

v.3

1893

[REDACTED]

[REDACTED]



THE
STREET RAILWAY
REVIEW

INDEX TO VOLUME III

1893

CHICAGO

WINDSOR & KENFIELD, PUBLISHERS

269 DEARBORN STREET

Street Railway Review

INDEX.

Articles marked "*" are illustrated. World's Fair is abbreviated as "w. f."

Editorial.

Accidents.....1, 63
 Ambulance Cars.....461
 Ammonia Motors.....2
 Attention to Possible Traffic.....195
 Baltimore Street Crossing Ordinance.....461
 Blocking Streets by House Moving.....331
 Boston Rapid Transit.....66, 127, 128, 267
 Brakes for Hills.....524
 Broadway Cable Construction.....64
 Bursting Boilers.....680
 Cable Construction in New York.....459
 Capital vs. Engineering Knowledge.....269
 Chicago Cable Stocks.....459
 Convention.....2, 128, 129, 524, 525
 Construction in 1893.....127
 Connecticut Roads.....64, 65
 Coal Blockades.....63
 Coal Consumption Variation.....523
 Cook's Elevated Railway.....194
 Credit Basis in Purchasing Supplies.....397
 Criminal Carelessness by Motormen.....2
 Damage Suits.....65, 460
 Detroit Troubles.....2, 333
 Economy in Power Plants.....461
 Elevated Electric Roads.....127, 267
 Elevated vs. Underground Roads.....523
 Employes Request Reduced Wages.....587
 Fares for Long Rides.....129
 Fenders.....193, 459
 Fires.....63
 Financial Stringency.....395, 524
 Fly Wheel Accidents.....587
 Free Rides for Mail Carriers.....269
 Gettysburg Trolley.....331
 "Go Ahead" Signals From Passengers.....678
 Grade Crossings.....129, 269, 331
 Induced Traffic.....127
 Insurance and the Trolley.....63
 Itemized Accounts and Records.....194
 Legislation.....65, 127, 128
 Legal Decisions.....193, 331, 677
 Locomotives vs. Car Motors.....588
 Los Angeles Cable Railway Suit.....331
 Maine Street Railway Association.....523
 Matlock Cable Opening.....459
 Municipal Ownership.....1
 Oil as a Fuel.....677
 Old Motors.....395
 Oregon City Electric Road Opening.....397
 Our Medal.....587
 Paving to T Rail.....128
 Pennsylvania Street Railway Association.....1
 Philadelphia Changes.....64
 Populists Electric Railroad Scheme.....395
 Power Selling by Street Railways.....128, 129, 194, 397
 Promoters of Electric Roads.....267
 Railroad Building in the United States.....461
 Rapid Transit Commission, New York.....1
 Return Circuits.....586, 678
 Separate Car Question in the South.....127, 396
 Short Riding.....331
 Shocks from 500 Volts.....461
 Snow Blockades.....64

Editorial.

Speed Limitations.....396
 Stephenson, John, Death of.....460
 Steps.....128
 Storage Batteries in Power Stations.....128
 Strikers at Toledo.....2
 Strikers.....64, 127, 194, 525, 679
 Sugar Plantation Electric Roads.....195
 Sunday Cars in Toronto.....395, 523
 Supply Business.....396
 Taxation of Street Railways.....66, 369
 Telephone vs. Tramway.....269
 Three-cent Fares.....63
 Travel Increasing in St. Louis.....64
 Transportation Department at w. f.....267
 Trailers and Economy of Power.....677
 Trolley in Chicago.....679
 Tug of War, "Railroad Day" w. f.....587
 Vestibule Platform Laws.....66
 Washington Troubles.....2, 193
 Winter Riding in 1892-'93.....65
 World's Fair.....1, 64, 193, 194, 268, 331, 395, 460, 588

A

Accident, A Strange.....70
 Accident, Deliberately Planned.....516, 517
 Accident, A New Kind of Invented.....695
 Accidents and Car Steps.....161
 Accidents, List of in Milwaukee.....109
 Accounts, A Simple System of, Suited to Small Roads.....422, 432
 Accounts, Standard Form For Street Railway.....718, 719
 Accounts, Complete Classification of.....298, 299, 300, 301, 302
 Acme Oil Filter*.....58
 Acme Sash Wheel*.....369
 Acme Storage Battery.....102
 Adams' Water Tube Boiler*.....795
 Advantages, Make the Most of Your.....398
 Advertising Your Line.....398
 Aetna Section Insulator*.....778
 Africa, Street Cars in*.....696, 697
 After the Fair*.....772
 Air Brakes, The Christensen*.....295
 Aluminium Tickets*.....516
 Aluminium Silver.....505
 Always Room at the Top*.....774
 Ambulance, St. Louis Car*.....463
 American Street Railway Association—
 Twelfth Annual Convention:
 Introduction.....590
 Wednesday Morning Session.....591 to 600
 Mayor's Welcome.....591
 President Longstreet's Address*.....591 to 592
 Executive Committee Report*.....592 to 595
 "Power House Engines," by E. G. Connette.....596 to 599
 Discussion of Connette's Paper.....599 to 600
 Wednesday Afternoon.....601
 Wednesday Evening, Remarks by O. T. Crosby, on "Power House Engines".....601, 602
 "Best Method of Heating and Light-Street Railway Cars," by G. F. Greenwood.....602 to 604
 Discussion, "Paving to T Rail".....604

American Street Railway Association—

Twelfth Annual Convention:
 "Traction and Street Railway Trucks," by Elmer H. Sperry.....604 to 609
 "Storage Batteries in Electric Generating Stations," by C. O. Mailloux*.....606 to 612
 "Direct Driven Generators," by C. J. Field*.....612 to 614
 Election of Officers (portrait of H. C. Payne).....615
 The Banquet.....615
 Friday.....616
 The Local Committee.....616
 The Ladies Present.....616
 Exhibits of the Convention.....617, 618, 659, 660, 661, 662, 663, 664, 665, 666, 667
 Delegates.....676
 Ammonia Motor.....7
 Ancient Kicker, An.....555
 And the Car Came Back.....722
 And She Felt Sorry For It.....363
 Anderson, A. A. (portrait).....322
 Andrews, D. A.....264
 Annual Review of the Year With Our Advertisers.....799-800 801-802 803
 Another case of Circumstantial Evidence.....482
 Another Suspender Car Scheme.....155
 Ansonia's, w f Exhibit*.....405, 406
 Anthony Reckenzan (obituary).....770
 Argentine's Street Railways.....450
 Arrester, Discharging*.....258
 As Hartford Sees Us.....563
 As Usual.....188
 As Seen From the Dark Side.....631
 Ashland, Wis., Combined Light and Power Station.....17
 Association, American Exhibits at*.....231
 Aurora, Ill., Increasing Revenue at*.....640, 641
 Australasian Electric Lines.....502
 Austin Dam, Break in the*.....511
 Automatic Brake Company Brake*.....182
 Auxilliary on Grades, An Unique*.....430, 431
 Awards in the Street Railway Industries at the w. f.....656

B

Babcock, Charles (portrait).....407
 Baggage Car on the Chattanooga Electric Railway*.....704
 Bailey, Theo. P. (portrait).....217
 Baker, Judge, Decision of.....103, 104
 Baker Heater, The*.....657
 Baltimore-Washington Electric, The.....164
 Baltimore, Fenders in.....717
 Baltimore's City & Suburban Earnings.....705
 Baltimore, The Lord No. 2*.....638, 639
 Baloonist Falls and is Saved by a Street Railway Man.....522
 Ball Engine, Western Agency of.....624
 Ball, of Erie, w f Exhibit of*.....437
 Ball Engine High Speed Tandem*.....180
 Ball Vertical Cross Compound Engine*.....692
 Ballad of the Crinoline*.....185
 Barnard, W. T. (portrait).....207
 Barnes, W. F. and John, Exhibit of* w. f.....470
 Barnes Cable Car on Chicago City Railway.....357
 Barre Sliding Railway* w. f.....337

<p>Bass Engine Exhibit* w f.....50</p> <p>Bass, J. H. (portrait).....</p> <p>Bates Machine Company, w f E.....</p> <p>Bay City Changes.....</p> <p>Bean, W. Worth (portrait).....</p> <p>Beats Geo. Washington's Little Hatchet.....682</p> <p>Belknap Motor Company* w f.....341</p> <p>Bellaire Bridgeport & Martin's Ferry Electric Railway*.....693, 694</p> <p>Belt of Steel and Cotton, A*.....657</p> <p>Belt Builder, A Big*.....569, 570</p> <p>Belt, A Big*.....256</p> <p>Benefit Association.....239</p> <p>Benefit Association, The St. Louis.....188</p> <p>Bessbrook & Newry Tramway* (Ireland).....478</p> <p>Best Men Know It, The.....180</p> <p>Biggest Boiler Plant in the World*.....143</p> <p>Binghamton, N. Y., Increased Earnings.....36</p> <p>Birthday, Our Second.....9</p> <p>Bishop, Harry (portrait).....211</p> <p>Block Signal, A Valuable*.....4</p> <p>Block Signal for Turnouts*.....16</p> <p>Block System, The.....239</p> <p>Blue Island Avenue Cable Line, Chicago, Starting the.....497</p> <p>Board in Chicago, Where to.....78</p> <p>Bogardus, W. A. H. (portrait).....15</p> <p>Boiler, Death From a Bursting*.....681, 682</p> <p>Bond, The Chicago*.....684</p> <p>"Bonding," by H. R. Keithley.....691</p> <p>Boston Pivotal Trolley*.....429</p> <p>Bowen, M. K. (portrait).....205</p> <p>Bowery, Cable Threatens the.....699</p> <p>Boys Stealing Rides on Cars.....478, 479, 569</p> <p>Bradford, H. P. (portrait).....110</p> <p>Brakes for Electric Cars.....629</p> <p>Brake Shoe, The Safety*.....655</p> <p>Brake, A New Street Car*.....182</p> <p>Brake Problem, A.....141</p> <p>Brandau Track and Wheel Brake, The*.....781</p> <p>Brevities.....126</p> <p>Brill Factory, Improvement at.....57</p> <p>Bridge of Pleasant Valley Traction Com- pany*.....308, 309</p> <p>Bridgeport, A Syndicate for.....84</p> <p>Brigantine Transit Company*.....566, 567</p> <p>Broadway Cable, First Car.....371</p> <p>Broadway Cable, The*.....71, 72, 73, 74, 75, 76</p> <p>Brooklyn City, New Secretary of.....15</p> <p>Brooklyn's Big Chimney.....741</p> <p>Brooklyn "L," The.....370</p> <p>Brooklyn Elevated, Lowering the Grade on.....501</p> <p>Brooklyn, Fly Wheel Bursts at*.....669, 670</p> <p>Brooklyn City Railway's Report.....704</p> <p>Brooklyn Bridge Problem, A Solution.....196</p> <p>Brown Electric Company, The*.....712</p> <p>Brownell's Artistic Exhibit*.....463, 469</p> <p>Brush Holder, The Lyons*.....258</p> <p>Brush Holder, A Simple Track*.....552</p> <p>Brush Grinder, A Dynamo*.....555</p> <p>Buckeye Engines at the Fair*.....107, 475</p> <p>Buckeye Engines at Convention*.....668</p> <p>Buckeye Engines at w f*.....107</p> <p>Buffalo, Phenomenal Increase of Traffic in.....91</p> <p>Bullock, M. C. (portrait).....212</p> <p>Burling, W. S. (portrait).....209</p> <p>Bursting, E. (portrait).....210</p> <p>Bursting of a Fly Wheel*.....513</p> <p>Burton's Elevated Electric w f.....347</p> <p>Byrns, John, Driver (portrait).....771</p>	<p>Cable Railway, The Invention of*.....</p> <p>.....147, 148, 149, 150</p> <p>Cables Report, Chicago's.....181</p> <p>Cable Crossings in Chicago*.....328, 329</p> <p>Cable Road Switch*.....624</p> <p>Cable Road Brake, Maynard's*.....571</p> <p>Caldwell, R. F. (portrait).....377</p> <p>California Rail Joint.....394</p> <p>Cameron, D. F. (portrait).....207</p> <p>Canadian Volts.....308, 498, 649, 760</p> <p>Canadian Cities, Fares per Capita in.....699</p> <p>Candle, The Innocent and the Electric Light.....370</p> <p>Canton Car Barn Conflagration.....653</p> <p>Capen, Geo. D. (obituary).....391</p> <p>Carried Stolen Registers.....693</p> <p>Carruthers-Wain, W. J. (portrait).....550</p> <p>Car Manufacturing Company, The Morse*658</p> <p>Car, New Castle Combination*.....553</p> <p>Car Bodies, Dead Weight in.....565</p> <p>Car House, Watertown*.....41</p> <p>Car Heating, Electric*.....241</p> <p>Car Floors and Cleanliness.....358, 359</p> <p>Car Barns, Large vs. Small.....83</p> <p>Car Steps and Accidents.....161</p> <p>Car Builders of America*.....392</p> <p>Car Belle, A.....293</p> <p>Carey, P. H. (portrait).....211</p> <p>Caught on the Rush Trip.....49 to 54, 111 to 116, 175 to 179, 249 to 253, 315 to 319, 379 to 383, 446 to 450, 507 to 511, 573 to 577, 643 to 647, 725 to 729</p> <p>Cash Avenue Contracts.....37</p> <p>Cash Belts for Conductors.....720</p> <p>Cat Tale, A.....58</p> <p>Cedar Rapids & Marion Express*.....432</p> <p>Cedar Rapids & Marion City Railway, Cost of Power on the*.....513-516</p> <p>Cellular Opestacitis.....490</p> <p>Cement for Steam Pipes.....431</p> <p>Centennial, Corliss at the.....438</p> <p>Center Bearing Rail*.....236</p> <p>Chadbourne, A. H. (portrait).....698</p> <p>Chairs, the World's Fair Rolling*.....277</p> <p>Chapman, J. R. (portrait).....528</p> <p>Charlton, B. E. (portrait).....529</p> <p>Chattanooga Electric Railway, Baggage Car on*.....704</p> <p>Cheney, F. A. (portrait).....620</p> <p>Chicago & Evanston Electric Railway.....133</p> <p>Chicago's Grand Central Company.....309</p> <p>Chicago City Railway, Electricity on*.....</p> <p>.....33-34-35-36</p> <p>Chicago*.....204</p> <p>Chicago Street Car Air Brake Company.....310</p> <p>Chicago City Railway Electric Plant*.....313</p> <p>Chicago Electric Club, The.....57</p> <p>Chicago Cable's Reports.....181</p> <p>Chicago City Railway's Electric Plant and Equipment, Performance of*.....</p> <p>.....685-686-687-688</p> <p>Chicago City Railway Fire*.....652</p> <p>Chicago & Central Indiana Electric Rail- way*.....561</p> <p>Chicago, Another Electric for.....370</p> <p>Chicago Cables Cross*.....328-329</p> <p>Chicago City Railway Cuts a Melon.....577</p> <p>Chicago Day Transportation*.....670-671</p> <p>Chicago, Transportation in During the World's Fair.....724</p> <p>Chicago & St. Louis Electric Railway*.....</p> <p>.....18-19 20-254</p> <p>Chimney, Brooklyn's Big.....741</p> <p>Chinese Cable Line, A*.....95</p> <p>Christensen Air Brake, the*.....295</p> <p>Cincinnati, Lost Car in.....87</p> <p>Cincinnati Landslide*.....501</p>	<p>City Loses, The.....779</p> <p>City & South London*.....561</p> <p>Clark, J. W. (portrait).....214</p> <p>Classification of Accounts.....299-300-301-302</p> <p>Clean the Track*.....803</p> <p>Cleveland's Cables Consolidate.....424</p> <p>Cleveland Combine, The.....188</p> <p>Cleanliness, Car Floors and.....358-359</p> <p>Cleminshaw, Chas. (portrait).....426</p> <p>Climax Boilers at w f*.....714</p> <p>Coal Consumption, Variation of in Power Plants*.....564</p> <p>Coal Mines, Electric Haulage for*.....292</p> <p>Coal Production in Japan.....780</p> <p>Cochran, Henry (portrait).....392</p> <p>Code, The Street Car.....499</p> <p>Cog Railroad, Pikes Peak*.....504-505</p> <p>Columbia (S. C.) Electric Railway*.....376-377</p> <p>Coldren's Combination Brake and Con- troller*.....327</p> <p>Cold Storage Fire*.....464-465</p> <p>Columbus Benefit Association.....769</p> <p>Columbia, Pa., New Line at.....85</p> <p>Combination Car*.....162-163</p> <p>Compressed Air at Leavenworth.....40</p> <p>Conductor's Traffic in Tickets.....434</p> <p>Conductors, Where They Come From.....694</p> <p>Controller and Brake Combined*.....327</p> <p>Consolidated Car Heating Company w f Exhibit*.....277-278</p> <p>Concord's Road Opens.....426</p> <p>Concord's Case.....171</p> <p>Connecticut's Competition.....132</p> <p>Connecticut Night Horse.....239</p> <p>Connelly Motor, Trial of.....62</p> <p>Congress, Electrical.....572</p> <p>Convention, The Coming Street Railway.....596</p> <p>Convention, Twelfth Annual (see Ameri- can Street Railway Association).</p> <p>Convention, Railroad Rates to.....546</p> <p>Continuous Rails.....307</p> <p>Cook, W. J. (portrait).....219</p> <p>Cook's Elevated Railway*.....197-198-199</p> <p>Cook Elevated Electric, w f Exhibit of.....439</p> <p>Cook, C. S. (portrait).....224</p> <p>Cook High Speed Elevated Exhibit w f.....584</p> <p>Cooney, S. A. (portrait).....373</p> <p>Corby, J. F. (portrait).....218</p> <p>Cosmopolites on the Intramural*.....408</p> <p>Cost of Power on the Cedar Rapids & Marion City Railway.....515-516</p> <p>Cost of Fuel.....142</p> <p>Cost of Iron Ore.....780</p> <p>Cost of Storage and Overhead Systems.....781</p> <p>Coyle, John A. (portrait).....24-25</p> <p>Crawford, R. C. (portrait).....206</p> <p>Crimmins, John D. (portrait).....528</p> <p>Crimmins' First Car.....371</p> <p>Crossing, Interlocking on the Chicago North Shore Electric Railway*.....729-730</p> <p>Crossman, T. E. (portrait).....529</p> <p>Crowbar on the Intramural, A.....420</p> <p>Crowd, The Largest in the World*.....670-671</p> <p>Current, Killed by the.....433</p> <p>Curves, New Wheels on.....292</p> <p>Cutter's Boulevard Street Hood*.....427</p> <p>Cutter, George, in Electricity Building at w f*.....472</p> <p>Cutter, George (portrait).....210</p>
<p>D</p>		
<p>Dam, Break in the Austin*.....514</p> <p>Dangers of Horse Cars.....489</p> <p>Davenport & Rock Island, Induced Traf- fic*.....428-429</p> <p>Davis, D. W. (portrait).....213</p>		

Day's Endless Chain Carriage*	321
Dead Weight in Car Bodies	565
Dean, D. B. (portrait)	225
Death from a Bursting Boiler*	681-682
Delegation, A Big	674
Denver Company's Picnic	451
Denver's Amalgamation	455
Denver City Cable Railway Company in Receiver's Hands	719
Depot, Lindell, St. Louis*	46
Des Moines Appliances, Some*	424
Detroit, Persecution in	674
Devices, Some New	189
Dictionary of Technical Terms	54-121-390
Didn't Care if he was a Gripman	560
Distresses the Horses	625
Doctors Disagree	557
Dodge Manufacturing Company, w f Exhibit of*	410
Dressel Dash Light	732
Durnin, T. J. (portrait)	549

E

Easily Moved	293
Echoes from the Trade	60 to 62, 119 to 123 182 to 185, 259 to 260, 323 to 325, 387 to 388, 456 to 458, 520 to 524, 582 to 583, 650 to 651, 735 to 738, 804.
Eclipse Exhaust Pipe Head*	555
Edison Feeder Patent	264
Edison's Sand	239
Edison Direct Coupled Unit at w f*	340
Editorial	743-744-745
Efficient Work, Prizes for	247
Electricity Draws the Traffic	476
Electric Car Elevator*	713-714
Electric Light on a Chicago Cable Train	773
Electricity Building	329
Electric Heating, Cost of	295
Electricity for the Farm*	28
Electricity Building Street Railway Exhibitors in*	411
Electric Light Association	78
Electric Traction in 1850*	139-140
Electric Heating Consolidated Company	241
Electrical Measurements I*	88-89 90-91
Electrical Measurements II	159-160
Electric Grand Stand, An	141
Electricity Building, w f*	338-339
Electricity on the Canal	719
Electrical Congress	572
Electric Belts	619
Electric Locomotive at the w f*	442
Electrical Inspection Department I	619
Electrical Inspection Department II	700
Electrolysis of Water Pipes	283-284
Electrolysis More About*	364-365
Elevated Railroad Bridge at w f*	353
Elevated Railway at Liverpool*	135
Elevated Railway, Cook's Exhibit of	439
Elevated vs. Underground Electric Traction in England	558
Elevated Electric Exhibit, The Cook High Speed at w f	584
Elevated Railway, Cook's*	197-198-199
Elevator, An Electric Car*	713-714
Elmira Horseheads Interurban Opened	480
Elmira & Horseheads Electric Railway*	620
Ely, H. S. (portrait)	287
English Rail Cleaner, A*	418
England, Tramway Expenses in	699
English Fare Raising	694
Engine Exhibit at w f	108
Engine, Ball's High Speed Tandem*	180
Engineering Feat, A Remarkable	501
Entirely Useless	321
Euphrat Fender, The*	750

Eureka Tempered Copper Company at w f	469-470
Evans, Major H. C.	59
Events of 1892, Leading Street Railway	38 39
Everett, Dr. A. (portrait)	528
Excursions, Special Street Railway	496
Exhibits, w f Key to Map of	272
Exhibits, w f Map of	273
Exhaust Pipe Head, Eclipse*	555
Exhibit at w f to March	109
Express, Cedar Rapids and Marion*	432
Experiences of a Superintendent—Part I. By C. P. Young (portrait)	789-791
Experiments and Experiences with Lighting	401-402
Extensometer, An Historical	417

F

Fall's Rivet & Machine Company w f Exhibit*	406-407
Fares per capita in Canadian Cities	699
Fare Register, Folger*	123
Fare Freak, A	162
Fares of the Fair	724
Farmer Electric Railway, Historical w f Exhibit*	340 341
Farmer, Moses G. (portrait)	374
Farm, Electricity for*	28
Fenders in Baltimore	717
Ferris Wheel, Dedicating of the*	405
Ferris Wheel, The*	274
Fete Days at World's Fair	354
Fire, Cold Storage*	464-465
Fire, The Chicago City Railway*	652
Fire, Canton	653
Fire Risks and the Trolley	680
Fire, A London*	647
Fire, The Milwaukee*	6
Fires, Power House*	82
Fire, North Chicago Car Barn*	741
Fireproof Construction*	365-366
Fisher, Harry C. (obituary)	391
Five Hundred and Fifty Volts, Received	12-13
Flat Car, A Large*	118
Florida Mule, A	482
Florida's First Electric*	287-288
Fly Wheel Bursts at Brooklyn	669-670
Fly Wheel, Bursting of a (Memphis)	513
Folger Electric Gong*	59
Folger's Fare Register*	123
Foreign Facts	57-375-443-514-675-740
Ft. Wayne's Electric System. *167-168-169-170	
Ft. Wayne, Sprinkling Car at	570
Forever and Forever	166
Fowler Car Company, The New	258
Fowler Snow Sweeper, The*	760
Free List Fiend	374
French Street Railway Strike	738
Freight Car, A Neat*	367
Friction Clutches, Lake Company's*	798
'Frisco, Fun in	377
Front Vestibules at Vincennes*	773
Fuel, A New	163
Funeral, A Strange	357

G

Garton Arrester Discharging*	258
Gas Motors on Cars	295
Gazette, The Street Railway, Changes Owners	76
General Electric Soo*	393
General Electric Company at w f	278 279-345-346
Genett Factory, The*	311
Genett Air Brake Exhibit at w f*	629
Genett Air Brake Exhibit at w f	343-344

Genuine Diplomat, A	766
German Iron Poles*	368
Germany, Growth of the Trolley in	709
Gettysburg Battlefield, Electric Railway on the*	635-636-637
Gettysburg Street Railway	425
Gibbs Trolley, The*	433
Gilbert, E. G. (portrait)	264
Given, Wm (portrait)	85
Gondola, Transit a la, at w f*	353
Gong, Folger Electric*	59
Goodhue, Wells (portrait)	216
Gould, Jay, A Story of	47
Gowan's Rail Cleaner*	394
Grand Rapids Pleasure Resorts on Road*	37
Graham's Standard Truck*	11
Grade Climber, A*	359
Greased Trolley Wire	37
Green, F. R. (portrait)	205
Green Tandem Compound Engine*	481
Great Britain, Annual Meeting of the Tramways Institute	500
Green Bay Power House, Historic Site of	565
Gregg, S. K. (portrait)	215
Green Fuel Economizer at the w f*	348-349
Griffin Wheels, w f Exhibit of*	415
Griffith, T. B. (obituary and portrait)	518
Grip Loan Collection, A*	412-413
Grips, A w f Exhibit of*	412-413
Grip 688	263
Ground Plates, An Argument in Favor of, as Against a Continuous Copper Return	117-118
Grounding, Plain Argument in Favor of*	559
Ground Return	289-292
Ground Return (by J. F. E.)	117-118
Ground Return	312-313
Ground Return, The	97-98-151-152-153-154-154-155
Guernsey Railway, A*	559

H

Half Fares	5-124-133-134-201 306-334-335-444-445-585-589-710-711-763
Hale & Kilburn's Exhibit at w f	351
Halladie, A. S. (portrait)	150
Hammond & East Chicago Railway, Building of	173
Hand Strap, Rombauer	749
Harrison, E. H. (portrait)	211
Harrison's Syndicate	590
Harris Patent Anti-Friction Trolley Base	32
Harris, N. W., & Company	210
Harris, J. H. (portrait)	219
Hasbrouck, D. B. (portrait)	630
Has a Mania	236
Hayes, J. M. (portrait)	212
Heating, Electric	363
Heater, The Baker*	657
Heaters, Cost of Operating Electric	295
Heart, A Change of	39
Healy Steam Motors, The*	707
Helm, J. W. (portrait)	206
Heatman Underground Trolley System*	441
His Malady	377
Holmes, John G. (portrait)	528
Holmden, W. (portrait)	551
Hommel, G. W. (portrait)	548
Honest Editor, One	27
Hoover, P. H. (portrait)	221
Hoppes Manufacturing Company, w f Exhibit of	435
Hot Pressed Pinion*	654
Hover, F. A. (portrait)	551
How It Happened	399
How They Read the Review	552
Hubbard, S. B. (portrait)	287

Hunt Company, C. W., at w f.....	69
Hurt, Joel (portrait).....	507
Hydraulic Wheel Press*.....	57

I

Ice as an Insulator.....	155
Ice, Removing from Trolley Wire.....	236
Ide & Sons Exhibit at w f*.....	517-518
Ide Engine, Chicago Agency of.....	432
Illuminated Sign on the Calumet*.....	493
Inauguration Crowds*.....	257
Increased Earnings.....	36
Incandescent Lamp Decision.....	31
Indianapolis, Gas Accident*.....	310
Indianapolis Situation at.....	164
Indianapolis History.....	314
Indianapolis Citizen's New Officers.....	322
Indianapolis Railway Group*.....	203
Indefinite Postponement.....	98
Induced Traffic*.....	428 429
Inducing Traffic.....	398
Induced Traffic.....	62
Induced Traffic.....	27
Induced Traffic.....	37
Insurance and the Trolley.....	85
Insurance and the Trolley.....	680
Insurance and Grounded Circuits.....	559-560
Insurance, Grounded Circuits and.....	355-356
Insulation of Coils*.....	44 45
Insulators From the Sea*.....	235
Inspection Department, The Electrical I.....	619
Inspection Department, The Electrical II.....	700
Interlocking Grade Crossing on The Chicago & North Shore Electric Rail- way*.....	729-730
Interurban Service, New Car for*.....	92-93
Interurban, Another Large.....	70
International Tramways Union.....	235
International Fare Register, w f Exhibit of*.....	413
Intramural Railway at w f Grounds*.....	21-22-23-24
Intramural at w f.....	279
Intramural Cars and Motors.....	229-230
Irish Tramway, A*.....	4 8
Iron as a Conductor.....	572
It Wasn't Dynamite.....	769

J

Jackson & Sharp Company Will Build Street Cars, The*.....	764-765
Jacksonville Electric Railway*.....	287
James Christopher (portrait).....	550
Jefferson Street Power House of West Chicago Street Railroad*.....	14
Jenkins, C. E. (portrait).....	320
Jewett Car Company, Handsome Cars of the*.....	571
Johnson Company of Johnstown at w f.....	521
Joint, Trolley Wire.....	370
Joint, Old Girder Rail as Bridge*.....	498
Jolly, J. K. (portrait).....	694
Jones Cars at w f*.....	352-353
Judges in Transportation and Electricity Departments at w f.....	532
Just the Point.....	370

K

Kansas City, Consolidation in.....	653
Keen, C. C. (portrait).....	220
Kenfield, F. S. (portrait).....	235
Kicker, A High.....	423
Killed by the Current.....	433
Killed the Goose That Layed the Golden Egg.....	418
Kodaked With a Pencil.....	414-415
Kohler, G. A. W. (portrait).....	209
Kohler, F. W. (portrait).....	209

L

Labor in Small Power Plants.....	502-503
LaCrosse, Rail Bonding At.....	429
LaCrosse Railway Opens to Traffic.....	738
Laclede's Exposition Car*.....	570
Ladder on Wheels, A*.....	738
Lafayette Electric*.....	29-30-31
Lake Street Elevated of Chicago.....	683-684
Lake Roland Elevated, The*.....	751-752-753-754
Lake Roland Road.....	307
Lake, J. H. D. & Company.....	418
Lamp Patent Suit at St. Louis.....	321
Lamont and the Railway.....	425
Lamokin Cars at w f*.....	282, 354
Lamokin Car Works.....	327
Lane & Bodley w f Exhibit of*.....	438
Latest Washington Nonsense, The.....	755
Launches, Electric*.....	276
Leavenworth, Pneumatic Railway.....	40
Leach, P. F. (portrait).....	215
License for Motormen.....	781
Lightning in a Cable Plant.....	500
Light, S. P. (portrait).....	552
Lightning, Some Experiments and Exper- iences with.....	401-402
Light, National Electric Convention.....	190
Lillie's, Dr. Electric Car.....	139-140
Lillie Dr., (portrait).....	139
Lindell Railway, Handsome Depot of the*.....	46
Lindell Railway Fire of*.....	82
Little, Hon. Samuel (portrait).....	700
Littell, H. M. (portrait).....	8
Liverpool Overhead Railway*.....	135-136 137-138
London Laugh, A.....	700
London's Metropolitan Hades.....	621
Londoners, How They Travel.....	83
London Fire, A*.....	647
London, City and South*.....	561
Longstreet, D. F. (portrait).....	527
Long Trailers, Disadvantages of.....	87
Long Distance Transmission.....	231
Long Distance Electric Railway*.....	18-19-20
Longwell, H. E. (portrait).....	224
Lord Baltimore No. 2*.....	638-639
Loss, C. E. (portrait).....	215
Los Angeles Consolidated Cable Rail- way*.....	67 68 69
Los Angeles and Pasadena Electric.....	307
Los Angeles Cable Road Sold.....	652
Los Angeles Receiver's Report.....	766-766
Louderback, D. H. (portrait).....	490
Louisville Changes.....	91
Love Electric Conduit System.....	17
Lowell & Suburban Street Railway, The*.....	758
Lowrey, G. P.....	327
Ludlow Combined Car Step and Gate*.....	642
Lunken Gate Valve*.....	499
Lynn, A. W. (portrait).....	518
Lyons Brush Holder*.....	258

MAC

McAdam a Scotchman.....	695
McClosky, J. W. (portrait).....	345
McDonald, R. T. (portrait).....	79
McEwen Engine at w f*.....	476
McGuire, W. A. (portrait).....	219
McGuire's w f Exhibit*.....	404
McGuire's Bicycle Truck*.....	427
McIntosh & Seymour at Jackson Park*.....	474
McKeesport Railways.....	392
McLean, Manager, of Indianapolis, Threatened With Assassination*.....	720
McTighe, T. J. (portrait).....	631

M

Machinery Hall*.....	108
Machinery Hall.....	409

Madison, Wis., Mules Replaced by Motors.....	13
Madras.....	681
Magnetic Pulleys.....	706-707
Maine's New Road (Calais & St. Stephen).....	371
Maine Street Railway Association.....	580
Manhattan's Millions.....	680
Manufacture of Electric Railway Appara- tus in England*.....	748-749
Mark Center Bearing Rail*.....	236
Married.....	376
Married.....	659
Massachusetts Railways.....	79
Mason, A. L. (portrait).....	322
Mason, W. R. (portrait).....	219
Massachusetts Street Railway Association.....	104
Matrimonial.....	59
Matlock Cable Tramway*.....	483-484-485-486-487-488
Maynard's Cable Road Brake*.....	571
Meaker Manufacturing Company*.....	222
Mehling Car, The*.....	164-165
Melbourne, Tramway Affairs at.....	630
Meims, G. J. (portrait).....	549
Memorial, In.....	57
Mertes, A., Manufacturing Company.....	733
Merrill, G. B. (portrait).....	225
Metropolitan Traction Changes.....	432
Metal Ties in Mexico.....	426
Middletown-Goshen Traction.....	781
Milwaukee Temporary Power House.....	15
Milwaukee Fire, The*.....	6
Milwaukee, Map of.....	547
Milwaukee's Hotel Plüster*.....	453 454-455
Milwaukee Street Railway Men.....	548-549
Milwaukee Accidents.....	109
Milwaukee, Hotels in.....	546
Milwaukee of To day*.....	534-535-536-537-538-539-540-541
Milwaukee Street Railway Companies*.....	541-542 543-544-545-546
Milwaukee, History of Rapid Transit*.....	530-531
Milwaukee, Exhibit Space at.....	546
Milwaukee, The Old*.....	532-533
Minary, T. J. (portrait).....	528
Minneapolis and St. Paul, Performance of Plants at.....	491-492-493
Mistake, A.....	266
Mobile's New Rapid Transit*.....	730-731-732
Model Men (Orange, N. J.).....	653-654
Montreal's Street Railway System*.....	25-26-27
Morse Car Manufacturing Company.....	658
Mosher Lamp, The*.....	146-265
Mosher, J. A. (portrait).....	223
Motorman, An Heroic.....	553
Motor, Narrow Gauge*.....	255
Motor Suspension, New Method of*.....	642
Motor Switch, Cutter's.....	806
Motors, A Use for Old.....	421
Motor, G. E. Soo*.....	393
Mt. Auburn Trolley Wheel.....	705
Movable Sidewalk, The Pier.....	442
Moving Sidewalk, The*.....	517
Moving Sidewalk, The.....	105
Movable Sidewalk*.....	226-227-228
Moving Sidewalk, Life on the*.....	718
Moving Sidewalk, The.....	15
Multiphase Railway Motor, Siemen's at w f.....	472-473
Multiphase Currents for Traction Work.....	174
Municipal Management in Canada.....	555
Munson Belting*.....	742
Myers, L. E. (portrait).....	218
Myers, G. (portrait).....	221
Nagl, Chas (portrait).....	206
Naval Exhibits in Transportation at w f*.....	347

N

New Castle Car Company, New Manager of.....	551
New Castle Combination Car*.....	553
New Way to Get Trolley Wire, A.....	771
Newark and Centerville Railroad*.....	628
Newspaper Rapid Transit.....	4
New Jersey's Roads.....	371
New Jersey, Prospects in.....	188
New Haven & West Haven Street Railway Power House.....	99-100-101
New Haven Fare Register.....	257
New Haven Fare Register, w f Exhibit of*.....	414
New Lines for Havana, Cuba.....	779
News from the Cities.....	683-781-785-786-787-788
New Publications.....	
.....	126-186-265-330 386-439-581-656-730
New Orleans, Opening of First Electric in*.....	77-78
New Orleans News.....	4
New Orleans and Carrollton Electric Line*.....	303-304-305
New Orleans, Electrics popular at*.....	173
New York, Broadway Cable*.....	71 to 76
New York, Broadway Cable Starting of by Constance Cruminitis*.....	161
New York City Rapid Transit.....	771
New York, Rapid Transit in.....	45
New York State, Eleventh Annual Meeting of the Street Railway Association of*.....	585-630
Niagara Falls Park & River Railway*.....	689-690-691
Niagara, Long Distance Transmission at.....	688
Noiseless Rail joint Exhibit at w f.....	394
Norwich, Conn. Lines Change Hands.....	82
North Hudson Company Road, Officers of.....	155
North Chicago Road Will Not Increase its Stock.....	555
North Chicago Rapid Transit Company, Plans of.....	294
North Chicago Cleans House.....	235
North Chicago Car Barn Fire*.....	741
Nugent W. W. (portrait).....	214
Nuttall R. D (obituary and portrait).....	572

O

Oakland, Electric Line in*.....	46
Oakland's Electrics Combined.....	489
Obituary.....	793
Obstructing The Street Cars.....	91
Ogden City Street Railway Plant, Performance of.....	568-569
O'Hara w f Exhibit.....	393
Ohio State Tramway Association.....	637-638
Ohio State Tramway Association.....	573
Oil Refiner, Ideal Steam*.....	254
Oil Fuel at The w f.....	144
Oil Filter, Acme*.....	58
Old Motors, A Use For.....	421
Omnibus Coach*.....	393
One of the Old Families.....	513
One on Solomon.....	313
One on Her*.....	87
Oneida's Earnings.....	367
On the Grip I.....	140-141
On the Grip II.....	288
On the Grip III.....	267
Opening the World's Fair*.....	270
Orange Mountain Cable*.....	371-372-373-374
Orr, C. F. (portrait).....	209
Orr, C. F., & Company.....	209
Our British Visitors.....	550
Our Medal.....	587
Ouray Electric Railway.....	56
Overhead Material, Type G*.....	447

P

Palmer, G. E. (portrait).....	216
Papers Said the People Didn't Want the Trolley.....	595
Parallel Coupling with Water Power.....	356
Paranite Displayed at w f.....	586
Paris Public Carriages of the Past*.....	622-623
Parkhurst, Dr., on the Car.....	234
Parsons, J. B. (portrait).....	296
Patents, Street Railway.....	17-255-330 385-452-512-578-654-733
Patent Office Gossip.....	381-451-512-578-733
Patent, How it Protects.....	166
Paving, A Chapter on.....	237-238
Paving, A Chapter on*.....	285-286
Paving in Europe.....	715
Payne, H. C. (portrait).....	548
Peckham Motor, Truck & Wheel Company, w f Exhibit of*.....	409-410
Peckham's Improved 6 A Truck*.....	391
Penington, T. C. (portrait).....	305
Pennsylvania Mortgage, A.....	489
Pennsylvania, Decision of Court.....	91
Pennsylvania Street Railway Association.....	10
Pennsylvania Street Railway Association, Second Annual Meeting of.....	551-552
Peoria, Fire at*.....	82
Peoria Power Plant.....	293
Persecution in Detroit.....	674
Performance of the Ogden City Street Railway Plant.....	568
Performance of Street Railway Power Plants (St. Paul and Minneapolis).....	491-492-493
Performance of the Chicago City Railway's Electric Plant and Equipment*.....	685-686-687-688
Personals.....	7-93-94-186-292-326-378-410-441-586-648-649-720-721-796
Philadelphia's Trolley.....	20
Philadelphia, New Cable Line for.....	84
Philadelphia Changes.....	314
Philadelphia Traction Companies' Plans.....	694
Philadelphia Bad Boys.....	693
Phillip, T. P.....	207
Phoenix Iron Works, The*.....	436
Pictorial Events of the Month*.....	125-386-481-506-531-648-507-808
Picnic, Denver Company's.....	481
Pikes Peak Cog Railroad*.....	504-505
Pinion, A Hot Pressed*.....	654
Pittsburg Combinations.....	434
Pleasant Valley Traction Company Bridge*.....	308-309
Pleasure Resorts and Created Travel*.....	756-757
Plugging Ties*.....	695
Polka, A Trolley.....	519
Police, Street Railroad.....	482
Porter New Rocker Switch*.....	31
Portland, Me., A Good Year at.....	102
Portland Street Car Plunges Into an Open Draw*.....	721
Power Plants, Performance of.....	491-492-493
Power House Force.....	560
Power Plant, A Suburban*.....	245-246
Power, Cost of, on the Cedar Rapids & Marion City Railway.....	515-516
Power Plants, Labor in Small.....	502-503
Postal Street Cars*.....	199-200
Pratt Portable Register*.....	311
Pratt, Geo. E. (portrait).....	354
Predictions Fulfilled, Our.....	295
Preston, E. B. (portrait).....	226
Pulleys, Magnetic.....	706-707
Purifying Steam Water*.....	298
Put-in-Bay & Southwestern*.....	293

Q

Quincy, the Dead.....	39-708
-----------------------	--------

R

Racine's Street Railway*.....	130-131-132
Rails, Continuous.....	397
Rail Bonding and the Ground Return I.....	97-98
Rail Bonding and the Ground Return II*.....	151-152-153-154-155
Rail Bond, The Chicago*.....	684
Rail Bonding at LaCrosse*.....	429
Rail Bonding.....	289-290-291-292
Rail Bonding, by H. R. Keithley.....	691
Rail Joint, An Overlapping.....	365
Rail Joints, Hot Riveting.....	329
Rail Joints, by Joseph Anthony*.....	703
Rail, Old Girders as Bridge*.....	438
Rail Cleaner, Gowan's*.....	394
Railway in a Day, A.....	421
Railway Equipment Company's Section Insulator.....	392
Railway Equipment Rail Bond*.....	768
Rapid Transit Idyl.....	247
Rau, Otto M. (portrait).....	549
Ray Pulley Covering, The*.....	778
Reading Rooms.....	247
Record for Hazard Cables, A.....	755
Recording Ammeter on the Cleveland City Railway*.....	625
Reel True Story, A*.....	766
Reflector, American*.....	171
Register, New Haven Fare.....	257
Register, Pratt Portable*.....	311
Reinoehl, Judge Adolphus (obituary and portrait).....	673
Reimann, G. L. (portrait).....	223
Removing Ice from Trolley Wire.....	236
Resorts, Winter.....	62
Restrictions, Prohibitive.....	418
Return Circuits, Overhead Copper for.....	369
Return Circuits*.....	364-365
Return Circuit.....	312-313
Return Circuit of an Electric Street Railway, The by O. M. Rau*.....	767-768-769
Return Circuit of Electric Railways, Report of Committee on.....	631-632-633-634
Return Circuit, Iron as a Conductor in.....	572
REVIEW Has Horns, The.....	778
Rhoads, H. R. (portrait).....	552
Richmond & Manchester Consolidation.....	189
Richardson, William (portrait).....	86
Richardson, Wm. (portrait).....	527
Rigg, J. A. (portrait).....	434
Roach, J. M. (portrait).....	296
Robins' Life Guard, The*.....	770
Robinson, M. S. (portrait).....	169
Rochester Street Car Advertisement, A*.....	779
Robinson, N. W. (portrait).....	213
Rochester Blaze, A.....	357
Rochester's Railway Depot.....	699
Roebling's Son's Company, Wire Exhibit of at w f.....	467-468
Rogers, E. P. (portrait).....	221
Rolling Chairs at w f*.....	277
Romance, A Back Platform.....	557
Royal Electric Mail Car at Ottawa*.....	782
Running Board, All Steel*.....	314

S

Sacramento's System.....	181
Safety Brake for Mountain Roads, A*.....	490
Safety Gate Fastener*.....	770
Salve, Water Power Electric Road at*.....	567-568
Salt Lake, Small Boys in.....	557
Sand Box, Sterling Supply Company's*.....	497

Sand Drying Machine, A 172
 Sander, Vogan Bros* 571
 Sandusky Receptiveness 621
 San Diego, Street Railway in* 425
 San Francisco's Consolidation Completed 682
 San Francisco's Gigantic Combination 623
 San Francisco, New Terminal at* 798
 San Francisco, Terminal Facilities in* 553
 San Francisco, History of the Market Steel Cable at 362
 Sargent, C. S. (portrait) 432
 Sargent & Lundy 208
 Scarrit Car Seat Exhibit at w f 394
 Scarrit Car Seat Company* 741
 Scheme to Ride with the Birds 40
 Schieren, Chas. A. & Company at w f* 350 351
 Schultz, J. A. J. (portrait) 569-570
 Schieren, Chas. A. Elected Mayor of Brooklyn (portrait) 712
 Schuttler Manufacturing Company, w f Exhibit of 414
 Schichau's Engines w f Exhibit 407
 Scranton & Carbondale Traction Company 480
 Scranton, New Buildings at 40
 Scranton Carbondale Electric Railway* 697-698
 Seattle, New Sale at 83
 Seattle Notes 256
 Searching for a Solution 190
 Selling Power From Trolley Circuit 233-234
 See Talks Back 166
 Sheffield Car Company at w f* 471-472
 Sheriffs, J. A. (portrait) 223
 Shield for Motemen, Acme* 254
 "Short Lap," A Talk on* 742
 Siamese Train, A 554
 Sidewalk, The Moving* 517
 Siemens & Halske at the Convention 668
 Siemen's Multiphase Railway Motor at w f 472-478
 Singapore, An Electric Railway in* 32
 Single as Against Double Motor Equipment 774
 Sioux City's Cable Changes Hands 623
 Situation, An L of a 421
 Small Roads, Account System for 422-423
 Smith, F. M., of Oakland 163
 Smith, of New York* 247-248
 Smith, C. H. of Scranton (portrait)* 294
 Smith, Willard A. (portrait) 106
 Smith, Wm. H. (portrait) 212
 Snow and Electric Cars 172
 Some Denials 13
 Something to be Proud of 256
 Sorrow Turned to Joy 162
 South Chicago City Railway* 156-157-158
 South American Street Railways 236
 South American Ox Cart, A* 280
 South Carolina, The First Electric Railway in* 376-377
 South Africa, Street Cars in* 696-697
 Span and Bracket Construction 781
 Spain, Making a Street Car in* 722-723
 Spencer, Lieut. E. J. (portrait) 346
 Spikes, Effect of Driving in Wooden Ties 593
 Splice, A Speedy 62
 Sprinkler, Day's* 805
 Sprinkling Car at Ft. Wayne 570
 Stalwart Stack, A* 755
 Stanwood Step* 314
 Standard Railway Supply Company, w f Exhibit of 436
 Standard Divider, The* 798
 Station Force (Ft. Worth) 560

Standard Paint Company, w f Exhibit of 417
 Steps, Steel* 314
 Steam Motor, A Swedish* 556
 Stephenson Company's Exhibit at w f 477-478
 Stealing Rides on Car 478-479
 Stephenson, John (portrait) 462-463
 Stenographer, The Official (T. E. Crossman) 529
 Stealing Rides on Cars Boys 560
 Stewart, B. F. (portrait) 224
 Steam Motors, The Healy* 707
 Stever Rail Joint, The* 399
 Stirling Boiler Exhibit at w f* 342
 Storage Battery Trial in Chicago* 795-796
 Storage Battery, The Logan 360
 Storage Battery, The Acme 102
 Storage Batteries Fail Again 258
 Storage Battery Buckled 327
 Storage Battery, Decision 461
 Storage Battery Operation, Cost of, on Second Avenue, New York* 716
 Storm Vestibules in Ohio* 778
 Strikers and the Law 103
 Stromberg & Allen (portraits) 210
 Strikers, Billings, J., on 305
 Street Railway Law 42, 80, 191, 242, 296, 368, 419, 494, 562, 626, 701, 761, 762
 Street Car Curtains* 793
 Street Sprinkling by Street Railways* 794
 Street Railway Man to the Rescue 625
 Streets in Germany 431
 Street Car Advertising in New York 234
 Strike at Toledo, Sequel to 110
 Strike at Wheeling 188
 Streator, An Interesting Case at 714
 Street Car as a Geologist 718
 Strap Handles, Wooden 256
 Sturges Sleet Trolley Wheel* 78
 St. Louis Street Car Ambulance* 463-464
 St. Louis Mileage 719
 St. Louis, Noble Work Among the Street Railway Employees in 709
 St. Louis Quarterly Report 698
 St. Clair Street Electric Line, Cleveland 476
 St. Louis, Travel in 483
 St. Louis, Passenger Traffic in 84
 St. Petersburg, Tramways of 361
 St. Paul & Minneapolis Again 235
 St. Paul and Minneapolis, Performance of Plants at 491-492-493
 Suburban Service, Largest in the World* 735
 Summer Resort Roads 733
 Sunday Transportation in Toronto 624
 Sunny, B. E. (portrait) 217
 Supplies, Street Railway in Chicago 208 to 225
 Supply Men's Organization 47
 Swedish Steam Motor, A* 555
 Switchboards, A Sermon on 717
 Switch, Adjusted Overhead* 418
 Switch, A Cable Road* 624
 Switch, Porter New Rocker* 31
 Syndicate, The New Jersey 246

T

Third Avenue Road, New York, Main Power Station of 791-792
 Those Absurd Curves 690
 Thrown up by the Sweeper 739
 Threedy, F. L. (portrait) 296
 Thurston, C. B. (portrait) 306
 Tickets, Aluminum 516
 Ties, Metal 358
 Ties, Plugging* 695
 Tiffin, Fire at* 82
 Timber Test Work, U. S. 196
 Toledo, Last Horse Car in 5
 Toledo Tower Wagon* 187
 Toronto, Canada Power House, Engines in the 625
 Toronto, Sunday Transportation in 624
 Toronto Transfer Ticket 716
 Tower of Light, w f* 344
 Tower Wagon* 263
 Tower Wagon, The Toledo* 187
 Tower Wagon on City Railway, Knox* 797
 Tower, The, on the Davenport & Rock Island* 428-429
 Traction, Comparative Resistance to 357
 Traffic, Electricity Draws the 476
 Tram Car Letter Boxes in Dublin* 780
 Transportation, Primitive, at w f* 347
 Transportation Building, How to See the 270-271
 Transportation Building, A Stroll Through 275-276
 Transportation at World's Fair 232
 Transportation for the Business District of Chicago, by Means of Movable Sidewalks 750
 Transfers, A Few Sample* 320
 Transfer Table, Day's* 321
 Transfer, The Troublesome 556
 Transfer Table, A Flush 653
 Transfer Printer, A Time 676
 Transfer Ticket, A Toronto 716
 Transfer, A Novel* 724
 Track Brush Holder, A Simple* 552
 Track Drainage* 430
 Track Curios* 404
 Tracy, L. M. (portrait) 214
 Travel in St. Louis 483
 Traveling Hospital, A 806
 Transmission, Long Distance, at Niagara 689
 Tramways Institute of Great Britain, Annual Meeting of 500
 Tramway Expenses in England 699
 Tropical Car, A* 403
 Trolley Head, R. and E.* 777
 Trolley Wire Joint 370
 Trolley Boy, The 81
 Trolley Wheel, West End* 261
 Trolley Circuit Arc Lamp* 265
 Trolley Base, Harris Anti-Friction* 32
 Trolley, The Gibbs* 433
 Trolley Malaria 553
 Trolley Polka 519
 Trolley as a Hypnotizer 490
 Trolley in Egypt 647
 Trolley, Boston Pivotal 429
 Trolley Patent, Again the 280
 Trolley Wire Splicer, A Threaded* 234
 Trolley Wheel, The Mt. Auburn 705
 Truck, Graham's Standard* 11
 Truck, Taylor Improved* 44
 Truck, Manufacture of an Electric Street Car 55-56
 Truck, McGuire's Bicycle* 427
 Truck, The New Taylor* 655
 Truck, Peckham's Improved G A* 391
 Trucks, Curious Idea in Motor* 719
 Tug-of-War Railroad Day* 639

U

Underground vs. Elevated Traction in England	558
Underground Trolley, Heitzman's System*	441
Underground Railways	621
Universal Brace*	777
Urbana & Champaign Electric Railway and Its Operation, The*	775-776-777

V

Valentine, J. L.	264
Valve, Lunken Gate*	499
Van Nuis and the Albert & J. M. Anderson Exhibit at w f*	467
Variation of Coal Consumption in Power Plants	564
Vestibule Platform Law in Ohio*	671-672-673
Vestibule, The Vogan Brothers Adjustable*	740
Vestibule Plan, Another	704
Vestibule, A New Street Car*	36
Vogan Brothers' Sander*	571
Vogan Brothers' Adjustable Vestibule*	740

W

Waddell-Entz Batteries in New York	716
Waddell-Entz System, The*	398-399
Wages and Profits, As to	34
Walking, How About Sunday	39
Walworth Pole Exhibit at w f	351

Wants His Scalp	174
Washburn & Moen w f Exhibit*	342-343
Was it a Hoodoo?	54
Washington, D. C., Crowds*	257
Wason, C. W. (portrait)	289
Watertown, Car House at*	41
Watertown Mutual Aid Society	339
Water Pipes, Electrolysis of	283
We Pull His Teeth	36
Webster Vacuum Feed Water Heater*	765
Welding Rail on the West End	436
Wells, Erastus (obituary)	673
West End's New President*	700
Western Bank Note Company, w f Exhibit of	413
Westinghouse Railway Exhibit at w f*	344
Westinghouse Company, w f Switchboard of*	280
Westinghouse, Church, Kerr & Company, w f Exhibit of*	435
Westinghouse at w f*	281-282
Westinghouse Multiphase w f Exhibit	416-417
West Chicago, Jefferson Street Power House of	14
Wharam, Wm. (portrait)	551
What Killed Him	558
Whale Back Christopher Columbus*	20
Wharton Derailing Switch*	780
Wheeler, G. K. (portrait)	217
Where Horses Ride*	246
Wheels on Curves, New	292
Wheeler, Geo. H. (portrait)	204
Where Conductors Come From	694

Whitewash, Receipt for	84
Whitney, Henry M. (portrait)	240
Why Paint Blisters	426
Wilcutt, Joseph L. (portrait)	362
Will Move Mountains Yet	142
Willans Engine and Its Western Home*	715
Will Do His Own Reviewing	708
Willans Engine and Clutch Works	402
Winding the Westinghouse Multipolar*	458
Windsor, H. H. (portrait)	225
Wood's Adjustable Pipe Bracket*	522
Worcester & Millbury Interurban	70
Worst Yet	239
World's Fair Notes	105-336-466
World's Fair*	143-144-145-146-227-228-229-230-231-232-270-271-272-273-274-275-276-277-278-279-280-281-282-403-404-405-406-407-408-409-410-411-412-413-414-415-316-417-435-436-437-438-466-467-468-469-470-471-472-473-474-475-476-477-478-517-521-579-580-584-586-629-656-714-715
World's Fair, Street Railway Interests at*	336-337-338-339-340-341-342-343-344-345-346-347-348-349-350-351-352-353-354-393-394

Y

Yerkes, C. T. (portrait)	206
Yerkes' New Residence	429
Young, W. D. (portrait)	346
Young, T. Hackworth	228
Youngstown Railway, The*	746-747



WINDSOR & KENFIELD,

PUBLISHERS AND PROPRIETORS,

269 DEARBORN ST., - - - CHICAGO.

Published on the 15th of each month.

SUBSCRIPTION, - - - TWO DOLLARS.

FOREIGN SUBSCRIPTION, - - - 20 SHILLINGS.

Address all Communications and Remittances to THE STREET RAILWAY REVIEW
269 Dearborn Street, Chicago.

H. H. WINDSOR,
Editor.

F. S. KENFIELD,
Business Manager.

CORRESPONDENCE.

We cordially invite correspondence on all subjects of interest to those engaged in any branch of Street Railway work, and will gratefully appreciate any marked copies of papers or news items our street railway friends may send us, pertaining either to companies or officers. Address:

THE STREET RAILWAY REVIEW,
269 Dearborn Street, Chicago.

Entered at the Post Office at Chicago as Second Class Matter.

This paper member Chicago Publishers' Association.

VOL. 3. JANUARY, 1893. NO. 1

BEGIN now to make your plans to visit the World's Fair and the STREET RAILWAY REVIEW. The former is the event of a life-time; the latter will endeavor to make your visit to Chicago more enjoyable.

THIS number marks the second birthday of the STREET RAILWAY REVIEW. We may not want to double its size in the next two years, but shall continue to make it intensely wide-awake and progressive.

STREET railway companies in all parts of the Union have a bright and busy year before them. Many roads will the coming season begin to realize returns from lines intended chiefly for pleasure riding, and which were completed too late for use last year.

AN unusual number of rare and disastrous accidents occurred during the last week of 1892. It seemed as though old Father Time suddenly awoke to wasted opportunities and endeavored at the last moment to make a startling record. He succeeded.

THE city council of Cleveland adopted a resolution expressing approval of municipal ownership of street railways in general; but evidently saw the error of its ways, for a little later a franchise was granted the cable company for rapid transit on the St. Clair line, which has been pending many moons.

THE New York Rapid Transit Commissioners have had their compensation fixed at \$5,000 a year each. The general term of the supreme court which fixed the salary says that the commissioners should not think that \$5,000 is an adequate return, but that "they must look to public gratitude for their reward." We fear they will need the Yerkes telescope.

ON December 28, last, the Pennsylvania Street Railway Association was organized under the most favorable circumstances, at Lancaster. There is much that the state organization can accomplish which does not come within the province of the American, and the REVIEW extends congratulations to the new association. John A. Coyle, Lancaster, was elected president.

THE city council of Bloomington has just ordained that the operation of open cars in that city must be restricted to the months of May to October, inclusive. There have been days in Chicago in November far more suitable to the operation of open cars than many other days in May or even June. We believe it should be left to the companies, and that such privilege would not be abused, to use open or closed cars according to their own judgment.

ON another page of this issue we publish a letter from an electrician who received upwards of 500 volts, and, while very vigorously shocked, was at work twelve hours later. That the full voltage was passed through his body is unquestioned, as the accident short-circuited the station. It is almost impossible that anything like as severe a shock could be received from a falling wire, and the props are now well knocked out from under the "deadly trolley" crank.

WITH the constantly increasing number of supply houses, and the desire for certain lines of business by manufacturers who heretofore have had no interest in street railway work, will come stronger competition. The buyer will therefore have a wider range in which to select, and, in some materials and appliances, lower prices. Purchasers should not, however, allow the attractions of extremely low bidders to overbalance their judgment of what is most servicable combined with the necessary wearing qualities. Repairs, not interest on first cost, count.

THIS is pre-eminently a World's Fair year. We read the fact not only in the coin of the realm but even in postage stamps. No one has yet read, however, enough to convey any approachable comprehension of the surpassing magnitude and completeness of the enterprise. No one who attends will fail to be happily surprised. It is fitting to entitle it the event of a lifetime. We trust every one of our readers will make it possible to attend. In the meantime the REVIEW will keep you fully posted as to what is being done at the point of interest, on which the eyes of all the world are centered.

THE obstructionist mayor of Detroit, Mayor Pingree, recently undertook to give an extra turn of the thumb-screws and proposed to enact a tax on the free list of the Citizens' railway. As the aforesaid free list was composed of the city officials and their satellites this proposed assessment was a case of plucking live feathers from the goose. General Manager Hawks was equal to the emergency, however, and instantly revoked all passes except the company's own employes. He has since lifted the ban from the fire and police department, but the city dads are doing penance, and find even the excellent streets of Detroit a hard Jordan to travel on foot these cool days.

ABOUT once in so often the old anhydrous ammonia motor is heard, or rather smelled of in a new part of the country. It is to be noted that, in all its travels during the past fifteen years, it is the same old anhydrous though usually bobbing up in a different suit of clothes, and never twice in the same place. If we had all the good money that has been squandered on ammonia motors we would have—well, enough to start a small syndicate. There has been as much humbug in the various chemical motors which have been sprung on the railway fraternity as in the fallacious car starter. Cars can be run by anhydrous ammonia, and caustic soda, and a long list of other gentle stimulants; they can be made to carry people; and so can balloons and ox carts, but none of them are commercially practical. They afford gigantic illustrations of what every student has seen in the physical laboratory, with all out doors for a class room and the whole public as spectators; and it all is very wonderful and very expensive and very rank of smell. But no chemical power at present known to man affords a suitable motive force for the operation of street cars.

THE linemen of Toledo, fearful lest an ill-timed strike on their part should fail in its purpose, maliciously cut the electric light and electric railway wires, and on Christmas eve the city was plunged in darkness and deprived, to a large extent, of street car service. The demands for higher wages and the limiting of the number of apprentices to one apprentice to every five men, were made by the union and not by the employes direct to their respective companies. Such acts of vandalism are as reprehensible as they are unwarranted, and at the start the strikers deprived themselves of any sympathy which otherwise might have existed. The trouble arose from the national union, which learned that lower wages prevailed in Toledo for this work than in some other cities. Wages in San Francisco, New Orleans and New York have nothing to do with the basis of wages in Toledo. To be consistent the union should furnish this class of labor as cheaply in Montana as in Maine, if Toledo wages are to be based on some other place. No thanks are due the strikers that loss of life did not result from the cut light wires. A person who cuts wires which do not belong to him should be as promptly sent to the penitentiary as the manager of a company who for some griev-

ance, real or imagined against his men, should destroy part or whole of the house and furniture in which the employe lives.

AS a rule, we believe, the street railways generally make a good selection in the choice of their men, and that these men endeavor to perform their duties in an earnest and sincere manner. To the most experienced and careful will sometimes come accidents in spite of all the watchfulness possible. There are many accidents which the victims actually force upon a company and for which their own personal negligence is to blame. On the other hand there occasionally creep into the ranks men who either are naturally careless of danger themselves, and expect others to be the same, or who allow themselves to become indifferent and so heedless of possible consequences, until they are suddenly awakened by some terrible fatality.

While not detracting in the least from what we believe to be the burden of caution resting upon the public, there can be no doubt that employes, where the evidence conclusively proves criminal and inexcusable carelessness, should be amenable to higher powers than the mere dismissal by the company's superintendent. Human life is invaluable and every reasonable precaution should be taken to protect it.

The foregoing is suggested by the recent sentence to one year at hard labor of one of the motormen of the Citizens' road, Memphis. So unusual is the case and so pointed are the comments of the Memphis Avalanche, we are impelled to quote the following from a recent editorial. Under the title of "Criminal Carelessness," it says:

The sentence of Motorman Stevens of the Citizens' Street Railway Company to one year at hard labor in the state's prison, because of criminal negligence in killing Joseph Thompson, while operating his car, affords an example which should be heeded by all persons engaged in employments which involve the care of lives of others. It is rare that convictions have been attained in such cases, and the Stevens case furnishes a precedent, if the verdict and Judge DuBose's instructions shall be sustained by the Supreme Court, which will be of important effect everywhere. The only recourse the public had in the case was to arrest and punish Stevens. A civil suit for damages might have been brought against the company by the heirs of Thompson. But that would have been a matter of private concern. The company laid no duty upon Stevens which he could not have fulfilled without endangering human life. Stevens merely forgot himself. He had never hurt any one, and, therefore, he grew careless and took chances. There was, of course, no malicious intent. The verdict was in line with right public policy. Stevens, of course, is entitled to some sympathy, and the public would not complain if he should be pardoned. It is sufficient for the public interest that it has at last been shown that the courts are ready to punish those who are guilty of criminal carelessness. It will make life more safe on our streets and railroads. Employes who are charged with trusts that include a watchful regard for human life that may be imperilled by their own recklessness or by too exact observance of carelessly given orders from their superiors, should find in the verdict a warning not to be ignored. It is well from every point that the importance of the statute has been emphasized. It was rapidly growing obsolete and Judge DuBose's charge should be studiously read by all persons who have responsibilities like those with which Stevens was entrusted.

AS a novel feature of the next convention at Milwaukee, General Manager Payne has suggested to the executive committee, that instead of the stereotyped banquet, one of the palace steamers of the Goodrich line, plying between Milwaukee and Chicago, be chartered.

The vessel could leave Milwaukee late in the evening, say 10 to 12 o'clock, and be at her dock at the World's Fair Grounds at daylight. After spending the whole day at the Fair, the return trip would again be made at night. The steamers are among the largest and finest on the lakes, and the trip would afford a delightful trip by water. We heartily endorse the plan, but agree with Mr. Payne, the date of the meeting should be made a little earlier on this and other accounts.

THE people who constitute the public, in Washington, D. C.,—that is, the minority who are left after subtracting the honorables and others who do not breathe plebeian air, and who consider themselves above riding in a street car except on passes, constitute the prize "Kickers" of all the great family, who from Atlantic to Pacific take up their favorite exercise at early dawn and continue the exhibition far into the hours of darkness. We think we have discovered the special objects of the Vanderbiltian anathema. Only a short time ago these people complained because there was no place of shelter at the end of the line in which to wait for a car. Then the company changed its schedule and held a train at the terminus until the next one came up to relieve it. As every street railway man knows, this means one full train and all its crew lying idle throughout the entire operating day; which means extra expense to the company. In most cities a grateful and intelligent public would have appreciated this endeavor on the part of the company. But not so in Washington. The inoffensive cars at once became a scandal, "occupying the streets to the detriment of the business interests of a large number of its citizens." Kickers addressed open abusive letters to "honorable senators," one of whom promises the public and threatens the company with a bill "to prevent the occupancy of streets by other than moving cars." Doubtless if terminal cars were kept revolving on a turn table, or raised and lowered on some kind of a gigantic see-saw, they might evade the bill and still claim to be the necessary "moving cars." The people of "the states" have always been told there was an overstock of fools in Washington, but it was hardly suspected the contagion had spread to such an extent. The street car companies of Washington deserve the sympathy of all the brethren. In no city in the country do street railways have as much of ignorance of street railway necessities, and the law-making powers, to contend with. There are no better roads in the United States than in the Capital City; their managers stand high in the American Street Railway Association as men of ability and experience; equipment is good; speed all that can be asked; employes carefully selected. Notwithstanding all this the roads are a perpetual target of abuse and vindictive legislation. The secret of it all lies in the fact that the railways of Washington are so subject to governmental control. The lesson is easily read as to what municipal control of street railways would create. The "honorable senator" better make a requisition on St. Peter for an equipment of golden chariots—roller bearings and buffet vestibules being specified.

AS TO WAGES AND PROFITS.

THE employes of the West End Street Railway Company, a corporation which operates extensive lines through Cambridge and other suburbs lying west of the city of Boston, have asked for an increase of pay. The case is such a thoroughly typical one that it is worth some attention.

The employes do not urge with any particular stress the argument that they are not now reasonably well paid, they say they have made an analysis of the income and outgo of the company; and as a result they are convinced that the company is earning unduly large dividends. The position of the employes is that the company should therefore divide these profits with them. Accordingly the demand is for higher pay and reduced hours of work.

In this matter several important considerations are to be taken into the account. In the first place the West End Street Railway has made a financial statement proving that its income is no more than is needed to pay its regular rates of dividend and interest. The company has within the last few years gone to great expense in doing away with horses and putting in an elaborate system of electric power. To meet this outlay there was a corresponding increase of capital upon which dividends must be paid. Consequently a much larger income is needed than before.

Yet, even were the company earning more than enough to meet its fixed charges, the employes have no right to assume that they are entitled to the excess. There is no special reason for granting them increased wages or reduced hours of work, so long as the company can hire all the men it wants at less wages than those now given.

One fact to be remembered in connection with this subject is that the street railway companies are not now in the position which they occupied ten or fifteen years ago. Then horses were used almost everywhere, and changes in motive power were not contingencies for which it was necessary to save much money. To-day, on the other hand, the liability is that almost any morning the manager may wake up to learn that during the night some one has discovered an improvement in electric railway appliances which renders some part of his equipment obsolete. In order to furnish the best obtainable to the patrons of the road he is forced to incur enormous expenditures, and suffer perhaps a total loss on what was until that time the best in the market. So rapid have been the improvements marking the past three years of electric railway metamorphosis that many roads have actually thrown out more than they have worn out. While it is fair to presume this danger is on the decrease, no intelligent man would for a moment consider the liability as removed.

Accidents to horse-stock could be very closely anticipated, and with the exception of severe epidemics which have appeared only at long intervals, such losses were evenly distributed throughout the year.

In the electric plant the burning out of a single armature may involve a loss of two thousand dollars in a fraction of a second.

An electric railway power station is a small exposition of delicate and costly machinery.

As soon as better appliances are invented the West End Company, as well as most of the others in this country, will be forced by public opinion, if not by the instinct of self preservation, to adopt them. The change will mean a considerable loss for which the companies should be now making some preparation. In other words, there is a rainy day ahead for which it would be wise to save something, to say nothing of necessary renewals from wear.

Still another view of the case is brought forward by the Boston Herald, which, in commenting on the demand upon the West End road, begs the employees to remember that, leaving aside the necessities of the corporation, the public is entitled to some share of excessive profits. The public grants the railway a monopoly of the streets. While the employees argue that the company is not entitled to surplus profits, and that the extra money should go to the employees, the truth of the matter is that the employees are no more entitled to excessive wages than the company to excessive profits. A company which receives a franchise from the community is in turn bound by an obligation to the community.

If it earns excessive profits, the public and not already fully paid employees, should receive the benefit, and this in the form of an improved and increased service. Franchises are not granted nor roads built to merely afford wage earning opportunities to employees. Roads are built to serve the public, of which the company's employees constitute a very small part. Employees are entitled to what their work is worth; after this, if a road reaches a point where profits are "excessive" the obligation immediately arises to improve its service.

When that time comes companies have it largely in their own power to create the public sentiment they will have to meet.

The sum of the matter is, then, that the public should no more countenance a street railway company in paying employees excessive wages than in exacting excessive profits.

NEWSPAPER RAPID TRANSIT.

THE exceedingly dismal failure of the gigantic scheme to furnish the city of New York with rapid transit should be an object lesson to three classes of people, namely, the secular press, the political economist and the recalcitrant citizen known commonly as the kicker. The general progress of the great object to be attained has been retarded two years at least. Eminent men and true, first-class engineers and the best legal talent have failed to do what one single every-day capitalist with common sense could have done in half the time.

The wildly delirious joy which welcomed the rapid transit scheme is best illustrated by a few excerpts from the Tribune, Mail and Express, Times, and Post, who hailed the scheme in these words:

"The franchise will be one of the most valuable railroad franchises in the world. The travel in that great artery of the metropolis will be enormous as soon as the road is open, and it will increase steadily and rapidly. Look at the yearly increase on the elevated roads, and remember that the new road is to be the great popular line for a fast growing city."

"The proposed system is immediately feasible from a financial point of view. The probable cost of construction and equipment falls within moderate limits, and hence the project appeals to men of prudence and stability, instead of to visionaries. There will not be the slightest difficulty in enlisting capital in the undertaking. There is likely to be a livelier competition for the franchise than the best interests of the city require."

"The road will cost a great deal of money, but so will any road that shall adequately meet the need. As it is certain to pay good dividends upon a heavy investment, its cost will be no barrier to its early completion. There is capital in plenty eager for an investment so surely profitable."

"No railroad was ever planned anywhere on the face of the globe that presented such attractions to capital. Never since Stephenson laid his first rails from Stockton to Darlington has any road been surveyed that promised to gather half as much traffic per mile."

The sequel of one bid, and that refused, tells the whole tale. Let rapid transit men provide rapid transit; let the engineers engineer and the preachers, teachers and school children attend strictly to business.

The moral also is pertinent that when cities undertake to engage in the planning of intramural transportation they are out of their proper sphere. How much more, then, would they be in the vastly increased responsibility of owning and operating.

The public are better provided for with street railway lines in the hands of corporations than it could possibly be under municipal control.

NEW ORLEANS NEWS.

EVERYBODY and everybody's smartest agent is now looking southward to New Orleans where the biggest orders since the Brooklyn equipment of last year, will be distributed during the last of this month or the first of next. It is pretty well understood that the General Electric has the first say as to equipment in their lines. The New Orleans manager will be H. M. Littell, of Cincinnati, while M. Hart, of New Orleans, will hold some high office, perhaps be president.

A VALUABLE BLOCK SIGNAL.

A VERY simple yet effective system for operating cars on single track, where it is impossible to see from one turnout to the next has been devised and put in successful operation by Mr. Ramsey, of the Pleasant Valley road, Allegheny. The illustrated description on another page will prove useful for adoption or modification on many single track lines which have experienced the same difficulty which gave rise to the adoption of the system mentioned.

THE Buda Pesth Electric has been sold by Siemens & Halske to the Anglo-Austrian bank there for 3,000,000 florins. The great confidence shown by such conservative capitalists augurs well for the financial success of like undertakings elsewhere in Europe.

HALF FARES.

Interesting Facts from all Parts of the Country Boiled down for Busy Readers.

ST. PAUL city council have fixed speed limit at 10 and 12 miles an hour.

THE product of the St. Louis street car factories for 1892 was nearly \$5,000,000.

OFFICIALS of the Kansas City Cable, and reported buyers, both deny the sale of that property.

WINNIPEG street railways are indulging in a rate-cut, and passengers now ride twelve times for 25 cents.

THE Columbus, O., railway gave 350 turkeys to the married employes and \$200 in money to other of its men, on Christmas.

THE Appleton street line, Springfield, Mass., has a tower car in place of a tower wagon, and it is said to greatly facilitate repairs.

WAGES have been raised 11 per cent on the South Covington & Cincinnati road, conductors and motormen now receiving \$2 per day.

KANSAS CITY is besieged with a compressed air scheme. The Kansas City Cable Company has received 7,000 feet of cable from Leeds, England.

WHEN President Yerkes is in New York he keeps in constant touch with his Chicago offices of the North Side and West Side roads by the use of the long distance telephone.

PRESIDENT LEWIS, of the Brooklyn City Railway has renewed his contract with the Knights of Labor for 1893, conductors and drivers receiving \$2, and stablemen \$1.75 per day.

THE divorced wife of M. Clemenceau, who recently indulged in a little harmless target practice, is visiting her uncle, James Sticknor, president of the West End Electric, Rockford, Ill.

IN Denver, a tobacco spitting passenger was offered his choice of desisting or leaving the car. He got off and so did five shots from his revolver, which narrowly missed the conductor and passengers.

A FEW days before the big fire General Manager Payne was hauled over the coals for a little smudge caused by one of his power-house stacks; but when he made \$250,000 worth of smoke and trouble there wasn't a word said about the smoke nuisance.

THE Mayor of Racine, Wis., is interested in the street railway there. Somebody conceived the idea that while either in itself was all right, to be both was sinful. The

mayor promptly resigned, but the city fathers sensibly refused to accept it, and again all is quiet on the Potomac.

THE Wheelless system of underground electric railway which many papers are publishing as nearly completed in Washington, D. C., and which the promoters maintain will be in operation the 20th of this month, has not been commenced, and the opening seems a long way off.

A CAR on Soho Hill, at Pittsburg, refused to obey the brake and reversing handle, and went coasting on its own account. Snow on the track was the cause. Most of the passengers got off. The car jumped the track after smashing two wagons, and was finally stopped by a heavy telegraph pole, which was snapped like a pipe-stem.

THE annual report of the Postmaster General gives very favorable results as to the use of house collection boxes in cities. Money order offices were increased two-thirds during the year, and sixteen and three-fourths million miles of railroad travel added. The deficit was reduced a million dollars and 2,790 new offices established.

THE LAST HORSE CAR IN TOLEDO.

IT may not be apparent to the careless observer that Manager Albion E. Lang, of Toledo, is possessed of sentiment and poetry in a high degree. But such is the case. His poetic nature finds a channel in deeds rather than words, as the following incident will show.

Eleven or twelve years ago Mr. Lang purchased of its original owners a strip of strap rail and a few dilapidated cars, known as the Dorr street line.

After years of patient labor the Toledo Consolidated has been brought to its present perfection, and the last line to come into the fold of electric traction was the Dorr street line. On the last day of 1892, however, Mr. Lang was notified that the line was finished and Mr. Lang indulged the sentiment above referred to. So, equipped as motor man, the manager ran the first car over the line amid the cheers of the citizens and the waving of handkerchiefs.

Upon his return to the office Mr. Lang thought of more sentiment and put it into execution. Therefore the old horse car was run onto the tracks, and Mr. Lang as driver took the reins of the midnight car, and while 1892 flitted away and the dreary midnight bells tolled the death of the old year, the last horse of the last horse line made its farewell appearance in Toledo.



THE MILWAUKEE FIRE.

A PILE of formless brick, a few jagged pieces of wall and heaps of warped and twisted trucks were all that the flames left of the Kinnickinnic avenue barns of the Milwaukee Consolidated, on the morning of December 28.

The magnificent car barns and well equipped shops of the Villard syndicate were brought to their highest perfection in the Kinnickinnic plant, which structure had been finished but a short time. The building was an immense structure, 270 feet long and extending 204 feet deep, of solid brick, two stories high and most substantially built. The car barns proper cost \$35,000, while the new shops were worth \$30,000, besides machinery

tion discredit this theory, which is supported by the endless accounts of fires in Milwaukee for three months past.

The loss sustained is hard to estimate, but it undoubtedly lies between \$250,000 and \$300,000. Nothing was saved and the fire burned itself out. The insurance will cover the greater part of the loss. Immediate preparations were made by the energetic management for a new plant.

The English custom of leaving luggage on the platform with the conductor has given rise to some trouble as to liability of the company in case of loss. A recent decision against the company was caused by the fact that the company's rules require large baggage to be left on the platform.

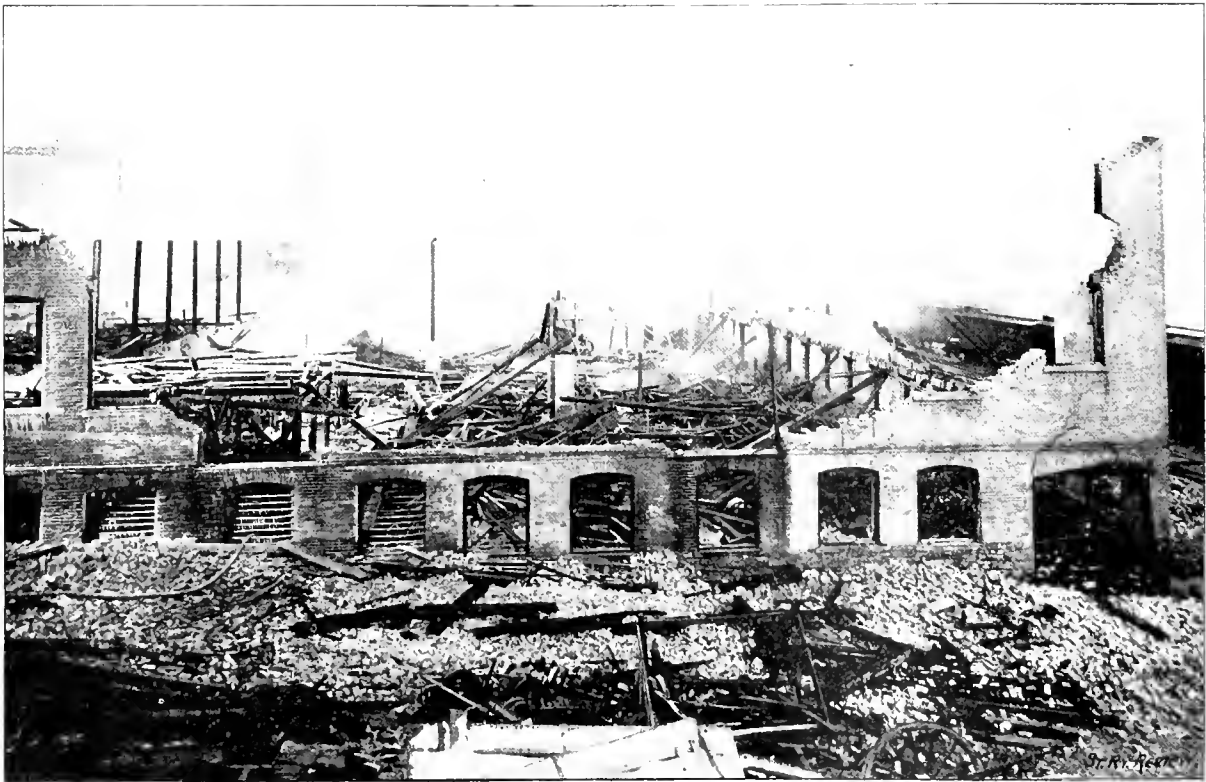

RUINS OF THE KINNICKINNIC AVENUE CAR HOUSE, MILWAUKEE.

costing close to \$70,000. A temporary power plant, which was in process of building at the Dutcher Stove Works adjoining, was not touched, and except for a few supplies suffered no interruption.

THE FIRE

began, according to the statements of the watchman, with an explosion in an owl car which was brought in about 1 o'clock. The flames rapidly spread, and before the car could be removed or help summoned the flames were running from one car to another along the line of stored cars. One hundred and four cars in the building were destroyed, which is nearly half the equipment of the road. One hundred and twenty-seven motors were lost.

Manager Lynn believes the fire to have been of incendiary origin, while the police department in self protec-

BAY CITY CHANGES.

A PHILADELPHIA syndicate represented by W. B. McKinley, of Chicago, has purchased the roads of Bay City and West Bay City, Mich. This is the same syndicate that operates the lines at Buffalo, Rochester, Indianapolis, and other places. West Bay City is already equipped with electricity, and the syndicate will at once install the same at Bay City, making in all, about 20 miles of road so operated. The station now operated by a 200 horse-power, Allis engine and Westinghouse generator, will have two more similar units added. As two of the units will operate the station, the reserve is 50 per cent. Eighteen new 50 horse-power motor equipments will be put on at first, and the service greatly improved in various ways.

PERSONALS.

S. DANA GREEN, with John Krensi and other officials of the General Electric, made a December visit to the World's Fair city.

H. C. THOM, chairman of the Republican state central committee of Wisconsin, has been made secretary of the Four Lakes Power & Lighting Company.

A. BARTLETT, superintendent, Syracuse, N.Y., consolidated, has resigned, and will remove to California. Mr. Bartlett has been in street railway work upwards of thirty years.

A. B. PEAVEY has resigned as superintendent of the Sioux City Street Railway, and will enter business for himself. His successor is I. B. Walker, who has been electrician of the road since its electric installation.

J. H. ALLEN, advertising manager, of Dixie, Atlanta, displayed a beaming countenance, the result of recent

COL. JOHN SCULLIN, of St. Louis, is another rising man in rapid transit circles. His latest acquisition of the Benton Bellefontaine road, and the consolidation with the Union Depot and the Mound City Lines, will make him one of the largest street railway owners in the west.

LEO DAFT, whose name is such a familiar one in electric railway circles, favored the REVIEW with a most delightful call during his recent brief visit to Chicago. With a view to benefiting his family's health, Mr. Daft a few months ago took up a temporary residence on Puget Sound, and has already become largely interested in a new street railway and light plant at Everett, Wash., and in numerous valuable mining enterprises, which bid fair to make him one of the bonanza kings.

AN inquiry made by Major General Hutchinson into the condition of the Highgate, England, Cable Tramway resulted in an order to shut down the works until repairs could be made.



SCENES OF THE KINNICKINNIC AVENUE CAR BARN FIRE, MILWAUKEE.

triumphs while in Chicago in the interest of his journal; the December souvenir number of which was very fine.

L. M. COLLINS, of the New York office, of the Electrical Engineer, becomes western editor and manager, with headquarters in Chicago. Mr. Collins is well known to the electrical fraternity of the west, and the REVIEW wishes him success.

L. M. HART, New York, business manager of the new consolidated publications, under the new name of Heating and Ventilation, called upon us a few days ago. He is meeting with good success, and under his management the paper is sure to prosper.

H. FORMAN COLLINS, who, as western editor and manager of the Electrical Engineer, has made so many friends and so marked a success, has resigned to accept the position of business manager of the Western Electrician. We sincerely wish for Mr. Collins in his new relation all the success the increased scope offers.

McMAHON'S AMMONIA MOTOR.

THE McMahon ammonia motor is being again exploited, this time on the Twenty-eight street line in New York. The anhydrous ammonia is obtained by evaporation from aqueous ammonia 120° F. It is then put into a tank on the car at a pressure of 80 pounds. The motor is run from this tank and the exhaust delivered into a weak solution of aqueous ammonia carried on the car. The claims made resemble perpetual motion. The outside cost for operating the ammonia motor is to be 7.68 cents a car mile, and the cost of a fifty car plant \$25,000 as against \$250,000 for the electric. The latent heat of the aqua ammonia carried on the car is to furnish force enough to keep the gas tank sufficiently warm to furnish force to run the car after the common every day energy is all gone.

One advantage possessed by no other motor lies in the fact that, when the proverbial old lady faints on the car, the conductor can instantly turn a hose of liquid melling salts on the patients.

H. M. LITTELL.

DECEMBER'S DIRE DOINGS.

NEVER honor came more deserved than that which made H. M. Littell, of the Mt. Auburn road of Cincinnati, manager of the recently consolidated New Orleans lines.

In selecting a man for this pivotal position there are enough requirements demanded to make the most experienced manager quake, and enough hard problems to solve to wrinkle up the smoothest brow into a map of County Clare. In the first place, the New Orleans lines will have to be completely reorganized, from groom to master mechanic, and the winnowing out of incompetent and uneducated workers will fall mainly upon the manager. Then, too, there is a great big public in New Orleans, not any better or any worse than in other places, but all completely ignorant of the advantages of rapid transit, and made aware of electric traction only by the vapid musings of some country editors down in New York City. These good people will have to be educated to the necessary degree of intelligence, and great patience and tact is another requisite of the manager.

These are some of the considerations by virtue of which Mr. Littell has been chosen.

It was four years ago since the affairs of the Mt. Auburn Inclined Plane and Street Railway Company began to look for a Moses to take them out of the land of deficits, and later there arrived a handsome young man who was introduced as H. M. Littell, the new manager. Under Mr. Littell's management the road was electrified, heavy girder rail laid, and improved inclined plane carriages made, together with extensions and improvements which have made new territory, won the public approbation and paid dividends. Stock that was bought at five cents on the dollar is now worth ninety-five. This Mr. Littell has been the means of doing.

Previously he was manager of the St. Paul roads.

Personally Mr. Littell is affable, a great favorite in society, and a leader in many benevolent and social enterprises, and for him we predict success in direct proportion to his great opportunities in New Orleans, the citizens of which city will find in him a broad-gauged, liberal man of strong executive ability.



H. M. LITTELL.

AN unusual number of fatal and peculiar accidents occurred in various parts of the country during the last few days of December.

In Chicago, John Nelson, driver of a horse car on the West Chicago road, managed to stop his car, but the runaway team dragged him over the dash and some distance along the stone pavement, causing injuries from which he died in a few hours.

A lady passenger on the North Side cable entered a car dragging a piece of telegraph wire, one end of which was wound around her leg, the other fastened to a large coil of the wire at a pole. It was not discovered until the car started, when the unfortunate woman was suddenly jerked through the door, striking the dash, and before the car could be stopped had most of the flesh stripped from the bone and she was otherwise injured. The accident has no parallel, so far as we can learn.

At Boston, the Everett power house of the West End road was wholly destroyed by fire, in which four employes lost their lives.

At Milwaukee, the Kinnickinnic car house and machine shops of the Milwaukee Street Railway were burned at 2 o'clock on the morning of December 28, 1892. Loss, \$300,000.

At Minneapolis, a crowded car was run down by a Great Northern switch engine and many injured, on December 21.

On December 29, as a horse car of the Forty-seventh street line of the Chicago City Railway was crossing the tracks of the Pennsylvania railroad, a construction train running at high speed ran down the car,

and four persons were killed. The accident occurred very early in the morning, before light, and the blame seems to rest on the gate tender, who was warming himself in a shanty near by, and the failure of the train crew to display proper headlights.

At Seattle, the day before Christmas, an electric car jumped the track, plunged into the bay, and sank. All were rescued, one passenger is probably fatally injured.

The iron supports of the new power house of the Baltimore City Passenger Railway, now building, gave way and the roof fell in, injuring eleven workmen, one of whom will die.

OUR SECOND BIRTHDAY.

At the Age of Two Years the "Street Railway Review" Enjoys Prosperity and Prestage Rarely Obtained in Ten—An Ever Increasing Success—Its Columns Read and Quoted all over the World—
Again Forced to Seek Larger Quarters.

WE, that is the STREET RAILWAY REVIEW, are two years old. True, two years are not many, yet two years were sufficient to develop the magazine you hold in your hand from a purpose known only to its publishers, to what it is, the leading journal in the world devoted to street railway interests. In two years the anxieties (!) in certain quarters, that the REVIEW would not hold out have been entirely dissipated: in two years the REVIEW has won a foremost place among the thousands of publications which fill the land: in two years it has become a gladly welcomed visitor to every street railway office on the continent, and is on the select list of the limited number of periodicals read by railway presidents, directors, managers and stock holders, whose interests are large and whose time is valuable.

The world moves and so does the STREET RAILWAY REVIEW, not because it does not promptly pay its rent, but because its rapidly developing interests have constantly required more room. For the third time in two years we have outgrown our quarters, and so last month took up our present abode, with ample accommodations for every department of our work. With a special view to taking care of all the street railway people who will visit our city during the Fair, we have secured ample room for pleasant reception quarters, opening into our business offices; while the location could not be better chosen, the Post Office and two leading hotels being within one block, and central to all railroad depots. We thus early extend an invitation to all our friends to make the REVIEW office headquarters when visiting the city.

OUR CIRCULATION

while surprisingly large from the start, has rapidly and steadily grown each month until we now have a larger number of readers than any other journal devoted to street railway interests. Considering the size, character and quality of the REVIEW, our subscription price is the lowest of any technical paper published, and while our readers generously urge us to increase the annual dues, we have always believed in, and worked along a broad-gauge policy.

THE ADVERTISING PAGES

of any paper at once indicate what manufacturers think of it, and the well-filled columns of this department are a gratifying endorsement of a "two-year old." Our record shows an increase for every month over the preceeding month, while the advertisements carried are those of leading concerns.

Our well-known policy in uniform rates, has never been deviated from in a single instance and has won the respect of business men. We have but one price, and

that the same to all. An offer of one dollar less than established rates would be no greater temptation than one hundred dollars. We are aware that comparatively few publications adhere to this policy, although no reputable publisher will, for a moment, take advantage of one advertiser and charge him more for a given space than is paid by any other advertiser using an equally good location. It is not only an unbusiness like procedure, but positively dishonest.

OUR ENGRAVING DEPARTMENT

has been largely increased and improved during the past year, and the quality of our illustrations place, them among the finest put in print. In this, as in the feature of press work and paper, no expense is spared to secure the best for the purpose, which can be obtained. The REVIEW has now a special photographer in almost every city on the continent, and within a few hours a telegram brings any desired view for illustrating, which may be of interest or value to our readers.

THE EDITORIAL FORCE

has been doubled and includes carefully trained and intelligent writers. Their work speaks for itself. In addition several hundred correspondents scattered all over the continent and in foreign lands enable us to secure reliable and interesting information from authentic sources. Our department devoted to

STREET RAILWAY LAW

furnishes each month a digest of decisions in higher courts, and is edited by a leading attorney of Chicago, who for years has made a special study of street railway cases. The first few lines of each report epitomize what is elaborated below, making a perusal of the entire digest unnecessary.

OUR DAILY EDITION.

For several months past the REVIEW has issued a daily edition, which is mailed at noon every day except Sunday. This edition is specially compiled for the exclusive use of our advertisers, and contains advance information of the organization of new street railways, where purchases are likely to be made soon, who the buyers are and what they will want to buy. Our facilities for securing this information is unequalled, and, it is hardly necessary to add, the "two-year old" REVIEW is the only publication in the field furnishing such advance news. The value to our advertisers of this publication is fully attested by complimentary letters received almost every day. If all the

GOOD WORDS FOR THE REVIEW

received by us were printed they would require several pages each month. It has never been the policy of this

paper to reprint such letters, as the standing and character of the REVIEW sufficiently speak for it. We do, however, most fully and sincerely appreciate the encouraging terms of approval our readers so kindly send, and shall always endeavor to merit their fullest confidence; and are thus constantly urged to greater efforts in our aim to continue in serving them with the best street railway paper in the world.

THE CHICAGO STREET CAR AIR BRAKE.

AS an evidence of Chicago enterprise the progress of the company whose title appears at the head of this article is a bright example. An air brake for street cars has just been perfected by N. A. Christianson, who has been at work on the appliance for several years. Having satisfied themselves of its undoubted merit, and well knowing the demand for a good brake, the company was organized on December 1, 1892, as follows: President, John A. Kruse, who is president of the Lone Star Iron Company, Jefferson, Texas, and a large capitalist; Edward Atfield, secretary and treasurer; L. J. Gennett, inventor of the air brake which bears his name, as mechanical superintendent; N. A. Christianson, consulting engineer; and David Reid, general sales agent. Mr. Reid's long connection with street railway interests and his acquaintance, which includes so large a number of street railways, specially fit him for the department he has in charge. Mr. Gennett's experience in air brake development will be invaluable in his new connection.

The new company in less than forty days after its organization had fully perfected its manufacturing arrangements and already have a large force of skilled mechanics engaged in getting out the brakes. It is one of the quickest cases on record. The makers confidently assure the railway public that the Chicago Street Car Air Brake is by far the most simple yet devised, and is, moreover, the only one that can be adapted to all trucks. No removal of car wheels is necessary to apply the brake which can be done by ordinary mechanics. The wearing parts are few and inexpensive. So thoroughly satisfied are the makers they offer to send a man, at their own expense, to put in a trial brake for any street railway which makes application therefor. The factory is at 44 South Jefferson street and the offices 804-806 Rookery Building, Chicago.

GOOD RECORD.

HAMILTON, Ohio, has 18,000 people and nine miles of electric road, on which are 15 motor cars and 8 trailers. While horse lines were the only means of traffic, the company could hardly pay expenses, now the road pays 4 per cent with the following increase in traffic. Passengers carried January 1892, 58,426; February, 55,147; March, 62,048; April, 67,108; May, 76,378; June, 86,442; July, 98,799; August, 110,224; September, 100,577; October, 100,623; thus going an increase in ten months of 42,197, or nearly 75 per cent.

PENNSYLVANIA STREET RAILWAY ASSOCIATION.

THE above title adds another to the list of state associations, and while contemplated for some time past, was brought to a focus by a call made by John A. Coyle, of Lancaster, at which city the convention met to organize, on December 28.

The meeting was a very enjoyable and satisfactory one, and after adoption of a constitution and by-laws, elected officers for the first year as follows:

President, John A. Coyle, Lancaster.
Vice-president, John G. Holmes, Pittsburg.
Second vice president, H. R. Rhoads, Williamsport.
Secretary, L. B. Reifsynder, Altoona.
Treasurer, Wm. H. Lanius, York.

The next meeting will occur at Harrisburg, the first Wednesday in September. Initiation was fixed at \$25, with annual dues of same amount. The executive committee are authorized to transact all business between meetings. The members of this committee are: The president and secretary ex-officio, and B. F. Meyers, Harrisburg, Wm. B. Hayes, West Chester, S. P. Might, Lebanon.

THE REPRESENTATIVES PRESENT

included the following gentlemen: B. F. Meyers, representing the Citizens' Company, of Harrisburg; L. B. Reifsynder, of the City Railway, of Altoona; John Haeigen, of the Johnstown lines; W. H. Lanius, superintendent Charles Long and Captain Geise, of the York Company; Patrick Russ, of Harrisburg, representing the Wyoming Traction Company, of Wilkes-Barre; John F. Ostrom, of the Middleton & Steelton road; J. Q. Denny and E. C. Felton, of the East Harrisburg line; W. B. Given, of Columbia; H. C. Harner, of the Lebanon and, Annville; Wm. Hager, of West Chester; H. B. Rhoads of Williamsport, and others from a distance. J. W. B. Bausman, Esq., Lancaster and Lititz; Dr. M. L. Herr, Lancaster and Strasburg. Local roads, of course, were represented, and H. J. Kenfield, of the STREET RAILWAY REVIEW, held up the street railway press alone.

In the opening speech Mr. Coyle stated that of forty-nine operative railways in the state, two-thirds of that number replied favorably to the suggestion, and that great benefit ought to accrue from the organization.

President Coyle very appropriately and generously closed proceedings with an elegant champagne dinner and a ride over his lines.

The only supplyman present was Howard Wheeler, of the Globe Iron Works, New York, but we can assure our Pennsylvania friends that their next meeting will be well attended by both newspaper and supplymen.

The Pennsylvania association is most fortunate in its executive department, and we strongly urge the smaller roads in the state to aid by presence and support.

EDWIN A. ALLEN, president of the Houston, Tex., Street Railway Company, died at Chadron, Neb., Jan. 7. Mr. Allen was a high mason.

GRAHAM'S STANDARD ELECTRIC MOTOR TRUCK.

THE severe wear which has come to rail joints with the use of electricity is not entirely due to the increased speed of the electric cars, nor to the fact alone that those cars are a great deal heavier than was possible when operating with animal power. It has been in many cases largely due to an improper suspension of the weight rather than the weight itself. A truck without proper springs allows the wheels to come down with a solid weight and pound the joints.

With the special object of correcting this difficulty the Consolidated Railway Supply Company are manufacturing, and have put on the market, the Graham Standard Truck, which embodies several new features which will interest street railway men.

attaching truck to the car. Four bolts hold the truck to the car body. These can be taken out in a very short time and car body removed. The large cut, Fig. 1,

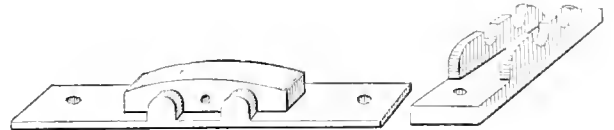

FIGS. 2 AND 3.

represents Graham's standard short truck "No. 32," which is intended for use on short cars. The attachment of the truck to the car is such as to prohibit all side play, making a perfectly solid joint.

A radial truck for four-wheel cars is also made. The frame is of 3x1 inch steel. Brake gear positive and simple; and twenty-eight bolts in the entire truck.

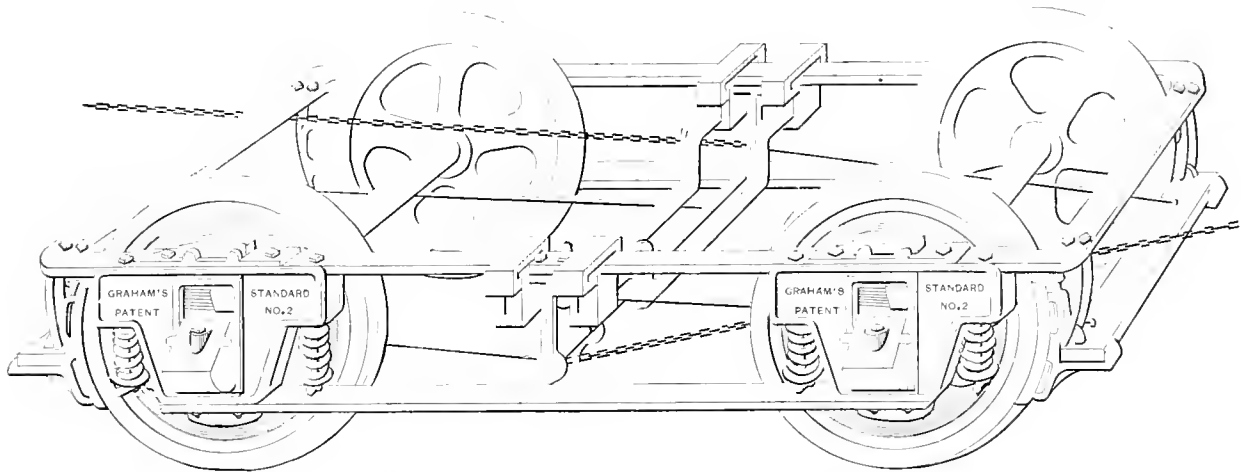
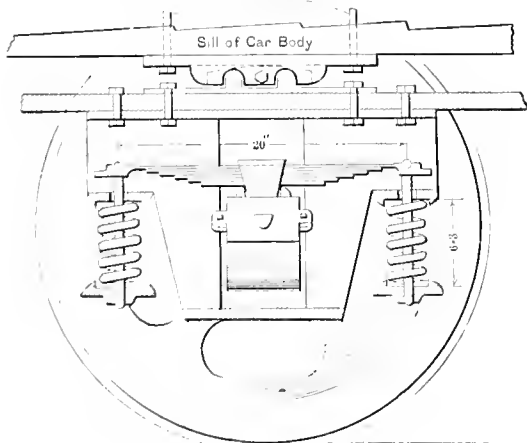

FIG. 1.—GRAHAM'S STANDARD SHORT TRUCK, NO. 32.

As shown in the cuts the weight of truck and car is carried on springs. These springs are of two kinds. The spirals take the greater part of the work until the car is heavily overloaded, when they are exhausted and the

In the case of one motor breaking down, it is only necessary to change the disabled end, and by a simple operation keep the car in service. Jack up the car at the disabled end; remove king bolt and coupler bolt; run the disabled part out and new one in; then drop the car down; couple up the motors and it is again ready for service. It prevents oscillation, has an extended wheel base of from seven to ten feet, and takes curves easily and can be easily attached or removed.



SPRING EQUALIZER AND PEDESTAL, WITH FRONT REMOVED.

Superintendent Pond, of the New Haven & West Haven road, says: "It took the sharpest curve we have easily and without any hard grinding, and after leaving curve squared itself without any trouble. No oscillation, whatever, was perceptible, even when our ten bench open cars were fully loaded."

The Consolidated Railway Supply Company, have offices at 258 Washington street, Boston, 20 Market Square, Providence, and 616 Ashland Block, this city. They are confident that they have a practical truck and invite inspection by street railway men.

half-elliptics "do the rest." The spiral springs will carry 1,500 pounds before exhaustion and the half-elliptics 5,000.

Figs. 2 and 3 show the male and female castings for

A MULTIPHASE railway system has just been patented by Prof. F. B. Badt. It involves the use of multiphase currents in connection with converters and sectional exposed rails.

RECEIVED 550 VOLTS.

And Lives to tell the Readers of the "Review" all about it—Hard at Work Twelve Hours Later—
Statement of the Attending Surgeon.

PEOPLE generally have been lead to believe that the slightest contact with a live trolley wire meant an instantly dead individual. The daily press has preached this gospel by the column. Electricians have denied it in vain, although honestly admitting that the power which propels an hundred loaded cars was necessarily rather energetic. Claims have been made by numerous persons as having "received 500 volts and lived," but in previous cases there has been wanting positive proof of the actual amount received.

At last, however, we find an instance which admits of no doubt, and while the gentleman whose experience we are about to relate at first refused the publicity which this article brings, finally consented to give to the readers of the STREET RAILWAY REVIEW an account of the accident and his sensations "before and after taking," purely on the grounds of its scientific interest and rarity. The gentleman referred to is Lewie A. Chatterton, the accomplished electrician of the Auburn, N. Y., City Railway, and replying to our inquiries he writes us only a few days after the event and tells, as follows:

HOW 500 VOLTS FEEL.

"I was testing a new armature, my mode being to raise the car in the air, try the armature first with the lower field and pole block, before putting the upper field and pole block in their places. The current had been applied three times. The brush holder side-tension springs were very weak, and I placed my foot upon the upper holder to make a perfect contact. I then told the houseman to turn on the current again; the armature appeared to be running away; my foot slipped from the brush holder down on the commutator, and whether my hand grasped the connections on the field block, or the stove, I cannot tell. I got that *chug*; the armature seemed to reverse, and that is all I remember until I regained consciousness in the office, which they say was between 25 and 30 minutes. When I came to myself I was taken with nausea and was very numb all through my left side. I tried to stand and my limbs doubled up. The sickness remained until the next day. The tired feeling is about

all gone: but I am very nervous and the slam of a door will make me jump. We were carrying between 500 and 550 voltage, but I do not know what quantity I received. I have received a great number of shocks but never one to put me to sleep before. At one time in particular I was connecting the main trolley wire in the station to a branch trolley, and the ladder being against the main trolley, I placed a coil of No. 3 copper wire on a box and taking the end in my left hand started up the ladder. When near the top of the ladder, which was only three inches above the trolley. I thought the ladder

was slipping and grasped for the trolley wire to save myself. The sudden move caused the coil of wire to slide off the box, on to the rail, or house track, thus forming a complete circuit and burning my fingers. That felt as though I had been struck in the base of the neck with a sand bag. I was lame for two days after that but not sick. The last accident short circuited the station.

I have since repaired two armatures, wound three fields, and am now re-winding an armature. I can say that aside from being a little nervous I

FEEL AS WELL AS EVER

I have felt. After the first chug I had no sensation whatever until I came to myself, and then as heretofore described. I don't like notoriety, but for the sake of the "I told you

so's" and the "deadly trolley" cranks I am willing to give you my experience."

Yours very truly,

Lewie A. Chatterton

When the accident occurred the company immediately summoned Dr. C. O. Baker, a well-known physician of Auburn, and who, as one of the official surgeons, has been called to witness the infliction of the death penalties by electrocution, all of which have occurred in the Auburn Prison. Hence, the statement of Dr. Baker is one based on actual experience and is rendered the more interesting and valuable on account of that observation.



LEWIE A. CHATTERTON.

THE DOCTOR'S STATEMENT.

It is true that I was called to see L. Chatterton, of the Auburn Street Railway Company, who was recently injured while repairing some part of a car motor. He is an expert and I am informed that he received a 500-volt current. I found him probably 20 minutes after the shock, sitting in a chair in the company's office, unconscious. Skin cold and moist all over the body, pulse very irregular and about 140 and sometimes almost imperceptible, respirations about 10 per minute, muscles of the body relaxed save those of the left leg, in which he received the current, and left arm. I think that the course of the current.

I ordered him placed on his back on a table, with the head quite low, which position sent more blood to the brain, but did not, for five minutes at least, improve the pulse very much. I asked to have a piece of soft iron placed in his hands as an experiment, and a piece of cast iron weighing 10 or 15 pounds was placed under his hands, and in two or three minutes the pulse improved, and in ten minutes he was sitting up and telling how it happened that he had taken the shock. I am not prepared to say that the iron did any good. I would suggest that it is always best, however, to place such a patient upon the back with the head either on a plane with the body, or lower, and to stimulate by friction and artificial respiration. Why this man did not suffer more than he did I do not know; probably because more vital tissues were not invaded. He complained of a bad feeling in the head and numbness of the leg and side, but went to work the next morning, 12 hours after the accident, seemingly all right.

You speak of electrical execution and ask if there is a parallel between it and the case of Chatterton. I should say no. I cannot argue the point fully for I do not know the position nor the contact of the body in Chatterton's case, and no one saw him at the exact time of the accident. In arranging for an electrical execution the utmost care is taken that all points of contact are perfect, and that the current is passed directly through the vital parts of the body. The brain and spinal cord are aimed at with "deadly precision" and the electricity measured out in quantity, quality and time, accurately and scientifically, by cool and careful hands. The first shock or contact of the electric current given to a man in the electrical chair probably kills in a space of time too small to calculate intelligently. It may be compared to the blowing out of a candle, and who can appreciate the time in which the flame is "going out." The current is continued for a few seconds, and all the muscular tissues of the body are contracted to some extent, and when the electricity is taken off the muscles relax, but it is not life. They will not again contract except by the electric stimulation. The pathological changes you ask for are not manifest at the post-mortem to the microscopical examination, and the microscope has failed thus far to give the desired information as to the cause of death. I am very glad that science has afforded us at last a means of administering

the death penalty which is completely under control and which is instantaneous and painless, and in a manner somewhat humane.

Very truly,

C. O. BAKER, M. D.

The reader should bear in mind that the contact made by Chatterton was made with all his strength, and that the accident occurred at the power house where the voltage is the highest. That he received the extreme 500 to 550 volts is proved by the short circuiting of the station. It would be impossible for a person to receive as severe a shock from falling railway wires in the street as was experienced by Mr. Chatterton.

SOME DENIALS.

GROVER CLEVELAND positively denies any connection with the street railway syndicate. This was the first of a series of annual denials. Henry Villard repays the compliment of Mr. Cleveland's repudiation of street railway business by boldly saying that he will not go into Mr. Cleveland's cabinet. Then comes ex-Secretary Whitney, of the navy, who says that nothing on earth will now stop him from a rapid transit career, and John D. Crimmins says that managing railways with the full complement of kickers, and New York kickers at that, is more to his taste than politics. Even Bismark says of the Milwaukee street railway that "he is not in it." The STREET RAILWAY REVIEW stands ready to print denials from all the rest of its constituency if it becomes necessary.

MOTORS DISPLACE MADISON MULES.

AMONG the recent "converts" is Madison, Wis., which has just inaugurated motors in place of mules. The new cars are the latest of the St. Louis Car Company, and are mounted on McGuire trucks, and propelled by two W. P. 30 motors of the General Electric Company. There are nine motor cars and four trailers. The line covers eight miles, two and a-half being new. Rails are 50 pounds T, laid on cedar ties, two feet between centers. The officers under the new ownership are: President, Geo. D. Cook, of Chicago; Secretary and Treasurer, H. H. Welch; Superintendent, Geo. H. Shaw, who was formerly connected with the Chicago City Railway. At the time Mr. Shaw took charge of the road, it was giving a very poor service, which under his able management was improved until no farther improvement was possible with animal power. Now that electricity is at work the capital city of Wisconsin will have a service which is every way in keeping with the city of Madison.

A BILL is now pending in the Ohio legislature to compel street railway companies to put cabs on motor and grip cars. The bill has strong friends and enemies both among the companies and employees.

THE JEFFERSON STREET POWER HOUSE OF THE WEST CHICAGO.

THE Cable plant of the West Chicago Street Railroad Company, at the corner of Washington and Jefferson streets, has three times undergone enlargement. The last changes have just been completed, and the plant will soon be operating the "tunnel loop" as formerly.

The boilers are the same as used before, being six in number, of the horizontal return tubular type, dimensions 18 feet by 72 inches, rating 150 H. P. each.

The steam separators were made by Fraser & Chalmers under patents of Westinghouse Church, Kerr & Co. The company also continue the use of oil as a fuel and find it satisfactory. The new engines were built and erected by Fraser & Chalmers, Chicago, and have a five foot stroke with three foot

cylinders. These engines are among the finest in the city, and no pains have been spared to make them perfect in every way. Constructed as they were for this particular work, several special features were introduced to meet the severe requirements of cable operation. The cylinders are lagged with walnut, the working parts are all emery polished, and the remainder tastefully painted to harmonize. Altogether the two giants form a pair of twins which will attract many visitors during the World's Fair. To accommodate its expected guests the company have erected a commodious platform opening on Jefferson street, from

which point of vantage the whole plant can be seen to best advantage. Steam separators are placed over each engine, giving the engine dry steam and automatically returning the water to the boilers at a high temperature. The engines are fed by 10-inch overhead mains and the exhaust led to the Berryman heaters through 12-inch pipe below the floor. The two Corliss engines are rated at 1,200 each, but will develop much higher, and work directly on the engine shaft at the ends of which they are placed, and which is 20 feet long and 15 inches in diameter. From the engine shaft the power is transmitted by 24 3-inch cotton ropes. The driving pulley is 7 feet 6 inches in diameter and the driven 27 feet 6 inches. The engines run at about 60 revolutions a minute and the transmission drum shaft at about 14; this latter shaft is 12 inches diameter by 76 feet long. Engine fly wheels weigh 40 tons and are 20 feet in diameter and

of handsome design. The Walker segmental drums of 12 feet diameter are used, and through cut steel gears both are driven, and give the cable a speed of about seven miles an hour. The Walker drum is being adopted in all the plants of the company and gives a largely increased life to the ropes. The drums are heavily cast, and while the differential rims will last a long time, and can then be easily replaced, the drum proper will practically never wear out. The gears on the drum shaft are 120 inches in diameter, 98 teeth, 12 inch face, and 4 inch pitch. The intermediate gear is 53 inches diameter, with same face and pitch. They were made by Walker Manufacturing Company, Cleveland, Ohio.

At first sight these gears give the same impression that

would be produced by a light buggy wheel under a big victoria. But they are cut steel and the hardest steel tools make scarcely any impression upon them. While this class of work is highly expensive, it simply illustrates the care which extends to every part of the plant, in sparing no expense to secure a durable and reliable source of power.

This station will operate the present down town tunnel loop, and also the State street loop, as soon as that line is opened. The present loop cable is 10,475 feet long and was made by J. A. Roeblings Sons Company. The cable is capable of transmitting 2,500 horse-

power, diameter 1 5-16 inches. Several changes are thus necessitated in leading out the ropes, and the new work relating to the ropes has been directed by T. C. Nash, superintendent of cables. The plans for the location of the engines and heavy machinery and loop work downtown cable crossings, etc., and the responsibility of the installation, has of course, rested upon the company's chief engineer, S. Potis.

That it should so soon become necessary to re-equip the entire plant with power and winding machinery of more than double that originally installed, shows the wonderful increase in transportation which the West Chicago Street Railway has experienced, and General Manager Parsons may well take a just pride in his multitudinous duties to take a just pride in his new plant, in which nothing is wanting to make it one of the best appointed and arranged in the world.

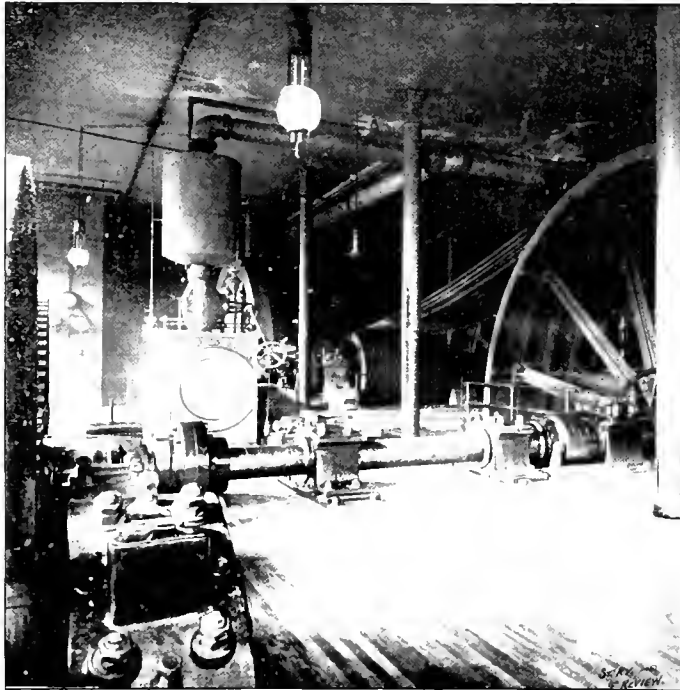

INTERIOR OF ENGINE ROOM JEFFERSON STREET POWER HOUSE.

THE NEW SECRETARY OF THE BROOKLYN CITY.

MANY surmises have been put to rest, perhaps bets settled, and not a few railway men surprised by the election of Washington A. H. Bogardus, of Chicago, as the successor of Wm. H. Thompson to the treasurership and secretaryship of the Brooklyn City Railway Company, of Brooklyn, N. Y.

An associated press dispatch dated January 11, brought the news to the STREET RAILWAY REVIEW, and on the following day Mr. Bogardus' portrait was in the engraver's hands.

A visit to the branch office of the Armour Packing Company found Mr. Bogardus as usual directing the



W. A. H. BOGARDUS.

large interests that report to him, and between orders to his army of clerks the STREET RAILWAY REVIEW gathered a few items of interest concerning his career.

Washington Augustus H. Bogardus was born thirty-four years ago, in New York city, of a good old New York family. His great grandfather was General Robert Bogardus. Here his education was attained in the excellent city and high schools.

His first business venture, however, was at Rome, in the same state, where he entered a private bank in 1877. Here in the banking and insurance business his first business experience was gained.

Three years later Mr. Bogardus came west and entered the counting room of Armour & Co. in the capacity of clerk. His native ability soon put him through nearly all the clerical parts of the work, and in one year Mr. Bogardus went on the road organizing branch houses, attending all the accounting of that portion of the business.

In 1890 Mr. Bogardus was put in charge of the branch

house business and became chief accountant of that large system. Besides these duties Mr. Bogardus is the disbursing auditor for the building department, and has charge of the taxes and assessments, leases, and the credits and collections of the refrigerator system.

In addition to his magnificent clerical and executive record, Mr. Bogardus has a good knowledge of steam engineering and electrical affairs.

Mr. Bogardus will take charge of his new position about February 1, and it is understood that Mr. Lewis will continue as chief executive. We bespeak for Mr. Bogardus a cordial welcome into the fraternity.

A TEMPORARY POWER HOUSE.

TO relieve the main power plant of River street, the Milwaukee Street Railway Company has recently erected on the South side a temporary plant, pending the completion of the Kinnickinnic permanent one.

The contracts for the station were let the first week in December, to be completed the first day of January, 1893. This was not an easy undertaking, when it is known that the steam plant consists of three simple Corliss engines, aggregating 1200 horse-power, and that the electrical equipment included three machines of 100, 150 and 200 kilowatts respectively, of the Edison bipolar type.

The E. P. Allis Company is responsible for the power installation, and the General Electric Company for the generators. The engines are belted direct to the dynamos.

The plant required the work of three gangs of men, working eight hours each, and the temporary connections alone consumed 14,000 feet of feeders, well strung, to connect with the underground feeder, and the necessary ground return was put in carefully.

A. W. Lynn, superintendent of repairs, is the director of the building and construction work, while the company's electrical engineer, L. T. Gibbs, is responsible for the electrical part of the plant.

THE MOVING SIDEWALK.

THE company which constructed the experimental multiple speed and traction sidewalk illustrated last year in this magazine will build a line of their structure one mile in length from the steamship landing to the grounds. The power will be furnished by the Intramural Railway. Some contracts have been already let, and some are still pending. Max Schmidt, the manager, has sold an option on the English right to build the structure to a London corporation.

THE Salt Lake City Street Railway Company has in the past year made improvements costing \$75,000, has added two new lines and has run 3,520 miles per day on the system.

ANOTHER victory has been scored for common sense progress and the trolley in the recent decision of the Pennsylvania Supreme Court.

ELECTRIC BLOCK SIGNALS FOR TURN-OUTS.

THE Pleasant Valley Company, of Allegheny, have considerable single track electric, and with a constantly decreasing headway, and the further complication of numerous curves where buildings obstructed the sight of motormen, an urgent necessity arose to either double track the line or devise some positive means of signals.

As the double track is at present impracticable, Electrical Superintendent W. M. Ramsey set about inventing the alternative—the signals.

This he has done in a manner which is proving very satisfactory, and which admits of almost unlimited variations in its adaptation to the varying circumstances of other roads.

There are some dozen or more of these block stations

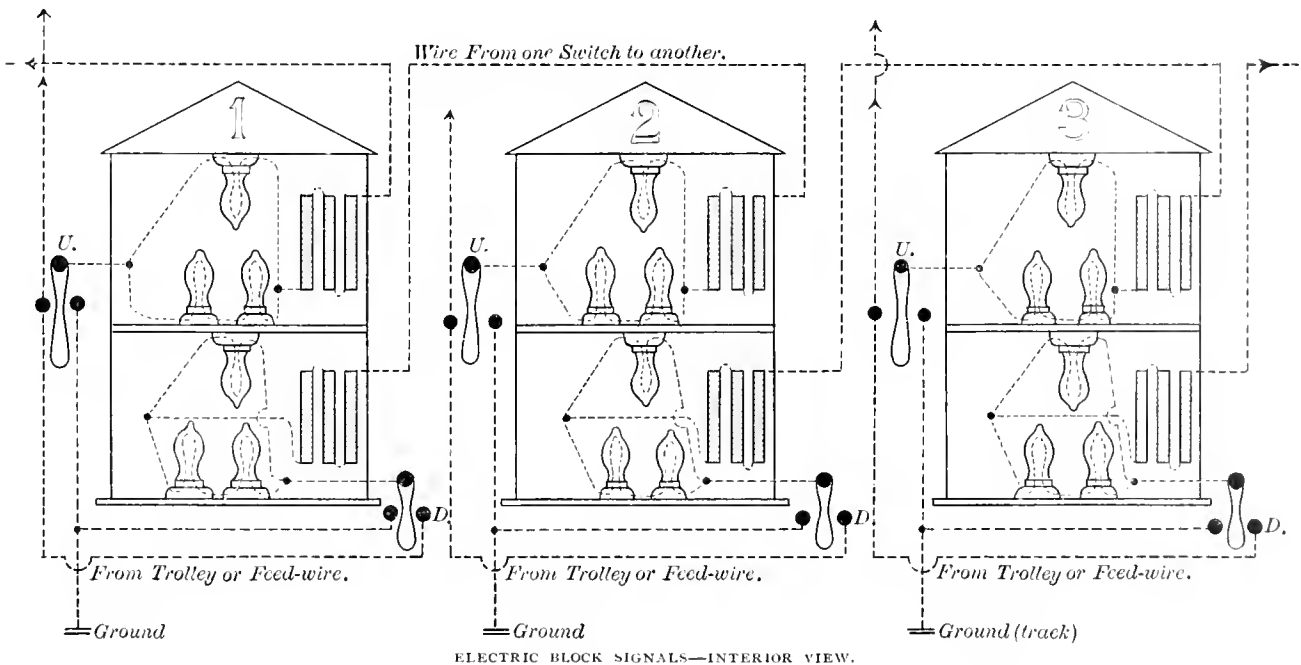

ELECTRIC BLOCK SIGNALS—INTERIOR VIEW.

on the line, but for descriptive purposes we take only three, as the rest are simply a repetition of the same system. The illustration readily explains the boxes, which are divided into upper and lower halves, each containing three lights. If desired different colored lamps may be used in the upper half, although Mr. Ramsey finds this unnecessary in his case.

The upper half of box No. 1 is connected with the lower half of box No. 2. The upper half of box No. 2 is connected with the lower half of box No. 3, and so on, so that conductor on car going up-hill looks at upper half of box. If the lights are burning, then he understands that another car is on the single track ahead of him—either on its way to the next switch, or approaching. If the car is on its way to the next switch, and too far ahead to allow him to follow on the same signal, then he must wait until that car arrives at next switch, and turns lamps out. He can then throw switch (small switch on upper

side of box) and if the lamps in upper half of box burn, he can go on to next switch. When he reaches next switch, box No. 2, he will find lamps burning in lower half of box (which he lighted when he left box No. 1). He must then turn them out, using switch on lower side of box. Then if lamps are not burning in upper half of box, he can turn them on as before, using upper lamp switch, and turning them out when he arrives at next switch, box No. 3, by using lower lamp switch. This process is repeated until the up end of the line is reached. The same order, only reversed, is followed in making the return, down trip, and conductor moves his car only when light are not burning in lower half of box. The whole is summarized in the two rules which Mr. Ramsey finds sufficient, and which read as follows:

RULE 1. Cars going UP-HILL are blocked by lamps burning in UPPER half of box. They can block cars at UPPER switch by turning switch on UP-HILL side of box; this makes lamps burn in lower half of box at next switch, and must be turned out when car reaches it

by using switch on DOWN-HILL side of box.

RULE 2. Cars going DOWN-HILL are blocked by lamps burning in LOWER half of box. They can block cars at LOWER switch by turning switch on DOWN-HILL side of box. This makes lamps burn in upper half of box at next switch, and must be turned out when car reaches it by using switch on UP-HILL side of box.

The system is really quite simple; in fact, much more so to operate than to describe. The men readily caught the scheme, and the result has been regularity in running, where formerly a run back to turnout was of more than hourly occurrence.

It is reported that ex-Mayor Grant, of New York, will engage in the street car advertising business.

It is officially denied that the Rhomberg lines at Du-buque have been sold, or offered for sale.

THE DETROIT ELECTRICAL WORKS sent out a very handsome calendar.

PROGRESS TO DATE OF THE LOVE ELECTRIC CONDUIT SYSTEM.

THE temporary excitement attending the opening of the Love electric conduit system on the Fullerton avenue loop of the North Chicago Railway Company, which occurred March 12, 1892, has assuaged considerably. As a matter of fact, the line has frequently suspended operations, and for several weeks before Christmas the patient horse betook himself around the curve as of yore. A visit to the scene of operations about November 15, revealed this state of affairs, and a call at the

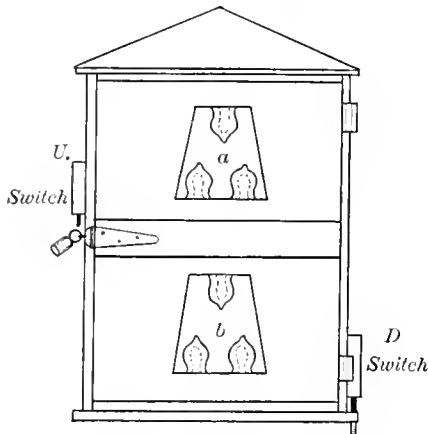

ELECTRIC BLOCK SIGNAL—EXTERIOR.

power house and conversation with the engineer elicited the information that "the company was overhauling the construction," although no signs of the said overhauling were visible. The engineer stated that the usual 500 volts and from fifteen to twenty amperes were required to operate one car by the underground system.

A. G. Wheeler, manager of the Love Company, is now at Washington City for the purpose of constructing a similar line, the greatest progress in which is along U street. It will be but a few blocks in length, but "if the directors are satisfied with the undertaking it will be extended several miles." Parenthetically it may be stated that this is evidence that the system is still in an experimental stage. Among other difficulties encountered by Mr. Wheeler is the crossing of the cable conduit. This he promises he can do.

For the past two weeks the Chicago line has again been "lovely," although during each of two visits of a REVIEW man to the scene of action the car became disabled, and had to be pushed by the Connelly motor. The results of numerous burn-outs were also recorded on the charred switch board.

An old man from the Wisconsin woods recently wandered into the capital of that commonwealth. Becoming weary he leaned up against an iron street railway post and, with hat in hand, pressed his ear against a mail box, listening to the buz. After a few minutes evidently satisfied he turned away and remarked, eyeing the mail box approvingly. "Thar, now, I hev heard a telephone talk at last."

STREET RAILWAY PATENTS.

Selected list of patents relating to Street Railway Inventions, granted during the past thirty days, reported especially for the STREET RAILWAY REVIEW, by Munn & Co., Patent Attorneys, 361 Broadway, New York, N. Y.

ISSUE OF DECEMBER 13, 1892.

Fare Register, J. W. Fowler, Brooklyn, N. Y.....	487,731
Conduit for Electric Railways, J. W. Hayden, Fort Wayne, Ind.....	488,735
Means for Transmitting Power, W. E. Walsh, San Francisco, Cal.....	487,805
Trolley Catcher, J. Werling and J. F. Agnew, Minneapolis, Minn.....	487,808
Electric Railway Trolley, A. Warner, Buda Pesh, Austria, Hungary.....	487,813
Electric Railway Trolley, D. Mason, New York, N. Y.....	488,022
Tramway Switch, J. H. Reinhardt, Newark, N. J.....	488,132
Elevated Railway, E. M. Turner, St. Louis, Mo.....	488,154
Elevated Railway, E. M. Turner, St. Louis, Mo.....	488,155
Elevated Railway, E. M. Turner, St. Louis, Mo.....	488,156
Double Track Elevated Railway, E. M. Turner, St. Louis, Mo.....	488,157

ISSUE OF DECEMBER 20, 1892.

Trolley Stand for Electric Cars, E. M. Bently, Boston, Mass.....	488,170
Cable Crossing, W. Bowers, New York, N. Y.....	488,262
Street Railway Switch, W. E. Brown, Milawana, Pa., and L. H. Smith, Elmira, N. Y.....	488,263
Street Car Fender, G. T. Hall, Monrovia, Cal.....	488,286
Elevated Railway Structure, J. L. Meigs, Boston, Mass.....	488,283
Closed Conduit for Electric Railways, R. A. Dion, Natick, Mass.....	488,351
Fender for Cars, H. A. Gamage and W. N. Schmidt, Boston, Mass.....	488,353
Car Fender, S. I. Crafts, Boston, Mass.....	488,376
Sand Box for Cars, S. Cory, Cambridge, Mass.....	488,387
Means for Operating Station Indicators, R. B. Ayres, New York, N. Y.....	488,415
Propelling Gear for Tramway Locomotives, C. D. Scott, Sanford, Pa.....	488,484

ISSUE OF DECEMBER 27, 1892.

Tramway Switch, W. G. Carmell, Columbus, Ohio.....	488,599
Trolley Catcher, W. L. Brown, Worcester, Mass.....	488,706
Tram Car Door, John Stephenson, New York, N. Y.....	488,722
Closed Conduit for Electric Railways, F. Mansfield, New York, N. Y.....	488,835
Trolley Wheel, L. J. Hirt, Arlington, Mass.....	488,811
Electric Railway Trolley, C. J. Van Depoele, Lynn, Mass.....	488,929
Electric Locomotive, C. J. Van Depoele, Lynn, Mass.....	488,930

ISSUE OF JANUARY 3, 1893.

Trolley Wire Support, G. H. Scranton and L. Spillman, Columbus, O.....	489,097
Rail Cleaner for Railway and Tramway Rails, H. Conradi, London, England.....	489,120
Car Fender, G. F. Toppliff, Boston, Mass.....	489,134
Automatic Switch for Trolley Tracks, W. H. Brodie, Brooklyn, N. Y.....	489,189
Fender for Electric or other Cars, M. S. Starkweather, Boston, Mass.....	489,207
Electric Railway Trolley, J. Reutlinger, St. Louis, Mo.....	489,234
Electric Elevated Railway, A. L. Rutter, Washington, D. C.....	489,330
Underground Conduit for Electric Railway, C. P. Tatro, Spokane, Wash.....	489,422

A GENTLEMAN, evidently from darkest Indiana, recently boarded a Calumet electric for the purpose of transportation and investigation. The thing that interested him most was the fare register, which he studied intently. Finally his curiosity got the better of his bashfulness and he asked the conductor, "Say, mister, how does that tarnal thing let your boss know it every time you take in a nickel? I've watched it a long time and I vum I can't see!"

LONG DISTANCE ELECTRIC RAILWAY.

LONG distance and high speed electric railways are constantly attracting more attention, not only from electricians but capitalists. Numerous lines are in daily operation, and have been for months past where a speed of 30 miles an hour is obtained with the ordinary motors, an ordinary track and with the usual voltage. On some of these lines current is transmitted direct for a distance of 15 miles from the power station. As we have had occasion to mention almost every month, the number and length of these interurban roads presents the most attractive field for future operations in electric railway work. Among the longer projected lines in this country is one to connect Galveston and Houston, a distance of 50 miles; one to extend 60 miles from Sandusky, Ohio, another between New York and Hartford, and still another to connect Chicago and Milwaukee, which latter is being kept very quiet, but when the first move

appear from time to time in their printed announcements of plans under way, or accounts of the progress of the work. It is now stated, however, that pending negotiations are well along toward settlement by which the entire bond issue will be taken in New York and Boston, although the buyers do not desire their names given out until the deal is closed. The preliminary survey was made several months ago and the topographical map reveals a line with practically no difficulties. The grades are all slight, and the only bridge of any consequence is the one over the Kankakee river, and that only 1,100 feet



C. E. BLEYER.



DR. ADAMS AND HIS DAUGHTER ALICE, THE FIRST "WORKMAN".

is made matters will be pushed to completion in short order. But by far the longest ever projected, and the one which is attracting universal attention, not only in this country but abroad, is the Chicago & St. Louis Electric Railway, which promises a speed of 100 miles an hour between this city and the settlement at the other end of the big bridge. The company have two general offices, one in St. Louis and the other in the Temple Building in this city, which latter is in charge of Charles E. Bleyer, assistant general manager, a most pleasant gentleman whose business interests are extensive in both St. Louis and Chicago, and who is a man of large executive ability.

The affairs of the road are closely managed and very little inside information reaches the public. The managers are cautious and make few statements other than

in length. Grade crossings are to be wholly avoided by elevating the tracks over roads and other railroads.

Work on the roadway was commenced October 6, at Edinburg, Ill., and at this writing some 24 miles have been graded. We are also informed, contracts for the entire balance of the line have been let and will be pushed as fast as the weather will permit, with hopes of completion by next fall, although the management hope to have a 50 mile section in working order before the closing of the Fair. While there are some who question the ability to make the speed named, the public and press generally throughout the country confidently expect it can be done even though they do not understand the details.

Electricians of high standing concede the possibility of 100 miles an hour, but have heretofore maintained that

the same work could be performed much cheaper by steam locomotives. This the managers of the electric

tion can be made economical, we are not prepared to say, as a demonstration will be the best evidence. The com-

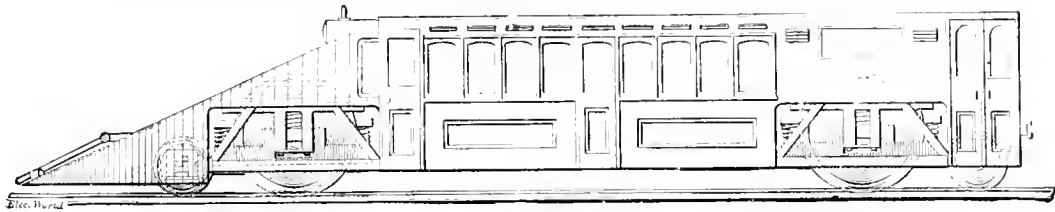

HIGH SPEED ELECTRIC CAR

road state they will overcome by using for fuel the slack from mines which they either own or control, which slack

pany's engineer states the coal properties already secured should suffice to operate the road for something like a

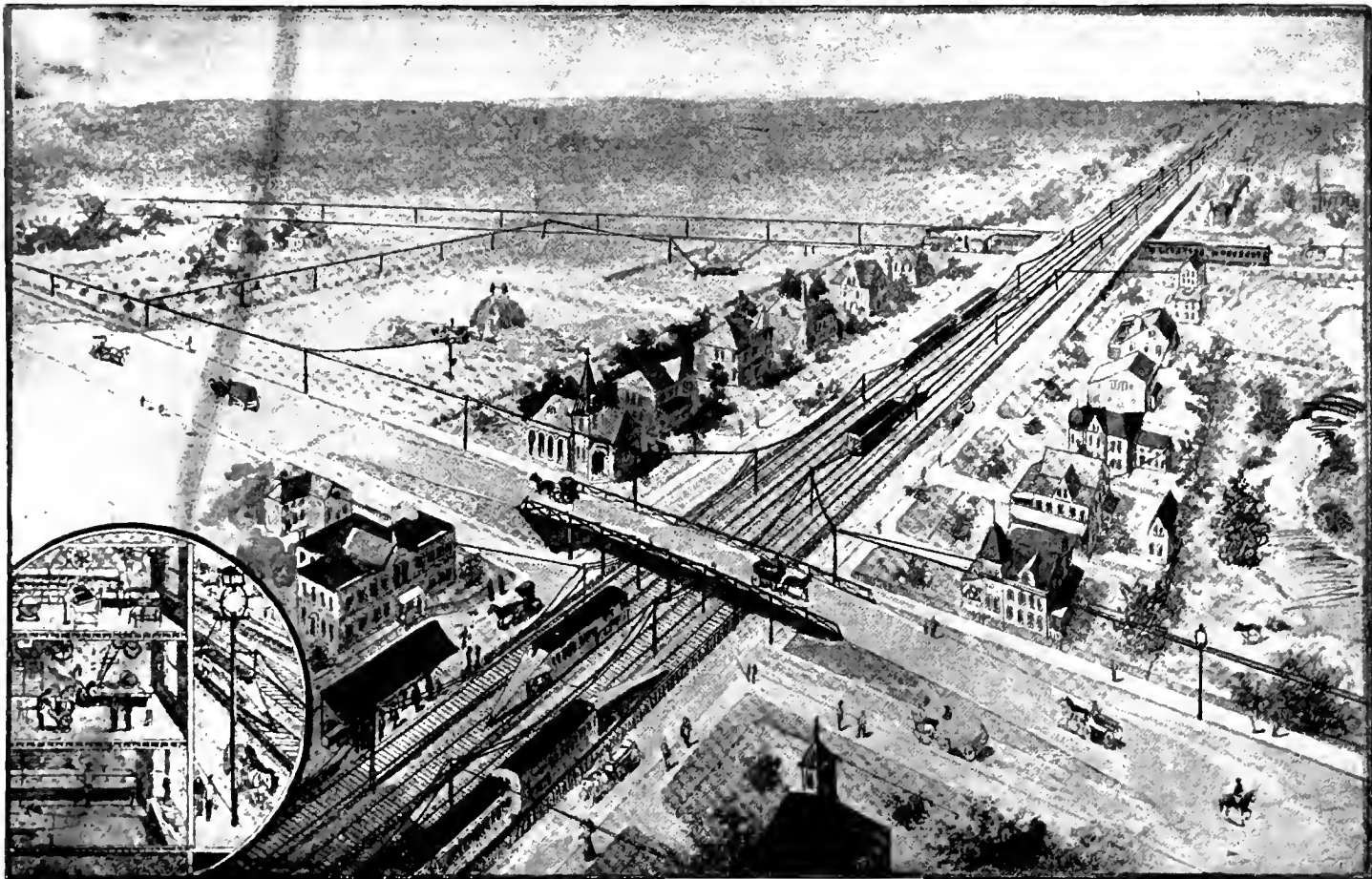

PROSPECTIVE BIRD'S EYE VIEW OF ROAD,

burned at the mine costs only 17 cents a ton, and is ordinarily unmarketable. Whether at this figure the opera-

century. Power station No. 1 is allotted Edinburg, and plans are being made for a second, in Livingston county,



THE POWER STATION AT EDINBURG, ILL.

near Fairbury, while a third is mentioned for Bloomington, and possibly one at Clinton. The farmers along the line are much enthused, and no small amount of real estate speculation has arisen in anticipation of what the road will do.

One of the most noticeable instances of this may be seen at Alpine Heights, just 23 miles from Chicago and situated near the line of the road. This fact alone has been sufficient to create a perfect boom in this beautiful county suburb, and prices are advancing rapidly and transfers being made at constantly increasing prices.

The company will in all probability adopt the Moffett Journal bearing for their motors.

Dr. Adams, president of the road, expects the first motor, which is being built in Germany, will reach here about March 1. The track is to be standard gauge, rock-ballasted and laid with 72-pound steel rails, and its progress will be watched with great interest.

"ZE GREAT CHRISTOPHER COLUMBO."

A WHALEBACK steamer is not exactly a street car, but the one shown in the engraving is to ply on one of the great thoroughfares between the heart of Chicago and the World's Fair. We are indebted to the Marine Review for the illustration of what will be the first whaleback used in passenger service. It is intended to run between Van Buren street and the Fair. This vessel is made entirely of steel, being 362 feet in length over all, 42 feet beam and 24 feet deep. The hull is of the same shape as that used on freight boats, but carries a water ballast of 730 tons in her double bottom. Engines are triple expansion, intended to develop 3,000 horse power. The passenger accommodations are all in the superstructure, which is supported by nine turrets in the center, and by ventilator tubes around the outside. The turrets are occupied by stairways, engine-rooms and



THE GREAT WHALE BACK PASSENGER STEAMSHIP, CHRISTOPHER COLUMBUS.

PHILADELPHIA'S TROLLEY.

In the cases, known as the "trolley cases," or "the citizens' committee against the traction company" in the Court of Common Pleas No. 4, the review of the Supreme bench gives a sweeping victory for the corporation. The decision handed down by Justice Mitchell makes it dependent entirely upon questions of law of the greatest local and State interest.

GARSON MYERS, president of the Standard Railway Equipment company, is meeting with splendid success with his car heaters. Among a multitude of complimentary letters we select the following from J. S. Ticknor, manager of the West End road, Rockford, Ill., who writes under date of January 6, 1893, as follows: "We have been using eight of the 'Standard' Stoves, bought of you last November, in our cars, and though we at first had serious doubts of their efficiency in very cold weather, and hence did not feel justified in giving them our endorsement, we can now, after having experienced the coldest weather in this locality for the last six years, speak in unqualified praise of these stoves. During our coldest weather the cars have been as comfortable as one could wish and have occasioned numerous compliments from our patrons. Another winter we expect to equip all our cars with the 'Standard' Stoves."

stacks. It will be seen that there are two decks. Dining rooms are in the middle of the lower deck. On the saloon deck the grand saloon is 225 feet long and 30 feet wide. The top of the saloon is a promenade 257 feet long. The whole vessel will be heated by steam and lit with electricity. Carrying capacity is about 5000 persons, and the run of seven miles will be made in thirty minutes. It is designed for excursion traffic, and consequently staterooms are omitted. The appointments are among the best. A large fountain will play in the center of the grand cabin.

THE first number of the World's Fair Electrical Engineering, of which Fred DeLand is editor, has made its appearance, and is a very readable and attractive issue. Mr. DeLands' well known ability as a writer has ample scope in his new magazine, which starts out with bright prospects.

A MAN who knows, says that Grand Rapids, Mich., would be a first-class point for building street cars. Carriages and wagons are built there, the shipping facilities are good and power is cheap. The street railway has a machine-shop and paint-shop in operation there.

E. A. LANG, general manager of the Consolidated lines, Toledo, was a welcome caller January 12th.

INTRAMURAL RAILWAY AT THE WORLD'S FAIR GROUNDS.

OUR readers will no doubt remember the article published on this subject in the STREET RAILWAY REVIEW for July. This article brought the first details of the work to the public eye and the present supplement gives the first detailed account of the remainder of the construction.

Referring to our engraving of the elevated structure, accompanying this article, the graceful outline and the light but strong construction of the road bed may be seen. The post foundations are concrete, 7x7 feet and 12 inches thick. The grades are slight, running from .5 to 2 per cent. and the curves vary from 100 to 200 feet radius. The radii of terminal loops are 100 feet. The length of the line is three and six tenths miles.

It starts with a loop near the Fisheries Building, running north to the boundary of the grounds, thence west

tasteful superstructure the contract for which was taken by Remington & Co., Chicago.

The Illinois steel company has the contract for the 60 pound-rail that is to be laid. The current will be conveyed to the car by an under running trolley wheel, running upon 60-pound steel T rails. A portion of the way this rail will be supplemented by two others of equal size in order to give sufficient carrying capacity. The I beams of the structure and the rails upon which cars run will form the return current. The motors will be controlled by the series parallel controller which is now being put into extended use by the General Electric Company. The cars will be equipped with four 50-horse-power Thomson-Houston motors capable of exerting a maximum capacity of 100-horse-power each, making the total capacity of each motor car 400-horse-power.



ELEVATED STRUCTURE; POWER HOUSE UNDER CONSTRUCTION.

and south just inside of the enclosing fence to a point near the Transportation Annex. Then runs over the roof of the Transportation Annex in a southeasterly direction, being supported upon posts built into the Transportation Building. From the Transportation Building it runs south to a point near the Machinery Hall, then makes a loop to the west around the west end of this building, thence runs due east to a point between the Colonnade and the Agricultural Building, where it turns and runs in a southeasterly direction toward the south end of the Forestry Building. Here it turns north and runs up to the lagoon near the east side of the Agricultural Building. At this point there is a loop upon which the trains turn and proceed back over the route above outlined. The road connects with the Barre sliding railway, with the Alley L and with the moveable sidewalk. Its introduction is one of the greatest conveniences on the grounds and will be appreciated by millions of passengers during the Exposition. To C. P. Matlack, engineer in chief, belongs the honor of the

There will be along the line eleven stations for passengers and sufficient transfer stations.

THE POWER STATION

is situated near the Forestry building. It is of staff, with a brick back wall for the furnace and smoke-stack. The latter is shown in our engraving, as well as the batteries of Babcock-Wilcox boilers, aggregating 5,000 horse-power.

This station, an elevation of which is also shown, is the product of the experience and talent of Bion J. Arnold, the consulting engineer. This work, which is of the most difficult character, as it involves the building of a temporary plant to do work that would test a permanent power house, bids fair to be as successful as Mr. Arnold's previous plants at Little Rock, St. Joe, Mich., and elsewhere have been. We call particular attention also to the longitudinal section of the power house.

The engine room is 140 feet long by 87 feet wide.

The boiler room is 140 feet long by 60 feet wide. The building is of frame construction, with the exception of the rear wall of the boiler room, which is of brick, as above stated. The entire building is covered with stuff outside and in, this making it cheap to construct. The trusses are of wood, and support the corrugated iron roof. The roof of the boiler room consists of common gravel roof, with tarred paper between the sheathing and the gravel. The building is so designed that all windows used in it are of standard size used for ordinary house building, so that considerable money can be realized from the sale of them after the Exposition is over. This idea has been conformed to by the designer of this station all through, and it will be noticed that heavy timbers are used in almost

severe tests that will be put upon it when the road goes into operation. To have built these foundations with piling in the ordinary manner would have cost double the money that the present work calls for, and it was thought best to depend upon concrete foundations.

The water for the plant is secured from the lake, which is about 300 feet from power-house, through an 18-inch vitrified sewer pipe and flows to the power-house by gravity. The condenser pumps take the water from this pipe, force it through the condensers and lift it high enough to give a sufficient head for the water to flow back into the lake through another vitrified sewer pipe. It will thus be noticed that all the energy that is required of the air pumps is to lift the water about 6 feet, as the

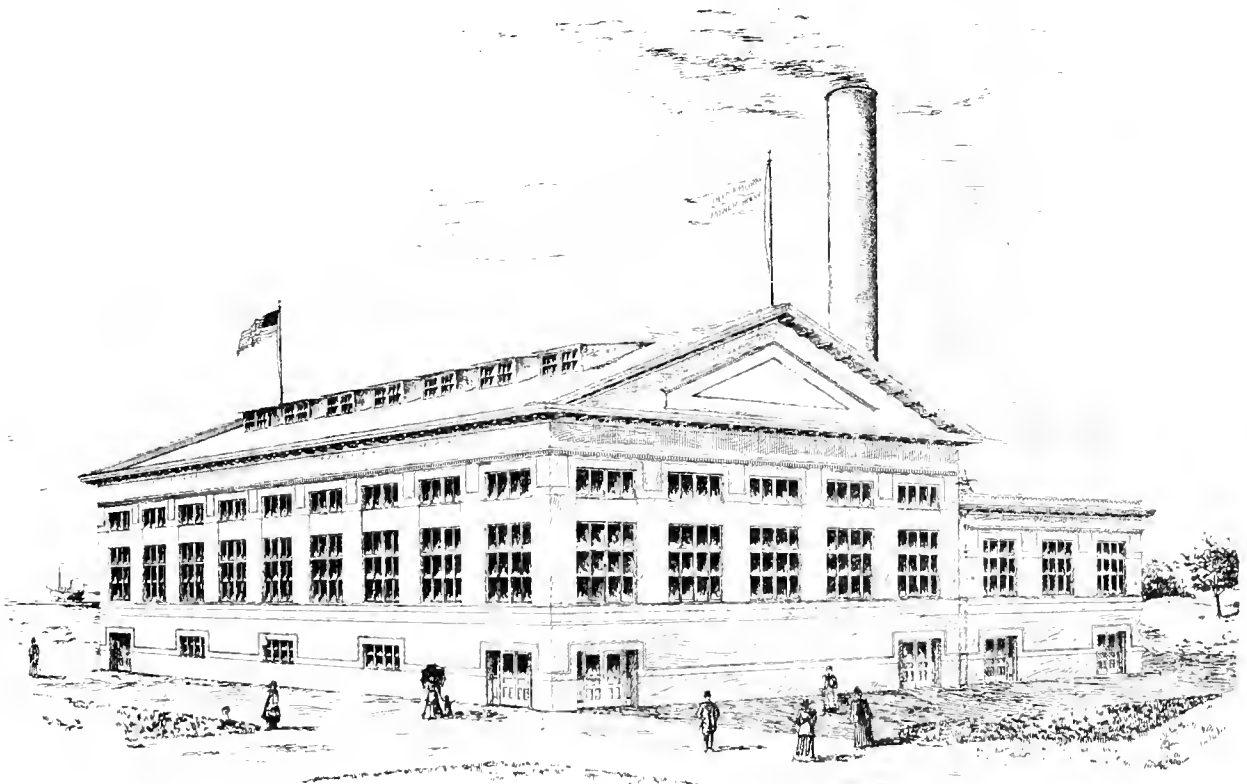

THE POWER HOUSE.

all cases, and that little cutting has been necessary, thus making the timber after the building has been torn down almost as good as new.

The extraordinary weight of the machinery to be placed in this building makes the matter of foundations quite an important subject, especially so when it is known that the station stands on running sand, which is almost as bad as quick sand. It will be noticed from the drawings that the earth is excavated to a point about three feet below the surface, which is below frost line. Over this is a temporary grillage work, consisting of two layers of 4x12 inch plank, placed at right angles to each other, and thoroughly spiked together. Upon this mass of timber was built one solid concrete stone, 140 feet long by 60 feet wide and 3 feet thick, made of Portland cement and sand. Upon this stone was built the engine and condenser foundations, and it is believed that it will stand the

water flows to and from the power-station by gravity. In the center of the engine-room will be noticed a 2,000 horse-power Reynolds-Corliss cross compound condensing engine, built by the Edward P. Allis Company, of Milwaukee, Wisconsin, coupled direct to a 1,500 kilowatt Thomson-Houston multipolar railway generator. At one end of the building is a 750 horse-power Reynolds cross compound engine coupled direct to a 500 kilowatt Thomson-Houston multipolar generator with an over-hung armature. It will be noticed that this generator is so built that the field can be moved off from over the armature by means of screws and hand wheels, thereby permitting easy access to the armature or fields for repairs. Midway between this engine and the main engine is located a 750 horse-power Hammond-Williams compound condensing, vertical engine, coupled direct to a 500 kilowatt Thomson-Houston multipolar generator. This generator is of the

same design as the one attached to the Allis tandem engine, except that it is provided with an out-board bearing for the armature. At the other end of the engine-room is located a 750 horse-power tandem cross compound condensing Greene engine built by the Providence Steam Engine Company, of Providence, R. I., coupled direct to a multipolar 500 Thomson-Houston generator, with a tightener on the slack side of the belt furnished by the Eclipse Clutch Works, of Beloit, Wisconsin. Between the Greene engine and the large engine, located in the center of the building, is placed a 400 horse-power tandem compound condensing engine built by the McIntosh & Seymour Company, of Albany, N. Y., coupled direct to a multipolar 200 kilowatt Thomson-Houston generator.

In the rear of the engine-room stand the condensers and boiler feed pumps for the entire plant, and it will be noticed that the engine-room floor is left open and a railing provided around the opening, thereby making a gallery for spectators to view the machinery below. In this condenser pit will be located two Allis vertical fly-wheel condensers, which are to work in connection with their engines. To the Williams engine there will be attached a fly-wheel condenser built by the Conover Manufacturing Company, of New York. To the McIntosh & Seymour engine will be attached a single acting condenser built by the Deane Steam Pump Company, of Holyoke, Mass. The Greene engine will be attached to a duplex condenser, manufactured by Henry R. Wortbington, of New York. The feed water for the boilers will be supplied by a triplex pump built by the Gould Manufacturing Company, of New York, and a duplex steam pump built by the Smith-Vaile Company, of Dayton, O. These boiler feed pumps will be arranged to take the water directly from the lake and the hot water wells of the condensers as occasion demands. They will also be attached to a system of fire service pipes running throughout the building and car barns of the company, located a short distance from the power house, so that these pumps will not only act as boiler feeders but will be on hand for fire service at all times.

LONGITUDINAL SECTION OF POWER STATION.

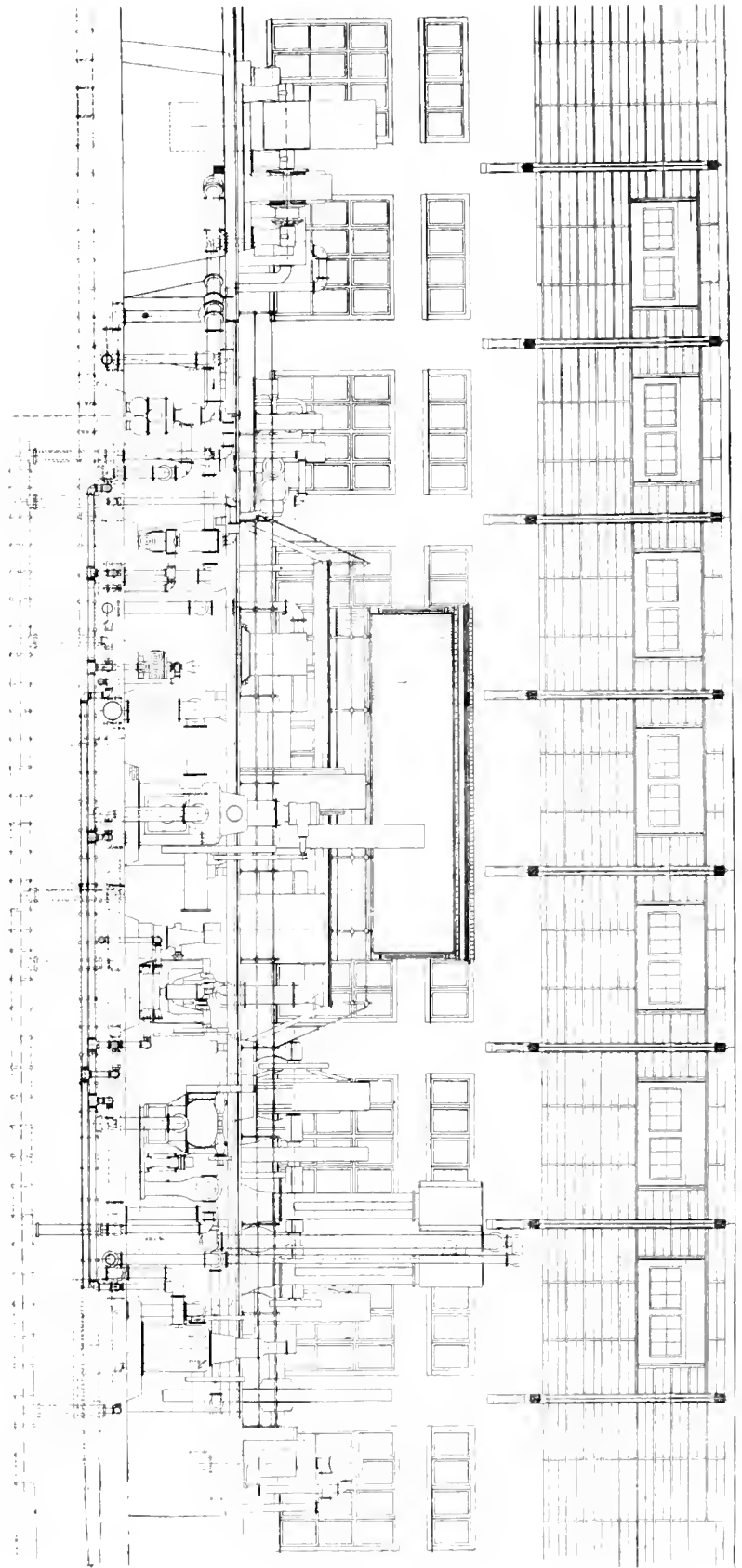

They will also supply hot water for washing the cars in the car barns.

It will be noticed that the condensing machinery is all steam driven and that each engine is provided with an independent condenser. The valves for handling the condensers and engines will be controlled by wheels located near the engines, so that the engineers can start the machinery without changing their positions to any great extent. In the boiler room will be located ten 300-horse-power Babcock & Wilcox water tube boilers, having a total maximum capacity of 5,000 horse-power, as occasion demands. In the rear of these boilers will be built brick smoke flues, and on the outside of the building will be placed two batteries of Greene's fuel economizers built by the Fuel Economizer Company of Mattewan, N. Y. The feed water will be taken from the hot wells of the condensers forced by the boiler feed pumps through these economizers, then to the boiler. The hot gases from the boilers will pass through the economizers on their way to the stack, thus heating the feed water to a high temperature before entering the boilers.

It will be seen that the piping for the plant is all independent of the building. A main header connects all the boilers from which leads three large steam pipes down beneath the boiler room floor to the engines, branches being taken off at proper points to supply the different condensers and pumps. An automatic pump and drainage tank is located below the lowest point of any of the pipe work and takes care of all water condensation. This pump will force the drainage water back into the boilers, thus doing away with all the traps and waste water in the plant. The boilers will be supplied with oil burning apparatus and will secure their supply of oil from the tanks of the World's Columbian Exposition Company, located about 300 feet distant from the power-house. The oil burning plant will be installed by the National Supply Company, of Chicago, while it is expected that a variety of oil burners will be used in the plant, endeavoring thereby to ascertain the real economy of the different burners now on the market.

The switch board of this plant will be located on a half story above the engines, which will permit the electrical operator, who will be located on the switch board platform, at all times to have complete supervision of all the machinery and electrical apparatus in the plant. The feeder wires will be laid from the power station to the elevated structure in an under ground conduit, provided with the necessary drainage and means for access.

The trains, 18 in number, will be run on a 1½ minute headway or 40 per hour, giving a capacity of 15,000 people per hour. The cars are built by Jackson & Sharp Co., of Wilmington, Del. A ten-cent fare will be charged.

The personnel of the staff is: W. E. Baker, general manager; R. I. Sloan, consulting engineer of the elevated structure; B. J. Arnold, consulting engineer; C. P. Matlack, engineer in chief; C. H. Macloskie, chief electrician, and G. K. Wheeler consulting electrical engineer.

The contractors of the work are as follows: Remington & Co., Chicago, the elevated structure and car barn; McArthur Bros., Chicago, Power station building; Cassidy & Victor, Cincinnati, Ohio, foundations; William E. Dee, Chicago, sewer work; Crane Company, Chicago, pipe work; J. H. Mathews, Harvey, Ill., smoke stack.

JOHN A. COYLE.

THE first president of the Pennsylvania Street Railway Association, formed December 28, 1892, is John A. Coyle, of Lancaster, who has also been president of the Lancaster City and West End Street Railway Company since its consolidation.

Mr. Coyle comes of a good Irish family on his father's side of the house, while his mother belonged to one of the oldest of the Pennsylvania German stock. With this heredity of Irish quickness and sagacity and German prudence John Coyle was born April 23, 1858, in Lancaster. After a preliminary education in the excellent city schools of Lancaster, young Coyle entered the famous institution known as Seton Hall, of which the presiding genius was bishop, now arch bishop Corrigan. From this school he was graduated in 1877 with high honors, and having chosen the law as his profession, entered the office of William Aug. Atlee, and was admitted to the bar in 1880. He was at once favored with a large practice and was known as the rising attorney among the younger men with a clientele that an old practitioner might envy.

Although Mr. Coyle's first care is his profession, like all men of his ability, he finds time for many public affairs. He is one of the owners of the Freie Presse and the Lanterrie, two German newspapers, is a trustee of St. Mary's Orphan Asylum, St. Mary's Cemetery, several benevolent organizations, and last but not least, guides the destinies of the Consolidated railways of Lancaster.

In 1890 the first consolidation of the Lancaster roads was made, followed in January of the next year by a consolidation of the Millersville line, practically making the roads one.

Mr. Coyle was a firm believer in electric equipment and was one of the main supporters of a then unpopular idea. His predictions have been wonderfully fulfilled, however, since in the last "horse-year" 183,000 passengers were carried, against 426,000 for the first electric's year, and for the last year 1,249,250.

Through Mr. Coyle's efforts various pleasure resorts have been placed on the line, notably Potts' park on the east, Engleside on the south and the beautiful park of Little Conestoga, whither concerts and amusements draw the crowds.

Mr. Coyle's intimate connections with rapid transit, by knowledge of its needs and legislative wants as well as his wide experience in human affairs, makes his choice as president of the Pennsylvania State Association one of particular suitability.

Personally Mr. Coyle is of that magnetic influence that belongs to men of strong natures and of a suavity that marks the men of affairs and of the world.



JOHN A. COYLE,

Lancaster.

President Pennsylvania Street Railway Association.



MONTREAL'S STREET RAILWAY SYSTEM.

OVER three hundred years ago, to-wit, about this time of year, Anno Domini, 1535, Jacques Cartier, captain of the ships of Francis I, most Christian emperor, first landed in Montreal. It was rather greed than glory that caused Francis to send Cartier to the New World, for, if history says aright, his most Christian majesty swore a most wicked swear saying, "I would fain see the clause in Adam's will that bequeaths all that vast heritage to my brothers of Spain and Portugal." However that may be, brave Captain Cartier found the great Gulf of St. Lawrence and came on to the village of Hochelega. The captain very properly took possession of all he saw in the name of the

Its peculiar population, where the Scotch Presbyterian jostles the Jesuit, with convent walls abutting factories and French barristers in English courts, makes it of the deepest interest to the scholar and the politician.

Rapidly increasing in population, with a large traffic, both by land and sea, with progressive men and a restless competitor across the boundary line, the future of Montreal is assured. In 1760 its population was 3,000; in 1850, 57,700; in 1870, 179,000 and in 1890, 217,000.

It was in November, 1861, that the first street car was pronounced *tres bon* by the inhabitants of the city of Montreal.

The line was a short one, operated by horses and



CAR HOUSE—MONTREAL STREET RAILWAY.

king, and named the beautiful eminence near the town, Mount Royal, and the settlement at its base, in later days became to the hybrid tongues, Montreal.

With Cartier and the French priests came the French people, of whom great numbers still live in the surrounding country, speaking their own tongue, so that street car conductors and policemen must know both languages. Canada was ceded to the English in 1763, and Montreal became the stronghold of the English power.

Since 1840 radical and swift changes have come to Montreal, and the beautiful city has become modernized, and to-day is one of the best cities on the continent and the center of commercial Canada, with banks, churches, architecture, colleges, schools, railroads, bridges and improvements becoming our century and our country.

using sleighs in winter. It was known as the Montreal Street Railway Company. This name has never been changed through all its vicissitudes, although the ownership has frequently changed.

The present management is composed of R. B. Angus, L. J. Forget, G. C. Cunningham, K. W. Blackwell and H. A. Everett. These gentlemen bought out the Jesse Joseph syndicate, which held the reins of power until the present management took charge.

The road until the present year was of no particular interest, except a very large horse line of about 50 miles, which used sleighs every winter at a deficit and had stormy directors' meetings to inquire at regular intervals as to the this-thusness of things.

However, after months of patient work, and after many

battles with recalcitrant old fogies, and aldermen seeking a reputation among their constituents, a change took place. This transmogrification was born with the street railway concession of July 19, 1892, allowing the Montreal Street Railway Company to use the overhead electric system, known to fame as the trolley. The contract is to run 30 years, and, under the conditions named, it was necessary to have in operation a large portion of the system. The honor of the victory for the new system belongs to W. McKenzie, the energetic president of the Toronto street railway system, and James Ross, connected with McKenzie as the contractor for the system, and H. A. Everett, so widely known in the States for his street railway management.

Mr. Ross was president from the beginning of the management, but finding that he could better further the interests of the company by giving more of his time to the construction, he resigned on October 5, when L. J. Forget succeeded him. Mr. Forget has been long and favorably known in connection with the Montreal Street Railway, and is a firm friend of rapid transit.

The managing director is H. A. Everett, above mentioned, who has so well applied his large experience and extensive knowledge of street railway work.

The tabulation is as follows, and is too remarkable not to claim a full share of the attention of street railway men:

	1891	1892	Increase in '92
Aug.	990,740	1,427,308	436,628
Sept.	1,121,999	1,627,769	505,770
Oct.	902,824	1,430,190	537,366

Total increase

1,479,764

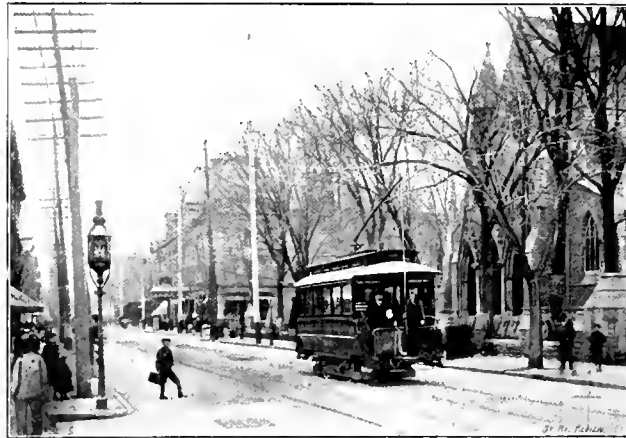

ST. CATHERINES STREET—LOOKING EAST.

This has been accomplished with but part of the line equipped with the new agent.

At present, 47 miles of track are traversed by Montreal cars with one-third of the mileage electrically equipped.

The engineer of the road is Granville C. Cunningham, M. I. C. E., late city engineer. He has found nearly all the rail in the city too light, and the new 70-pound girder and 45-pound tram rail is rapidly replacing the strap whereon the horse car was wont to

glide. The new rail is made by Dick, Kerr & Co.

The rolling stock consists of 200 cars made by various manufacturers, both Canadian and American. The American cars are principally from the shops of John Stephenson and the Newburyport Car Company, while the Canadians are represented by Crossen and the La Riviere works near Quebec. The Canadian cars are very fair



STABLES, WITH REPAIR SHOP TO THE LEFT—MONTREAL STREET RAILWAY.

On November 2, the annual report of the stockholders showed a remarkable increase over previous years which is principally attributable to the influence of electric traction in the three months previous to the report. The net profits for the year ending September 30 was \$93,880.21, as against \$60,261.77 of the previous year. Out of that amount two dividends of 4 per cent, amounting to \$71,000, having been declared.

The reports of the three months of August, September and October show an increased patronage of 1,479,764,

representatives of the art. The cars are 16, 18 and 20 feet in length. They are mounted on trucks from the well known factories of Brill, Bemis and the Fulton foundry. The wheels are made by the Buffalo Car Wheel Company.

The cars are equipped with two motors each. The motors are divided among the Royal Electric Company of Montreal, the Edison and the Westinghouse Companies. Their service is very hard, as there are numbers of 10 and 12 per cent grades and a maximum incline of 14 per cent.

At present the power used is furnished by the Royal Electric Company and, as sufficient power can be rented, the company will not now build a power house.

The copper trolley wire is strung on wooden poles temporarily, but iron poles will be substituted.

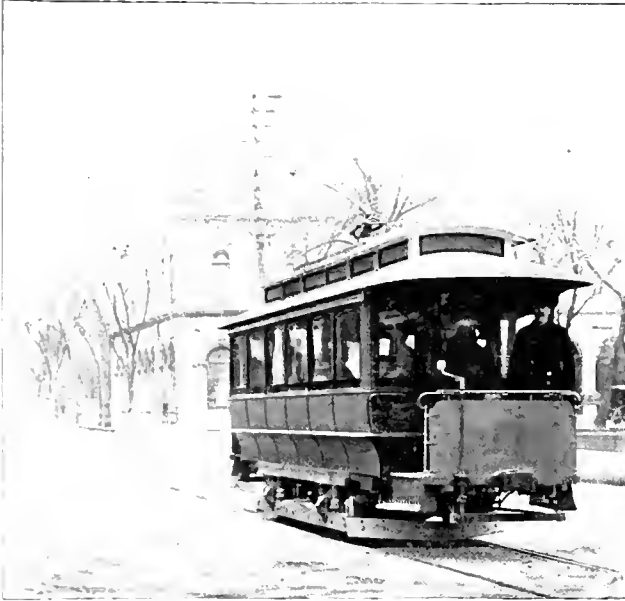

ST. CATHERINES STREET—LOOKING WEST.

The most distinctive feature of railway work in Montreal arises from the frequency, pertinacity and depth of the beautiful snow, which is no respecter of corporations, and falls in a cold, damp, hard-packed blanket on the street railway tracks and the heart of the manager. For many years the great difficulty was overcome to some degree by the use of sleighs which made regular trips. There were 100 of these in use.

To take care of the snow fall is an immense task, as the average fall for the past seventeen years has been 12 feet annually. This the railway company is required by ordinance to cart off from curb to curb, the city paying one-half the expense.

With the advent of electric cars more extensive means of removing the snow must be made, and the very ingenious suggestion is made by Mr. Ross, of melting the snow. Chief engineer Cunningham works out the idea to this effect. The heat generated from 15 tons of coal will melt 1,000 tons of snow in 20 hours, or somewhat more than would accumulate on a mile of street at a depth of 12 inches. This will reduce the expenses of hauling snow from the central part of the city; with the additional help of electric snow sweepers and track brooms it is estimated by the engineer that the expense of keeping 10 miles of track open can be done at a reasonable expense, dependent on the organization of the snow cleaning force.

The number of sleighs will be reduced for this winter, and as these vehicles could not be heated, and the electric cars will be provided with hard coal stoves and Burton electric heaters, the public will be better pleased.

On the line of the railway are found numerous resorts which, with rapid transit facilities, will be liberally patronized. Historic Mount Royal and the beautiful Sohmer and Lacrosse parks have many attractions for both visitor and inhabitant of Montreal.

The addition of 35 miles of new track and the final changing of the 50 miles now existent will also have its effect on outlying property.

The present management is a strong combination of forces, and the street railway world looks to it for a strong example of enterprise. President Forget and Secretary E. Lousher are first-class men, who, with Superintendent

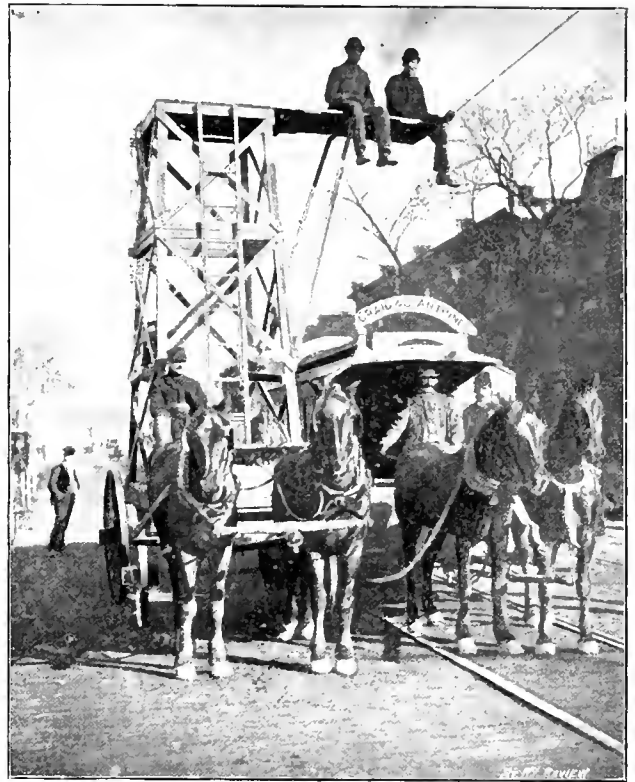

NEW TOWER WAGON—MONTREAL.

Franklin, are well acquainted with locality and people, while the accomplished skill and the extensive experience of Managing Director Everett does the rest.

ONE HONEST EDITOR.

THERE was much opposition in the good old city of New London, Conn., to the introduction of the trolley system. The daily "Day," more honest than most papers, says: "The street railway has done all for the town that was promised by its projectors, and more. We make the acknowledgement now, not only for our own satisfaction, but for the benefit of course, of our contemporaries in other parts of the state, who are struggling with the same misgivings and influenced by the same unfounded prejudices which led us to question the expediency of introducing the trolley system."

ELECTRICITY FOR THE FARM.

A RATHER rose colored scheme for keeping the boys on the farm is proposed by Nelson Black, in a recent engineering magazine. Mr. Black estimates that more than 90 per cent of the roads in the United States could be equipped with electric traction at the cost of \$3,500 per mile, and to accomplish his utopian scheme, he claims that a capitalization of \$10 per acre would fit up a district 10 miles square with lines one mile apart. In other words, an interest charge of \$60 annually, on the average farm.

Mr. Black's enthusiasm is commendable, and his plan is to some degree practicable, but as to the manner and means of accomplishing the end considerable latitude should be allowed.

As to the manner, the most feasible idea is to build a few lines to the more thickly settled districts, and at sufficiently frequent points on the line, place stations and loading platforms, where the neighborhood should meet to load the electric freight cars for market and to receive in their wagons the supplies brought from town. This will economize time without waste of money, on lines where traffic will be limited, and as lines on all streets of all cities will not pay, much less will the mile-block system of suburban electric lines return a dividend to the agricultural investor.

Suppose however, that a line should be built 15 miles in each cardinal direction from a market town, the center of, say, 100,000 people. This would bring a shipping point within two or three miles teaming of at least one-half of the above number. This is the best method if it be done.

Mr. Black's estimate of \$3,500 a mile as the cost of construction, is considerably out of plumb with the existing circumstances as to supplies, labor, and engineering difficulties frequently to be overcome. A mile of substantial electric road, laid with 45-pound T rail, will cost \$5,000. For if built at all, it should be built in a first-class manner, capable of any freight work that may come upon it and be less liable to repairs. The line work is now worth perhaps \$1,700 a mile. In addition to this first cost of construction, the power plant and attendance, as well as rolling stock, must be accounted for, bringing the total cost to a figure apparently not appreciated by the granger writer.

The revenue which some might imagine as available, from rental of power along his line, will be found to be more theoretical than practical. The farmer must have his teams, and would figure his "horse-power" as costing him nothing, for with the exception of running threshers,

which is largely done by portable engines, his other work requiring stationary machinery, is operated either by wind mill or by horse-power machine, in neither of which case is there any outlay for operating expenses. Hence little revenue can be estimated from this source.

There is nothing, moreover, harder than convincing the average farmer of the value of interest. He much prefers the dollar in the hand to several hundred in the future, and as to Mr. Black's method of raising the necessary capital, it is less possible than his original proposition.

Along certain roads with some particular advantages of commodity and with a particular kind of people, the idea is good, but with ordinary difficulties of construction, with ordinary values of commodities and among ordinary rural population, the scheme of co-operative railway would go the way of the granger movement, the farmers' alliance, and half a dozen socialistic villages.

We are earnest advocates of interurban roads, and were among the earliest to point out their benefits, but the impracticability of the road-a-mile is neither sufficiently extravagant to be original, nor sensible enough to be commendable. Such writers are harmful to the best interests of electric traction.

His death recalls an interesting event in the life of Dr. Siemens, who was at one time imprisoned for acting as second in a duel. While there he was allowed to experiment on electroplating, and was greatly disappointed when, after a month, was pardoned.

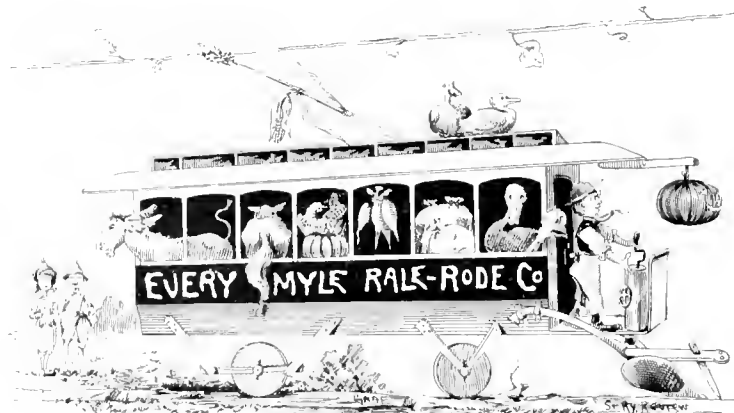

THE FARMER'S DREAM.

FUEL CONSUMPTION IN THE UNITED STATES.

THE following table gives the consumption of fuel for the past twenty years according to the United States census:

	1870	1880	1890
Gross tons of anthracite coal	13,925,229	23,580,189	40,714,721
Gross tons of bituminous coal.....	15,356,610	38,242,641	85,383,059
Bushels of charcoal.....		74,008,972	90,000,000*
Cords of wood.....		145,778,137	180,000,000*
Barrels of petroleum.....	5,260,745	26,286,123	34,820,306
Natural gas, value of coal displaced. No report. No report.			\$20,000,000*

*Estimated.

The present consumption is equal to about $3\frac{1}{2}$ tons of coal per annum in calorific value, per capita. A million and a half tons of fuel have to be transported every day in the year, and the mining and handling require a million laborers. This does not include natural gas.

WM. S. WALCOTT has been appointed superintendent of the Danvers division of the Lynn & Boston Street Railway.

LA FAYETTE ELECTRICS.

THE natal state of James Whitcomb Riley has no prettier city than
 "THAT TOWN OF LAFAYETTE."

Here, on the historic soil trodden by the warring bands of redmen and the resolute early settlers, redolent with the history of "Tippecanoe and Tyler too," down on the banks of the Wabash dwell the 16,000 wide awake, progressive, and busy people of LaFayette.

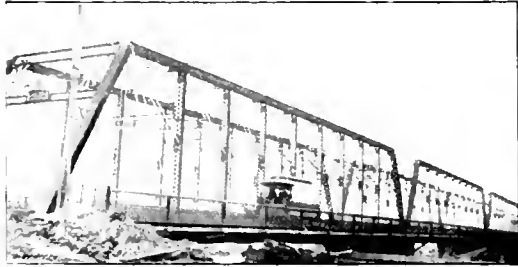

MAIN STREET BRIDGE.

The town was founded in 1827, and has had a slow but sure growth in population and wealth ever since. Today the carriages, farm implements, machinery, cloth, paper, and other articles of domestic manufacture made here are known all over the land. The town boasts of

electric traction, that what is said to be the second Sprague system in the world was installed with proper enthusiasm. This first electric road used seven-and-a-half horse-power motors on the old horse cars. There were eight motor cars in use all told, although in 1889 there was added another car equipped with Sprague No.



MOUNTING A 7.5 PER CENT GRADE.

6 motors, which were improvements over the old style, but still crude from the present point of view.

On October 14, 1891, the road was reorganized under the present management, and a new and modern equipment ordered, with the exception of the engines and boilers of the old plant, which were retained for the new

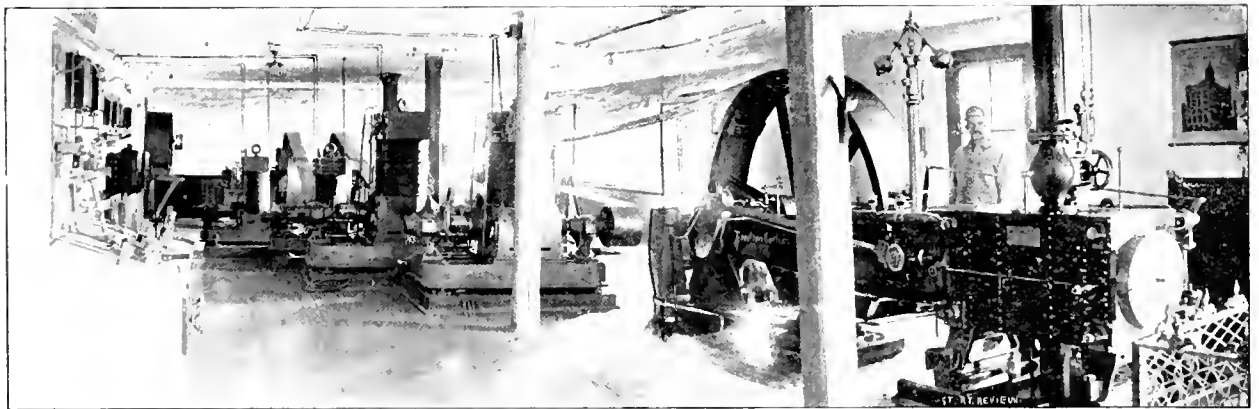

INTERIOR OF POWER HOUSE—LA FAYETTE STREET RAILWAY.

twenty-seven churches, three daily and five weekly newspapers, and is besides the home of Perdue University, an institution well known for its scientific attainments. It is on a state foundation, and its curriculum includes a thorough mechanical course, including electrical engineering in all its branches, with practical applications to industries there settled.

From 1827 to 1881 the good burgers of LaFayette wore out shoe leather and patience in walking to and from their daily haunts of business and pleasure. The oldest inhabitant finally died of over-exertion in pedestrian exercise, and a valient company accepted a franchise for a horse street railway, which was built in 1884. Three years later the rumors of electric traction excited the curiosity of the owners of the road, and an investigation showed such superior merits, even at that early stage of

service, and a 220-volt dynamo used for running stationary motors. A contract was made with the Edison General to furnish six double equipments of No. 14 Edison motors, and two dynamos of the same make of 60 kilowatts capacity each, together with the line construction, switch board, and other minor equipments. At the same time the J. G. Brill Company, of Philadelphia, was bidden to construct five closed 14-foot cars of their best make, and, to honor these high-class equipments, new 56-pound Johnson T rail was laid on the entire roadbed of five miles. Brill has furnished three more cars, so satisfactory were the first ordered. These cars carry two 20-horse-power motors, and run on Brill, and Griffin Wheel and Foundry wheels. Brill's trucks are also used.

The power station is provided with a 130-horse-power Hamilton-Corliss engine, now in use long enough to

make it the "stand-by" and "swear-by" of the company, by reason of its excellent performance. Hoover, Owens & Rentschler made the two boilers, which give the best of results, and Hoppes' feed water heater is an indispensable adjunct of the station. Natural gas is used as the fuel, at a saving of two-thirds over coal. We illustrate the burning connections.



CAR HOUSE—LA FAYETTE STREET RAILWAY.

The stationary motor business is no small item in the year's business, consuming the 220-volt output of the two Edison 25-horse-power generators, which drive 14 motors ranging from $\frac{1}{8}$ to 10-horse-power. This power is giving excellent satisfaction in operating printing houses, shoe factories, elevators, ventilating fans, and

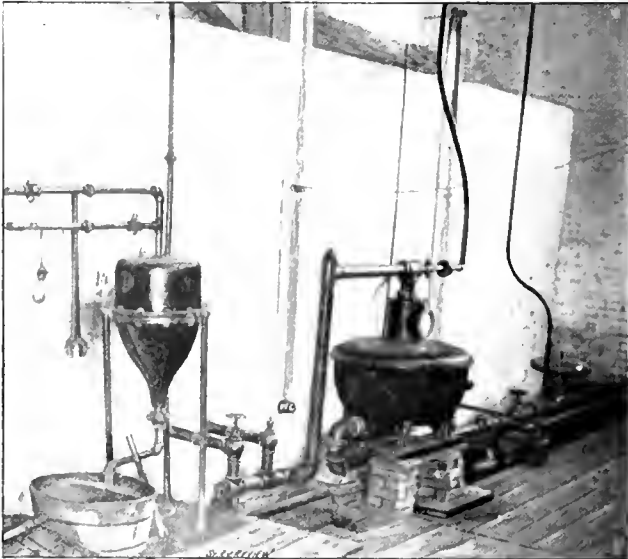

METRE FOR MEASURING NATURAL GAS.

light manufactories. This rented power does not interfere with the regular progress of business, and we strongly advocate similar enterprise in several cases of "too small income."

Perdue University above mentioned gives a good patronage to the road, having for three quarters of the year eight hundred students in attendance. The bridge over

the Wabash river to the university is shown in the accompanying engraving. Both conductors and motormen are employed on all cars.

The present management which has raised the road to its present excellence, consists of T. J. Levering, president and treasurer; J. C. Welles, secretary, and J. S. Hill, general manager.

It gives us great pleasure to introduce by means of the graphic art the faces of the two latter named gentlemen, and also to give sketches of their lives up to date.

J. S. HILL.

The general manager made his debut Jan. 22, 1860, and stayed on the farm until his twenty-first year, when his inclination towards mechanical art took him to a machine shop at his native town of Delaware, Indiana.



J. S. HILL.

Here he learned the trade which has since been so valuable to him. In 1888 Mr. Hill took charge of an electric light plant until 1889, when he became wireman for J. K. How, of Baltimore, with work at Washington City. After working for the Wenstrom Company and the Marr Construction Company, of Pittsburg, Mr. Hill went into electric railway work with Thomson-Houston, at Brooklyn, in 1890. In June of the same year he became manager of the Glen Echo road, Maryland, and in December became associated with his present affiliation. Mr. Hill's energy and practical knowledge as well as his pleasing personality and social ability has made him the master of every situation he has yet encountered.

J. C. WELLES,

the popular and efficient secretary of the company, was ushered into this sphere of joy and tribulation November 27, 1865, at Newburgh, N. Y.

After a good preparation in the excellent common and high schools of his native place, Mr. Wells served a varied apprenticeship at clerical and machine work, ending with a good position with the Marr Construction Company, of Pittsburg, and going in this employ to

various parts of the country. Mr. Welles' life has not been long enough to admit of much history, but the success he has already attained bids fair for a longer biography at some later date. He became secretary of the



J. C. WELLES.

LaFayette line in April, 1892, and the success of his efforts have been recorded in the preceding history of the strides of the road towards life, liberty and dividends.

THE INCANDESCENT LAMP DECISION.

THE U. S. Court of Appeals has granted the injunction asked for by the Edison General Electric Company against the Sawyer-Man Company (Westinghouse). The injunction is a permanent one, forbidding the latter company to manufacture incandescent lamps infringing the Edison patent. The court imposes the condition that the Edison Company must sell lamps for use with Westinghouse apparatus installed prior to Judge Wallace's decision of July 14th, 1891, "Upon terms reasonable under the circumstances of the particular case."

No provision whatever is made for applying lamps to Westinghouse apparatus installed since July 14th, 1891, or that may be hereafter installed, and the question of terms, prices, etc., for lamps for use with apparatus installed before that date is left open, except that they must be "reasonable under the circumstances of the particular case."

A LARGE amount of Belgian block is being laid by the Philadelphia companies, who are using it to replace cobble.

HENRY S. IVES, the "Napoleon of Finance," who distinguished himself by borrowing \$23,000,000 before he was 24 years old, is said to be forming a syndicate for extensive purchase of street railway interests, and that the Seligman's will back him.

THE PORTER NEW ROCKER SWITCH.

THE Porter new rocker switch, made by the Porter Tramway Switch Company, of Cleveland, differs from all other switches made, in that the point instead of being fixed at one end moves with an equal motion at both ends.

As will be seen in the engraving the switch is surrounded with a cast iron box. The main object of this box is to receive the dirt that is caught in the switch. The openings around the switch allow whatever debris is caught in this way to fall through whenever the switch is turned, thereby keeping the point free from dirt and ice. The point is supported on a segment of a roller and the motion is a simple tilting of the wedge or switch point from one side of the switch box to the other. Thus

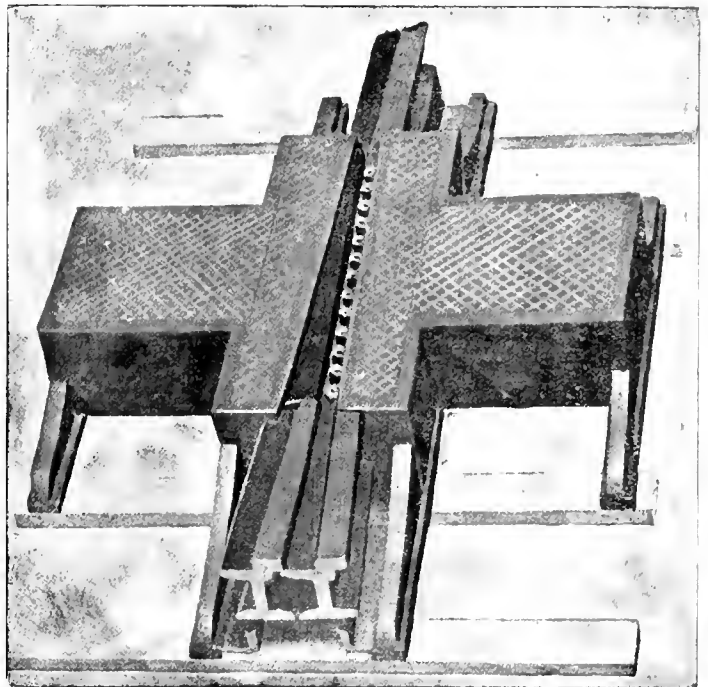

THE PORTER ROCKER SWITCH.

there can be no slipping of the switch from side to side while the car is passing over. The combination is heavy enough to hold eighty tons.

The switch point being only thirty inches long it is adapted to almost any curve. If convenient sewer connections can be made with the box, making it practically self-cleaning. They are made either single or self-acting, and the tongue can be thrown from the car either by electricity or a shifter lever on the front platform. Every wearing part can be renewed in a few minutes without removing pavement or interfering in any manner with traffic.

This switch has been tried on several roads in Cleveland with great success and is being rapidly introduced in other cities. For an appliance which is of so recent introduction its success has been quite unusual. J. Y. Porter is the inventor and the switch is manufactured by the Porter Tramway Switch Company, 53 Wade Building, Cleveland.

THE HARRIS PATENT ANTI-FRICTION TROLLEY BASE.

ALTHOUGH not of such primary importance as a sound road bed, or a highly efficient motor, yet the trolley attachment is of considerable importance in making up the best equipped electric car.

Of the many and various kinds of trolley bases in use the one of which we give a sketch is well deserving of prominence.

It is light, easy of adjustment and exceedingly strong. The stand is made from one malleable iron casting, having an upright arm, 4 7-8 inches long. The body is

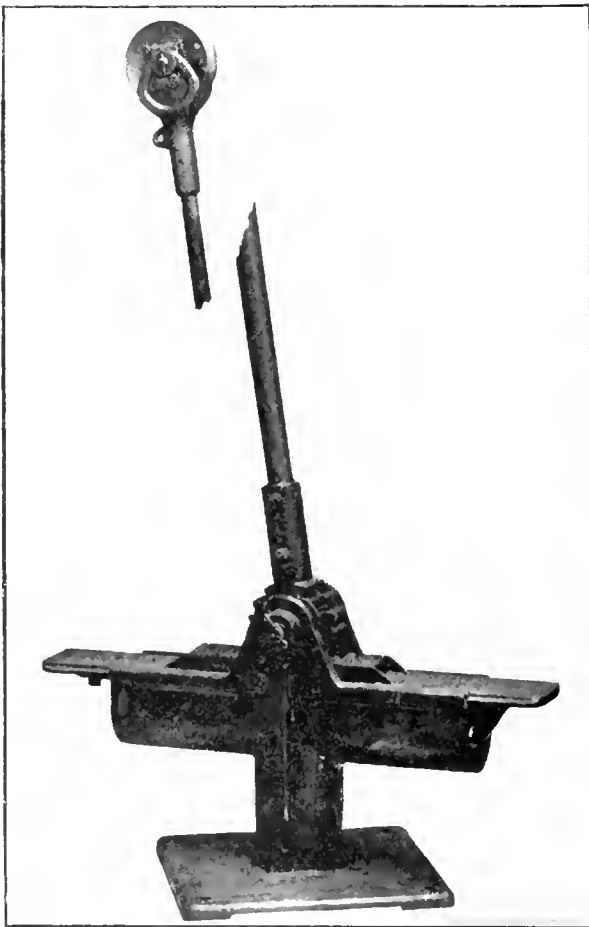

HARRIS' TROLLEY BASE.

also made from one malleable iron casting, and has a sleeve fitting arm on stand, and made to revolve freely by means of an anti-friction roller bearing.

Encased in the body are two highly tempered spiral springs. Covering the body, and thus protecting the springs, is a cast steel plate 25½ inches long and 4 inches wide, fitted to body by grooved joint. A rack in the center of this plate has teeth, which are made to mesh with teeth in steel pinion. To the steel pinion is cast the socket for holding the trolley pole. These parts, with a few minor fittings, comprise the whole base.

The Brooklyn Street Railway Company, Cleveland, Ohio, say that during the twelve months since they first put them into use the repairs on them have been nomi-

nal as compared to other trolley bases which they have used. All parts are made interchangeable. They are manufactured by The Steel Motor Company, Cleveland, Ohio.

AN ELECTRIC RAILWAY IN SINGAPORE.

IT isn't every country that is so advanced in civilization that it can leap boldly from shank's horses and palaquins to a lightning propelled carriage, without going through the intermediary processes of wheel barrows, wagons and steam engines. This thing, however, has been done at Singapore, a city off the Malay peninsula of India, on an island of the same name, under the protectorate of England.

The population of the island is about 275,000, composed of Malays, Chinamen, Dutch, French and English.

The government is under the supervision of native princes, with Mr. Gladstone's ministry immediately behind the throne for decapitative purposes. The particulars of the installation are at present very meagre, but suffice it to say that our engraving, which is made from a photograph, shows the crown prince of Johore

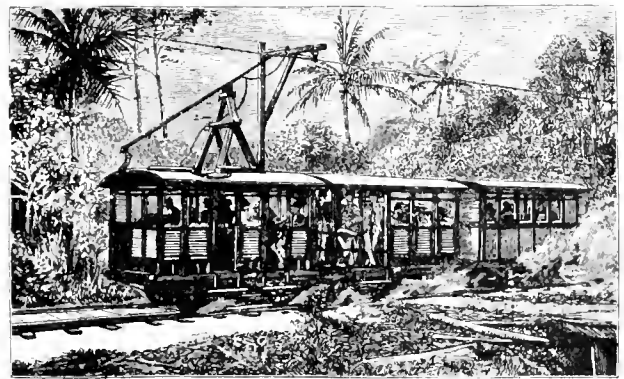

SINGAPORE ELECTRIC RAILWAY.

with a right royal retinue of sword bearers, high muck-a-mucks and harems. The Sultan of Penang may be recognized also by those of our readers who have met his Terribleness, together with his first wife, Thea Nectar, and half a dozen of his mothers-in-law.

The line is now one mile long, but is the beginning of a longer one to be completed between Singapore and Kranzi. The road is counting on a good traffic, from both the natives and the thousands of Europeans who come thither as travellers or as merchants. Three cars were run in one train for seven days, by way of trial, and the working was found very complete and satisfactory. Open cars with curtains are the only ones in use, and, while we do not admire the graceful outline of the trolley stand and pole, we suppose they are for the benefit of our Simian ancestors, who may wish to travel on top. As this form of trolley pole has not been patented in America there may be a chance for some of our readers.

THE manager of the Muncie, Ind., line is going to give a storage battery car a trial. Thus far the managers who have experimented with "bat" cars have been the ones who have had the "trials."

ELECTRICITY ON THE CHICAGO CITY RAILWAY.

ONE of the greatest strides electrically, for street railway work that has taken place in the year 1892, is the adoption of electricity for its crosstown lines of the Chicago City Railway, of which Geo. H. Wheeler is president, M. K. Bowen, superintendent and Robt. J. Hill, chief engineer.

The first lines to be equipped are two miles on Sixty-first street from State street to Jackson Park, with a branch on Cottage Grove avenue to Sixty-third street; thence on Sixty-third street to Jackson Park with a double loop extending north and south at the park; four miles on Forty-seventh street extending from Western avenue east to Cottage Grove avenue; and three miles on Thirty-fifth street from California avenue east to State street. All the above mentioned lines will be equipped and running before the opening of the World's Fair; the balance

is finished so as to appear from the street to be two stories high, while, in reality, it is but one story, 35 feet in height. Red pressed brick with terra cotta and stone trimmings forms the structure. The roof is trussed tile and designed to carry a weight of 40,000 pounds. Skylights will be placed in the roof to afford the best possible light.

The boiler room is 56 feet by 128 feet, and will contain 14 Mohr tubular boilers, 72 inches by 18 feet long, each to have sixty-four 4-inch tubes and be equipped with a Murphy smokeless furnace. Coal will be supplied to these furnaces by a coal conveying apparatus running from the bins to each furnace. The bins in this house will have a storage capacity of 420 tons. The stack is

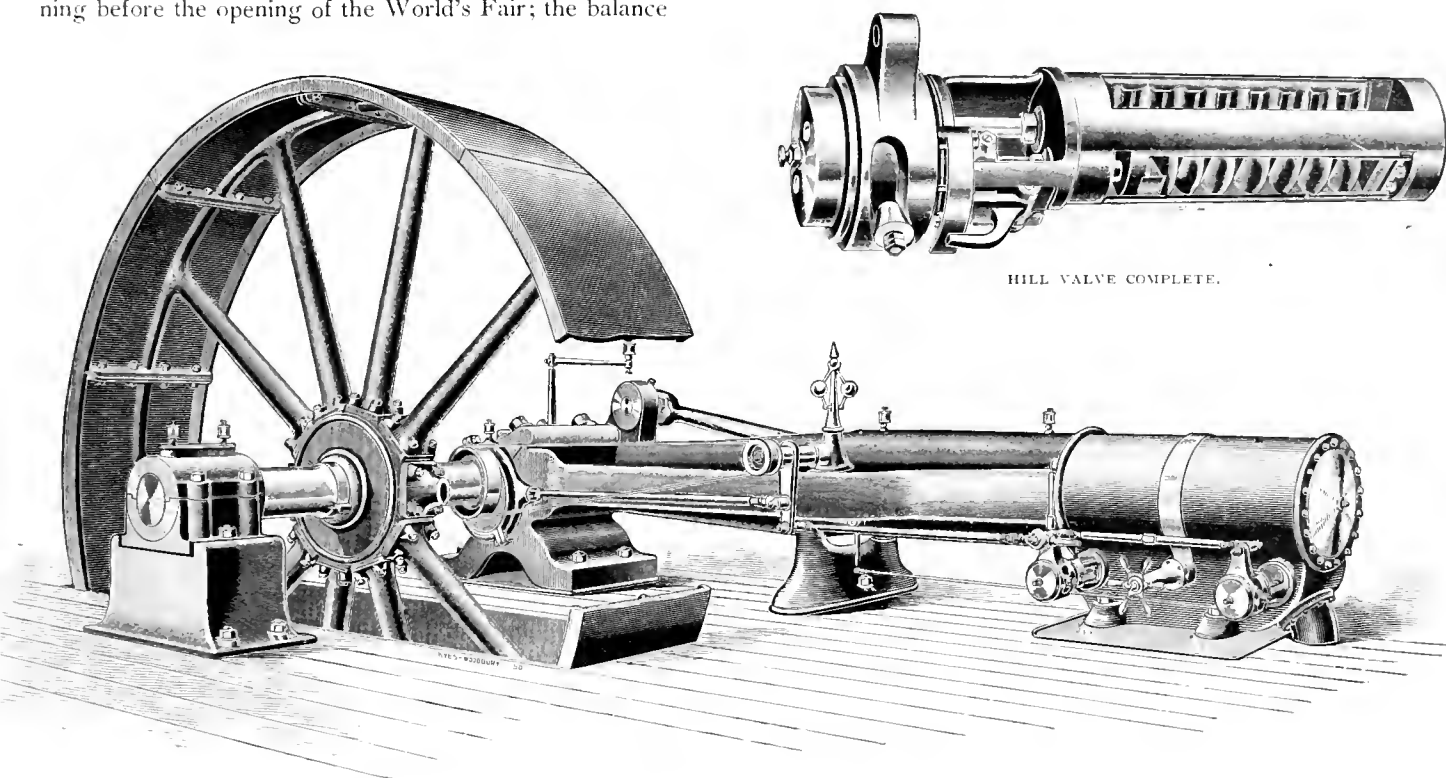

IMPROVED WHEELLOCK ENGINE, WITH HILL VALVE GEAR—CHICAGO CITY RAILWAY.

of the lines that are now operated by horses will be changed as soon as equipment can be procured and when all complete will comprise: 108 miles of track and 350 car equipments: 200 cars will have two 25-horse-power motors to each car, and 150 cars will have two 15-horse-power motors to each car.

The power plant to generate the electric current for these lines, contain some new features; and all of the improvements known for the commercial and mechanical success of such work have been taken advantage of in this plant.

The building is now almost completed and is situated on Wabash avenue, between Fifty-second and Fifty-third streets, and is 130 by 147 feet on the ground floor, and

placed in the center of the boiler room and has 7 boilers on each side, leading the gases into it by means of iron breechings extending over all the boilers. When completed it will be 175 feet high, 17 feet outside diameter with a 10 foot flue the entire length. Between the stack and the engine room there are to be two Baraganath heaters of proper capacity to heat the feed water for the entire boiler plant.

The system of piping in this plant is certainly modern in every detail. 30-inch drums 53 feet in length extend over the entire battery of boilers and are connected, as shown in the cut by means of an 18-inch copper goose neck. From the 30-inch drums, steam is taken to each engine by means of a 10-inch heavy steam piping, having

a 10-inch angle valve placed next to the drum. Copper joints and elbows are used throughout the entire plant, which probably accounts for the comfort now enjoyed by Engineer Hill in his present plants.

into two sections each of the shape of a letter V on its side; these meet at a central door which allows access to the rear of the board. The outside of each division will control the station apparatus, while the inside of the board,

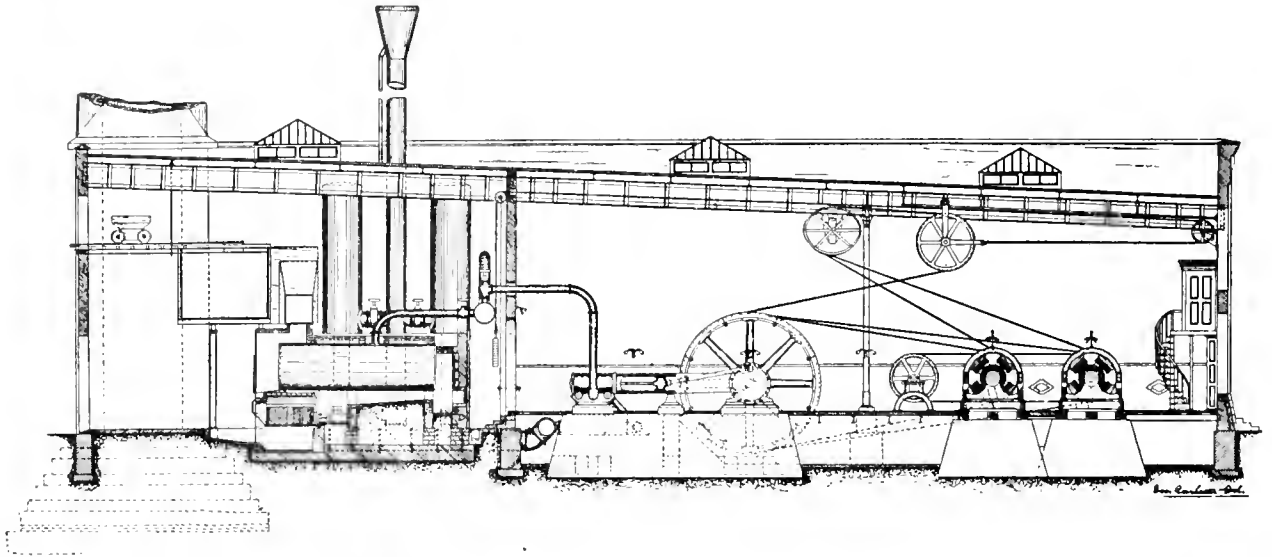

ELEVATION OF POWER HOUSE—CHICAGO CITY RAILWAY.

The engine room is to be a fine specimen of steam and electric equipment. The dimensions of the engine room will be 90 feet by 128 feet and finished in white enameled brick; the generators are to be ten in number, each of

formed by the other side of the V, controls the lines. Most of the apparatus will be composed of marble or slate. A separate lighting plant will illuminate the dynamo room by 10 arc lamps and 60 incandescent lights.

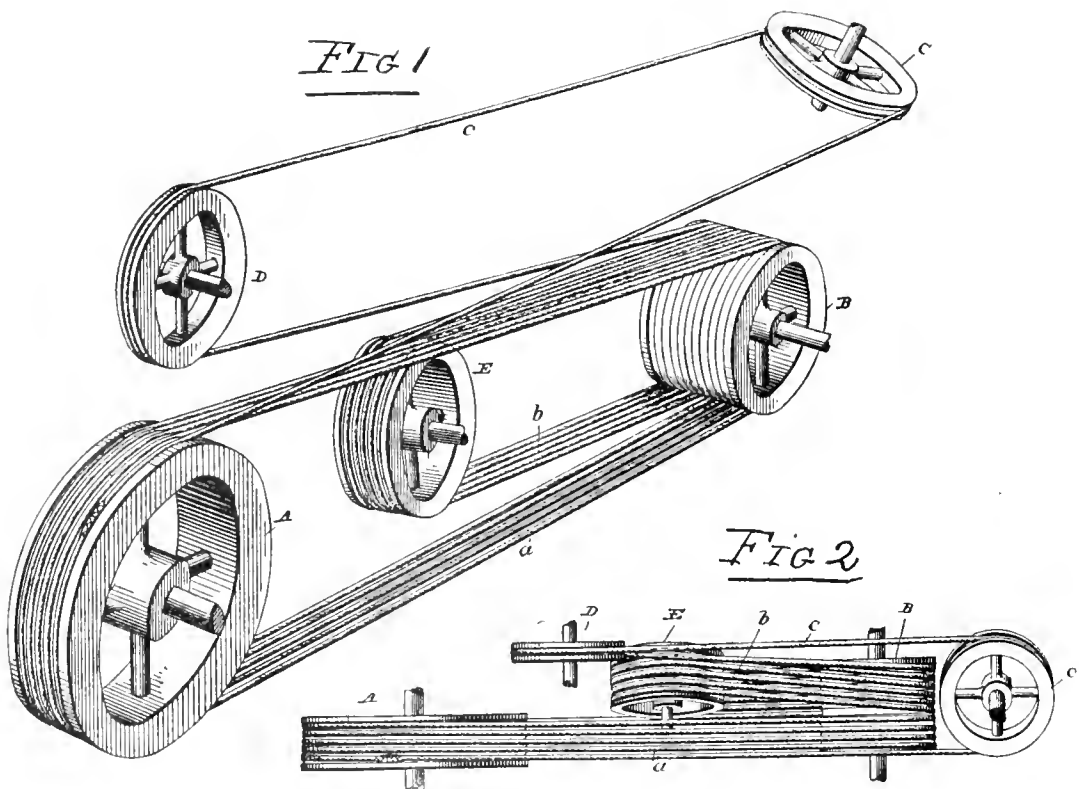

HOADLEYS' COMPOUND WIND SYSTEM—CHICAGO CITY RAILWAY.

the Westinghouse No. 6 type, rated at 700-horse-power when running at 300 revolutions per minute.

The switch board for the plant will be placed on a balcony in front of the dynamo room. It will be divided

The engines to drive this plant are of the improved Wheelock type, equipped with E. K. Hill's valve system. They are ten in number composed of five pair. They are designed to run 100 revolutions per minute with 100

pounds boiler pressure, and while so running will develop, per pair, 1,400 horse-power. The size of the cylinders are 24 inches by 48 inch-stroke.

The Hill valves and their arrangement are illustrated on pages 33 and 35. The advantages of the valve gear need no explanations, while the ease and quickness with which the gear may be stripped and replaced is a recommendation.

Each pair of these engines will have an 18 foot "built up" fly wheel, weighing about 50,000 pounds. The hub will be forced on the shaft and each arm (10 to each wheel) recessed 4 inches into the hub; each segment will be bolted to arm and keyed with side keys; each wheel will be grooved for 21 wraps of 1 1/4 inch rope. A new departure in transmission of power is being inaugurated in this plant and will be watched with great interest. It is the endless system of rope transmission and is a combination of the Dodge, Hitzeroth, Williams, Macdonald and Hoadley patents. It is known as the compound wind and is extensively used on the Pacific coast for electrical work. The driven pulleys in this case are 72 inches in diameter and revolve 300 turns per minute, are

grooved in for 32 wraps of 1 1/4 inch rope and drive two 700 horse power generators. The compound multiple

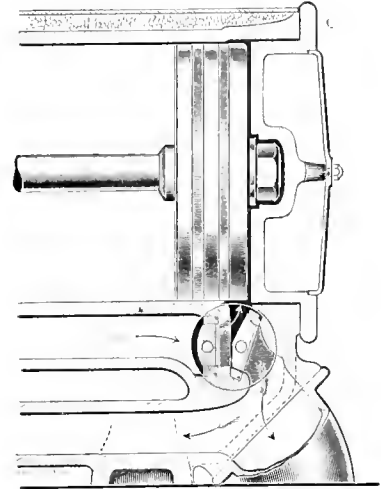

SECTION OF VALVES AND CYLINDERS.

winder is 72 inches diameter, grooved for 11 wraps 1 1/4 inch rope. The stationary and carriage tighteners are

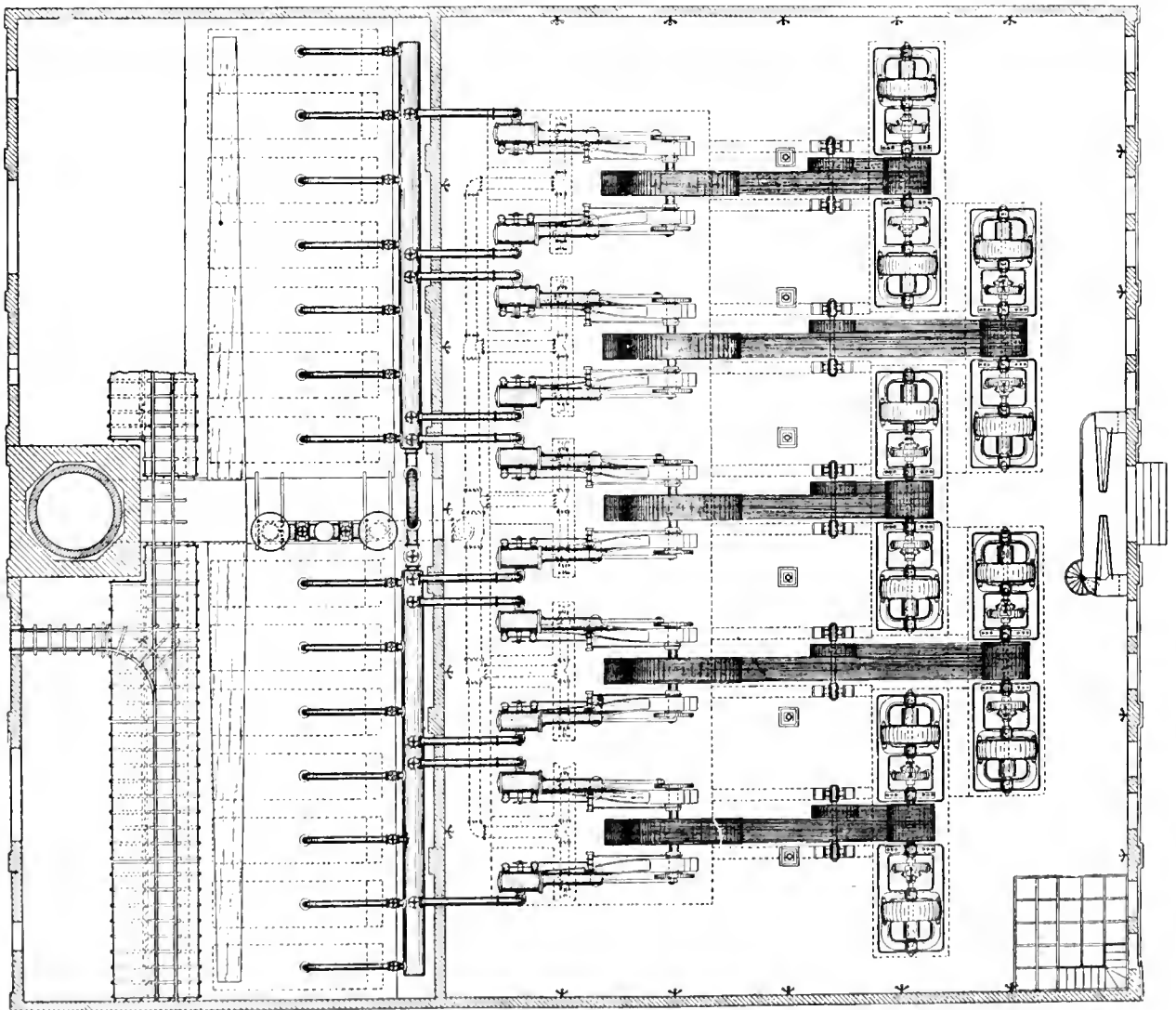

PLAN OF POWER HOUSE—CHICAGO CITY RAILWAY.

84 inches in diameter and suspended from the ceiling. These transmissions are designed to transmit 1,600 horse power, and when it is noted that the fly wheel face is only 39 inches in width, it is something of importance in handling large powers. The rope will be lubricated with Bichette rope dressing and it is expected that one set of ropes will last five years when properly handled.

This plant is being constructed and furnished by the California Engineering Company of Chicago, Hoadley Brothers engineers. They are having the engines built by the Wheelock Engine Company, of Worcester, Mass., and the Eclipse Clutch Works, of Beloit, Wisconsin, who also furnish these mammoth clutches. The rope transmission pulleys and attachments by the Dodge Manufacturing Company, of Mishawaka, Indiana. It is expected to have the plant in operation within thirty days.

INCREASED EARNINGS OF RAPID TRANSIT.

SO much has been written on what a change from horse to mechanical power will accomplish, readers are apt to accept the statement, but neglect to notice in how marked a degree is the resulting increase.

The Binghamton, N. Y., street railway is a good example of the above, and the more so because it is not one of the larger roads. This road shows the following wonderful increase in the past three years:—

Gross earnings year ending Sept. 30, 1889	\$12,163.40
Gross earnings year ending Sept. 30, 1892	52,250.33
Gain for July, August and September, 1891, over 1890	4,621.05
Gain for July, August and September, 1892, over 1891	5,008.14

Showing a total gain of this period of three months of 1892 over 1890 of \$9,629.19, the same being a gain of 73 per cent and with the same track mileage and local conditions.

The earnings shown for year ending Sept. 30th, 1892, were made with ten miles of the system operated by electricity; the balance by horse power. The remaining 3½ miles have been electrically equipped by the Binghamton Railroad Company since consolidation, and operation of the same commenced Oct. 13th, '92. and with the same number of cars (three) for the first four weeks earned, viz.:—

Oct. 13 to Nov. 9, '92, electricity (3 cars)	\$1,264.80
Oct. 13 to Nov. 9, '91, horses, (3 cars)	538.55

Earnings under same conditions and with same number of cars, for the first two weeks operated by electricity, and last two weeks operated by horses:—

Oct. 13 to Oct. 26, '92, electricity	\$680.30
Sept. 29 to Oct. 13, '92, horses	322.60

The growth of the city of course has had somewhat to do with this increase, but does any person imagine for a moment horse car earnings could have made any such showing?

THE Consolidated of Toledo, O., has increased its mileage 50 per cent in three years, and have dropped from 650 to 80 horses.

WE PULL HIS TEETH.

A GENTLEMAN in the East who recently had occasion to place an advertisement, which he desired should reach every street railway man in the country, sent it to the REVIEW with a pleasant letter of which the following is a part:—

"Your valuable journal reminds me of the Chinaman's sign of a good dentist. When a Chinaman in his native country desires to have a tooth extracted, he travels 'round from one dentist to another and inspects the receptacles they use for teeth they have extracted. A full one indicates prosperity and popularity. An empty one, or nearly so, is considered the result of a poor and unpopular dentist. Consequently the suffering Chinaman sets in the chair that is recommended by the full basket and feels sure he is in the right place. Your journal is the full basket compared with the other journals that come to my office. Consequently you pull my teeth."

Next! With or without "gas?"

NEW STREET CAR VESTIBULE.

A RECENT invention has been made by J. E. Foster for street car vestibules, doing away with outside steps. Both ends of the car are similarly constructed, but whichever is used by the motorman is occupied by him exclusively. The vestibule is semi-circular, and is entered directly from the street. Sliding entrance doors are placed at "D." A pivoted door opens from the vestibule into the interior of the car and com-

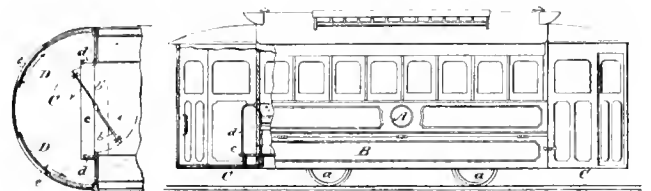

pels passengers to enter and depart at their right, and is intended to prevent a blockade of that passageway. The car floor is elevated one step above the vestibule floor. While the arrangement is new, objections may be made to having passengers in leaving, step to the ground with their backs to the car, as any accidental start would almost certainly throw them down; and a crowded vestibule would seriously interfere with ingress and exit and also the opening of the pivoted door.

Stop-over Privileges Discontinued.

To avoid manipulation and illegitimate use of its tickets, the Wabash Railroad Company has found it necessary to discontinue the granting of stop-over privileges on all kinds and classes of tickets, and after January 1st, 1893, passengers will be obliged to purchase tickets from point to point. The new arrangement, however, which will be fully explained by any of the Company's agents, will be found to be equally as convenient to the traveling public as the old, while the Company will be enabled to protect itself from imposition.

CASS AVENUE COMPANY'S CONTRACTS.

THE three lines known as the Cass Avenue and Fair Grounds, the Northern Central Railway, and the Union Railroad Company, of St. Louis, have been united under the head of the Cass Avenue and Fair Grounds Railway Company, of which D. G. Hamilton, Chicago, is president, and Captain Robert H. McCulloch, general manager. Contracts have been let for \$1,500,000 worth of electric equipment, allotted as follows: Track material, Johnson Company, Johnstown, Pa.; ties, Duff & Company, St. Louis; electrical equipment, General Electric Company; engines, (three 800-horse power and one 300-horse-power), E. P. Allis & Company, Milwaukee; twelve boilers, John O'Brien, St. Louis; one hundred cars, St. Louis Car Company; wire, J. A. Roebling's Sons Company.

PLEASURE RESORTS ON THE GRAND RAPIDS ELECTRIC.

OUR readers know how great an interest is being taken all over the country in the creation of pleasure resorts in connection with street railway enterprise. In some places the city joins with the company, as in Minneapolis, in others the burden falls

entirely upon the road. As an instance of the latter the work of the Consolidated Street Railway, Grand Rapids, Mich., is a notable one.

entirely upon the road. As an instance of the latter the work of the Consolidated Street Railway, Grand Rapids, Mich., is a notable one.

The Reed's lake pavillion will be ready for occupancy at the beginning of next season. Reed's lake is situated on the company's ground, and the site of the new pavillion is occupied by old buildings at present. It is the intention to remove these and put in their place a fine new pavillion, that will be all that could be desired, for the accommodation of the pleasure seeking public. The main building will be 75x140 feet, with an L in front 75x75 feet. The lower part is open, as can be seen in the engraving. Up stairs will be a dining-room, with balconies leading off. The tower is to be 75 feet high and made resplendent with electric lights. The building will have two complete systems of water works, one for drinking and the other for general purposes. The com-

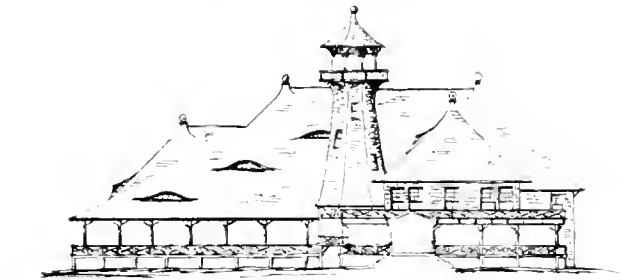

PAVILLION AS SEEN FROM LAKE.

pany will also provide a first-class band to play afternoons and evenings during the summer season of seventeen weeks. Toilet accommodations are provided in the building. Fine steamers ply on the lake, and there are pic-nic grounds, bath houses and other attractions, so that people who go to Reed's lake for recreation can have their choice of a variety of amusements. Another enterprise of the company is the dredging out of a channel

between Reed's lake and Fisk lake, making them practically one, the result of a long cherished scheme of B. S. Hanchett, Jr., the assistant secretary and treasurer. The present general manager of the road is Jas. R. Chapman. When these improvements are completed Grand Rapids will have one of the best pleasure resorts of any city in the country, and the whole undertaking

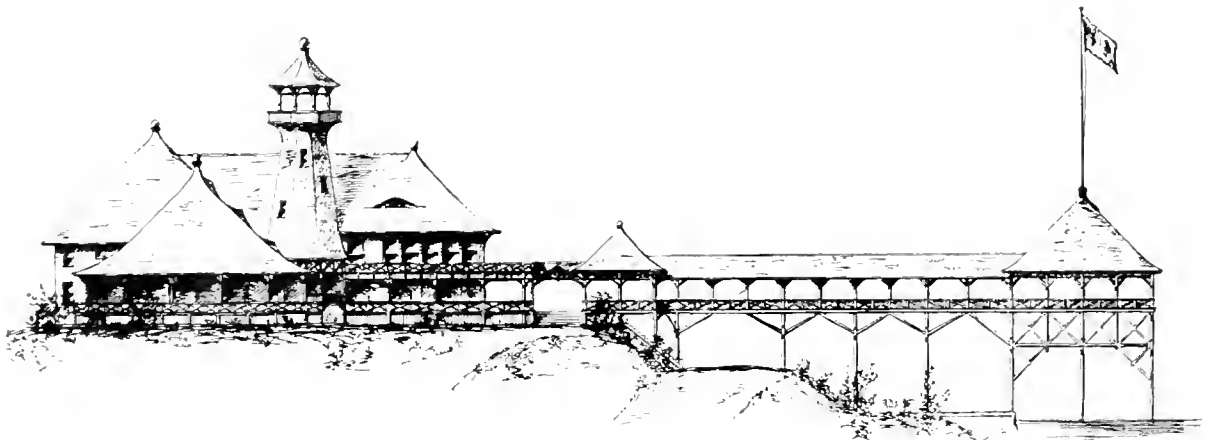

REED'S LAKE PAVILLION AS SEEN FROM THE STREET RAILWAY.

reflects great credit upon the company and its enterprising management. The architect of all the buildings is C. S. Thompson, of Denver, who certainly has conceived a structure most happily adapted to its purpose. The railway tracks run direct to the main entrance.

"GREASED LIGHTNING."

A VERY successful attempt has been made in Portland to keep ice from the trolley wires by the use of vaseline. The application is very simple. Two men stand on a platform on top of a car and while it is moving at the ordinary rate of speed one man spreads the vaseline on sponges while the other applies it. It takes about a gallon to grease the whole system and when the weather is cold the vaseline will stay on a long time. It is applied only to the top of the wire.

LEADING STREET RAILWAY EVENTS OF 1892.

JANUARY.

Helena, Montana, Electric, opens January 1.
 Stout Street Electric, Denver, opens January 1.
 Atlanta & West End and the Grant Park railways consolidate.
 Metropolitan, of San Francisco, begins work on the first electric line in that city.
 The Robinsons and the Consolidated of Toledo, O., sign a treaty of peace.
 Aurora & Chicago Electric organize.
 STREET RAILWAY REVIEW celebrated its first birthday January 15.
 Power house of the Uniontown, Pa., Railway burns.
 Strike at Birmingham, Alabama.

FEBRUARY.

Watervliet Turnpike & Railroad Company leased to the Albany Railway Company.
 Ann Arbor and Ypsilanti road suspended.
 Baltimore City Passenger awards cable construction contract to E. Saxton, of Washington, and Walker Manufacturing Company secures contract for driving machinery.
 Beatrice, Neb., Rapids Transit Company buys out the Beatrice Street Railway Company.
 Death of Calvin A. Richards, Feb. 15.
 Use of electricity resolved on by Philadelphia Traction Company.
 Carthage, N. Y., road bought from American Loan & Trust Company for \$35,000.
 Siemens & Halske of America incorporated.
 Dr. Lewis Bell resigns from the Electric World. Carl Herring succeeds him.
 Massachusetts Railway Association eats at Young's Hotel Boston, and talks snow plows.
 Great Indianapolis strike.
 Death of A. D. Whitton, chief engineer of the Philadelphia Traction Company, Feb. 23.

MARCH.

Indianapolis strike terminates.
 The City Council of Ann Arbor repents and allows the interurban to enter.
 Metropolitan Elevated, of Chicago, organizes.
 Missouri Railway Company's shops burnt at St. Louis, March 15.
 Brooklyn City awards its big electric contracts.
 Death of Chas. J. VanDepoele, March 18.
 The consolidation of the Edison and the Thomson-Houston Companies is assured.

APRIL.

Death in San Francisco of Calvin Goddard, April 4, President of South Side Rapid Transit Company, Chicago.
 Death of Samuel T. Pope, superintendent of the Chicago City Railway.
 The Chester, Pa., electric awards its contract.
 The Elmira Syndicate buys up the electric railway and lightning interests of Elmira.
 M. K. Bowen promoted to the superintendency of the Chicago City Railway vice S. T. Pope, deceased.
 Boston Rapid Transit Commission reports.
 Judge Cox decides the storage battery suit in favor of the Accumulator Company.

MAY.

Northern Car Company, Minneapolis, burns May 7; loss, \$60,000.
 New 2,000-horse-power engines of the Chicago City Railway put in commission.
 Transportation within the grounds of the World's Fair awarded to the Thomson-Houston Company.
 Detroit Citizens' Railway makes arrangements for the trolley.
 General Electric Company organizes with \$50,000,000 capital; C. C. Coffin, president; A. S. Bevis, treasurer; E. J. Garfield, secretary.
 Metropolitan Electric, of San Francisco, opens its lines.
 Chicago's first elevated opened May 27.
 New Orleans strike.

JUNE.

The American Institute of Electrical Engineers meets June 6, 7, 8, at Chicago.
 Willard J. Hield becomes general manager of the Twin Cities Rapid Transit Company at Minneapolis.
 The Worcester & Mellbury road awards its electrical contracts.
 Street railways along the Mississippi and Missouri rivers suffer from the floods.
 The Calumet Electric runs its first car to connect with the Chicago City Railway.
 Contracts awarded for the Duluth electric line.

JULY.

Chicago & Jefferson Urban Transit Company organized.
 Elgin, Aurora and Fox River Electric road is organized.
 Sand storm in St. Paul stops traffic.
 Montreal aldermen vote trolley rights.
 American Electrical Works tender their fourteenth annual banquet to the trade, at Providence, R. I., July 23.

AUGUST.

Otis Elevating Railway opened in the Catskill mountains.
 Griffin Wheel & Foundry Company totally destroyed by fire Aug. 10, opened in two weeks.
 Victoria, B. C., Tramway lost its power house and equipment by fire, August 10.
 Horses on all the roads suffer from heat.
 Washington & Georgetown Street Railway opens its new cable lines.

SEPTEMBER.

Baltimore Cable put in commission.
 Tenth annual meeting of the Street Railway Association of the State of New York, held at the United States Hotel, Saratoga, September 20.

OCTOBER.

Eleventh Annual Convention of the American Street Railway Association held at Cleveland, October 19, 20, 21; 800 in attendance.
 Columbia Exposition dedicated at Chicago, October 21.
 Great crowds at various Columbian festivities tax rapid transit in all the cities.

NOVEMBER.

The street railway employes strike at Columbus, O., on account of a dime.
 Lindell car barns burn at St. Louis, loss, \$150,000.
 Ohio State Tramway Association meets at Zanesville, Nov. 16.

The Staffordshire Tramway, of England, inspected Nov. 12. Worked by electricity.

November 16 sees the beginning of work on the Leavenworth compressed air, street railway.

Philadelphia's first electric road opens.

Atlantic Avenue Street Railway bought by the Philadelphia syndicate of the Richardsons, for \$3,000,000. President Richardson will retire.

The New York Rapid Transit commission, after two years' work, report in favor of an underground road to cost \$50,000,000.

Indianapolis street railways bought by the Pittsburg syndicate.

DECEMBER.

New York bankers buy the New Orleans street railways for \$10,000,000.

Dr. Werner Siemens, of Siemens & Halske, dies at Berlin, December 6.

A severe snow storm in the Missouri valley stops cars at Omaha, Council Bluffs and Sioux City.

The Kansas City Elevated changed from steam to electricity and opens December 6.

Death of Jay Gould, December 1.

STREET RAILWAY REVIEW occupies its new offices, 269 Dearborn street.

Car house of West End road, Boston, burns December 21, with \$125,000 loss, and four employes perish in the flames.

Pennsylvania Street Railway Association organized at Lancaster, December 28.

A car on 47th street line, Chicago City Railway, run down by an engine of the Pennsylvania road, four passengers killed, many injured, December 29.

Lines at Syracuse, N. Y., consolidated, December 20.

Fire completely consumes car house and machine shops at Milwaukee City Railway, December 28. Loss, \$225,000.

Montague cable road, Brooklyn, sold, December 22.

Rapid Transit Commissioners offer underground franchise, December 29, without success.

John Scullin of the Union Depot Lines secures the Benton-Bellefontaine, December 30.

ABOUT THE SUNDAY WALKER.

THE New Orleans Picayune read the following in the Boston Transcript: "No," said the good man, "I never patronize the street cars on Sunday. I consider it a desecration of the day. So I walk, and I receive my reward in an approving conscience, not to speak of the beneficial effects of the exercise, nor of the fact that I have saved 5 cents;" and then it commented: "It does not follow that a man will put in the contribution box at church the nickel he has saved in walking to worship. The saving grace is for his own pocket."

THE Metropolitan dummy lines at Atlanta, Ga., have passed back into the hands of the Consolidated.

AN IOWA paper relates the fall of a driver upon a detached electric truck, which dislocated his hip, and then dislocates his finer feelings by adding: "This is a severe blow to Mr. Murphy."

We should say it was.

THE QUICK AND THE DEAD.

TWO papers came to us by the same mail. One was from a well-to-do but decidedly slow town down in Massachusetts; the other from a smaller place but with big ideas, over in Indiana.

The Bay State paper, sailing under the refreshing title of the "Breeze," blows about the objections which should be raised to the invasion of the place by a proposed electric railway, and through its leaves come the mournful sound that "if we mistake not, a very loud protest will be heard by the legislative committee on street railways, against the right to build a street or electric railway through Magnolia and Manchester." The editor evidently labors under the fear that the new road would enhance the value of real estate and he will have to pay a dollar a month more rent for a place to store a few old type and his army press.

On the other hand the blue-jeans editor over in Hoop-pole county is glad he is alive and in a live town; and on the occasion of the christening of the electric road delivered himself thusly:—

"It is true that the motormen on street cars should be very watchful and cautious, and give people a chance for their lives. But the people must remember that we are in an age of rapid transit, and should likewise use extra precautions and quicken their pace, to conform to the idea of rapid transit."

Verily, the quick and the dead.

A CHANGE OF HEART.

THE California papers which only a year ago proclaimed destruction and disaster as a concomitant of the trolley, are beginning to chant a very different tune. One case will illustrate this change of heart. The Oakland, San Leandro & Haywards electric line, 13 miles in length, was fully described and illustrated in a recent REVIEW. The line has been in operation less than one year, but already several small towns have started along the route. San Leandro has developed from a ranch to a place of considerable importance, and Haywards has had a lively waking up, and is rapidly extending its limits. Only last June, when a REVIEW representative visited the power house at San Leandro, it stood alone. Now a long row of stores flank it on either side on land only recently devoted to farming, and concrete walks replace the beds of weeds and flowers which skirted the roadside.

In this connection the Oakland Tribune remarks:—"Electric railroads are proving to be wonderful factors in the development of all of Oakland's back country, but the territory traversed by the Haywards line is at present undergoing changes more marvelous than any other of Oakland's suburbs."

The possibilities of these interurban lines in all parts of the Union are as yet but little realized, and we predict the construction of country lines in the near future will be little less wonderful than the last three years in cities.

SCHEME TO RIDE WITH THE BIRDS.

WHEN the ordinary citizen has nothing to do of a Sunday afternoon, he generally thinks for half an hour, and hatches up a magnificent scheme for settling the vexed question of rapid transit. While poetry and criticism and letters from "vox populi" can be had at the sacrifice of a few sheets of virgin paper and, perhaps, a two-cent stamp.

Yet there be schemes and schemes. "One hundred feet in the ground" some one proposes, "through the buildings," cries his neighbor, "elevated roads with spurs," howls the man across the street, while just now "one hundred feet in the air," comes the cry of Edward Norton, the successful tin-ware manufacturer and merchant, of Chicago.

Mr. Norton would, in brief, build a series of suspension bridges from the high buildings, to run through the alleys in the congested portion of the city, to form a downtown terminal for the north, west and south surface roads and the two elevated structures, with huge elevators to lift and lower the crowds to and from the terminal points. It is designed to use the multiple speed and traction sidewalk, described by the REVIEW last year, but the manager of the sidewalk says no definite proposals have yet been received, and Mr. Norton, in an interview, stated that his scheme was considered by engineers to be feasible, and that, as to the company to push the construction, he would say nothing, leaving the interviewer to imagine some gigantic syndicate.

NEW BUILDINGS AT SCRANTON.

THE car house and engine room of the Scranton Pa., Traction Company, are now in process of erection and will be completed probably about March 1. The plans were drawn by J. H. Bickford, of Salem, Mass., which goes to show that the management of the Traction Company thinks the best none too good. The work is being done under the direct personal supervision of C. M. Knight, of Indianapolis.

The car house will be on the same lot with the power plant. The outside stone wall will be 114 feet 4 inches long, and 93 feet 4 inches wide. This barn will accommodate 60 cars. Between the car barn and the power house will be a driveway. The engine room will be 124 feet by 63 feet 8 inches, and will harbor a Corliss of 2,400-horse-power, made by the Dickson Manufacturing Company. Here will also be placed a vitrified brick switch board in a vulcanized hard pine frame, with lightning arresters and feeders. The boiler room will be 69 feet 8 inches by 68 feet, and will contain 3,000-horse-power boilers.

A store house will be built in the rear of the buildings. These premises are convenient to steam roads, and a permanent switch has been built to the seat of operations.

The citizens at Scranton owe much to the energy and good management of the Traction Company.

BLOWING OPEN THE GROUND.

ON the afternoon of November 16, 1892, at 1 o'clock, Dr. R. J. Brown, of Leavenworth, Kas., broke ground for the construction of the Pneumatic Street Railway line. The breezes of heaven crept into their holes while the air line made its debut. The gentle zephyrs were abashed and the rough north wind hid his face.

The enthusiastic promoters were in their element, and nothing remained but to put their element to work. Compressed air with expressed "nerve" would do many things for Leavenworth. It promises ten miles of street railway, ten factories, and tender care for each and all of the inhabitants of Leavenworth. It will be piped into their houses to cool them in summer and heat them in winter. It will rock the cradle and run the sewing machine—if it goes, and if it doesn't, the ghost of similar deceased enterprises will arise from Washington, New York, Pullman, Paris and Chicago and plaintively pipe "where air we at?"

There were present at the dedication: Harry L. Earle, wife and daughter, J. W. and Mrs. Crancer, Mr. and Mrs. Tuttle, of the Aetna Loan Company, Hon. John Hamon, Frank Hunt, J. C. Douglas, E. Jameson, Col. Graves, constructing engineer Henry Costello and others.

Mr. Earle made the speech of the occasion. It was promised that the rails would be laid as fast as the road-bed was prepared.

After this ten men shoveled for a day or two, digging a trench about two feet deep for one block, and laying a small iron pipe. Construction of the compressor plant has not yet begun. As chronicled from time to time in the REVIEW, the scheme from beginning down to the present time has given little promise of success, and now that the street railway people seem likely to at last secure their ordinance for electricity, the compressed air folks threaten to pull stakes and abandon Leavenworth and the \$250,000 bonus still in escrow.

BY CABLE UNDER EAST RIVER.

THE New York & Brooklyn Railway Company has applied to the New York board of aldermen for a franchise to construct a tunnel under the East river. It is proposed to build from a point near Park Row in New York to Myrtle avenue and Fulton street in Brooklyn. President Benjamin S. Henning said that the work could be completed in two years at a cost of from \$6,000,000 to \$12,000,000. The company's idea at present is to use cable traction. If the franchise is granted, borings will be made in the river bed and should it prove too difficult an undertaking the project will be abandoned. No difficulty is expected however. Geo. S. Morison, engineer of the Mississippi bridge at Memphis, has looked over the ground and will superintend the borings. The company has good financial backing and action of the two city councils is all that is now necessary.

A CONVENIENT CAR HOUSE.

THE attention which has been given to convenience in planning buildings for street railway uses affords a sharp contrast to what was considered "good enough" five years ago. Now, when a company erects a new building, provision is made for the comfort not only of officers but employes as well.

A very nicely planned building recently erected is that of the Watertown Street Railway, Watertown, N. Y.

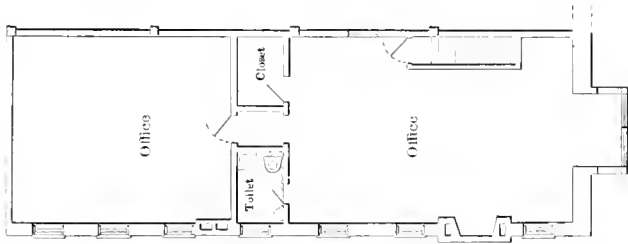

PLAN SECOND STORY.

The front is of stone, with stone turreted corner, and generous sized bay window on the second floor front. The remaining walls are of brick. Dimensions are 70 feet front by 152 deep. Two large entrances are for running in and out cars, and another admits to a vestibule 5 by 20 feet, opening into the public waiting room which is 15 by 20 feet, with a toilet room for gentlemen and another for ladies. To the rear of this is an attractive room for the conductors and drivers, 20 by 24 feet,

Returning to the vestibule, a handsome oak stairway leads to the second story, where are domiciled the officers of the road, in two rooms respectively 20 by 23 feet and 20 by 30 feet. Between the two rooms, are toilet rooms and a fire proof vault 5 by 7 feet. The



FRONT EXTERIOR VIEW.

building is a credit, not only to the company, to Hinds & Bond, the architects, but to the enterprising city of which the Watertown Street Railway is so important and popular an institution.

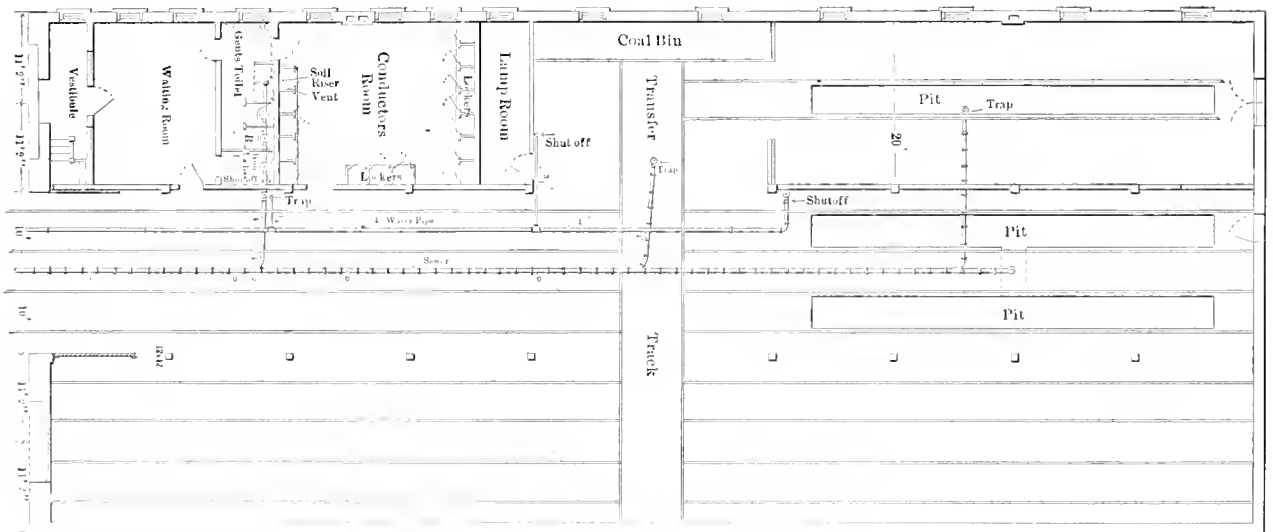

PLAN FIRST FLOOR WATERTOWN CAR HOUSE.

with individual lockers for each man, extending around three sides of the room, and large windows on the remaining side. Chairs, tables, and brushes for cleaning clothes and shoes are provided, together with the STREET RAILWAY REVIEW and other attractive reading matter. To the rear of this room is the lamp room, surrounded by fire proof walls. The balance of the ground floor is devoted to car storage, with a transfer table 30 feet long, located midway and running from one side to the other. Pits and wash rooms are conveniently and sufficiently supplied.

A GANG of Italian laborers, at Johnstown, New York, after working several weeks on the Cayadutta electric road and receiving no pay, held up Contractor Coffin with stilletos and pistols, demanding their wages. But for the arrival of citizens with clubs and bricks, Mr. Coffin might have needed one.

COMPLAINT comes from Calcutta of the miserable condition of the tramway tracks in that city. The rails are from three to five inches below the level of the street and are a constant menace to carriage travel.

STREET RAILWAY LAW.

EDITED BY MR. FRANK HUMBOLDT CLARK, ATTORNEY AT LAW, CHICAGO.

Defective Insulation of Wires of Electric Railway.

An electric street railway company is liable for injuries to a passenger who receives an electric shock from the handles of the dash-board of the car, which had become charged as the result of defective insulation of the wires conducting the motive power.

In the opinion the Court said: "The learned council for the defendant company made the point in his argument that the company had no notice or knowledge of the peril that a person, passing from one car to another in the manner that plaintiff attempted so to pass, might receive an electric shock. He argues therefrom that the company is not liable in this action. We think the point is not well taken. The company was chargeable with notice that the electrical apparatus on its cars was in a defective condition, for it appears that it had the means of readily ascertaining whether any electricity was escaping from the machine and works in the body of the car, and knowledge must be imputed to the company that if it escaped the iron handles of the platform were liable to become charged therewith. The only other question argued in the case is, whether the evidence conclusively proves that the attempt of plaintiff to pass from one car to the other when the cars were in motion, in the manner he did, was negligence on his part which contributed directly to the injury of which he complains, or, stated in another form, was it error for the trial court to submit the question of contributory negligence to the jury? The testimony tends to prove that the company had no rule prohibiting passengers from stepping from the platform of one car to the platform of the other when the cars were in motion, and had never given any caution against the practice; that before plaintiff was injured, passengers on those cars, among whom was the plaintiff, frequently did so without objection on the part of the company; and that the car conductors constantly passed from one car to another when the same were in motion, in the same manner. Moreover, while it may reasonably be claimed that there was some peril of being thrown from and under the cars, there was no apparent reason to apprehend, and the plaintiff did not apprehend, the presence of any peril that by so doing he would come in contact with a current of electricity. Under these circumstances we cannot say that contributory negligence on the part of the plaintiff was conclusively proved. Hence it was not error to submit that question to the jury."

(Sup. Ct. Wis. *Burt v. Douglas County & Ry. Co.* 8 N. Y. L. Jour. 488.)

Imputed Negligence—Injury to Person riding in Wagon Negligence of Driver of Wagon.

If the plaintiff herself was free from negligence, and her injury was due to the concurrent negligence of the railroad company and the person with whom she was riding in a wagon, he not being her servant, and it not appearing that she was the owner of the horse or wagon, or that she had any agency or concern in procuring or

driving the same, and nothing appearing which tends to show that she was aware of any incompetency in the driver, the company is liable to her for all the damages consequent upon the injury, and can take no credit as to any part thereof on account of the contributory negligence of the driver of the wagon.

(Sup. Ct. Ga. *Metropolitan St. Ry. Co. v. Powell*. 16 S. E. Rep. 118.)

Riding on Platform of Electric Car—Contributory Negligence.

In this case the plaintiff was riding on the front platform of an electric car, and was thrown to the ground in consequence of the car running off the track. The accident was primarily due to a defective and worn-out switch. The case was tried in the Superior Court, and the question of negligence was left to the jury. In charging the jury the Court said: "In one respect this case presents a novelty. The Court has decided that if a passenger voluntarily and unnecessarily rides on the platform of a steam car and there gets hurt, he cannot recover, because the very fact that he undertakes to ride on the platform when the car is in motion instead of riding on a seat within the car, when he might do so, is held to be an act of carelessness on his part, which will prevent him from recovering damages for an injury sustained by him while so riding on the platform; but the Court has also decided that it is not necessarily negligent for a passenger to ride on the platform of a horse-car in motion.

"The reason for the distinction is this: the steam car is propelled or driven by a great force, the tremendous power of steam, and is or may be driven at a very high rate of speed, and the danger attending the employment of great power, great forces and moving at great speed, is greater than when the vehicle in which we are riding is drawn or propelled by horse power at a less speed, and therefore in this case the place in which the passenger rides is conclusive as to the want of care, and in the other it is a mere question of fact, to be decided by the jury in each case. It is the extraordinary force of the propelling power of the steam car that is decisive.

"The car in this case was not a horse car; it was propelled by electricity. If electricity is a force that may drive the car at a speed equal to that of the steam car, then there would be attending the employment of this force the same dangers that might attend the employment of steam, and whether you drive your car by electricity at a high speed, or by steam at a high speed, would not make the difference between danger and safety; but it is the fact of the force, and the rapidity with which the car is driven."

The jury found that the plaintiff was guilty of negligence, and returned a verdict for the defendant. The instructions of the Court below are held correct.

(Sup. Jud. Ct. Mass. *Beal v. Lowell & Gracut St. Ry. Co.*; not yet reported.)

Personal Injury by being struck by Grip car—Negligence of Driver in failing to stop Car—Insufficient Evidence.

In an action for damages caused by collision with a street grip-car, on the theory that defendant's grip-man could have stopped the car in time to avert the injury after he saw, or by the exercise of reasonable diligence could have seen, the perilous position of plaintiff. Where there is no evidence as to the space within which the car could have been stopped, nor as to the distance of plaintiff from the car when his peril could first have been observed, it is error to submit the case to the jury.

(App. Ct. Mo. Turluh v. People's Ry. Co. 46 Mo. App. 636.)

Boy riding on Car at invitation of Motor-man—Liability of Company for Injuries.

Plaintiff, a boy eight years old, after opening a switch of an electric street railroad as a service to the motor-man, was in return invited and allowed by the motor-man to ride on the car, against the prohibition of the defendant company. In getting on the car, which was moving slowly, plaintiff slipped, and the car passed over his legs. Held, that the motor-man went beyond the scope of his authority; that defendant owed no duty to plaintiff as a passenger, and that he was not entitled to recover for the injury.

(Sup. Ct. N. Y. Finley v. Hudson Electric R. Co. 19 N. Y. Supp. 621.)

(NOTE.—A contrary decision was rendered by the Supreme Court of Missouri in the case of Buck vs. People's St. R. Co., 18 S. W. Rep. 1090, in which it is stated that when a small boy becomes a free passenger on a street-car by consent of the driver in charge, the Company is bound to exercise towards him the same care as towards other passengers.—Ed.)

Street-car Having intoxicated Driver—Evidence—Injury to Pedestrian.

In an action against a street railroad for injuries sustained by being struck by a car, in consequence of the driver's negligence and intoxication, evidence that the driver had on that same trip missed a switch at a certain street, that he had failed to respond to the conductor's signal to stop at another street, had driven rapidly, and that a person had been thrown down in attempting to get aboard, is admissible as showing a series of acts indicative of such intoxication at the time of the accident as to incapacitate him for the proper control of the car. The fact that the driver had had drink just before starting on the trip, was admissible as bearing on his condition at the time of the accident.

(Ct. Com. Pls. N. Y. Pyne v. Broadway & Seventh Av. R. Co. 19 N. Y. Supp. 217.)

Improvement of Streets—Agreement by Street Railway Company—Contract let by City.

Where a city caused to be awarded to contractors a contract to pave with gravel a street on which the tracks of a street railway company were located, and which under a contract previously made between the city and the street railway the company was bound to plank, and the company submits to the city a proposition to pay part

of the cost of graveling the street in lieu of its planking contract, which proposition is acted upon. The city cannot maintain a suit to compel the company to plank the street, without having rescinded its action in awarding the subsequent contract to have the street gravelled.

(Sup. Ct. La. State v. St. Charles St. R. Co. 10 So. Rep. 927.)

Powers of City Council—Granting Franchise to Lay Track in Narrow Street.

The grant of a right to lay a street railway in a street where the driveway is so narrow that but 8 feet 7½ inches will be left on each side of a street car for the passage of teams, is not beyond the power of a city council.

(Sup. Ct. Mich. People v. Ft. Wayne & E. R. Co. 52 N. W. Rep. 1010.)

Abutting Property Owner—Rights in Street—Damage by Street Railway—Space for Market Wagons.

The interest of an abutting owner in the continuance of a market in the street is not one of his incidental rights in the street which can be impaired by the construction therein of a street railway, causing the market wagons to remove elsewhere.

A double track street railway is not an interference with the right of access of an abutting owner because there is not sufficient space between the rails and curb to permit teams to stand at right angles to the street.

(Ct. Com. Pls. Ohio. Sells v. Columbus St. R. Co. 28 Ohio L. J. 172.)

Passenger Standing on Car Step—Injury by Passing Car—Defective Condition of Tracks.

A passenger upon a street car is not guilty of negligence contributing to his injury by being struck by another car going in an opposite direction, owing to the fact that the tracks were too near each other for safety, and that the inner rails were depressed so that the upper portion of the cars were tilted towards each other, in standing upon the outer rail or step, where that is the only apparently unoccupied place when the car stops to take him up, and he is ignorant of the condition of the tracks.

(Sup. Ct. N. Y. Herdt v. Rochester City & B. R. Co. 20 N. Y. Supp. 346.)

Ordinance Granting Franchise—Conditions—Payment of Percentage of Gross Earnings.

A cable street railway company authorized by ordinance to operate a certain route within a city on condition of paying a percentage of its gross earnings from all sources, must pay such percentage upon the earnings from an extension of its line in an adjoining village, where such extension is operated by the same cable as the city line from an engine within the city, since the earnings are directly dependent upon the franchise granted by the city.

Earnings from rentals of the privilege of advertising in the cars are within the conditions of such ordinance.

(Cin. Super Ct. Cincinnati v. Mt. Auburn Cable R. Co. 28 Ohio L. J. 276.)

IMPROVED TAYLOR ELECTRIC TRUCK.

THE Taylor Electric Truck is designed purely in the light of modern electric traction, and is an attempt to get rid of all of the old fallacious ideas inherited from horse-car days, and working great injury to electric service, as it is at present. The makers claim that this truck eliminates the "galloping," or end-tilting, so frequent on electric roads. The main frame of the truck is a rectangle of wrought iron bars, strengthened in the center by two more bars which serve to support the end of the motor. On the side bars of this frame are bolted the jaws for holding the journal boxes. These jaws are also supported by angle irons and by rods running from one box to the other. It will be seen from the cut that while the boxes are held firmly they are allowed vertical play. The weight of car and truck frame is supported by half elliptical springs, resting on the boxes and fastened to side bars of the truck. The car body itself rests on the elliptical springs, as shown in the cut, and, instead of being fastened to the body bolster on top of the springs, the car body is held down by two king bolts.

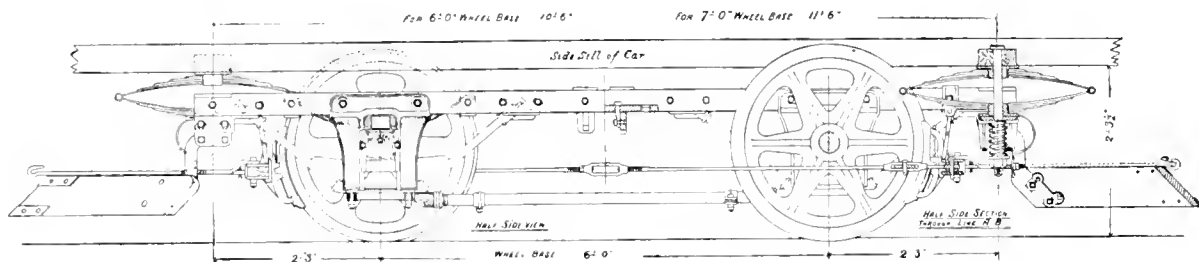

These king bolts are kept tight by a coiled spring, which is designed to prevent the end-tilting of the car. The truck can be removed from the car by taking out the king bolts, and the wheels and journals removed by taking out only the bottom braces to the pedestals.

One of the special features of this truck is the brake, the shoe of which adjusts itself to the wheel periphery however the car may be loaded, securing an even wear. The brake shoe is a separate part, and can be renewed when worn very thin, thereby saving metal and expense. The releasing springs are adjustable, so that the shoes can be set at equal distances from the wheels. It is claimed that the brake shoes when worn out weigh only 3 1/4 pounds.

The truck forms a complete and rigid unit in itself and is fastened to the car body in a substantial manner. The Taylor truck has been well received by managers and are giving satisfactory service on the already large number of roads which have adopted them. They are manufactured by the Taylor Electric Truck Company, Troy, N. Y.

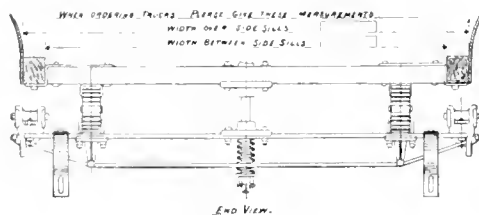

TAYLOR TRUCK.

INSULATION OF COILS.

THE greatest objection to the use of electrical machinery up to the present time has been its liability to burn out. No class of users has felt this more strongly than street railroad men. Owing to the hard usage of generators and motors in such work "burn-outs" are uncomfortably frequent, and introduce an element of uncertainty both in the service and in the repair bills, that is never pleasant to contemplate. "Burn-outs" are not, by any means, as frequent as formerly, because more care is taken in the construction of coils; nor are they as expensive, because railway apparatus is now universally made so as to admit the re-winding of one coil or section without disturbing others.

At the December 21 meeting of the Institute of Electrical Engineers, New York, a paper was presented on "Micanite and its Application to Armature Insulation." by C. W. Jefferson and A. H. S. Dyer. The following abstract will be read with interest by all railway electricians. Judging from the apparatus in use to-day there has been very little progress in the line of heat-proof

insulation for coils, but this paper shows that effort has not been wanting in that direction, and the amount of work done and number of materials tried will surprise those who have not known the inner workings of our great factory laboratories.

The paper states first, that the difficulty of armature insulation lies in the fact that while the insulating material must take up very little space it must at the same time be able to withstand high pressure, and at times, great heat. Besides this, it must be firm. Though many devices have been used to cool the armature, there will always be times when the machine becomes abnormally hot. If the insulation is combustible, it will become charred in time. Shellac is the only available substance that does not have its resistance lowered by charring. Even shellac, however, has its rigidity impaired by heat, and loss of solidity is even worse than lowering of insulation. Iron rust has proved a fairly good insulator for iron disks. Shellaced glass is barred by mechanical reasons. The introduction of mica probably came from its use as a temporary insulator. It is used universally between commu-

tator segments. Mica is a good insulator, besides being heat-proof. There are many varieties of mica differing in chemical constitution. Another advantage of mica is its even laminated structure. The trouble with natural mica is that it breaks when twisted. Large sheets are also very expensive. Water can enter between the layers. It is easily injured by splitting during handling. It can



MICANITE TUBE FOR INSULATING CORE PROJECTIONS.

not be neatly cut. Comminuted or pulverized mica held together with cement has been tried. This is practically a cement insulator, as the current can leak around between the particles of mica without touching them. Comminuted mica cement made of a mixture of powdered mica, asbestos, sodium silicate and sulphur compounds is good for trolley wire hangers, but will melt and run when subjected to armature heat.

Pieces of micanite were then exhibited as the authors' solution of the problem. Three of them are shown in our engravings. The authors stated that they were practically all mica, being made of thin sheets cemented together by a cement adapted to the purpose for which



MICANITE TUBE.

the micanite is to be used. Plates can be made of any size or thickness. In the manufacture scrap mica is first split up into pieces. These are then laid together by machinery, with the edges overlapping. After the cement is applied pressure is used, so that the cement actually remaining in a piece is very small, almost infinitesimal. Micanite is superior to natural sheet mica in that it can be cut, has more tenacity between the layers, and will not absorb moisture. It is also very much less costly and much stronger, and can be moulded in any shape. In making a comparative test with ground mica and shel-



MICANITE ARMATURE SLOT INSULATOR.

lac, the mica and shellac softened after remaining on the steam table a minute, while the micanite remained so solid after five minutes that it was able to flatten a piece of copper wire against which it was compressed, being only slightly crumpled where the wire pressed against it. Micanite can be used for anything from a dynamo bed plate or armature head to a single wire insulator on an armature. Insulation tests show that its insulation is practically the same as that of mica. Plates of micanite can be split with a thin knife. This substance has such metal-like qualities that it can almost be called "insulating metal." Being made of scrap mica, an increase in size does not enormously increase the cost, as with the natural plate.

RAPID TRANSIT DIFFICULTIES.

RAPID transit in New York has become synonymous with underground railroading. This is unfortunate for the great object to be attained, as well as for the most practical exponents of rapid transit, the cable and the trolley. The New York scheme, proposed by seemingly intelligent men, and endorsed by really reputable engineers, has one difficulty that all the "perfumes of Araby" can not make sweet to the capitalist who has the dollars. It is an unfortunate thing that the only people in this world who are contented with glory and the good of human kind are newspaper men. From the pulpit to the plow all, except this class, are looking for increase on energy and capital expended. It is this difficulty of dividends that is harassing the great tunnel scheme in New York. The capitalist finds the following objections: First, the bonded indebtedness of the company is limited to \$50,000,000. The question is, What are these bonds worth? No one knows until the road is built what they are worth, or what the road will cost. Guesses make the cost from forty to one hundred million of dollars. With this uncertainty the bonds cannot sell at par. As a bonus for buying these bonds the banks would probably demand an equal amount of stock to the bonds subscribed for.

Now the stocks having been given away to sell the bonds they would produce no money for the company. This, however, can not be done by the terms of the subscription. It is contemplated that this stock shall go at par, and 5 per cent, or \$2,500,000, must be paid in at the time of subscription. And each stockholder is individually liable to the creditors of the corporation to full amount unpaid on the stock for all debts and liabilities. These provisions defeat the scheme more thoroughly than the original proposition. Taking the bonds at 70, with stock thrown in, the entire amount available to build the road is but \$35,000,000. Besides, the road must be built under the supervision and control of the board. This will add 15 per cent to the expenses.

The only salvation for the scheme, in the mind of the REVIEW, is that the board be compelled to take half the stock. This would probably kill the scheme extremely dead and give a few practical men a chance to give New York what it needs—rapid transit.

A CONDUCTOR on one of the Accelerator cars on the North Side cable line in Chicago, recently said: "I would rather work 16 hours on one of these cars than 12 hours on one of the old cars. It is so much easier and I am relieved of the constant quarreling with the passengers in my efforts to keep a passage way over the platform so persons can get in and out of the car. I can also handle 120 people on one of these cars easier than I can 60 on one of the old style. It is the best car I ever saw to work on, and all the conductors like them." This is quite a compliment to the Brownell Car Company, who built the cars, and it shows commendation from a source well worthy of consideration.

TELEGRAPH AVENUE ELECTRIC LINE, OAKLAND.

THE Telegraph avenue line began traffic the first of the year. The electrical equipment is Thomson-Houston throughout, and the installation has been made under the charge of A. L. Abell. To "begin at the beginning" the coal is thrown onto rocking grates under Babcock & Wilcox water tube boilers. Three compound condensing engines of the Lake Erie Engineering

HANDSOME DEPOTS OF THE LINDELL LINE.

THE Lindell Railway Company, operating an electric in the above suburb of St. Louis, furnishes examples of enterprising effort to create traffic that are worthy of rich reward. The first of these enterprises was the pavilion at Forest Park, known as the Lindell Railway Pavilion, and situated at the end of their Washington Avenue line. The park is about ten years

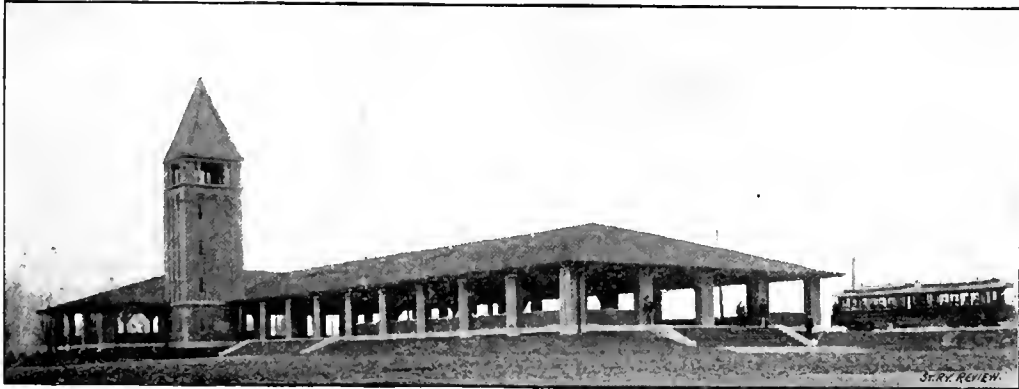

LINDELL RAILWAY PAVILION, FOREST PARK.

Works are belted direct to 120 horse-power multipolar generators. The cars are supplied with two fifteen horse-power motors. Thirteen cars are closed the remaining seven are open. The motorman is protected by a vestibule. Headlights are on top of cars. Light will be plenty inside the cars and at the station. Each car has seven 32 candle-power incandescents and the powerhouse 120 "sixteens." Cars are fitted with ratchet lever

old, and up to last year no street car lines entered the park, and no shelter was provided for the public. President Geo. Capen, of the Lindell Railway, initiated the idea of running into the park, and a franchise was granted on condition that the company erect within ten years a \$25,000 pavilion. The building erected last year is shown in the engraving, and is 200 feet long by 60 wide, having a floor space of 15,000 square feet. The clock

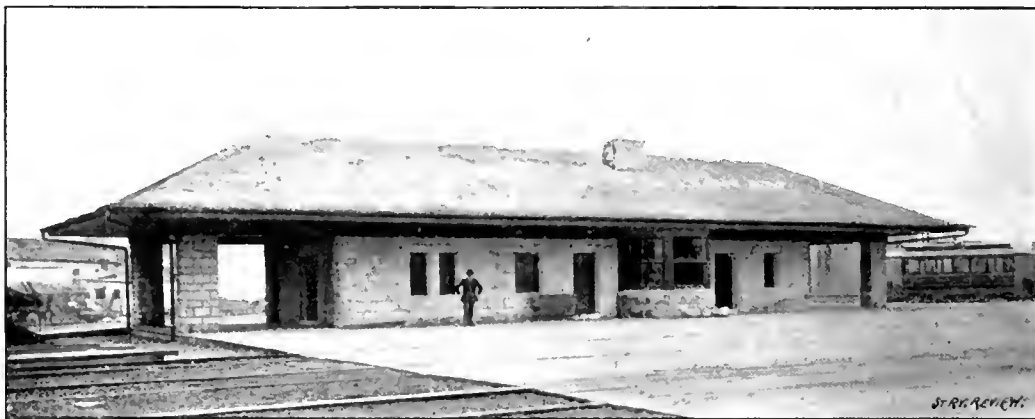

LINDELL PASSENGER DEPOT AT MISSOURI PACIFIC R. R.

brakes. Eight miles an hour is to be the speed in the city and twelve miles an hour outside. The power house is built with a view to enlargement when the Twelfth street extension is built. At present it is counted that two of the three power units at the station will be enough to operate sixteen cars. Engineer A. Goodrich has charge of the station.

tower furnishes an observatory affording a good view of the park. The building is of white cut stone and yellow brick, being finished with yellow pine, lighted with electricity and furnished with janitor service.

Another undertaking was the erection of the Missouri Pacific Passenger Depot at the end of its Vandeventer Avenue line. This handsome building was built entirely

at the expense of the Lindell Railway Company, and turned over to the use of the Missouri Pacific Railroad. This road has the great bulk of the St. Louis-Kansas City travel, and heretofore the Lindell people have had to go two miles down town to the Union Depot before they could get a train or leave one. Since the recent opening of this new depot all passenger trains stop at Lindell. The traveler can then go to almost any part of

WHAT A GOOD NAME DID.

THE death of a noted man always brings to light many forgotten or unknown glimpses of his character, and the death of Dr. Siemens and Jay Gould, within so short a period, lend unusual interest to the following, which we find in the Electrical Review.

Jay Gould wanted a cable to be laid upon the bed of the Atlantic ocean. He wanted to own one; why or wherefore it matters not; he wanted to possess a cable and that was sufficient. With this in view he telegraphed to the agent of the celebrated firm of Siemens & Halske, in New York, saying he wished to see him. (Millionaires don't write letters when they own telegraph companies, they telegraph.) The agent very promptly presented himself at Mr. Gould's office and was requested to be seated. Awed in the presence of the great little man, he obeyed. Suddenly Mr. Gould turned toward the agent and said:

"You are the agent of Siemens & Halske, of Berlin? I want a cable laid across the Atlantic ocean, and I want Siemens & Halske to make it. Have it ready as soon as possible, please."

When the agent had recovered from the shock, he managed to find breath to say:

"Very well, Mr. Gould, we will be pleased to take your order. I shall cable to the firm and have the plans ready for you in a short time."

Mr. Gould turned his bright little eyes on the agent and said:

"My dear man, I didn't ask for any plans. What I want is a cable. Oh! I see, I beg your pardon." Whereupon Mr. Gould pressed a button and a clerk appeared.

"Mr. B —, just write out a check for \$100,000 to the order of Siemens & Halske, of Berlin, and give it to this gentleman. I suppose that will be enough to start with. Come in at the end of a week and let me know how the work is progressing. Good morning."

At the end of a week the agent again presented himself at the office.

"Mr. Gould, our engineers would be pleased to call upon you at your earliest convenience. They are prepared to submit their figures to you."

"My dear sir," protested Mr. Gould, "I told you before I didn't want any plans or figures. I know Dr. Siemens. I know the firm of Siemens & Halske, and I am sure that whatever the doctor undertakes he does thoroughly and to the best of his ability. I don't care about the price, go ahead and make the cable and bring the bill to me. But, perhaps,"—and again did Mr. Gould push the button, and again was a check for \$100,000, payable to the order of Siemens & Halske, put into the hands of the astonished agent.

In quick time the cable was finished and laid, and is at the present day one of the best and most serviceable under the Atlantic ocean.

Such was the handsome tribute paid to Werner Siemens by Jay Gould.



LINDELL PASSENGER DEPOT, FOREST PARK.

the city over the street lines, instead of going up to the crowded Union Depot, only to come back several miles. Eames and Young, of St. Louis, were the architects of both the pavilion and railroad depot, and a glance at the engravings will show the substantial excellence of the



work. The same firm are just starting to build a \$30,000 depot for the Forest Park, Laclede Avenue and Fourth Street Railway, a sketch of which, as when completed, is shown in the cut.

THE RETURNS ALL IN.

AT the Cleveland convention, Jos. E. Lockwood, secretary of the Detroit Electrical Works, presided over a meeting of supplymen, who convened to discuss the advisability of an auxiliary organization. The committee then appointed to confer with the executive committee were unable to secure a report before the convention adjourned, and now report as follows:

MR. JOS. E. LOCKWOOD, Chairman:

DEAR SIR—The undersigned Committee appointed by you to confer with the Executive Committee of the American Street Railway Association, beg to submit the following report: That a majority of the Committee waited upon the Executive Committee of the American Street Railway Association, at their headquarters at the Hollenden Hotel, and briefly stated the case, as the time had then arrived for the convening of the Association, and wanted to settle the matter definitely for the present. It was moved by Mr. Lang of the Executive Committee, and unanimously carried, that it was the sense of the Executive Committee that the association of supply men, such as was contemplated, was not necessary at the present time.

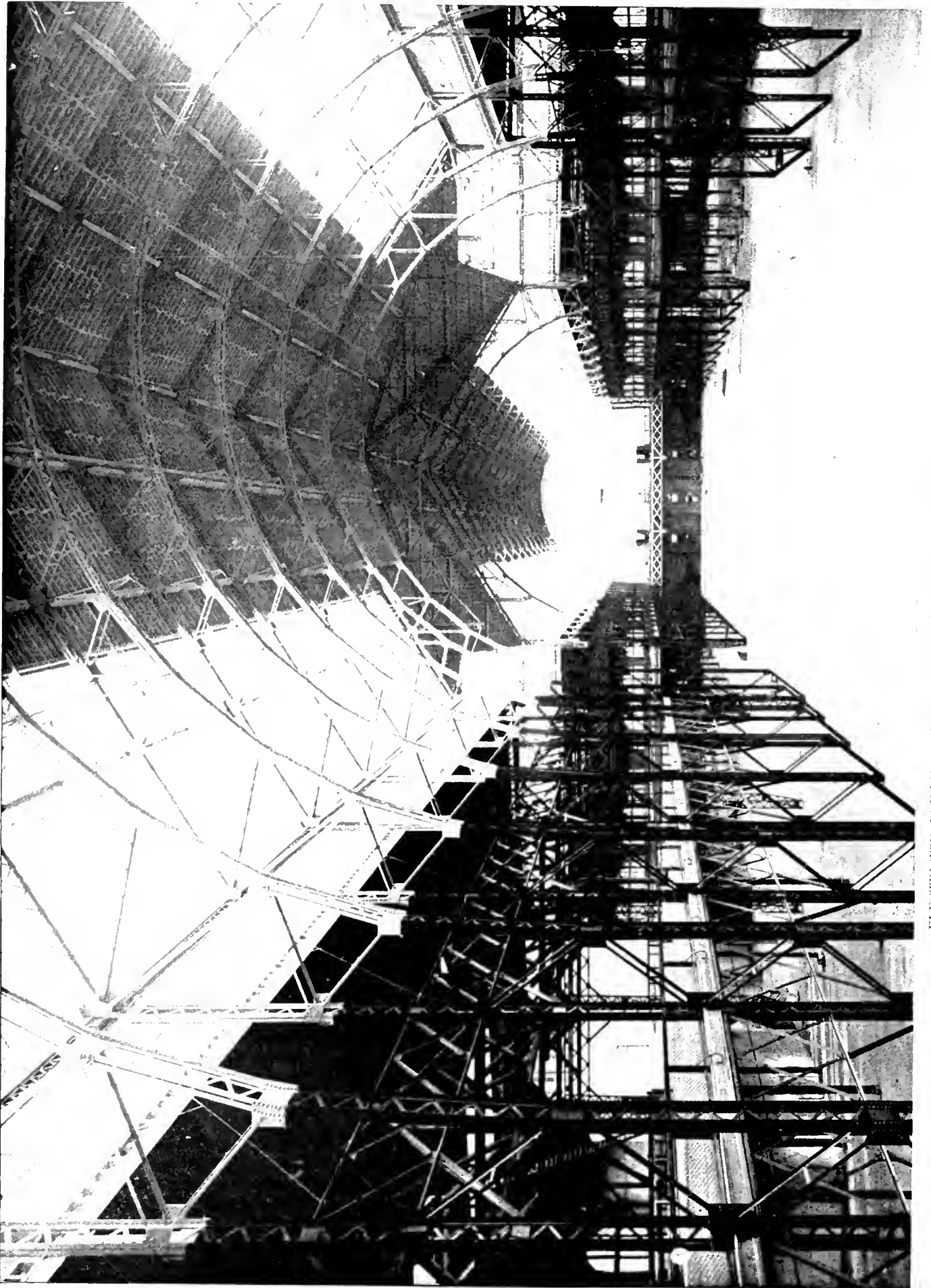

ELECTRICITY BUILDING.—MAIN HALL.—700 FEET LONG, 340 FEET WIDE.

CAUGHT ON THE RUSH TRIP.

American Street Railway Association.

D. F. LONGSTREET, PRESIDENT, Denver, Col.
 DR. A. EVERETT, FIRST VICE-PRESIDENT, Cleveland, O.
 JOEL HURT, SECOND VICE-PRESIDENT, Atlanta, Ga.
 W. WORTH BEAN, THIRD VICE-PRESIDENT, St. Joseph, Mich.
 WM. J. RICHARDSON, SECRETARY AND TREASURER, Brooklyn, N. Y.
 EXECUTIVE COMMITTEE—THE PRESIDENT, VICE-PRESIDENTS, and JOHN G. HOLMES, Pittsburg, Pa.; J. D. CRIMMINS, New York City; THOS. MINARY, Louisville, Ky.; JAS. R. CHAPMAN, Grand Rapids, Mich., and BENJ. E. CHARLTON-HAMILTON, Ont.
 Next meeting, Exposition Building, Milwaukee, third Wednesday in October.

Massachusetts Street Railway Association.

President, CHARLES B. PRATT, Salem; Vice-presidents, H. M. WHITNEY, Boston, AMOS F. BREED, Lynn, FRANK S. STEVENS; Secretary and Treasurer, J. H. EATON, Lawrence.
 Meets first Wednesday of each month.

Ohio State Tramway Association.

President A. E. LANG, Toledo; Vice-president, W. J. KELLY, Columbus; Secretary and Treasurer, J. B. HANNA, Cleveland; Chairman Executive Committee, W. A. LYNCH, Canton, O.
 Meets at Cincinnati on the fourth Wednesday in September, 1893.

The Street Railway Association of the State of New Jersey.

President, JOHN H. BONN, Hoboken; Vice-president, THOS. C. BARR, Newark. Secretary and Treasurer, CHARLES Y. BAMFORD, Trenton; Executive Committee, OFFICERS and C. B. THURSTON, Jersey City; H. ROMAINE, Paterson; LEWIS PERLINE, JR., Trenton.

The Street Railway Association of the State of New York.

C. DENSMORE WYMAN, PRESIDENT, New York.
 D. B. HASBROUCK, FIRST VICE-PRESIDENT, New York.
 JAS. A. POWERS, SECOND VICE-PRESIDENT, Glen Falls.
 W. J. RICHARDSON, SECRETARY AND TREASURER, Brooklyn.
 EXECUTIVE COMMITTEE.—D. F. LEWIS, Brooklyn; JOHN N. BECKLEY, Rochester, J. W. McNAMARA, Albany.
 The next meeting will be held at Rochester, September 19, 1893.

Pennsylvania Street Railway Association.

JOHN A. COYLE, PRESIDENT, Lancaster.
 JOHN G. HOLMES, VICE PRESIDENT, Pittsburg.
 H. R. RHODES, SECOND VICE-PRESIDENT, Williamsport.
 L. B. REIFSNEIDER, SECRETARY, Altoona.
 WM. H. LANIONS, TREASURER, York.
 Next meeting ———.

Arizona.

PHOENIX, ARIZ.—H. L. Wharton has been granted franchise for one and one-half miles of electric railway before March 7, 1893; Joseph Campbell, mayor.

TEMPE, ARIZ.—The electric line, which T. W. Hine, of Phoenix, has promoted, will be built, passing through this city and extending to Phoenix and Mesa. Completion is promised in six months.

Arkansas.

HOT SPRINGS, ARK.—An ordinance is in process giving the Hot Springs Company electric rights and some extension of privileges.

California.

COLTON, CAL.—The electric to connect Rialto, San Bernardino, Bloomington, Riverside and Colton, it is said, will be pushed rapidly next spring.

NEVADA CITY, CAL.—Peter Tautphaus, president Providence Mining Company, heads a scheme to build an electric to Grass Valley.

OAKLAND, CAL.—S. and W. Meek, W. E. Meek, W. J. Sanders ask franchise for an electric.

THE Council will compel E. C. Sessions to erect iron instead of wooden poles.

OAKLAND, CAL.—The old Metz line charter to Alameda has been changed to allow electric.

OAKLAND, CAL.—The branch of the Berkeley electric down Thirteenth street is to be in operation February 1.

OAKLAND, CAL.—The Highland Park & Fruitvale Railroad has secured the passage of its ordinance granting valuable street rights in this city. E. C. Sessions is president.

OAKLAND, CAL.—Mayor Chapman has signed the ordinance giving the Oakland Railroad Company permit to substitute electricity for horses. Road owned by Pacific Improvement Company. J. Y. Loring, superintendent.

SANTA ANNA, CAL.—M. J. Bundy has been granted right-of-way to Garden Grove, Westminster and the Beach. The road will be commenced soon.

SAN FRANCISCO, CAL.—The Fowler & Durand, and the West Shore franchises have been passed by council.

SANTA ROSA, CAL.—John Wharton Morris, of Oakland, asks for electric rights. Road to begin building in six months.

Chicago.

CHICAGO.—The Cicero & Proviso will extend a new line to Maywood. Company will bridge the Desplaines river.

ORGANIZED: The World's Fair Rapid Transit Company; capital stock, \$150,000; incorporator, W. H. Murdock.

CHICAGO.—South Side Urban Rapid Transit Company, capital \$500,000; incorporators, G. H. Smith, J. Meredith Davis and Lafayette, Kirkpatrick.

CHICAGO.—Organized: The Chicago General Street Railway Company; capital stock, \$3,000,000; incorporators, Lyman M. Paine, H. L. Burnette and Chas. L. Hull.

CHICAGO.—The Great Western Electric Company will at present say nothing about the reported change of base to Duluth. Manager says it is only an idea for discussion, but will not deny.

CHICAGO.—The Globe Storage Battery Company, organized at \$1,000,000; J. H. Wheeler, S. Kapig and L. Dumas, H. C. Porter, secretary, Des Moines, Ia. Traction and other purposes.

CHICAGO.—The Chicago, Lake View & Suburban Railroad Company, organized at \$500,000 to construct electric from Chicago to Waukegan. William J. McGarigle, Henry Jampolis, John McKeough Henry Southworth and J. G. Jenking are the incorporators.

CHICAGO.—The Chicago & Calumet Valley Railroad incorporate to build in southern part of city, through Lyons, Worth, Palos and Lamonte. Capital, \$500,000. Board of Directors are: John G. Campbell, John Barton Payne, Henry S. Ritter, Wm. Brace and Cornelius V. Smith, all of Chicago.

CHICAGO.—Organized: The Chicago Suburban Transit Company, Chicago, capital stock, \$1,000,000; incorporators, Andrew Christ Thorbjornson and William W. Riley. Organized: The Chicago Street Air Brake Company, Chicago; capital stock, \$200,000; incorporators, John A. Kruse, James Hanley and David Reed.

Colorado.

DENVER, COLO.—The Denver and Globeville Street Railway incorporated at \$10,000; R. G. Head, J. H. Head, W. S. Rencan; horse line.

DENVER, COL.—The Standard Railway Supply Company, Monadnock building, Chicago, has sold the Tramway company stoves for their suburban trains.

DENVER, COL.—Otto Mears, president "Rainbow Route" of the Rio Grande, has returned from the East, where money was raised to build the Ouray electric; eight miles long. Will carry freight also.

DENVER, COL.—The Denver, Mt. Olive & Golden Railway Company incorporated to build from Golden; capital stock, \$125,000. Office at Denver; incorporators, Charles E. Tallmadge and Daniel Sayer, of Denver, and Ira Coulehan, Charles Fisk and Elwood Easley, of Jefferson county.

DENVER, COL.—Denver & Westminster Railway Company organized; capital, \$1,000,000. D. R. C. Brown, the Aspen millionaire; J. W. Downing, of Aspen, R. W. Woodbury, of the Union National Bank, Mitchell Benedict and H. J. Mayham are in the directory. Line to be electric, five miles long.

TRINIDAD, COL.—Council has revoked old franchise. Best chance in the state to organize a railway; 8,000 people.

TRINIDAD, COL.—A proposition for electric in place of horse car has been presented by the Mountain Electric Company, of Denver.

Connecticut.

ANSONIA, CONN.—The Birmingham & Ansonia Horse Railway asks large extensions and right for increase capital stock to \$150,000.

BRIDGEPORT, CONN.—The East End Railway Company asks franchises on new streets and extensions on old ones.

HARTFORD, CONN.—Ralph and Frank Cheney will incorporate the South Manchester Light, Power & Tramway Company. Said to be a go.

HARTFORD, CONN.—An electric is being agitated to run to Rockville. State Treasurer E. S. Henry, Col. F. J. Maxwell and W. H. Preseatt are leading promoters.

NEW HAVEN, CONN.—Henry Sutton and Chas. K. Bush, of Orange will petition the legislature for incorporation to build an electric from this city to Derby, and on various streets in the two places.

NORWALK, CONN.—The Tramway Company will ask of next Legislature right to run through the towns of Norwalk, Darien, Stamford, New Canaan, Westport, the city of South Norwalk, the borough of Norwalk, the borough of Stamford and borough of New Canaan.

MOODUS, CONN.—Charter is to be asked for the Moodus, Marlborough & Glastonbury Electric. Power to be supplied from Leesville.

STONINGTON, CONN.—Notice is given that a petition will be made in next legislature for a charter for an electric line here.

WALLINGFORD, CONN.—The Wallingford Electric Tramway Light & Power Company organized by prominent home men: Rev. Father Mallon, II. F. Hall, W. D. Wilson, et al. Scheme considered sure and prospects for patronage good.

District of Columbia.

WASHINGTON, D. C.—Bill introduced to incorporate the East End Electric to run within the city. Stock 250,000; incorporators: William Lee White, George J. Seufferle, John E. Herrell, Charles Barker, Albert Carry, George W. Moss, Isaac Childs, Thomas J. Brown, John D. Croissant, John F. O'Neill, John H. Oberly, A. S. Lindsay, John L. Vogt, R. S. Saunders, Francis A. Kennedy, E. E. White, Samuel Cross, R. Lee White and M. D. Brainard of the District of Columbia and R. R. Glover of Kentucky.

Also introduced, a bill to incorporate the Washington & Marlboro Electric Railway. Incorporators are James G. Berrett, Charles E. Creecy, William I. Hill, Robert A. Howard, George J. Johnson, John A. Luttrell, Chas. C. Lancaster, James T. Perkins, Archibald M. Bliss and John W. Belt and their associates.

Florida.

TAMPA, FLA.—The Consumer's Electric Light & Power Company is ready to lay track on certain streets and establish service, but are waiting for bonus.

Georgia.

ATLANTA, GA.—F. I. Stone has secured the contract to build and equip 7 miles of electric railway here. Will also build and equip the power station.

AUGUSTA, GA.—North Augusta, Langley, Graniteville and Aiken are to be connected with an electric. Maj. W. T. Gary has taken the franchise before the legislature.

Idaho.

POCATELLO, IDA.—A. A. Courter, L. S. Keller and W. J. Scott have applied for electric franchise. As another company is bidding, the scheme seems assured.

Illinois.

ALTON, ILL.—Eastern stockholders of the C. B. & Q. have bought the street railway here, and will extend and electrify. A. M. Farnum, Windsor, Vt., is chief promotor.

BLOOMINGTON, ILL.—The Bloomington City Railway, after a big fight, have been granted an ordinance by the City Council to lay T rails on all its lines. The company will build some extensions in the spring.

GALESBURG, ILL.—The Galesburg Electric Power & Motor Company has elected officers as follows: President, W. Secord; secretary, H. F. Arnold, and superintendent, Wm. Wise; \$80,000 has been expended on the system.

OTTAWA, ILL.—W. Y. Soper proposes to unite the City Passenger and the Electric, and issue transfers with franchise for thirty years.

PEKIN, ILL.—W. L. Prettyman is obtaining right of way for his line.

PEKIN, ILL.—Pekin Rapid Transit Company, organized; capital stock, \$100,000; electric; W. L. Prettyman, J. J. Reed and Chas. Karchen.

PEORIA, ILL.—The Averyville trustees have given right-of-way to the Peoria Heights Railway. Theo. J. Miller, of this place, and C. W. Constantine, of Springfield, O., are heavily interested.

UTICA, ILL.—The General Electric and Chicago has already completed its survey for an electric to the clay beds. Line used for freight.

Indiana.

BRAZIL, IND.—Officers are elected Rapid Transit Railway here: Geo. Van Ginkel, president and treasurer; J. D. Sourwine, vice-president; R. I. Baylers, secretary.

BRAZIL, IND.—The Brazil Rapid Transit Electric Street Railway is making solid progress. Is asking \$8,000 bonus to build to Harmony. Will probably get it.

ELKHART, IND.—C. W. Fish is appointed receiver of the Elkhart Electric Street Railway which owes \$85,000.

REDKEY, IND.—There is a good opening here for some one to build a line to connect this place with Dunkirk. Natural gas here in abundance. (Redkey, population 2,000; Dunkirk, 1,200.)

SHELBYVILLE, IND.—The Shelbyville Electric Street Railway has let contract for power house, and track work will commence at once.

VALPARAISO, IND.—A scheme to unite the towns of Hammond, Valparaiso and LaPorte is on foot. The Hammond & East Chicago line is the first of which the organizers are: C. F. Griffin, A. R. Shroyes and W. H. Fitzgerald; capital \$200,000, organized at Indianapolis.

VINCENNES, IND.—Plans are being made for an electric to Monroe City, a distance of 15 miles. Local capital is interested. Line will carry baggage, mail and express.

BRAZIL, IND.—J. D. Sourwine, representing the Des Moines syndicate, has been granted a franchise for the Brazil Rapid Transit Company. Sourwine may be found at the Chamber of Commerce building, Chicago. He is a Brazil man.

Iowa.

KEOKUK, IA.—The Keokuk Railway & Improvement Company has been organized, with a capital stock of \$1,000,000; to run 50 years. Wm. Ballinger, president; W. C. Anderson, secretary.

SIoux CITY, IA.—Sioux City & Leeds Electric will soon begin building its own power plant. More equipment.

SIoux CITY, IA.—A. B. Peavey, superintendent of the Sioux City Street Railway, has resigned, to take effect January 1st. Will go into business, and be succeeded by I. B. Walker, present electrician of company.

Kansas.

LEAVENWORTH, KAS.—City council has quashed the Putnam franchise.

LEAVENWORTH, KAN.—The Leavenworth Electric Railway is before the council for franchise. The opposition from the Earl Compressed Air Scheme has weakened, and the electric ordinance will undoubtedly now pass. Wm. Dill, attorney for petitioners.

Kentucky.

COVINGTON, KY.—Registers are being placed on the Covington cars.

OWENSBORO, KY.—Organized: The Owensboro Electric Car Company, capital, \$600,000.

OWENSBORO, KY.—J. N. Alsop and W. E. Whitley have bought control of the railway. The new company will endeavor to put in an electric immediately.

OWENSBORO, KY.—R. H. Neely, superintendent of the Owensboro City Railway, states his company intend putting in electricity. Probably stimulated by the Owensboro Electric Railway, recently incorporated.

Maine.

ELSWORTH, ME.—Electric railway is being agitated here.

Mexico.

CITY OF MEXICO.—J. S. Clarkson, ex assistant postmaster general; V. T. Meek, president of the Colorado Iron Company; R. W. Clay, of Philadelphia, and T. H. Blakewell, of New York, are said to have bought the tramways here for from seven to nine million dollars. They intend to work the road by electricity. The plan is a paying one and the report is probably correct.

Manitoba.

WINNIPEG, MANITOBA.—The motion of the old Street Railway Company to enjoin the electric railway from running cars has been dismissed and the cars are now to run.

Maryland.

BALTIMORE, MD.—The Maryland Electric Company is capitalized at \$2,000,000. W. T. Putney, of New York, president; A. J. Carr, secretary; R. T. McDonald, of Ft. Wayne, is also interested. The company will do light, heat and power business, and controls all Edison patents in this vicinity.

HAGGERSTOWN, MD.—J. C. Blackwell, S. Murdock, R. H. Edmonds and others, of Baltimore, and Col. Wm. F. McCarty, of this place, are before the council for ordinance to construct electric railway. Success almost sure.

UPPER MARLBORO, MD.—H. W. Clagett, J. W. Belt and Jas. T. Perkins, of this place, are incorporators of the Upper Marlboro & Washington Electric Railway.

Massachusetts.

LAWRENCE, MASS.—The big street railway deal, consolidating the Lowell Haverhill & Lawrence, the Haverhill & Groveland, and the Merrimack Valley road is engineered by John U. Beckley and his syndicate of Rochester from their Boston office.

LOWELL, MASS.—The Lowell, Haverhill & Lawrence Street Railway petitions for rights to build in North Andover and Bradford. It asks also the right to buy the Groveland road.

NEWTON, MASS.—H. B. Parker, G. W. Morse, A. R. Mitchell, et al. incorporate the Newton & Brighton Street Railway Company; capital stock, \$100,000. There is said to be no antagonism with the West End

ROCKLAND, MASS.—The Abington & Rockland Electric have secured an extension of franchise to August 1, '93. Company promise to begin work in May.

WORCESTER, MASS.—The directors of the Consolidated voted to petition for right to double track its entire system, and also ask for further extensions. The company will erect a large power station as soon as a convenient site can be secured. The horse-power will be 2000, provided by five triple expansion engines of 500-horse-power each. There will be ten generators of 250-horse-power each. An enormous iron building, two stories high, will be built to store 100 large electric cars. Paint and repair shops will occupy the upper story, together with the office of the company, while the lower floor will accommodate the cars. It is intended to equip the entire system of twenty-five miles or more with electricity by June, 1893.

Michigan.

DETROIT, MICH.—Bela Hubbard, C. B. Hubbard, R. H. Fyfe and others petition for a street car line on Warren avenue. Bids will be advertised for franchise.

DETROIT, MICH.—Homer Warren, R. H. Fyfe, Collins B. Hubbard and others are seeking franchises on Jefferson avenue. Supposed to represent a new company.

DETROIT, MICH.—The Detroit Suburban Railway Company has bought in the Highland Park Electric for \$125,000. The new purchaser will spend \$100,000 in improvements.

DETROIT, MICH.—The new Metropolitan Railway Company, of which A. E. Riopelle is president, has filed a petition to operate a street railway by electricity. The stockholders say they mean business.

DETROIT, MICH.—Eber W. Cottrell has secured a franchise for ninety nine years in Greenfield township for a street railway to run from present terminus of Grand River Avenue line. Two miles must be laid in two years.

DETROIT, MICH.—At a director's meeting of the Citizens' Street Railway, the secretary was ordered to get plans and specifications for sixty new cars. Half to be motor cars, other half so constructed that they can be changed from trailers to motor.

DETROIT, MICH.—C. W. Harrah heads a syndicate which has bought the Windsor, Ont., electric road. The line was electric only in name, and horses will be still used until May 1, by the former owner, Mr. Boomer. Then the road will be delivered and electrified.

GLADSTONE, MICH.—M. B. Koon, W. D. Washburn, Jr., and W. D. Hale have been granted a franchise to construct a street railway here, which must be in operation prior to Jan. 1, '94. Any but steam locomotion or animal power may be used.

IONIA, MICH.—A project is on foot to dam Prairie creek to furnish power for the electric railway. Mayor Davis, L. B. Townsend and Surveyor Crawford are looking over the ground. The road is projected by Sam Tibbitts.

KALAMAZOO, MICH.—W. F. Davidson, of Port Huron, Mich., bought in the Kalamazoo City & County Railway at \$32,000. Davidson represents the General Electric.

LYONS, MICH.—H. R. Wagar, the capitalist of Ionia, proposes to use the water power here for the power of an electric in both and between these cities.

WEST BAY CITY, MICH.—The Philadelphia syndicate has bought the lines here and in Bay City. Price \$350,000 for the twenty-five miles. To be changed to electricity in the spring.

Minnesota.

DULUTH, MINN.—The Minnesota Point Street Railway Company has had its right-of-way confirmed in the village of Park Point. Animal or pneumatic power to be used. R. W. Petre, A. McDougall, R. P. Edson, Bernard Silberstein, et al.

MINNEAPOLIS, MINN.—Arrangements are about complete for the reorganization of the Northern Car Company. New stock to the amount of \$50,000 is to be subscribed, and the factory will be located at Columbia Heights.

Mississippi.

VICKSBURG, MISS.—C. R. McFarland is now receiving bids for material to construct an electric road. Light and power will be sold in addition to operating cars.

VICKSBURG, MISS.—C. R. McFarland, J. J. Mulligan and L. W. Magruder, of Vicksburg, incorporate the Vicksburg Electric Transit Company.

Missouri.

KANSAS CITY, MO.—The Wyandotte ordinance is likely to pass.

ST. LOUIS, MO.—The St. Louis & Madison Bridge Transfer Company; capital \$350,000, to build electric roads and wagon way over the Merchants' bridge at North St. Louis.

JOPLIN, Mo.—The Southwest Missouri Electric Railway Company has received a franchise between here and Webb City.

KANSAS CITY, Mo.—West Side Street Railway will extend from present terminus at Eighteenth street to Quindaro. Bonus now raised.

GEO. H. CHURCHILL is appointed receiver of the Tenth Street Cable in place of H. P. Churchill, resigned; Supt. Frank Phillips remains.

ST. LOUIS, Mo.—O. D. Tucker will press his elevated franchise scheme by introducing a bill into the house of delegates.

ST. LOUIS.—St. Louis Traction Company filed papers of agreement; stock, \$2,000; James Campbell, 18 shares, W. T. Reed and W. S. Corcoran, 1 each.

F. L. THOMAS, of Belleville, has applied for rights in East St. Louis.

ST. LOUIS.—The Kirkwood, Webster Groves and St. Louis Railroad makes a new offer. They will construct and operate a line to cost \$300,000 if local parties will subscribe \$100,000 and take second mortgage bonds, payable when the road is running. August Heman is president; J. D. Housman, Jr., secretary.

Nebraska.

OMAHA, NEB.—Car stables at Albright near South Omaha, one car burned; loss, \$5,000.

New Jersey.

BRIDGETON, N. J.—The council has received an application for charter from the Bridgeton Rapid Transit Company. Capitalized at \$100,000; incorporators, T. U. Harris, J. Smalley, W. O. Garrison of Bridgeton; E. V. Douglass, W. P. Douglass and P. Newbold of Philadelphia. The company expects to introduce the Conelly motor.

NEWARK, N. J.—The Worcester Traction Company has incorporated under New Jersey laws for \$5,000,000 to buy, sell and operate street railways.

NEWARK, N. J.—Worcester Traction Company, organized to buy, sell build and operate street railways by Edward A. Dennison, Edward J. More, and C. F. Stephenson, of Philadelphia, Stephen E. Haas, of Chester, Pa., and Thomas C. Barr, president of the local electric lines here, incorporators. The capital, \$5,000,000.

New York.

BROOKLYN, N. Y.—The Brooklyn & Jamaica Plains, electric, has decided to extend to Wood Haven. Other extensions will follow.

BROOKLYN, N. Y.—The Montague Cable Line has been sold. Buyers not yet known.

THE Brooklyn City has received a franchise for new lines on Flushing avenue, Fresh Pond road and to Bowery Bay beach.

BROOKLYN, N. Y.—The Brooklyn City offers \$250,000 for franchise on about 50 streets. This is the first offer of compensation for franchise.

GLOVERSVILLE, N. Y.—H. Walter Webb of the New York Central has acquired the Fonda, Johnstown & Gloversville electric.

ILION, N. Y.—Frankfort & Ilion Street Railway, electric, asks rights between the two towns. A. J. Douglass, president board of trustees.

JAMESTOWN, N. Y.—Superintendent Maltby says his company will double track their line to Falconer.

LOCKPORT, N. Y.—The Lock City Electric Railway Company has received its franchise and put up forfeit. Work must begin by May 1 and finished by Sept. 1, 1893. This ends the fight.

NEW YORK CITY.—The Kings Company Electric has applied for extensive additions. The road will be second in mileage to the Brooklyn City.

NEW YORK CITY.—New York, Mapleton & Van Pelt Manor Electric has elected A. D. Baird, president; W. P. Rae, secretary, and will build to the Thirty-ninth street ferry to Twentieth and Cropsey avenue.

THE Third Avenue line has certified to extensions

LEXINGTON AVENUE RAILROAD COMPANY has organized; capital, \$75,000; A. Lazarus, Albert J. Elias, Henry Hart, E. Lauterbach, directors.

NEW YORK CITY.—The Broadway cable is to be extended to 110th street, and a \$500,000 forfeit put up. The Columbus & Ninth Avenue Company bought the franchise but W. C. Whitney, of the Metropolitan brought down the check.

NEW YORK CITY.—Incorporated: Columbus & Ninth Avenue Railroad, \$3,000,000; Pavonia Ferry Railroad, \$5,000,000. Former will construct 3 miles; latter 7 miles. Directors: both corporations the same N. Brady, of Albany, Phillip E. Bray, John Seage, Howard Vansideren, Edward Ferrero, James J. Traynor, John J. Cumming, James R. Breen and Samuel Goldsticker, of New York.

NEW YORK CITY.—The great auction of the franchise for the underground rapid transit system, formulated by the Rapid Transit Commission, was held December 29 and just one bid made—and that not in accordance with advertised terms. One-half of 1 per cent of gross earnings and \$500 annual rental was offered for 999 years. Commissioners will immediately tackle the question of elevated transit.

NIAGARA FALLS, N. Y.—W. Carroll Ely, of this place, seeks rights to build an electric to Buffalo.

ROCHESTER, N. Y.—Rival companies ask new franchises. The Rochester City stands the best chance of gaining them.

ROCHESTER, N. Y.—The Rochester, Windsor Beach & Irondequoit Bay Railway organized with Stephen Remington, president; vice-president, Charles Goetzmann; secretary and treasurer, Frank J. Hone; directors, the above named and A. J. Johnson, George Weldon, George W. Archer, Joseph W. Palmer, John Fahy, John VanVoorhis, William Moran, Max Brickner, Henry Gallagher, I. C. Tone. The capital stock of the new company is \$1,000,000.

ROME, N. Y.—Charles D. Haines, of the firm of Haines Brothers, New York, will probably get possession of the road here. Conditions are that the firm is to equip electrically and secure the bonds of the company.

WAVERLY, N. Y.—Incorporated: the Interstate Traction Company, to build surface road; capital \$20,000; directors, Arthur, William and Edward Frothingham, M. J. and E. G. Wightman, and James H. Torrey, of Scranton, Pa.; J. T. Sawyer, J. B. Floyd, and Fred A. Sawyer of Waverly.

WHITE PLAINS, N. Y.—An electric from Tarrytown to this village and from here to Port Chester, L. I. sound is talked of. A stage company does a good business and an electric could do better.

Ohio.

CINCINNATI, O.—The Cincinnati Street Railway are asking permission to electrify some of their present lines and to construct an inclined plane as a part of the new lines asked.

CLEVELAND, O.—St. Clair street electric franchise granted to the Cleveland cable.

LANCASTER, O.—Frank Barrett and A. Bauman have gained their electric franchise. Contracts will soon be let.

MARION, O.—Clark Rude, of Sandusky, and Reid Carpenter, of Mansfield, secure contract for construction of electric line here. They are now receiving bids for all material and equipment. Five cars will be bought. Line must open July 1st, '93.

WARREN, O.—Contract for constructing the electric from this city to Niles is let to the Pennsylvania General Electric Company, of Pittsburg, for \$100,000. Road must be delivered June 1st.

YOUNGSTOWN, O.—The south-city franchises have been accepted by the street railway company.

PIQUA, O.—The Miami Valley Railway Company, of this city, are considering the construction of an electric line from this city to Covington and Bradford, with an extension to West Milton and Dayton. Company will incorporate soon.

WORTHINGTON, OHIO.—The directors of the Worthington, Clintonville & Columbus Street Railway Company effected a permanent organization. President, O. W. Aldrich; vice, J. M. Milne; secretary, R. M. Weaver; treasurer, H. C. Cooke; executive committee, O. W. Aldrich, H. C. Cooke, J. M. Loren, A. M. Milne and H. W. Wright. The board determined to investigate the practicability of using the storage system for their electric cars.

MARION, O.—The Marion Electric Street Railway Company has elected officers as follows: Daniel Babst, president; W. E. Scofield, secretary; Harry True, treasurer. C. H. Norris and W. E. Scofield were appointed a committee to confer with the Electric Light Company regarding their furnishing the power.

MIDDLETOWN, O.—A New York capitalist wants to build an electric here. A local company unites in the deal, and the work will begin early in the year.

CLEVELAND, O.—The Johnson Electric Company has transferred its business to the Steel Motor Company of this city. F. J. Lewis is the manager of the new company.

COLUMBUS, O.—Transfer tickets are to be issued by the Columbus Consolidated.

TROY, O.—Col. W. P. Orr says that the Miami Valley Electric Railway Company has bought all the stock of the old Piqua Electric. The interurban to Piqua will not be built by this company, and a good opportunity is offered for a new company.

WOOSTER, O.—Council has a proposition from B. M. Barr for the Thomson-Houston Electric Company, of Cleveland, to construct a street railway in this city.

COLUMBUS, O.—The directors of the Worthington, Clintonville & Columbus elected officers. President, O. W. Aldrich; vice president, J. M. Milne; secretary, R. M. Weaver; treasurer, H. C. Cooke; executive committee, O. W. Aldrich, H. C. Cooke, J. M. Loren, A. M. Milne and H. W. Wright.

NILES, O.—The Warren-Niles road has re-organized, with H. G. Chresty president, A. D. Sillasas, vice president, and E. D. Kennedy, secretary and treasurer. It is now promised that the road will be in operation by June 1st.

CLEVELAND, O.—Citizens petition the city to build a line to Gordon Park. The director of public works is to take charge.

OSBORNE, O.—Stock subscribed for an electric from Dayton to Osborne.

Oklahoma.

GUTHRIE, OKLAHOMA.—W. D. Ford, president of the Guthrie Electric Railway Company, is advertising for ties and will receive bids for material on electric line.

Ontario.

LONDON, ONT.—Everett & Grace, of Montreal, have bought the control of this line and will electrify soon.

WINDSOR, ONT.—The street railway electric power house burned, December 26th.

HAMILTON, ONT.—Strong efforts are made to put the H. W. & G Electric road through the village of Waterdown and East Flamboro.

Oregon.

PORTLAND, ORE.—Portland capitalists have bought the controlling interest in the Salem Electric Railway & Light Company.

PORTLAND, ORE.—The Multnomah Consolidated is being importuned to construct a line on Union avenue. The company is also seeking further franchises.

SALEM, ORE.—Geo. B. Markle, S. Z. Mitchell, E. P. McCormack incorporate the Salem Consolidated Street Railway for \$500,000.

Pennsylvania.

EASTON, PA.—Philadelphia capitalists have options on the Reading roads, Mt. Penn gravity; Neversink Electric and other roads.

PITTSBURG, PA.—The Larimer Street Railway Company Ordinance has been passed.

THE Morningside & Highland Park franchise was amended to death and then passed.

DUQUESNE TRACTION granted extensions.

ASHLAND, PA.—D. D. Phillips, S. A. Beddall and J. J. Coyle have gone to Norfolk, Va., to secure right-of way of the Norfolk-Ocean View line. Charter granted and work will begin soon.

BRADDOCK, PA.—The Braddock Street Railway Company will extend to Turtle creek.

GETTYSBURG, PA.—Council has granted the right of way over all of the principal streets of the borough to the Electric Railway Company, which will build a line over the battlefield.

PHILADELPHIA, PA.—Jas. Rawle, of the Brill Company, is the head of a company that has obtained the control of the Manayunk Company, running an incline and surface road that has never yet paid a dividend. It will now be electrified. Road five and one-half miles long.

PITTSBURG, PA.—Council have granted the long sought franchise to the Wilkesbarre & Wyoming Traction Company.

PHILADELPHIA, PA.—The Philadelphia, Castle Rock & Westchester Railway, incorporated for \$90,000, to build 15 miles.

BRISTOL, PA.—Leading citizens of this place and Laughton and Newtown, are meeting to organize an electric road to connect the three places. Franchises will be asked early in January.

PHOENIXVILLE, PA.—Incorporated: The Schuylkill Valley Electric Railway Company; capital, \$50,000; eight miles, Phoenixville to Royersford. The directors of the company are George P. Pierson, Charles H. Davis, Edward Chamberlain, Philadelphia; Bayard Snyder, A. C. Milliken, Pottsville; Welde & Thomas Brewing Company, Philadelphia, capital \$400,000; directors, John Welde, John Thomas, William J. McLaughlin, Jacob J. Kitschler.

Rhode Island.

PROVIDENCE, R. I.—The Union Railroad Company has decided to make its own power, and is now securing plans for a power house, 76x325 feet.

Tennessee.

NASHVILLE, TENN.—M. A. Spurr, J. B. Armstrong, G. W. Ehle Isaac Litton and A. Wills have filed an application for a charter of the Maplewood Electric Railway Company.

CHATTANOOGA, TENN.—A scheme is on foot among heavy local capitalists to convert the Belt line into an electric.

CHATTANOOGA, TENN.—The Chattanooga Electric Railway has secured control of the new tracks of the Chattanooga Company, Limited. The line extends over and beyond the river three miles. Will open February 15.

CHATTANOOGA, TENN.—The Lookout Mountain Railway Company has changed hands, being reorganized with T. B. Redmond, president; Linn White, vice; C. S. Henry, secretary. Another electric road to the mountain is the meaning of this.

Texas.

DALLAS, TEX.—Col. Chas. S. Freeman has been appointed receiver of the Dallas Rapid Transit Railway.

VICTORIA, TEX.—Victoria Street Railway sold under mortgage to J. M. Brownson for \$400. He will probably tear it up in the interests of the hackmen.

Vermont.

BURLINGTON, VT.—J. A. Bowers, of Lansingburg, a suburb of Troy, N. Y., has purchased the Winooski & Burlington Horse Railway, and will equip electrically in the spring.

Washington.

ELBERTON, WASH.—D. M. Nulty, editor of the "Wheat Belt," is working up an electric railway to connect towns in the Palouse valley.

SPOKANE, WASH.—Loren C. Barton says the Manhattan Company has completed its survey to Chelan Falls and will build next spring. A beautiful resort will also be established at the lake.

Wisconsin.

WAUSAU, WIS.—The council is considering a proposition from John D. Ross, Walter Alexander and Hiram Dunfield to build a street railway.

JANESVILLE, WIS.—A line of 18 miles, from here to Johnstown, is contemplated.

MILWAUKEE, WIS.—The Wauwautosa motor line extension to North Greenfield will be built. Bonus of \$10,000 raised and route ready for survey.

RACINE, WIS.—Reiplinger & Francis have purchased the old cars of the Belle City Street Railway Company and it is reported that they will run an independent line to the Rapids and North Point.

RACINE, WIS.—President Holmes states the additions to his power plant the coming season will include a 500-horse-power engine, 6 motor cars, 6 trail cars, and will also enlarge buildings.

Abraham Lincoln

When leaving his home at Springfield, Ill., to be inaugurated President of the United States, made a farewell address to his old friends and neighbors, in which he said, "NEIGHBORS GIVE YOUR BOYS A CHANCE."

These words come with as much force to day as they did thirty years ago.

How give them this chance?

Up in the Northwest is a great empire waiting for young, and sturdy fellows to come and develop it and "grow up with the country." All over this land are the young fellows, the boys that Lincoln referred to seeking to better their condition and get on in life.

Here is their chance!

The country referred to lies along the Northern Pacific R. R. Here you can find almost anything you want. In Minnesota and in the Red River Valley of North Dakota, the finest of prairie lands fitted for wheat and grain, or as well as for diversified farming. In Western North Dakota, and Montana, are stock ranges limitless in extent, clothed with the most nutritious of grasses.

If a fruit farming region is wanted there is the whole State of Washington to select from.

As for scenic delights the Northern Pacific Railroad passes through a country unparalleled. In crossing the Rocky, Bitter Root, and Cascade Mountains, the greatest mountain scenery to be seen in the United States from car windows is to be found. The wonderful bad lands, wonderful in graceful form and glowing color, are a poem. Lakes Pend d'Oreille and Coeur d'Alene, are alone worth a trans-continental trip, while they are the fisherman's Ultima Thule. The ride along Clark's Fork of the Columbia River is a daylight dream. To cap the climax this is the only way to reach the far-famed Yellowstone Park.

To reach and see all this the Northern Pacific Railroad furnish trains and service of unsurpassed excellence. The most approved and comfortable Palace Sleeping cars; the best Dining cars that can be made; Pullman Tourist cars good for both first and second class passengers; easy riding Day Coaches, with Baggage, Express, and Postal cars, all drawn by powerful Baldwin locomotives, make a train fit for royalty itself.

Those seeking for new homes should take this train and go and spy out the land. To be prepared, write to

CHAS. S. FEE,
G. P. & T. A.
St. Paul, Minn.

FRANK DE H. ROBISON, president of the Cleveland City Cable Railway, generously offers to be one of the 200 to contribute \$1,000 each, or one of forty to give \$2,500 each, to start a subscription to float city bonds to be issued for a system of boulevards and parks.

HAS IT A HOODOO?

WHEN Sheriff Lewis sold the Dundee Place Electric Line at Omaha, the other day, he put an end, at least temporarily, to a succession of misfortunes that pursued this unfortunate piece of track from before its building. Right at the beginning, a suit followed a dispute with the contracting engineer, and the former is still in litigation. The lucky bidder for the contract sent to Germany for the material, and the enraged Atlantic promptly protected home industries by sinking ship and cargo. Or, better stated, the car didn't go.

The contractor proceeded to fail for \$80,000, leaving the line uncompleted. The owners finished the equipment, put in electricity, and carried people free until the overworked expenses landed the road with the sheriff. Romance yet attends this tale: R. W. Patrick and his son were rivals for possession. The young man started it at \$10,000, the old man raised him ten thousand, the young man looked at his hand, called out \$25,000, the old man raised him another five thousand, when the son ended the game with a \$40,000 bid.

THE Milan, Italy, council has granted permission to the Edison Company for building a tramway at that place.

OUR DICTIONARY OF TECHNICAL TERMS.



"CALLED SHORT."



"SPOTTED."

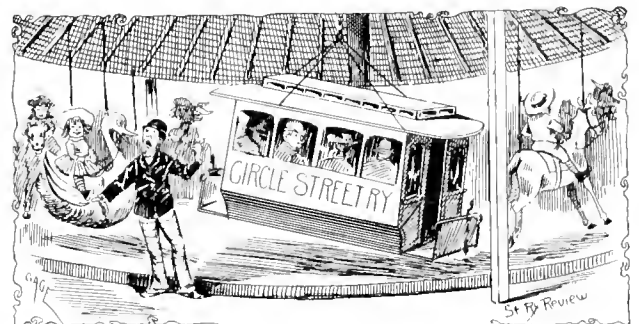

"A ROUND TRIP."

Map of the United States.

A large handsome map of the United States, mounted and suitable for office or home use, is issued by the Burlington Route. Copies will be mailed to any address on receipt of fifteen cents in postage, by P. S. Eustice, Gen'l Pass. Agent, C., B. & Q. R. R., Chicago, Ill.

THE MANUFACTURE OF AN ELECTRIC STREET CAR TRUCK.

WHAT constitutes the most necessary qualities in a good truck for an electric or cable car has been a matter over which several hundred managers have studiously toiled, and still others will have to take up the question soon, for the first time. One of the most successful and popular trucks is that made by the McGuire Manufacturing Company, of this city, and, while this article will not go into minute detail as to its evolution, a few words as to the process of its construction cannot but be of interest. The makers attribute their success largely to the peculiar feature of their

number of an English street railway paper, in an article on electric railways in England, an exact counterpart of this frame is shown, excepting that the McGuire Company makes the flanges turned outward while the English turn theirs inward. Accompanying this the following paragraph appears: "The managers of the road have recently made a tour of the United States for the purpose of examining the American system, and have embodied, after the most critical survey of all the important roads, those features which they thought the most valuable." This shows that John Bull, whatever amount of alleged stupidity he may possess, and however lacking in originality, has an abnormally developed bump of perceptiveness and imitativeness.

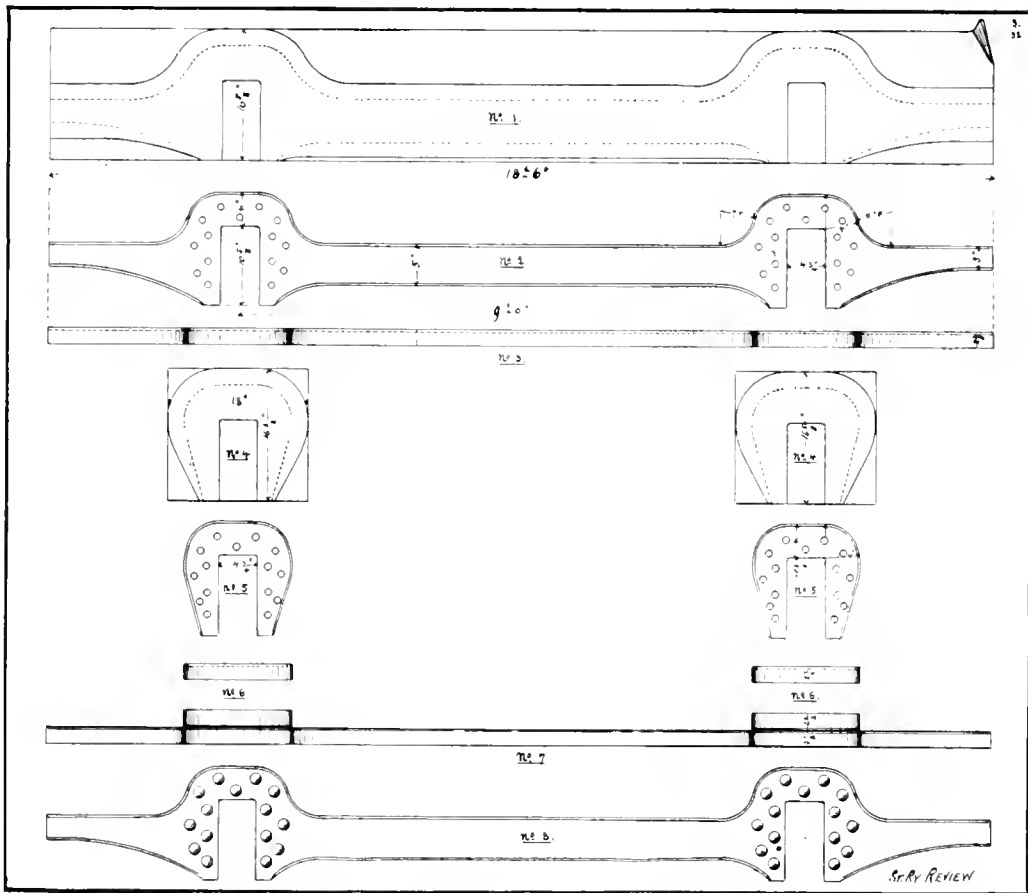

M'GUIRE TRUCK IN VARIOUS STAGES OF MANUFACTURE.

pressed steel truck frame. This frame has attracted the attention of electric railway people, iron and steel workers in all parts of the world where electric railroading has been introduced, as is shown by the fact that the company have sold within the last year to England, Germany, France, Mexico, Canada and South America. Only recently a mechanical engineer, a representative of the oldest and largest electric manufacturing and construction company in the world, not satisfied with the study of one of the trucks made for his people by the McGuire Manufacturing Company, came all the way from Germany to see the complete operation of making one of these frames. How interesting a work this is can only be appreciated by witnessing it. In the December

The peculiar construction and manufacture of this frame is instructive and interesting, demonstrating as it does a fact that a piece of mechanism can be so constructed that its weakest point is as strong as its strongest, like the "deacon's wonderful one-horse shay."

The margin of strength, combined with the flexibility of all parts, and the elasticity of the steel, permits the ready adjustment of the truck to the car body, under any and all the varying strains met with on rough tracks and in electric service generally, without bending or crystallizing any of its parts and adding greatly to the life of the car body. All corners and fillets being large and well rounded, the steel being sheared and pressed at a bright red heat, precludes all possibility of crystallization,

cracks or fissures; even the rivet holes are placed with that exact nicety that even the most critical must admire. The end sills are pressed of the same material and the whole frame being riveted together at the corners. The absence of a bolt or joint in the entire frame, or a truss rod to crystallize and break, makes the frame include the three essentials necessary to a perfect truck frame, viz.: symmetry, flexibility and strength.

The process of manufacture is well worth seeing, as it is done in one movement of a huge hydraulic press into which steel dies are set.

The accompanying sketches of the side frames, showing the different stages of the process before and after pressing, should be interesting. The extraordinary length, thirteen feet six inches, as compared with the width, five inches, necessitates having the light sheet, three-eighths inch, equally heated its entire length and handled with the greatest care to place it between the dies, so that when the pressing is done the flanges around the entire frame will be found to be exactly as designed, that is to say of equal depth at every point, generally two inches. Cut No. 1 represents a sheet of steel thirteen feet six inches long by sixteen inches wide, three-eighths inch thick, from which sides for the Chicago City Railway Company were pressed. The full lines show how the sheets are sheared, the dotted lines the shape after being pressed. The space between the full and dotted lines shows the metal left for forming the flange, extending two inches at right angles after being pressed. Cut No. 2 shows the side after being pressed and punched. Cut No. 3 gives an edge view of the same, showing flange and thickness of the metal. Cut No. 4 is the reinforcement for pedestal and around oil box before being sheared or pressed, the space between full and dotted lines showing the flange. Cut No. 5 shows the reinforcement after being sheared, punched and pressed. Cut No. 6 an edge view of same. Cut No. 7 and 8 are an edge and face view of finished side with reinforcement riveted on and flanges turned opposite each other.

The McGuire Company have now on exhibition at their works the latest production of the inventive talent which always keeps that company in the foreground. It is called the "Columbian" truck. The new feature is an ingeniously devised plan of setting a spring on each side of the frame over the journal box, thus cushioning every part of the truck frame and placing every pound of weight of load, car body and truck frame, on the springs, thereby obtaining the softest riding qualities.

A HAIR LIFTER.

THE president of the Rio Grande Southern Railway, Otto Mears, is planning to connect Ouray and Ironton, Colorado, with an electric road that will surpass the famous Georgetown loop in hair lifting effect. The line will run down the Uncomphagre canon, through a tunnel and around a loop down to Ouray. Length to be eight miles; maximum grade, seven per cent. Both freight and passengers are to be carried.

LARGE SHEAVES REPLACE CURVE PULLEYS AT MELBOURNE.

AS previously mentioned in these columns, the largest operating cable road in the world, and one of the best, is that of the Melbourne Tramway & Omnibus Company. When the line was constructed small curve pulleys were used on all curves, but, as has been the experience of all cable engineers, the wear on the rope at such points was excessive. Some months ago the curve system was remodeled, and wherever gravity or momentum was sufficient to carry the train around a curve the small pulleys were removed and 12 foot sheaves substituted. Only one line has been so changed a sufficient length of time to afford much data, but on that section, which has two right angle curves and one obtuse curve, the result has been highly satisfactory. The rope in use since the change gave a life of fifty-seven weeks, against a previous average life of sixteen and a previous maximum of twenty-eight weeks.

HOURS AND WAGES IN OHIO.

THE bureau of labor statistics, of the State of Ohio, of which W. T. Lewis is commissioner and and Thomas Thomas is chief clerk, are compiling a report on street railway employes. To the courtesy of Mr. Thomas we are indebted for the following table. These figures are for the fiscal year ending July 1, 1892, and are returns from 43 companies operating in the State. No reduction in wages has since been reported by any road, but there were 27 advances, ranging from 5 to 40 per cent, mostly for drivers, conductors and motormen. The table does not include the advances.

NUMBER OF ROADS, 43.

	No. of Employes.	Average Hours of Labor Per Day.	Average Wages Per Day.
Conductors (electric cars).....	803	11.2	\$1.82
Conductors (horse cars).....	313	11.4	1.85
Conductors (cable cars).....	67	10.	1.75
Drivers.....	468	11.5	1.69
Motormen.....	941	11.2	1.80
Trolley men.....	77	11.1	1.58
Linemen.....	60	11.1	2.10
Laborers.....	307	10.	1.46
Motor repairers.....	153	10.5	2.01
Motor inspectors.....	21	11.6	1.87
Shedmen.....	21	11.7	1.57
Car cleaners.....	110	11.8	1.60
Lamp tenders.....	14	11.	1.55
Watchmen.....	51	10.7	1.60
Engineers.....	62	11.13	2.55
Firemen.....	54	11.4	1.70
Oilers.....	38	12.	1.68
Dynamo tenders.....	13	11.7	1.91
Feeders.....	29	11.	1.53
Grooms.....	241	10.5	1.45
Farriers.....	13	10.5	2.40
Harness repairers.....	6	10.	1.71
Wood workers.....	90	10.	2.21
Blacksmiths.....	75	10.1	2.08
Painters.....	36	10.	2.17
Cashiers.....	36	9.4	2.10
Not Classified.....	69		
Total.....	4,168		

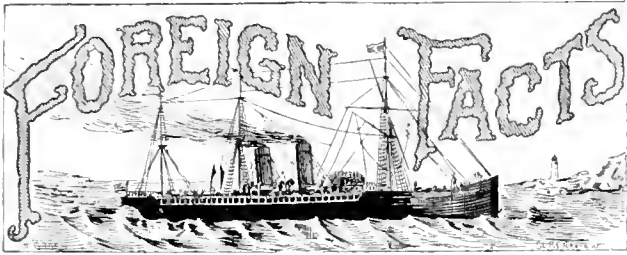

COVENTRY is in the midst of a trolley fight.

ONE fare for the round trip is a novelty recently introduced on an English tram line, sold mornings to working-men, but good to return any time during the day.

MORE underground railways to be operated by cable or electricity are being considered by Parliament as a remedy for the congestion of population in London.

EUROPEANS seem to be doing much more than Americans in the way of long distance transmission from water falls. In Italy transmissions are especially numerous.

THE society of engineers recently heard Herr Koester describe an electric motor which is to travel 123 miles an hour. A road is projected from Vienna to Buda Pesth.

MANCHESTER, England, conductors have a Christmas fund to which passengers may contribute. It is divided among the whole force. Subscription books hang in each car.

THE Glasgow Tramways Company has a new car, or as we should call it, a double-decked bus, with pneumatic tires. The vehicle runs between the city and Pollockshields. The front tires are inflated to 150 pounds and the rear tires to 170 pounds.

THE Edinburgh Tramways Company informs the city that it is prepared to sell out the part of the undertaking within the city for \$1,525,000. The company has eighteen miles of road worked by horse power and the capital expenditure of the company is nearly \$2,000,000.

A NEW London company, called the United Electric Tramways, limited, proposes to build, acquire and install electric railways and stations for light and power generally. The capital is \$150,000 and the financial papers in England seem to doubt the sufficiency of such a capital.

A FINE IMPROVEMENT AT THE BRILL FACTORY.

THE well known car builders, J. G. Brill Company, are always forging to the front with improvements in their plant, with the idea of making it the most complete car factory in the country. The latest addition to the works is a testing electric railroad. This line extends around two sides of an eleven-acre enclosure, and is half a mile long, including curves as sharp as 30

feet radius and a gradient of 5 per cent. Any cars on which the electric machinery is mounted at the works of Brill Company, either by the employes of the General Electric Company, Westinghouse Company or other electric manufacturing companies, or by the regular electricians in the employ of the Brill Company, are run out of the shop and put to a severe test and all connections certified to as being correct. The advantage of this improvement was manifest only a few days ago, when the equipment for the Philadelphia Traction Company's Catherine & Bainbridge Streets line was delivered. There were twenty-two cars furnished in all; twenty by the Brill Company and two by another maker. The Brill cars were out on the street and operated successfully, while the other two cars could not be moved by the current. The railway fraternity cannot but express commendation of the progressive and enterprising spirit of the officers in charge of the business of the Brill Company. By this railway also a great deal of time is saved in the loading of cars; a wire is attached to the truck frame and connected with the rail, to make the ground current and the electric car mounts the skids to the freight car by its own power. This is an interesting and valuable improvement, one worth the attention of all railway men.

IN MEMORIAM.

At a meeting of the Chicago Electric Club the following was adopted:

Whereas, It has pleased the Almighty to remove from our midst two honored and beloved members of this club, and

Whereas, We acknowledge the wisdom of God while we cannot fathom his infinite design,

Resolved, That we feel in the demise of Geo. H. Meeker and M. M. M. Slattery the club has lost two members of whom all were justly proud, as fellows and friends, genial and upright men, whose removal will leave a blank place in our circle, and whose presence will be missed at our social and literary meetings.

Resolved, That we deeply sympathize with the relatives of the deceased, and earnestly commend them to the Father of all for the consolation he alone can give.

Resolved, That copies of these resolutions be properly certified and transmitted to the families of the deceased, and published in all electrical papers.

W. A. KREIDLER.

Secretary.

Winter Resorts of the South.

Jacksonville and Tampa, Fla., and other South Atlantic and Gulf Coast resorts can be reached with but one change of cars from Chicago, and that at Louisville or Cincinnati, where the Monon makes close connection with the L. & N. and Q. & C. Vestibule trains, running through to Florida.

The Monon's day trains are now all equipped with beautiful new Parlor and Dining Cars, while its night trains are made up of Smoking Cars, Day Coaches, and Pullman and Compartment Sleepers, lighted by electricity from headlight to hindermost sleeper.

The Monon has gradually fought its way to the front, making extensive improvements in its road-bed and service, until to-day it is the best equipped line from Chicago to the South, offering its patrons facilities and accommodations second to none in the world, and at rates lower than ever before.

MRS. E. M. BURKE, wife of Superintendent Burke, of the Terra Haute, Ind., Street Railway died December 23 of pneumonia. Mrs. Burke was formerly a resident of Chicago.

ACME OIL FILTERER.

COMPETENT engineers at this age of the world need no urging to adopt an oil filter. The only question is to what type of lubricant saver; and to answer this question the Acme Filter Company, of 714 N. Main street, St. Louis, put forward the device herewith illustrated.

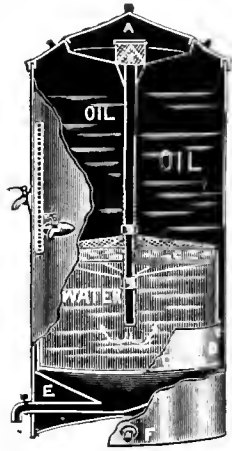

The main design is to remove the coarser matter by means of a filter check and allowing the oil to pass down a tube from which it passes by gravity through filtering material and water, reappearing cleansed and ready for re-use at the top of the filter. A steam chamber is also provided, by means of which the oil thickened by cold, may be rendered easier to handle. Every three or four months the filter material should be cleaned, which is easily accomplished, and the filter check can be readily cleaned every week.

The company gives a positive guarantee at 30 days trial and avers that the use of the filter will save 50 per cent in the oil account, as it restores drip or dirty oil to its original color and condition. Three hundred have been sold in 15 months and abundant testimonial is furnished by the delighted users of the filter. The device is made in four sizes, applicable to steam plants of every size and condition.

A CAT TALE.

THE voracious president of the Ananias Club, of Grand Rapids, Mich., tells the following tale: "At last I have discovered the secret of the wonderful growth of our cats on Lagrove street. The electric road is responsible for the great change. Before, in horse car days, our cats were scrawny and sickly. Now they are large and frisky, more like Newfoundland pups. Coming home after a night at the office, I discovered what caused the change. The cars had ceased running except at long intervals, so the road was clear, and there, to my surprise, I saw all along the line the Lagrove street cats taking an electric bath. They would wallow on the rails until every several hair was full of electricity, and then fall over in an electric trance. There they were, Thomas cats and pussy cats, and kittens in assorted sizes, in worse orgies than that enjoyed in catnip days. Electro therapeutics is a great thing, and the only drawback is the voice culture of the cats."

CAPTAIN WILLARD L. CANDEE, American manager of the Okonite Company, limited, 13 Park Row, New York, sailed December 31 on the North German Lloyd steamship Saale for London, on business connected with the company.

NEW PUBLICATIONS.

ELECTRIC HEATING is the title of a neat little pamphlet just published by the Burton Electric Company, setting forth the advantages of electric over other kinds of heating, for street cars, steam cars, dwellings, offices and domestic uses. Taylor, Goodhue & Ames, Chicago, selling agents.

WILLARD J. HIELD, general manager of the Twin City Rapid Transit Company, St. Paul-Minneapolis, has just issued one of the best compilations of rules for conductors and drivers we have seen. It contains cuts and diagrams of all parts of motors used, with parts named, and the book is entitled "The Trainman's Guide."

MRS. LEE C. HARBY, a journalist and novelist well-known in the South and in New York, contributes a bright, gossipy article entitled, "In the Old South State" to the January New England Magazine. It deals with the interesting old town of Georgetown, S. C., and its social and historical traditions. It is finely illustrated by Jo. H. Hatfield and H. Martin Beal.

"**DO YOU USE MACHINE BELTING?**" is the attractive title of a most attractive 72-page booklet just issued by the Schultz Belting Company, St. Louis. The promise on the first page, that the book is filled with information useful to engineers and belt users is faithfully carried out. The work will interest every engineer, to whom it will be sent free on application.

LIPPINCOTT'S MAGAZINE for January contains a complete novel by Mary E. Stickney, under the title, "A Pacific Encounter." The Atlantic Series article for the month is on "Foins and Fencing," by Captain Van Schaik, of the Manhattan Athletic Club. W. S. Walsh writes in a very entertaining way on "Gossips of the Century." Among other articles are "Men of the Day," (including Emile Zola, Thos. A. Edison and Geo. DuMaurier,) by M. Crofton, and a chapter of Mrs. M. E. W. Sherwood's reminiscences headed "In War Time."

ELECTRICITY AND MAGNETISM, W. J. Johnston Company, Limited, 41 Park Row, New York; price, \$1—the title of a series of advanced primers, by Prof. Edwin J. Houston. This volume is a compilation and revision of eighteen former primers, by Prof. Houston. They have been brought up to the times and thoroughly revised, the last one being a "Primer of Primers," which sums up the essential points in the others. The book is intended for popular reading, but is at the same time of great value as a reference book for electricians, who wish to review minor points in the study of electricity.

ORIGINAL PAPERS ON DYNAMO MACHINERY AND ALLIED SUBJECTS, by John Hopkinson. W. J. Johnston Company, Ltd., 41 Park Row, New York, \$1. This is a collection of all the original papers written by Prof. Hopkinson on electrical subjects. There are eleven in all, the first having been written in 1879. Ever since that time Mr. Hopkinson's papers have been among the standard references for electrical students, and the object of this publication is to make available in convenient form what was formerly found only in the files of current literature. The author's vigorous mathematical treatment of his subjects is too well known to need comment.

DAVIS STANDARD TABLES for electric wiring; W. J. Johnston Company, Ltd., 41 Park Row, New York, \$1. The book has been thoroughly revised and an attempt made to leave out all useless tables and matter of an unpractical nature. The rules of the National Electric Light Association in regard to safe wiring and Ayres instructions to linemen are included. The lamp wiring tables are all calculated on the basis of 55 watt lamps. Formulas taken from actual practice on the horse power of engines and boilers and the heating surface and rating of boilers are among other valuable contents. The tables for the limiting current of outside conductors and candle power of arc lamps are entirely new in their present form; and the work is among the most valued of their many excellent publications.

DR. W. L. BURTON, inventor of the electric heater which bears his name, died at his home in Richmond, Va., December 17, 1892.

THE FOLGER ELECTRIC GONG.

THIS gong is the first one intended to be operated from the trolley circuit ever put on the market.

All previous apparatus was not designed for so heavy a current. The makers of this gong claim that mechanical gongs operated by hand or foot are worthless at the very moment they are needed most, because the motorman needs all his powers to stop the car. The Folger gong will ring continuously upon the touching of a button with the foot or turning of a switch. The clapper of the gong is made to vibrate between two solenoids

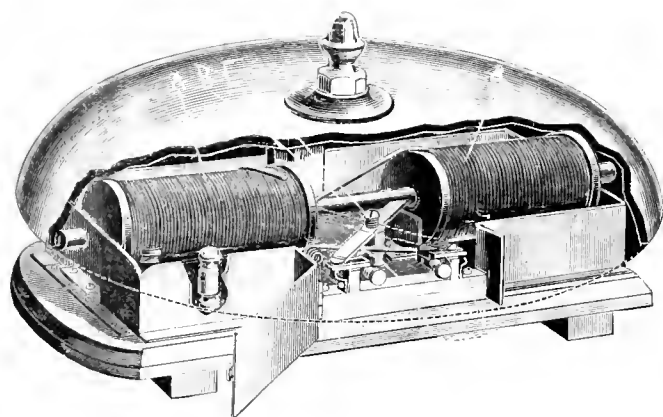

when the current is turned on, giving a continuous alarm at times most needed, and yet always under control of the motorman. The gongs are made for any voltage required. By using a low voltage gong, for example one taking 100 volts, it can be connected up in series with a powerful reflector electric headlight on top of the car, so that when the bell is rung, a light is flashed ahead of the car to any desired distance. The evident advantages of such a gong speak for themselves. At times when the current is broken the bell may be sounded by use of the ordinary clapper and depending bell cord,

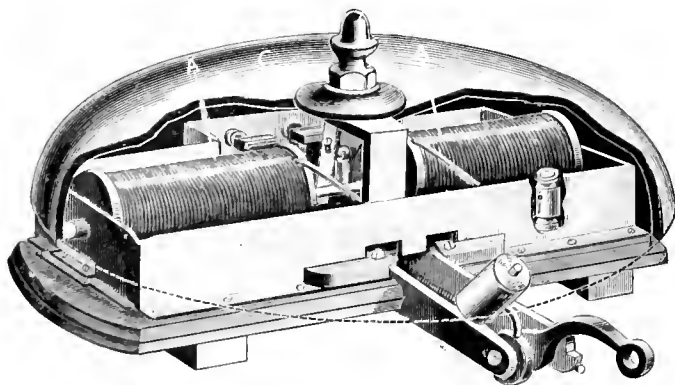

The bell can be adjusted to give either a single tap or a continuous rattle, as desired. It is made of carefully selected materials. The three illustrations sufficiently explain themselves. Figure 1 shows the bell with a portion of the gong cut away. Figure 2 is a similar view,

showing the attachment for ringing the bell by hand or foot, should there be any stoppage of the current, while Figure 3 shows apparatus attached to the car.

It is made by the Cincinnati Novelty Manufacturing Company, of which Chas. H. Mergard is manager.

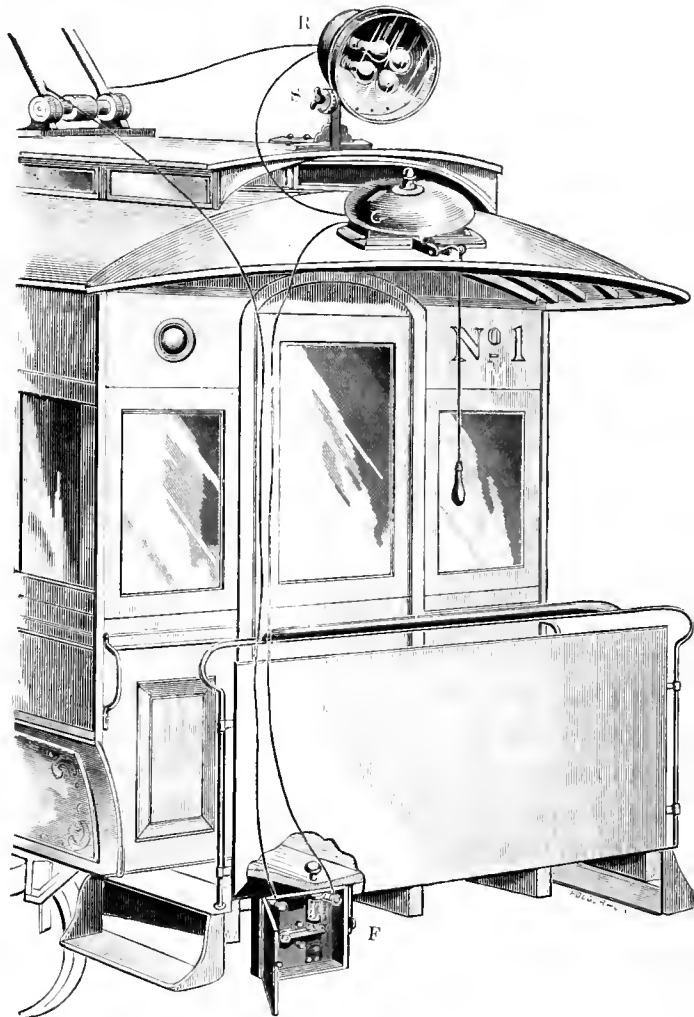

MATRIMONIAL.

THE jolly and popular Major H. C. Evans, New York representative of the Johnson Rail Company, has decided to leave—not the Johnson Company but the state of single blessedness and on December 21, Miss Grace L. Whitney became Mrs. Evans, in the presence of many friends at the home of the brides' parents in Brooklyn. Congratulations are almost needless to both parties to the contract but the STREET RAILWAY REVIEW, nevertheless ventures to express a wish for long and happy life to the couple.

THE Finney Motor Company, of Chicago, has been incorporated. Douglas Dyrenforth of the patent attorney firm of Dyrenforth & Dyrenforth, is at the head. A gas motor will soon be on the market.

C. E. MARK, accompanied by Secretary Hogan, of the Mark Company, Cleveland, paid the REVIEW a pleasant visit on their recent trip to Chicago.

ECHOES FROM THE TRADE.

THE R. D. NUTTALL COMPANY, Allegheny, have sent their friends a very neat and useful desk tab and calendar.

GEORGE CUTTER is building a new form of the Cutter non-inductive voltmeter with a large circular dial that can be read at considerable distance.

THE LALEDE CAR COMPANY has received many handsome compliments from the people of Superior, Wis., on account of the new cars placed there recently.

THE ILLUMINATED STREET CAR SIGN COMPANY, of Newport, Ky., is a new concern with W. R. Garner and D. A. Glenn in command. They will endeavor to fill a long felt want.

THE WALWORTH MANUFACTURING COMPANY, Boston, are getting out two car loads of their electric railway poles on an order from Rio Janiero; one car load for the West Indies and another for Mexico.

"THE CUSHION CAR WHEEL COMPANY," says P. F. Leech, at club room 9, Grand Pacific, "is doing very well, thank you. We have just received a nice order for Bay City, Michigan, and another for a trial at Columbus, O., on the Consolidated."

THE GOUBERT MANUFACTURING COMPANY, 32 Cortlandt street, New York, have delivered to the Broadway Cable Road, of that city, the three 1,000 horse-power feed water heaters ordered by the road for its power station at Broadway and Houston street.

THE STEEL MOTOR COMPANY are the successors to the Johnson Electric Company, Cleveland, O., and find the trade in excellent attitude toward their specialties. The Harris trolley base mentioned elsewhere is a late acquisition that bids fair to make a large place for itself.

THE LYNN & BOSTON STREET RAILWAY COMPANY are fitting up two large plants, one at Lynn and the other at Chelsea, with Babcock & Wilcox boilers. The same company are putting in 3,000 horse-power in addition to the 6,000 already installed in the West End Company's main station.

J. M. JONES' SONS, West Troy, N. Y., say that 1893 starts in most encouragingly. A new order for fifty twenty-foot cars for the new electric service at Providence, R. I., is among a number of late contracts. The company's long standing reputation is upheld by every car that goes out of the shop.

THE LUNKENHEIMER COMPANY, of Cincinnati, of which E. H. Lunkenheimer is president, C. F. Lunkenheimer, vice-president and general manager and D. T. Williams, secretary, has doubled its capital to \$500,000, in order to give scope for the manufacture of its brass and iron specialties, for which there is an increasing demand. Their oil and grease cups have been very well received by the street railway trade.

WITHIN the past week contracts have been let by the Everett, Washington, Light & Power Company as follows: One 200, two 150 horse-power Ball cross compound condensing engines; four tubular 125 horse-power boilers, Washington Works, Seattle; incandescent lights, Westinghouse, 2,000 arc lights, 150 Standard; cars, American Car Company, St. Louis; rail, Illinois Steel Company, Chicago; trucks, McGuire; motors, forty horse-power single reduction, Westinghouse.

THE BATES MACHINE COMPANY, Joliet, Ill., states that their last year has been the best in its history. The record of 1892 has far exceeded that of last year and has been all they could desire. The Bates-Corliss engine, of which they are sole manufacturers, has grown both in popularity and demand and is doing all they claim for it. The outlook for the coming year is considered very flattering, indeed, so much so that they feel warranted in making many improvements which are now under way.

A HANDSOMELY steel engraved announcement, dated Chicago and St. Louis, January 1, reads:

"We beg to inform you that the business heretofore conducted under the firm name of O. W. Meysenburg & Co., will be continued by the same parties under the firm name of Littlefield & Meysenburg."

For some time past the street railway business of the firm has been largely managed by Mr. Littlefield, and it was a happy compliment in Mr. Meysenburg, whose interests are both large and varied, to thus use Mr. Littlefield's name at the front end of the firm title.

THE DETROIT ELECTRICAL WORKS, through Louis E. Myers, their active Chicago manager, has secured a big order from the Calumet Electric, of this city, and will furnish in addition to all the station electrical equipment, twelve motors of forty horse-power each, ten generators 100 kilowatts and a switch-board which it is said will be the finest in the west. It is needless to say that the order was secured against very strong competition. Mr. Myers also sold six motors and two generators the same day to the Racine road.

QUEEN & COMPANY, incorporated: Among recent business changes of special interest to the electrical fraternity is the transferring of the business of James W. Queen & Company, Philadelphia, to a stock corporation bearing the title Queen & Company, incorporated. The new company starts with a paid capital of \$600,000, which will be increased from time to time as may be required for the extension of its numerous interests, which, in addition to electrical measuring instruments, comprise scientific apparatus of every description. The incorporators and directors for 1893 are S. L. Fox, R. B. Fox, J. G. Gray, W. Biddle, Jr., J. G. Biddle and F. W. Stanwood, all of whom have been actively connected with the old firm. E. G. Willyoung continues as superintendent of the electrical laboratory.

THE NATIONAL FARE BOX COMPANY is making a fare box that is as good as a Hall Safe. The following letter tells its own story:

LIMA ELECTRIC RAILWAY COMPANY, LIMA, O., Oct. 22, 1892.
National Fare Box Company:

GENTS: We have to-day shipped to you by Adams Express fare box No. 723, made by you. We received a new car last week and put it into service Wednesday evening. The box unlocked all right on Wednesday night but we could not open it Thursday. I took it to a locksmith but he could not open it so thought it better to return it to you. Please have it fixed immediately and return contents in box.

THE LIMA ELECTRIC RAILWAY COMPANY, W. H. THOMPSON,
Secretary

C. & G. COOPER, by their Chicago agent, Mr. Hayes, report a flourishing trade. The shops are running night and day, with more orders coming in for future delivery. The western branch has secured an order for five engines from the Fred. W. Wolf Company, of Chicago, and is now installing 350 horse-power tandem, compound condensing at Galesburg, for the Paving Brick Company, and but recently sold Chas. Pope Glucose Company, of Racine, 100 horse-power. Mr. Hayes has every reason to be proud of his success and of the success of his installations.

AMONG recent sales of the Goubert Manufacturing Company, 32 Cortlandt street, New York, sole makers of the Goubert Feed Water Heater, we notice the following: Negaunee & Ishpeming Street Railway & Electric Company, Negaunee, Mich., 350 horse-power; Urbana & Champaign Electric & Street Railway Company, Champaign, Ill., 600 horse-power; Mutual Light & Power Company, Montgomery, Ala., 700 horse-power; Edison Electric Illuminating Company, of New York, 2,000 horse-power; Edison Electric Illuminating Company, of Brooklyn, N. Y., 1,000 horse-power; West Side Street Railroad Company, Elmira, N. Y., 400 horse-power.

THE SHULTZ BELTING COMPANY, St. Louis, had an exhibit at the St. Louis exposition, and the following incident was the result of a visit of a small Divoll-school boy. The teacher who had just finished an elementary astronomy lesson, in review questioned the above mentioned small boy: "Johnnie, what makes the earth and moon spin around like tops?" "That there strap," answered Johnnie promptly. "What strap?" inquired the mystified teacher. "Well, that there strap I seen on the pitcher card at the exposition what had the machine chopping up pieces of leather and a pitcher of a strap running around the earth and moon and making 'em spin like tops." And then the teacher sat down and reflected on the subject of advertising as an educator.

THE ELECTRIC RAILWAY EQUIPMENT COMPANY, of Cincinnati, O., started in business the first of last July, in the manufacture of their patent wrought iron and steel tubular poles and electric railway supplies for all systems. The first month they were in business they furnished some 1,200 of their patent jointed poles to the street railway lines at Evansville, Ind., and have since supplied their poles to different lines at Cincinnati,

O., Covington, Ky., St. Louis, Mo., and other points, and are now rushed with orders, but have the best of facilities for furnishing poles on short notice. Their factory is pushed to the utmost with orders, for their overhead line work, pinions, bearings and motor repair parts, and trolley wheels for all the different systems. They are adding many new patterns and putting in much new machinery, and aim to keep up with the rapid progress of their line of business.

THE CROSSLEY CAR BRAKE COMPANY not only brake cars but keeps right along breaking its record for sales. A recent letter from the Brooklyn Street Railroad Company is self-explanatory. The letter bears date of Nov. 15, 1892, and in it Samuel Harris, superintendent, says: "Your rope brakes put on our Jennings Avenue Line some months ago are giving us good satisfaction. They are the easiest on the men, the motors and cars and the cheapest, most simple, durable and effective and cost least for repairs of any brake we have ever used or have knowledge of. We have concluded to equip our Wilson and Scoville avenue lines with them. Please send us a dozen at once for a starter." The company has met with large sales the latest being equipments for the Chattanooga & North Side Street Railway Company, Chattanooga, Tenn., Chattanooga Electric Railway Company and the Montgomery & Cloverdale Electric Railway Company, Montgomery, Ala.

McINTOSH, SEYMOUR & COMPANY, of Auburn, N. Y., are still running twenty-three hours per day, putting out engines for every variety of work, especially for electric railway and light plants. Among recent sales we notice one 1,200 horse-power, double tandem compound condensing for the Syracuse Electric Light & Power Company, Syracuse, N. Y., having a new style frame; another ball and socket, self-oiling pillow-block bearings, auxiliary shafts carrying the eccentrics and governor to a seven-foot face fly wheel to carry two belts. The machine will weigh 125 tons. At Elmira, N. Y., two engines have been sold. One is a 600 horse-power, four cylinder, vertical, triple expansion and one a 350 horse-power tandem, compound condensing railway engine. Both of these are for the Elmira Illuminating Company. Two 500 horse-power standard, compound condensing, self-contained engines, have also been ordered for the East River Electric Company, New York City, and the Edison Illuminating Company, New York. These are among the largest and heaviest in the country, weighing forty tons each with eleven-inch shafts. Foreign orders include a 250 horse-power standard compound for Durban, South Africa, and three 150 horse-power, same type, for the Union Elektricitats-Gesellschaft, Berlin. Besides this list other orders make a total of 7,000 horse-power, exclusive of the above mentioned. The company has magnificent and deserved success.

THE MASSACHUSETTS CHEMICAL COMPANY are varnish makers in general, with offices at 8 Oliver street, Boston, 60 and 62 Broadway, New York, and 390 Con-

gress street, Portland, Maine. Their factory and laboratories are at 165 and 167 A street, South Boston. The company is particularly interesting to the electrical fraternity as manufacturers of Insullac, a new insulating compound adapted to armature windings and other work where a smooth, rapid-drying insulator is needed. Insullac is perfectly waterproof, does not require baking, contains no acids injurious to any material. It may be applied with any metallic fastened brush and it can in no way effect the health of the workman. Samuel Barnes, chief electrician of the Grand Rapids Consolidated, says in a letter dated Dec. 16, 1892: "I have used gallons of your Insullac for armature winding and can gladly say that it is better and cheaper for insulating purposes than shellac and gives satisfactory results for all you claim for it." President Hill, of the Hill Electric Company, 133 Oliver street, Boston, says under date of Dec. 7, 1892: "We have used your Insullac on all our factory work for the past three months and I am pleased to report that it has given the most satisfactory results. We have been doing some fine work that required extra good insulation which from the character of the work was difficult to secure with ordinary methods. We tried Insullac and it filled the bill. I feel safe in recommending it as far superior to any insulating compound I have ever seen." The compound can be made as thin as desired and can be supplied at short notice from any office. Harry Bishop is Chicago agent.

TRIAL OF THE CONNELLY.

THE REVIEW representative attended the first trial trip, last week, of the improved Connelly gas motor, which was taken out on the north side line for its initial run. Superintendent Lynch, of the Connelly Motor Company, who has redesigned the motor in many particulars, acted as motorman and has every reason to feel proud of his work. The new friction gear gave no signs of springing and the whole machine acted in a very satisfactory manner during the test. It was first run around the Fullerton and Webster avenue loop pulling a trailer. At one point it came up behind a heavy Love electric motor car with trailer that had lost the trolley wire and pushed it for some distance at good speed. It is evident that starting an electric motor car, with its high speed armature, is not light work but the Connelly stood up to its work and, with the use of sand, could probably do much more. The car was then taken down on the Clark street cable line as far as Division street and maintained its speed with the grip cars. The foundation for the gas works to supply these motors with fuel is already in and more cars will be put regular service before long.

A PETITION with 600 signatures asking for a new trolley line in the Thirteenth ward, Philadelphia, is a strong testimony since these 600 names were once signed to an anti-trolley petition and the 600 owners of the names swore many dire swears to keep the trolley out of the ward.

WINTER RESORTS.

THE profitable revenue which is derived from the establishment of pleasant summer resort attractions along the line of so many roads, find even better results this winter with many companies who are providing good skating.

One of our traveling representatives reports a very large number of winter resorts in Pennsylvania, among the best of which is the skating park at Lancaster. The company secured control of a small lake at the terminus of one of its electric lines, and at trifling expense keep a man in charge; the ice nicely swept; a cheap but comfortable shelter in which to warm and rest; and lights with current from the trolley wires. President Coyle says it draws far better than a summer resort. We know of a number of roads which are allowing this business to take care of itself, when by a little effort and nominal expense the receipts from this source might be increased many times. Give the public something to go to, and they will do the rest.

A SPEEDY SPLICE.

THE Washington Street Cable or Tunnel Loop of the West Chicago Street Railway Company was injured on December 31st, at 3:30 p. m., by a careless gripman not letting go at the proper place. As a result the cable was stranded nearly 4000 feet. After the damaged strand was removed, the cable was started up again and ran until 12:30, when it was stopped, and preparations made to run a new rope in, which was accomplished in one hour and twenty minutes. The cable is 10,475 feet in length, the first splice being made in twelve minutes, and the permanent splice connecting both ends of the new rope was made in twenty-six minutes. The balance of the time was consumed in running the cable into the conduit.

THE Wabash road has put on a new equipment of vestibule cars. Coaches are seventy feet long and will seat eighty passengers. All cars have toilet and smoking compartments, and are lighted with Pintsch gas and heated with steam. The Chicago-Detroit line is just completed and is seventeen miles shorter than any other route. Passenger service will begin over the new route in about three months. The road will be run in connection with the Grand Trunk, West Shore, and Fitchburg lines, making an important new service from Chicago to the seaboard, each road furnishing a quarter of the equipment.

THE Amalgamated Association of Employes at Cleveland has died for want of a head. The men didn't want to pay the officers and the officers were not in it for their health.

AN industry known as the Chicago Naptha Motor company for street railways wishes to settle at Braidwood, Ill. Hon. Wm. Mooney offers to give the necessary land for the factory.

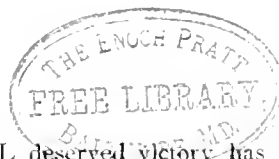

WINDSOR & KENFIELD,
PUBLISHERS AND PROPRIETORS,
269 DEARBORN ST., - - - CHICAGO.
Published on the 15th of each month.

SUBSCRIPTION, - - - TWO DOLLARS.
FOREIGN SUBSCRIPTION, - - - 20 SHILLINGS.

Address all Communications and Remittances to THE STREET RAILWAY REVIEW
269 Dearborn Street, Chicago.

H. H. WINDSOR, Editor. F. S. KENFIELD, Business Manager.

CORRESPONDENCE.

We cordially invite correspondence on all subjects of interest to those engaged in any branch of Street Railway work, and will gratefully appreciate any marked copies of papers or news items our street railway friends may send us, pertaining either to companies or officers. Address:

THE STREET RAILWAY REVIEW,
269 Dearborn Street, Chicago.

Entered at the Post Office at Chicago as Second Class Matter.

This paper member Chicago Publishers' Association.

VOL. 3. FEBRUARY 15, 1893. NO. 2

ONE of the advantages of the Anti-Sunday car regulation in Toronto, Canada, was discovered on Monday, when it was found the rails had become so securely embraced in the icy grasp of winter that it was impossible to operate the line until near noon.

DURING the past month two of the best known presidents have withdrawn from active service. Dr. A. Everett, of Cleveland, who has been at the helm for thirty-three consecutive years past, and Wm. Richardson, of Brooklyn who has been so prominent a figure in the street railway interests of his city for twenty-five years.

ELECTRICITY having thrown the street car mule out of a job, bids fair to supplant in the very near future that field of usefulness on canals also. The trolley is in every way adapted to this work, and it is to be hoped the effort now making in the New York State legislature to bring about the change may be successful.

WONDER is that out of all the hundreds of thousands carried daily by the street car service of the country, the number of fatalities is so few. The annual report of the coroner of the county of which Milwaukee constitutes the largest portion of inhabitants shows that the three unusual classes of accident namely, scalding, falling down stairs and drowning in cisterns, were each responsible for more deaths than the street railway.

A WELL deserved victory has been gained in the Supreme Court of Pennsylvania over the obstreperous teamster who delights himself in obstructing a car track. The case is mentioned elsewhere and will serve as a valued precedent, especially as the decision of Justice McCullum was a reversal of the verdict in the lower courts.

WASHINGTON dailies and correspondents have been full of direful tales of a general closing of fire insurance offices in Brooklyn, and a refusal to renew old risks or write new ones—all on account of the advent of the trolley. We have taken pains to carefully investigate the report and find it utterly without foundation. Rates have been advanced in Brooklyn, but from other reasons and wholly independent of the trolley, which had no influence whatever in the matter. The same is true of Boston, Buffalo and other cities.

POWER HOUSE and car house fires have been so numerous in the past two months that the question is forcing itself upon managers as to the relative advantages and dangers of large as against small buildings. Opinion, however, seems largely to prevail, that the larger buildings can afford more frequent and careful inspection, and certainly on many accounts are more economical to maintain than several smaller structures. We print elsewhere, this month, the views of several leading managers on this question.

CONTINUED cold weather which marked the greater part of the month of January was a severe test on the coal supply of the country. A few electric companies were "called short" on their supply and were forced to shut down in some cases an entire day. Fuel is as essential to the operation of an electric line as passengers, and it would seem that ordinary foresight in this respect should leave no chance for excuse for failure from this cause. No road should carry less than a four days' supply in constant reserve during winter months, and a week is little more than a safe limit.

IT is two years now since a bill was last introduced in the legislature of this state providing for three cent fares. The only reason this length of time has been allowed to lapse in this careless manner is entirely due to the fact that it is now two years since the legislature last met. The same old bill, with the same old ear marks has been introduced by one Berry; whether a black Berry or a white Berry we are not informed. In the Chicago market February berries come high. Mr. Berry has assumed a great life work on behalf of his agricultural constituents who, when they visit the city once each year, are compelled to yield up a hard earned nickel for a ride of 10 miles in a comfortable car, which same distance in a lumber wagon over a rough road could not be purchased for five times the price. It is a curious circumstance that this class of sand bag legislation is generally introduced by some back woods representative, whose district has less than a dozen miles of street railway all told.

IN the department devoted to street railway interests at the World's Fair, printed elsewhere in this issue, will be found our announcement of the plan formulated by the STREET RAILWAY REVIEW for helping our readers to desirable boarding and lodging places at any time during the exhibition. This has involved a large amount of work, and will demand much more as the Fair opens, but we have made a special department for this purpose, and like everything else undertaken by this paper, the plan will be carried out in a thorough and business-like manner. Our friends are invited to avail themselves of this opportunity.

WERE the subject any less practical and commendable, the good people of Connecticut might well be thought to have gone crazy on the subject of electric roads. No less than thirty-one charters are now pending for the incorporation of lines, many of which will certainly be built and others not unlikely. The explanation in this phenomenal waking up is due to the fact that no legislature has been held in four years, and a general desire prevails to secure charters against future needs. The volume of electric railway business which is already in sight in the wooden nutmeg state offers a very attractive field to the manufacturer and dealer in railway supplies.

SOUTHERN roads are not expected to be equipped to combat northern snow falls, and there is little wonder the big January storm found them ill prepared. The energy with which the means at hand—in most cases simply men with shovels—were used, reflects great credit on the various managers. One road in West Virginia gave up the ship and its lines were dead for a period of forty-eight hours, but the rest gave valiant battle. One manager was in the saddle continuously for forty hours. In Chicago the storm was the hardest to handle of any since the historical January blizzard of 1888, but cars were operated with little delay and no suspensions. "Bucking" snow is a prodigiously expensive amusement, a very little of which goes a long ways.

BROADWAY with its modern transportation facilities now about completed would present a strange picture to a returning Knickerbocker of the ante-Sharp days. The construction of the cable system thereon has been one of the most gigantic municipal undertakings of the age. An hundred difficulties presented, any one of which might well discourage men of less perseverance than those who have had the enterprise in charge. But from start to finish the work has been prosecuted with diligence and intelligence and now stands as a lasting monument to the men who dared to undertake so large a work. The annoyances attending construction will all be soon forgotten by the public, who will in so large a measure enjoy the fruits of others' enterprise and money, and a suggestion to return to a former condition of affairs would raise a tempest of remonstrance. The engineering problems solved have called for and given opportunity to effort never excelled in any chasm or mountain summit of the far west.

JUDGE BAKER, of the United States Court, sitting at Indianapolis, has handed down an opinion in the case of the Lake Erie & Western strikers, that, while eminently dignified and humane, most clearly and forcibly sets forth the necessity and majesty of the law. It is printed in full in this number and should be thoughtfully read by every street railroad man in the country, from president down to the least important position. The judge recognizes the right of labor to organize for any and all legitimate purposes, and for such commends the same; but draws a sharp line between organization for betterment of condition as against organization for unlawful purposes. He sounds the keynote when he states that violation of the law by an organized body is no less criminal than the same overt act when undertaken by the individual, and points out the danger the workingman would bring upon himself if deprived of the protection of the law he so heedlessly and, in some cases thoughtlessly violates. To overthrow law would be to return the laborer to the prevailing evils of the dark ages, and call back the days when feudalism ruled.

THE announcement of the decision of the directors of the Philadelphia Traction Company to thoroughly overhaul and reconstruct their entire cable system is a matter of the highest satisfaction, not only to the citizens of that city, but the advocates of the cable system. At the time when the lines in question were built the cost of cable work was nearly double what it is to-day, and the experience which has come from fifteen years of cable operation did not exist. The management took chances and expected to make a much cheaper construction answer the purpose. The result is too well known and has proven anything but satisfactory. Frequent stoppages, annoying delays and break-downs followed one another in such rapid succession as to largely unpopularize the cable system in Philadelphia. Reconstruction has been the constant history of the road from its opening day, and while of late years many evils have been remedied, the system was far inferior to the cable systems of Chicago and other cities. Hence the wise decision to thoroughly rebuild will enable the company to guarantee a first-class service. The moral of a first-class construction is too apparent to even need cursory mention.

AN increase in two years of 30,000,000 passengers over the preceding twelve months is the astounding record which is shown in detail elsewhere. St. Louis is the city. While there has been a healthful growth in population there has been nothing in the nature of a boom, and the figures can be explained in only one way—rapid transit. The splendid cable and electric lines of St. Louis are equaled by no other city of its size in the world. In the good old horse days the people of St. Louis frequently found it more expeditious to walk than ride. Now all this is changed, and residents undertake frequent trips to other parts of the city because the time consumed in transit has been made so short. The excellent management of the St. Louis lines has, of course,

largely contributed to this result, but first-class rapid transit is almost synonymous with first-class management. Other cities and towns which are exerting unwise efforts to curtail the prime value of mechanical traction by a foolish restriction of the speed limit may well study the policy of St. Louis, which some envious persons have called "slow" but which is anything but that in the matter of street railway facilities.

AS an instance of the consummate meanness of which some people are capable, the recent damage suit of one Dr. (?) C. Steiner against the Pittsburg Traction Company is but a single case out of many—how many, is only known to the claim departments of our large roads. In the trial the leading witness confessed he was hired to give testimony which had been written for him by Steiner, who in fact had admitted he had never been in an accident on the defendant's road, and that he was resorting to leeches and irritating drugs to produce inflammations, sores, and other phenomena, as necessary "exhibits" before the jury. It was also proved that Steiner had worked the same game on a steam railroad and secured a large amount; the promise of a trip to Germany being the compensation of his chief witness in that case. We could cite a very large number of similar cases which have come under our own personal notice. It is hard to imagine a more despicable and abhorrent practice than the disfigurement of the human body as an aid to infamous blackmail suits. The duty which the Traction Company owes the fraternity and the public, is to follow the case up and land the culprit in the penitentiary. Such matters should not be allowed to go by default, nor should the company be satisfied to escape the payment of blood money which was so narrowly averted. The courts certainly cannot but inflict the full penalty provided by law if the injured company does not withdraw objection. A few convictions, a few more blackmailers clothed in stripes, and the story and sequel of the case industriously circulated through the press, will exert a most helpful and moral influence, and do much to purge the courts of a large number of cases, which, if only the truth could be uncovered, would prove the basest prostitution of law and justice.

A BILL is pending before the Connecticut legislature for the appointment of a "Board of Street Railway Commissioners," to consist of one lawyer, one electrical engineer and one "business man." None of the board may have any pecuniary interest in a street railway or any appliance sold same. Great care seems to have been thrown about the proposed commission to prevent the inevitable disaster of having a board which might possibly know anything about the business for which it is created. Even the electrical engineer may fill the "bill" and still know absolutely nothing of the actual operation of a street railway beyond the technical and mechanical features of electrical construction. If the mover of the bill really wanted to create a board in the fullest capabilities suggested by the act, he should have further stipu-

lated that each member should be both deaf and blind and a resident of the county not less than fifty and of the state not less than eighty years. The "electrical engineer" is not so bad, but the "business man" is open to suspicion, and the "lawyer" is simply dreadful. In other states roads are planned, built and made servicable to the public with a simple charter from the secretary of state and a franchise from the city in which the tracks are laid. The method admits of progress that is progress and not a weary nursing into life, which is the history of such enterprises in Connecticut and some other states. It is a matter which concerns the city and not the state. The people of any city are obviously better qualified to know what their special needs are than any commission ever appointed by any governor. It is a useless, needless, excuseless complication to strain matters through an additional sieve, which does nobody (but the commission) any good and is a restricting of local rights along a line which prevails in the Old World, and is in direct variance with the spirit of a free and independent people.

THE public in nearly all the northern cities have indulged in considerable ill-timed and inconsiderate complaint through the columns of the daily press, at the street car facilities. It is true the cars have been crowded to an uncomfortable and unusual extent. There is, however, a good reason for this, and the manager has a wide margin of excuse this winter. It is interesting to take up one daily after another until the leading papers of a dozen or more States have thus been examined. In all of them on the same day, and about the same time, the writers really seem to believe themselves the most unfortunate of mortals. But could they only know the same experience has been an almost universal one there would doubtless be both comfort and patience in the thought. The aforesaid reason is that the demand on street car service this winter is a wholly unprecedented one. This winter has been the most severe on street car operation of any in the past five years. During that time cities have grown enormously, down-town districts have become greatly congested, and the public have been educated up to a high standard of mechanical service which breeds impatience of delay, which, under the old horse regime was philosophically accepted as part of the inevitable, and then aroused sympathy which is now turned to complaint. The winter has proportionally been much harder on street car operation than on the steam roads; although on the latter the arrival of a train on time was the exception, and yet people found no fault. In addition to difficulties of operation there has been a tremendous increase in riding from people who during the past few winters have been accustomed to walk or use carriages. This season these two methods of transportation have been well nigh impossible. The public also have largely increased their short riding owing to difficulty of getting about. All this has taxed the car accommodations to the utmost, which, under ordinary conditions, would have been ample, and all an ordinary business could afford. If any one could have predicted the existing weather, not

less than eighteen months ago, it would have been possible to have ordered extra cars built to meet the unexpected want. We have yet, however, to hear from any one who did so forecast the future. The public, then, should in all fairness give the unhappy manager his due—most of him would be satisfied with even less—and remember when compelled to stand on the homeward trip that such conveyance is a big improvement over walking, and then sign a petition to Uncle Jerry Rusk to get out an injunction on this kind of a “winter of our discontent.”

AND now comes the mayor of Brooklyn with a proposed bill to tax the gross receipts of the surface roads; and with a mild sarcasm invites the local presidents to come before him on a certain day that he may draw pleasure from their distress. It was shown that the companies are already taxed in no less than eight different ways, and that any addition would not only be a hardship but a discrimination and positive injustice. Among the speakers was Wm. Richardson, whose thirty years' experience at the head of a Brooklyn company specially fits him to discuss this question, and which he sums up as follows:

“Why,” he asked, “should any criticism apply to the business of street railroads, provided they give the highest degree of accommodation to their passengers at the lowest rates of fare at which the service can be rendered. The fact that they can make a return to their stockholders, after long years of patient waiting, in many cases without any dividends being paid at all, is no reason for taxing them unequally. The company with which I have had the honor to be connected, has made during the twenty-one years of its existence an aggregate of \$832,653, in dividends, being at the rate of 5.15 per cent on the outstanding capital stock during the whole period of existence. I claim, Mr. Mayor, that it is to the interest of the city to encourage the street surface railroads to the highest form of development, holding them rigidly to their obligations for the accommodation of the people, rather than to attempt, by annoying penalties and taxations, to limit and cripple their future development.”

ALTOGETHER the most sensible and practical suggestion that has been made in all the volumes of schemes to give Boston rapid transit, is that proposed by a Mr. Chester. This gentleman bases his arguments on a fact which seemed to escape others; that is, that Boston already has rapid transit but under present conditions receives few of the benefits. As a matter of fact almost no city in the country is better provided with electric cars, but certainly in no other city is their operation attended with more difficulty. This is not the fault of the equipment but of the unfortunate condition of streets. Boston streets will never be less crowded than now; the necessity for cars will increase not diminish. Mr. Chester recommends for the congested district that certain streets be widened; that others be cut through; that wagons be allowed to occupy their width only; that all work on roadway be done at night only; that a standard maximum load be established by law, proportioned to the weight of the animal drawing it; that loads requiring much time in delivery be handled at night—such as safes and similar loads which now cause blockades. These and other suggestions would reduce the present causes of blockade to a large extent, and blockades removed, rapid transit at once has a chance to assert itself. To reconstruct the business

streets of Boston is an undertaking of such magnitude and expense that no wonder is occasioned that each generation evades the duty and passes it on with ever increasing difficulties to the next; but it is a question which will surely have to be met and solved some day and only a courageous and radical treatment will ever give permanent relief. Then, too, a sentimental regard for the antiquities has ever proved a barrier to progress in Boston, utterly out of keeping with the needs and good business sense of the present age. In Chicago nothing is allowed to block the wheels of progress. Churches, schools, asylums, the residence of the oldest settler all have to clear the track when the car of progress comes along. True all these institutions are cared for in other and frequently better localities, but in these days few landmarks are so valuable but that occasion may arise when absence serves a better purpose than presence.

TO the title of the “New South” may soon be added the “New Orleans,” now that its first electric car on February 1st entered on its mission of supplanting the lazy little mules which have for so many years been employed to get up motive power. The construction work has been free from the difficulties of heavy grades, as the city is an almost perfect level, but the pole planting called out the ingenuity of the engineer, owing to the yielding nature of the soil. Other lines are speedily to follow, and a great stimulus to activity may confidently be expected when the city shall have become fully electrified. No city in the country is better adapted to use the electric system than New Orleans. The opening ceremonies occasioned the greatest enthusiasm.

IN both the Ohio and Illinois state legislatures bills have been introduced making it obligatory on street railway companies to use winter cars with inclosed platforms. We do not, however, consider the measure either wise or necessary, and it is very evident the framers of these bills have no practical experience as to the details of street railway operation. It is true that during several days of the present winter the weather was so severe as to render the front platform on undesirable place to spend the day; but, let us ask the senator, during the past six years, which more than covers the use of electric railways, how many such days have there been in Ohio and Illinois? It is well known that running a car against a snow or rain storm so completely blinds the glass windows of the vestibule that the driver cannot see his track or passengers on the sidewalk desiring to stop the car; and the conservative opinion of a very large majority of the managers who have had most experience, is that the inclosed platform would very greatly add to the danger of operating. We earnestly advocate all reasonable and practical means to promote the welfare and comfort of the men, and it is too obvious to even discuss the advantage to the company of so caring for its employes; but we are convinced the remedy is in wearing heavy clothing and not as contemplated in the act. Why not pass a bill requiring drivers to wear fur coats?

THE LOS ANGELES CONSOLIDATED ELECTRIC RAILWAY.

The Finest Electric Railway Plant on the Pacific Coast, and one of the best in the Country—History of its Organization and Construction.

LATE in 1850 a party of capitalists casting about on the Pacific coast for a desirable investment in street railway property were confronted with two propositions. One was to construct a line in Oakland and the other was to construct a line in Los Angeles. Oakland offered the projectors a bonus and was in need of an additional system of street railways. Los Angeles to the contrary held out no inducements and was supplied with street railways. The splendid system of roads of the Pacific Cable Company had been completed but two years before at a cost of \$3,000,000 and, notwithstanding the efficiency of the service, it had

than before. Besides these spots on what might be called colonies or centers of population, dotted here and there within the city boundaries, the city has grown marvelously in the direction of the lines of the cable railway. But the growth has not clustered along the rights of way of the cable. To the contrary it has spread, tapering away off until much of it became practically out of the reach of the cable, so that the system came to afford a very poor service to some districts, and the need of additional railways became to people living therein a serious and pressing matter. The district of the city known as "The Hills" comprising the elevated section west of the center

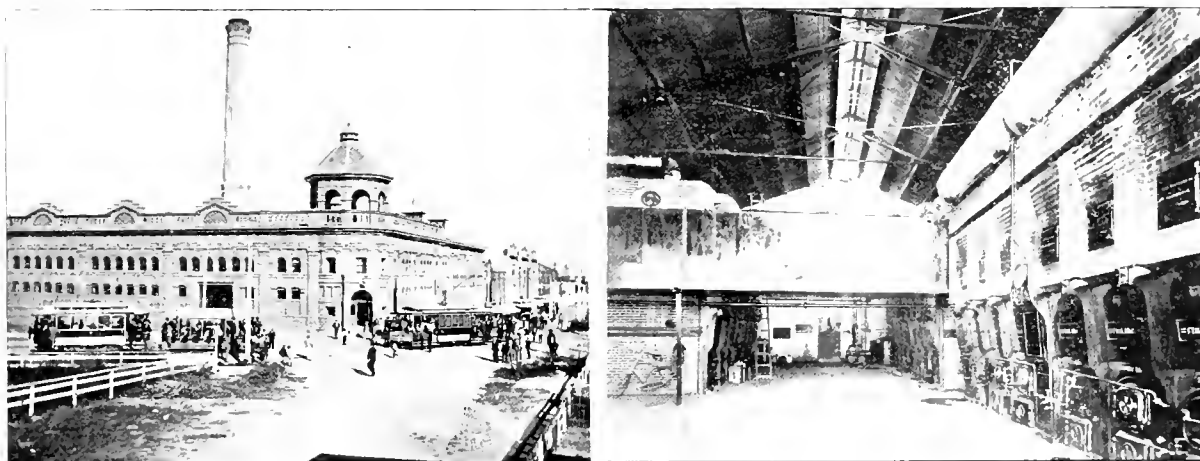

POWER HOUSE AND CAR BARN—BATTERY OF STIRLING BOILERS.

made but poor returns on such an investment, the system had been placed under heavy mortgages and a squabble was pending between stockholders and mortgagees as to who should escape with the least loss. The cable company's lines were built in the shape of an elongated cross and reached into the eastern, western and southern portions of the city. These branches penetrated the suburbs and there is no question but they contributed immensely to building up the outlying sections of the city. But even in sections reached by the cable company there were large areas equally as populous as those immediately tapped by its lines which were so remote from those lines as to be altogether unprovided by a railway system. Los Angeles has encountered a phenomenal growth and this growth has been, as it were in spots, dotting the great stretch of land enclosed by the boundary limits of the city, and this growth has been greater per annum since the cable company completed its system

of the city, had been furnished several years before with a service consisting of a small cable line; which continued in service about two years and then went to pieces, partly through poor construction and partly through bad management. During the period of its existence, however, it built up that part of the city, rendering it quite populous and a desirable quarter in which to live. When it collapsed it left the residents along its lines in a sore plight; they had built houses on high hills difficult of access without the aid of a car line from the business center where most of them were employed, hence they commenced immediately to clamor for a service upon the stumbling down of the cable and their demand for several years continued a "crying one."

Another part of the city unsupplied with a railway service at the time of which we write was Pico Heights. As was the case with "The Hills" this section was settled up by a line of street railway which quit business

just about the time, had it been legitimately run, when it should have begun to pay. A rapid transit company operating an electric line had developed out of a scheme to sell lots on the heights. The road was operated subsidiary to the business of selling lots. Every purchaser of a lot was given a bunch of free passes, and the purchasers being many, very soon the road was running entirely on a free pass basis. The lots having been all sold and the purchasers holding great quantities of these passes there was nothing in operating that road for the next year or more except to redeem those free passes. This the proprietors did not care to do so the road was permitted to subside. The condition of the people they had beguiled to this extremity of the city, was worthy of sympathy. They had their car service suddenly cut off; many of them had to move temporarily away; while others remained and continued to make the welkin ring with their demands for cars.

sioner of streets and was thoroughly acquainted with all the thoroughfares. With his assistance the lines were marked out and the council readily granted the franchise. A power house and car barn were built on the corner of Central avenue and Wilde street, an entire block of land being purchased there for the site. The buildings are handsome edifices of brick, fronting 150 feet on Central avenue and 435 feet on Wilde street. The power house is ornamented with Arizona brownstone, the whole structure covered with an iron roof supported by a net work of iron beams and trusses, making the entire absolutely fire proof and really one of the finest and most complete power houses in the country. This power house is ornamented over the main entrance on the corner by a tower and is made one of the distinguishing land marks of the city by a handsome chimney 154 feet high.

This power house was equipped with two 700-horse-power double engines triple expansion, built by the

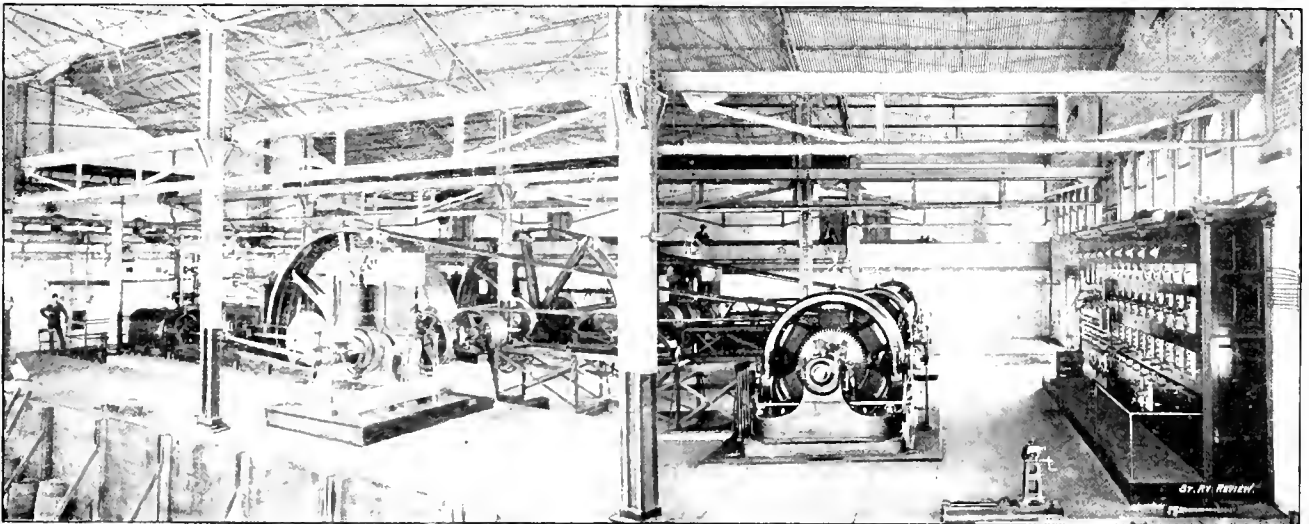

INTERIOR VIEW OF POWER STATION, LOS ANGELES CONSOLIDATED ELECTRIC RAILWAY.

Then there was the district along Maple avenue and Seventh street, tending westerly from the center of the city. This, too, had been traversed by an electric railway operated under the Daft system; but this like the others had disappeared, leaving its patrons to mourn its loss. Besides these were numerous systems of horse lines, whose patronage entirely justified the operation upon their routes of superior electric cars, and the absorption by a large concern of the several companies was a matter, which as results have shown, would easily succumb to an attempt.

Accordingly a company was incorporated with a capital stock of \$3,000,000, and with Gen. M. H. Sherman president, E. P. Clark vice president and manager, F. V. McDonald treasurer, and A. W. Barratt superintendent. The company organized, it at once set to work. Lines were built to reach the sections where roads were most needed and which are indicated above, all lines passing through and connecting in the business center of the city. Captain Barratt had recently left the office of commis-

Golden State & Miners Iron Works, of San Francisco. Each engine operates 740-horse-power of generators. These engines have been a marvel of smoothness in running, have each developed more power than contracted for and have been successes in every way. The drive wheels are respectively 17 feet and 19 feet in diameter.

One engine drives two 250-horse-power Westinghouse multipolar generators and one 240-horse-power Edison generator; the other engine drives one 500-horse-power Westinghouse multipolar generator and one 240-horse-power Edison generator. The 500-horse-power generator was the first of that size built in this country and has a capacity of 700 electrical horse-power. The same may be said of the two 250-horse-power Westinghouse machines; they were the first two of that size ever built in this country and they were built expressly for this company. This is, therefore, the first plant in this country installed with generators of large units, and the success of their operation has fully proven the wisdom of the experiment.

The boiler rooms are equipped with 1500-horse-power of the Stirling water tube boilers, comprising three batteries of 500-horse-power each. These boilers are believed by Mr. Clark and others to be the most efficient and economical boilers in use for large plants. The fuel used is oil, supplied by the Santa Paula Oil Company, but coal can be used as well.

The power house further contains a machine shop which is the most complete in its equipment on the coast, outside of San Francisco. In this a motor can be made complete, and all the repairs and rebuilding of either motors or cars are done in this shop.

The car house is immediately in the rear of the power house, separated only by a small open court. This is built also of brick of the same pattern as the power house and contains space for 60 cars. It is provided with transfer tables and all other conveniences.

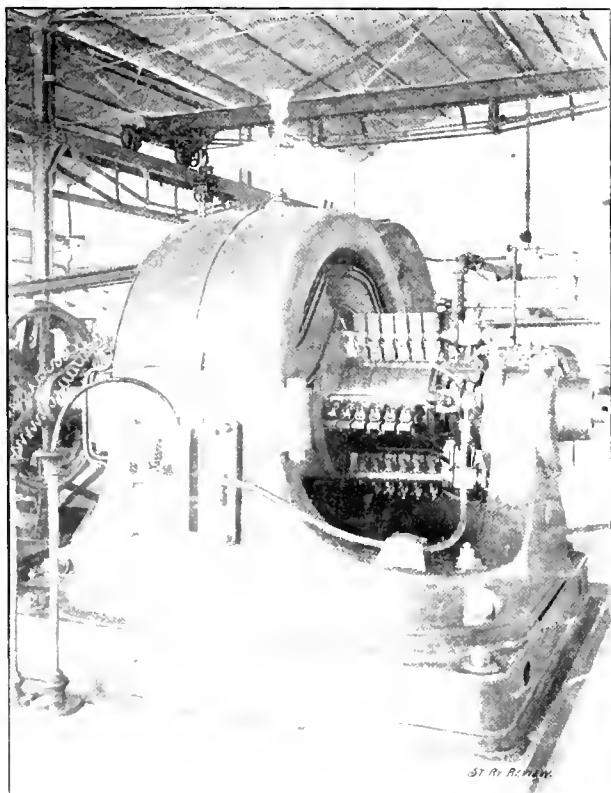

ONE OF THE WESTINGHOUSE GENERATORS—LOS ANGELES CONSOLIDATED ELECTRIC.

The construction of the road bed is one of the most substantial features of the entire plant. Part of it was built under contract with the Pacific Rolling Mill Company and part was completed by the company itself. The trackage is mostly of 15 pound girder combination rails of the Pacific Rolling Mills pattern, laid on iron ties imbedded in cement, making a most secure and permanent mode of construction, there being no ties to rot out and little repair work required.

The line material is uniform throughout. The poles are neat and of the same size; they are 12 inches square at the bottom and from 6 feet up taper to 8 inches square at

the top; they are 30 feet long, with six feet in the ground; the corners are all chamfered; they are all painted and present an ornamental style of line construction.

There is, including ground wires, feeding wires and trolley wires, over 120 miles of copper wire mostly sizes 0 and 000. All of the line construction has been done in the most careful manner.

The rolling stock includes 45 electric cars, 15 of which are double truck, open at the ends and seating 48 persons. Builders represented are J. G. Brill Company and

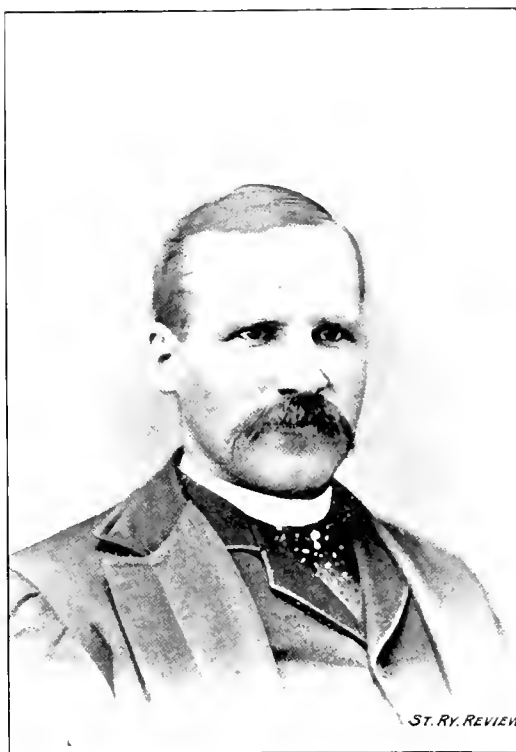

GEN. M. H. SHERMAN, PRESIDENT.

the St. Louis Car Company. Motors are single reduction Westinghouse, and have given splendid service. One line is a series of grades from 5 to 13 per cent with deep cuts and immense fills. Lines are as follows:—

DIVISION.	MILES.
Second street.....	4.5
Depot.....	3.5
Maple avenue.....	3.5
Vernor.....	5.5
Pico street.....	3.75
Elysian Park.....	3.25

A consolidation of the properties of the electric with the cable company in all probability will be completed at an early date. This means what the name of the company implies, viz.: The Los Angeles Consolidated Electric, whose plant as it stands now is the most extensive on the coast, and one of the finest in the country.

A few words need yet be said of the moving spirits of this great enterprise. It has resulted mainly from the activities of two men—Gen. M. H. Sherman, the president, and E. P. Clark, the vice-president and manager. Gen. Sherman is only 38 years old and looks much

younger. He was born in New York but came to the coast twenty years ago and early identified himself with the young and promising territory of Arizona. For a number of years he held the position of superintendent of public instruction and later of adjutant general of the territory. He is now a capitalist on a wide scale. He owns more real estate in Phoenix, Arizona, than any single man there, his tax bill being the heaviest; he is sole owner of the Valley Street Railway, of Phoenix, is a large owner in the water system of Phoenix and heavily interested in the Great Arizona Canal Company, which controls all the irrigation waters of the Salt River Valley.



GENERAL MANAGER E. P. CLARK.

General Sherman's success is due to his own efforts. He inherited none of this world's goods and came west poor. He is to-day one of the most striking figures in western development. His energy is restless and irresistible and his brain power appears equally strong. Yet a young man and a millionaire of his own making it is perfectly clear that the future for this man holds great things.

E. P. Clark was born forty-five years ago in Iowa, and came to Arizona twenty-five years later on account of his health. For ten years he was county auditor in Arizona, and subsequently became engaged in an extensive manufacturing lumber business, also in mining and drilling. He is a man of wide practical knowledge and experience in handling of men, and under the matter of fact business methods he has introduced in the operation of the company, the enterprise has been a success from the start, and is destined to be a property of great value.

DID THE OSTRICH ACT.

AN unusual accident in Cleveland recently deprived an employe the use of his head for awhile. The East Cleveland sweeper rounded a sudden curve precipitating one of the crew, head first into the sand-box. The grinding machinery bruised his head and fractured his skull, but his prospect for life is still good, and after this he will refrain from putting his head in the sand.

PEORIA PUSH AND PLUCK.

MANAGER FINLEY, of the Central City railway, Peoria, believes in pushing things. Before the smoke had ceased to rise from the ruins of his power house, new generators had been ordered and were shipped part of the way by express and on the home stretch by special train. In the mean time arrangements had been made with a paper mill for use of water power, and foundations and feed wiring completed. The fire occurred on the early morning of January 16th, and the 550-horse-power generator was in place and operating five cars on the 26th, only ten days after the fire. The temporary return to horses was quite enough to make the Peorians realize the superior advantages of electricity.

ANOTHER LARGE INTER-URBAN SYSTEM.

WHAT promises to be the most extensive suburban electric railway in the world has just been organized as the Central Massachusetts Railway Company at Worcester, Mass. The new company is composed of the Worcester, Leicester & Spencer, the Worcester & Millbury and the Worcester & Southbridge lines, together with proposed extensions and additions aggregating forty miles of new track and trolley. The entire system will bring seventy-five to eighty miles of electric under one management.

The most remarkable thing about the scheme is the large number of towns within the thickly settled area about Worcester that will be connected and inter-connected by this web of track. Cities, towns, villages and hamlets to the number of twenty-six, as follows: Worcester, Marlboro. Spencer, Leicester, Millbury, Shrewsbury, Northboro, Westboro, Grafton, Sutton, Northbridge, Upton, Auburn, Oxford, Charlton, Southbridge, Sandersdale, Webster, Wilkonville, Farmersville, Fisherville, Rockdale, Jamesville, Rochdale, North Grafton and Saundersville. The popular summer resorts in the surrounding region will be touched by the lines, and mail and express service is to be instituted. A schedule of fares is to be issued. As the steam road connections are very poor and the coach and tally ho facilities nearly as bad, the possibly 200,000 people in the district will be greatly pleased with and duly patronize the new system.

A STREET railway employe in Rockford, Ill., has recently fallen heir to \$3,000,000.

THE BROADWAY CABLE.

The Most Difficult Enterprise Undertaken by a Street Railway—A Magnificent Construction—Massive Machinery—Handsome Power Stations—A Stupendous Triumph of Engineering Skill.



Since the Pennsylvania Iron Works Company have now in successful operation the first cable power plant of the five stations which they have in course of construction for the Broadway and Third Avenue cable lines in New York City, our readers will be

glad of the opportunity to inform themselves of the progress made in this important branch of railway work in the great metropolis.

It is impossible with words and the engraver's tool to adequately present the immensity of the undertaking, the difficulties of which arose each day like a morning fog, and the splendid triumph of energy and brains over all. To only those who bore the burden and heat of the day,

man to an end in the following year by the death of heart-broken Jacob Sharp, on April 5.

But the difficulties which confronted the builders of the Broadway cable were no whit less discouraging, although of a different character, than those which impeded progress in former years. We refer to the condition of Broadway itself—the sub-Broadway as it were. For more than 50 years there had been an ever increasing network of gas, water, electric, steam and other pipes and conductors burrowing their endless lengths beneath the busy street, and when at last as a sort of judgment day, all these works were uncovered and laid bare, the picture was one to astonish even the best posted in such matters, and enough to discourage and turn back any man or company possessed of even more than ordinary courage.

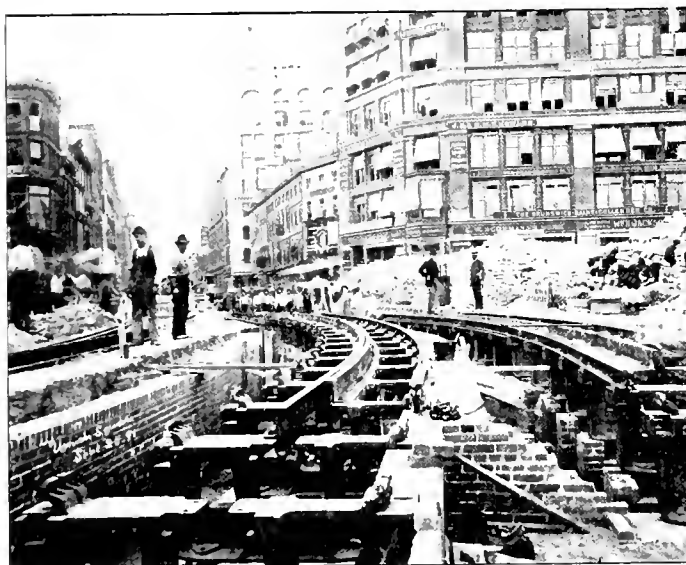

CONSTRUCTING A CURVE.



A FEW "DIFFICULTIES,"

and we might add, the chill and exposures of many a stormy night, can ever have a true appreciation of all that is conveyed in the three words, "Broadway is cabled."

The history of rapid transit on Broadway is interminably mingled and coincident with the life and labors of Jacob Sharp, who from 1850 until 1884 kept up a gallant fight for a surface line along this thoroughfare. Jacob Sharp when a young man began the public agitation for a horse car line from the battery to Manhattanville in the summer of 1851, and kept up a ceaseless combat with the opposition until August in 1884, when the ordinance was passed over the Mayor's veto and the injunction of the court. A. T. Stewart, one of the most astute figures in New York municipal history, was Sharp's heaviest opponent. Without ceasing, the endless Irish tenacity and the bull dog firmness of Jacob Sharp hung to the idea for 30 years. His successive troubles culminating in an unproved indictment for bribery in 1887, brought the contest of one

The fight was a long and bitter one, but skill, patience and great expense finally overcame all, and to-day the energies which find their current in the iron arteries beneath Broadway are in an orderly, systematic condition that is not to be compared with the chaotic mysteries of the ante-cable days.

THE TRACK

is probably the most substantial of any in existence—certainly the best on this continent. The lines being divided into four sections, as follows:—

1st section—South Ferry to Bowling Green.....	1/4 mile
2nd section—To Houston street.....	2 miles
3rd section—Houston to Thirty-seventh.....	13 1/2 miles
4th section—To Central Park at Seventh avenue and Fifty-ninth street.....	1 mile

The yokes are cast iron, weigh 550 pounds each, and are 5 feet 2 1/2 inches long, 37 1/4 inches high to bearings and 12 inches wide at base. They are spaced 4 feet 6 inches from center to center. Each rests on a concrete

foundation 45 inches long by 18 wide and 6 inches deep. The conduit is 24 inches deep and 15 inches wide, formed of concrete and brought up to sustain the pavement next the rail. Carrying pulleys are cast iron and measure 14 inches diameter to bottom of groove, which is chilled and the ground perfectly true and smooth. Each pulley with its shaft weighs 35 pounds and are spaced to intervals of 31 feet 6 inches. At such points the conduit is enlarged to form a pulley pit 42 inches long, 37 inches wide and 48 inches deep. Sewer connections are as frequent as necessity requires.

The track rails rest directly on the yokes, are grooved girder, made by the Johnson Company and weigh 91 pounds to the yard. Joints have received special attention and instead of resting on yokes are made 13½ inches between them. The splice is a fish plate, 16½ inches

section" and weighs 40 tons. Ropes are 1½ inches diameter with the usual hemp core and were made by the John A. Roebling Sons Company, Trenton, N. J., and the Trenton Iron Company. As already noted there are two similar ropes in each conduit, (except on the first section) so that in any possible case of strand there will always be the reserve rope which can be started up on a moment's notice, hence inspection and repairs are not confined to night work, and it is very difficult to imagine an accident which can cripple the line.

THE GRIP

used is the double, side opening, with fixed lower jaw and rope ejector. It is 37 inches long over all, with die lining 23 inches long. It weighs complete about 450 pounds and is similar to Robertson's. The gripping power is 90 pounds to the square inch, fully 2,000 pounds total.

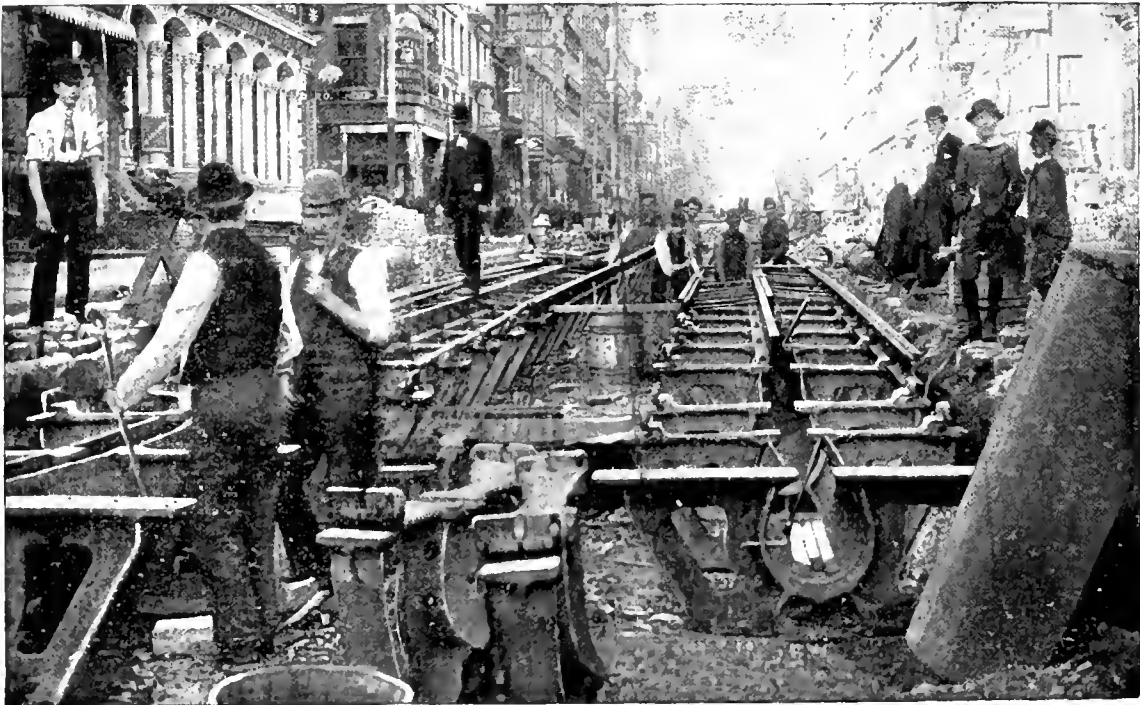

LAYING THE RAILS: LOOKING NORTH FROM CANAL STREET.

(From Engineering Magazine.)

long, weighing 12½ pounds each, fastened with four 1-inch bolts and the McConway & Torley clamps. The slot rail is 7 inches deep, weighs 67 pounds per yard, is firmly braced to the track rail with iron rods, and forms a slot ¾ inch wide. The pavement on and between the tracks is of Maine granite.

The curve work is the best possible and the admiration of every observing engineer and railway man. The rope is conducted on horizontal wheels, on separate shafts for the upper and lower (alive and dead cables) ropes, no cone pulleys being used. Diameter of curve wheels at bottom of groove is 30½ inches.

THE CABLES

are seven in number (three of which are the reserve cables) and have a total length of nearly 11 miles; the longest being 21,000 feet. This rope is on the "second

THE CARS

are marvels of beauty and comfort, no expense having been spared in their construction, as has been the rule throughout the entire system. The Laclede Car Company has delivered its sample car and will have 25 more ready within 30 days, being a part of their order for 100 cars. They are 22 foot bodies, 33½ feet over all, extreme width 7 feet and roof 10 feet 4 inches above rails. The ceiling is in natural light woods and very light and handsome. Windows are glazed with English crystal glass, cushioned with rubber to the sash which is cherry. There are 8 large, high windows on each side, and shaded with rich spring roller curtains. The double doors at each end are of cherry. Seats are covered with best Wilton carpet and all the metal trimmings are solid bronze. At night cars are lit with 3 center cluster lights of Pintch

gas. Both ends of cars are plentifully supplied with safety hand rails of brass and the steps are of specially easy ascent, hung low, and have rubber treads. The braking system is the design of the engineering department of the road and is powerful and positive. At sides and ends of platforms wire life guards are placed. Platforms are large and capacious, each end being closed at one side to prevent accidents from persons jumping on or off between passing trains. Special provision is made for quick ingress and egress, the doors being very large and opening simultaneously by one motion, and with approaches near the steps.

The John Stephenson Company also furnish one hundred cars of their Bombay roof type, on their own trucks. They are same dimensions as those already described and like them seat 30 passengers.

One power house is now ready for service and another nearly so. The completed plant is



BLASTING BROADWAY.

THE FIFTY-FIRST STREET STATION,

situated on the block bounded by Sixth and Seventh avenues and Fiftieth and Fifty-first streets, formerly occupied by the old horse and car barns. This plant will drive the cables on the upper end of Broadway and Seventh avenue, the first rope for which started on its endless journey on the last day of January, of this year. The structure is of brick, well lighted from good sized windows, capacious and convenient. There were no special difficulties in the way of its construction.

THE BOILER ROOM

has been specially well laid out with a view to convenience, ventilation and applicability for its purpose. The boilers are six in number and are of the patent Heine safety type, of 250-horse-power nominal capacity each. They are set in the most approved manner recommended by the builders, and are also arranged in connection with Gallager furnace, and the McCaslin device

for handling coal and ashes, located in a large trench immediately beneath the boiler ash pits. The grates being dumped deliver into the chutes or hoppers from whence they pass into trucks below running on tracks which lead to a convenient dumping place outside. Coal is conveyed to the boilers by the same means, except that the tracks are elevated to the surface of the boiler room floor, and the load is weighed before being dumped into the coal bank, which is arranged along the fronts of the boilers. The steam upon leaving the boiler is conveyed to the engine, through an elaborate system of steam piping, especially arranged for high pressures, as the working pressure of this plant will be 150 pounds. The piping is so arranged that any of the boilers can be cut out of service without in the slightest degree handicapping the efficiency of the plant.

Automatic pressure regulating valves are provided with each boiler, thus maintaining a nicety of regulation of steam pressure on each of the boilers.

The boiler room also contains the boiler feeding pump devices. The heater is of the well known Goubert style of 1,000-horse-power capacity. The pumps are of the Snow make. There are two 10 by 5 by 10 Duplex pumps. The high reputation which these pumps have established for themselves since their introduction on the market renders special comment upon their merits unnecessary in connection with this article; suffice it to say, however, that pumps of this make have been installed in nearly all of the cable power plants throughout the country which have been recently constructed. Particularly has this been the case with the stations installed by the Pennsylvania Iron Works Company.

The engines are two high-pressure Dickson-Corliss, with cylinders 36 inches in diameter by 60 inches stroke. The fly wheels are 24 feet in diameter and weigh 80,000 pounds each. The main shaft is 18 inches diameter in the bearings and 20 inches in the swell. Engines are rights and lefts and are placed at opposite ends of the main driving shaft, to which they are coupled by means of large plate couplings with cross keys and bolts. The shaft is supported on extra large bearings, which are substantially mounted on heavy stands anchored to the foundation masonry by 2½-inch by 10-foot anchor bolts. Power is transmitted from main to drum shafts by rope transmission, the main shaft drivers being four in number, 10 feet in diameter and carrying 2-inch cotton ropes. They are fitted with phosphor-bronze bushings being intended to remain idle on the shaft when not thrown into use by means of improved friction clutches with which they are engaged. This admits of the use of either, or all pairs of rope drums at will. The driven drums are 32 feet diameter built up in segments with centers mounted on hollow steel shafts which are supplied with independent bearings.

The cable drums are of the solid type, 12 feet diameter, both being driven. They have five removable rims, in which are turned grooves.

The system of tension apparatus which is in use is that commonly known as the direct system, and in this instance

is contained in a tower of structural iron, and is about 40 feet high, thus enabling a very wide range of movement from the tension carriage. The means of lengthening and shortening the tension of dead ropes is provided on the end of the tension carriage and is of the usual drum pattern, arranged to operate with worm wheel and gear.



THE HOUSTON STREET POWER STATION.

There is provided in conjunction with this plant a pair of auxiliary reversing engines, specially designed for use in the operating of the idle cable, and they are connected to the shaft by means of gears, which are mounted on either side of the several plate couplings. By the use of a patented sliding pinion gear, these engines can be made to operate either half of the entire plant, while the other half is in full operation and propelling cars. Thus it will be readily seen that a very important feature is well provided for, viz., the practicability of making speedy changes in new cables and examining the idle rope at any time during the 24 hours, as it must be remembered that in the duplex system, while the rope is in operation continuously, no chances can be taken which will in any way involve the stoppage of the system. With this constantly in view, the builders of the plant have been careful to consider every point which would make these plants perform the functions required of them, with the least possible chance of tie-up, and thus prevent any hitch in any part of the machinery which could possibly extend beyond a very few moments.

In order to appreciate the immensity of this room and the ponderous machinery installed, one must needs make it a personal visit. The room is 100 by 260 feet, and contains no columns or other obstructions to the view of the machinery.

The foundations for this plant are built entirely on bed rock and in consequence of this it was necessary to elevate the machinery and its foundation about 14 feet above the originally contemplated level. The foundations are built of brick and stone, and are faced up with Philadel-

phia pressed brick, making a very striking appearance and indicating from the very first entrance in the building the substantial manner in which all of the work in connection with this monstrous undertaking of installing the cable system on Broadway has been done. The machinery is fully in keeping with its magnificent home.

THE HOUSTON STREET STATION

as shown in the illustration, is a handsome business block nine stories high, erected at a cost of \$700,000 for the building, which fronts 125 feet on Broadway and 200 on Houston street, occupying the northwest corner. From the exterior there is little to suggest the mine of power safely installed in the basement, which was excavated to a depth of 42 feet below street level for the purpose.

The plant is fast nearing completion and will be the largest of them all.

The engineering difficulties which were required to be overcome in the preparing of the foundations for the immense machinery plant, can best be told by the Broadway and Seventh avenue Railroad Chief Engineer Major G. W. McNulty, and would of itself make a very interesting article to our readers, and we will therefore refrain from touching upon these points at this time, and confine ourselves alone to the enormous undertaking of installing the largest cable railway plant which up to this time has been attempted, we believe, in the world.

The foundations for this plant are also entirely made of brick, and have been very carefully laid out, in order to provide ample weight and surface for the machinery, at the same time keeping clear of the numerous columns which are contained within the basement for supporting the large building. At no point whatever do the foundations for the machinery and the building come in contact with each other; thus primarily overcoming any possible

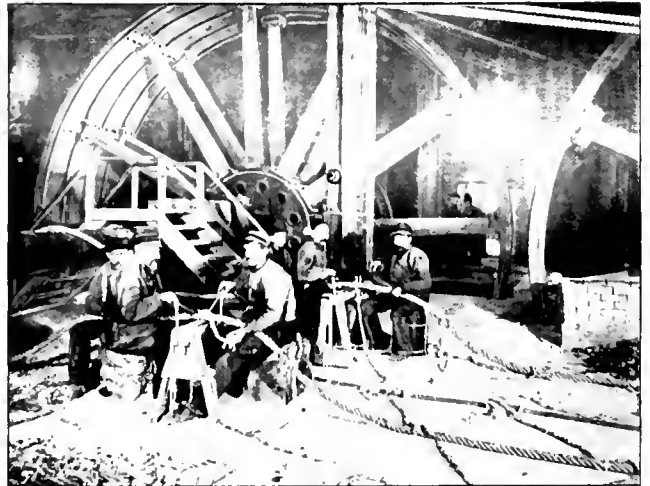

SPLICING THE TRANSMISSION ROPES.

chance for vibration being telegraphed through the building, which would necessarily annoy tenants.

From this station will be operated two live ropes, and there will also be led the two duplex or reserve ropes.

The machinery for transmitting the power of these ropes in service of the very naturally increased traffic in

the lower part of the city must necessarily be very much heavier than at other stations. To compensate for this there will be introduced four engines of the Dickson-Corliss high pressure pattern, with cylinders 38 inches diameter by 60 inches stroke. They are arranged in pairs of rights and lefts and transmit their power to a main jack shaft through a rope wheel, which is 26 feet in diameter, built up in the sections and mounted on a shaft which is 20 inches in diameter on the journals by 26 inches in the

mounted. These are four in number, 10 feet diameter each, and contain thirty-four grooves for 2-inch diameter cotton rope, and like those previously described for the 51st street station, are mounted loose on the shafts and are engaged for services with a similar clutch device. The capacity of each of these friction clutches, it might be stated, is known of 1,000 horse power. In combination with the jack shaft is also arranged a pair of duplex auxiliary engines of the reversing motion, for the same

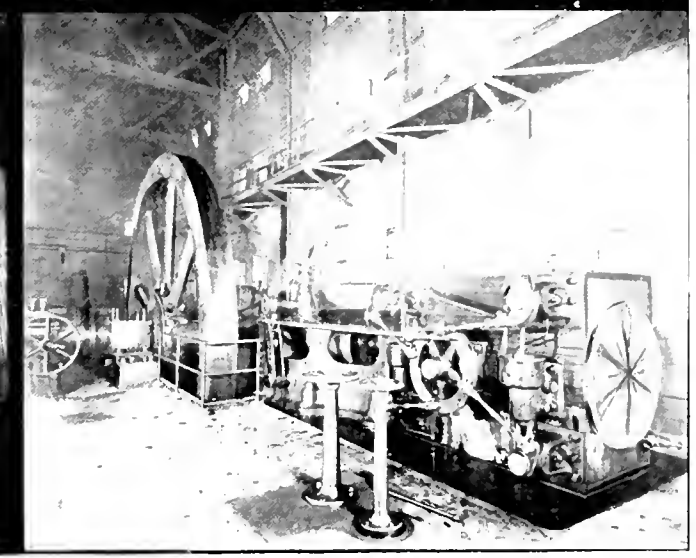
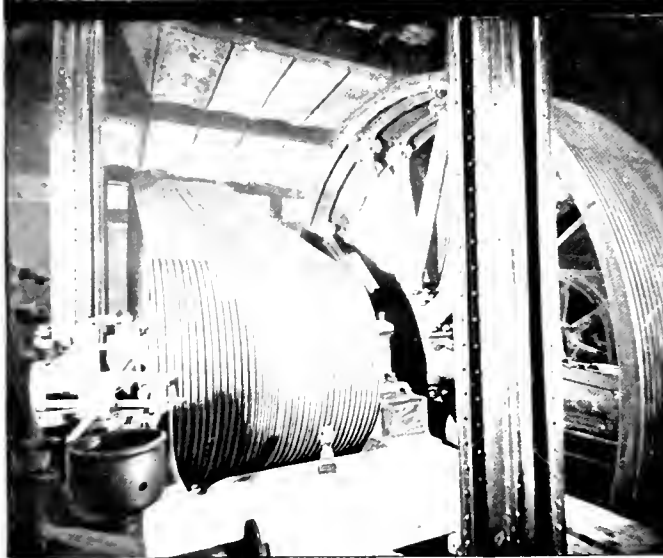
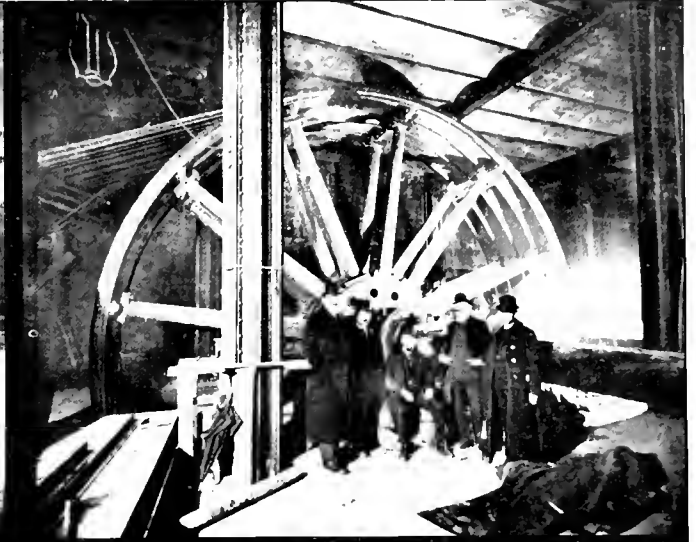
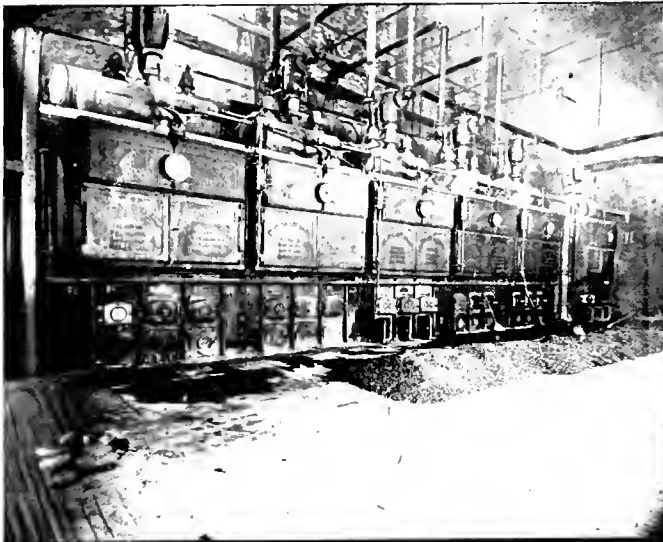

HEINE BOILERS AT 51ST ST. STATION.
ROPE DRIVE AT HOUSTON ST. STATION.

32-FOOT WHEEL AT HOUSTON ST. STATION.
ENGINE ROOM AT 51ST ST. STATION.

(From Flash-Light Photographs by the REVIEW ARTIST.)

swell. A half plate coupling is provided on each end whereby connection can be made with the corresponding half coupling fitted to the respective engine shafts, so as to enable the use of either one of the engines for the purpose of driving either complete set of the cable driving machinery. The 32 feet rope wheels contain twenty grooves of 2-inch diameter for cotton ropes. The main shaft extends the full width of the building within a few feet and is 18 inches in diameter, with 20-inch swells, where the loose rope driving drum pinions are

purpose as stated for the other end of the line. From these 10 feet diameter rope drums the power is transmitted to the first and second driving shafts, for each half of the winding machinery. The arrangement of this part of the driving machinery is so as to make substantially two complete systems, entirely independent of each other. There are eight cable drums of the solid type, 11 feet in diameter, each containing five grooves, and are made substantially the same as those described at the other stations. In fact, it may be stated that the general

arrangement of this machinery, so far as its immediate relation to the cable drums is concerned, is in every particular like that of the other station, except that in all of the parts the dimensions have been very materially increased. For instance, the connecting shafts are from 20 to 28 inches in diameter, to suit requirements of the condition, many of the bearings being 20 inches diameter by 36 inches long. The cable driving pedestals are also made especially large. The most interesting feature of this station to a general observer and a mechanic alike, is the ponderous proportions of the large cotton rope drums, which are 32 feet in diameter and contain thirty-four grooves for 2-inch diameter cotton ropes. The rim segments are made the entire width of the wheel and are mounted on two centers with two distinct sets of arms. The boilers which will be used for generating steam for this plant will be twelve Heine patent safety, 250-horse-power each, arranged in two batteries of six each, and are so connected to the engines by the system of steam piping that will enable the use of any of the boilers to the exclusion of any that may be put out of service, and likewise with the engines. There have been supplied here three 10 by 6 by 10 Snow pumps for the boiler feed service and two 1,000-horse-power capacity Goubert heaters. Condensing water is obtained from six tube wells, each 86 feet deep. The smoke-stack is concealed by the building walls and is 220 feet high.

In this plant the tension runs and appliances are all arranged underneath the floor and are consequently hidden from the view of the visitor. The steam piping is arranged so as to be kept out of view in the power room, being carried underneath the floor. To suit the location the tension apparatus here will be somewhat of the modification of the one employed at Fifty-first street station, but the same principle is maintained,

Special facilities have been provided in each of these plants for the handling of any of the parts which for any cause might need repairing or examining, by the introduction of portable and hoisting appliances. In fact, it may be said that no expense has been spared to provide any appliances in either of these plants, or throughout the entire system, which could in any way contribute to its efficiency or perfectness.

SPLENDID ELECTRIC LIGHT SYSTEM.

The station will be as light as day from its own electric lighting plant of 5,000 lights capacity. This plant will represent the very latest developments in electrical work. The choice of engines, dynamos, wire, etc., was left entirely with H. Ward Leonard & Company, the bulk electric contractors, and they have selected Siemens & Halske dynamos, Ideal engines, and Habirshaw wire. The dynamos will be direct coupled, that is, will be placed upon the main shafts of the engines. The engines and dynamos will run at 300 revolutions per minute.

The voltmeters and amperemeters are of the Weston manufacture, and the rheostats are of the new and enamel type, made by the Carpenter Enamel Rheostat Company.

All of the wiring will be done in interior conduits.

The switches will be of special design, and made expressly for this building.

There will be 1,900 lamps in the engine room, the lamps being arranged in coronas upon the columns.

The electric plant will be in operation about the middle of March, and will thereafter be in continuous service night and day.

For the owners, President John D. Crimmins has not spared his own strength or comfort to secure to them a system that will be one of the finest railway properties in the world. His fine executive ability has found a constant occasion to display itself, as one knotty problem after another presented, commanding instant decision and where a mistake in judgment meant wrong construction which could never be rectified.

To the Pennsylvania Iron Works Company belongs the credit of building and installing the several thousand tons of machinery, and the work already accomplished will be a lasting monument to W. L. Elkins, Jr., its president, general manager B. W. Grist and A. E. Moore the superintending engineer of construction. The contract taken by the Pennsylvania Iron Works was one of the largest and most exacting character, and their satisfaction is naturally proportionate to their efforts, now that installation has reached a point where the merry travel of the engines and uniform and noiseless gliding of the endless ropes tells the story of accomplished success.

STREET RAILWAY GAZETTE CHANGES OWNERS.

THE Street Railway Gazette, Chicago, has again changed hands. It is now controlled by J. H. McGraw, president, and C. E. Stump, business manager of the Street Railway Journal of New York. The rumor that the Gazette was to be removed to New York is now denied. A strong effort has been made to conceal the identity of the new owners, but we have it from absolutely reliable authority. Edward Caldwell, recently of the Electrical World, has been selected to represent the McGraw-Stump interests here and has entered on his duties as editor.

LORD SALISBURY, formally opened the Liverpool, England, elevated electric, February 4. Lord Salisbury first visited the generating station and started the engines. Then his lordship, accompanied by the Earl of Latham, Lord Kelvin, the electrician, and the mayor of Liverpool, entered a car and traveled over the line at a speed of 22 miles an hour. This line was described by the REVIEW in 1890 and is operated by electricity.

THE NEW JERSEY TRACTION COMPANY, organized to gain possession of the Jersey City lines, has selected its site for the erection of a gigantic power plant. The syndicate has possession already of the Newark Lighting Company's plants.

OPENING OF THE FIRST ELECTRIC IN NEW ORLEANS.

THE era of electrical progress began in the metropolis of the South on February 1, 1893, with the baptismal trip of the New Orleans & Carrollton Electric Railway at New Orleans.

For many months past the engineers and contractors for the road bed have been battling with the almost bottomless mud and sand upon which the old city is founded and finally after conquering this succession of troubles from water, mud and quicksand, the road is turned over to the owners.

On the opening day Chief Engineer A. Langstaff Johnston, Superintendent C. V. Haile and deputation of all the prominent business men of the city, mounted the beautiful St. Louis Car Company cars, and were whirled through the city on the wings of electricity. Wondering crowds, white and negro inhabitants, greeted the new power with cheers and with exclamations of delight. The day was a perfect one and no auspicious incident was wanting to prophesy bon voyage to the envoy of progress. Aristocratic old families left their high born repose to stand out in the open air to watch the progress of the car. Pedestrians stopped and looked back as long as the cars were in sight, while the more demonstrative school children and colored people cheered like mad. It was a gala day for New Orleans.

THE EQUIPMENT OF THE ROAD

is modern in every respect, and installed with the care that characterizes the labors of A. Langstaff Johnston, of Richmond, Va., who has been engineer in chief.

The power house, situated on Napoleon avenue near the river, for convenience to water supply, is 85 by 125 feet in dimensions. Here are installed three Babcock &

The cars, when the entire order arrives from the St. Louis Car Company, will number fifty. Thirty of them are painted green, ten red and two yellow, to denote



C. V. HAILE, SUPERINTENDENT.

their routes. Each car is equipped with a 25-horse-power General Electric single reduction water proof motor and is 18½ feet in length.



THE INAUGURAL TRIP—NEW ORLEANS.

Wilcox boilers of 300-horse-power, and three engines, Lane & Bodley compound condensing, of 300-horse-power, furnished by C. S. Burt & Company, of New Orleans. The engines are connected to three 200 Kilowatt Thomson-Houston dynamos. The car barn, near Carrollton avenue, is 128 feet wide by 265 feet long, with paint shop and repair facilities in connection.

J. G. White & Company, of New York, were contractors for the overhead construction, for which the Ansonia Brass & Copper Company furnished the wire.

The rail is divided as follows along the 10 miles of line: Five miles of 50-pound steel T, made by the Belleville Rail Company, of Birmingham, Ala., and sold by G. Herbert Ellerbe; five miles of Johnson girder, and a

considerable amount of Duplex Strt Railway Track Company's specialty. This order is the first of the kind in New Orleans. Center pole construction is used.

Chas. Munson Company furnished the belting for the power plant from their New Orleans house.

One of the specialties introduced in the power house is the electric current disconnecter, made by the Johnston Safe Automatic Electric Company, of Richmond.

The officers of the company are J. Hernandez, president; Walter V. Crouch, secretary, and Chris V. Haile superintendent.

So much of the success of the installation of the line has depended upon Mr. Haile that we are pleased to present his features as those of the first electric railway superintendent in the Crescent City. The engraving of the trial trip tells better than words the keen interest that the new line has aroused.

The New Orleans City & Lake Railroad, of which H. Mitchell Littell is the manager-elect, will follow this event with the changing of his line from the mule to electricity within the next twelve months.

STURGES' SLEET TROLLEY WHEEL.

ATROLLEY for cutting sleet from the wire has been invented by William H. Sturges, superintendent of the Utica Belt Line Street Railroad Company. Instead of being solid the wheel has spokes and is divided into halves, one of which is shown in our engraving. Each half is free to turn independently of the other, and the groove for the trolley wire is made very deep and narrow, being, in fact, just wide enough for the trolley wire. The shoulders on the edge of the groove act to break the ice before the trolley wire begins



INSIDE VIEW OF HALF OF STURGES' SLEET TROLLEY WHEEL.

to make contact in the bottom of the groove. This trolley has been tried in several sleet storms with success and without the usual sparking.

The wheels, as shown us, are made of cast brass and are very light. When sleet begins to fall it is simply necessary to replace the usual wheels with the "sleet cutters" and the traffic goes on without interruption.

No one who has ever had anything to do with trolley wires in a heavy sleet storm can fail to realize the field there is for an invention of this kind. It is cheap but wonderfully effective and will save many a road from

tribulation. If sleet is allowed to form the trolley wire will be practically insulated, and, unless there is some quick way to clear it, traffic will either be stopped or slowed to such an extent as to cause much complaint.

ANNUAL MEETING NATIONAL ELECTRIC LIGHT ASSOCIATION.

THE annual meeting of the National Electric Light Association, the sixteenth occasion of which is February 28, will be held in the Bell Telephone building, corner of Tenth and Olive streets, at St. Louis. This meeting will be of more than passing interest to street railway men, as many of the subjects under discussion are closely related to street railway practice. The program includes the following papers: "Under What Conditions is the Use of Water Power Economical?" L. B. Stillwell, Pittsburg; C. S. Bradley, Ft. Wayne, on "Long Distance Transmission of Power;" R. H. Sterling, Denver, "Some Experiences with Alternating Systems;" E. A. Armstrong, Camden, N. J., "Morals of Corporations;" Captain Wm. Brophy, Boston, "Electrical Insurance;" with papers by Dr. Bell, Boston; William Stanley, Pittsfield, Mass., and Professor Weston, of Newark, N. J. Professor George Forbes, the London authority on long distance transmission, may be present and read a paper and Professor Elihu Thomson will take part in discussion. The crowning event of the meeting will be the lecture at Music Hall on Tuesday evening, by the brilliant Nikola Tesla, in which some experiments will be performed.

It is not often that the West is honored by so distinguished a group of electricians and this meeting should be greeted by a large attendance of all electric workers.

WHERE TO BOARD IN CHICAGO.

THE STREET RAILWAY REVIEW, realizing the annoyances and inconveniences that strangers will experience in securing a desirable stopping place when away from home, and which will be largely increased in Chicago during the Fair, has formulated a plan for assisting its readers in this dilemma.

We have already secured a large list of desirable places, including hotels, good boarding houses and suitable private families, where accommodations may be had for any length of time desired, and ranging in price according to the location and accommodations. Thousands of the best families in Chicago will open their homes for a limited number of guests each, and such places will on many accounts afford specially desirable quarters. We know the demand will be large, but expect to have a supply that will be ample. Readers desiring further information will please address the REVIEW, stating about what time they desire accommodations, for how long and to what extent. We make no charge for this service.

THE People's Traction Company of Philadelphia, succeeds the People's Passenger Railway Company.

McDONALD'S BROAD RIPPLE PURCHASE.

CONSIDERABLE excitement was caused in street railway circles at Indianapolis, some time since, by an unknown individual who appeared in that city without any name or address, and began investigating the famous Broad Ripple franchise which has been in statu quo for nearly two years.

The excitement was finally allayed when it later became known that R. T. McDonald, of Ft. Wayne, was the principal in a deal that contemplated the reviving, buying and galvanizing of the right to build an electric line between Indianapolis and Broad Ripple. Dr. Cal. Light is the present holder, but litigation and other troubles have prevented the building of this much needed suburban route.

Mr. McDonald says that any litigation against the road will be fought to the court of final resort, and that he represents no scheme, combination or syndicate. He is sure that the road would pay and is willing to attempt it. He wishes a 30-year franchise, agrees to pay 2½ per cent for the first 5 years, 5 per cent for 15 years and 7 per cent for the remaining 10 years. Mr. McDonald contemplates an additional complete system of suburban connections. New franchises will be asked and no doubt given.

We wish to assure the good people of Indianapolis that their Broad Ripple road is perfectly safe in Mr. McDonald's hands. He is a man of no ordinary mind or experience.

Ten years ago R. T. McDonald was a poor man. Today he is one of the financial pillars of Ft. Wayne, a town noted for its wealth. Mr. McDonald is yet this side of 50 and a native Indianian from Steuben county. When he was a young man he went to Ft. Wayne, entering a dry-goods establishment of which he was afterwards third owner. His business career was interrupted by a long and honorable war record, but returning to Ft. Wayne resumed the art of peace with the same fire and enthusiasm.

Mr. McDonald braved the uncertainties of inventions and became president of the Jenney Electric Light Company. The concern grew, was added unto and has made its backers wealthy.

Mr. McDonald is thoroughly interested in street rail-

ways at Ft. Wayne. New Orleans and other points, with business connections with literally hundreds of other enterprises. He is a Scotchman with all a Scotchman's tenacity, and an American with all an American's shrewdness.

Mr. McDonald is a firm, fighting Republican, a public-spirited citizen and a thorough gentleman. A number of good stories of his earlier life are told at Ft. Wayne. It is said that once when poor and unknown he applied to a hotel for lodging, but was refused because he had no baggage. Mr. McDonald told the land-lord that some day he would come back and buy him out. Ten years later the prophecy was fulfilled. His application for a loan of \$25 was refused once by a bank. Five years later his check for \$125,000 saved the same institution from ruin. A great admirer of Judge Gresham, he bitterly opposed Harrison's nomination at the last republican national convention and took the Ft. Wayne Blaine club to Minneapolis at a cost to his own pocket of \$9,000. Nothing daunts him. He goes into nothing rashly, and we prophecy final triumph for the Broad Ripple line and R. T. McDonald.



R. T. McDONALD.

THROUGH the kindness of D. O. Beldin, of the Aurora Electric Railway, the University Extension lecture delivered by Professor Thwing, of the Northwestern University, was illustrated with a 500-volt current from the trolley.

THE Metropolitan, of Kansas City, has had a daily increase of 2,200 fares during the past year.

MASSACHUSETTS RAILWAYS.

ON the thirtieth of September, 1892, Massachusetts had 81.4 miles of street railway, an increase of 190 miles over the previous year. Of this 492 miles were wholly or in part electric, with one storage battery line. The aggregate capital stock is \$23,540,536, an increase of \$4,000,000. There were 193,760,783 passengers carried, an increase of 18,000,000. The average received for transportation of a passenger was 5.07 cents, cost 3.85 cents. The total dividends were \$1,582,668, an average of 6.72 per cent against 5.63 of preceding year. Fatal accidents numbered twenty-six.

STREET RAILWAY LAW.

EDITED BY MR. FRANK HUMBOLDT CLARK, ATTORNEY AT LAW, CHICAGO.

Ordinance requiring Street Railway to pave part of Street.

Under an ordinance requiring a street railway company to keep the portion of the street between its tracks, and two feet on each side thereof, in as good repair and condition as the city keeps the balance of the street, it is the duty of the street railway company to pave said portions of the street when the city paves the balance.

It is insisted by counsel for respondent that no further duty is imposed by the ordinance than to repair the portions of the streets in question, and that the duty to repair does not include the obligation to pave. Under the duty to repair would doubtless be included the liability to restore any pavement that might be put down by the City; but simply to repair cannot be construed into a duty to place the pavement in the first instance. Counsel for the City contend that the ordinance in question means more than simply to repair. In determining the rights and duties of the respective contestants here, a liberal construction should obtain in favor of the relator. The grant to the respondent of the right to use the streets for the prosecution of its business for profit is a benefit and privilege, and the rule is that such grants are to be construed against the beneficiary. Taking the language of the contract between the parties in its literal meaning, we think it cannot be confined simply to repairs. We think that when the city paves the balance of the streets, the duty devolves upon the respondent company to pave between its tracks and two feet on each side. When the City paves, if the railroad company declines, it cannot be said that it keeps those portions of the streets in as good condition as the City keeps the balance. In order to meet this obligation, the railroad company must pave.

No question of changing the grade of the street is presented by the pleadings. The ordinance provides that said portions of the street shall be kept in as good repair and condition as the city keeps the balance, and of even grade with the street, excepting in cases of regrading. The 13th section of the ordinance expressly provides that the grade of the railway tracks shall not be changed at the expense of the railway company.

That mandamus is the proper remedy is not denied. It is settled by authority that the writ will lie against such a corporation to compel it to perform a clear duty to the public.

(Sup. Ct. Fla. State vs. Jacksonville St. R. Co. 10 So. Rep. 590.)

(NOTE.—In the case of *Mayor vs. New York & H. R. Co.* (Supreme Court N. Y.) 10 New York Supplement 67, a street railroad had been authorized to lay its tracks in certain streets on condition that it should pave the streets in and about the tracks. Afterwards an Act was passed authorizing it to extend its tracks in Madison avenue from 79th street to 86th street, and as far northerly as the avenue might from time to time be opened, but it did not expressly impose the condition that it should pave the street—merely providing that in the construction, use and operation of its tracks and extensions, it should have the same rights and privileges which it then possessed under former grants. The Act also provided for the appointment of commissioners to fix the amount of compensation to be paid for the rights and privileges granted. It was held that the Act did not impose on the company the duty of paving between its tracks north of 79th street.—ED.)

Electric Railway—Operation by Construction Company—Liability for Personal Injuries.

Though under the contract for the construction and equipment of an electric railway line, the construction company agrees to operate the road satisfactorily for ten days before payment for the equipment, still where during that time regular passenger cars manned with the usual help and on which the public are invited to take passage at the usual fare, are run, the railway company is responsible for an accident to a passenger occasioned by negligence in the operation of the cars.

(Sup. Ct. Wash. Cogswell vs. West St. & C. Elec. R. Co. 31 Pac. Rep. 411.)

Care required of Street Railway at Crossing of Steam Railway—Injury to Passenger on Street Car.

A passenger in a street car, while crossing the tracks of the Chicago & Northwestern Railway, was struck by an engine belonging to that road and seriously injured. The action was brought against the street railway company and the steam railway company jointly. Judgment was rendered against both, and the street railway company alone appealed.

Upon the trial there was evidence that upon the arrival of appellant's car at the Rockwell street crossing, the gates were down and a freight train was passing; that as soon as the gates were raised by the man in the signal tower, appellant's conductor, who had gone ahead of the car, gave the signal to the driver to come on; that he gave this signal before the freight train had completely passed; that as soon as the freight train was entirely by, the driver of appellant's car started on and went directly in front of an engine going in a direction opposite to that in which the freight train was moving.

Grade crossings are well known to be places of imminent peril; the diligence of the carrier at these points must be proportionate to their well known danger. We think it was the duty of the servants of appellant to go forward upon the railroad tracks to a position where could be ascertained the fact whether or not the cars of said Northwestern Railway Company were approaching said crossing.

It is immaterial that the negligence of the Chicago & Northwestern Railway Company may have been greater than that of appellant; the question presented, so far as appellant is concerned, is, Did it perform its duty toward appellee, its passenger?

(App. Ct. Ill. Martin vs. West Chicago St. R. Co.; not yet reported.)

Street Railroads—Use of Steam—Ordinance—Turn-outs and Switches.

A city ordinance authorized the construction of a railway on certain streets "to be operated by electricity or such other power as will not unnecessarily obstruct the use of said streets by the public." *Held*, That evidence

that it was not intended to allow the use of steam, was inadmissible. Said ordinance did not confer on the company the absolute right to operate its cars by steam, the question as to whether the use of steam would "necessarily obstruct said streets" being one of fact for the jury.

The grant of a right to construct a railway carries with it the right to construct such turnouts and switches as may be necessary for the successful operation of the road. Where a city ordinance grants permission to build a railroad in its streets the right of the city to be consulted about the situation of side tracks, switches and turn-outs, is of equal dignity with the right of the railway company to construct them; and until it can be shown that the city has waived its privilege or declined to act, the railway company is not entitled to an injunction in that respect.

(Sup. Ct. Tex. Mayor vs. Houston B. & M. R. Co. 19 S. W. Rep. 786.)

Elevated Railroad—Conditional Franchise.

The condition in the articles of association of an elevated railroad company organized under the New York Rapid Transit Act, that the company shall not be permitted to do any work towards the construction of its road on a certain street until it shall have entered into an agreement with the companies owning and operating a surface steam railroad thereon, transforming said surface road into a mere street railway and transferring its operation by steam to the elevated tracks, is a condition subsequent and does not prevent said elevated railroad company from acquiring a franchise or capacity as a corporation until such contract is made. The agreement directed is to precede construction, and not corporate existence. The company is to make the agreement, and it must exist first in order to agree at all. When it has acquired corporate life and so has capacity of acting, it is endowed, not with absolute, but with a conditional franchise to become absolute, by the performance of one or more imposed conditions.

Such condition is authorized by the provision of the Rapid Transit Act, that commissioners may impose such conditions on railroad companies organized under it as shall seem expedient, and that they shall embody the conditions in the articles of association tendered for acceptance.

(N. Y. Ct. App. In re Atlantic Ave. El. R. Co. 32 N. E. Rep. 771.)

Contract to Construct Street Railway to Plaintiff's Land—Action for Breach—Damages.

A street railway corporation, of which plaintiff and associates were stockholders and officers, in its corporate capacity, agreed to sell certain franchises to defendants, stipulating to transfer to them additional rights of way over certain portions of the proposed route. Afterwards plaintiff and associates, as individuals, sold and transferred the stock of the corporation to defendants, the latter agreeing to construct and complete the railway within a specified time, to a certain point, which was over the route for which the corporation agreed to secure the rights of way. *Held*, that the failure of the corporation to secure the rights of way is no defense to an action by

plaintiff for the breach of defendant's agreement to construct the railway, as their contract with plaintiff and associates was separate and distinct from the contract with the corporation.

After plaintiff had purchased on contract land which he subdivided for residence lots, defendants agreed with him to construct to such land a street railway within a specified time and to sell tickets for passage to residents and property owners on such land, at a specified price. *Held*, that in an action for breach of defendant's contract, defendants must have known that the loss to plaintiff of the enhanced value of the land by the construction of the railway, would be the result of their failure to perform the contract.

(Sup. Ct. Ore., Blagen v. Thompson. 31 Pac. Rep. 647.)

Crossing of two Street Railway Tracks—Care required—Collision between Street Cars.

Deceased was a driver of a horse car, in the employ of the West Chicago Street Railway Company, and was thrown from his car and killed by a collision which occurred between the car which he was driving and a grip car crossing its track.

Where street cars of two different lines have equal rights at a crossing of their tracks, the fact that the hind end of the car upon one of them is struck by the front end of the other, while passing over such crossing, of itself and without explanation, raises the presumption that the colliding car was carelessly managed. * * *

Any increase in speed of the horse car or lessening of the speed of the grip car only makes the case worse for the grip driver. He was bound to see the horses when they entered upon the cable track, and if he did see them there was no rate of speed shown by the evidence of both or either of the cars that would render it impossible for him to stop the grip before he struck the rear end of the horse car, if he exercised reasonable diligence to do so. If he did not see the horses take the crossing, or having seen, did not apply his brake in time, or with sufficient power, then he was negligent. If he undertook to calculate the rate at which the horse car was moving and by that calculation gauged his own speed, he took the risk of all errors in his estimate. Nor is he relieved by any sudden or unexpected slackening of the speed of the horse car in going over the track. The horse car had the crossing and the gripman was bound to so govern the movement of his train as that whether the horse car went fast or slow, and even if it came to a dead stop with the rear end still in the cable track, he could stop before striking it.

(Ills. App. Ct. Chicago City Railway Company v. McLaughlin. 40 Ills., App. Rep. 196.)

A PROMINENT coal dealer of Winnipeg, Manitoba, has given the use of his offices as a waiting station for street railway passengers. The gentleman thinks the advertisement worth the trouble. Many other railways may profit by this exchange of courtesies.

TWO POWER HOUSE FIRES.

JANUARY seemed ambitious to keep up December's reckless record in the matter of destruction. The year is young yet but if this thing continues we shall be compelled to call for a special insurance rate on power houses.

On the sixteenth of the month the Tiffin Electric Light Company's plant, including the almost complete power

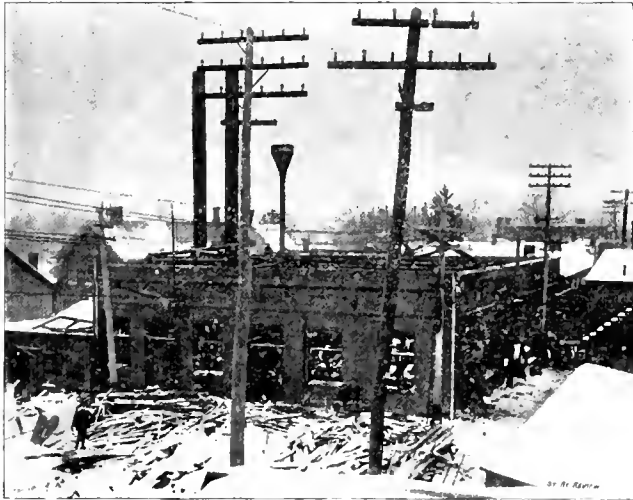

RUINS OF TIFFIN PLANT.

house that was to furnish the electricity for the two railroads at Tiffin, Ohio, was laid in ashes. The loss was \$30,000, partially covered by insurance.

Three hours earlier, the same morning, fire was discovered at the machine shops of the Central Railway Company at Peoria. Before the fire could be controlled the entire plant was in flames. This loss involves \$20,000



THE FIRE AT PEORIA.

on buildings, \$12,000 on engines and boilers, \$6,500 on machinery, \$35,000 on electrical equipment, and \$27,500 on nine motors, making a total of \$101,500. The insurance was \$61,500.

In the latter conflagration two employes were considerably burned about the face in their efforts to escape. In

both cases the firemen worked at a disadvantage from late arrival and lack of water. There ought to be under ordinary circumstances proper facilities in every car barn and power house for fire protection.

The REVIEW artists were early at the scene of action, as our engravings of the events testify.

The Lindell, St. Louis, narrowly escaped a serious blaze at its car barn on Fairfax street. The flames in this case were discovered in time, and made a loss of only \$600. The fire was extinguished by running the burning car out of the barn. This happened January 11.

EVERETT, WASH., ELECTRIC ROAD.

NINETEEN months ago the spot of land at present occupied by the city of Everett, Wash., was a wilderness of fir and cedar trees. Today 5,000 inhabitants have dispossessed the original settlers and built 18 modern brick blocks and many miles of planked streets and plank walks over the former theater of the forest primeval.

Factories, too, have settled down upon this pleasant spot. On the Puget Sound or salt water side of the town a nail factory is already turning out 200 kegs of wire nails per diem; the south part boasts of a large paper mill, a steel barge works on the northern side, with a liberal garnishment of lumber factories, shingle mills and a pressed brick factory.

With its situation on the Snohomish river and Puget Sound, and being the terminus of the Great Northern, Everett has a great future, and the Everett Railway, Power & Light Company appreciates and has faith in this fact. This company has entrusted to Leo Daft the installation of a complete arc and incandescent light plant and seven miles of electric railway. In its power plant will be found Ball cross compound condensing engines in units of 200, 150 and 150; four tubular Washington Works boilers of Seattle; Westinghouse dynamos and 40-horse-power, single reduction Westinghouse motors, under American Car Company's cars on McGuire trucks. The station will admit of an increase of 1,000-horse-power in the future. The seven miles, standard gauge track with one loop, 3 turnouts and 7 curves has an overhead construction of No. 1 hard drawn copper wire. The small car equipment is at present all the traffic demands. But increase of cars and service will surely follow the success that is sure to be attained by Everett and its railway.

NORWICH, CONN., LINES CHANGE HANDS.

THE Norwich, Conn., Street Railway Company has passed into the Hands of a Boston syndicate and the following Boston men will act as trustees: Wm. A. Tucker, John T. Crocker and Francis Peabody, Jr. The old management will probably be retained, with E. P. Shaw as superintendent.

It takes 250,000 feet of natural gas per day to run the power plant of the Ft. Wayne, Ind., railway.

ONE LARGE VERSUS SEVERAL SMALL CAR BARNs.

A SYMPOSIUM.

THE recent destructive car barn fires at Milwaukee, Boston, St. Louis and other places of less note, and consequent loss of rolling stock, have been the cause of some question as to the advisability of storing a large number of cars in one place.

With a view of ascertaining the opinions of some of our most noted managers, the REVIEW wrote to a half-dozen in various cities, asking their judgment on the question. Their replies make up the present symposium.

J. E. RUGG,

superintendent of the Citizens' Traction Company, of Pittsburg, says: "In my opinion circumstances ought to govern, but I prefer small car-houses well distributed, instead of concentrating a large amount of property in one place. A very long route with large equipment is better operated by having a car house at each end. I think the power house should be separate from the car storage."

HENRY HURT,

president of the Washington & Georgetown, of Washington City, replies: "We favor car houses at the termini of each line."

JOHN N. BECKLEY,

of the Rochester, N. Y., railway, states that his opinion inclines to one large rather than to two small car houses on an electric road, and this at the center of the system. This method gives the superintendent the best opportunity to manage the plant, as well as giving more economical service.

TOM L. JOHNSON,

of the Brooklyn line, at Cleveland, O., drops legislative duties long enough to write from the House of Representatives at Washington. Mr. Johnson says: "With smaller companies having 50 cars or less I prefer one car house. When the companies are large my practice has led me to limit the contents of one house to not over 100 cars, multiplying houses beyond that point. But really it is very hard to lay down a rule, as so many elements enter into the question."

THOMAS H. M'LEAN,

general manager of the Houston, West Street & Pavonia Ferry Railroad Company, of New York City, replies: "I fail to see wherein a large depot should not be as safe from fire as smaller ones, assuming that every precaution is used. I attach great importance to the use of the wet pipe sprinkler system, having had personal knowledge of their efficiency in checking fire prior to the arrival of the department. It is of course essential to have an efficient staff of watchmen. If several divisions are concentrated in one the building might be isolated to an extent, thus reducing the risk considerably.

GEO. W. BAUMHOFF,

of the Lindell, of St. Louis, declares unequivocally in favor of the large car house, provided the arrangement of the tracking is such as to facilitate the removal of cars in case of fire. Mr. Baumhoff says: "A large car shed can be built with track similar to switch track in steam railroad yards, which, on account of the loss of room in car sheds having less depth, would be a decided disadvantage. A car shed with the longest possible length, having one main track crossing and leading into each main track at each end of the building, is in my opinion the best adapted and least expensive to maintain, and insures less loss of space."

C. S. SERGEANT,

of the West End, of Boston, thinks that if proper fire protection is afforded that the large car house has the advantage. He suggests that the barn be constructed in fire proof sections. Mr. Sergeant also states: "The car house should be so situated as to get the greatest amount of time on the street for the men employed in the car service within the number of hours' labor which are established to constitute a day's work. This element of expense I should deem of more consequence in determining the location of houses than the expense incident to protection against fire."

The REVIEW will be pleased to hear from other managers having views on this highly important question.

NEW DEAL AT SEATTLE.

THE Seattle Consolidated Street Railway Company has undergone changes that may result in changes on all the Seattle roads. The new president is F. T. Blunck, of Davenport, Iowa, and the stock is now controlled by eastern men. C. S. Clark, of Kansas City, will have the management of the road, and it is the intention to devise means for consolidation with other of Seattle's numerous roads. Seattle has 104 miles of single track, but divided among so many lines that few of them are paying expenses. Previous attempts at consolidation have failed, but it is thought that eastern capital may be able to effect it.

HOW LONDONERS TRAVEL.

IN "dear old Lunnon, d'ye know," it takes 10,000 horses to work the extensive 'bus system on which so great a portion of the metropolitans depend for transit and the road cars require 3,000 more. Besides this 20,000 tram horses are in use hauling two and a half ton cars. Each omnibus weighs one and a half tons and carries a ton of passengers, earning forty-four shillings or \$11.00 per diem. The capital required for the omnibus service is \$7,500,000, and for the tram lines \$17,500,000. The average cost of food per week is \$2.50 per horse.

THE corner of Bleeker street and Broadway has been bought by the Metropolitan, of New York, for \$750,000. An office building will probably be erected.

THE TROLLEY BOY.



of the amusing features of some Old World lines, to an American at least, is a functionary who would be known in English as the trolley boy. It seems that the epidemic common here a few years ago, which caused the trolley to leave the wire at inconvenient times and places, has traveled eastward, contrary to the general rule, and now turns up in Europe. We admit, however, that the European method of curing this trouble is an original one, and gladly give them credit for it. On the Vevey-Montreux road in France the current is taken from two copper tubes of .6 inch inside diameter, slotted on the under side and with the contact sliding inside. These tubes are hung from wooden brackets and have steel wire along the top to help prevent sag. As there is some trouble at switches the company employs a trolley boy to roost on the car roof and keep the trolley "in the way it should go." At another place where the under running trolley is used the boy stands with the rope in his hand, on the rear platform, ready to replace it whenever it runs off. And now word comes that the Staffordshire trolleys described in our December issue come off frequently in regular service. Americans rather expected this although earnestly hoping that the Staffordshire system would be a success, and it may yet be with slight modifications. One English paper even goes so far as to suggest that a trolley boy may eventually be necessary on the above line. We fear that the gravity of an American street railway man would be seriously disturbed by the sight of a trolley boy vainly striving to steer the "cranky" double jointed trolley around one of the sharp curves on the above road, for the reason that Americans have lately been given to understand that their experience and patient work for the last ten years has been thrown away, and that England would now proceed to show the world how to build trolley lines.

NEW CABLE LINE FOR PHILADELPHIA.

THE directors of the Philadelphia Traction Company have voted to rebuild the entire cable system, putting in the most modern and approved methods and appliances. A power house for the electric feeder lines will also be built in the North-central part of the city. Samuel Hart & Sons will probably take the contract for the power houses and the Field Engineering Company for the electrical equipment. The directors are heartily in favor of sparing no expense to make the new lines the best that money, brains and pains will procure. The paving which the road lays will be asphalt, block or brick, as the residents along the line may vote. The manifest intention of the Traction Company to make the facilities the best ought to be met with the utmost consideration on the part of the citizens.

PASSENGER TRAFFIC IN ST. LOUIS IN 1892

THE St. Louis railways have officially published their traffic totals for 1892. The returns are gratifying and read as follows:

Missouri Railway.....	14,708,156
Lindell.....	12,411,794
St. Louis.....	12,301,596
Union Depot.....	10,628,535
Citizens'.....	9,372,125
Fourth St. & Arsenal (leased).....	22,532
Baden & St. Louis.....	193,144
Union Line.....	820,497
Bellefontaine.....	3,072,992
Cass Ave. & Fair Grounds.....	4,151,592
Jefferson Ave.....	1,957,551
Mound City.....	4,484,729
Northern Central.....	1,046,508
Peoples'.....	4,731,379
St. Louis & Suburban.....	7,037,685
Southern.....	4,744,761
Total.....	91,685,576

This shows an increase of ten and a half million passengers over last year and twenty-five million over 1890. Nearly all railway stock reported is above par, Jefferson avenue bringing \$300 and Union Depot \$200. The index of a city's material prosperity is its railways, which rule shows St. Louis to be in a highly prosperous condition.

SYNDICATE AT BRIDGEPORT.

THE new syndicate which has bought the East End line at Bridgeport, Conn., at the head of which is Col. N. H. Heft, is attempting to gain control of the "old line"—the Bridgeport Horse Railroad Company. Chas. Hotchkiss, the owner of the latter line, however, wants \$100,000 more than the syndicate are willing to pay and matters are at a standstill. Should the syndicate gain control the whole Bridgeport system will be rebuilt and electrified, giving as high a grade of service as can be found anywhere.

A GOOD RECIPE FOR WHITEWASH.

TO make a good whitewash for car barns take a half bushel of good unslacked lime and slack with boiling water, covering up during the process to confine the steam. Strain the liquid and add a peck of salt dissolved in warm water, three pounds of ground rice boiled to a thin paste, a half pound of Spanish whiting and one pound of clean glue previously dissolved by thorough soaking. Heat this mixture just below the temperature of boiling water. (This can best be done by putting the kettle inside another kettle of boiling water). Add five gallons of hot water and stir well. Let stand for five days. Coloring matter can be put in if desired. This kind of whitewash has been on the White House for years, and is nearly as good to-day as when applied.

JOHN GREENLEAF WHITTIER'S estate was found to amount to \$133,000, mostly invested in railroad and electric stocks covering over 100 investments.

THE NEW LINE AT COLUMBIA, PA.

DECEMBER 21, 1892, was a red letter day in Columbia for the Columbians and for William Given, all on account of the opening of one of the prettiest little electric railway plants in the great old state of Pennsylvania.

The power equipment of the road is just such as President Given would be expected to buy, and consists of one 125-horse-power Ball & Wood horizontal, automatic cut-off engine. The engine is fed from a Supplee Steam Engine Company's horizontal tubular boiler, 6 feet diameter by 18 feet long, with 122 three-inch tubes. Its horse-power is 125. A No. 8 Otis heater, Worthington pump and Korting injector complete the list of steam appliances. The electric equipment consists of one 125-horse-power Westinghouse multi-polar railway generator



WILLIAM GIVEN.

and four car equipments of eight 20-horse-power Westinghouse motors, single reduction. J. G. Brill Company made the four motors and two trail cars, each 18 feet over all.

The rail is 66-pound Johnson girder, carefully bonded. The gauge is standard.

The buildings of the company consist of a car shed 30 by 100 feet, a boiler room 25 by 60, an engine room 20 by 48, two stories high, and an office building of two stories.

The principal spirit in the enterprise is William B. Given, whose portrait is herewith presented. Mr. Given is a lawyer by profession, but finds time between questions of legal importance to put forth his best energies in any direction that will develop the interests of his city. This loyal citizen in return is loyally supported by other loyal citizens, who willingly concede Mr. Given the honor of the enterprise. The other members of the management of the Columbia Electric Railway Company are Joseph Janson, treasurer, and Frank S. Given, superintendent.

On the day of the inauguration of the system President Given tendered a banquet and inspection trip to the prominent citizens, stockholders of the road, and newspaper men of Columbia.

"CONDUCTOR! Conductor!" screamed an excited old lady as she pushed on to the platform of a Pittsburg car. the other day, "well ma'am?" "There's a drunken man in there with his arms around a young lady. You ought to see about it!" "Is it embarrassing to the lady ma'am?" asked the conductor in good faith. The crowd howled.

INSURANCE RATES NOT AFFECTED BY THE TROLLEY.

THE most fertile imaginative product of the century is the trolley liar. He lies by note, and runs the whole gamut from the high C of the deadly wire to the guttural G of the fire insurance rate. He lies twice as fast as the campaign liar, and is believed eight times more.

The latest howl comes from the New York Tribune, and a supposititious interview with J. H. Washburn, vice-president of the Home Insurance Company, reads as follows: "Last summer the Board of Fire Underwriters gave notice that the insurance rates would be raised if the trolley came onto the island." A letter from Mr. Washburn, of January 11, says: "The Board of Fire Underwriters is not a rate-making body, and the only action taken has been the ordering of an investigation of the Tariff Association." This report has not been yet made.

The same bright young man who gets up interviews says in the same article: "Insurance rates were raised in Boston last fall because of fires attributed to trolley wires." We give in rebuttal to this bare-faced "fake" the following letters from Osborne Howes, Jr., secretary of the Boston Board of Fire Underwriters, 55 Kilby street, Boston: "While the rates of insurance in Boston are higher than they were before the introduction of the trolley system, this change is by no means one of cause and effect, but is due largely to the fact the fire losses throughout the United States have been for the last two years so large that it has been necessary for fire underwriters in all parts of the United States to materially advance their rates, and Boston has simply joined the procession. While there have been fires attributable to trolley wires, it cannot be shown that any were of serious consequence, nor would justify any change in rates."

Fire Marshal Lewis, of Brooklyn, promptly brands the story of the Washington Star, reprinted in the New York World, in which it is said that several insurance companies have closed their offices and are leaving Brooklyn to its fate. Mr. Lewis remarks: "There is not a particle of truth in the rumor that the introduction of the trolley has caused the insurance companies to close their offices, or refuse to renew old risks. Rates have been too low in Brooklyn, and there is a tendency to increase them. I know of no fire in Brooklyn which has resulted from the trolley."

B. C. Thorn, secretary of the Brooklyn department of the Phenix Company, makes substantially the same statement as Mr. Lewis, and the general summing up of the case is that advices from a dozen other companies contain the same statement.

The lie that is part the truth is so much the more a lie.

THE veterinary department of the Government of Great Britain states that the number of cases of glanders increased from 947 in 1890 to 1,260 in 1891, and the animals suffering from farcy from 861 in 1890 to 1,175 last year.

WILLIAM RICHARDSON.

A BIOGRAPHY.

THE subject of our sketch this month is Mr. William Richardson, who has been so well known throughout street railway circles as the President of The Atlantic Avenue Railroad Company, of Brooklyn, New York. He was born in Berkhamsted, Hertfordshire, England, on December 8th, 1822. His parents soon after moved to London, and what schooling he had was obtained in that city before he reached ten years of age. At this age he entered the services of a barrister in Elm Court, Middle Temple, London, where he remained several years, during which time he had opportunities for self-improvement and quite an extended course of reading. In 1834 his father, with William and another son, John, came to this country, and located at Mt. Vernon, Ohio. The trip from New York to Ohio occupied one week by the quickest routes; the journey being made by steamboat to Albany, thence by cars to Schenectady, by way of the Erie Canal to Buffalo, and the remainder by steamboat on Lake Erie. William was at once engaged in the office of the Knox County Republican, where he remained over a year, and after service on a farm with relatives and in several stores in Mt. Vernon, the family moved to Albany, N. Y., in 1840. This was the year of the Harrison campaign, and he took an active interest in it.

His experiences in Albany, where he resided for twenty-five years, were somewhat varied. He was successively a hotel clerk, an umbrella maker, and finally opened a paper and paper-hanging store, in which he continued until 1850. In September, 1844, he was married to Miss Mary Freeman, and they look forward to the celebration of their Golden Wedding next year. Both are in good health and there is every reason to believe that their expectations will be realized. Seven children were born, four of whom are now living—a daughter and three sons—one of whom is William J. Richardson, Secretary of the American Street Railway Association and The Street Railway Association of the State of New York.

In politics Mr. Richardson was always opposed to slavery, and since the advent of the Republican party has been its earnest adherent. In 1857 he was elected Clerk of the New York State Assembly, and was re-elected for the two terms following; and during the memorable session of 1858, when there was a "tie" in the House, he performed the duties of both Clerk and Speaker for six weeks. As a result of this severe mental and physical strain he was prostrated with a fever, and his hair became white, which is now so distinctive a feature of his personality. Subsequent to this he was engaged for a short time as a proof reader on the Albany Evening Journal, and the training received there has endured through his life, as anyone knows who has had occasion to observe his exactitude. On June 1st, 1861, he was appointed Additional Paymaster in the United States Army, and

after a service of three years, when located at New Orleans, tendered his resignation and returned home. In 1870 Mr. Richardson received the Republican nomination for Alderman of the Twenty-second Ward, Brooklyn, and although the ward was strongly Democratic, was elected and re-elected in 1872. He accepted a nomination by Republicans for State Senator in 1878 but was defeated. This ended his political aspirations, if he ever had any.

Mr. Richardson's introduction to the street railway business took place in 1865, when he was elected a director of the Dry Dock, East Broadway & Battery Railroad Company, of New York City. A few weeks afterward he was elected president, and his management of the road in a short time, by means of several judicious extensions and the grant of new rights, more than trebled the receipts. In 1867 he was induced to take a lease for forty years of the Jamaica Railway Company, a road running between Brooklyn and Jamaica, and he undertook the control of this road as a personal enterprise. Everything connected with the road was run down, and Mr. Richardson had a decidedly uphill undertaking before him, but kept manfully at it until 1872, when, being unable to meet a first mortgage on the property which became due that year, a syndicate was formed by which the road was purchased and the franchise and equipment transferred to the Atlantic Avenue Railroad Company, which was then organized.

Mr. Richardson is largely known as "Deacon" Richardson, but this prefix is entirely mythical. It was conferred upon him at a time when, having laid a certain track early one Sunday morning (an injunction restraining the company from doing which having expired Saturday night) charges of disorderly walk were brought against him in the Hanson Place Baptist Church, of which he was a member, and it was out of the newspaper reports of this occasion that the title grew.

Mr. Richardson recently consummated a sale of the rights, property and franchises of the Atlantic Avenue Railroad Company, and realized therefrom large personal gains, having been a very large shareholder in the company. He now retires at the age of seventy years from active life. He is a man who has been capable of great physical and mental effort, with a clear idea of what he wanted to do and a strong will which enabled him to accomplish it. He has been the subject of more or less unfriendly criticism; but this, as we know, follows naturally upon the president of a street railway corporation; although we are glad to say, en passant, that the feeling against street railways and their officials is not so harsh as in former years. Mr. Richardson has figured conspicuously in the combats with the Knights of Labor, his road having been made an especial mark for some of their most unreasonable demands. It was on his road that the two greatest street railroad strikes in the east were inaugurated—March, 1886, and January, 1889. The first strike continued three days, during which time all the street railroads in New York and Brooklyn were involved, and the concessions demanded



WILLIAM RICHARDSON,

Brooklyn,

For 25 years President Atlantic Avenue Railroad.

were acceded to. The strike of 1889 was of ten days' duration, and confined to this road alone, and after a hard struggle, during which many outrages were committed, extending to murder, the company came off victorious. Mr. Richardson at this time was confined to his bed, but directed all the movements on the part of the company. He has been a prominent figure at the meetings of the American Street Railway Association, having attended all of them since the New York meeting in 1884, except the meeting in Cincinnati in 1886, and has usually been accompanied by his wife and daughter.

LOST CAR IN CINCINNATI.

THE superintendent of the Dayton, Cincinnati & Covington line at Dayton, Ky. had an experience lately on one of his lines similar to that related by the late Calvin Richards in the days of the Metropolitan of Boston. It happened in this wise. The company had lately put on its extra list a gentleman named "Jim" from "Central Kaintuck sah." "Can you manage a car?" asked the superintendent dubiously. "Enny fool orter be able to foller a track and git back," replied Jim. "Jes' gim me a trial, boss, and I'll git around." So Jim got a car one morning, and after cracking his whip in a professional manner headed his car for Cincinnati, across the river. His mind was not clouded by doubt and he went on with unsuspecting passengers and mules. Crossing the bridge an unforeseen difficulty presented itself. There was a net-work of track with not a mark to show whither they led. "Well, one's as good as 'tother," soliloquised Jim, "and the rule is turn to yer right." So to the right he went, taking every switch he came to. The passengers meantime had taken to the sidewalk and the mules bewildered switched their tails and said nothing.

Jim went on and on. The track seemed endless and the terminus removed itself further and further. "Git up thar," said Jim, "we'll git to the end if we keep going." Finally about five o'clock in the afternoon Jim called a halt and yelled to a passing citizen: "Say, boss, whar's Fountain Squar'? I've been travellin' all day and I can't find it." The citizen saw Jim's difficulty and mounting the car landed it at the bridge safe in "Kaintuck." The last that was seen of Jim was in an exciting dialogue with the superintendent on time account and trip sheets.

THE MARKS RAILWAY EQUIPMENT COMPANY, Cleveland, is the new stock company, successors to Marks & Sterling, and of which C. E. Marks is president. The new organization was made necessary by the rapid increase in the company's business which has demanded constantly enlarged facilities for manufacture. The city of Cleveland has long had a national reputation for street railway supplies, and the success of President Marks is proving no exception to the rule. Their joint bridges and other track specialties are being rapidly introduced. Harrison & Carey have become Chicago agents and will actively push the good work in this territory.

ONE ON HER.

SHE had escaped the perils of the guard, the gate and the gang and settled herself in a South Side elevated car. Her lap was full of bundles, showing that the day's shopping was done, and her black alpaca gown was very becoming. But all the above enumerated mercies did not make her happy. Her drawn-down mouth and restless eye showed outwardly an inward grief. Finally her feet began to shuffle and it became apparent to the philosopher that the brand new pair of shoes that encased her pedal extremities were at least a size too small. This solved the question. They looked well, but, oh my! how they did pinch. Several persons left the train at Twenty-first street and she saw her opportunity. She stooped over, fumbled her skirts, and with a sigh of relief leaned back with an almost beautiful expression. It was plain that the offending shoe had been removed.



"Fifty-fifth, all out, faraswego!" yelled the guard in his best Calumet dialect. Then the trouble began. She fumbled the skirts with vigor, but the abused foot rebelled. It had swollen and refused. Concealment was not longer possible. The woman jerked and sawed, said something between her clenched teeth and fourteen horrid men laughed, when a disconsolate female limped out on the platform with her arms full of bundles and one shoe in her hand. But the look on her face was nearly akin to fighting lunacy, and the philosopher walked two blocks the wrong way to keep out of her road.



THE DISADVANTAGES OF LONG TRAILERS.

SOME facetious member of the Rapid Transit Board of New York has a point well taken when he says: "Take any down town day car and 30 per cent of the passengers are women, 40 per cent men, and 30 per cent boys and girls. Now it is demonstrable that a person can safely approach within four feet of a woman with the present long trained dresses. Now as most men measure only eleven inches through the dorso-ventral section, one woman takes up the space of four men in getting on and off trains and standing in the car. Thus 30 per cent of the women consume approximately 80 per cent of the time for stopping, and the number of stops multiplied by the saving of time by one trainless skirt will give the net earning on one trip, to say nothing of packing qualities."

Picture!

"NURSING TRAMCARS" is what they say in England when a wagon obstructs the passage of a street car. In this country much more emphatic terms are considered as unequal to the necessities of the occasion.

ELECTRICAL MEASUREMENTS.

BY PROF. GEORGE D. SHEPARDSON, OF THE UNIVERSITY OF MINNESOTA.

THE electrical measurements required for ordinary commercial purposes are those of current, electromotive force and resistance. These are usually quite simple when dealing with direct currents. Measurements of current and electromotive force are comparatively easy, and, since they are used in most methods for measuring resistance, they will be considered first.

Current is measured by connecting an "ammeter" into the circuit. The ammeter measures the rate at which the current is passing, as an anemometer measures the rate at which the wind is blowing. A "current-meter" or "recording ammeter" measures the product of the rate by the time, or the ampere-hours, as a water meter measures the total number of cubic feet of water passed. A "voltmeter" connected to any two points, measures the difference of potential (electromotive force, pressure or voltage) between them as a manometer tube measures the difference of pressure between the ends of the tube.

Electrical measuring instruments may be either "direct reading" or "zero" instruments. The former give the value of the measurements directly by the amount of deflection of a pointer. In the latter class some part of the instrument must be adjusted until the pointer comes back to its zero position, or the position it occupies when no current is passing. The position of the adjustable part when the balance is obtained gives the proper reading.

The two classes are well illustrated by weighing scales, the spring balance being direct reading. The lever balance is a "zero" instrument, since the load is balanced by adding or moving weights until the beam swings freely

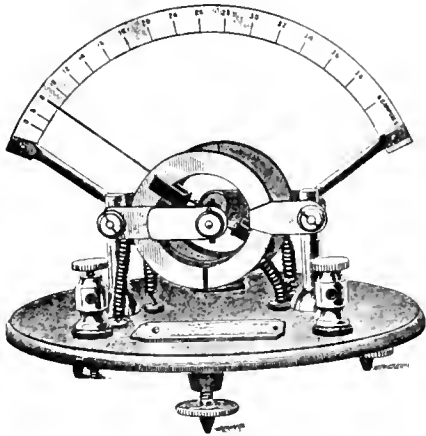

I H A. C. AND D. C. AMMETER.

and the pointer stands at zero, or midway between the stops, the load being measured by the position or number of counter-weights on the beam. The advantage of the direct reading instruments is that they indicate any changes of the quantity being measured and do not require any handling. The advantage of zero instruments is that they may be adjusted to closer measurements. Since zero instruments may be set to read zero at normal current or voltage, and may be so sensitive

that a small variation will give a large deflection which may be seen across the room, they are of special value in the engine room or dynamo room, where the machines must be regulated to give constant current or constant potential.

What is commonly called an electric current is materially different from a current of water in that it cannot be observed by the senses directly. It can only be detected and measured indirectly by its effects. An electric cur-

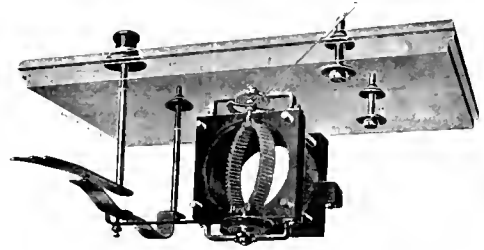

WESTON A. C. AND D. C. VOLTMETER.

rent heats the conductor, produces a magnetic field in the surrounding space, gives the conductor an electric charge which attracts or repels other charged conductors, and chemically acts upon any portion of the conductor that may be a liquid (unless the liquid be an elementary substance). All these effects are proportional to the quantity of current, hence any one of them may be used as a measure of the current.

Instruments based upon these effects may be arranged for use either as ammeters or voltmeters. For use as ammeters either the conductors in the instruments are made large enough to carry the entire current without introducing undue resistance and without being overheated; or only a known fractional amount of the total current passes through the instrument, the remainder passing through a shunt. When used as voltmeters they are really only modified ammeters, the conductor being a fine wire of high resistance (an external resistance being sometimes added), so that only a small current will pass through the instrument when it is connected to the two points whose difference of potential is to be measured. By Ohm's well known law the current through the instrument will be the difference of potential divided by the resistance of the voltmeter; but since the resistance of the voltmeter is practically constant, the current through it is proportional to the difference of potential at its terminals, so that the instrument may be calibrated to read volts.

Electro-magnetic measurements are based upon the fact that a current of electricity is surrounded by magnetic lines of force which follow the path of least resistance. Since iron gives a better path for magnetic lines than air the lines will be attracted to the iron, and (by their tendency to shorten) will tend to draw the iron into such a position as to furnish the shortest possible path for the lines of force. This tendency to move the iron may

be measured by the force required to balance it, the force being exerted by a spring, gravity, magnetic field or any combination of them.

The simplest and cheapest instruments for measuring current are based upon the tendency of a solenoid or coil of wire carrying a current, to draw or suck an iron core into itself, this motion being opposed by a weight (sometimes that of the iron core), or by a spring. This class of instruments is illustrated by the well known Edison or Brush ammeters.

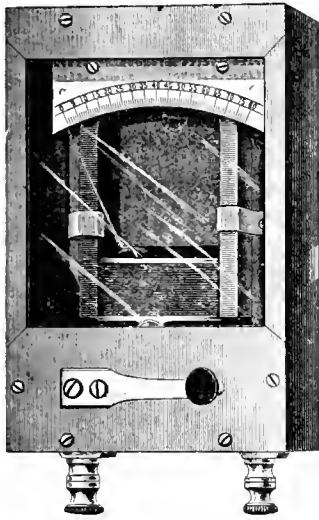

THOMSON-RICE VOLTMETER.

If the core is not exactly in the center of the coil it tends to move away from the center and get as close as possible to the wire. This is the principle used in the well known T.-H. ammeters and voltmeters for direct or alternating currents. A thin strip of soft iron is bent so as to form three sides of a rectangle and is pivoted eccentrically inside a coil through which the current passes. As the iron strip rotates it comes closer to one side of the coil, the rotation being opposed by

small counter weights or by the weight of the iron strip itself.

A common method of measuring electricity is by the opposition of two magnetizing forces, on the principle that a movable body acted upon by two forces at right angles to each other assumes an intermediate position depending upon their relative intensities. In such instruments one of the forces is generally of constant strength while the other varies. This principle is used in the ordinary form of Weston instruments, in which a coil of wire rotates in the field of a permanent magnet. The movable coil is connected with the electric circuit by delicate spiral springs. In the new Weston alternating and direct voltmeters the current through the moving coil passes also through a stationary field coil, which replaces the permanent magnet of the other instruments.

Another class of instruments closely allied to the above has a small permanent magnet called the "needle" for the movable part, the conductor being stationary and usually arranged as a coil with the needle at its center. The movable needle may be placed in the strong field between the poles of a horseshoe magnet, with the surrounding coil placed so that its magnetizing force is at right angles to that of the magnet. When no current passes the needle takes a position directly across between the poles of the magnet. Current through the coil tends to turn it at right angles to this position. The position it takes depends upon the strength of the current in the coil. This used to be a common form of instrument,

illustrated by the Thomson-Rice voltmeter and some forms of Bergmann ammeter.

When the conductor is a coil concentric with the needle and the controlling force is the earth or a magnet at a distance, so that the needle is in a comparatively weak and uniform field, the instrument is called a "galvanometer." The galvanometer may be made extremely sensitive by the use of very light needles suspended by long delicate fibres of silk or quartz. Usually the needle carries a mirror which reflects the light from a scale to a telescope, so that very small deflections may be read. Galvanometers have been made on which a current of $\frac{1}{1000000}$ ampere could be measured, but they are very delicate and can be used successfully only by skilled observers.

Since a magnetic field surrounds every current, and since the magnetic lines tend to shorten, it follows that

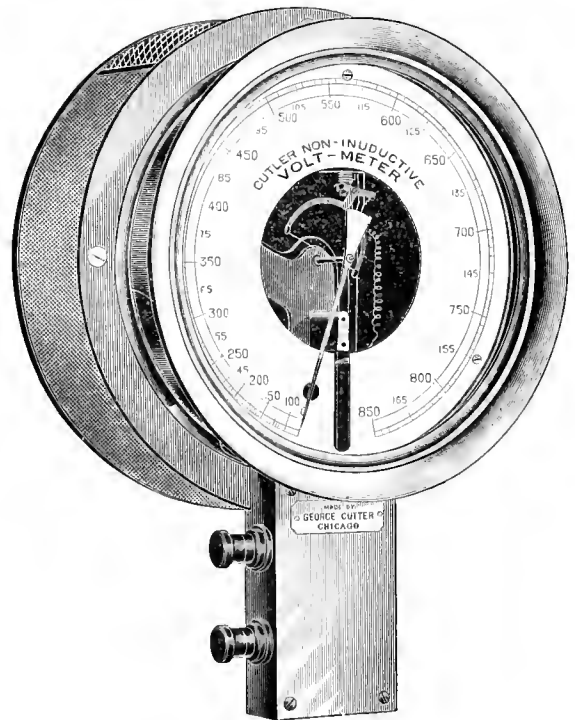

CUTLER HOT WIRE VOLTMETER.

parallel wires carrying currents in the same direction attract each other and those carrying currents in opposite directions repel. This principle is utilized in the ampere-balance, in which movable coils are placed between parallel stationary coils, so connected that one attracts the movable coil while the other repels it. This tendency to move may be balanced by sliding a weight along a beam until the movable coil returns to its zero position midway between the two coils, as is done in the Thomson balance. Or the movable coil may be allowed to take different positions and so be direct reading.

In the second class of instruments the heating effect of the current is measured either by the longitudinal extension of a portion of the conductor, or by the indirect effect of the heat upon other bodies. The extension of the heated conductor may be magnified by a train of gearing

with a long pointer attached, as in the Cardew voltmeter, or by a long lever arm, as in Cutler's new hot wire instruments.

The chemical action of the current is largely used in laboratory work for testing or calibrating ammeters, and is used in one or more commercial forms of current registering devices. Current passing through any liquid (except an elementary chemical substance), decomposes it. If two metallic plates are immersed in a solution of

a salt of the same metal, current passing through will decrease the weight of one plate and increase that of the other, the amount of change being proportional to the product of the time and strength of the current. The chemical action of the current is not suitable for ammeters since

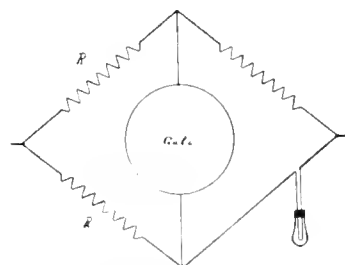

CONNECTIONS OF HOWELL LAMP INDICATOR.

it does not give the instantaneous value of the current. Nor is it suitable for use with alternate currents, since the chemical changes caused by the current while in one direction are almost exactly neutralized by the current in the reverse direction.

As stated before, these various methods for measuring current may be adapted for use in measuring electromotive force. There are other methods suitable for measuring electromotive force but not current.

The first is the "potentiometer" or "fall of potential" method, which is based upon principles deduced from Ohm's law, that the potential of a current flowing through a uniform resistance falls uniformly from one end of the resistance to the other. The difference of potential or voltage between any two points of the circuit has the same ratio to the total voltage whatever the latter may be. Also the portion of the whole circuit, which must be taken to obtain a given voltage, depends upon the total voltage.

This method is used in one of two ways for measuring higher voltages than the voltmeter could measure directly.

The first is by inserting in series with the voltmeter any multiple of its resistance, so that the fall of potential through the voltmeter is a definite fraction of the total voltage. Thus if the extra resistance is twice that of the voltmeter the total resistance of the voltmeter circuit is three times what it was before. When the circuit is closed the voltage between the terminals of the voltmeter will therefore be only one-third of the total, and its reading must be multiplied by three.

Another fractional method is that introduced by M. D. Law, who measures very high voltages, such as those on arc light circuits, by connecting a series of incandescent lamps across the terminals of the circuit and measuring the voltages of the separate lamps by an ordinary voltmeter. The total voltage is the sum of these separate ones. For this purpose the voltmeter should have a resistance many times greater than that of each lamp, so

that the current through the lamp will not be appreciably affected by it.

The Edison Company has introduced a zero potentiometer instrument in which a high resistance is connected to the two points whose voltage is to be measured. Shunted around part of this resistance is a second circuit including a battery of constant electromotive force and a galvanometer. One end of the galvanometer circuit is permanently connected to the main circuit while the other end may be adjusted to make contact at different points. When the contact is made at the right point the electromotive force of the battery equals the difference of potential between the two points on the main circuit, and no current goes through the galvanometer. The position of the contact for obtaining a balance varies with the voltage at the terminals of the instrument and a scale indicates the voltage corresponding to the different positions.

Another well-known zero instrument used by the Edison company, the Howell Lamp Indicator, is based upon a further development of the fall of potential

method. Since the potential falls from one end of a conductor to the other, it is evident that if current flows through two conductors connected in parallel, the ends of one conductor will be at the same potential as the corresponding ends of the other. It is also evident that for any point in either conductor a corresponding point may be found in the other conductor which will have the same potential, and if a galvanometer were connect-

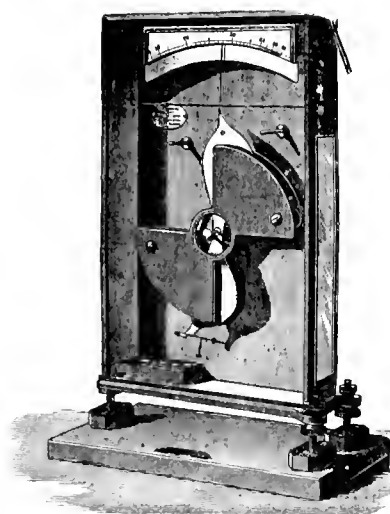

THOMSON ELECTROSTATIC VOLTMETER (HIGH PRESSURE)

ed to two such points, no current would flow through it. Such an arrangement is known as a Wheatstone bridge and is commonly used for measuring resistance.

The Howell lamp indicator is a Wheatstone bridge, three sides of which are made of German silver and copper wire, while the fourth side is the carbon filament of an incandescent lamp. Carbon has the peculiarity that its resistance decreases with rise of temperature while that of most conductors increases. The galvanometer circuit is arranged with a sliding contact at one end, so that a balance may be obtained for any voltage at the terminals of the instrument. Suppose the indicator is adjusted so that the galvanometer points to zero for a given voltage. If the voltage at the terminals is increased more current flows through both sides of the bridge, the resistance of the lamp decreases on account of its higher temperature while that of the wire is increased, and the lamp becomes a smaller part of the total resistance than before. The points connected with the galvanometer are therefore

at different potentials and a current will pass between them, deflecting the galvanometer to one side. If on the other hand the voltage at the terminals is decreased, then the difference of potential between the terminals of the galvanometer will be reversed and the needle will be deflected in the opposite direction.

Another special method of measuring voltage is the electrometer or "electrostatic" method, based upon the fact that two surfaces charged with electricity of the same polarity repel each other and that two oppositely charged attract each other. The "quadrant electrometer" in its highly developed form is a delicate laboratory instrument, but modifications of it are well suited for ordinary use. The best known of these is the Thomson "electrostatic voltmeter," which, in various sizes and types, has a range of from 40 to 100,000 volts, and is equally suitable for direct or alternating electromotive forces.

(TO BE CONTINUED.)

PHENOMENAL INCREASE OF TRAFFIC IN BUFFALO.

TO show the tremendous increase in traffic on the Buffalo railway, General Manager Littell has prepared a monograph which was published in the city papers. In this review Mr. Littell states that in 1890 the total number of passengers was 16,211,846 to whom 457,112 transfers were given. The increase in traffic for 1890 showed 200,000 more in December than January. In 1891 there were 18,780,595 passengers carried and 476,295 transfers issued; an increase of 2,500,000. The year 1892 showed 23,912,938 passengers and 6,575,148 transfers, with an increase of 5,200,000 passengers and 6,098,847 transfers in that twelve month. With this tremendous increase the car mileage kept pace, ranging from 3,566,274 car miles in 1891 to 5,447,500 car miles in 1892, showing that accommodations kept pace as quickly as possible with the increase of traffic.

In June, 1891, every car was operated by horse with the following showing:

Miles of track, single.....	82½
Number of horse cars.....	96
Horses.....	1,264
Passengers, daily.....	53,172
Paid transfers, daily.....	6,454
Employees.....	750

In twenty months the figures show:

Miles track, single.....	114¾
Horse cars.....	69
Motor cars.....	82
Trailers.....	16
Total cars.....	157
Horses.....	982
Passengers, daily.....	97,915
Free transfers.....	21,982
Employees.....	1,305

In 1893 all horse lines will be changed to electric and 100 motor cars are under contract. To operate this new equipment three engines of an aggregate maximum capacity of 2,250 horse-power, with the needed boiler equipment is now under way. All of these changes

can not be made in a day, and with the present overcrowding of car orders alone the magnificent service given to the people of Buffalo should be a subject of congratulation to the millions using the poor man's carriage.

It is safe to say that no other street railway system in the country has stood up more bravely under such a tremendous increase in traffic coupled with the difficulties attending the reorganization of such an extensive service from the oldest known to the latest used.

WAGONS MUST NOT DELAY CARS IN PENNSYLVANIA.

THE decision of Justice McCollum, of the Pennsylvania Supreme Court, reversing the decision of Common Pleas No. 2 of Allegheny county, in the case of Robert Winters vs. the Federal Street & Pleasant Valley Railway, appellant, gives some very pungent and readable remarks on the obstruction of rapid transit by teamsters and other vehicle drivers. The case referred to was that of a teamster who drove upon the track of the Federal street road, in order to remove a safe from his dray, and obstructed traffic.

Here it seems that his team suffered some, and in the action for damages the case was appealed and reversed by the Supreme Court, making the railway company the victor.

In the decision, Judge McCollum substantially says: Now that rapid transit is recognized as essential to the business and prosperity of cities it is necessary to make the danger as little as possible, and that such actions as were practiced by the appellee are in defiance of safety and common sense. With the introduction of cable and electric cars so much the more caution is required and the appellee's contributory negligence calls for an affirmance of the appellant's point and is a sufficient answer to the claim.

LOUISVILLE CHANGES.

THE introduction of the trolley into New Orleans will take from Louisville, Ky., a number of its most experienced street railway men. A. H. Ford goes as secretary and treasurer of the new company. H. Mitchell Littell becomes general manager as previously noted. Benjamin B. Gilman resigns as superintendent of the Louisville Railway Company to accept a similar place at New Orleans, and J. O. Haddox takes his place. Lawrence Field succeeds Mr. Haddox.

THE returns from South Wales, England, tram lines, show at Cardiff, 10,724,703 passengers carried on 53 cars, at a profit of \$10,000 at Llaueilly, 263,128 passengers, 5 cars; at other places, 4,525,554 passengers, 43 cars. Only one line is operated mechanically and that by steam.

A DRIVER of a Brooklyn, N. Y., car, who failed to answer signals, for several blocks, was, on investigation, found standing on the platform stricken with paralysis.

J. C. WEAVER, superintendent of the Mt. Adams & Eden Park Inclined Railway Company, is a man that can be trusted to keep his line going under all circumstances. Some time ago when a gripman on his road became so full of election beer that it was dangerous to keep him on the car, in default of an extra man Mr. Weaver took the grip and kept the cars in motion. The action was heartily applauded by the public, and the company is to be congratulated on their superintendent.

NEW CAR DESIGN FOR INTER-URBAN SERVICE.

FROM Spokane, Wash., to the beautiful Coeur'd Alene lake, 32 miles distant, an electric railway will soon be transporting the delighted citizens of that famous city. For use on this road, B. C. Riblet, of Spokane, the chief engineer of the Spokane & Coeur'd Alene Railway & Navigation Company, has designed an

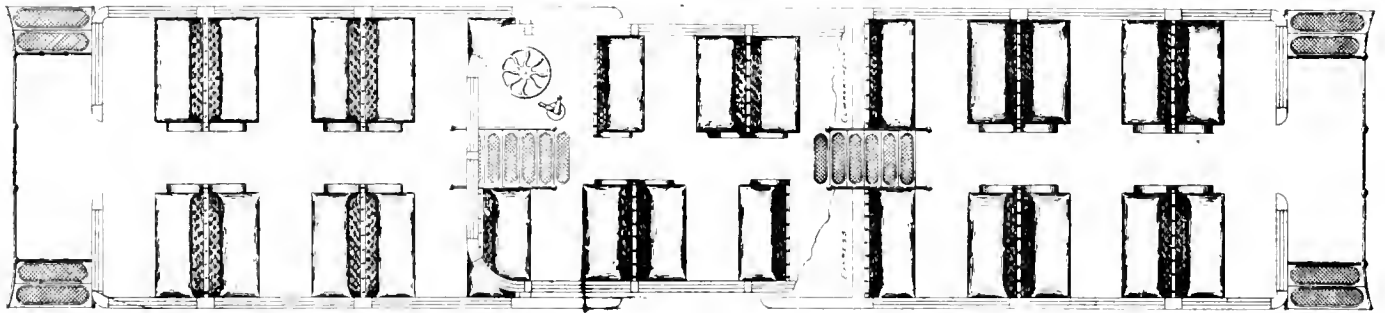

PLAN VIEW RIBLET'S INTER-URBAN CAR.

A NO LESS authority than the London Electrician gravely advises its readers, editorially, to place in each boot, before arising, an 8-candle power light. "Boots being tolerably adiathermous," says the electrician, "their temperature will soon rise." This may be an English joke, therefore we refrain from commenting on this antidote for cold feet.

entirely new type of car, and one which is specially well adapted to the work to which it will be assigned. This car, which is about 40 feet in length, will have a seating capacity of 60 persons, with a separate compartment for carrying freight and express, having a capacity 6 by 8 by 9 feet. A speed of 40 miles an hour on levels is contemplated, and will doubtless be attained a good part of the

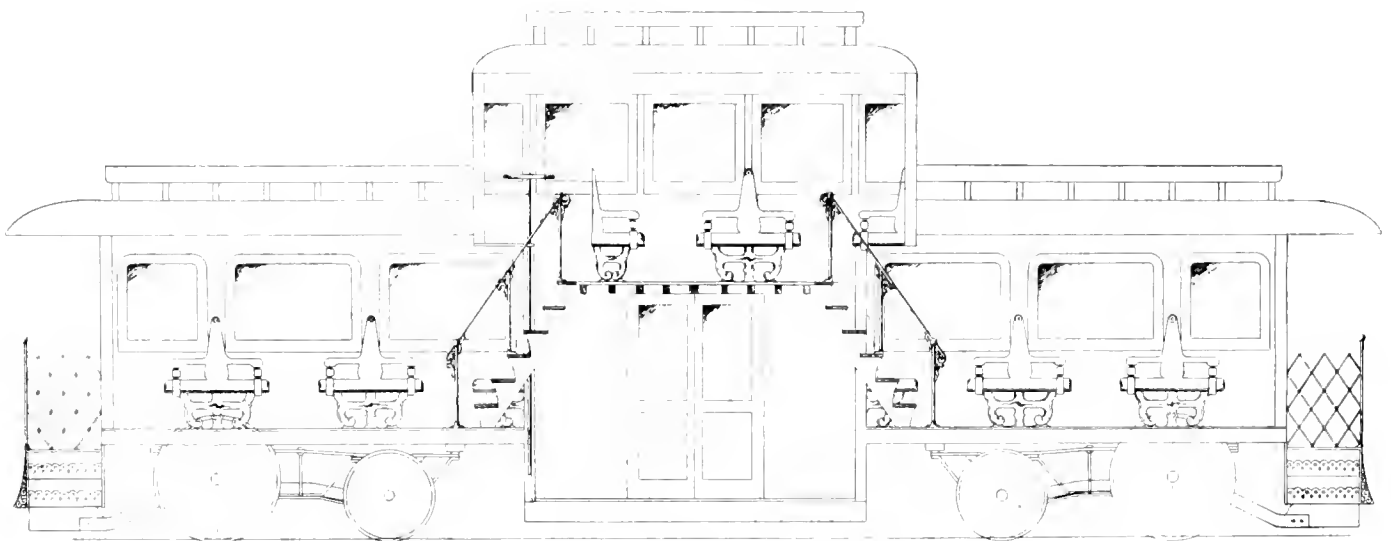

ELEVATION RIBLET'S INTER-URBAN CAR.

GOOD Col. Elliott Shepherd, of New York, has a judgment of \$50,000 against that disgrace to New York, the Fifth avenue stage line. We hope the Colonel will get possession of the affair and put a printed copy of the golden rule on every stage with other appropriate scripture on the horses.

distance, as the grades do not exceed one per cent, and curves are also very light with the exception only of two 10-degree curves.

Cars will be equipped with air brakes and upholstered with embossed leather, and the windows of plate glass; the entire finish being of palatial character. Outside of the regular passenger and freight business the company will do a big excursion business during the summer months. Trailers will be attached to motor cars to accommodate the traffic at such times. The Coeur'd Alene Lake will be one of the termini of the road. This lake is

THE Southport, England, town council, has adopted a plan for constructing an electric road. It is also reported that a line will be opened in the Matlock district. The latter is a private affair.

a very beautiful sheet of water some 30 miles in length, situated in the heart of the Coeur d' Alene mountains, and abounds in fishing and hunting. It is already one of the most popular resorts of Eastern Washington. Our illustrations convey a very intelligent idea of the arrangement of the interior of the car. The observation room will be specially inviting and will also be the location for the motorman. Mr. Riblet has succeeded in planning a car strong in construction, of large carrying capacity and unusually attractive in both interior and exterior.

The driving wheels are 42-inch diameter paper wheels with steel tires. The smaller wheels are 30 inches, of same make. Two 45 horse-power single reduction motors will be used on each car. Car and motor equipment will weigh 9 tons. Controlling stands will also be placed on front platform for use in operating car when on that portion of the line within the city. Car will be painted ivory white with gold trimmings. The distance from

PERSONALS.

A. E. TOWNSEND, Pittsburg, is the new president of the Washington, Pa., electric railway company.

HENRY MILLER becomes president of the Suburban Rapid Transit, of Pittsburg.

C. H. COBB, general manager of the Kankakee Electric Railway, made us a pleasant call recently.

S. W. HUME has been selected as the new western representative of Power.

GEO. A. MURCH has resigned the superintendency of the Worcester, Leicester & Spencer Electric.

C. S. MONTGOMERY, a prominent attorney of Omaha, has been elected to the presidency of the Houston, Texas City Railway Company, vice E. A. Allen, deceased.

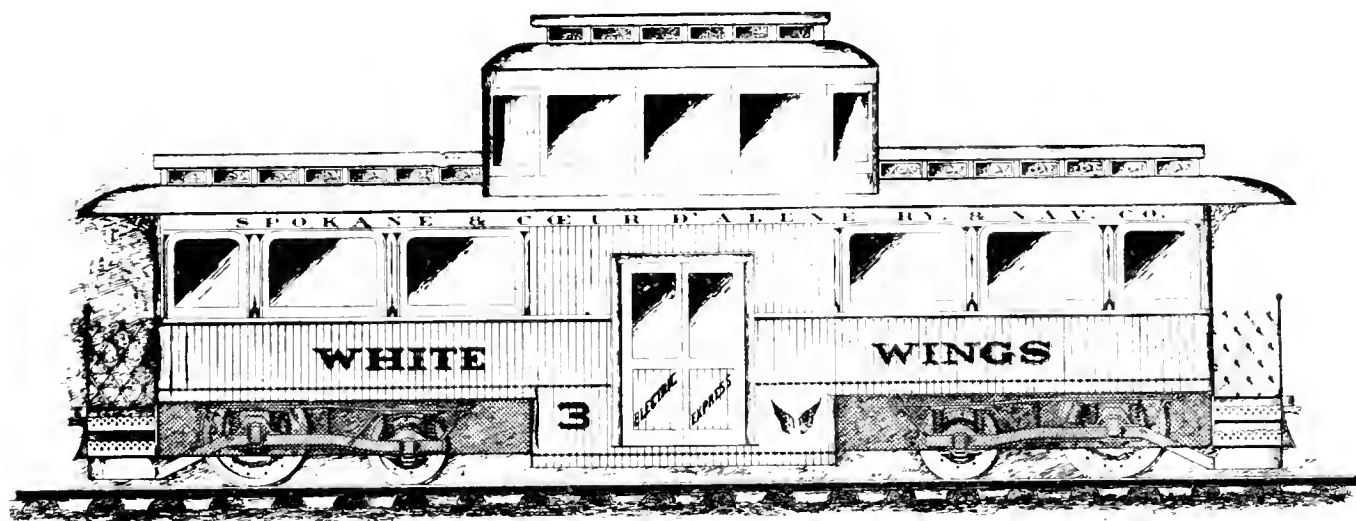

NEW CAR FOR THE SPOKANE & COEUR D' ALENE RAILWAY & NAVIGATION COMPANY.

Spokane to the lake is 32 miles. Power will be derived from two water-power stations, one in the city and the other at Post Falls, on the line of the road 22 miles from Spokane.

THE pending bill in congress to allow the importation without duty of certain electrical machinery necessary to the operation of electric railways at a very high speed is being fought by the General Electric Company through its counsel, E. C. Lewis. On January 12, before the senate committee, Mr. Lewis admitted his company had not, nor did he know of any in this country which had ever built the special machinery in controversy, but expressed his belief that they could do so in time. Dr. Wellington Adams, who is asking the passage of the bill for the Chicago-St. Louis electric, stated the apparatus needed by his road was made only in Germany, and that to wait for the perfection of machinery here would entail severe losses and delays upon his work. The bill is not a special concession as it applies to any high speed long distance road which may desire the same privileges here,

LEWIS J. COX, vice-president and treasurer of the Terre Haute Car & Manufacturing Company, made the REVIEW a pleasant visit during his last trip to Chicago.

B. F. HARRIS, JR., Champaign, Ill., general manager of the Urbana & Champaign lines, has just returned from an eastern trip in the interest of his company.

H. S. COOPER, of the Winston-Salem, N. C., road, has been appointed superintendent of the Alexandria & Mt. Vernon, of Washington, D. C.

F. C. DAVIES, secretary of the Piqua, O., street railway, and Miss Margaret Johnson, of Cincinnati, were married last month.

J. P. KEMPER, of New Orleans, recently of the Grea Western, has taken up residence in Chicago to engage in electrical construction.

BEN B. GILMAN, who as superintendent of the Louisville City has earned so enviable a record, has accepted the same position with the new consolidated in New

Orleans. Mr. Gilman is another example of self promotion, having started in as driver, and by sheer merit worked himself up to his present responsible and desirable position.

D. W. DOZIER has assumed his office as chief engineer of the Kansas City Cable. Mr. Dozier is one of the most enthusiastic and capable engineers in the cable fraternity.

JOHNS HOPKINS, vice-president of the Huntingdon & Broad Top railway, has been elected president of the Hestonville, Mantua & Fairmount Passenger Railway Company, of Philadelphia.

J. LOUIS VANNESS, JR., of New York, is associated with Harry Bishop, of the Massachusetts Chemical Company. These gentlemen, with offices at 823 Monadnock, Chicago, will represent insullac in the west.

FRED. S. WARDWELL, general manager of the Duluth street railway, and under whose guidance the company have been able to show so flattering a business, spent several days in Chicago, calling on the REVIEW while here.

G. HELLEBRUCK, assistant in the railway department of the General Electric at Lyrin, has accepted the position of master mechanic with the General Electric Company at Brussels, Belgium.

F. A. REED, of the Washington, Alexandria & Mt. Vernon road, Washington City, has taken charge of the business relations of the company after putting the road in operation.

E. F. SEIXAS, of the Street Railway Gazette, has accepted a flattering offer and becomes manager of the advertising department of the Chicago & St. Louis Electric railroad.

GEO. F. TALCOTT, the general sales agent of the Campbell Electric Supply Company, Boston, paid the REVIEW a most pleasant visit during his recent very successful business trip in the west.

JOHN C. WEAVER, the energetic and capable superintendent of the Mt. Adams & Eden Park lines in Cincinnati, has been making a trip inspecting the railway systems of Chicago, St. Louis and other places. He made the REVIEW a pleasant call while in Chicago.

COL. W. H. SINCLAIR, Galveston, exchanged for ten days, the icy weather of his home for the delightful summer breezes of Chicago and New York, the first of the month. During his stay in Chicago, his two sons, who are studying at a military school in Michigan, paid him a visit.

WM. RICHARDSON, who as president of the Atlantic Avenue Railroad, Brooklyn, has managed its affairs in so signally successful a manner for the past twenty-five years, has declined a re-election, although remaining with

the company in an advisory capacity. Mr. Richardson is one of the best known street railway managers in the country, and fully deserves a well earned enjoyment of relief from vexatious details.

W. H. SHAFFER, manager of the Richmond, Ind., road, is to assume charge of the Asbury Park, N. J., line of which his brother, John C. Shaffer, is president. The citizens of Richmond are very sorry to lose Mr. Shaffer. Fred Roth will probably succeed as manager of the Richmond road.

THE South Chicago City railway is to be congratulated on its electrical engineer in the person of J. F. Esterbrook. He is one of those who has risen from the ranks of the every day electrician to a position where his recent labors have resulted in one of the finest electric plants in the country, and one in which he feels a just pride.

S. H. PIERCE AND H. T. PURDY, general manager and general superintendent respectively, of the Tacoma Railway & Motor Company, have assumed their duties. Mr. Pierce comes from the Northwest General Electric of St. Paul, and Mr. Purdy is a graduate of St. Paul street railway practice and Edison experience. Both are competent and progressive men.

MRS. CHAS. T. YERKES recently lost two beautiful 7-carat diamonds in her New York hotel on Fifth avenue. A reward of \$500 was offered for their recovery, and a servant girl in the house, three days later turned in the stones which she had found, and claimed the reward, which was promptly paid. The servant girl has since received forty-seven offers of marriage from the male attaches of the hostelry.

DR. A. EVERETT, for the last 33 years president of the East Cleveland railroad, retires from his long and successful career by resigning these duties to his son, Henry A. Everett. Dr. Everett has well earned his vacation, but his strong influence and kindly presence will be sorely missed in the meetings of the street railway fraternity. The result will be a reorganization. Henry A. Everett has a splendid personal record as well as good street railway heredity, having grown up with the company.

GEO. A. CRAGIN, who has scored so excellent a record as general manager of the San Francisco branch of the Washburn-Moen Company, will take charge of the company's interest at Houston, Texas, and be succeeded by Frank L. Brown, of Portland, Ore. The latter leaves the position of secretary of the extensive interests of Mitchell, Lewis & Staver, at Portland, to connect himself as above. He is a most genial gentleman of wide business experience and splendid executive ability. Mr. Cragin is already so well known to electric railway managers that it is quite unnecessary to add that he as fully is entitled to the good qualities just attributed to Mr. Brown. Both gentlemen were in Chicago for a few days the past month.

A CHINESE CABLE LINE.

PERHAPS many readers of the REVIEW are surprised at this title, but the "heathen Chinese" has learned more than one game from his occidental brethren. The latest cue taken is an improvement for getting up hill, which exercise is no more relished by the celestial pedestrian than by the inhabitants of San Francisco.

The city of Hong Kong, where the cable is installed, is on an island about twenty-seven miles in circumfer-

mountain springs, on account of which feature comes the name Hong Kong—"sweet waters." A fine, six-story hotel with all modern conveniences ministers to the sea-worn traveler, and several beautiful resorts enable the residents to ameliorate the torridity of the climate. One of the most popular of these pleasure spots is known as the Peak and to this Peak our story has its most pointed reference.

The Peak lies at the back of the town and has an elevation of 1,800 feet. To reach the top by foot requires more energy than is allowable to the ease-loving east-



HONG KONG CABLE RAILWAY—SHOWING DEPRESSION PULLEY.

ence and is, by all odds, the most modern city in eastern Asia. Its record is much more like many new American towns than any on the continent.

In 1841 the island was only a rendezvous for pirates, but English money and Saxon ideas have made it a city of 200,000 souls, with a magnificent harbor, a civilized European municipal government and the only cable railway on the mother continent of our race. Eight thousand Europeans dwell in the island, and in their ships is taken the greater part of Chinese commerce.

The island itself is beautiful—diversified by mountain peaks and well supplied with water from hundreds of

erners, even for pleasure. It was necessary to devise other means to attain this end. Therefore the High Level Tramways Company, limited, with an eye to the shekels, built the present cable line, which for 4,900 feet passes through the most beautiful of the hill residence portion of the town. The scene from the car is a magnificent panorama of fantastic residence, solid English houses, crystal brooks and green lawns culminating in a surprisingly beautiful landscape visible from the summit. On either hand may be seen the sea studded with islands and alive with the tiny boats of the natives and the greater vessels of the transpacific, and transatlantic

commerce. The mainland is distinctly visible, separated only by a narrow channel from the British-governed stronghold.

The residence portion along the route is laid off in terraces, and one of the greatest points of interest is a stop at the Bowen road which stretches along for miles. This road is the city aqueduct paved over smoothly and is one of the most beautiful pleasure walks in the world.

The cable road was opened for traffic in 1888, and was three years in construction. The gauge is five feet, and the grade averages one in four, with a minimum of one

The cars are of the composite pattern on double trucks, 32 feet long, weighing $4\frac{1}{2}$ tons empty. They carry forty passengers and two employes.

For safety in this sensational climb, a clip-brake, gripping a center rail is used, and frequent governmental tests are made of the machinery and rope.

Our engravings show the method of guiding the rope by means of pulleys placed at intervals for straight runs, lateral curves and concave vertical curves. The road is successful commercially, and a great convenience to travelers.

The personnel of the company's force is as follows:



HONG KONG CABLE—ONE CAR ABOVE AND ONE CAR BELOW POINT WHERE PHOTOGRAPH IS TAKEN.

in twenty-five and a maximum of one in two feet. The method used is the tail end system, with a cable $3\frac{1}{2}$ inches in circumference and breaking strain of fifty tons, made by D. H. and G. Haggie, Sunderland, England. The rope winds three times around the drum, which is eight feet in diameter at the bottom of the grooves. The motive power is furnished by two pairs of engines of 220 indicated horse-power, made by Ruston, Proctor & Co., London, supplied by two 40 horse power semi-portable locomotive boilers.

Municipal regulations require a speed of less than 9 miles per hour. The actual speed, however, is from $5\frac{1}{2}$ to $6\frac{1}{2}$ miles an hour.

I. F. Boulton, A. M. I. C. E., resident engineer; W. Smith, C. E., Aberdeen, Scotland, consulting engineer; I. D. Humphreys & Son, Hong Kong, managers.

THE NEW YORK COMMISSION.

THE ultimatum of the much-suffered New York Rapid Transit Commission is at hand. This ukase holds the underground road in abeyance, and declares that present needs shall be met with extensions of the elevated. The commission still adheres to the underground idea, and hopes for some capitalist to sacrifice himself for future generations.

RAIL BONDING AND THE GROUND RETURN.

Brief History of Methods—Present Difficulties—Reports from Leading Roads Throughout the Country.

THE question of rail bonding and the ground return has been a living one ever since the operation of the first electric railway. One reason for this was the fact that in the early days the ground return was not made heavy enough or was soon overtaxed by the growth of traffic. The more recent troubles, however, are from electrolysis. This latter acts much more quickly in some soils than in others, and depends in part on the amount of traffic and the metal used. Thus iron is thought to be much better for some soils while in others it is almost worthless. The fact still remains, however, that wherever there is moisture a bare conductor laid in the ground will be subject to electrolytic action. The question is how to reduce this action to as low a point as possible.

In the first roads the rails alone without any bonding were used. Of course so much power went to waste that something had to be done, and rail bonding was resorted to. The most primitive way of doing this was to simply rivet the bond wire to the rail ends. This gave trouble in most cases, because moisture would get in around the riveted joint and the result was poor contact ending in complete corrosion. The next step in the direction of bond improvement was to either weld or solder the bond wire to the rivet. There has been some complaint from poor contact at the weld in these cases, and faults are said to develop from the jarring of the rail end. Wherever moisture gets in around connections there is liable to be trouble. Wedging in the bond with channel pins has found some favor. The more recent forms of bond are all made in one piece with the ends so fixed that they can be riveted into the rail end. It has recently been suggested to protect the bond from moisture by slipping over it a block of wood slotted on one side to receive the bond and filled with pitch before application. Track feeders and connections to water and gas pipes were the next step in the evolution of the ground return.

A typical railway system of the present will consist of some or all of the following features: Connections with gas and water pipes along the line and at the station; similar connections with ground plates, buried car wheels, etc.; bare track feeders run to different points along the road; bond wires (or double bond wires) connected to feeders and cross connected at regular intervals. In addition, overhead return feeders are being installed at present in many places. There is much difference of opinion as to the relative merits of iron and copper for bonds and feeders. Some claim that there will always be chemical action between iron and copper when placed in the ground, while on the other hand the more numerous advocates of copper point to the enormously greater mass of metal required to conduct a given current than would be required with the use of copper. It is very probable that the difference in soils is responsible for many of the differences of opinion on the iron and copper question.

Quite recently plans have been suggested for the use of old rails as return feeders. By using a great number it is claimed that a sufficient cross section can be obtained while the use of worn out rails makes it cheap.

It is evident that whenever the current is obliged to flow from the ground to a metallic conductor or from a conductor to the ground electrolysis will show itself on the metal. The aim then should be to prevent such passage of current as much as possible by the use of low resistance metallic circuits, unless it is intended to use ground plates and renew them regularly.

With the idea of obtaining information as to past experience and present practice in this matter the STREET RAILWAY REVIEW has written to a number of the older and larger roads of the country asking the following questions:

- How long has your road used electricity?
- Have you had any trouble with track bonding and the ground return? If so what?
- What methods have you used and what have been the results?
- What do you consider the ultimate solution of the problem?
- Have you ever tried dispensing with ground plates and depending on track feeders alone?
- Any complaint from water companies as to the oxidation of their mains from the current?

The answers received afford the greatest variety of practice conceivable. The soil, the traffic and the age of the road all show their influences in these answers.

On behalf of the REVIEW and its readers we take this occasion to thank our friends for their prompt and comprehensive replies.

DENVER.

Superintendent C. K. Durbin, of the Denver Tramway Company, writes that their road has used electricity since December 25, 1889. The only trouble they have had with track bonding arose from the use of iron bond wires, where there was electrolysis caused by salt. At first they used iron bond wires and then No. 4 copper, but finally adopted No. 0 copper. He considers the solution of the problem to be good connections at the joints, good ground connections, such as water pipes, creeks, rivers, or any water body, and plenty of return feeders. The company has never used ground plates and has had no complaint from water companies.

SALT LAKE CITY.

The Salt Lake Rapid Transit Company have no track feeders but use bond wires cross connected about every 500 feet. The bonds are Nos. 2 and 4 B. & S. copper wire tinned. These are set and soldered in the head of a malleable iron rivet. They are grounded to water pipes, artesian wells, waterways and any other places where a good ground is obtainable. No complaint from water companies. Some of their bond wires have been eaten out in six months and some have been in for two years.

The difference in soil causes this. Some galvanized iron bonds have been used by the side of copper but have not been in long enough to show what they will do.

Jas. N. Smith, electrician of the Salt Lake City Railroad Company, says that they use a No. 4 copper wire bond with cross bonds at every joint. They had tried dispensing with ground plates and using track feeders alone, but it was not satisfactory and they had found that if the track bonding was poor there would be trouble from water pipes. Personally Mr. Smith says that he has installed some four or five electric roads and has found that good track bonding is necessary and that the return can not be too good. He has tried the feeder system and also tapping onto water pipes, but does not consider the latter good as it injures the pipes.

OGDEN, UTAH.

H. H. Smith, electrician of the Ogden City Street Railway, says that they use a No. 3 copper wire for return, and the bonds are connected directly to this, the joints of course being soldered. All wires are in as good condition to-day as when first put down, in September, 1891. No complaints from water companies. Mr. Smith thinks it best to depend on feeders for a return.

FROM DES MOINES.

General Manager Hippee replies: "We use the rails bonded and an o wire on each track. The bond wires are soldered to the continuous wire and are cross connected at close intervals. Our return wires have been in about three years. We have never had any trouble with them, except where we have an excessive amount of current going through them near our power house, where they burned off; but this was on account of not having enough wires. We use some ground plates but not many. We have during the last sixty days put up overhead return wires, which are connected to the rails at intervals where our heaviest current is used, and think that this is much the preferable way. I believe that there is as much necessity for an equal amount of ground wire going back to the power house and to the generators as there is for feed wires to carry the current to your line."

WASHINGTON, D. C.

The report from the Eckington & Soldiers' Home Railway, of Washington, D. C., says that they use a supplementary in connection with track bonding. Bonds are of No. 6 copper, held with channel pins, and the return has been in three years. They depend on track feeders alone for the return, and have had no trouble from electrolysis of water pipes.

ANOTHER EASTERN CITY

of over 100,000 inhabitants reports as follows: They have used electricity about eighteen months and have had no trouble with their return. They use rail bonds with a supplementary copper wire, and cross connections from rail to rail and between double tracks. In some cases only bonds are used. No ground plates are used, and here has been no complaint from water companies.

LA FAYETTE, INDIANA.

Another very interesting and valuable reply is that of Superintendent J. S. Hill, of the Lafayette Street Railway Company.

"I take pleasure in replying to your favor of the 3rd inst. relative to ground returns for electric street railways, as I have read with interest the articles regarding this subject, and think it is one which all street railway men should give their careful attention. We are using nothing but the ordinary rail bond on our road here, that is, since rebuilding the system. We have removed the old copper ground wires which were put in in 1888, as they were entirely eaten through in many places, and the light copper wire by which they were fastened to the rails was in nearly all cases gone entirely. Our bond wires are of galvanized iron, three-sixteenths to one-fourth inch diameter, riveted across the rail splice in the usual way on the T rail, with a cross bond from both rails every three-rail lengths. This we find very satisfactory, as our rails are fifty-six pounds to the yard, which gives us a large metallic surface for a ground return. There are also several ground plates which were used by the old system, but which I abandoned, as they were not reliable, and we use four No. 2 copper wires from the power house strung on poles, and in addition to this several short sections of rail sunk in the river and connected on switch board at power house. We have been using this for over one year with entire success, and we have had no complaints from water or gas companies regarding oxidation of their pipes, and in fact I have been compelled to use the natural gas pipes for a return during the extreme cold weather in the winter of 1892, as we had torn up our track to relay it, and while the ground was wet we had a good return, but as soon as it became frozen it was almost impossible to run a car. But I connected the pipe at the power house to switch board and then to the branch line where we had the trouble, and succeeded in running everything all right. I believe the oxidation of gas and water pipes due to electric current is caused by their not being connected directly to the ground wires at the power house, or that they are used entirely as a ground return, and have not sufficient surface to carry the heavy amperage which street railways use. But it is an undoubted fact that the above subject is worthy of consideration on the part of all street railway men, as a good ground return is a necessity for the successful running of an electric street railway."

(TO BE CONTINUED.)

INDEFINITE POSTPONEMENT.

FATHER OF THE HEIRESS—What are your expectations?

THE SUITOR—I am to be manager of the Underground railway of New York.

FATHER OF THE HEIRESS—Bless you, my son, when the road's built you can have her.

MR. CLEVELAND denies the story that he is in the St. Louis syndicate deal.

POWER STATION OF THE NEW HAVEN & WEST HAVEN STREET RAILWAY,
NEW HAVEN, CONN.

THE New Haven and West Haven Street Railway operates a line of double track road between "The Green" in the city of New Haven, Conn., and a seaside resort known as Savin Rock, in West Haven, with two branches in the residence district, being a total distance of $9\frac{1}{4}$ miles, of which $4\frac{1}{2}$ miles are double tracked. Their present equipment consists of 42 cars, comprising seven open cars having two motors of 30-horse-power each, and 16 cars equipped with one 30-horse-power motor each, nine cars with single 20-horse-power motors and ten trailers. The road has the usual city and suburban trade throughout the year, and in the summer season it handles a heavy pleasure travel to the Savin Rock resort.

tion to operate the road electrically on the 1st of July, the company having disposed of most of its equipment of horses, relying on the power plant to handle the holiday crowd. As events resulted steam was raised on the 1st day of July, and the road was ready, so far as the power was concerned, to take care of the 4th of July traffic, and as a matter of fact did so to the extent of the full car equipment at that time in service.

The plant is situated at the west end of the West Haven bridge, at tide water. A pier runs out 300 feet to the ship channel so that coal may be handled by the cargo. A Hunt tramway with dumping car carries the coal from the pier head and distributes it through a coal pocket outside of the boiler room. This pocket is carried on

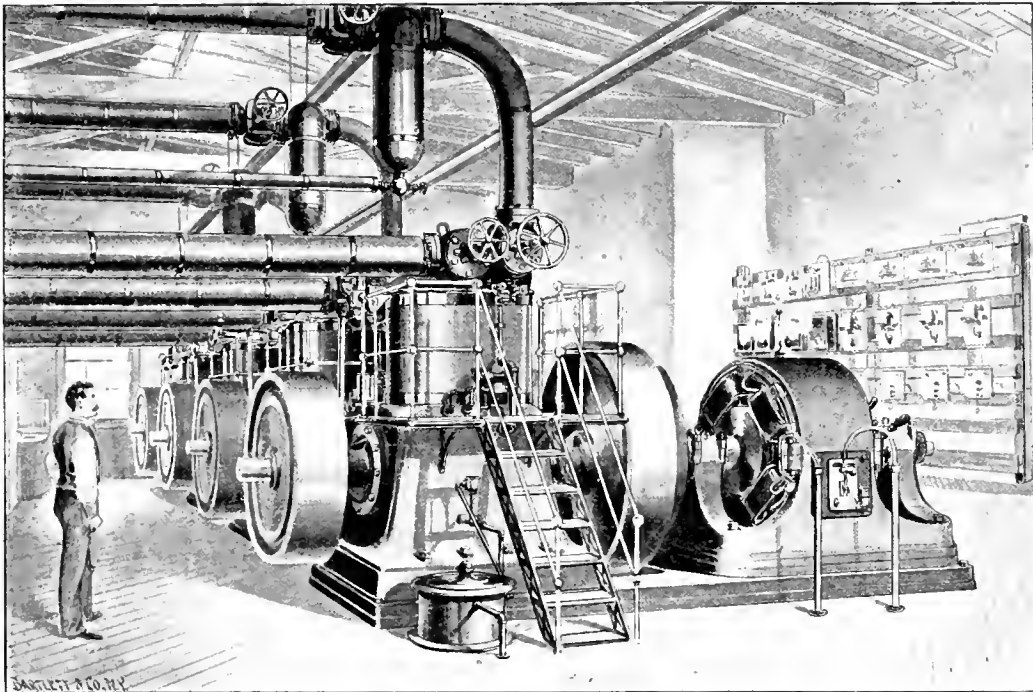

INTERIOR OF ENGINE ROOM.

The power station which this article illustrates is a remarkable example of modern engineering in this department. So far as known it is the first power station in this country which has followed the European practice in completely equipping with direct-connected, slow-speed dynamos, or "Kodaks;" and the whole design of the plant in its minor details is so thorough a departure from the older lines of practice as to attract the attention of engineers and railway men throughout the country. The power station was constructed under contract by Westinghouse, Church, Kerr & Co.; the work being designed and supervised by William Lee Church of the above concern. It is worthy of remark that the contract was awarded on the 6th of April, 1892, and the ground was broken on the following day. The contractors, although not formally bound, were under a moral obliga-

heavy timbers, with a floor incline at such an angle as to let the coal run freely into the fire-room through openings in the building wall opposite each boiler. A coal supply for ten weeks can thus be stored, being sufficient to tide over any possible freezing of the bay during a severe winter.

The building is laid out for a total plant of 1,000 horse power, nominal generator capacity; 500 horse power being installed at present under the original contract. The boiler room is 72 feet by 29 feet with a clear height of 26 feet under the trusses. The floor is of brick laid in cement, being on a level with the grade outside. A slope of about 4 feet in the lot enables the floor of the dynamo room to be raised above the boiler room, and at the same time to be entered at grade from the front of the building. The boiler plant at present consists of three Manning

boilers of 150 horse power each, two of which are adequate to run the present plant to its full capacity, the third standing as relay. These boilers are furnished with shaking grates, and an ash car runs on a track within convenient distance of the ash pits.

A most striking feature of this plant is the perfect control of the fires independent of conditions, by the use of mechanical suction draft. The observer will be struck by the absence of the usual chimney stack, and will find it difficult to believe that an insignificant steel stack 4 feet in diameter and showing only nine feet above the ridge of the roof, is the only provision for firing the ultimate plant of 750 horse power of boilers to their fullest capacity.

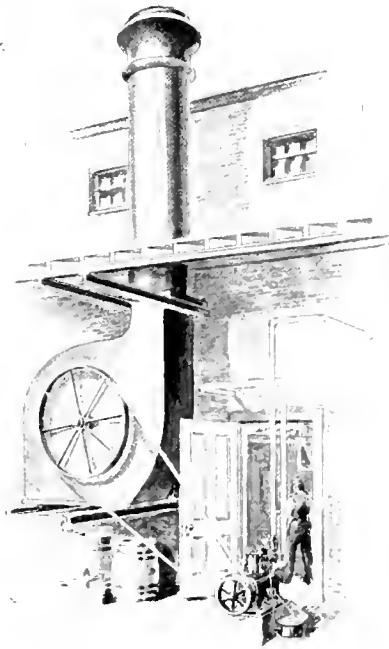

STACK AND EXHAUST FAN.

The smoke flues from the boilers are carefully protected by non-conducting material, so as to save all the available heat for transference to the feed water in the economizer. The smoke flue after running to the back of the boiler room dives down into a brick chamber, in which is a Lowcock economizer, the scrapers of which are operated by a little engine on its upper deck. A by-pass with damper runs underneath the floor of the economizer, so that the latter can be cut out for repairs without interfering with the boiler service. The cold end of the economizer opens directly into a large slow-running exhaust fan whose wheel is 6 feet and its case 9 feet in diameter. This fan stands on I beams in an annex to the boiler room, and discharges directly up into the bottom of the stack before mentioned. In the base of the stack a steam nozzle may be placed as a relay in case of temporary repairs to the fan, the chances of which may be judged from the fact that it runs in ordinary service at from 10 to 50 turns, and in rare emergencies at 80 turns. At the latter speed the air can be heard to whistle through the ash pit doors, and an intensity of combustion is obtained which practically doubles the rated horse power of the boilers. The power for the

fan is a Westinghouse engine of nominally 5-horse-power, but which runs under a throttle barely started from its seat. The economizer extracts all available heat from the gases, reducing their temperature in the fan to practically that of the incoming feed water, and returning to the boiler a heat value which would otherwise be required for the production of natural draft in the chimney. The economical results are very marked, but a not less important feature in connection with street railways is the entire control which the fireman has over his steam pressure under all the fluctuating emergencies of railway service. He no longer fears a poor quality of coal, dirty tubes, or dirty fires after a long and hard run. He is not

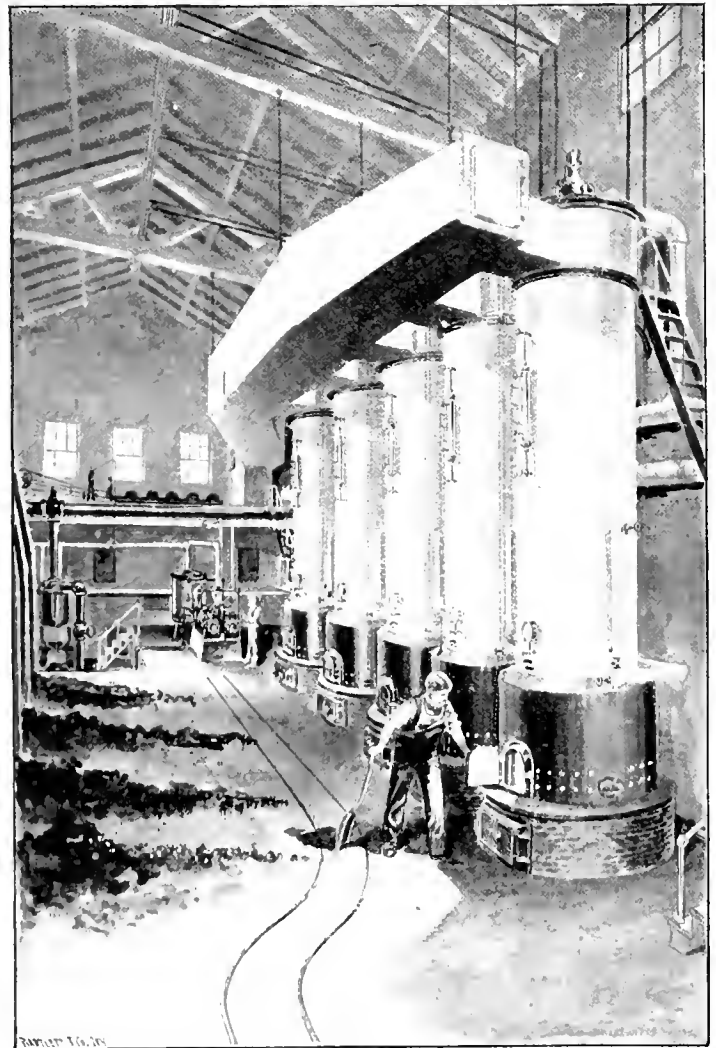

INTERIOR OF BOILER ROOM.

appalled by a heavy snow fall or by a sluggish condition of the atmosphere, which is apt to kill the draft at a time when the tracks are the greasiest.

Its capabilities were brilliantly illustrated by an incident occurring shortly after the road was opened in July last.

The day was a sultry summer day, and in consequence a large crowd had accumulated at the sea shore. The company had only four motor cars at that time in service, the remainder of the traffic being taken care of by the

horse cars. Several other motor cars were equipped and standing in the car shed, but no motormen had been assigned to them. A railway man need not be told that a green motorman will use an extravagant amount of current, and will unlatch the circuit breakers with a frequency which is ruinous to the morals of the man at the other end. In the evening a heavy thunder storm came up and the crowd immediately flocked for the cars. Word was telephoned to the power house that the crowd was coming and must be taken care of: that the new cars would be run out with green men and must be handled at all hazards. One boiler and one engine were running, and the second standing banked from the night before, and showing a pressure of 45 lbs. The fan was speeded up a few turns, the second engine immediately started from the same boiler, and the fire hauled down in the second boiler. In eight minutes from receiving the message the second boiler showed 120 pounds of steam, and the first boiler had pulled through the double duty and the car service performed without a break. These facts appeal mightily to the railway manager, who cannot make up for lost time in dealing with the public, which accepts no excuses.

In the boiler room is the usual double equipment of feed pumps, either pump being adequate to supply the full battery of boilers. These pumps take water through a meter, so that by weighing the coal, and dividing into the water, a running log of the evaporative duty can be taken and reported to the office. The feed water is first carried through a National heater, into which are turned the exhausts from the feed pumps, condenser, fan engine, etc., the whole being sufficient to raise the temperature to about 150°. From the heater it goes through the economizer, and reappears with a temperature of about 330°, in which condition it is fed to the boilers.

A pit in the boiler room contains a Deane independent condenser which receives the exhaust from all the main engines in the generator room. The injection is salt water drawing through a suction pipe from the end of the pier,

and discharging to waste, its value being as a producer of vacuum only. Entering the generator room, we find a floor space 72x31 feet and 16 feet high under the trusses. This room contains three Westinghouse compound engines of 160-horse-power each, with maximum of 200-horse-power under 125 pound steam coupled direct through a flexible insulating coupling to Westinghouse slow-speed generators of 160-horse-power nominal capacity. The room will ultimately contain six of these generators, aggregating around 1000-horse-power of rating, with a maximum capacity much in excess of this figure. Each kodak occupies a floor space 6 feet by 16 feet 4 inches, and the arrangement is as shown in the interior view, the distance between centers being 11 feet. A separator is

placed in the steam line to each engine near the throttle, and an independent steam loop runs from each one, getting its rise in the roof of the boiler house. Absolutely dry steam is thus insured, and all water of condensation or entrainment is returned to the boilers. The 12 inch exhaust line is made tight against vacuum by screwing the pipe clear through the flanges and riveting the end down into a counter-sink. Expansion is taken care of by copper bends in both the steam and exhaust lines, and since starting the plant not a sign of leak-

age either of steam or air has appeared, and a steady vacuum of 27 inches is maintained.

A trolley-fall runs on an I beam over the line of engines and over the line of generators, permitting of quick handling in case of repairs. An alcove 30 feet long and 6 feet deep contains a skeleton switchboard of quartered oak, so located as to be accessible from all sides without projecting into the main body of the room. The floor is laid in diagonal stuff of hard pine, and ample provision is made for artistic lighting on the generators and switchboard, the lighting circuits being on a shunt from the main circuits. The perfection of the engines as to speed is strikingly exhibited by the perfect steadiness of the lights, notwithstanding the rapid and extreme fluctuations of load common to railway service.

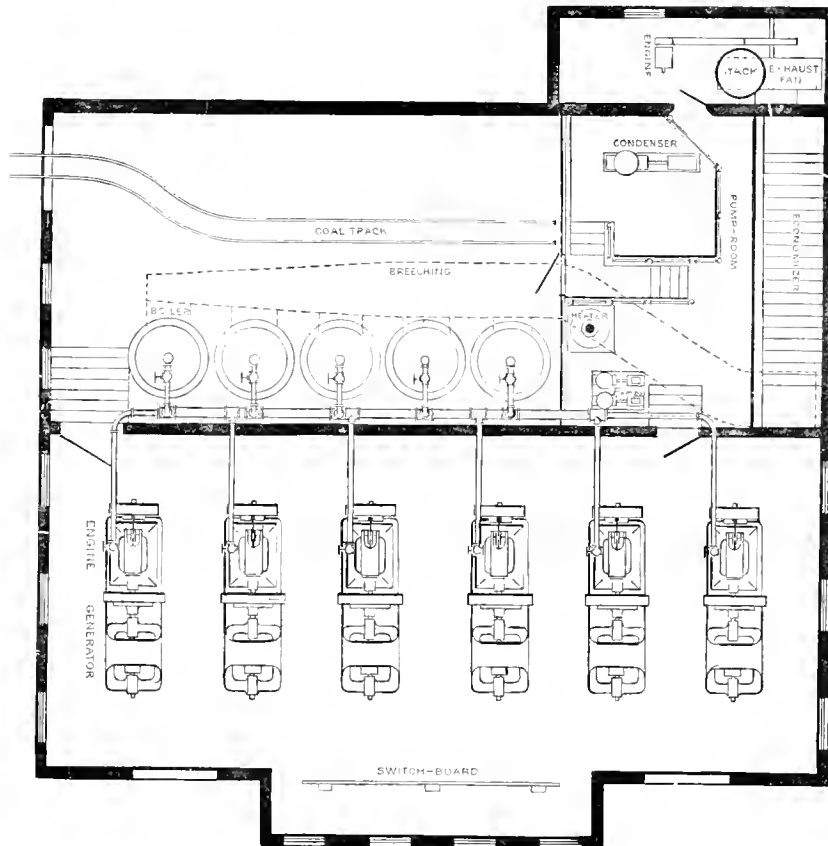

PLAN OF POWER STATION—BUILDING, 74x64. CAPACITY, 1000 H. P.

A fact which will strike every practical man is the remarkably small space occupied by the entire plant. We have here a building 74 feet by 63 feet outside which contains a 1,000-horse-power equipment complete, including engines, generators, switchboard, boiler plant, with relay, economizer, condenser, feed pumps, and all sundries, including a most generous space for the fire-room. The remarkable economy in ground space thus secured is indicated in the fact that less than 5 square feet of space per electrical horse power is required for all purposes. This for a small plant. A more recent design for a complete power station of 8,000-horse-power generator capacity on a still more compact arrangement, reduces to 2.3 square feet per electrical horse power. The bearing of this fact upon the cost of real estate, particularly in city plants, and upon the cost of the building, is obvious, amounting to a reduction of fully two-thirds of this heavy item.



COAL HOIST AND TRAMWAY.

The effect upon the capital account is obvious, and the next point of interest is the result in the operating expenses. In this particular the records of the above described station speak for themselves. No official test has yet been made, as the complete car equipment was not in service until the summer rush was over. A detailed test will be made in the summer of 1893, but the company has kept running records of the car mileage and coal consumption, which give the essential information. Owing to the non-completion of the pier and the suction line to the condenser, the engines were run non-condensing for some months after the plant was started. During this time an average of almost exactly 2,000 car miles per day was performed at a total cost of coal of exactly \$18; coal being \$3.67 per ton delivered in the bins. This reduces to of one cent per car mile. About the first

of October the condenser was connected with an immediate reduction to .82 of a cent per car mile. At the present writing the plant is running on almost exactly four tons of coal per day gross consumption, including not only banking of fires, steam for pumps, condenser, fan engine, etc., but also the electric heating of all the cars in one of the severest winters on record, or slightly less than three-quarters of a cent per car mile for power, light and heat. This, at the comparatively high price of coal obtaining in New England, is a result which demands the thoughtful attention and comparison of railway managers, and very conclusively establishes the question of the adaptability of a proper design of compound engine, either condensing or non-condensing, to the variable loads of railway service. It further indicates the economical advantage of converting the power in the most direct manner possible from the piston of the engine to the armature of the dynamo without the frictional losses due to counter-shafting, clutches, etc.

The operating force of the station consists of a chief engineer, who is held responsible for the plant in general, and who runs from starting time until 4 p. m., at which time the second engineer goes on and runs until midnight. There are three firemen running eight hour turns, changing at 6 a. m., 2 p. m., and 10 p. m., the last man acting also as night watchman, and raising steam and starting one engine for the morning run.

The station above described is a bold departure in engineering, but one which rests upon a substantial foundation of practical experience and a full appreciation of the commercial as well as the engineering side of the problem involved. Its success has been marked, and the officers of the company are unstinted in their commendation of the whole plant, and of the contracting parties.

THE ACME STORAGE BATTERY.

A NEW storage battery called the Acme has been tried on Ninth avenue, New York. The battery and car complete weigh about six tons. The peculiar feature of the cell is that the plates are held in a non-conducting material, and this non-conducting material being unaffected by the acid or action of the current prevents the plates from bucking and falling apart. The cells, 144 in number, weigh about a ton. The battery is the invention of P. Kennedy, of New York.

A GOOD YEAR AT PORTLAND, ME.

THE Portland, Maine, Railroad Company directors report that their road has carried 3,449,583 passengers during the year. The power station has been enlarged 250-horse-power, making 550 in all. The whole business has had a substantial increase. The company now make their own cars. During the year \$12,000 in dividends were paid, leaving a surplus of \$19,000. The former officers were re-elected for 1893.

THE New York Rapid Transit Commission have a new play for sale, called "A Hole in the Ground."

THE STRIKER AND THE LAW.

The United States Court at Indianapolis Hands Down an Important Decision—Violation of Law by an Organized Body no less Criminal than by the Individual.

IN the United States Court at Indianapolis, on January 20, Judge Baker, in reviewing the case of the Lake Erie & Western Railroad strikers, hands down a most thoughtful and sound opinion which so clearly and fairly passes on the acts and rights of organized labor that it fully merits reproduction in full in these columns. Judge Baker said:—

“The court recognizes the right of any man or number of men to quit the services of their employers; and it recognizes the right of men to organize, if they deem it expedient to better their condition. It also recognizes the hardships of the life of the average laboring man. Their conditions are often such as to touch the sensibilities of a feeling heart. The court is also aware of the scanty wages which they often receive, of their long and arduous hours of service, frequently exposed to the rigors of an inclement season. All these things are calculated to produce sympathy in every right-minded man. It is laudable for men, whether they are day laborers or are engaged in other vocations of life, by organization, to take any lawful course for the purpose of bettering their condition. But it must be done according to those principles that lie at the very foundation of the social compact. Man was created for organized society, and in order that society shall exist, whatever may be the form of government, it is absolutely indispensable that the great fundamental and God-given right of every human being, unrestrained and unintimidated, to labor and enjoy the fruits of his toil, should be protected. There is little excuse for labor to organize and by unlawful means attempt to overthrow the law. Society is organized under our form of government on the recognition of man's rights as man. If society were overthrown and men turned back into conditions of anarchy, as they were in large measure during the dark ages, when power and force made right, the condition of the laboring man would not be bettered. If such were the condition of society the man or the men with great intellectual power and great wealth would become the masters of the laboring classes as in those dark ages, and the laborer would be little better than a slave.

“The effort of these defendants, as the evidence in this case shows, is an effort not only to overthrow the law, but also an effort to overturn the just authority of the courts. To permit this would be an offense not only against society, but against the laboring men themselves. In the convulsions of society, when law becomes silent and force reigns, it is the humble, and the poor and the powerless that become the victims. The condition of things that is evidenced by these strikes is well calculated to impress thoughtful men with their danger. I do not know but that I am a little old-fashioned in my notions, but I confess that I cannot look with any degree of tolerance on the false and dangerous teachings of those who

actively, or by their silent acquiescence, are leading labor organizations to think that because they are organized in associations they have the right to seize property, or by intimidation to prevent well-disposed people from laboring. In my judgment it is no less criminal for an organized body of men to commit these wrongs than it would be for a single man, armed with bludgeons or revolvers, to commit the same wrongs upon the persons or property of others. I confess that so far as I can see, if my property or personal rights are invaded by a body of men who call themselves organized laborers, there is no distinction, either in the view of God's law or human law, than if the same things were done by a single individual. Indeed, it would be more tolerable if it were done by the midnight robber in the silent watches of the night than if it were done by an organized body of men. I think it would be wholesome if this lesson which was taught me by my parents in a rude frontier cabin in the early settlement of northwestern Ohio had been taught these men by their fathers and mothers. When I come to the final disposition of these cases I shall deal justly and mercifully with these men. But I do not intend that it shall ever be said of me, if anything shall ever be said, that, as a magistrate, I failed in the discharge of my duty in any such way as tended to unsettle the foundations of our government. I am charged with a great and solemn duty. There can be no greater or more solemn duty than that which requires judges to impress on men not only the supremacy of the law, and the rightful supremacy of the law, but that it is necessary that men should be punished who violate the law, in order that the fabric of human society may not go to pieces.

“In this case the evidence shows that there are a number of men who belong to a secret labor organization whose ramifications reach not only over the entire extent of the United States, but into Canada as well. It has kindred associations by other names in Europe. All these organizations have the same general aim, and that is by force, violence and terrorism to compel their employers to submit their business, their property, their means of livelihood to the arbitrary demands of these associations. In their secret, oath-bound assemblies they determine for themselves on what terms they will work for others. They refuse those who are not members of their association to labor when they desire to do so. Those who will not submit to their exactions have no more option about carrying on their business than has the belated traveler when a highwayman presents a revolver and bids him submit.

“As I say, I do not see any difference, either morally or legally, between this sort of business where an organized body of men combine for the criminal and unlawful purpose of compelling somebody else, against his will, to submit to their demands, than if the same thing were

done by a single individual. If they compel submission it is robbery, because whoever compels me by force or terrorism to give up one dime of my money or one dime's worth of my property is equally guilty, whether it be the man who meets me on the street corner in the night-time, or an organized band of strikers who take possession of my property and deprive me of its use. But these combinations are infinitely worse than isolated violations of the law in that they teach general disregard and contempt of law. They make people think that human rights are of no value. They teach the fantastic and monstrous doctrine that a man who is hired to labor and is paid for his work has some sort of equitable right in the property of his employer, together with a right of perpetual employment. It has been said on the floor of the United States Senate that the laborer has a sort of an equitable lien on the property of the man for whom he works, whose money bought the property, together with the right of perpetual employment. It may do for men that are reckless of the welfare of human society, who care nothing for its peace and good order, to imperil life, property and liberty, and the perpetuity of our institutions by teaching such doctrines, but the judge who tolerates it ought to be stripped of his gown and be driven from the sacred temple of justice.

"I think these men have been misled. I think they have been deceived by false teachers, but still they ought to have known better than to violate the law of the land and to trample under foot the solemn processes of the court. I want it to be understood so far as this court is concerned that such offenses will not be deemed trivial, and that the law cannot be violated with impunity by any combination of men under whatever name they may clothe themselves. They will not be permitted to violate the law and then set themselves above the court.

"If laborers wish to organize to learn the principles of political economy, to learn something about the great laws of supply and demand, to learn something about the effect of immigration and the increase of the number of laborers on the wage market of the country; if they want to organize for the purpose of quitting their employers, in short, if they want to organize to do anything that is recognized as within the pale of the law, I have no word of criticism. I think that such organizations for lawful purposes are to be commended. But when these organizations, as I said on yesterday, combine and confederate for the purpose of seizing other men's property, or when they undertake by force and intimidation to drive other men away from employment, and thus deny them the right of earning a livelihood, they commit a crime—they commit a crime that this court cannot suffer to go unpunished. There ought to be blazed on the minds of every one of these men that belongs to a labor organization, as with a hot iron, so that they shall know and understand it, that while it is lawful and commendable to organize for legitimate and peaceful purposes, that it is criminal to organize for the invasion of the rights of others to enjoy life, liberty and property.

"I will not pass upon the cases of these men now, and

before I do pass upon them I shall be glad to know who and what they are, something about their former lives, what they have been doing, whether they have been engaged in criminal combinations before this. The gravity of crime depends on the character of the criminal. An ignorant boy who, in the heat of excitement or the impulse of the moment, is led into the commission of crime, is to be looked upon with sympathy, and ought to be dealt with lightly; but the man who is given to lawlessness, who is a confirmed criminal and violator of the law, on whom reason and mercy would have no influence, ought to be made to feel the heavy hand of the law, so that if respect for law and respect for the rights of their neighbors will have no influence upon them, the power of the law and its judgments may have."

MASSACHUSETTS STREET RAILWAY SUPERINTENDENTS' ASSOCIATION.

THE third regular meeting was held in the afternoon of Friday, January 27th, 1893, at the Woodland Park Hotel, Auburndale. Prior to the meeting the members gathered at Newtonville, and took a trip in a special car provided by Superintendent Henderson, of the Newton & Boston Street Railway Company.

The party then took a special car for the hotel, where a fine repast was served. After the cigars were lighted Vice President B. J. Weeks, in the absence of President Murch, assumed the chair and, after a short address, the business of the meeting was proceeded with, the session lasting four hours. The committee on by-laws made a report which was adopted. In these the usual quota of officers are provided for and the membership fee is fixed at five dollars a year. The third Wednesday in June is set as the date of the annual meeting, with quarterly meetings determined by the board of officers.

It is incumbent on every member to make known to the Secretary any subject on which he may need advice or help, and the officers shall, by correspondence or discussion, arranged for at the regular meeting, attempt to help that member to the aid he seeks.

The following matters were discussed:

1. The best methods for keeping a good rail in winter.
2. Snow plows.
3. Improvements in cars.
4. Improvements in trucks.
5. Wages paid conductors and motormen.
6. Arbitrary rule by a president.
7. Life saving fenders.

It was the most interesting and profitable meeting that the association has had and of great value to those present. It was voted to hold the next meeting at Lawrence, date to be fixed by the secretary.

A big black horse attracted considerable attention lately by following one of the new electric cars at Peoria for several days. Investigation revealed that in former years he had been in the street car business, and couldn't forget his old habits. He was finally corralled, and his owner notified.



Work on the exterior of the large buildings is practically finished and an immense force will be turned on inside work.

The avalanche of wet snow that slid from the top of the Liberal Arts Building and crashed through the wings below, was much less severe in its damage than currently reported.

The Siemens-Halske of America will show one of the most interesting displays in electric railway lines. This will consist of a fully equipped conduit system 1,100 feet long with station complete, on the pattern of the Buda Pesth plant.

CARNEGIE, PHIPPS & Co., will have no exhibit, owing to their inability to secure space in accordance with their application. Twenty-five hundred square feet were applied for and 500 allowed. The Illinois Steel Company withdraws for the same reason.

The Inter-Ocean for March 25 will be a complete avant courier for World's Fair visitors. A full list of rooming places, hotels, churches, public buildings, theaters, hack fares, street railways and other items of interest will be found in its pages. They will print 200,000 copies.

The lighting contract for the World's Fair requires machinery, wiring and lamps for a minimum of 92,000 sixteen-candle lamps. The Westinghouse people will supply 12 large generators of 15,000 lamp capacity. Six of these will be driven by Westinghouse Machine Company's engines, direct coupled. The other six will be belted to exhibited engines. High tension long distance transmission will be illustrated in the Electricity Building. The company, if possible, will install a model lamp factory to show the process of manufacture.

The subways for the spider web net work of underground wiring at the Exposition grounds will be perhaps one of the greatest exhibitions of the wireman's skill ever shown to the lay or professional visitors. For two miles

there are conduits in which a man can walk upright without danger to his silk hat, and running from these main arteries are the thousands of ramifications bringing light, heat and power to the various buildings. The two mains run 1,200 feet straight away from the Machinery Building to the Administration Building. Here the left hand tunnel divides into two directions, one running to the Electricity Building and the other to the Mining Building. The second conduit runs to the Electricity Building, turns east to the Manufacturers' Building, under the lagoon to the Government Building and narrowing ends at the Fisheries. The conduits measure 6 feet 6 inches at Machinery Hall. The exterior, including concrete and sand floor, plaster wall and timber roof are 8 feet 4 inches by the same. The wires within are arranged on cross arms and are suspended at intervals of 20 feet on iron uprights. There are twelve cross arms between floor and ceiling. Each arm carries 5 insulators and each insulator two wires. Engineer Sargent calculates that 700 miles of underground wire will be used, and the cost of the conduits at \$65,000.

MOVING SIDEWALK ON THE CASINO PIER.

Contracts have been let for the construction of 4,500 feet of movable sidewalk on the great Casino pier of the World's Fair grounds. The sidewalk is designed principally to carry passengers arriving by steam boats from the lake end of the pier to the shore, 2,500 feet westward.

The Pier Movable Sidewalk Company owns the concession granted by the Exposition Company for a display of this novel and useful method of transportation on the Casino pier. The Pullman Palace Car Company has the contract for the entire rolling stock, the General Electric Company for the motors and electrical equipments and Hiero B. Herr & Co., the contractors who have just finished the pier, will build the substructure, the plans calling for the movable platforms to be five feet above the floor of the pier, so as to afford to all of its passengers an elevated and unobstructed view of the shore and lake. The directors of this company are Wm. Eliot Furness, Max E. Schmidt, Geo. F. Brown General Manager of the Pullman Palace Car Company, H. B. Herr, J. L. Silsbee, Dr. Arnold P. Gilmore and F. W. Gookin. Work will be commenced at once, and rapidly pushed. This exhibit will afford one of the most novel, interesting and practical exhibits on the grounds.

WILLARD A. SMITH.

The chief of the department of transportation is already a well-known figure in steam railway work, and under the three sympathies of a railroad man, an editor, and the chief of this department, we take pleasure in presenting his features to the street railway fraternity.

Mr. Smith was born at Kenosha, Wis., in 1849, of a sturdy New England family, that came in an early day to the then wilds of Wisconsin. His primary education was obtained at the Kenosha public schools, with a collegiate preparation at Rockford, Ill. The year 1865 found him duly matriculated at Shurtleff College, Alton,



WILLARD A. SMITH.

from which he was graduated in 1869. Having chosen the law as a profession, Mr. Smith removed to St. Louis and took up the study of his choice at Washington University, from which well-known institution he obtained his sheepskin in 1871. Here also his first essay into journalism was made in a successful college paper. After graduation the publication of the St. Louis Post Office Bulletin occupied his attention. Having disposed of this venture at a profit, he started the St. Louis Railway Register, a weekly journal, which he conducted with great success until 1873, when he sold out to take possession of our Chicago contemporary and namesake, the RAILWAY REVIEW, the success of which is a standing monument of Mr. Smith's ability.

He owes the nomination to his present position to the unanimous voice of the managers of the railways centering in Chicago, which action shows the confidence reposed in him by men noted for their critical judgment of strict integrity.

The national and local commissions ratified unanimously and immediately the choice of the railway managers. Mr. Smith may be found now at his comfortable office in the transportation building, one of the hardest working and most obliging officers of the Columbian Exposition.



The message of the Sphinx, an heroic statue by Theodore Bowers, will grace the permanent art exhibit. We show an engraving of this unique and powerful subject.

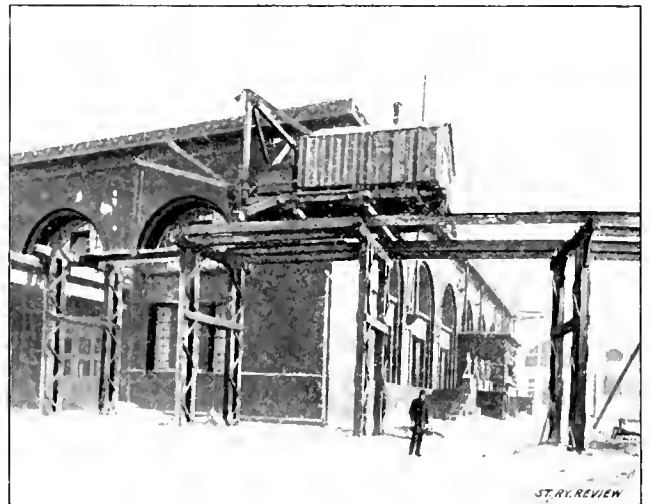

An engraving of the travelling crane that helps build the intramural's tracks is shown herewith. The point of view is at the annex of the Transportation Building.

ANOTHER TEMPORARY PLANT.

The temporary power plants at the World's Fair grounds are first-class exhibitions of the skill of some of our best engine builders and boiler makers. The conditions are ordinarily as severe as conditions can very well be, but the records made and the work done are up to the standard of the various artisans represented in the plants. Of the exhibitions of this character we note

one of the most interesting exhibitions of temporary power installation is the structure just south of the Transportation building, where the necessary electric energy is generated to light the immense buildings and the exposition grounds. The chief of these interesting features in the building referred to is a Buckeye engine, made by the Buckeye Engine Company, of Salem, O. This machine was one of the first installed, under the most discouraging conditions, but the engineers are only the prouder of its service. The engine has a 11 by 16 inch high pressure cylinder, and 21 by 16 low. It is running at 275 revolutions per minute, and, although seldom indicated, is of 150 horse-power rated capacity. It is belted to run one 80-light arc machine, and one 125 power and incandescent generator. Hoyt's belts, sold by W. D. Allen & Co., 151 Lake street, Chicago, are used, and give the best of satisfaction for solid leather belting. The engine foundation is not of the best construction, and, in fact, the temporary construction of the plant militates everywhere against the best results. In spite of this the engine does good work. Our illustration shows the engine and its surroundings.

THE Morgan Engineering Co. of Alliance, O. has built several electric cranes, one of which we show, together with the interior of Machinery Hall. This



machine can lift and transfer 10,000 pounds; has a span of 75 feet and a run of 400. The General Electric made its motors.

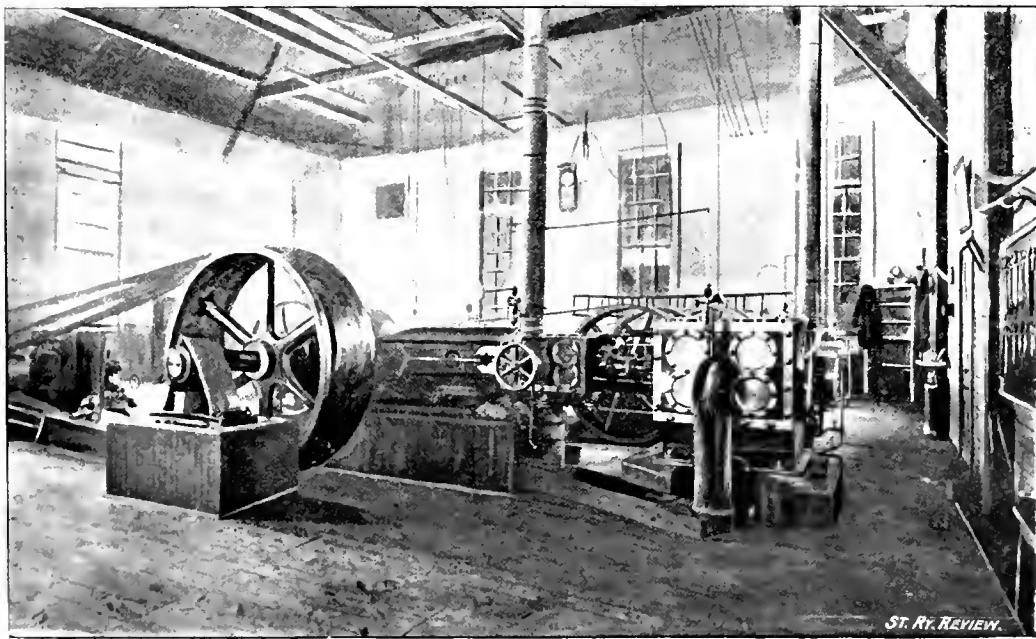

BUCKEYE ENGINES AT TEMPORARY ELECTRIC LIGHT AND POWER PLANT.

Besides this machine the Buckeye Company has furnished for the exposition a 14 by 24 and 28 by 24 inch, cross compound, one 13 by 21 inch, medium speed, one 16½ by 30, slow speed, one 13 by 16, high speed, and a triple expansion of 1,250 horse-power with a 20 by 48 inch high pressure cylinder, two low pressures, each 36 by 48 inches, with intermediate cylinders 32½ by 48. This exhibit, representing the several types built by the company should be a matter of just pride to the builders and of interest to all visiting power users.

THE Fine Arts display will far exceed any previous collection ever attempted.

THERE are already on the grounds 35,000 packages of exhibits, of which a large proportion are foreign.

THE Chinese exhibit, numbering 1,367 packages, has just arrived in Chicago.

THE Western Union Telegraph company has shipped a model of the steamship Great Eastern, which laid the Atlantic cable. It is valued at \$5,000.

A REMARKABLE collection of photographs of transportation vehicles in all parts of the world, is in bond. The collection includes chariots, coaches, wheelbarrows, street cars and steam cars.

MACHINERY HALL.

Machinery Hall will be a mine of interest, as will also be the power plant near by.

The boiler plant is situated in a long, narrow building with a total length of 850 feet. In this largest boiler room the world has ever seen will be arranged from 45 to 50 boilers of the water tube type, with a uniform pressure of 125 pounds to the square inch. The boilers now contracted for are as follows:

Two batteries of two each of the Gill type, 1,500-horse-power; two of two each, Root type, 1,500-horse-power; two of four each, Heine make, 3,750-horse-power; two of two each, National, 1,500-horse-power; five batteries comprising nine Campbell & Zell, aggregating 3,750-

Ball, of Erie. Cross compound of 480-horse-power; Armington & Sims, simple, 400; General Electric, triple expansion, 1,000; Phoenix, triple expansion, 500, tandem compound and a simple, each of 250; Woodbury, tandem compound, 600 and one 375; Ide, tandem compound, 2 25 simple, 200; Ball & Wood, Cross compound, 200, two simple of 150 each, and tandem compound of 150-horse-power; Westinghouse, four compound, 1,000 each; Buckeye, triple expansion, 1,000; Atlas, compound, 1,000, McIntosh-Seymour, double tandem compound of 1,000, horse-power. Two Westinghouse compound follow of 1,000 each; one Buckeye cross-compound, 300, two simple, 125-horse-power each, a simple, 190 and a tandem compound, 150; one Russell, double tandem compound



MACHINERY HALL — THE LAST IN EXTERIOR COMPLETION.

horse-power; five of two Babcock & Wilcox, 3,000-horse-power; two of two each, Sterling boilers, 1,600-horse-power. All boilers will be fired with crude petroleum from the Standard Oil Company's tanks on the ground. The main header extends the length of the house and is thirty-six inches in diameter.

THE ENGINE EXHIBIT

will be also the greatest ever known, and will call for one quadruple expansion, ten triple expansion, thirty compound and thirteen simple engines. Twenty-five thousand horse-power will be required as follows: 13,000 for incandescent work; 4,200 for power generators for motor work; 4,600 for arc lighting, and from 3,000 to 5,000 for line shafting in Machinery Hall. They are to be arranged in blocks as follows:

E. P. Allis & Company will put in the quadruple expansion of 2,000-horse-power; Fraser & Chalmers will make the double triple expansion 1,000-horse-power machine;

500; Lane & Bodley, cross-compound and tandem compound, each of 300; Bass cross-compound, 224-horse-power; Atlas, tandem 500, and to close the list a Watertown double tandem compound, 250-horse-power, two Skinner, simple, of 150 each, two Westinghouse of 400, three smaller of the same make and an A. W. McEwen tandem compound condenser.

Besides these lists contracts have been made for additional power with the Harrisburg Foundry & Machine Works, Golden State & Miners' Iron Works, B. W. Payne & Son, Cooper, Roberts & Co., Skinner Engine Company, Hamilton-Corliss Company, Providence Steam Engine Company, Armington & Sims and with one foreign engine of English make.

The belting of the plant will be entered for exhibition. Five 72-inch belts will be supplied by Page-Jewell, Chas. A. Schieren & Company, of St. Louis, and Loden & Fayerweather. More belting is yet to be contracted.

EXHIBITS TO DATE.

IN THE TRANSPORTATION BUILDING.

THE street railway exhibit at the World's Fair will not be as extensive as many outside of the trade may expect. To those who understand that those manufacturers particularly and solely interested in street railway supplies prefer to meet solely and particularly street railway managers this will not be particularly surprising. "Your convention in Milwaukee," said Mr. W. A. Smith, chief of the transportation department, "will in a great measure curtail this exhibit in the Transportation Building. However, the following companies have applied for and have been allotted space in our department: Under the head of cars, Brill of Philadelphia, Stephenson of New York, the Lamokin Company of Chester, Pa., J. M. Jones' Sons of Troy, Brownell of St. Louis, the Snider Combination Company of Chicago, and Mehling of Cleveland, will exhibit. The Johnson Company of Johnstown, Pa., the Duplex Street Railway Track Company of New York, Wm. Wharton Jr. & Co. of Philadelphia, and the Porter Tramway Switch Company of Cleveland, will make particular exhibits, all except the Wharton Company being out of doors. The truck men will be represented by the McGuire Manufacturing Company of Chicago, the Peckham Motor, Truck and Wheel Company of Kingston, N. Y., the Taylor Electric Truck Company of Troy, and the Steel Motor Company of Cleveland. The Morton Car Heating Company will have a display, as will also the International Register Co., the Reliable Manufacturing Co., and the Standard Fireless (ammonia) Motor. G. W. Ludlow will exhibit an elevated electric railway system, as will J. L. Pope, W. D. Beach and Moser & Merckel. The Coburn Trolley Track Company, J. I. Cody and J. N. Volley, with other devices for traction, will be represented. Compressed air will be represented by the Nesson Manufacturing Company, the Smith Pneumatic Transfer and Storage Co., and the Jarvis Pneumatic Railway Co., R. A. Park, and the Rand Drill Co. J. P. Murray will show a car brake. The Otis Elevating Railway Company will show photographs of their Katskill Cable, illustrated by your magazine. Numerous manufacturers will exhibit in connection with other exhibits on the grounds; for instance, the American Car Company will show to advantage on the Barre Sliding railway, and Jackson & Sharp on the intramural. All specialties, such as these mentioned, the Movable Sidewalk, and a host of other means of transportation, are entered as exhibits although in working order. The Griffin Cushion Car Wheel Company; Baltimore, and other car wheels, fare registers, etc. The Standard Railway Equipment Company, stoves, have accepted space."

THE ELECTRICAL EXHIBITS,

superintended by John P. Barrett, chief of the department, and Dr. J. W. Hornsby, his assistant, will include many displays of interest to street railway men. The building itself is well adapted to the display and conven-

iently located north of the Administration and east of the Mining building. Electricity will have 243,000 square feet of ground floor and 95,000 square feet in the gallery devoted to its manufacturing and commercial interests. It is pleasing to note that all so-called electric belts and body-appliances have been denied room.

The building is well along towards completion, with two booths nearly ready for the Bell Telephone and the Western Union respectively.

The electric traction exhibit is to be complete, although the exact details of the installation cannot be given. The list of exhibitors and plat of the building published in several of the electrical journals is declared by Assistant Chief Hornsby to be both inaccurate and insufficient. The correct locations cannot be known until almost the opening day.

The present list as corrected for the STREET RAILWAY REVIEW by Mr. Hawley gives the following firms as making applications: Detroit Electric Works; C. & C. Motor Company; Sperry Electric Mining Machinery Company; Eddy Electric Company; Schieren Belting Company; Page Belting Company; the E. S. Greeley Company; New York Insulated Wire Company; Akron Electric Company; Washburn & Moen; American Storage Battery Company; Brush Electric Company, and Short Electric Railway Company; General Electric; Western Electric; Electrical Supply Company; A. C. Mather, and a number of spaces marked "apparatus" and "miscellaneous" will have their share of electrical supplies. The foreign exhibits, under the heads of Italy (two allotments) and Belgium (one space), have withdrawn their exhibits from this building. The allotment has been attended by many changes and readjustments, with more to follow, so that a complete, accurate and official list will not be possible for some time yet.

KILLED IN MILWAUKEE.

THE coroner of Milwaukee states that during the past year 234 deaths have been under his investigation, of these 165 were accidental. The railroads caused 40 of these, 28 were drowned, burned, 11; drowned in the cistern, 5; fell down and killed, 28; scalded, 7; suffocated by coal gas, 5; killed by street cars, 5. This needs no comment other than to call the deadly trolley crank's attention to the fact that scalding, falling down stairs, and drowning in cisterns is more fatal than the "juggernaut."

THE BROWNELL CAR COMPANY and its accelerator are household words in several cities now. Milwaukee and Detroit have large orders in, one to replace the big fire loss and the other to equip their new lines. The new management of the Atlantic Avenue Traction Company has ordered 50 cars for their lines. Daily newspapers in all the cities where the accelerator has been introduced are heartily pleased with the new style. The Cincinnati, Covington & Newport is one of the latest roads to introduce the car to the general satisfaction of populace and manager.

H. P. BRADFORD.

THE successor of H. Mitchell Littell in the superintendency of the Mt. Auburn Cable Line must needs be a man of ripe judgment, full experience and endless industry. To the end of finding in the field of street railway work such a man, the "available" were carefully canvassed, and the man chosen was found at Little Rock, Arkansas, in the person of H. P. Bradford, whose features are represented in the engraving on this page.

Mr. Bradford's present position is the logical result of years of painstaking, intelligent work in various branches of industry pertaining to street railway work and transportation in general.



H. P. BRADFORD.

H. P. Bradford was born July 29, 1858, at Memphis, Tenn., and after a short tuition in the public schools began active life as a messenger for the Western Union Telegraph Company. Afterward he branched out as a news agent and at the same time handled the team delivery of coal for the Memphis Coal Supply. Later, during the yellow fever epidemic of 1873, Mr. Bradford was given the entire charge of the coal fleets and yards of Hait & Lewis and Brown & Jones, two of the largest dealers in the city. After two years in this capacity Mr. Bradford went East in the steam railroad service, drifting South again in the employ of the Missouri Pacific as local freight and passenger agent at Little Rock. Resigning this office in 1885 Mr. Bradford began his street railway work by securing valuable franchises at Pine Bluffs, Arkansas, 42 miles south of Little Rock. Here he built and equipped a line 10 miles long, building and operating at the same time a steam freight elevator for loading and unloading the river steamboats of the Mississippi.

He also bought and improved the freight and passenger transfer lines at this place, filling in the gaps of time when he had nothing else to do by taking railroad contracts.

In 1890 the three lines at Little Rock, the City Electric Railway (steam), the Citizens' Street Railway (horse) and the Little Rock Street Railway (horse), found that something must be done to consolidate, and H. P. Bradford did the deed, combining all and electrifying it under the name of the City Electric Street Railway Company. Of this road he was made president and general manager, from which office he resigned to take his present position.

Mr. Bradford's enterprise and sagacity well fit him for a position in which a less capable man would feel ill at ease.

SEQUEL TO THE TOLEDO STRIKE.

LAST month we had occasion to mention the criminal acts of the striking linemen at Toledo, extending to both railway and telegraph lines. Since the article was printed some further developments have come to light.

It seems that while the strike was in progress and lines being cut, the Union held a meeting and denounced the persons who were committing the depredations, and volunteered their services to detect the guilty parties. When the companies took them at their word, and endeavored to secure a committee to patrol the lines, the strikers backed down. The companies, however, did not, and were successful in detecting several of the guilty parties. The case was laid before the grand jury, and the evidence was so clear an indictment was found against six men. Of these, five escaped service by leaving the city, and the other pleaded guilty and was allowed by the court to go on payment of a fine of twenty-five dollars. The lesson to the men should be a lasting one, as they certainly are very fortunate in that the companies seem willing to let the matter rest where it is. The action of the Union plainly shows the wire-cutting was not only known, but countenanced, if not actually ordered by the strikers' association, and places that body in a most undesirable position. The five strikers who ran away must have had some good reason for doing so, and their action admits of but one explanation. It is just such experiences as these that compel managers of companies to refuse to have anything to do with unions, which "tote fair" just so long as matters happen to suit them, and violate contracts and destroy property when the notion pleases.

THE TOLEDO, O., ELECTRIC LIGHT PLANT is to have the largest belt in regular use as soon as the Schultz Belt Company can fill the order. It is to be 80 inches wide and 100 feet long. The same company has orders for another 72-inch belt from the St. Louis & Suburban road.

J. P. KEMPER has returned from New Orleans to engage in electric construction work in Chicago.

CAUGHT ON THE RUSH TRIP.

American Street Railway Association.

D. F. LONGSTREET, PRESIDENT, Denver, Col.
 DR. A. EVERETT, FIRST VICE-PRESIDENT, Cleveland, O.
 JOEL HURT, SECOND VICE-PRESIDENT, Atlanta, Ga.
 W. WORTH BEAN, THIRD VICE-PRESIDENT, St. Joseph, Mich.
 WM. J. RICHARDSON, SECRETARY AND TREASURER, Brooklyn, N. Y.
 EXECUTIVE COMMITTEE THE PRESIDENT, VICE-PRESIDENTS, and JOHN G. HOLMES, PITTSBURGH, Pa.; J. D. CRIMMINS, New York City; THOS. MINARY, Louisville, Ky.; JAS. R. CHAPMAN, Grand Rapids, Mich., and BENJ. E. CHARLTON-HAMILTON, Ont.
 Next meeting, Exposition Building, Milwaukee, third Wednesday in October.

Massachusetts Street Railway Association.

PRESIDENT, CHARLES B. PRATT, Salem; VICE-PRESIDENTS, H. M. WHITNEY, Boston, AMOS E. BEEDL, LYNN, FRANK S. STEVENS; SECRETARY AND TREASURER, J. H. EATON, Lawrence.
 Meets first Wednesday of each month.

Ohio State Tramway Association.

PRESIDENT A. E. LANG, Toledo; VICE-PRESIDENT, W. J. KELLY, Columbus; SECRETARY AND TREASURER, J. B. HANNA, Cleveland; CHAIRMAN EXECUTIVE COMMITTEE, W. A. LYNCH, Canton, O.
 Meets at Cincinnati on the fourth Wednesday in September, 1893.

The Street Railway Association of the State of New Jersey.

PRESIDENT, JOHN H. BONN, Hoboken; VICE-PRESIDENT, THOS. C. BARE, Newark, SECRETARY AND TREASURER, CHARLES Y. BARNFORD, Trenton; EXECUTIVE COMMITTEE, OFFICERS and C. B. THURSTON, Jersey City; H. ROMAINE, Paterson; LEWIS PERLINE, J. B., Trenton.

The Street Railway Association of the State of New York.

C. DENSMORE WYMAN, PRESIDENT, New York.
 D. B. HASBROUCK, FIRST VICE-PRESIDENT, New York.
 JAS. A. POWERS, SECOND VICE-PRESIDENT, Glen Falls.
 W. J. RICHARDSON, SECRETARY AND TREASURER, Brooklyn.
 EXECUTIVE COMMITTEE.—D. F. LEWIS, Brooklyn; JOHN N. BECKLEY, Rochester, J. W. McNAMARA, Albany.
 The next meeting will be held at Rochester, September 19, 1893.

Pennsylvania Street Railway Association.

JOHN A. COYLE, PRESIDENT, Lancaster.
 JOHN G. BOLMES, VICE PRESIDENT, Pittsburg.
 H. R. RHODES, SECOND VICE-PRESIDENT, Williamsport.
 L. B. REIFSNIEDER, SECRETARY, Altoona.
 WM. H. LANIONS, TREASURER, York.
 Next meeting, Harrisburg, September 6, 1893.

Alabama.

MONTGOMERY, ALA.—Montgomery Terminal & Street Railway will equip with electricity. Bids for equipment called for.

Arizona.

PHOENIX, ARIZONA.—J. T. Dennis and F. L. Brill are pushing the survey of the Northern Addition Electric Railway.

YUMA, ARIZ.—Frank McMullen, of San Francisco, and Judge J. L. VanDerwerker have been granted a franchise here for an electric.

California.

GRASS VALLEY, CAL.—Peter Tautphaus and others, of San Francisco, make franchise from supervisors for line to Nevada City. Promoters will put men at work soon.

SAN FRANCISCO, CAL.—Col. J. W. Hartzell, manager of the San Francisco & San Mateo electric, is asking a franchise here.

OAKLAND, CAL.—The supervisors have granted the Consolidated Piedmont, rights for cable or electric on Piedmont avenue to Mountain View Cemetery.

OAKLAND, CAL.—The Highland Park Street Railway Company owed to submit to supervisors for electricity for horse power. East Oakland asks for new streets. Alameda, Oakland and Piedmont ask for new lines, electric.

PACIFIC GROVE, CAL.—The Pacific Grove Monterey, & Del Monte organized at \$250,000, by J. T. McCrosson, Wm. H. Chapman, Geo. W. Hopkins and M. W. Bell.

SANTA CRUZ, CAL.—Bonds have been issued by the Santa Cruz Electric Railway, amounting to \$280,000 and by the S. C. Electric Light & Power Company of \$200,000. The city bank is fiduciary agent. These securities are considered good here.

SAN JOSE, CAL.—Ordinance under way giving J. W. Morton, J. F. Parkinson rights for cable, electricity or horse.

SANTA ROSA, CAL.—Organized: Union Street Railway Company Santa Rosa, Sonoma County. Capital stock, \$50,000. Directors, B. Spencer, H. G. Habmann, G. E. Grosse, L. Burbank, B. Hottinger, J. S. Taylor and C. F. Juilliard

Canada

HAMILTON, ONT.—The Street Railway will extend in spring. J. B. Griffiths has gone to England to buy rail.

TORONTO, CAN.—A. W. Dingman, of the Toronto and Scarboro Electric Railway Light & Power Company, asks rights to enter city via the Don railway allowance.

WINDSOR, ONT.—W. Ryckman has bought the Sandwich, Windsor & Amherst for \$155,000, closing up their option. Extensions will be made in the spring.

WINDSOR, ONT.—The franchise on Ouelette avenue is bought by J. S. Visger of Detroit, for \$2,100.

Chicago.

CHICAGO.—Calumet Electric gave mortgages to the Jennings Trust Company for \$1,250,000. Loan made in 6 per cent gold bonds.

CHICAGO.—Incorporated: The Englewood & Chicago Street Railway Company. The capital stock is \$1,000,000. The incorporators and first board of directors are James P. Mallette, David D. Chidester, George C. Lazear, Wm. H. Comstock and F. W. Pringle, all of this city.

THE West Chicago Railway Company has increased its stock from \$10,000,000 to \$20,000,000. The North Chicago increased from five to ten millions.

Colorado.

BRIGHTON, COL.—Platte Valley Electric Railway Company has a clear right of way. Hon. D. F. Carmichael is prime mover.

BRIGHTON, COL.—The electric from here to Denver is agitating the public mind, and a general petition has gone before the County Commissioners of Arapahoe county asking rights for 20 years for such road.

COLORADO SPRINGS, COL.—A twenty-five mile electric road, backed by eastern capitalists, will be built to Cripple Creek. J. H. Jewett, of Green Mountain Falls, Frank Earle, of Colorado Springs, and C. B. Wilder, of Colorado City, are also interested.

OURAY, COL.—The Mayfield Coal Mine, Toll Road & Electric Railway Company is incorporated to operate in Ouray county; capital stock, \$100,000; incorporators, F. N. Mayfield, Wm. Hory, F. Hochull, A. Humphrey and C. W. Haskins.

PUEBLO, COL.—H. E. Chubbuck, of Omaha, is manager of the railway, vice J. B. Downey. W. M. Martin is superintendent. A large amount is to be used in betterments.

PUEBLO, COL.—H. E. Chubbuck, of Omaha, agent General Electric, has brought several experienced electric railway men here, Geo. Martin, of Chicago, and Wm. Martin, of Omaha. Improvements are to be made and extensions built.

Connecticut.

GRISWOLD, CONN.—A. A. Young, of Griswold, Windham county, asks for electric rights.

Florida.

TAMPA, FLA.—President Ahern, of the Street Railway, says the Westinghouse system is to be used, and the line to be operated March 1.

Georgia.

SAVANNAH, GA.—The People's Electric Light & Power Company gets control of the ten miles of electric road now operating and of three miles now in construction. The Savannah Electric Company has sold out for \$125,000. The People's Company will expend about \$200,000 in a lighting plant, in addition to the power plant, new cars, extension of road, etc. J. S. Collins is president of the company, W. J. Lindsay, vice-president, and T. G. Reid, secretary and treasurer.

Illinois.

ALTON, ILL.—The Alton Electric Street Railway Company, Alton; capital stock, \$250,000; incorporators, Manning Mayfield, Henry G. McPike and John F. McGinnis.

DUNDEE, ILL.—Incorporated: The Dundee Rapid Transit Company, Dundee; to operate a street railway; capital stock \$50,000. Edgar C. Hawley, G. Frank Oatman and William Fay.

DUNDEE, ILL.—The Dundee Rapid Transit Company will add 100 and 150-horse-power engines and two 100-horse-power generators to the electric light plant for railway service. A three-rail system to be used. William Fay, Elgin, is the authority.

EAST ST. LOUIS, ILL.—The East St. Louis Belt Suburban Dummy Electric Railroad; capital stock, \$500,000. Incorporators, Louis Gross, John W. Renshaw, James P. Slade, M. F. Geary, Henry Voss and W. H. Bennett.

EAST ST. LOUIS, ILL.—The East St. Louis Electric & Dummy Company; capital stock, \$500,000; incorporators, James P. Slade, William H. Bennett, John P. Renshaw, Michael F. Geary, Henry Voss and Louis Gross; to construct an electric and connect the towns of Madison, East Carondelet and other villages in the vicinity.

ELGIN, ILL.—The right-of-way of the Elgin, Aurora & Fox River Electric is progressing finely.

FREEPORT, ILL.—Stockholders agree to ask Secretary W. G. Barnes to get bids on electric equipment for Freeport. Heavy backing promised for electricity.

PEKIN, ILL.—W. L. Prettyman, of this city, and Mr. Demange, of Bloomington, represent parties who desire to connect this place with Peoria by an electric line via Hollis and Bartonville. Franchise pending.

PONTIAC, ILL.—J. E. Monroe, R. M. John, et al., organize the Pontiac Street Railway Company; \$100,000 capital stock.

ROCKFORD, ILL.—West End road is to be extended.

Indiana.

BRAZIL, IND.—N. Bails, of Rockford, Ill., and A. Van Ginkle will begin work on a \$50,000 plant.

FT. WAYNE, IND.—J. W. Hayden and W. S. O'Rourke are getting capital for an electric line to New Haven, same county. Principals claim that capital is coming in.

HAMMOND, IND.—Wm. H. Fitzgerald, C. E. Loss, Chicago, et al., are organized as the Hammond Electric & Street Railway Company to acquire railway rights, and companies already organized at Hammond and in the vicinity.

INDIANAPOLIS, IND.—The Citizens' Street Railway will build a line on Virginia avenue as soon as spring opens, also one on Indiana avenue.

LOGANSPOBT, IND.—Manager J. T. McNary and Architect Rhodes are preparing plans for a power house, 38 by 165; new boilers, engines and dynamos. This power is for intended extensions.

MARION, IND.—The Marion Street Railway has been granted franchise to Gas City, to be completed July 15. Probably the beginning of a system of transferring lines for the entire gas field.

MARION, IND.—Carroll and Brownlee are attorneys for the Marion Street Railway Company, and Lou Wallace, Jr., of Indianapolis, and Judge St. John, of Marion, are attorneys for the Delafield Construction Company, in the franchise fight.

MICHIGAN CITY, IND.—Lew Wallace, Jr., of New York, and Jas. S. Devor, of Indianapolis, are here to push work on the Lake Cities Electric.

TERRA HAUTE, IND.—I. T. Dyer, president Chicago, Grand City & Terre Haute Railway Company, is in the city making arrangements for the new road incorporated in Illinois. Incorporators are W. B. Bass, C. I. Shomberg, A. S. McDonald, H. G. Leed, C. D. Hyndman, all of Chicago. Road electric.

Iowa.

COUNCIL BLUFFS, IA.—The Courtland Beach Association is granted right to build a street railway and bridge over Cut-off Lake. W. D. Lawrence, mayor, A. J. Stephenson, city clerk.

DAVENPORT, IA.—Vice-president Lardner and Superintendent Schnitzer recommended \$30,000 improvements and extensions. It will probably be granted. D. H. Louderbeck, Chicago, president of the Davenport lines.

DES MOINES, IA.—The City Railway will erect at once a \$25,000 waiting room and depot.

DUBUQUE, IA.—March 1 is the date set by Judge Shiras for selling the Allen & Swiney lines. Major D. C. Cram is appointed master of sale, which will be at 10 a. m., at the court house. Curtis and Matley, Boston, are said to be likely purchasers, with a prospect of expending \$50,000 in new equipment and machinery.

DUBUQUE, IA.—Judge Shiras has ordered the receiver to sell the Allen & Swiney Electric Railway & Light Company. Liabilities, \$400,000.

SIoux CITY, IA.—A. M. Coffman, the local representative of the Chicago syndicate, headed by J. Francis Lee, that recently purchased the Riverside Park property and electric line here for \$600,000, has purchased the Sioux City & Leeds Electric Line, running from this city to Leeds. It is thought he represents the Chicago syndicate in this matter. This would give the company twelve miles of electric line passing through the center of the city. Coffman is now in Chicago.

SIoux CITY, IOWA.—Sioux City & Leeds Railway has been sold to J. Francis Lee, of Chicago, who is supposed to represent the Canadian Pacific.

Kansas.

ATCHISON, KAN.—Dr. L. W. Challiss, president of the Atchison Street Railway Company files deeds and mortgages to cover \$135,060 indebtedness.

TOPEKA, KAN.—The Chicago, Topeka Light, Heat & Power Company is to build a new dam over the Kaw river. It will be for general power business. J. B. Bartholemew represents the company. The Citizens' Committee is P. S. Noel, J. B. McAfee, S. T. Howe, T. J. Kellam, T. E. Bowman, et al.

WICHITA, KAN.—The Wichita Electric Railway has been sold by the sheriff under a mortgage of \$300,000, and was bought in by the bondholders, capitalists of Boston and Keene and Nashua, N. H. There will be a reorganization, but the management will remain in the same hands.

Kentucky.

COVINGTON, KY.—J. J. Shipherd, of Cleveland, says the company will spend \$1,500,000 on the Covington-Newport road with 3,000-horse-power at Newport.

LOUISVILLE, KY.—Ben B. Gilman, for a long time superintendent of the Louisville City Railway, has accepted the superintendence of the New Orleans Consolidation.

Louisiana.

BATON ROUGE, LA.—The council has granted additional streets to the electric railway. Councilmen Powers, Weis and Stewart are committee on police fire alarms.

NEW ORLEANS, LA.—Maurice J. Hart, for Judah Hart, has bought the 50 years' extension of the Crescent City franchise for \$25,000.

Maine.

AUBURN, ME.—J. R. Learned, B. F. Biggs, H. Wesley Hutchins, Ara Cushman and George G. Gifford are a committee to push the electric railway scheme between Mechanic Falls and Turner.

NEW CASTLE, ME.—The Pemiquid, Damariscotta & New Castle Street Railway is incorporated by W. E. Lewis, W. S. Bromer, W. S. Fuller, Geo. W. Ellis, Eugene Sproul, Augustus Fossett, Arad Fossett, H. M. Heath, O. A. Mill, H. H. Chambelain, F. H. Boynton, J. E. Nichols, and W. F. Sawyer. Some of these presumably of Lewiston. Capital, \$300,000; horse or electricity.

Maryland.

CUMBERLAND, MD.—The Lonaconing & Cumberland Railway and Power Company incorporated at \$250,000. The incorporators are Geo. W. Clark and J. J. Bell, of Lonaconing, Jas. B. Stewart and Frank V. L. Turner, of Washington, D. C., and Wm. Pearre, of Cumberland. Road to connect Barton, Phoenix and Franklin.

Massachusetts.

ATHOL, MASS.—W. W. Kimball, president Fourth National Bank Boston; N. J. Rust, president Lincoln National Bank, N. Sumner Myrick, vice-president of the Middlesex Trust Company, file petition for franchise for electric with stock at \$100,000. Citizens not asked to subscribe, Figures show that traffic to Orange is heavy enough to warrant the road. It is said S. H. Barrett may also apply for franchise. J. Granville Young, Jr., manufacturer of Bents water crackers, is interested in the first named franchise.

BOSTON, MASS.—Hon. E. P. Shaw and J. F. Shaw, his son, have formed a partnership under the name J. F. Shaw & Co., to do business at 1026 Exchange Building, Boston, as dealers in street railway securities, stocks and bonds.

GLOUCESTER, MASS.—The Rockport Street Railway Company is organized by David S. Presson, A. R. Hallowell, Gloucester; Henri N. Woods, Summer D. York, Rockport; W. B. Ferguson, Malden; Albert D. Bosson, Chelsea; Edward P. Shaw, Newburyport, et al.

HOLYOKE, MASS.—The Springfield Street Railway Company has elected officers and appointed a committee to consummate arrangements for interurban extensions. The Springfield and Holyoke roads will then consolidate.

MILLBURY, MASS.—C. D. Morse has let contracts for building his new car factory. There is \$150,000 reported back of the enterprise.

NEWTON, MASS.—The Newton & Brighton Street Railway Company will apply for charter. Capital, \$100,000; length, 5 miles. The Wellesley & Boston road, \$100,000, will unite with the above. The present owners of the Newton Street Railway Company are at the back of the scheme.

NEWTON, MASS.—H. B. Parker, George W. Morse, Frederick Johnson and others are the directors of a new electric road, to be built between Wellesbury and the Brighton terminus of the West End.

NEW BEDFORD, MASS.—Citizens of the Bedford and Dartmouth have signed articles of agreement to build a railway between these towns to be called the New Bedford & Padanaram Railway. Capital, \$60,000.

NEW BEDFORD.—The Union Street Railway Company will entirely rebuild its lines in the spring.

NEW BEDFORD, MASS.—Abbott P. Smith, of this place, representing J. O. Wardell, of Boston, and A. E. Perry, of New Bedford, has petition for the New Bedford and Fall River line before council; guarantee construction.

NORTHAMPTON, MASS.—J. C. Hammond, of the horse railroad, files petition for extension to Bay State, Leeds and other points. Outside parties are trying to buy and electrify the road. The present company will probably electrify.

SPRINGFIELD, MASS.—G. Hodges and Wm. Damon, of Boston, have had consultation with President Olmsted, with the result that the railway will build its own power house in the spring. This work will require 1500-horse-power steam plant and four dynamos. Track extensions on several lines will be made.

WORCESTER, MASS.—The gigantic combination of all the city and suburban roads including Marlboro, Spencer, Leicester, Grafton, Sutton, Auburn, Webster, Rockdale and others, to the amount of twenty-six, asks for forty-four miles of new right of way. The combination will be known as the Central Massachusetts Traction Company. Marlboro, Northbridge and Webster will be termini and power stations. Building will begin early in the spring. Samuel Winslow, of the Worcester, Spencer & Leicester; T. T. Robinson, of Dedham; W. B. Ferguson, of Malden, are interested.

Michigan.

DETROIT, MICH.—The E. W. Cottrell franchise has been granted.

DETROIT, MICH.—The Suburban Street Railway Company has abandoned its franchise on Gratiot avenue.

DETROIT, MICH.—The Highland Park council gave a franchise to J. W. Sincock and Charles Wright, of Detroit, any motive power and 18 months' limit to build and equip.

GRAND RAPIDS, MICH.—F. W. Stephens is making survey of route for the Percy T. Cook line. It is said E. Crofton Fox and Chas. Fox are with Cook in the deal.

GRAND RAPIDS, MICH.—The Consolidated asks franchises on Fifth avenue and other streets.

MT. CLEMENS, MICH.—Mathew Slush, owner of the street railway line, wants more streets for extension and equipment with electricity. Will probably be allowed.

SAGINAW, MICH.—The Saginaw Street Railway intends expending \$100,000 in electric equipment in the early summer.

Minnesota.

DULUTH, MINN.—Reported that the Phoenix Electric Company is to buy out the Peoria Electric Company and Manufacture supplies.

Mississippi.

NATCHEZ, MISS.—City council authorizes company to equip with electricity. Address Natchez Street Railroad Company; Abe Moses, secretary, Maurice Moses, president.

Missouri.

JOPLIN, MO.—The Joplin Electric Railway & Motor Company contemplate extensive improvements in the spring.

PLATTE CITY, MO.—Henry A. Koster, A. D. Burnes, F. Burnes sign bond to carry out conditions of franchise between Platte City and Tracy. Six months' limit of time; double track. Town of Platte, Soo.

KANSAS CITY, MO.—The Metropolitan elected following directors: C. F. Morse, Geo. F. Nettleton, Wallace Pratt and S. B. Armour, of Kansas City, and Charles E. Cotling, N. H. Emmons and T. J. Coolidge, Jr., of Boston. The new loop will in all probability be built.

ST. LOUIS, Mo.—Incorporated: St. Louis & Kirkwood Rapid Transit Company; capital stock, \$10,000. Incorporators: Edward P. Dickson, of Glendale, George M. Keeley, Henry Sylvester and George M. Voeleker, of St. Louis.

ST. LOUIS, Mo.—Plans of the Baden-St. Louis line which has been absorbed by the Broadway system, are ready.

ST. LOUIS, Mo.—St. Louis & Kirkwood, Ed. P. Dickson, G. M. Keeley, H. Sylvester and George Voelker, incorporators, proposes to accept its franchise and issue first mortgage bonds in sum of \$200,000 to assist in building this road.

ST. LOUIS, Mo.—The Cass Avenue & Fair Grounds Railway Company has taken out a permit for a \$15,000 power-house 100x155 feet on the east side of Prairie avenue, at North Market and Lincoln streets. R. W. Morrison, contractor.

ST. LOUIS, Mo.—John Scullin will probably build a new line to Jefferson Barracks.

ST. LOUIS, Mo.—Incorporated: Southern Electric Railway Company. The incorporators are Tom L. Johnson, of Cleveland, O., 9,970 shares of preferred stock and 4,885 shares of common stock; J. Clifford Richardson, twenty-four preferred and twelve common; Edward S. Lovejoy, two preferred and one common; Hugo Muench, two preferred and one common. Attorney, Judge Luebke; stock, \$1,500,000.

THE Fourth street and Arsenal road asks extensions; single track.

THE Missouri System asks extensions on Forest Park and Laclede avenue and Fourth street

THE Lindell asks for several franchises. One on Taylor avenue is the longest.

Nebraska.

OMAHA, NEB.—Omaha Railway, Bridge & Terminal Company propose a new electric in South Omaha, and have bought a tract of land for \$300,000 for town lots.

New Hampshire.

CONCORD, N. H.—Adverse action of the legislature does not discourage the Merrimac Valley electric promoters. The Messabeaic road asks extensions and can probably supply the missing link of right of way. Steam roads fight the scheme.

New Jersey.

ASBURY PARK, N. J.—The Asbury Park & Belmar Street Railway Company incorporated at \$75,000 by Nelson E. Buchanon, Township Collector John Hubbard, Assessor L. E. Watson, John Rockafeller, treasurer of the Electric Light Company; Henry C. Winsor, president of Asbury Park and Ocean Grove Bank; George Potts, a railroad contractor, and Chas. McDermott, a real estate agent of Belmar.

HOBOKEN, N. J.—The Passaic, Rutherford & Carlstadt Railway Company has been incorporated at \$300,000; J. A. Morrissey, F. C. Van Dyk, J. R. Lee, of Paterson; J. V. Morrisse, of Passaic, and Raymond C. Johnson and C. H. Russell, of Brooklyn, N. Y., are the incorporators.

IN connection with this road the Jersey City, Hoboken & Rutherford Electric Railway is incorporated at \$300,000 to run 999 years, by Thos. D. Jordan, Passaic, Chas. H. Russell and Chas. A. Johnson, of Brooklyn, W. N. Ince, F. K. Irving, O. H. Lohsen, et al., of Jersey City; C. A. Currie, Brooklyn, H. P. Hyde and Louis Fitzgerald, both of New York, are large holders.

PATERSON, N. J.—John R. Lee, A. A. VanVoorhies, A. H. Post, et al, this city, will build a line on Grand street as a loop for the Central Electric Railway.

WOODBURY, N. J.—The Woodbury Electric Railroad & Power Company organized. Capital, \$150,000. W. H. Livermore, president; Dr. H. H. Clark, secretary; Dr. McGeorge, treasurer.

ORANGE, N. J.—A. Z. Mason, of Boston, George Spottiswoode, Charles A. Lindsley, F. W. Child, A. W. Kissam, James S. Holmes and Stephen D. Day incorporate the Orange Valley Street Railroad to build one mile electric to connect the Highland avenue depot of the Lackawanna road with the Orange Mountain Cable. Capital, \$10,000.

New York.

BROOKLYN, N. Y.—The Lewis & Fowler Manufacturing Company has elected for 1893, Albert H. Dollard, president; D. F. Lewis, treasurer; Geo. W. Myers, secretary.

BROOKLYN, N. Y.—President Lewis says the Long Island Traction Company, which has gained the Brooklyn City, is not the company acquiring the Atlantic Avenue line. The new company guarantees 10 per cent to owners of B. C. stock and will have to earn interest on \$42,000,000 stock. He says there is no change in the management.

BROOKLYN, N. Y.—Organized: The Twenty-third Street Ferry & Newton Railroad; six miles long; capital stock, \$750,000; directors are Moses May, John G. Jenkins, Peter Wyckoff, John J. Cooney, H. B. Scharman, Theodore F. Jackson, John E. Van Nostrand, Frank Jenkins, and Marshall S. Driggs.

BUFFALO, N. Y.—The Buffalo & Tonawanda Electric Railway organized at \$100,000. The directors for the first year are Frederick Swift and Wendell Goodwin, New York; G. H. Wirth, Brooklyn; W. P. Whitlock, Elizabeth, N. J.; L. P. Mey, New York; Francis Gilbert, East Orange, N. J.; the Hon. W. Caryl Ely and Frank A. Dudley Niagara Falls, and Charles A. Leh, New York. The road is heavily backed and will be twenty-eight miles long.

BUFFALO, N. Y.—Chairman Louis F. W. Arend and Secretary L. L. Grove have filed a certificate of an increase to \$75,000 in capital stock of the Buffalo & Williamsville Electric Railway Company.

PEEKSKILL, N. Y.—The Peekskill Surface Railroad Company ask for electric rights. The franchise has been granted for horse line.

SCHENECTADY, N. Y.—The Schenectady Street Railway Company has applied for extension rights.

STILLWATER, N. Y.—The Stillwater & Mechanicsville horse railway are seeking authority to change to electricity with hopes to have line completed May 1st.

SYRACUSE, N. Y.—W. R. Kimball, of Cincinnati, and W. P. Gannon, of Syracuse, are new directors of the Syndicate lines. No changes in direct management will be made at present.

WAVERLY, N. Y.—The Susquehanna Valley Traction Company has been organized at \$20,000, to build in Tioga county. The directors are Almet N. Broadhead, Chas. McDow, Sheldon B. Broadhead, William Broadhead, Orisino E. Jones, Jamestown; F. M. Stephens, Sayre; W. L. Watrous, and Michael Quigley, Waverly.

Ohio.

AKRON, O.—H. A. Robinson, H. J. Stambaugh, Cyrus Bailey, E. M. Buel and Alfred Akers are incorporated to build an electric line 27 miles long from Barberton to Ravenna.

AKRON, O.—The Peoples' Electric Company, H. A. Robinson, H. J. Stambaugh, Cyrus Bailey, E. M. Buel, et al, at \$25,000, have taken steps to locate and equip their power houses and lines.

CANTON, OHIO.—The Canton-Massillon electric railway is about to build lines to Louisville, Navarre, New Berlin and Osnaburg, and representatives of the company are soliciting for right of way. The Canton-Massillon line has succeeded beyond expectation, and this leads to the contemplated extensions.

CINCINNATI, O.—This new Fairmont road has opened for business. John H. Kilgour, president.

COLUMBUS, O.—The Columbus & Harrisburg Electric Railway has been incorporated by J. M. Briggs, A. G. Grant, G. D. Martin, J. S. Young, J. H. Chenoweth, Levi Hite and G. M. Stark; capital, \$1,500; light and power.

HUBBARD, O.—An electric street railroad from Hubbard to Youngstown would be a good paying piece of property. Capitalists who have money to invest should investigate.

DAYTON, OHIO.—Judge Dwyer and O. B. Brown, et al., are working up a new line for this city and suburbs.

KENT, O.—W. H. Davis, M. G. Garrison, N. J. A. Minnich, C. L. Howard, E. E. France and F. L. Allen ask for right for an electric Belt Line.

TOLEDO, O.—The Robinson lines will institute light, heat and power renting on a considerable scale.

TROY, O.—E. H. McKnight, a Troy man, has been given the franchise here.

Oregon.

SALEM, ORE.—Salem Consolidated, articles of incorporation filed by G. B. Markle, S. Z. Michell and E. P. McCornac, at \$500,000. The new organization does not take in the Salem Motor Company. Five new branches are contemplated and the company is a solid one.

PORTLAND, ORE.—Business men on First street are subscribing money to buy the horse line there in order to electrify it. Chas. Hegele, Dayton & Hall, Oregon Furniture Company, et al., are signers of the agreements.

PORTLAND, ORE.—The Portland & Vancouver railway is to be electrified within six months. The company is seeking to secure a franchise for a double track on Union avenue to Hawthorne avenue. The cars have been ordered.

Pennsylvania.

ALLENTOWN, PA.—Allentown & Bethlehem road votes increase of debt to \$700,000 and stock to \$1,400,000.

ASHLAND, PA.—Organized: Ashland, Locust Dale & Centralia Electric Railroad. Officers, Joshua F. Bailey, Philadelphia, president; directors, C. E. Winter, Springfield, J. H. Cofrode, F. E. Bailey, both of Philadelphia.

BEDFORD, PA.—Congressman John B. Robinson, of Media; Congressman W. A. Stone, Senator John Neeb and James B. Oliver, of Pittsburg, S. R. Longnecker, Geo. M. Harris and John S. Wells, of Bedford, have gained their franchise here after hard fight. Road two and one-half miles long.

DOYLESTOWN, PA.—John Schwartz, of Perkasie, A. T. Meyers, of Bloomington, John Yardsley, of Doylestown, et al, are inspecting electric roads with a view of using electricity on the proposed road from Perkasie to Doylestown.

HARRISBURG, PA.—The Lancaster & Middletown Electric Railway incorporated by Luther S. Bent, J. Q. Denny, John A. Cayle, et al. Capital stock, \$500,000.

JENKINTOWN, PA.—Organized: The Jenkintown Electric Railway Company; capital, \$150,000; by Seth W. Wilson, John W. Henderson William S. Watson, Joseph W. Tilton and Oscar H. Weidman.

LANCASTER, PA.—An electric is chartered to build to Reading, thirty miles, passing through Oregon, Farmersville and other towns. Capital, \$600,000; John A. Coyle, this city, is a leading promoter.

LANCASTER, PA.—Chartered, the Lancaster & Marietta Street Railway, capital, \$90,000.

LANCASTER, PA.—Lancaster & Philadelphia incorporated at \$1,500,000. Ex-Senator J. D. Patterson, of Millintown, projector.

LANCASTER, PA.—Chartered: The Lancaster & Terre Hill Street Railway Company, the line of which will run from Lancaster to the villages of Oregon, Brownstown, Farmersville and Martindale. Capital, \$200,000.

LUCERNE, PA.—Organized: The Luzerne & Carbon Electric; capitalized at \$50,000. John F. Finney, president; O. A. Keim, secretary; S. W. Yost, treasurer; John Grant, R. J. Yost and H. C. Boyer, incorporators. Capital to build the road has already been assured.

MAHANOEY CITY, PA.—Chartered: Lakindi Street Railway Company, of Mahanoe City; capital, \$50,000.

LANCASTER, PA.—John A. Coyle has incorporated the Lancaster & Manheim Railway at \$250,000.

MARIETTA, PA.—The Marietta and Maytown ordinance will be passed, out the company must run cars in three months. Hon. William B. Givin attorney for the company.

NORRISTOWN, PA.—The Royersford town council has been asked for electric light and railway rights by L. K. Perot, of the Schuylkill Valley Electric Company. The Phoenixville council has granted light privileges and has railway rights under consideration.

NORTHUMBERLAND, PA.—Granted charter, the Northumberland & Allentown Street Railway; capital, \$180,000.

OLYPHANT, PA.—The Olyphant & Winton Traction Company has been chartered to build a line six miles long. The directors are Joseph A. Dolphin, Olyphant; Julius Moses, Carbondale; Thos. Grier, Dickson City; John N. Lillibridge, Blakley, and Richard J. Gallagher, Olyphant. Capital, \$36,000.

PHILADELPHIA, PA.—The West Girard Avenue Passenger Railway Company, of Philadelphia, capital \$24,000, and the Erie Avenue Railway Company, Philadelphia, capital \$52,000, has been granted charters at the State Department.

PHILADELPHIA, PA.—The Fifth & Sixth Streets Passenger Railway Company applies for trolley rights to Frankfort, throwing the dummy line out.

PITTSBURG, PA.—The Highland Park & Morningside Railway Company has been given right of way by select council.

PITTSBURG, PA.—The Charleroi, Monongahela City and West Brownsville Electric Company organized at \$700,000. The road will be partly new lines and partly consolidation, and will be 58 miles long. Local capitalists are in the deal and Jesse Y. Ruggles, of West Virginia

READING, PA.—An electric road will be built from Terre Hill to Mohnsville. Supposed to be controlled by the Reading & Southwestern Railroad in the hands of Philadelphia men. Capital \$600,000.

READING, PA.—Mayor Merritt has signed the franchise giving permission for the Reading City Passenger Railway to operate 20 miles of trolley. Change will cost \$400,000.

SCRANTON, PA.—Chartered: The Scranton Rapid Transit Company; capital, \$60,000, and directors, P. J. Horan, A. Frothingham, M. J. Wightman, A. L. Johnson, and E. G. Wightman.

SCRANTON, PA.—The Traction Company has purchased for \$15,000 the "Boulevard," the principal driveway to Carbondale, and will build an electric thereon.

WESTCHESTER, PA.—The trolley ordinance which has been pending two years has been passed.

WOODBURY, PA.—The Woodbury & Camden Electric is organized. The capital stock has been placed at \$150,000, part of which has been subscribed, and the officers are W. H. Livermore, president; Dr. H. H. Clark, secretary; Dr. Wallace McGeorge, treasurer, and James Sickler, solicitor.

Tennessee.

CHATTANOOGA, TENN.—Herbert C. Hulse and President Divine, of the street railway, plan a short line to the National Cemetery; an 820-foot bridge is contemplated and the road runs to Highland Park.

Texas.

DALLAS, TEX.—Franchise given to A. W. Childress and associates to construct, operate and maintain an electric street railway. About 15 miles of street railway will be built before July 1. The Thomson-Houston are said to be people behind the enterprise.

SAN ANTONIO, TEX.—The Alamo Railway has been granted parallel rights with the San Antonio line.

TYLER, TEX.—The road here has voted to put in electricity and has the capital back of it to do so.

SAN ANTONIO, TEX.—Council has granted four new routes to the Alamo Electric.

TYLER, TEX.—Major J. P. Douglass is in Kansas City making arrangements for the electric road. Council votes to buy for 50 additional street lights.

WACO, TEX.—Bill granting Waco Water Power & Electric Company is before legislature. James I. More is interested.

Utah.

SALT LAKE CITY, UTAH.—The S. L. City Railway has authorized an issue of bonds not exceeding \$1,500,000, of which \$650,000 are to be issued immediately. Trust deed to N. Y. Guaranty & Indemnity Association and Rollins & Sons, New York, will place the bonds.

Vermont.

BELLOWS FALLS, VT.—The charter of the contemplated electric railway between Bellows Falls and Saxtons River has been disposed of to Boston capitalists, they guaranteeing that the road shall be built within two years.

BRATTLEBORO, VT.—New road organizes. S. H. Herrick, president; E. C. Crosby, vice; S. H. Barrett, 182 No. Main street, Springfield, Mass., secretary.

BURLINGTON, VT.—Jos. A. Powers, of Lansburg, N. Y., has bought controlling interest in the Winooski & Burlington Horse Railway and will equip with electricity. Possibility of water power.

Washington.

OLYMPIA, WASH.—The North West General Electric has contract for the West Side Railway Company's new line. Extensions are contemplated.

SEATTLE, WASH.—The Consolidated elects an entirely new board, with exception of V. Hugo Smith, who remains. New officers are: President, F. T. Blunck; vice-president, Jacob Furth; secretary, V. Hugo Smith; treasurer, R. R. Spencer; auditor, A. Dunn; general superintendent, C. S. Clark. The office of general manager has been abolished. Mr. Blunck, the new president, is a wealthy capitalist of Davenport, Ia., and the largest individual stockholder in the company.

SPOKANE, WASH.—A. A. Newberry is in the East to place \$250,000 in bonds for the Cour d'Alene Electric.

SPOKANE, WASH.—The Liberty Park Electric, and John I. Booge, a real estate man, are to make a new settlement. The syndicate is wealthy, and the railway will be a five-mile line of the best construction.

TACOMA, WASH.—E. E. Bair, P. Metzler and S. B. Feder have incorporated the Ocosta, Westport, North Cove & Toke Point Railway and Motor Company. They say the subsidy of \$50,000 will be soon granted and work begun. Steam motors at first to be used and then electricity.

Wisconsin.

BELOIT, WIS.—C. H. Morse, Chicago, has bought out the Williams Engine and Eclipse Clutch Works of M. H. Wheeler.

FOND DU LAC, WIS.—Incorporated: Fond du Lac Light, Power & Railway Company; capital stock, \$100,000.

JANESVILLE, WIS.—Geo. W. Blabou, of Philadelphia, has bought the railway. W. R. Proudfoot remains as superintendent. Guard wires and iron poles to be bought; also additional cars.

SPARTA, WIS.—J. B. Canterbury, of LaCrosse, asks franchise here.

SUPERIOR, WIS.—Organized: The Belt Line Electric Company, of Superior, capital \$600,000; incorporators, R. C. Pope, G. R. Smith and W. B. Perry.

THE CARS WERE 'TENDING A FUNERAL.

THERE'S a town in California that has a street car line with three cars. The transportation facilities are rather limited and the sad-eyed mules are a little slow. A stranger alighting from a railroad train one day waited in grim silence for the vehicle, the advent of which seemed assured by the well scoured tracks. After a while he turned to a native and said:—

"Where's the cars in this bloody town?"

"Yez'll get no car the day," said the native.

"Why ain't they running?"

"Faith they'll be running, but the're all at th' funeral, yez see, sor, the line runs to the cimitery and the mourners like 'em because they is more handy than kerriges."

In this same happy town the president of the road takes one of the cars while the men eat their dinner.

THE vice-president of the Eighth avenue railway company of New York city, denies the rumor of consolidation with the Metropolitan traction company.

AMONG the half-dozen cities in the United States that claim the first electric car is Hornellsville, N. Y. Their claim is that Dr. J. H. Lillie, of that place, ran an electric traction motor on a twelve-foot track as early as 1846. In 1850 the doctor patented his car and constructed one for P. T. Barnum.

Abraham Lincoln

When leaving his home at Springfield, Ill., to be inaugurated President of the United States, made a farewell address to his old friends and neighbors, in which he said, "NEIGHBORS GIVE YOUR BOYS A CHANCE."

These words come with as much force to day as they did thirty years ago.

How give them this chance?

Up in the Northwest is a great empire waiting for young, and sturdy fellows to come and develop it and "grow up with the country." All over this land are the young fellows, the boys that Lincoln referred to seeking to better their condition and get on in life.

Here is their chance!

The country referred to lies along the Northern Pacific R. R. Here you can find almost anything you want. In Minnesota and in the Red River Valley of North Dakota, the finest of prairie lands fitted for wheat and grain, or as well as for diversified farming. In Western North Dakota, and Montana, are stock ranges limitless in extent, clothed with the most nutritious of grasses.

If a fruit farming region is wanted there is the whole State of Washington to select from.

As for scenic delights the Northern Pacific Railroad passes through a country unparalleled. In crossing the Rocky, Bitter Root, and Cascade Mountains, the greatest mountain scenery to be seen in the United States from car windows is to be found. The wonderful bad lands, wonderful in graceful form and glowing color, are a poem. Lakes Pend d'Oreille and Cour d'Alene, are alone worth a trans-continental trip, while they are the fisherman's Ultima Thule. The ride along Clark's Fork of the Columbia River is a daylight dream. To cap the climax this is the only way to reach the far-famed Yellowstone Park.

To reach and see all this the Northern Pacific Railroad furnish trains and service of unsurpassed excellence. The most approved and comfortable Palace Sleeping cars; the best Dining cars that can be made; Pullman Tourist cars good for both first and second class passengers; easy riding Day Coaches, with Baggage, Express, and Postal cars, all drawn by powerful Baldwin locomotives, make a train fit for royalty itself.

Those seeking for new homes should take this train and go and spy out the land. To be prepared, write to

CHAS. S. FEE,

G. P. & T. A.

St. Paul, Minn.

AN ARGUMENT IN FAVOR OF GROUND PLATES AS AGAINST A CONTINUOUS COPPER RETURN.

BY J. F. E.

A VERY unusual and singular occurrence took place on an extensive electric railway system in the northwest last month during a spell of unusually cold weather, which has attracted considerable attention in the electrical field.

The question of the proper method of bonding the rails of an electric railway, or otherwise providing a "return circuit," seems from current practice to admit of a great diversity of opinion, but latterly this part of electric railway construction has been given more attention, with a view to providing a "return circuit," more consistent with the known laws of electricity and economical operation of the system.

The unusual occurrences on the road referred to bear so directly upon this subject as to present a very favorable illustrative argument for a method of providing a "return circuit," such as is described hereafter. The essential features of the various occurrences which happened on this road were as follows:

In the middle of the day, while apparently everything was operating to the best of satisfaction, suddenly every car throughout the system stopped, and horses in various localities about the city, coming in contact with the rails, were knocked down from the shock received, and the main ampere meter in the station registered no current, although all the dynamos were in operation.

The first thing that was done to try to remedy the trouble after ascertaining that all fuses, switches, dynamo connections, etc., etc., were in proper condition, was to run from the negative line bar in the station a cable into an adjacent river bed, thus providing an excellent ground for the dynamos. But this did not obviate the difficulty: the ampere meters still registered no current, and cars refused to move; this proved conclusively that it was not lack of dynamo grounds that caused the trouble.

Attention was next directed to the track feeders, which were buried in the ground and connected the track with the negative sides of the dynamos. They, upon inspection, were found with their soldered connections melted, the wire itself very hot and burned for a length of two feet. A new cable was immediately provided in place of the burned one, and the road then started up in as good order as before.

That the earth was in a condition offering great resistance to the flow of electricity through its surface, either on account of its being in a dry frozen condition or for some other peculiar local condition, or that the rails themselves were practically insulated from the earth, which, when it is considered that ice is a very good insulator, it can easily be imagined possible to occur in cold weather, is very evident from the fact that the soldered connections in the track feeders were melted.

This melting of the connections would only have occurred by reason of excessive current passing through them, which being the fact, occurred because the rails

alone were conducting approximately the entire amount of current necessary to operate the system back to the station. This could only occur when the earth was in a condition offering great resistance, as compared with the rails, or when the rails were insulated from the earth, for usually under normal conditions the "return circuit" offered by the rails is greatly supplemented by the earth itself.

On account of the exceedingly low resistance of damp earth as an electric conductor, it being in fact infinitesimal, and as electricity in flowing back to the dynamos chooses the path of least resistance, and as the return circuit presented by the rails is of enormous resistance as compared with the earth, the greater part of the current chooses the earth as a means of returning to the station in preference to the rails, as offering infinitely less resistance. Thus with most of the current returning through the earth and very little through the rails, and as the only current that concerns the track feeder is that returning through rails alone, if this wire is of moderate size under ordinary conditions the current returning through it is not sufficient to heat it, much less to melt its connections.

Now if the rails through abnormal conditions become insulated, or partially so, from the earth, or the surface of the ground which is in immediate contact with the rails is in a condition offering great resistance to the flow of electricity, there is then no means by which it can reach moist earth, and the entire current will then be compelled to return through the rails, as offering the only available path, in which case the track feeders will have an amount of current to carry far in excess of normal, the wires will heat, due to the excessive current, and the soldered connections melt.

How it was possible for the rails to be thus practically insulated from the earth it is not the purpose to discuss in this paper, but that such was the case is conclusively proven from results that could not have occurred otherwise.

When these track feeders melted, then even this path for the return was shut off, there then being no metallic connection between the rails and dynamos, and as the rails, as is shown, must have been practically insulated from the earth, there is then no place for the current to flow to or dissipate itself, and the rails immediately become a charged conductor at the same, or practically the same, potential as the trolley wire. In fact, the rails under these conditions are made part of the trolley wire.

The fact that horses standing partly on the rails and partly on the ground were knocked down from the shock received, proves that a difference of potential existed between the rails and the ground, and the same result occurs when the circuit is completed through the body of a horse or other animal between a broken trolley wire and the ground.

In the case of the horses being knocked down by

coming in contact with the rails, their respective bodies formed the connecting link between the rails and the earth, which rails were heavily charged. Now if there had been some sort of conductor provided between the rails and the moist earth to which the current could have been conducted and thus drained off the charge held on the rails, this difference of potential would not have existed, and such accidents could not have occurred. Ordinarily the earth itself is this conductor, but when it is in a state offering great resistance, when it is very dry, for instance, it fails to perform its functions as a conductor. Thus it becomes necessary to provide an artificial one, such as a copper wire.

The effect upon the horses, showing that no difference of potential existed between the trolley wire and the rails explains why the cars refused to move.

In order to operate a motor it is essential to have a flow of electricity, and as electricity always flows from a higher to a lower potential, it becomes necessary to create this difference of potential, which is the function of the dynamo, in order to gain a flow; but if the element of difference of potential is lacking between the trolley wire and rails it is very obvious why the motors refused to operate.

From the above facts the following conclusions are logically deduced, which shut down the road and occasioned accidents: (1) The rails were insulated or partially so from the earth, (2) which prevented a flow of electricity from the rails to the earth; (3) thus the rails and trolley wire were at practically the same potential, being connected together through the motors, etc.

If it is imagined that the trolley wire and rails constitute a continuous pipe, that the dynamo is a centrifugal pump, pumping water into this pipe, it is very evident that if the end of this pipe is closed so that no water can flow therefrom, the pipe will soon become filled and there will be no flow of water. This is the exact state of conditions that existed in the case at hand. If, on the other hand, holes be drilled at frequent intervals along the length of this pipe, water would escape, and a flow in the pipe be induced by this means. The holes in this case are analogous to connecting the rails at frequent intervals to the moist earth beneath the frost line, by means of a copper wire. Thus a flow of current is always an absolute certainty; no condition could arise, such as in the case cited, that could prevent.

The facts of this case being thus brought to view, present in themselves a strong argument in favor of providing suitable grounds along the line of an electric railway, by connecting the rails at frequent intervals to the moist earth beneath the frost line. Besides preventing such mishaps occurring as shutting down an entire railway system, it would furthermore prove a valuable adjunct in the economical operation of a railway, for it would very materially decrease the total resistance of the circuit. In this manner dry earth is a very poor conductor. The earth in actual contact with the rails is dry during the greater part of the year, particularly in summer; thus the path offered by the dry earth for the current to find its

way to the moist earth underneath is one of considerable resistance. Now if copper wires are connected between the rails and the moist earth an easy path of very little resistance is immediately provided, and as it is desirable to have as much current return through the moist earth as possible, as being a medium offering the least resistance, infinitely less than the rails, the advantages of this method of construction are very apparent.

These grounds should be provided at least every tenth of a mile, or as much oftener as circumstances will admit. The wire should be as large as No. 6 B. & S., and connected to both rails if a single track, and to all four rails if a double track road.

If without these track grounds there is any advantage in running a copper return wire the whole length of a railway, a method of construction the economy of which is very much to be doubted, with these track grounds it is only a useless expense, for in providing a conductor of no resistance for "the return," as is the case in using the moist earth, why supplement this by another one of infinitely greater resistance, as would be the case in a copper return wire? Another difficulty overcome by providing these track grounds is the complaints made by telephone companies, where they themselves use the ground as a return, that at certain periods adjacent electric railways cause all their annunciators to drop in the central office. This is due to the railway not having efficient track grounds, in which case the current seeking to "return" through the dry surface of the earth, runs across a grounded telephone wire. This offering a path of less resistance than the dry earth, it immediately chooses this wire upon which to return. Thus passing through the telephone central office, it drops all their annunciators, as can be shown to be the case. This fault can be obviated by providing efficient track grounds in manner as above described.

A LARGE FLAT CAR.

TO enable the shipment of more than one street car on a flat, the American Car Company, St. Louis, have had built a number of extra long flats. These cars are 60 feet long, with 20-inch sill stiffened by eight 1½-inch truss rods.



FLAT CAR FOR SHIPPING STREET CARS.

ECHOES FROM THE TRADE.

THE traffic of the Central Electric line, at Baltimore, has increased 80 per cent since the advent of the trolley.

THE ESMOND STREET RAIL COMPANY, 106 Broadway, New York, will supply considerable of rail for use in Chicago.

THE AMERICAN CAR COMPANY, St. Louis, has orders at present for 500 cars, and is rushing things at full capacity.

J. A. TRIMBLE, of New York, furnished the storage battery cars for the Metropolitan Company, of Washington, D. C.

THE MARK RAILWAY EQUIPMENT COMPANY, of Cleveland, with Mr. Mark as manager, are successors to Mark & Sterling.

ROBERT SPENCER AND CARTER H. FITZ-HUGH will represent the Baldwin Locomotive at 1013 Monadnock Block, Chicago.

THE BATES MACHINE COMPANY, Joliet, Illinois, still continues to pay special attention to the power wants of street railway plants.

THE OHIO CONSTRUCTION COMPANY is now ready for business at 54 Franklin street, Cleveland, with H. L. Browning at the head.

THE NORTHERN CAR COMPANY, of Minneapolis, will reorganize and build a new plant in the spring. Minneapolis capital is interested.

FREMONT WILLIAMS has opened an office at 153 Times building, New York, as consulting electrician and street railway insurance expert.

THE ELECTRIC RAILWAY SWITCH COMPANY, of Portland, Maine, will manufacture and handle all kinds of electrical and mechanical devices.

THE NEW ENGLAND ENGINEERING COMPANY is the successor to the Electric Railway Engineering Company. Address still 180 Summer street, Boston.

THE ELLIS CAR COMPANY, of Amesbury, Mass., has a large stock ready for delivery, and also a number of bodies that can be made up to order to suit customers.

THE STIRLING water tube boilers will be installed to the amount of 400-horse-power for the Bay City Railway, and 600-horse-power for the Toledo Consolidated.

DEWEY ELECTRIC HEATERS are used on 98 street railroads in the United States. A Canadian branch company will be established soon, with W. H. Harvey as manager.

THE PURITY OIL FILTER MANUFACTURING COMPANY have been exceptionally prosperous during the last two months, the number of orders booked being something enormous.

TAYLOR, GOODHUE & AMES, of Monadnock Building, this city, are doing so good a business, especially with the Burton heater, that an enlargement of quarters is contemplated.

THE CAR TRUCK SUPPLY COMPANY, Chicago, has made a fine record in the street railway field, and the Schuttler Track Drill keeps up its reputation as a time and labor saver.

THE KUHLMAN COMPANY, of Cleveland, are successfully introducing a new car, which is said to be free from the old mistakes in car building handed down from former generations.

THE EDDY ELECTRIC MOTOR COMPANY, Windsor Conn., is doing good business with their generators, the records of which on various roads make their best recommendation.

BENJAMIN NORTON, the new president of the Brooklyn Traction Company, has taken to the service of his new connection, Henry R. Newkirk, formerly superintendent of the Long Island railroad.

B. W. PAYNE & SONS, makers of Corliss and high speed engines, at 41 Dey street, New York, will install two 200-horse-power high speed Corliss engines for the Kingston, N. Y., electric railway.

GENETT AIR BRAKE COMPANY is working day and night to keep up with their orders and the cry is, "Still they come." The brake has a fine record for positive action and is almost indestructible.

THE LEWIS & FOWLER MANUFACTURING COMPANY, of Brooklyn, have been purchasing additional land on which to place their factories, and hope to be able to keep up with orders in spite of great increase.

RALSTON & HENRY, street railway contractors and dealers in new and second hand machinery, at Philadelphia, are having a great call for their "Dynamo" waste, which is made especially for electrical work.

BATES MACHINE COMPANY, Joliet, Ill., has appointed W. L. Lee & Co., 275 South Canal street as their Chicago agent. Mr. Lee is a competent and genial man, and the company has made no mistake in the choice.

THE Chicago Metropolitan Elevated has secured practically all of its right-of-way between Ashland and Western avenues. Between Halsted street and Ashland avenue about one-third is secured. About one-half between Western avenue and Forty-eighth street has been condemned and the balance is on trial now.

THE GRAHAM MANUFACTURING COMPANY is the successor of the Consolidated Railway Supply Company in the building of the well-known Graham trucks. The new company has a good article and will push its sale.

THE TERRA HAUTE CAR & MANUFACTURING COMPANY contribute to our collection a strikingly attractive multi-colored calendar, in which their Barr contracting chilled wheels is shown, and illustrating its many advantages.

THE BRUNSWICK STEEL TIRED WHEELS made by Page, Newell & Company, of Boston, have been tried with satisfaction on a number of the trunk lines of the country. The company now make a wheel especially for electric cars.

THE ABENDROTH & ROOT MANUFACTURING COMPANY, 28 Cliff street, New York, will furnish that city with Root Improved Water Tube Steam Boilers and Root Spiral Riveted Pipe, for the aquarium at Castle Garden, Battery Park.

THE LYNN & BOSTON Electric, when they receive the expected permission of the Beverly authorities, will carry a passenger from Scolley square, Boston, to Hamilton camp ground, a distance of twenty-seven miles, without change.

MCGUIRE trucks are in such demand in Canada that it has been resolved by the manufacturing company to establish a branch factory at St. Catharines, Ontario. A recent order of fifty trucks came McGuire-ward from the new Niagara electric.

J. C. WELLES, secretary and treasurer of the LaFayette, Ind., Electric Railway Company, has resigned to take a position with a Chicago railway supply house. We extend our sympathy to LaFayette and our congratulations to the supply house.

THE E. H. SEDGWICK MANUFACTURING COMPANY of Poughkeepsie, have purchased the business of the S Wilke Manufacturing Company, 113-123 Clinton street Chicago. The new company will enlarge and push the sale of steam generators and heaters.

THE DETROIT ELECTRICAL WORKS will invite the attention of World's Fair visitors to the electrical equipment of the Calumet electric railways' new station at Burnside. The electrical features will be very fine. Eight 100-kilowatt dynamos will be installed.

WASIBURN & MOEN have had such an enormous increase in the business of making wires for electrical purposes that they are building three immense factories for that class of work at Worcester, Mass., and expect to have them going inside of three months.

RECENT ORDERS of Chas. A. Schieren & Company include a full equipment for the New York "Herald"

building, of which the largest belts are 35-inch; the Gas & Electric Company, of Wichita, Kansas, and the Electric Light & Power Company, of Lima, Ohio.

THE LEWIS & FOWLER MANUFACTURING COMPANY, of Brooklyn, N. Y., has furnished six elegant cars with heaters for the Quinsigamond line of the Worcester Consolidated. They are mounted on Brill trucks and supplied with 50-horse-power motor equipment.

CAPTAIN CHAS. H. SMITH, of Wilmington, Del., who recently retired from the superintendency of the City Passenger, of that city, was presented with a handsome parlor suit by the employes of the road. Captain Smith assumes the same office with the Scranton, Pa., Traction Company.

THE SCHULTZ BELTING COMPANY has sold a double leather belt, 80 inches wide and 100 feet long, to the Toledo Electric light Company. Previous to this order the St. Louis & Suburban bought two belts 72 inches by 154 feet. These were considered big belts but the latest is also the biggest.

C. D. MORSE has let contracts for building a car factory at Millbury, Mass. The company is backed by \$150,000, and Mr. Morse's former business, that of sash, door and woodworking, gives him a first rate experience for his new venture. We predict for the new firm a good patronage and a growing business.

THE GOUBERT MANUFACTURING COMPANY, of 618 John Hancock Building, Boston, Alfred A. Hunting, manager, have recently sold over 1,000 horse-power of their popular heaters, 300 of which go to the Puget Reduction Company, Seattle, Wash., and 300 to the Washington, D. C., Brewery Company.

THE FULTON FOUNDRY COMPANY, of Cleveland, has sold eight more trucks to the East Cleveland road. Mr. Wason, vice-president, is greatly pleased with the action of the trucks. The wheels, turn tables, switches, and other car house specialties, are rewarded for their excellence with a large number of new orders.

ALBERT & J. M. ANDERSON, of Boston, keeps still in the front rank of manufacturers of overhead material. Their new Brocklyn strain insulators have recently been subjected to the most rigid tests of the Massachusetts Electrical Engineering Company, with astonishing results. The insulators in question were submerged 12 days in the wreck of the steamer H. M. Whitney.

THE RISDON IRON WORKS, San Francisco, have taken the contract to supply the Oakland, Alameda & Piedmont Electric Railway with all their power plant equipment. Paul Heck is the agent of the company and should be justly proud of his capture. This is the twelfth large order of the kind for the Risdon Works, and indications point to a much larger business in the next few months.

OUR DICTIONARY OF TECHNICAL TERMS.

THE AMERICAN RAILWAY CONSTRUCTION COMPANY is the successor to the well-known and popular firm of Wright & Meysenburg, engineers and contractors for all kinds of street railway work. A. S. Littlefield is president of the new company, E. F. Carry, vice-president, and Edw. A. Meysenburg, secretary and treasurer. The new company cannot fail to succeed to the full prosperity and large business of the former firm.

PROVIDENCE CORLISS.—A great engine order from the Lake Roland Elevated, of Baltimore, has just been furnished by the Corliss Steam Engine Company, of Providence, R. I. The order asked for two tandem compound engines, 20 and 36 by 60 inches, connected by counter shaft 52 feet by 17 inches. The fly wheels are of 40-inch face, 20 feet in diameter and weigh 36,000 pounds. The General Electric furnished the generators.

THE WESTINGHOUSE ELECTRIC & MANUFACTURING COMPANY held a reception for the week beginning January 16, at their Allegheny City factory, for the introduction of the new lighting dynamos for the World's Fair. The machines weigh 150,000 pounds each and the armature 42,000. The attendants showing these products of Westinghouse skill, were prompt, courteous and intelligent in their explanations, and the affair was altogether a great success.

THE CAMPBELL ELECTRIC SUPPLY COMPANY, 104 High Street, Boston, are now manufacturing the Century wires, formerly made under royalty by the Simplex company, and the former are now in the market with the various grades of feeder, underground, submarine cables and line wires of the Century patent. The Campbells are using the original formulas for the celebrated "T. R. R." with important improvements by the inventor, Henry F. Campbell.

THE GOUBERT MANUFACTURING COMPANY, located at 32 Courtland street, New York City, makers of the Goubert Feed-Water Heater, have purchased the patents, stock and business of the Stratton Separator Company, and are now the sole manufacturers of the well-known Stratton Separator. This device for extracting entrained water and grease from steam, that it may be furnished dry to engine, is one of the most popular inventions of the kind on the market, and its manufacturers have enjoyed a substantial increase of business yearly.

THE ELECTRICAL SUPPLY COMPANY, of Chicago, is receiving many warm compliments on the success of the Carpenter electric heater, of which the company is agent. The successful tests of the Carpenter device under the strain of our late cold weather is gratifying in the extreme. A letter from Mr. Charles Smith, of the Findlay Street Railway Company, says: "The past three days were terribly cold here, but our cars were comfortably warm. We have all our cars equipped with the Carpenter Electric Heaters and are well pleased with them." The company has recently changed its name to the Ansonia Electric Company.



"A Hammered Joint."



"Ringing up a Fare."



"The Down Trip"



"Called a Miss."



"A Rope Transmission."



"Ahead of Time."
(also behind time)

THE finest specimen of photography which has ever come into the REVIEW office is the handsomely framed mammoth picture showing the three big bays in the extensive works of the Walker Manufacturing Company, Cleveland. The artist has succeeded in catching even the smallest details, while the massive structural work of the buildings and the long lines of machinery in operation are all perfect. The picture is nearly 3 feet wide by 6 long and is one of the attractions of the REVIEW office. Gen. Walker has spared no expense in securing one of the finest results in interior photography we have ever seen.

THE LAMORIN CAR WORKS, at Philadelphia, have, since the introduction of their late improved construction, been in receipt of numerous letters of inquiry for prices, congratulations and recommendations, with a large increase in orders. Lately orders have come from the Philadelphia Traction Company for 40, 29-foot open and closed; East Harrisburg Passenger Railway, ten closed vestibuled car bodies; Wilmington, Del., City Passenger, 15 open cars; Schuylkill Traction, Ashland, Pa., four 18-foot closed vestibuled; East End Railway, Williamsport, Pa., two 16-foot closed vestibuled; Greensburgh & Hempfield Railway, one 16-foot closed. Late deliveries count in an order for the Schuylkill Company.

W. W. ALLEN, Red Wing, Minn., whose double acting safety brake will make a quick stop and hold a car on any grade an electric car can climb, has still further improved it by the substitution of a cast iron adjustable shoe in place of the rubber shoe. The iron shoe is said to work perfectly. Mr. Allen has also done away with all chains and uses a piece of 3/4-inch gas pipe for a connection between the shaft and brake staff, which has several advantages and is less expensive. The Bemis Car Box Company, which is now equipping quite a large order with these brakes, made a test of the brake, and after doing so wrote Mr. Allen as follows:—

"We have received the sample brake sent us and find it satisfactory in all respects. Please make us six (6) more sets all complete and forward to us at the very earliest possible date."

ONE of the largest contracts for road bed construction for an electric line has just been closed in St. Louis. The Chicago & St. Louis Electric Road, about which so much has been written of late, have closed the contract for the entire road-bed including grading, bridge-work and track-laying. The contractors are Bagnall Bros., of St. Louis, Mo., and Givens Bros., of Memphis, Tenn. Both of these firms are well and favorably known and have laid more than a thousand miles of road and track work for various western and southern railroads. The contract price is \$5,500,000, of which \$2,750,000 is to be taken in bonds of the company at par. The true limit of the contract is one year, but it is very probable that by fall the road-bed will be completed, as it is proposed to start work immediately at several different points and work in both directions.

THE BALL ENGINE COMPANY, of Erie, Penn., has placed through its Chicago agency, the following equipments: Calumet Electric Railway, four 300-horse-power cross-compound electric railway engines; Hammond Electric Street Railway Company, Hammond, Ind., a 150-horse-power steam plant; Western Light & Power Company, Chicago, one 300-horse-power; Englewood Electric Light Company, Chicago, one 500 cross-compound; Marengo, Iowa, Electric Light Company, a 100-horse-power steam plant; Elmwood, Ill., Electric Light Company, one 300-horse-power, together with smaller orders at other western points. Frank R. Chinnock, at 18 Cortlandt street, New York, reports the eastern sales of the Ball Company including: Main & Tonawanda Street Railway, Tonawanda, N. Y., engines; Ithaca Street Railway Company, Ithaca, N. Y., complete steam plant; Seabury & Johnson, East Orange, N. J., engines; Hahne & Co., Newbury, N. J., engines; Doves Stores, Brooklyn, N. Y., engines.

THE wisdom of the Railway Equipment Company, Chicago, in confining its business to the specialty of electric railway supplies only, has been acknowledged by all contractors and street railway managers. The certainty of finding everything needed for the complete equipment and maintenance of electric roads of all systems, ready for immediate shipment, has resulted in making customers for the company throughout the entire world and wherever an electric road is in operation. The policy of the company has always been to furnish the best material obtainable, and the present standing of the company, as well as its constantly increasing business, would seem to indicate that it has been successful in furnishing such material.

Already large orders have been received for roads to be equipped in the spring, and undoubtedly a large share of this business has been on account of the new type "G" material brought out by the company the last season. It is claimed that this material is superior in point of strength, insulation, and ease of adjustment to any other like material manufactured. The company has greatly increased its facilities for the manufacture, and announces that it will be able to fill orders promptly for the coming season.

Among the specialties of this company is the agency for Brand's Patent Steel Wire Track Brooms. These brooms have a large sale throughout the country and Canada, and are a great convenience, if not an absolute necessity, on all electric roads. The Ahearn Electric Heater is perhaps the most important agency of the many handled by the company. Electric car heaters have been placed on some seventy-five roads this season, while the trade in electric stoves and other heating and cooking devices is constantly increasing.

The company can rightly be called the pioneer house in its exclusive line, and the long and practical experience of its manager in catering to the wants of electric roads, is sufficient guarantee of satisfactory dealings, and the men are too well known to require commendation.

J. G. BRILL COMPANY, Philadelphia, has just closed a contract for thirteen cars for the West Side Street Railway Company, Elmira, N. Y.

A. S. PARTRIDGE, St. Louis, is doing a fine business in railway supplies. His second-hand rail bargains make numerous customers.

THE PECKHAM MOTOR, TRUCK & WHEEL COMPANY, of Kingston, N. Y., is getting its share of the spring delivery orders. They will be pleased to send plans and blue prints to prospective buyers.

THE PITTSBURG STEEL HOLLOW WARE COMPANY is making music for a number of cities on their famous rolled steel gong. The tone of these bells is loud and continuous, and the wear of the best.

HILL & WELLES, LaFayette, Ind., recently sold three of their elegant tower wagons to J. G. White & Company, for the equipment of roads built by the White people.

T. C. WHITE & COMPANY, St. Louis, the western agents for R. D. Nuttall, are as ever prepared to furnish anything and everything a street railway can ask in the way of gears, pinions, trolley specialties and other supplies.

THE ELECTRIC SUPPLY CHANGES ITS NAME TO "THE ANSONIA ELECTRIC COMPANY."

JUST as we are going to press we learn of an important change which has been made by one of the largest electrical companies. Wherever electrical merchandise has found its way, the name of the Electrical Supply Company has been known also: in fact, so well known has the name become, in the fifteen years that they have been doing business, that smaller concerns all over the country have adopted and adapted the name, or part of it, to their own use. This has led to a confusion in the minds of the general public that has been of no little annoyance to the company originating the name.

A new name for the same old company has been under consideration for several months, in fact for a year or more. They could not but hesitate in relinquishing a name that has cost them thousands of dollars to make a familiar one everywhere, but in so doing they have been actuated by reasons that seem good and sufficient. There is no doubt that the new name, The Ansonia Electric Company, will become as well and familiarly known as the old; it will certainly have the advantage of being unlike any other name, and cannot be traded upon by those who have not the energy or capital to establish names of their own.

We understand from F. S. Terry, manager of the western department of the company, that there has been no change whatever in the organization, character or personnel of the company. He says: "the business will be conducted as heretofore, following the same methods

of popularizing our goods, and observing the same fundamental principle of making them the best that is possible with expensive and improved machinery and expert mechanical ingenuity.

We have found it necessary to enlarge the capacity of the factories at Ansonia, which are undergoing additions and changes that will enable us to materially increase our output.

It is not the intention to drop our old name immediately and entirely, but the two names will appear together for some time in our advertisement and printed matter; we can in this way more thoroughly establish the identity of the new name."

FOLGER'S IMPROVED FARE REGISTER PUNCH.

A NEW fare register has just been brought out by the Cincinnati Novelty Manufacturing Company. Its advantages will readily be understood from an examination of the cuts. In the form Fig. 1, the registry movement is covered by cover permanently sealed

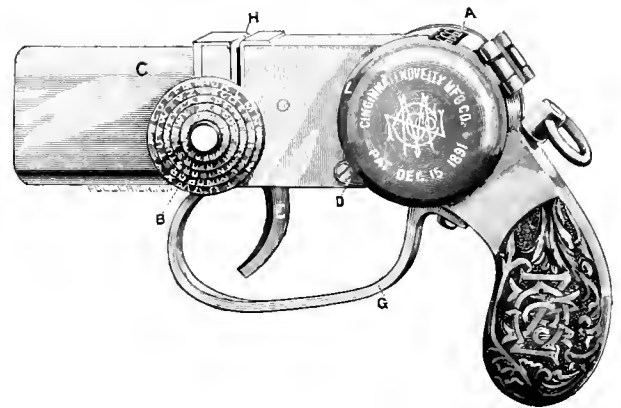

FIG. 1.

and which can only be opened by the manufacturer. The registry wheels show through the opening "a" and record to 9999, then automatically return to 0000: these wheels are permanently locked by screw "d." The combination lock "b" only releases the wad receptacle "c," and as there are five wheels in the combination it is impossible for an expert even to discover it.

The opening lever "e" is protected by guard "g" and cannot catch on clothing or in any other way. If the user desires to distinguish between full and half fares registered, a cash slip may be inserted in slot "h," the wad dropping into proper receptacle to be checked against total register at end of day.

There is another form of this punch, differing in shape and with different location for combination lock "b." Both forms carry alarm bell which sounds with every register. The register can be suspended from the neck by strap, or at the side by chain. Is light, cannot get out of order and is of positive action and has much to commend its use.

It is reported that Mr. Yerkes and Chicago associates have bought in considerable Washington City stock.

HALF FARES.

Interesting Facts from all Parts of the Country Boiled down for Busy Readers.

THE HOSKINS MOTOR is now being tried on the Powell street line, San Francisco.

THE New London and Norwich street railroads have been consolidated under one management.

EIGHT hundred men were required to clean the tracks of the Montreal street railway lines after one of the regulation snow storms incident to that city.

RUSSELL HARRISON and the sheriff have taken possession of the Queen City road, of Marion, Ind. The Delafield Construction Company held the road.

THE legal war over the Los Angeles Cable Railway is being waged in that city, and is proving one of the most complicated legal controversies in many years.

THE New York Sun states the cost of a system of underground roads in that city, such as would solve the rapid transit problem, could not be built for less than \$300,000,000.

THE Joplin Electric Street Railway & Motor Company now rents its power from the Southwestern Electric Light & Power Company, having a water power station at Grand Falls.

THE LEBANON & ANNVILLE road, after 16 months' service, declares a 6 per cent dividend. There is a population of only 16,000 to draw from, but the road is a magnificent success.

ON Monday, January 23, the alley elevated road in Chicago, was turned over by the constructing company to the operating department of the Chicago & South Side Rapid Transit Company.

THE Brooklyn, Bath and West End road has been bought by the Philadelphia syndicate, owning the Atlantic avenue line. This gives a quick and direct route to Coney Island from the heart of Brooklyn.

GENERAL SLOCUM, of Brooklyn, is elated over his victory in the courts over a man who claimed to have been shocked by the current from one of the Coney Island cars. Experts proved the action groundless.

TOY WING SANG, of Canton, China, has gone into the syndicate business, and interested English and American capital to the extent of \$1,400,000 for the purpose of building electric railway and light plants in Canton.

AKRON, O., has just recovered from a small pox scare. The street railway thoroughly fumigated its cars twice each day, and won much commendation for the vigorous manner in which they protected the public.

THE TWIN CITIES RAPID TRANSIT COMPANY has moved its accounting department from St. Paul to Minneapolis.

A ten days' strike has been on at Wheeling, W. Va., over the discharge of a driver and conductor whom a patron makes affidavit refused to stop for him. Car service maintained in fairly good condition.

AMONG the recent idiotic attempts at legislation in Ohio it is refreshing to find a bill introduced by Dodge, of Cuyahoga, proposing to sell the now entirely useless Hocking canal and build with the proceeds an electric road the entire length of the course.

THE National Railway Company, owning five lines in St. Louis, has re-elected its old officers with D. G. Hamilton, Chicago, president, and Capt. Robert McCulloch, general manager. Last year's dividend was 7 per cent. The company resolved to electrify three horse lines.

THE Brooklyn Traction Company, the successor of the Atlantic Avenue Railroad Company, has been publicly organized. The directors are: E. D. Phillips, Albert Strauss, Henry S. Glazier, E. J. Kavanaugh, of New York and P. J. Vaughan and J. H. Lockman, of Brooklyn.

THE Tacoma Railway & Motor Company, of Tacoma, Wash., is making its own cars, using McGuire trucks, and President Paul Schulze says that hereafter the company will do all its own car building. A car factory on the coast ought to be a paying institution. Who will be the first?

THE fortieth annual meeting of the American Society of Civil Engineers opened its session in New York, January 19. A committee was appointed to frame a code of ethics and officers elected as follows: President, William Metcalf, of Pittsburg; Vice-President, Elmer L. Corthell, of Chicago, and Charles McDonald, of New York. The next meeting will be held next July in Chicago.

THE East Cleveland Railroad Company will put thirty new cars in commission, and considerably enlarge the power house at Second street and Fifth avenue. President Henry A. Everett will have control, acting through Secretary Beilstein, while attending to his Canadian business. Superintendent Duty will remain. The list of officers reads as follows: President, H. A. Everett; vice-president, C. W. Wason; secretary and treasurer, L. E. Beilstein.

A Milwaukee plumber went out to plumb. And as he plumbed by the electric roadside he dugged a deep hole. And some of the hole fell upon the track. And as the electric car passed that way there was a great shaking of the car and the conductor thereof was cast into the ditch. And his raiment and his spirit were rent. And so it came to pass that the conductor sues the plumber for \$1,000, with the which to make himself whole for having been in the hole.

PICTORIAL EVENTS OF A MONTH.

A NEW system of rapid transit was exhibited on the Cicero & Proviso electric in the western part of Chicago. A passenger left the car at the bluff overlooking the Desplaines river and after divesting himself of his outer clothing got into a big sack he carried and drawing a cord from the inside completely overlapped his head and body. He then cast himself down into the river where he was rescued by the passengers, who pulled the sack out of the river and cut it open. As they did so a pair of wild eyes snapped while a husky voice inquired, "Am I Dead?"

A FUNNY and rather significant feature of the inclosed platform bill is that the men for whom the act is ostensibly introduced were neither instrumental in seeking it, and do not now urge its passage. To a man up a trolley the whole scheme smells strongly of sand bag legislation.

At Fonda, N. Y., while a gang of Italian laborers were thawing 20 sticks of dynamite, for blasting on the Fonda & Gloversville Electric Road, an explosion occurred, killing one and wounding many.

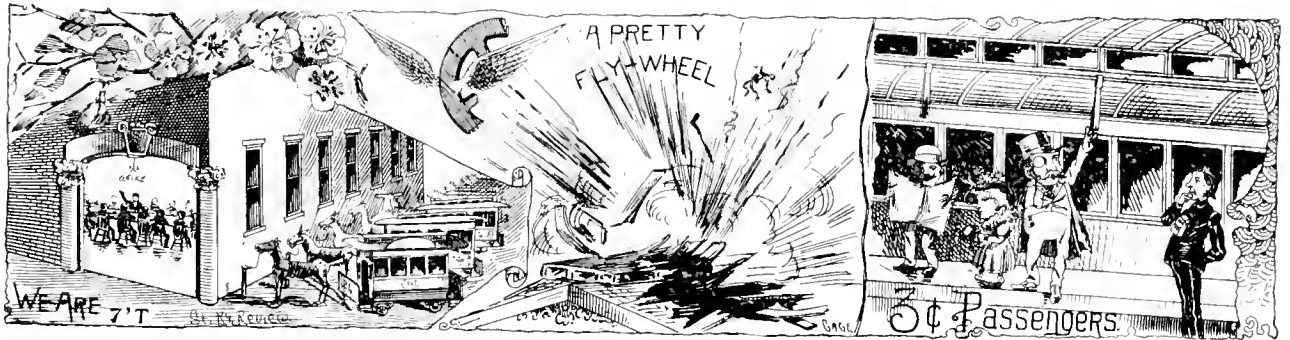

THE Union Depot Street Railway, St. Louis, suffered a rather unusual accident recently in the bursting of a small fly wheel at their Jefferson avenue power house. In its tangential flight a segment of the wheel landed a block away, destroying the wall of the building, a picket fence and the equanimity of several pedestrians. The loss was about \$1,000. Half an hour before the accident the street was crowded with people.

At Provo, Utah, the entire rolling stock of the Provo City Railway was sold for \$127 50 to S. B. Thurman, for payment of taxes amounting to \$248. As the company promise to pass the hat and raise the balance the sale of the track has been postponed a few days

At Birmingham, Eng, the traffic manager, T. Goodyear, presided

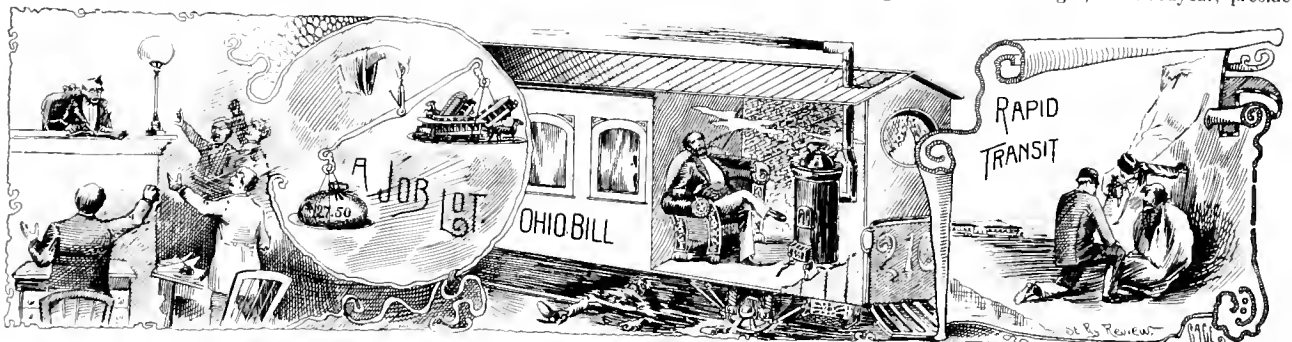

THERE are people in plenty, as the experience of every manager shows, who in case of a 3-cent standing fare being established, would swear by their great-grandfathers' thumbs that it did not agree with them to sit. In the absence of any standing room on the floor these people would not hesitate to stand on the seats. At present these are the no seat-no fare howlers.

over the seventy employes of the Bristol Road Tramway, who held their annual dinner. Car service was entirely suspended during this enjoyable event, and passengers walked while the boys ate.

THE Arctic road is the latest crazy transportation scheme which Erastus Craw, New York, proposes. It contemplates tracks of iron

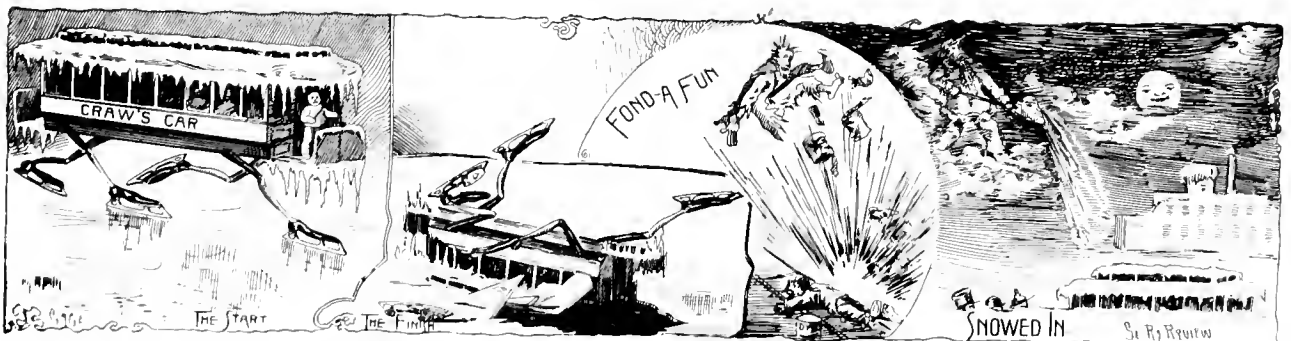

Two thousand unemployed laborers of Montreal recently invaded the city hall demanding that the street cars be allowed to run as it gave them employment. The demonstration was occasioned by a petition of carters and others to stop the cars, as it was ruinous to their business. The alderman were hissed and hooted, and the city government in general made very uncomfortable.

pipes filled with a freezing mixture on which the moisture of the air will congeal, forming a sheet of ice on which a car propelled by hydraulic jets will skate. He promises eighty miles an hour, but we predict that if anybody buys stock in the scheme it will stick in his 'craw.' Another advantage of this system is free ice water for patrons of the line.

NEW PUBLICATIONS.

A TREATISE ON THE LAW OF STREET RAILWAYS, by Henry J. Booth, of the Columbus, O., bar, 689½, XV, 749, law sheep, published by T. & J. W. Johnson & Company, Philadelphia; price, \$6.

Without investigating the natural rights of man, without any long dissertation on the sociological questions incident to rapid transit Mr. Booth has prepared a text book on that branch of private corporation law in which our readers are solely interested. Without doubt the courts of our country have had their most difficult cases, the least precedent, and the most obscure analogies in street railway litigation, a branch of legal proceedings born of the most rapid mechanical progress of this rapid century. The many excellent text-books on the law of steam railroads have touched lightly or not at all this field embracing so many new and important questions.

Mr. Booth had thus a most difficult, although a most intensely interesting, subject for discussion, a subject without perspicuous definitions, without aid from the greater writers on American law and with only the contemporaneous law literature to guide.

How well the learned author has succeeded in covering the variety of correlated subjects can be understood only by a perusal of the table of contents.

Steam street railways, horse lines, electric and cable traction and elevated railways have each their appropriate head and discussion. Franchises are discussed in all points of view. The minor particulars of removal of snow from the streets, smoking on cars, gongs, bells and fenders are examined carefully and a complete table of cases referred to sections makes the work complete and accurate.

The book is prepared for the use of the bench, the bar, the corporation and the general public, to whose consideration we recommend it.

THE NEW ENGLAND MAGAZINE for this month has a very attractive menu, including "Fayal," "Literary Chicago," "Prophets," "The Pilgrim's Church in Plymouth," "Tacoma," and "The Story of a New England Parish in the Days of the Province." The illustrations are fully up to the high standard of this publication.

WE acknowledge the receipt of the report of President Adams on the University of Wisconsin, in which Dr. Adams asks for \$33,850 for improvements in the mechanical and electrical departments of the University. This appropriation will put in a complete electrical plant.

THE "TECHNIC," the annual of the Engineering Societies of the University of Michigan, is just published, and shows that "good works," in the way of original investigation on scientific subjects, have not been wanting in that institution during the past year. Among articles of special interest to railway men are "Transmission of Power," by A. R. Frantzen, and "Relative Cost of Prime Movers," by J. R. Allen. H. George Field is the corresponding secretary of the society.

A NEAT little pamphlet has just been published by Taylor, Goodhue & Ames, on the subject of transformers, with special reference to the Diamond Transformer. There is much of general interest to electricians in its contents.

CASSELL'S FAMILY MAGAZINE for February contains a very interesting and full account of the United States Weather Bureau, a subject that has never been enlarged upon before to any great extent. A paper of practical value in the same issue is on "Getting on in Business."

LIPPINCOTT'S MAGAZINE this month prints a complete novel by Julien Gordon, under the title "The First Flight." Herman F. Wolf gives an account of "Wrestling," for the athletic series. "Seventh Commandment Novels" are criticised by Miriam Coles Harris.

IT is said that \$20,000 has been raised in Fairfax county to aid L. W. Spear's Alexandria city and suburban road of Washington city.

By April 1 the inhabitants of Snohomish and Everett, Washington, will be exchanging afternoon calls by means of the new electric railway. A power house is in building at East Everett, and the Land & River Improvement Company, of Snohomish, expects to rush the affair.

BREVITIES.

L. E. MYERS, who, as Chicago agent of the railway department of the Detroit Electrical Works, has done so much to advance the interests of his company, has been rewarded by the appointment to district manager. His offices are Nos. 917 and 918 Monadnock building, Chicago, and he will have entire charge of the railway, power and lighting departments in this vicinity. The appointment is a justly merited one, and Mr. Myers' numerous friends will learn with pleasure of his success.

THE BAY STATE TRUST COMPANY has been granted its application for trustees' sale of the Allen & Swiney lines at Dubuque. The total indebtedness is \$350,000, and the sale will take place during the last week in March. The Trust Company holds a \$200,000 lien, the General Electric is a judgment creditor for \$23,000 and inferior liens make up the balance. It will take from \$40,000 to \$50,000 to put in the necessary new equipment.

THE long suffering Atlanta Traction Company has changed hands again. This time northern capital buys the stock and either Judge Rosser or Judge Hines will become president, vice J. W. English, Jr., who has sold out his stock and retired. The road is four years old, doing a good business, and owning 6¼ miles of track and eighteen cars. Besides the Judges mentioned, Mr. Woodward and the northern unknown are in the new company. E. E. Holcombe will remain as general manager.

W. R. MASON, general manager of the Railway Equipment Company, Chicago, has just sent out a circular to the eastern trade, calling attention to the unequalled facilities of the company for furnishing everything necessary for the complete equipment and maintenance of electric roads, and also calling particular attention to the merits of the type "G" overhead material manufactured by his company. This material has been specified on a majority of the leading roads during the last season. He also informs the trade that he expects to be in New York the latter part of this month, and will call on the leading contractors and street railroads in the east.

THE Glasgow town council committee has decided that electricity is not the thing for Glasgow. Cable traction will next have an examination, but a horse system will probably be the ultimatum.

LABORERS rejoicing in the names of Jesus Chacon and Frank Moraga recently unearthed \$2,000 in gold and silver Spanish coin while digging on the Alameda railway bed at Oakland, Cal.

A DISGUSTED passenger rushes into an English paper to remark that it makes him tired and swearful "to run 100 yards after a tram car only to find the lawful capacity taken," and then have to wait for the next car.



WINDSOR & KENFIELD,

PUBLISHERS AND PROPRIETORS,

269 DEARBORN ST., - - - CHICAGO.

Published on the 15th of each month.

SUBSCRIPTION, - - - TWO DOLLARS.

FOREIGN SUBSCRIPTION, - - - 20 SHILLINGS.

Address all Communications and Remittances to THE STREET RAILWAY REVIEW
269 Dearborn Street, Chicago.

H. H. WINDSOR,
Editor.

F. S. KENFIELD,
Business Manager.

CORRESPONDENCE.

We cordially invite correspondence on all subjects of interest to those engaged in any branch of Street Railway work, and will gratefully appreciate any marked copies of papers or news items our street railway friends may send us, pertaining either to companies or officers. Address:

THE STREET RAILWAY REVIEW,
269 Dearborn Street, Chicago.

Entered at the Post Office at Chicago as Second Class Matter.

This paper member Chicago Publishers' Association.

VOL. 3. MARCH 15, 1893. NO. 3

MANY of our readers who find it difficult to spare any time at their office for the perusal of even a street railway publication, have directed us to send the REVIEW to their residence, where they can pick it up at leisure. The plan has worked very satisfactorily.

WHAT have you decided on in the way of attractions to create pleasure riding, this summer? Those roads which maintained skating parks the past winter report a very profitable business. If you have never tried the experiment of out-door attractions, arrange to do so this season and note the surprising results.

ELECTRICITY as applied to the operation of elevated roads will now have a large and practical demonstration. We have already described the line in Kansas City, and this month relate the details of a still larger system, that of the Liverpool, England, Overhead Railway. The English installation is very complete, but is simple in both arrangement and construction. Stations, platforms and cars are of course electrically lighted, and air brakes, and electric block signals—the first of their kind on elevated roads—insure safety in operation. The elevated road within the World's Fair grounds will shortly afford another exhibition of electric transportation of this type.

THE street railway company at Wheeling, W. Va., has been made a spectacle during the last six weeks. Apparently the city officials have not raised a hand to suppress the mob element which has endeavored to prevent the operation of the cars. At any rate the authorities have lacked sadly in moral courage somewhere, or such disgraceful proceedings could never have occurred day after day.

INDICATIONS point to an early spring, which means an early start to a multitude of new railway enterprises only awaiting the advent of good weather. Reports from all directions indicate an enormous volume of new work for this year. Probably a much greater amount of old track will be relaid this season than last, while extensions and new lines will consume a large amount of material. Power house work in new plants and additions to old will be a prominent feature.

OHIO is rapidly becoming as prominent as Pennsylvania in electric traction. Columbiana county is said to have 15 miles of road, Mahoning county 37, and Stark county 31. These counties are in the new districts. Trumbull county has 60 miles of franchises pending and about 3½ miles of road in operation. The number of interdependent small manufacturing and mining centers in the two grand states mentioned make them inviting fields for interurban electric enterprise.

AS stated in these columns frequently, the tendency on the part of legislators to the creation of state boards of commissions, and similar bodies is a bad one for the interests of the people. An effective illustration of this comes from Massachusetts, where the people of Beverly, by an overwhelming majority at the polls, gave the right to construct an electric road, which the selectmen steadily refused to sanction for the past four years. The announcement was the occasion of a popular demonstration.

THE public mind of New Orleans is at present considerably exercised over the question of separate street cars for the negro and white population. The street railway companies have nothing to do with the case, as it is confined principally to letters printed in the city papers. A similar question has troubled several other southern cities without coming to any definite conclusion. The question is still before the jury of the people, and the street railway, a third and so far neutral party.

ONCE more the rapid transit fever has broken out in all its fury in good old Boston; again committees report, mayors speak and preside at public gatherings and the local newspapers are sure of several columns a day. The problem is purely a local one and will have to be worked out on the ground. It certainly is one of the most difficult matters to consummate, owing to the widely different individual interests. Which ever way the commission turn their eyes a host of business men arise and object, pleading "not here." They all want rapid transit but at the expense of someone else. The blessed old

common, which in the eyes of the unregenerate westerner approaches at certain seasons of the year to a close resemblance to a frog pond, seems to rise before the well made plans of engineers like a dead line. The proposal to slice off sufficient for sidewalk purposes is deemed the entering wedge to preemption, while the prospect to cut a street or so across its sacred limits is nothing less than sacrilege, pure and simple. As stated in these columns, widen the streets and rapid transit already in operation will assert itself.

IN the Boston Traveler a contributor states: "Boston and Massachusetts will never have fast, safe and convenient traveling facilities by steam or electricity until all cars propelled by these powers are compelled by the people, through their agent, the Legislature, to pass all streets and roads above or below grade." If this be the case, then Boston will celebrate its three hundredth anniversary before the accomplishment of the desired end. Underground roads will not be built in Boston. Elevated roads would for the most part have to occupy the streets, and even then would be obliged to cut through many valuable business blocks. This can be accomplished, but it will be a slow, difficult and enormously expensive undertaking.

IN street railway management, as in the operation of steam roads, it is largely the small details that must be watched to prevent accident. It is all in vain to maintain the most careful inspection of machinery and wheels of locomotive and train if the same care is not taken of switches and an hundred other places. The manager may equip his car with the most approved brakes and fenders, and yet overlook the steps over which every passenger must pass twice during every ride. The number of accidents occurring to passengers while boarding or leaving a car will undoubtedly outnumber those arising from all other causes combined. Hence to carefully make a study of step and hand rails is one which may well engage the time of the busiest superintendent. We have seen steps on street cars which the directors would consider a constant source of danger if built into a flight of stairs in their residence. Such roads are, of course exceptions, nevertheless it can do no harm to watch your steps and determine as to whether or not you are as fully protected as may be.

A FRANCHISE is being sought from the commissioners of a certain county in a neighboring state, for an interurban line. The commissioners, undoubtedly in the endeavor to do their whole duty to their constituents, thought to err on the safe side and threw around the proposed franchise so many and unnecessarily severe restrictions that the promoters of the enterprise are about ready to give up in dismay and disgust. We cannot but be convinced from the reports repeatedly brought us, that this class of public servants is sadly in need of a better understanding of what is fair and just; of the extreme difficulty of enlisting capital where the terms are made so exacting; and the untold advantage and benefit such

lines have been and will prove to the entire community. It enables the farmer and all his family to get to town in the worst weather, quickly, cheaply and comfortably, and encourages and makes possible intercourse between the various villages and cities so connected. The facilities for transporting light freight, express and mail is invaluable to the public. As an illustration of the granger ideas of the board referred to it is only necessary to mention that one clause bound the railway company to build a switch track into every farm yard along the entire route whenever the owner requested. A better knowledge of these matters, such as can be gained from a progressive publication devoted exclusively to street railway problems would work a change of heart and ideas.

OF the subjects for discussion at the next convention there are two which possess more of newness than the others. One is the use of the T rail on a paved street; the other, storage batteries at central stations. With the improvements made in the manufacture of vitrified brick for street pavement, and the ease with which it can be turned out by machinery in any desired shape or length, it is a matter of surprise that the rail men have not paid more attention to its development. As for the brick makers, they already seem to be overrun with orders, and doubtless, knowing very little of street railway wants, have ignored this branch. This certainly will prove a most interesting subject, full of practical interest, and it is to be hoped may be the means of bringing out much useful information. If it is practical to pave to a T rail, street railway men ought to know it. If, on the contrary, it is not a satisfactory combination, they are just as interested to be assured of that fact. As to storage batteries at central power stations, we are convinced that is to be the great field for the battery in railway work. As a reservoir of energy on a car it has been a dismal failure, as witnessed at Dubuque, and within the past month at Washington, D. C. But for station work we predict a large demand for the storage battery as soon as American managers become more familiar with its possibilities for usefulness and the results already attained in similar work in Europe.

WE believe in operating a business, whatever it may be, for all there is in it. While in the very largest cities the transportation of passengers may afford all the work the company can profitably handle, in hundreds of smaller cities and larger towns the avenues to good revenue which may be opened up in various directions, and leading out from the power station are numerous. The sale of electric power for the operation of small stationary motors, and even larger ones, naturally comes first on the list, and the wonder is more managers have not secured this field to their companies. In some cases it may require personal effort to introduce and popularize this system of power, but once started it becomes self-advertising. Also, when a new enterprise is contemplated, the local manager can easily influence a decision in favor of using electric power from the start. Then there are an endless variety

of purposes where the electric heater has a place, and electric lighting has almost no limit. Exhaust steam, even in comparatively small plants, if within a reasonable distance of stores, residences and public buildings, has a commercial value far beyond the realization of most people. Already in several railway plants the sale of exhaust steam has gone a long way toward reducing the fuel account to a surprisingly low figure. In at least an hundred railway plants enough exhaust steam is allowed to go to waste to pay a good, fat dividend. We can see little difference between needless waste at the exhaust head and a careless collection of fares, where a large portion of the passengers are overlooked. A manager who would install his plant without putting in a feed water heater would be looked upon with suspicion; oil filters are acknowledged to save their cost every few months, a daily record is kept of the oil used; coal is weighed into the fire-room, and any unusual consumption calls out an immediate explanation. Why not carry out the economy to its utmost practical limit?

WHILE cab and carriage hire is lower in Europe than here, the street car fares are not, despite the frequent assertions to the contrary by people who do not know. True, one can ride a half mile there for less than any American line will haul him, but the vastly greater important fact is overlooked in that there are no cheap rapid transit facilities for clerks, working men and the vast army of moderate wage earners. With us a three to five mile ride for the five cent fare is found everywhere, and in this city and elsewhere it extends to even eight and ten miles. In other words the long hauls abroad cost more than here. The result is the poorer classes are compelled to make their homes in down town districts, crowding in like ants and deprived of the room, air and cheaper rents of the suburbs. The construction of cable and electric lines have revolutionized values in outlying and previously unoccupied properties, but great as has been the good work in this respect, the untold moral and sanitary advantages which have resulted from this spreading of population are vastly greater. The long hauls, as on some lines in Chicago, are made at a loss, and are only possible in proportion to the volume of short riders paying the same fare as the others. To reduce fares for short distances would necessitate an increase for the long distances, which in view of the manifold benefits to the community already suggested would prove a most unfortunate and unwise step. If some of the one-idea theorists who profess to have carefully studied the foreign transportation problem, only would or could comprehend the widely separated existing conditions, and the magnificent service furnished in America they would, if honest, put off their warped old blue-glass goggles when further attempting to write on a subject at present little understood by them. We confidently predict that of all the astonishments in store for our tramway brothers across the water on the occasion of their prospective visit to Chicago and the states, the street railway systems will occasion the largest attention and surprise. Our friends

will then return to institute a series of reforms based on American methods of operation which will surprise even themselves.

ASSIGNMENTS of subjects and committees for a report at the next street railway convention has just been announced by the secretary. It is to be hoped the executive committee will limit the preparation of papers to the six topics chosen, as the convention this year will need more time than ever before for discussion. A few timely questions carefully reported and freely discussed are of more value than twice that number read only by title. Then, too, this year we shall have a large attendance of the fraternity from across the water and both courtesy and personal interest demand the giving up of considerable time to them. Outside of regular sessions there will be more than ever to occupy the time of all in attendance. The exhibit will be much larger than that in the street railway department at the World's Fair, and the regulation three days will hardly suffice for the accomplishment of the attractive programme Mr. Payne will provide. The committee have certainly made a most commendable selection of subjects, while the assignment is specially well placed. Four of the topics are exclusively electric; another is largely so, while the other one applies to any system. Horses and cables are entirely ignored, but of the former nothing new worth the time of the convention has been developed in the past several years, and the cable system has been long since perfected. The list of subjects is as follows:

1. Best Method of Lighting and Heating Street Railway Cars.
G. F. Greenwood, General Manager Pittsburg, Allegheny & Manchester Traction Company, Pittsburg, Pa.
2. Can the T Rail be Satisfactorily Used in Paved Streets?
C. Densmore Wyman, Vice-President Central Park, North & East River Railroad, New York City, N. Y.
3. Direct Driven Generators.
C. J. Field, Electrical Engineer, New Jersey Traction Company, Newark, N. J.
4. Power House Engines.
E. G. Connette, Superintendent United Electric Railway, Nashville, Tenn.
L. H. McIntire, Electrical Engineer, Atlantic Avenue Railroad Company, Brooklyn, N. Y.
F. S. Pearson, Electrical Superintendent West End Railroad Company, Boston, Mass.
5. Standards for Electric Street Railways.
O. T. Crosby, Boston, Mass.
Charles W. Wason, Cleveland, Ohio
L. H. McIntire, Brooklyn, N. Y.
Thos. H. McLean, New York City.
C. G. Goodrich, Minneapolis, Minn.
6. Storage Batteries in Connection with Central Stations for Utilizing Surplus Energy for Lighting or Power.
C. O. Mailloux, Electrical Engineer, Metropolitan Railroad Company, Washington, D. C.

ONE of the most important and far reaching measures which ever passed a city council, has become a municipal law in Chicago. It calls for a practical abolishment of the several thousand grade crossings, and the steam roads are allowed six years in which to complete the work. To carry out the order will involve the expenditure of many millions, but will be a grand thing for the public and the surface car companies.

RACINE'S STREET RAILWAY.

HISTORY says that horse lines in Racine were not blessed with quiet, uneventful lives. On the contrary from August, 1878, when the first street railway was organized as the Racine Horse Railway Company, until 1892, when the last horse retired from service, the records shows four changes in management, two failures to lay track and other vicissitudes until, in 1883, the Belle City Railway Company, of which Charles Hathaway was manager, began to work.

there are in contemplation several extensions. The road-bed is mainly earth with five miles paved, divided between macadam, stone and wooden block. Brick paving is contemplated for the remainder of the line. The rail is 52-pound girder and 45-pound T, made by the Johnson Company and spiked to ties spaced 16 inches, center to center. All bonding is double, number 0000 wire being used. The return is through the rail.

The overhead construction was put up by the Detroit

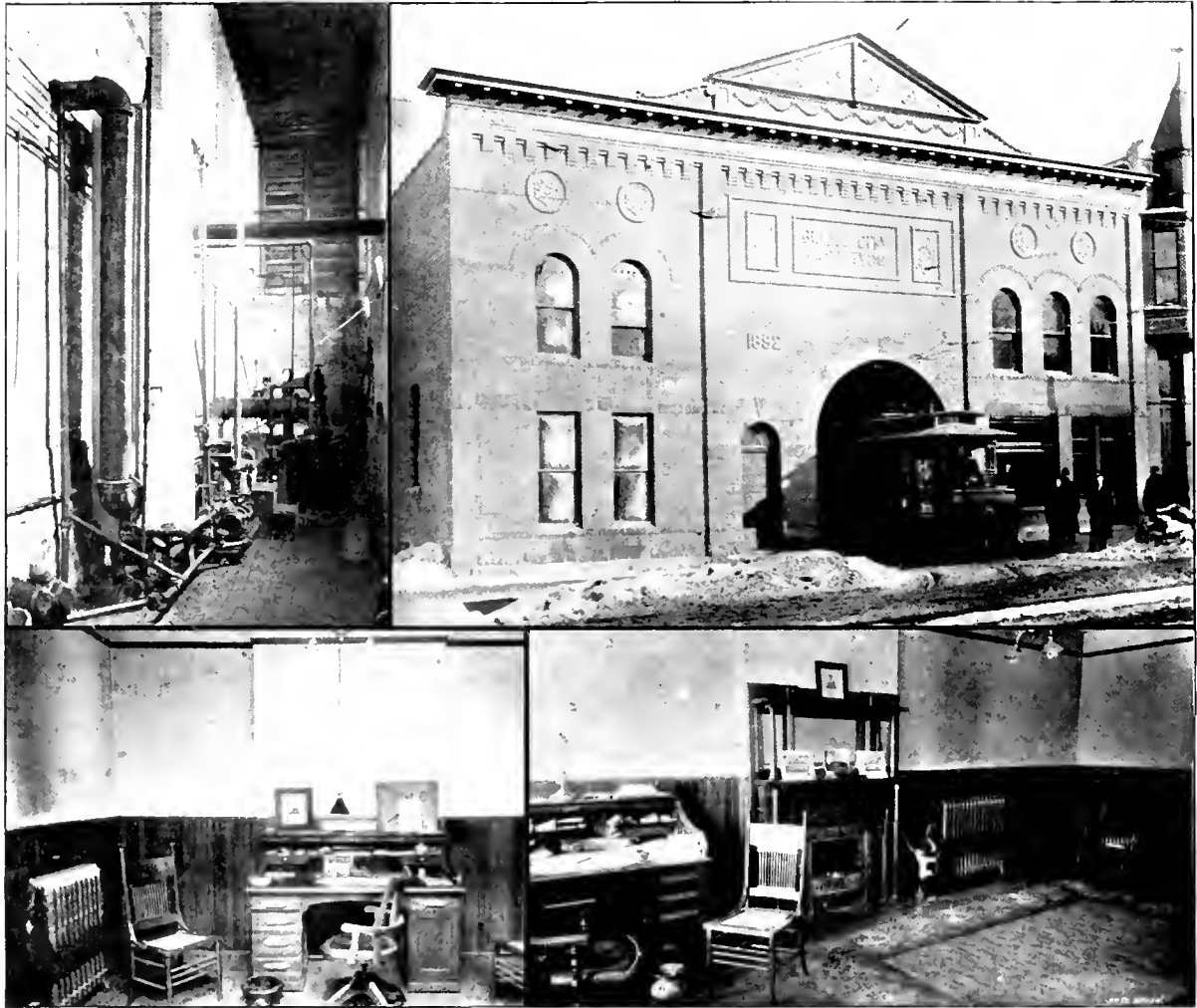

COLLES FEED WATER HEATER.
ALLEN SHEWMAN'S OFFICE.

EXTERIOR OF POWER HOUSE.
PRESIDENT HOLMES' OFFICE.

The horse lines thus finally built were very successful but the demand for the "latest," to which the people of Racine are partial, brought C. H. Holmes and Allen Shewman, of St. Louis, to Racine to spy out the land. The change of ownership ensued and in June, 1892, the re-organization was effected. A franchise for 50 years was obtained a little later and in July last the company commenced the system which to-day gives Racine's pedestrians such a satisfactory service.

The Belle City Street Railway Company now owns 13 miles of track, of which three miles are double and

Electrical Works and is well done. Wooden side poles are most extensively used but a mile and a half of center pole construction may also be seen. A change soon to be made is the cutting in of the feeders in six sections. This will serve a double purpose in supplying small power users with electricity for commercial purposes. Already a large number of applications have been made. The Main street line crosses a bridge over the river and the connecting device, designed by H. B. Niles, of Sargent & Lundy, is worthy of more extended notice. A submarine feeder will be used on the bridge section as soon

as a dredge is obtainable. A temporary wire suffices for this winter. Sargent & Lundy, of Chicago, were contractors for the roadbed and the work was superintended by W. J. McCord. The bridge above referred to is built on a three and one-half per cent grade and is 150 feet long on the draw.

Situated on the main street line at the center of the system is

THE POWER PLANT,

offices and car barn. The power house is 1,200 feet from Lake Michigan with a tunnel to that sheet of water emptying into an 8-foot condensing well supplied with a Worthington condenser. The work cost one dollar a foot but pays for itself every nine months.

The big engine that is responsible for the well-being of the Racine plant was made by the M. C. Bullock Manu-

The dynamos are five 80-kilowatt "Detroit" machines, to which will be added three 225-horse-power of the same make when the station unit is increased as above related. The station is 60 by 120 feet in dimension, and contains also in a room next to the engines a Colles feed water heater and purifier, herewith illustrated. The heater is an important adjunct to the economy of the plant and saves its cost several times over during the year.

The Tracy oil filter is another economizer that is worthy of mention. The Phoenix Automatic Filter Company, of Racine, is the manufacturer and guarantees a large saving in oil. Mr. Shewman recommends the device heartily.

The boilers are three in number, en banque. They are 66 inches in diameter, 16 feet long and each contain 64 inch tubes. The domes are 40 inches high and 36

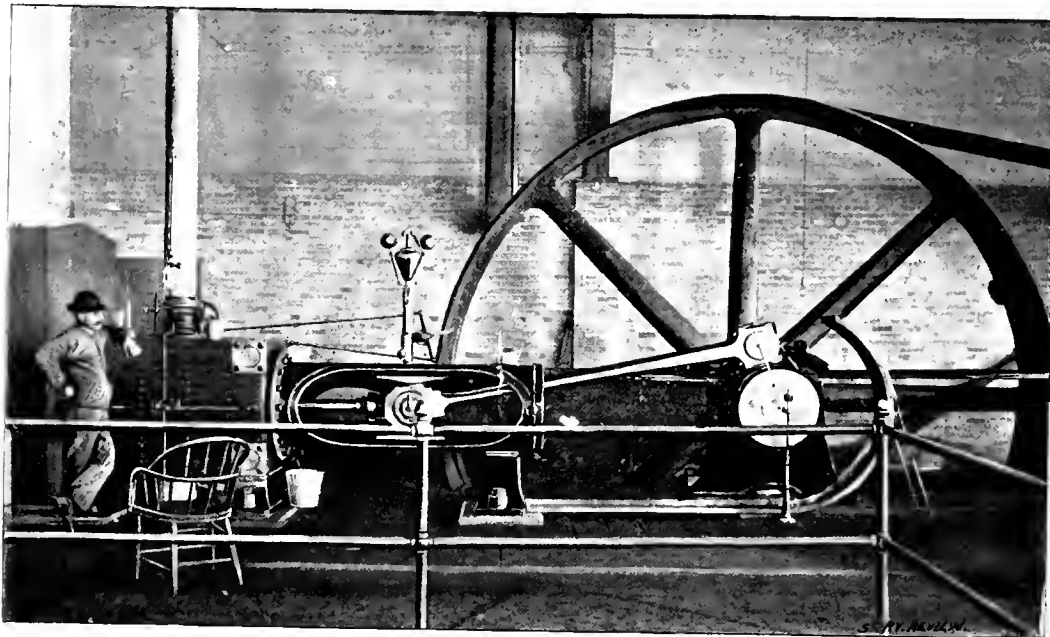

M. C. BULLOCK-CORLISS ENGINE, RACINE.

facturing Company, which company, it is well to remark, was contractor for the entire steam plant.

The engine in question is one of their well-known Corliss type, with cylinder 22 inches in diameter by 42 inch stroke, driving the three 80 kilowatt Detroit generators.

The engine carries an 18-foot wheel, weighing 30,000 pounds. The action of the engine is smooth and the government very sensitive, giving two of the most essential requisites of street railway service, and Manager Shewman is well satisfied with the entire installation.

The engine is belted to a 34 by 66 inch driving pulley, and the power distributed from an 8-inch jack shaft 29 feet long, on which are three clutch pulleys 16 by 66 inches. The shaft is broken near the driving pulley and coupled with a clutch coupling. Two Munson double leather belts transmit the power. One is 120 feet long and 32 inches wide and the other belt 200 feet in length and 14 inches in breadth.

inches in diameter. The shells are of 3/8-inch pure steel, and the heads 1/2-inch steel. The smoke stack is 60 feet high, 54 inches in diameter and made by the S. Freeman & Sons Manufacturing Company, of Racine, who also built and installed the boilers under sub-contract of the Bullock Engine Company.

THE ROLLING STOCK

consists of ten St. Louis Car Company's motor cars and four of Lamokin's make. All are 25 feet over all and mounted on Brill trucks. Six more cars are under way at the American Car Factory, to be mounted on McGuire trucks and Cushion car wheels. The motors under the cars are of the Detroit Standard system, double reduction, furnished with the Detroit Company's new patent controlling switches, by the use of which it is impossible for motormen to "get switched" between points, thereby preventing the burning of switches. The motors run

smoothly and quietly and have given no occasion for repairs; in fact, so firm is the Racine people's faith in the equipment that no repair shop is contemplated.

The fine offices of the company are herewith illustrated. Beneath the offices are located the neatly appointed waiting station and a compact cashier's office and a large vault.

The officers of the company are: C. H. Holmes, president; J. E. Dodge, secretary, and Allen Shewman, general manager.

DR. C. H. HOLMES

is about 40 years of age and a native of Anderson, Ind. His education was acquired at the Indiana State University and his medical degree in Rush Medical, Chicago. After practicing his profession four years, electricity became so attractive to him that he turned from the scalpel to the dynamo, going to St. Louis, where he was chief organizer of the Municipal Electric Light & Power Company. After setting this company on the high road to success he retired, taking up the electrical supply business at St. Louis, furnishing the above named company. Going to Racine in 1890 with Mr. Hathaway, he then became a fully reformed doctor and is able to correctly diagnose the symptoms of non-dividend-paying roads and apply the proper remedies, as his successful career shows.

ALLEN SHEWMAN

was formerly a lawyer, born at Kokomo, Ind., in 1864. After studying at the Terre Haute Normal he was graduated from the law department at Ann Arbor in 1885. After practicing four years at his home, and after a large experience in Texas real estate, he became associated with Dr. Holmes in the electrical supply business. Finding his vocation in railway work, he spends his time in exemplifying the new but true maxim that railway managers are both born and made.

CONNECTICUT'S COMPETITION.

THE consolidation known as the New York, New Haven & Hartford is making a fight against the extensive electric systems that bid fair to become strong rivals. A bill is before the legislature asking for a street railway commission to supervise this line of business, and a joint committee of steam and electric men will try to prepare a mutually satisfactory arrangement which will also be submitted to the same body of law makers. The consolidated does not oppose local lines, but rises in earnest protest against the long paralleling of steam lines. The steam people will therefore vigorously oppose the longer interurban lines. It might be well for the steam men to reflect that all the legislation possible will not prevent the inevitable. Know all men by these symptoms that there is a new era in electric traction now beginning.

"YOUR'E OFF THE TROLLEY" is a classical expression occurring in one of the plays now being presented in this city.

THE CHICAGO AND EVANSTON ELECTRIC RAILWAY.

THE long fought battle for a franchise has been ended by the city of Evanston's recent grant of extensive rights to the Chicago & North Shore Street Railway Company.

The line which will connect the beautiful suburb to the metropolis must needs be of the most modern and beautiful construction and a glance at the list of contracts already let will show that no details will be left unfinished. The line will make connection with the North Chicago cable.

Iron poles, both center and side, will carry the trolley wire and 27 miles of 0000 and 000 feeder will be used.

The American Construction Company, of Chicago, has the contract for the track construction, using Johnson 85-pound girder rail on electrically welded chairs.

The power station will be 100 feet front by 230 feet deep, situated on Evanston avenue near Ardmore. The style of the construction is Italian Renaissance.

The General Electric Company has the contract for the electrical equipment, which will consist of two, 450-horse-power generators, switch boards and wiring. The California Construction Company will furnish their well-known rope transmission and three 250-horse-power Heine boilers will furnish steam for 450-horse-power Wheelock engines.

The rolling stock now under contract will consist of 26 closed 18-foot cars and 16 open cars 24 feet in length. All mounted on McGuire trucks.

It is expected that the city end of the line will be in operation by April 25 and the remainder of the system by June 15. The American Construction Company has all the necessary hustle to do this big contract on short notice and will have a large army of workmen on the field.

Geo. W. Maher, of Chicago, is the architect of the power house. B. J. Arnold, of the General Electric, has charge of the engineering and Mr. McLimont is superintendent of construction.

THE INDIANAPOLIS FROG AND SWITCH COMPANY.

THIS enterprising company, so well known to all street railway as well as to steam road men, has just completed their new factory at Springfield, O. The new shop is a tremendous affair, 60 by 800 feet in dimensions, built of brick and fitted with all the improved machinery for executing the largest orders for street railway switches and crossings.

The great increase in their trade during the last year necessitated this addition to their facilities. Among several large street railway orders now in the hands of the workmen are extensive contracts for the Memphis, Tenn., Street Railway Company and the Chicago City Railway.

HALF FARES.

Interesting Facts from all parts of the Country Boiled down for Busy Readers.

PRESIDENT B. F. GIVEN, of the City Passenger, Reading, Pa., has applied for new charter under title of the Reading Traction Company.

EX-MAYOR GRANT has sent out his circulars as president of the Railway Advertising Company. They will advertise in Broadway surface cars.

THE tramways company of Sheffield, England, received \$96,340 last year and spent \$71,330, leaving a net profit of \$25,010. A 4 per cent dividend was paid.

AN automatic street indicator geared to the car axle has been testing in San Francisco, and is reported a success. Such devices heretofore have all proved failures.

THE big storm recently in Ottawa, Canada, required the electric railway to use 1,000 horse-power to keep the equipment in motion. Thirty teams were also at work removing snow from the down town districts.

SOUTHERN enterprise at Florence, S. C., will soon have an electric railway. The entire plant of the Columbia Street Railway has been bought by the Florence & Suburban. The plant consists of $4\frac{1}{2}$ miles good, new track and six cars.

PRESIDENT C. T. YERKES, of the North and the West Chicago cables has rejected the design of Sculptor Kelly, of New York, for an heroic representation of "Sheridan's Ride," for Union Park, Chicago, and has decided to open the design to competition.

DR. MARY WALKER has boldly and equivocably gone on record as an opponent of crinoline on the grounds that it interferes with rapid transit. Dr. Mary has just celebrated the silver anniversary of her enfranchisement to 'pants' and she ought to know.

THE Lowell & Suburban Street Railway Company used a harrow with good effect during the winter to loosen ice and snow between the tracks. The harrow was to all appearances the ordinary agricultural implement, but equipped with a dozen 18-inch teeth.

AN extensive plan for a net work of interurban lines in Northern Ohio will embrace Youngstown and other larger cities. The Canton-Massillon line will be extended to Alliance. The Warren-Niles line and the Youngstown-Niles line will probably be built this summer.

THE mendacity of mean men on the line of the Staten Island Rapid Transit Company, of New York, will probably cost honest people their commutation privileges. The company sells fifty-four tickets for \$3.00 to those who earn less than \$7.00 a week. Some higher salaried people have made poverty affidavits and the company threatens to withdraw the privilege.

THE proposed high speed line between Buda-Pesth and Vienna has recently been severely criticised by J. Kareis, a well known Austrian engineer. Mr. Kareis says that the mechanical details are not wanting, but that the traffic, 200,000 annually, will not warrant the outlay.

ANTHONY N. BRADY, the New York millionaire and street railway magnate, began life 48 years ago. He was the son of poor parents and made the greater part of his fortune in the last five years. He recently put down his check for a cool million for the purchase of the Lexington avenue line, New York.

SNOW, cold weather, and want of fuel has played havoc with the expenses all over the country for the past month. On February 8, the Grand Rapids Railway had fifty miles of track without a car on account of the coal famine. Nearly all the large factories in the town were shut down and the domestic supply itself was in danger of exhaustion.

HIGH KICKING has been severely condemned by many good people, and now the Nebraska courts have held a street railway in that state responsible for the death of a driver who was killed by a right-hand-back-foot shot from an ugly broncho which rebelled at drawing an overloaded street car. The deadly trolley will have to look to its laurels now.

C. F. HOLMES, general manager of the Kansas City cable, has received merited praise from the citizens and press for his active services during the recent hard storms. The cable line was kept open during the most severe weather. Once Mr. Holmes appeared in rubber boots, leggings, macintosh and cap, driving a pair of mules to the sweeper. It is gratifying to know that his efforts were appreciated.

ALBERT I. FAY, of Minneapolis, has invented a conduit system of electric railway not unlike many which have gone before. Across a shallow conduit are placed the ties, and on these the copper conductor. Two slot rails over the conductor form a second and smaller conduit. The difficulty, amounting practically to inability of cleaning his lower conduit, would alone seem to make the method a failure.

COLD AS IS COLD.—Wallace D. Dickinson, superintendent of the Great Falls, Montana, Street Railway, when calling at the REVIEW office, laughed at the reported cold in the eastern states the past winter. At one time the thermometer fell to 54 degrees below zero, and for a time made no effort to get up again. For two weeks the highest register at any time was 10 below, while during several days the warmest was 20 degrees below zero. At one time Mr. Dickinson found it necessary to use two drivers to a car, working them in 10-minute shifts. His cars are equipped with Carpenter electric heaters, and while on the coldest days it was not found necessary to leave the front door open, still the results were very satisfactory.

THE BOYNTON BICYCLE system of transit makes a proposal to New York City to introduce this method of traction on an elevated plan. In 1891 the STREET RAILWAY REVIEW illustrated Mr. Boynton's patent and the contributor of an article on "Rapid Transit in New York" spoke of the advantages of this method on certain lines. Mr. Boynton's will probably not lighten the surface transit to any serious degree.

OVER 5,000 shares of stock in the lines operated by the Belt Line Company, of Washington City, were sold recently at \$55 for \$50 shares. Some stock brokers say that the sale was made in the interests of the Philadelphia syndicate. It is also rumored that a controlling interest has been secured in the Metropolitan and in the Columbia roads. These interests will be placed under one management. It is thought that these lines will soon be equipped electrically.

HON. S. W. FORDYCE, a prominent steam road man of St. Louis, has been elected president of the Little Rock Electric Railway Company. Since the road is again in the hands of the stockholders, it is hoped that it may be placed on a firm footing. The road is a good property, well constructed, economically and mechanically, and ought to be able to live until the public is educated to its advantages. A consolidation of the town lighting interests is being financed.

THE GENERAL ELECTRIC COMPANY are again the victors in the lamp patent litigation. The remarkable evidence brought in by the Beacon Company at the eleventh hour, claiming the invention and use of the incandescent lamp twenty years prior to the Edison patent was overruled by Judge Colt, of Boston, who says in his decision: "The presumption of novelty arising from the grant of the patent is not to be overcome except upon the most clear and convincing proof."

WOONSOCKET. R. I., has granted the Woonsocket Street Railway Company an exclusive franchise for 20 years. The street railway in return will pay 1 per cent of its gross earnings to the city for the first year, 2 per cent for the next year and 3 per cent for the remainder of the time. Legislative consent is already obtained for an increase of stock to \$400,000 with permission to issue \$400,000 in bonds. It is proposed to extend the line to Uxbridge, Mass., taking in a number of villages and towns.

A POWER house 89 by 125 feet in dimension with double pitch roof, is to be built by the Berlin Bridge Company, of East Berlin, Conn., for the Worcester, Mass., Traction Company. The boiler room will contain nine 6-foot boilers, made by the Stewart Boiler Works, of Worcester. The Lake Erie Engine Company, of Buffalo, will put in five high speed compound condensing engines of 500-horse-power each, direct coupled. Five 500-horse-power General Electric generators. The Field Engineering Company has the contract.

R. B. PIERPONT, well known as the former manager of the Gould & Watson Company, Chicago, and now a member of the banking firm of Longstreet, Pierpont & Company, and Jas. W. Longstreet, nephew of President Longstreet, of the American Street Railway Association, will establish a restaurant at the corner of Sixty-third street and Madison avenue. It will be called the Boston Cafe. Mr. Pierpont will be manager. It will be opened April 18, and all street railway men will find the warmest welcome and the best fare.

A RATHER difficult situation confronts the street railway men of Montreal, resulting from the passage, after a stormy meeting of the city council, of the by law awarding the contract for an electric railway from the city to St. Louis de Mile-end, to the Montreal Street Railway Company, throwing out the grant to A. J. Corriveau. Notwithstanding this Mr. Corriveau will proceed with the road under a former contract and carry the matter to court. Ground has been bought for a power house, and engines and boilers of 1,000-horse-power will be put in.

WE can't swear to the veracity of the story, but it is said that a long-suffering conductor in Cleveland recently cured a certain man of a bad habit. The man in question always appeared with a \$10 bill on the early morning trip, and the conductor not being able to change it paid the fare. The fifth morning the worm turned and when the bill was offered the conductor said, "Certainly, sir," and pulled out a heavy bag from under the seat. "Here's yer change, sir. It's all right; I counted it." And before he knew it the astonished traveler was the happy possessor of \$9.75 in pennies!

An interview, published in the New York World, contains the news that the patents secured by Geo. F. Green, of Kalamazoo, Michigan, who died last year, have been bought by the General Electric Company, of O. S. Kelley, of Springfield, O., the assignee of Green. These patents were filed in 1879, but rejected on technicalities, but finally secured to Green, December 15, 1892. F. B. Fish, of Boston, is said to have been the counsel for the buyers. S. D. Greene, assistant manager of the General Electric, is reported as the informant of the World, and is quoted as saying that the "patents cover broadly the overhead trolley system as used by all electric roads."

THE 250 miles of track operated by the Twin City Rapid Transit Company were buried under from two to ten feet of solidly packed snow during the storm the last of February. In some places the cuts were above the car roofs. The blockade cost the company in the neighborhood of \$10,000.

THE Nationalist Club, of Indianapolis, has settled the rapid transit question again. They would rent the streets at \$1,000 a mile per annum. After 1901 the city would then buy back the plant and operate by means of ward politicians.

LIVERPOOL OVERHEAD RAILWAY.

The first Elevated Railway to use Electricity in Europe—The Largest of its kind in the World—A Magnificent Structure with Splendid Construction and Perfect in all its details—Tilting Bridge Spans—Automatic Electric Block System of Signals.

BY J. H. WOODWARD, C. E.

THE most noted electrical event which has occurred in Europe in a long time was the opening, on February 4, of the electric elevated railway in Liverpool, locally known as the Liverpool Overhead Railway.* A large attendance of notables graced the occasion, and the machinery was set in motion by the Marquis of Salisbury, who delivered an appropri-

rapid communication between all the docks lying along the river. The railway is carried overhead for its whole length, with the exception of about 270 yards, where it passes on an embankment under an already existing line belonging to the Lancashire & Yorkshire Railway Company. The structure is built up almost entirely of steel, several novel features having been introduced, both in the

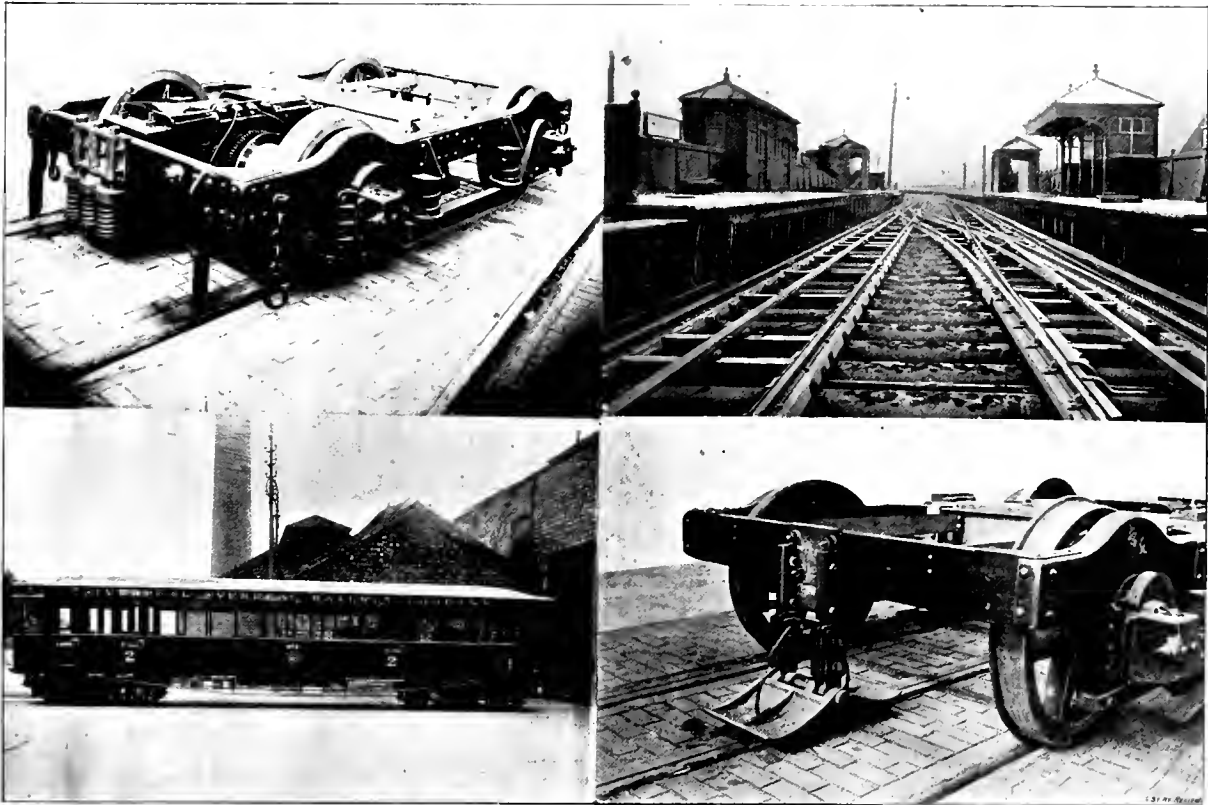

SCENES FROM THE LIVERPOOL OVERHEAD RAILWAY.

BOGIE TRUCK.

TWO CLASS COMPARTMENT CAR.

SECTION OF ELEVATED TRACK.

COLLECTOR SHOE AS ATTACHED TO TRUCK.

ate address. Among other speakers were the mayor of Liverpool and Sir William Forwood. The inaugural trip passed off successfully and was witnessed by thousands.

The railway as at present completed, consists of a double line of rails of the ordinary 4-foot 8½-inch gauge, extending for a distance of six miles over the Mersey Dock Board's Estate, and intended to give a means of

design itself and in the method of erection employed.

Special mention should be made of the tilting bridge, by which two spans' lengths of the railway can be tilted to allow the passage below of very large boilers, etc.

The whole works have been carried out under the direction of Sir Douglas Fox and J. H. Greathead, the consulting engineers to the Liverpool Overhead Railway Company.

Throughout the greater part of the line the gradients are easy, though where it comes to the embankments to pass under the other line there is a dip having a gradient of 1 in 40. The smallest curve has a radius of six chains. Fourteen stations give ample provision for taking up and setting down passengers; the maximum distance between

*A full description of construction will be found in THE STREET RAILWAY REVIEW for August, 1891. In 1887 parliament authorized the Dock Board to construct the line, which for the most part is over their own property. In January, 1888, the Dock Board agreed to build the road and lease it for 999 years to the Liverpool Overhead Railway Company. Construction began July, 1890; line was formally opened February 4, 1893. Structure contains 25,000 tons of metal, and cost complete \$3,500,000.

any two stations being 1,200 yards. The stations in the city, at the center of the line, are more frequent, those at Pier Head and Jarvis street being only 300 yards apart.

After very careful investigation on the part of the directors and engineers it was decided to adopt electricity as the motive power, and also for working the signals and lighting the stations.

The contract for the whole of the generating plant, conductors, rolling stock, signals, etc., was placed with the Electric Construction Corporation, Ltd., of London and Wolverhampton, and has been carried out by them under the personal direction of Thomas Parker, their chief engi-

which is brought in trucks over the boiler house and discharged directly into the hoppers feeding the stokers. The engines are four in number, of the horizontal coupled compound type, each capable of indicating 400 horsepower with 120 pounds steam pressure, at 100 revolutions per minute. The cylinders are 15½ and 31 inches diameter, 36 inch stroke. Corliss valve gear is fitted to both cylinders, securing good regulation in speed with the rapidly varying loads which all engines are subject to when used for driving electric railways. The flywheels are 14 feet diameter, grooved for nineteen 1¼ inch diameter ropes. The exhaust steam from the engines is taken to

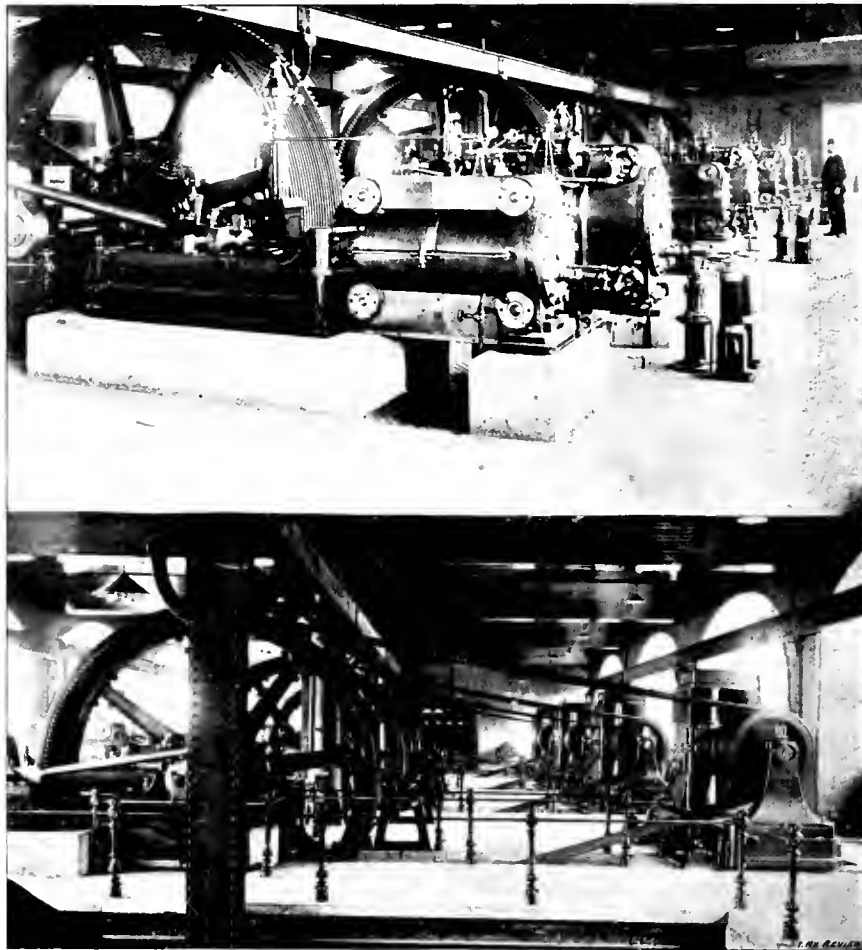

INTERIOR POWER STATION LIVERPOOL OVERHEAD RAILWAY.

neer. The constructors have supplied a generating plant and conductors capable of running a three minute service of trains throughout the whole line, each train weighing, with passengers and motors, about forty tons. The six miles has to be run, including stoppages at each station, in thirty minutes, this necessitating a maximum speed of twenty-five to thirty miles per hour.

The generating station supplying power for working the whole line is erected at the Bramley-Moor dock, the site being close to the railway and about the center of its length. Steam is provided by six Lancashire boilers eight feet in diameter and thirty feet in length. These are fitted with mechanical stokers, conveyer, and all appliances for the economical use and handling of coal,

a separate surface condensing plant, the circulating water for which is obtained from the dock adjoining the station. Two sets of condensers are installed, each capable of dealing with the steam from three of the main engines working under full load. Auxiliary engines are employed for driving the boiler feed pumps, stokers, conveyer and scrapers of fuel economiser fixed in the main flue. All steam and feed pipes are arranged to give a duplicate service between the engines, boilers and pumps.

Each of the main engines drives by means of cotton ropes, an Elwell-Parker continuous current dynamo, giving 500 volts, 475 amperes, at 400 revolutions per minute. The magnets are two pole, of the double horse-shoe type, fixed vertically, divided on the horizontal line, so

that the top half can be lifted off to allow of examination or removal of the armature. The pulleys are carried between two bearings, and a coupling inserted between the pulley and armature shafts allows the latter to be taken out without taking off the ropes, dismantling the pulley, or interfering with the set of the bearings.

The current is carried from the dynamos by underground cables to a switch board, where all the machines couple in parallel onto omnibus bars. An ammeter, voltmeter, double-pole automatic magnetic cut-out, main switch, and regulating switch with resistance coils is provided for each machine. The main current on its way to the line passes through another automatic magnetic cut-out. The conductor along the line from which motors draw their supply consists of a steel channel carried upon porcelain insulators in between the ordinary rails. The steel was specially made so as to secure a high conductivity, and has a section of four square inches. The surface of the channel is about one inch higher than the tops of the ordinary rails, and the lengths are jointed together by copper fish plates. The return circuit is completed through the ordinary rails, which are electrically joined across the fish plates.

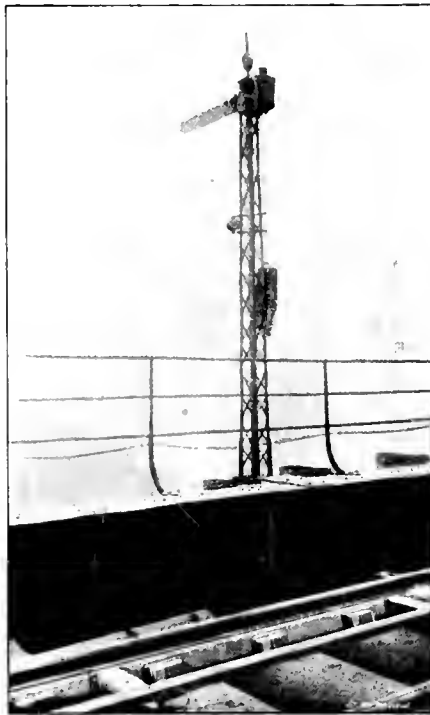

ELECTRIC BLOCK SIGNAL.

The carriages are mounted upon two 4-wheel bogies. The length over end pillars is 45 feet, and width over side pillars 8 feet 6 inches; centers of bogies, 32 feet; wheel base of bogies, 7 feet; diameter of wheels, 2 feet 9 inches. They seat 56 passengers. Each is provided with a driver's box at one end, in which are fitted all the driving switches and brake controlling levers. One of the bogies carries the motor, the armature of which is mounted directly upon the axle. The magnets are of the double

horse-shoe type, series wound. In addition to the bearings on the axle they are supported at the ends by a special arrangement of springs from the bogie's frame. Ten revolutions of the motor armature are equivalent to a car speed of one mile per hour, so that the maximum speed attained is 250 to 300 revolutions per minute. The

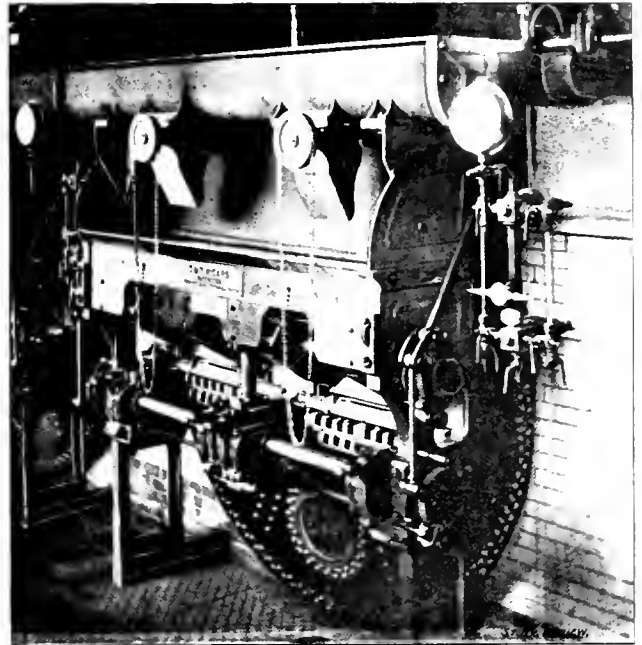

ONE OF THE BOILERS.

motors when tested in the shops gave when at rest the following torque efforts at the rim of the wheel (2 feet 9 inches in diameter):—

- With 30 amperes, 170 pounds.
- With 50 amperes, 450 pounds.
- With 60 amperes, 650 pounds.
- With 80 amperes, 1060 pounds.

The brakes are of the Westinghouse pattern, supplied with compressed air from a large receiver carried under each car, this being charged at the terminal station, where a compressing plant is installed.

The trains consist of two of the above carriages, connected so that there is a driver's box at each end and a motor on the leading bogie of the last car. There is no shunting at the terminal stations, the driver simply changing ends. A gangway between the two cars affords a clear passage through the train for the conductor. The carriages are lighted by incandescent lamps, supplied with current from the center rail.

The bodies are constructed with a gangway down the center of the carriage, and the seats arranged on each side, the entrance to the carriages being through side doors. The interior is divided into three large compartments and one small compartment for the driver. The first-class compartment at one end provided with seat accommodations for sixteen passengers is divided from the second-class compartment by a sliding door. The second-class compartments are divided by a partition with open doorway, the seats arranged to accommodate forty passengers.

The collectors consist of hinged cast iron shoes supported by, but insulated from the bogie frames, one to each carriage. These shoes are made very much wider than the conductor so that at the cross over roads they will bridge across from the conductor on one side of the ordinary rail to that on the other side.

At each of the stations along the line an accumulator of

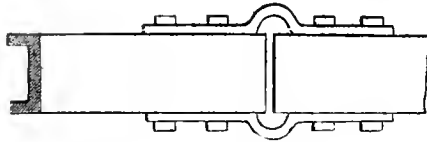

CONDUCTOR RAIL CONNECTION.

54 cells is erected. A number of these are connected in series and charged by current at 500 volts from the main dynamo at the generating station. These batteries supply current for lighting the stations and also for working the signals. This is the first line of its kind upon which a complete line of automatic electric signals has been adopted. They are entirely automatic in action, each

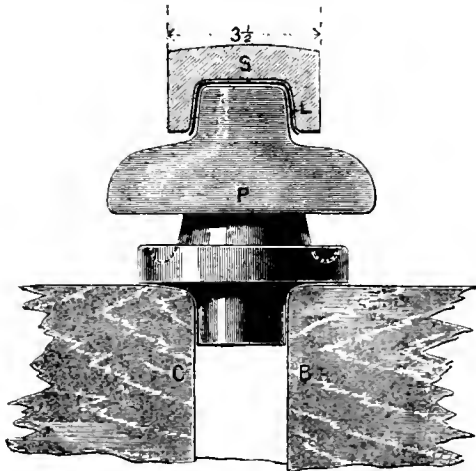

MANNER OF INSULATING CONDUCTOR.

train blocking the section in the rear as it passes along.

To carry out the work several firms have been employed as sub-contractors. The boilers, engines and other portions of the steam plant having been supplied by John Musgrove & Sons, Ltd., of Bolton; the carriages by Brown-Marshall Company, Ltd., of Birmingham; the steel channel by the Shelton Iron & Steel Company, Ltd.,



CROSS SUPPORT OF CONDUCTOR.

of Stoke-on-Trent. The whole of the electrical plant has been manufactured under Thomas Parker's supervision at the works of the Electric Construction Corporation, Ltd., Wolverhampton. They also being responsible as contractors for the complete plant.

The construction and equipment are all first-class, and the work has been carried out to a most successful completion, reflecting great credit on all connected with the enterprise. It has entered at the start upon a large and

profitable business, and is literally on the "high road to success." As the volume of business to be carried will



ONE OF THE STATIONS.

be large throughout the day, the results will command unusual interest from elevated roads in this country.

INDUCED TRAFFIC in New Jersey is becoming a feature of traction policy since the introduction of the trolley. The Newark and South Orange Company has placed under the distinguished consideration of the city fathers of Newark a plan for the extension of several lines, one of which will touch the new summer pavilion at the "Neck." Here Sunday schools and social dancers will picnic, and far from the maddening crowd Newark will disport itself. The electric wishes to carry the crowd and will probably get the privilege.



UNDER VIEW OF STRUCTURE.

"If this doesn't end soon I am going to go out and lose myself," observed Rapid Transit Commissioner Bushe of New York city, recently.

"In my dreams I see swarms of cranks displaying plans for roads ploughing under the city; others built on all the high church steeples; tunnels, viaducts, depressed roads, 'L' roads, surface roads, transverse roads, cables, trolleys and electric motors, all in a fearful jumble. No wonder I look pale."

ELECTRIC TRACTION IN 1850.

NOT many men have seen the toys of their youth grow into useful products and blossom out into world wide reaching industries, as has Dr. John H. Lillie, of Los Angeles, California, who, as far as we are able to investigate the annals of what now is ancient history, seems to be the pioneer electric railway inventor in America. Contemporary with the experiments of Morse in telegraph, Dr. John H. Lillie, then residing at Joliet, Ill., was deeply engaged in electrical experiment, the most satisfactory of which was an electric traction motor, the subject of the present sketch.

It was not until 1850, however, that the patent office issued the papers which recorded as No. 7,287 the allegation of an improvement in "electro-magnetic engines." The title page of this interesting document is reproduced here, and may be the subject of curiosity to the holder of patent number four-hundred-thousand-and-something, if for nothing else, to show the tremendous strides of American electrical industry since this yellow and faded sheepskin, No. 7,287, grew on the back of a frisky spring lamb of 1850.

The text of the patent proclaims that the said Lillie has invented a new and useful machine for electro-magnetic power.

In brief, the invention consists in the employment of a number of permanent horse shoe magnets, compound or simple, revolving on a wheel in front of an electro-magnet fixed stationary to a frame. Around the outside of the electro-magnet was a helix of fine wire, "producing other electro-magnets and destroying secondary currents in the first magnet." The construction of the machine was very simple, being a series of permanent compound U magnets placed in a wheel in a radial position, the poles projecting beyond the periphery of the wheel. On one end of the axis of this wheel there was a larger spur wheel driving two pinions. Break pieces, or commutators, were attached. The frame supporting the wheel held two U-form electro-magnets, which were on a line

radial from the shaft, one on each side. Around the coils on the magnet were fine wires which secondary coils were connected to the electro-magnets "to be magnetized by means of, and for the purpose of also destroying the secondary currents." The magnets were placed to aid in the propulsion of the wheel. The break piece was in two parts, one half being a conductor and the other a non-conductor. The conductor half was connected by means of a spring with the opposite cut off shaft so as to be thrown alternately onto one or the other

of two insulated break pieces, by which the current was made to pass in one direction or the other through either of the coils. One break piece was connected with the battery by means of a spring through a binding screw. The other break piece was connected with the opposite binding screw by another spring. One end of each of the two primary coils was connected by a wire with the break piece, or "current changer," by means of a spring. The other end of these coils were alternately connected with the spring to close the circuit by means of a spring device. In the quaint phrase of the letters patent it is stated: "By this arrangement it will be seen that the electro-magnets are charged with opposite poles to the permanent

magnets, and when the magnets are opposite their centers the poles are changed by the revolution of the brake piece and the permanent magnets are repelled. It is necessary to have the permanent magnets long, otherwise their poles will be changed by a powerful current in the electro-magnets."

The claim of "newness" made is, first, the employment of induced electricity, inducing electricity in the secondary electro-magnets to be used as motive power in connection with the prime mover, and to neutralize the secondary currents of the principal magnets formed by the direct current from the battery.

The venerable inventor of this old-timer is now a resident of Los Angeles, Cal., at the age of 80 years. His

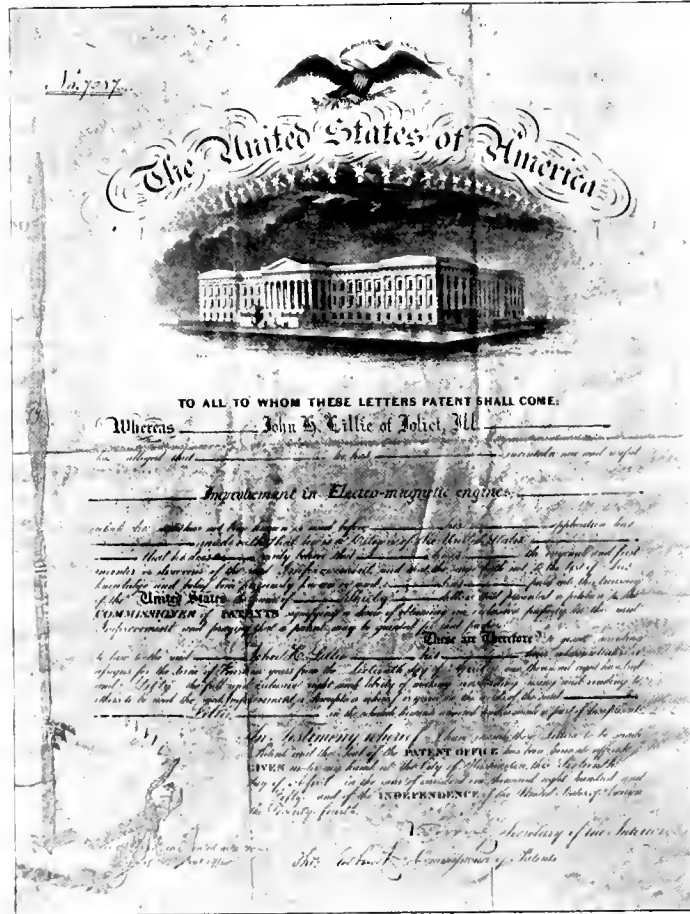

DR. LILLIE'S PATENT OF APRIL, 1850.

birth place was Montrose, Pa., and his medical degree acquired at Cincinnati, O., in 1838, where his first interest in electricity was aroused. His electrical work began with some interesting designs in testing instruments, making a delicate electrometer with which he substantiated his belief in the electrical origin of cyclones. He besides dipped into electro-therapeutics. Electric lighting and insulation also claimed a part of his interests, although he prosecuted none to commercial usefulness. The electro-magnetic engine above sketched, however, was the most interesting of these affairs. In 1850 a 12-foot circular track was built at Hornellsville, N. Y., his then residence, and upon it one of his engines was placed. Later he built another and much larger one for P. T. Barnum, the great showman, which was exhibited in many places and attracted much attention. A little later another on a larger scale was built at the request of Pro-

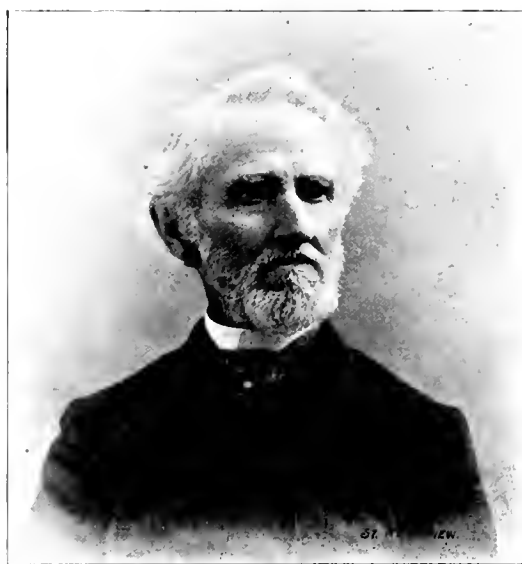

DR. JOHN H. LILLIE.

fessor Henry, the famous curator of the Smithsonian Institute, and exhibited in that collection. The last public appearance of this early motor was at the late New Orleans exposition about eight years ago, since which time the tremendous strides of commercial electricity have overshadowed it.

We take pleasure in showing an engraving of Dr. Lillie, from a photograph taken especially for the REVIEW, and faithfully presenting the doctor's kindly features as he appears in his old age, justly honored.

THE good pastor of the first Baptist church of Minneapolis, Dr. Wayland Hoyt, recently preached a sermon on the efficacy of prayer, and among other things said that he thought a sad lack of the spirit of prayer pervaded the Twin Cities' Rapid Transit Company. Verily, Doctor, there is as little prayerfulness on the part of the company as there is in the remarks of the Minneapolis kicker, and heaven knows the fearful lack there.

ON THE GRIP.

CHAPTER I.

OF all students of human nature that study that class of beings "a little lower than the angels," the street railway man on the back or front platform has the most abundant opportunities. The book agent's chance of seeing fifty people a day fades into insignificance before the hundreds that touch thumbs with the conductor or hail the driver several thousand times each year.

To the street railway employe the fair sex has the greatest possibilities for observation, and at a late meeting of the literary club of the Chicago City Railway, A. D. Perry, a gripman on the Wabash line, gave the assembled brethren the benefit of his wide experience. Among other things Mr. Perry observed:

We find, with the rest of mankind, that it is next to impossible for a man to argue with a woman to show her the error of her way. After all the logic, all the reason, and all the examples in the category are exhausted she will close the debate by remarking, "I *know* it is so because I *know* it's so." On this point she will stand out against Webster's dictionary and the powers that be, and the wisest course for a man to take is to drop the subject.

I think the reason for this is that a woman has an inborn idea that a man is her natural and hereditary enemy and thinks that any display of the guiding hand or necessary authority is nothing more or less than an attempt at tyranny. This is one of our most serious troubles, for no explanation can smooth the ruffled feathers of wounded pride. Next on the list is a woman's superior knowledge. It may be due to the century in which we live, or to the higher education of women, but one thing is sure; any woman that ever lived knows better how to do any particular thing than any man, or body of men, that ever dared to breathe. These are the general characteristics that cause women to be that which they are just because they are so.

The first noticeable peculiarity of women in connection with street car riding is the rear door attraction. Why a woman persists in making a short-cut for the rear platform to mount a car, I can't see, but she will do it. The women in the car, of course, get out through the rear door where, of course, there stand a half-dozen of other women trying to get on. The conductor may plead, "wait a minute, please, and let these people off." He may at his peril recommend the front door as an avenue into the car. The driver may try to assist the conductor in directing their attention to the forward platform, but the thought of every woman in the crowd is "that horrid man is trying to order us." "Shall he tell us what to do?" So we wait. Oh! that the female mind could grasp the idea that the front door of a car was made for use and not ornament. Oh! that the female intellect could be suddenly enlightened on the old philosophical maxim that two bodies cannot occupy the same place at the same time and still be happy. It would beat Ayer's Hair Renewer in taking the gray locks from our hair.

It is an old tale that no woman can mount or descend from a street car properly, but why a woman who can be so graceful in the drawing-room or at a ball should be so awkward when attempting to get off a car is a puzzle to me. If she attempt to gain time by getting off before the car stops, nine chances out of ten she will swing off backwards on the ground. Of course, she never gets hurt badly in this original ground and lofty tumbling act, but she musses her clothes and her temper, and, oh, what a look at the man who says, "Just like a woman." Having been reared in the country and being familiar with rural affairs, I can only compare a woman's performance as she takes hold of a post on a grip car to a dog's gyrations just before lying down. The dog makes several turns and twists and finally settles, just as the woman does, but with less force. As to jumping off the car, I never saw a man yet who did not gaze with admiration on one of the opposite sex who had learned this feat.

Down near Thirty-fifth street, one day, a young woman rose from her seat on my grip just before the car stopped and swinging out a little moved as if to jump. Four or five men stretched out their hands to stop her as if she had been an escaped lunatic, I yelled, as usual, "Wait a moment, lady," but she was gone; gracefully, and with not a little triumph in her eye she turned towards the car as much as to say, "There, now, just say you saw a woman get off a street car right, once in your lives."

No other accomplishment raises a woman in a man's estimation as quickly as knowing how to get off a car

Many theories have been advanced for this inability of women to retire from a car with grace and safety, but I affirm the reason is that a woman starts for her destination regardless of everything except getting there. If the car would stop so that she would face her destination as well as the grip car she would not get off backwards, but let the car go past her destination but one yard and she turns her face in that direction, with fatal results to her drapery and temper. Then her trail is in her way, and to manage this portion of her clothing takes at least one hand. When they begin to wear crinoline what will become of us? The conductors will be continually reported for crushing dresses, and "to sit closer, please," will be a physical impossibility. There might be a volume written on the subject of getting off a car, but our time is too short.

A man's ability to get off a car is his particular pride, but every woman that travels on a street car has a faculty that not one young man in a thousand can boast—but that must go over until next month.

THE University of Minnesota course in electrical engineering is coming to be considered as among the best in the country. This is owing, mainly, to the efforts of Professor George D. Shepardson, whose name is not unfamiliar to street railway men, and who is making his institution, favorably situated as it is with a great system near at hand, one of the centers of street railway electrical engineering.

A BRAKE PROBLEM.

A READER of the STREET RAILWAY REVIEW asks the following question:

How many pounds are necessary to stop a 30-inch diameter steel street car wheel having three quarters of an inch flange and two inch tread; brake shoe 12 inches long.

J. Archy Smith, mathematician at Chicago University, sends us at our request the following solution:

If the wheel is to be stopped instantaneously, the speed of the car is practically not a factor of the force necessary to stop the wheel, nor is the shape or size of the brake shoe. The friction at the brake must be equal to or greater than the friction on the rail, plus, of course, the momentum of the wheel itself, which is, of course, insignificant.

If the brake shoe and the rail are of the same material and smoothness, the force applied to the brake must equal the weight of the car.

The distance (in feet) that a car will slide on *dry steel rails* after the wheels are stopped dead is obtained approximately by taking $\frac{1}{4}$ of the speed in miles per hour; or a car traveling six miles an hour will slide about 15 inches, if the wheels are stopped dead.

If the wheels are not stopped dead, the distance that the car will travel after the brakes are put on is obtained from the following formula:—

$$\text{Distance in feet} = \frac{1}{4} \times \frac{\text{Weight of car} \times \text{speed in miles per hour.}}{\text{Weight on brake.}}$$

$$\text{Or weight on brake} = \frac{1}{4} \times \frac{\text{Weight of car} \times \text{speed in miles per hour.}}{\text{Distance in feet the car will travel.}}$$

These formulæ are approximately correct only when the car is stopped in short distances. They do not consider the friction of the car's own machinery.

AN ELECTRIC CAR GRAND STAND.

A COMPANY has been formed at Madison, Wis., with a totally unique object. The scheme is the pet child of Grant Lariber's inventive genius, and proposes an electrical grand stand for race courses.

The stand is to be built with a seating capacity of 5,000 and will be modelled after an electric car. A straight-away track, with as much dip as is allowed by the racing association, will be constructed, and parallel to it the car grand stand will run on three tracks. It will be connected with the starters' stand so that at the fall of the flag, horses, grand stand and all will begin the race simultaneously. Racing will be conducted by night as well as by day. The company which has been formed, it is said, includes some of the most wealthy men in Wisconsin, and \$100,000 in stock has been subscribed. The track is promised to be in operation by July 1, after which Guttenburg, Roby, Hawthorne and Garfield might as well shut up business. All that is lacking is a telephone connection with Chicago to hear the shouts of the traveling grand stand, a set of electrically operated puppets to represent the horses, and an electric pool seller, to make the plan, one to interest a monopoly, and racing interests of the world will be syndicated and settled.

AT THE WORLD'S FAIR GROUNDS.

THE BIGGEST BOILER PLANT IN THE WORLD.

In common with all the other biggest things in the world that will appear on the World's Fair grounds, the boiler plant situated in Machinery Hall gathers about it the full quota of interest due such a magnificent undertaking.

This plant utterly eclipses anything ever seen before in the mechanical world as an aggregation of power producers. The boiler room itself is a well lighted annex to the hall proper. It is lighted from above by a double sky light and has a visitors' gallery running the entire length of the room. Beneath this gallery is space for piping and storage. The length of the room is 850 feet and its width is about 30 feet.

Our perspective view gives a good representation of the batteries as they appear to the eye from a point in the west end of the pit. The other two engravings show

water an hour. Now, turning to the other half of the plant as represented in our engraving, part of the National display is joined by five batteries of Campbell & Zell boilers of Baltimore. Nine of them aggregate 3,750 horse-power and evaporate 112,500 pounds of water an hour. Babcock & Wilcox here join the procession with five batteries of two each, giving 3,000-horse-power and evaporating 90,000 pounds of water per hour. Farther to the west and ending the plant are two batteries of two each of the Sterling boilers of 1,600-horse-power, evaporating 54,000 pounds of water an hour.

The basis of contract made by the exposition managers is not commercial horse-power but evaporation, the price being \$177.75 per thousand pounds evaporating capacity per hour.

The magnificent showing which this immense power

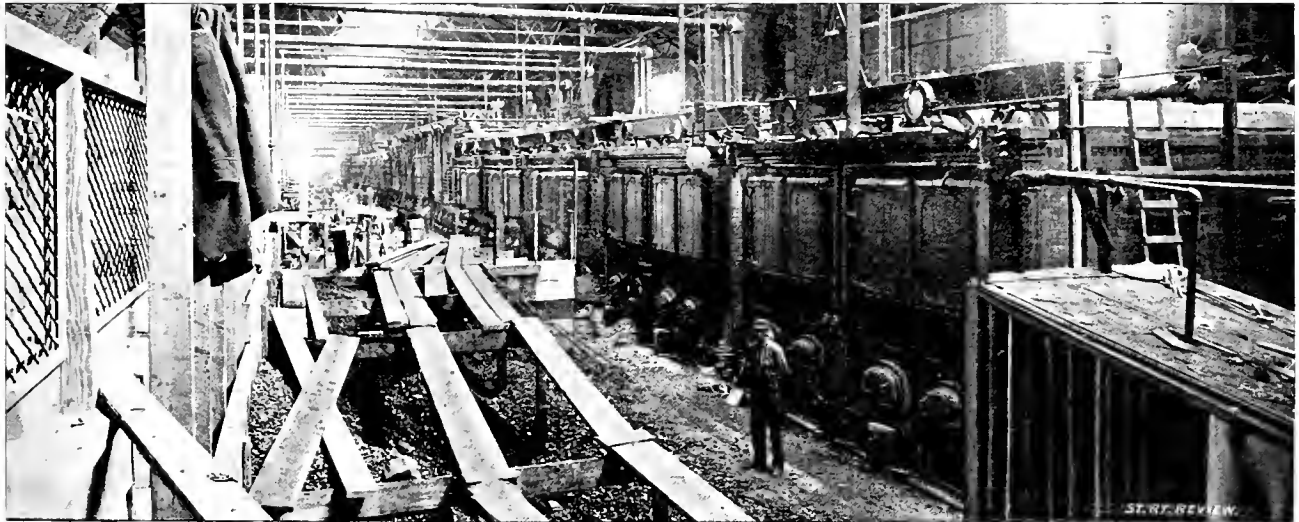

PERSPECTIVE VIEW OF BOILER PLANT SHOWING PIPING SYSTEM.

more clearly the position of each battery together with the details of the piping. Both the latter views are taken from the center of the plant, one looking east and the other westward along this Chinese wall of steel fronts.

All of the boilers are of the water tube type and will be run under a uniform pressure of 125 pounds to the square inch. Fartherest to the east are located two batteries of two Root boilers aggregating 1,500-horse-power. These will evaporate 45,000 pounds of water an hour. Next are stationed two batteries of two each of the Gill type, aggregating 1,500-horse-power, intended to evaporate 45,000 pounds of water an hour. Heine's two batteries of four boilers each come next. They will aggregate 3,750-horse-power and will evaporate 112,500 pounds of water every sixty minutes. Near the middle of the plant and abutting Heine's boilers stand two batteries of two boilers each of the National type, aggregate power 1,500 and evaporating 45,000 pounds of

plant will place before the mechanically-inclined visitors at the Fair will undoubtedly make it one of the most attractive points on the grounds.

THE OIL FUEL SYSTEM

in use is also on the largest scale, and several burners have been invited to attend this heating jubilee.

The Standard Oil Company agrees to furnish all the oil required at 72½ cents a barrel, delivered each day. All arrangements for the tanks and pipes have been made agreeable to the rules of the Underwriters' Association. The storage tanks are twelve in number and hold 112,500 gallons. Every possible precaution has been taken to prevent accidents, and no trouble is even remotely hinted at by even the most obtuse kicker. All the pumps are located very close to the tanks. From the storage tanks the oil is pumped into a stand-pipe 30 feet high and 30 inches diameter, connecting direct to the boiler, thus maintaining an equalized pressure of from seven to eight

pounds. A feed pump, feed water heater, two 40-horse-power engines, two vertical boilers and two Snow oil pumps are used, one always in reserve. Double suction connections enable one pump to deliver oil to the stand-pipe or boilers while the other is reversing the operation, or in case of accident emptying the storage tank or stand-pipe.

A single 5-inch wrought iron pipe connects the stand-pipe with the boiler house. This is laid in a straight line 3,200 feet, between the oil-pump house and the center of the boiler house. A 2-inch steam pipe parallels the 5-inch oil pipe to the boiler house, for the purpose of keep-

ing the oil liquid during the severest weather. The Nationals have a new design in setting the burner, inclining it a little downward, so that the flame is directed well into the arch. A header of 2-inch pipe is run over each battery of boilers, from which the burner connections are taken off. These headers are provided with separate 1½-inch connections, with the boilers independent of the main steam connections, and the headers over each battery are cross connected by a 2½-inch pipe running the entire length of the boiler room, so that if any boiler has been shut down it can be started from any other in the plant.

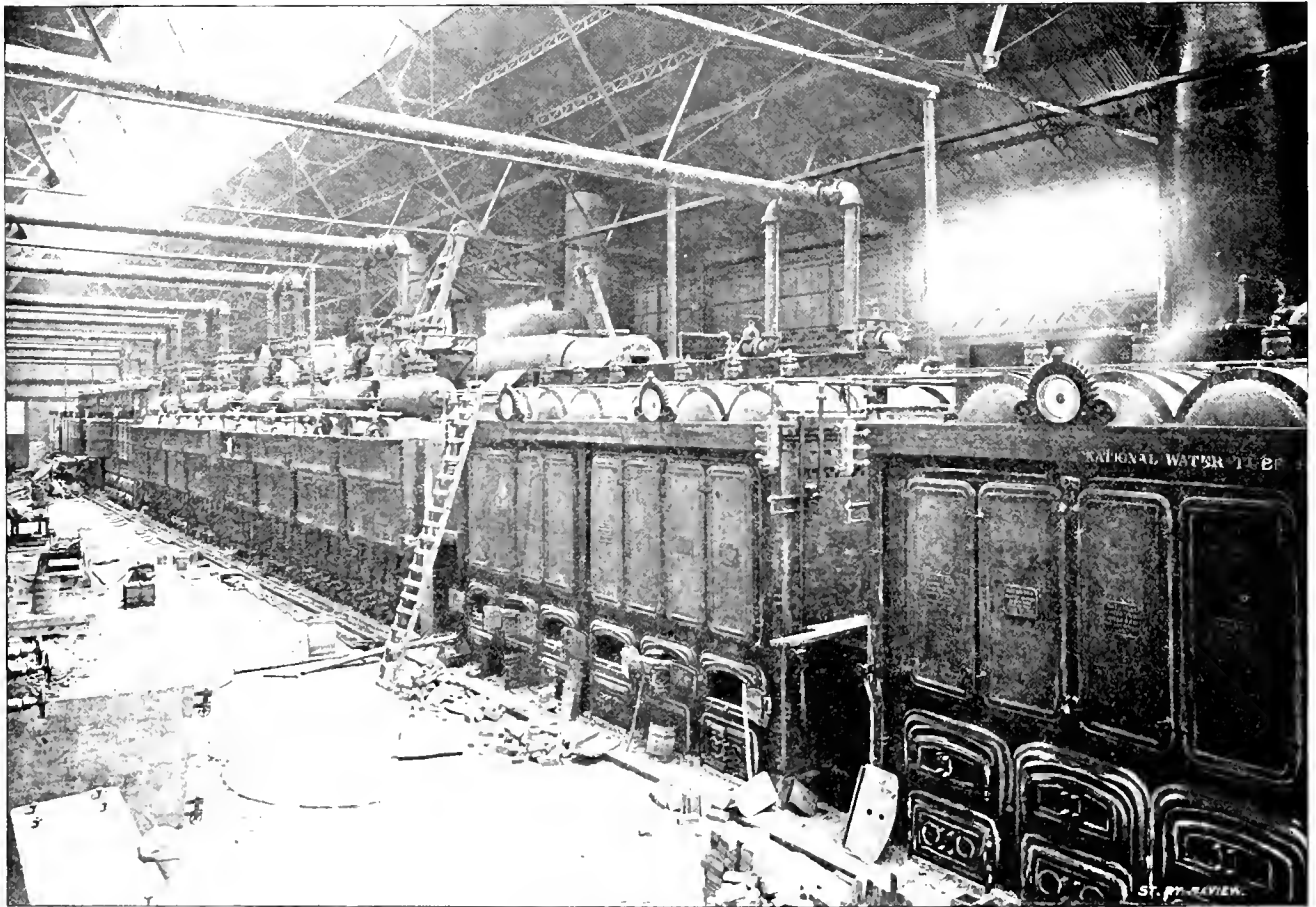

EAST HALF OF BOILER PLANT.

ing the oil liquid during the severest weather. A small steam coil is also placed in the storage tank.

At the boiler house the supply pipe branches, running in both directions, with off shoots to reach battery of boilers. The main is laid in a wooden box, covered with removable iron plates. Each boiler maker has the right to select his oil burning system, with the approval of the engineer. So far, it is known that the Root, the National and two of the Heine boilers will be supplied by the Reed burner. The Armstrong burner will be put on all of the four Gill boilers (Stearns Mfg. Co.) and the International on two of the Heines'. The Hydro-Carbon burner will probably be represented. On the National and Gill boilers the burners are placed inside the fire door, and all

THE PIPING SYSTEM

is now already finished, and is as mighty as befits this mammoth plant.

EXHIBITS AT THE TRANSPORTATION BUILDING.

Exhibits now qualified and ready to come out of durability in the warehouses are more numerous than last month, and include the following firms, together with the nature of their displays, as corrected to date by T. Hacksworth Young, of the railway department.

J. L. Pope, Cleveland, pressed steel elevated railway tackle block; Porter Tramway Switch Company, Cleveland, switch, track and motor; Reliable Manufacturing Company, Boston, patent sand box; Standard Fireless

Engine Company, Chicago, ammonia motor; Genett Air Brake Company, air brake; International Register Company, fare register; Johnson & Co., Johnstown, Pa., rail and appliances; J. M. Jones' Sons, West Troy, N. Y., two electric street cars; Geo. M. Ludlow, Elgin, Ill., model of electric railway car; McGuire Manufacturing Company, motor truck; Morton Steam Heating Company, Baltimore, Md., storage steam heater for street cars; Jasper Murray, Cleveland, O., anti-friction street car brake; A. O. Norton, Boston, screw jacks for street car shops and barns; Pullman Palace Car Company, street cars; Robert A. Parke, New York, compressed air street car; Peckham Motor Truck & Wheel Company, Kingston, N. Y., electric motor truck; Price Railway Appliance Company, Philadelphia, track construction; Snider Combination Car Company, Chicago, car; Steel Motor Truck

Naptha Motor Company, Englewood, Ill., street motor; Geo. Craddock & Company, Wakefield, England, samples of new and worn cable; Duplex Track Company, New York, track; Elevated Suspension Electric Railway Company, Chicago, model; the Frost Veneer Seating Company, New York, seats. The list is rather shortened by a division of display with the electricity department and the number of displays made in connection with rapid transit specialties on the grounds.

Germany and France are the only foreign nations asking admission to this department and their exhibit consists mainly of various types of steam motors.

THE MACKAYE SPECTATORIUM.

It was many years ago that Wagner attempted to stage his operas on a scale of magnificence never before

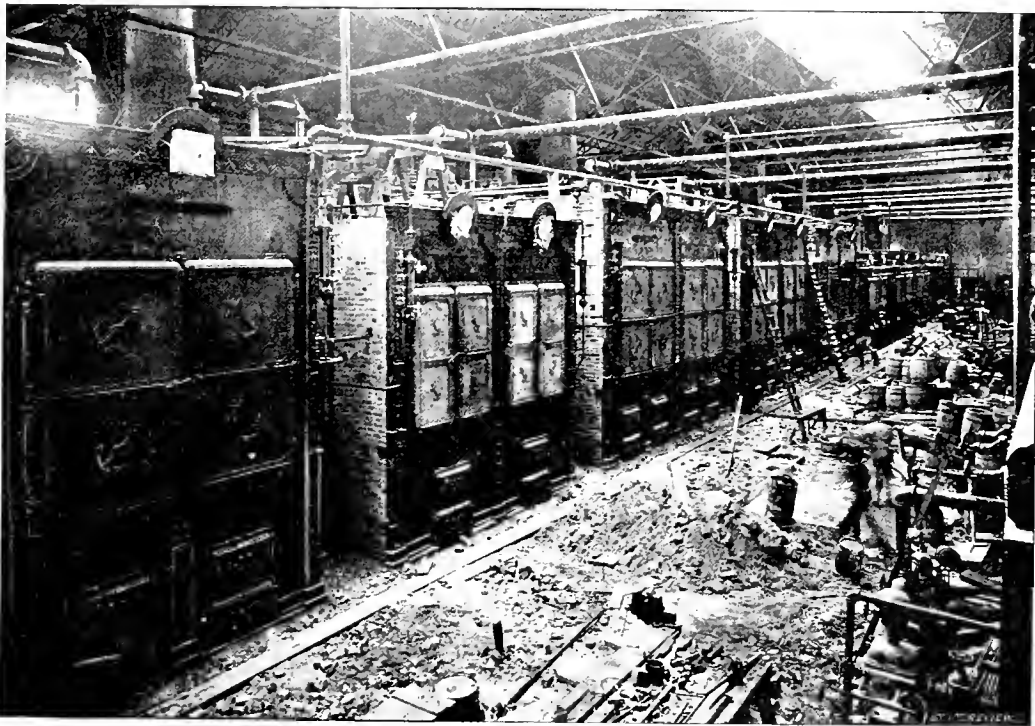

WEST HALF OF BOILER PLANT.

Company, Cleveland, motor and gear; John Stephenson & Co., Ltd., New York, one cable, one electric car and appliances, historical photographs; St. Louis Car Company, St. Louis, car and car wheels; Thomas & William Smith, Newcastle-on-the-Tyne, England, cables; Taylor Electric Truck Company, Troy, N. Y., electric car truck; B. E. Tilden & Co., Chicago, motor replacer and wrecking outfit; Harris A. Wheeler, Chicago, street car seats; E. H. Wilson Co., Philadelphia, two street cars, gates and equipment; Wm. Wharton, Jr., & Co., Philadelphia, street rail material and track.

Albert & J. M. Anderson, Boston, electric railway, fixtures and specialties; Bass Foundry & Machine Works, electric motor castings and machinery; Brownell Car Company, St. Louis, cars and appliances; Cushion Car Wheel Company, electric motor car wheels; Chicago

attempted. His partial success was due principally to the insufficiency of the mechanical arrangements. In the Columbian year, however, science, art and mechanics has so far advanced that the most stupendous illusions are attempted without the slightest misgivings.

The McKaye Spectatorium will be without doubt, next to the Fair itself, the greatest drawing card near Jackson Park. This marvellous attempt is thoroughly backed by Chicago's solidest men, planned by Steele MacKaye and finished in the mechanical details by the Hill Clutch Works, of Cleveland, under the direct supervision of H. W. Hill, with his extensive theatrical knowledge coupled with a complete knowledge of mechanics.

The spectatorium proper will be a series of revolving views, representing among other things the Columbian panorama. No ordinary stage "business" will suffice for

this greatest show on earth. The winds are real pneumatic wonders, the rain descends in aqueous torrents, the mountains are 80 feet high. The companion ships of Columbus are life size models and Columbus plants real corn in real ground. Sunlight, twilight and starlight, in their succession grow on the gazer's mind and eye. To come down to cold facts the idea will cause the investment of \$1,000,000. The seating capacity of the construction will be 9,000, with a building frontage of 480 feet. The stage is the sector of a circle 700 by 130 feet. The scenes will be driven on cars over 14 tracks at a slow speed, as over 600 tons of scenery must be moved

direct current circuits, and excited the greatest interest of those believing in the future of the arc lamp under such conditions.

The Mosher Company, whose factory and offices are at 125-127 E. Ontario street, Chicago, have received flattering testimonials as to the substantiation of their claims.

The lamp is provided with a compound rheostat and cut out. The rheostat is mounted on the lamp, one winding being a very low resistance and in circuit continuously. The other is equal to the resistance of the arc of the lamp when burning, and is automatically cut in circuit, when for any reason the arc is broken.

G. L. Reiman, president, and John A. Mosher, inventor, were at the convention with this new and attractive light.

STREET RAILWAY PATENTS.

Selected list of patents relating to Street Railway Inventions, granted during the past thirty days, reported especially for the STREET RAILWAY REVIEW, by Munn & Co., Patent Attorneys, 361 Broadway, New York, N. Y.

ISSUE OF FEBRUARY, 14, 1893.

Removable caps for street railway rails, J. A. Eno, Newark, N. J.	491,538
Tram car, John Stephenson, New York, N. Y.	491,608
Electric Locomotive, S. H. Short, Cleveland, O.	491,666
Directly connected motor for cars, S. H. Short, Cleveland, O.	491,667
Series system for railways, G. L. Thomas, Brooklyn, N. Y.	491,691
Electric locomotive, T. B. Rae, Detroit, Mich.	491,857
Compressed air motor for propelling wheeled vehicles, J. Kames Philadelphia, Pa.	491,892
Cable grip, A. O. Babendrier & F. P. Davis, Baltimore, Md.	491,934
Car brake handle, C. D. Lyon, Lynn, Mass.	491,969

ISSUE OF FEBRUARY 21, 1893.

Electric motor and controlling apparatus for cars, J. V. Capek, New York, N. Y.	491,982
Electric railway trolley, A. Dickinson, Darboston, England.	491,988
Turn table, G. Van Wagenen, New York, N. Y.	492,069
Apparatus for shipping and unshipping cable car grippers, J. H. Pendleton & C. Tiers, Brooklyn, N. Y.	492,103
Conduit railway, F. B. Rae, Detroit, Mich.	492,106
Supplementary truck for street cars, B. Price, Brooklyn, N. Y.	492,230
Cable gripper, J. Walsh, Jr., Philadelphia, Pa.	492,248
Conduit electric railway, F. W. Brann, Oakland, Cal.	492,265
Street car motor, J. A. Currie, Springfield, O.	492,274
Steel rails for use on common roads, G. M. Ramsey, Clokey, Pa.	492,365

ISSUE OF FEBRUARY 28, 1893.

Closed electric conduit for railways, A. Heiser, Chicago, Ills.	492,398
Car fender, J. Nagle, Clarendon, Ark.	492,423
Electric railway block system, F. O. Blackwell, Boston, Mass.	492,547
Interlocking rail chair, W. M. Brown, Johnstown, Pa.	492,458
Railroad rail and chair, H. C. Evans, Brooklyn, N. Y.	492,464
Tramway switch, J. Y. Porter, Cleveland, O.	492,472
Multiple switch for overhead trolley lines, W. H. Brodie, Brooklyn, N. Y.	492,526
Cable support, G. P. Wern, Brooklyn, N. Y.	492,648
Conduit electric railway, J. H. Bates, Hoboken, N. J.	492,737

ISSUE OF MARCH 7, 1893.

Street car, J. O. Adsit, Hornellsville, N. Y.	492,882
Joint box for the joints of street railways, E. O. Evans, Cincinnati, O.	492,885
Safety guard for cars, N. C. Bassett, Lynn, Mass.	492,932
Truck for electric locomotive, J. C. Henry, New York, N. Y.	493,089
Electric railroad danger signal and bell, P. Seeler, San Francisco, Cal.	493,125
Elevated railway, J. G. D. Tucker, Perrysville, O.	493,142
Trolley wire support, T. E. Head, Toledo, O.	493,212

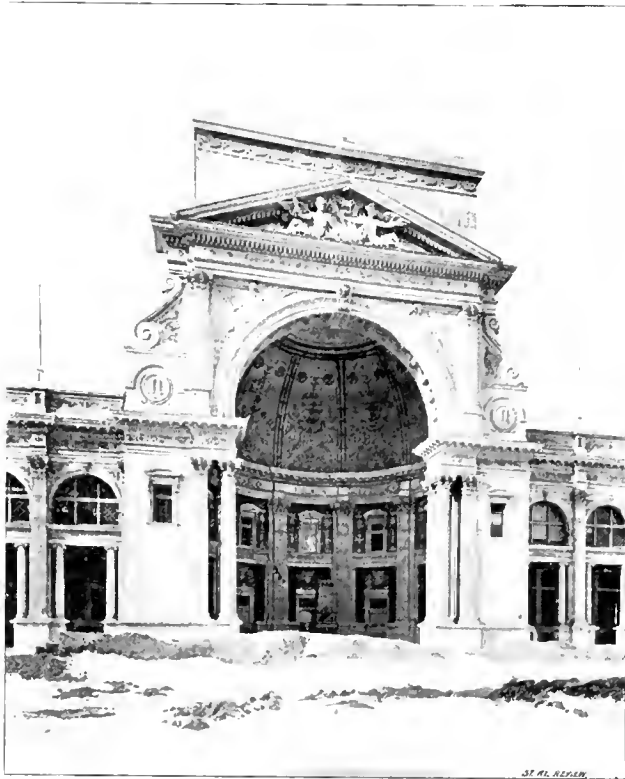

SOUTH ENTRANCE—ELECTRICAL BUILDING.

at one time. Some of the moving scenes will carry as high as 240 people and 40 horses. The governing arrangements will be controlled by one man seated before a number of levers contained in a space about two feet square. The shafting and transmission machinery, of which there will be about 300 tons, will be furnished by the Hill Clutch Works as well as 300 feet of shafting, the most of which will be eight inches in diameter. Thirty-six Hill friction clutches and a car load of cut gears will be required. A 300-horse-power Hamilton-Corliss will furnish the power.

THE MOSHER LAMP.

ONE of the most interesting exhibits at the late Electric Light Convention at St. Louis, and a particularly attractive display for the street railway men present, was that of the new Mosher clock feed arc lamp, style c, 12. This lamp is adopted for use on

THE INVENTION OF THE CABLE RAILWAY.

Suggested by an Accident—Early Discouragements and Trials—The Trial Trip made at 4 O'clock in the Morning in a Dense Fog—Nearly 700 Miles in Operation in this Country at the Present Time—Portrait of Andrew S. Hallidie, the Inventor.

IT was during the winter months of 1869, that a young man with a kind but determined face paused in his rapid walk to watch an overloaded street car start up one of the steep hills of San Francisco. A cold rain had been falling all the day, and impatient men and women had crowded the little car to its fullest capacity, until there did not seem room even for the proverbial "one more." Slowly and with the utmost difficulty did the five horses start the car, and inch by inch ascend the steep incline—so steep one could with difficulty mount it on foot. When half a block had been covered, one horse slipped on the smooth cobbles with which the street was

He at once set to work to adapt the same system to the propulsion of street cars up the scarcely less steep hills of his city. The proposition called for an endless wire rope, carried underground, but to which a car could be attached or disconnected at will. In one year Mr. Hallidie had worked out the problem to his own complete satisfaction. The next step was to secure the necessary capital to demonstrate that system. As with so many other great inventions, people laughed at the scheme, and nobody could be found who would put a dollar into it. These discouragements only served to make Mr. Hallidie more determined than ever, and at his own expense a



THE FIRST CABLE TRAIN—TAKEN A FEW DAYS AFTER THE OPENING OF THE ROAD.

paved. The driver instantly applied his brake, but with such force as to snap the chain. The car at once began to slide backwards down the hill, dragging the bodies of the unfortunate horses over the stones, until the car reached one of the "levels" of a cross street, where citizens succeeded in stopping it. As the young man assisted in releasing the bleeding, mutilated animals from their traces, he decided that he would not rest until he should have worked out a means which would render a repetition of such distressing scenes impossible.

Mr. Hallidie, for he it was, had already successfully installed a number of "ropeways" in the mining districts of California, by means of which great iron buckets of rock and ore were carried across deep chasms and up steep mountain sides where it was impossible to build bridges or roads.

survey was made for a line up California street between Kearney and Powell, a distance of 1,386 feet, and with the gentle rise of 193 feet. The construction of the line called for a much larger outlay of money than our inventor possessed, and as he could get no financial assistance, the plan was temporarily abandoned.

During the following twelve months Mr. Hallidie succeeded in interesting three men, who alone of his friends and business associates could be induced to lend a hand and even they were full of doubts, and were almost forced into the scheme under the pressure of a strong personal friendship for the hopeful young man. Their names are Joseph Britton, Henry L. Davis and James Moffitt, all of San Francisco. Under their advice a company was organized and Clay street was selected as offering a less expensive opportunity to "try the thing" than California

street. Accordingly a franchise was obtained, a survey made, and the public invited to purchase stock, which they did to the cordial extent of 120 shares, and even these were soon surrendered and thrown back, so great was the force of public opinion, which included the very best engineering talent in the west. Periodical and frequent attacks of fear and discouragement would seize the three gentlemen, and Mr. Hallidie would have to spend hours in convincing argument that the plan would actually work. The property owners on the hill were solicited to subscribe to a bonus conditional on the successful completion of the road and \$40,000 was thus pledged, of which only \$28,000 was ever paid in. Mr. Hallidie, put \$20,000 in the enterprise, every dollar he had in the world, and the three other gentlemen subscribed altogether \$40,000. To

that had to be surmounted, because they have all been surmounted; but, at that time, twenty-two years ago, they seemed quite large, and I do not doubt if I had been less familiar with the problem than I was, and had had less confidence than I did, it might have been many years before the cable system would have received a practical application."

The story of the patient builder forms a most interesting chapter of persevering industry, which we reluctantly pass, with its wealth of historic incident and episode. Suffice it to say the road was a double track, of tee rail laid in cast iron yokes set at intervals of four feet, while the spaces between the bottom and part way up the sides were incased in sheet iron; the upper portion and surface being protected by timbers and forming a tube 22 inches deep and 14 inches wide.



LOOKING DOWN CALIFORNIA STREET, 1893.

this \$60,000 thus raised an additional \$30,000 was secured on a ten year loan bearing 10 per cent per annum.

Meanwhile the franchise, already once extended, was well advanced in its second term, and the cable road still existed "only in the fertile mind of its inventor," and as everybody assured everybody else, there it would ever be. But in May, 1872, the money matters had been finally arranged, and with a light heart and no encouragement, Mr. Hallidie began his great work. Each day brought a new difficulty to solve. Undreamed of details swarmed up out of that hole in the ground until a less courageous man would have been literally buried in that hole. Patterns had to be made for all the machinery, and a hundred other parts, and upon one man rested all the responsibility of ultimate success or failure.

In a recent letter Mr. Hallidie, very modestly writes: "I cannot recount here, to-day, what the obstacles were

Timber protected the slot, which had an opening of seven-eighths of an inch, and was placed on one side of a center line about two inches? The grip was made so that the center of the gripping jaws which took the cable was in the center of the tube, and the slides holding the jaws worked horizontally by means of a wedge attached to a vertical rod worked up and down by means of a screw and nut in a hand-wheel. The heel of the grip had a smooth surface on top, and along the crown of the tube inside a longitudinal timber ran its entire length, and was intended to be used as a safety brake by pressing the heel of the grip up against it, in case all the other provisions for safety failed.

At changes of the grade of the street where the cable was inclined to raise above the surface of the street or strike the crown of the tube, depression pulleys were placed to take the cable. The shank of the grip which

passes through the slot being set off on one side, enabled the heel and gripping jaws to pass under the depression pulleys. The slot being two inches off on one side of the cable, all the grit, dirt and water which dropped through the slot into the tube were prevented from coming in contact with the cable.

The gripping jaws were provided with guide pulleys which were grooved to fit the cable and were placed at an angle so as to lead the cable fairly in between the gripping jaws; and by means of rubber springs these guide pulleys were pressed forward sufficiently to throw the cable off from contact with the gripping jaws when they were temporarily opened for the purpose of stopping the car. These provisions, of course, added much to the life of the cable.

power station at the corner of Leavenworth and Clay streets. They had been up all night watching with feverish anxiety the final hurried efforts of the workmen. Without, the fog was unusually thick, and came rolling in great banks from off the sea. The street lamps were visible for only a few yards, and then faded into the darkness that could almost be felt. Within the power house, furnace fires roared under the boilers, which were already blowing their overload of steam with a spiteful hiss, as though angered at being harnessed to such work.

At last all was ready; the engine moved; very slowly at first, then regularly, and as the tension took up the slack cable the steady hum of the gliding, endless rope was heard. Not a moment was to be lost and the party



A DAILY SCENE AT THE FERRIES—THE TERMINUS OF NEARLY EVERY LINE IN SAN FRANCISCO.

From the above it will readily be seen how perfectly the cable system of to-day was exemplified in this the first one ever constructed. Even in these early days, the sworn enemies of the cable engineer asserted themselves, and two sets of gas and water mains had to be moved. Also several water cisterns used in early days by the fire department had to be filled up. But the track work was completed in 60 days, and the contractors, Martin & Ballard, made their final settlement in July, 1873. In the meantime work at the power house had been as actively pushed, and the cable rope, made especially for the purpose, was in readiness.

But the first day of August was near at hand, on which day if no cable cars were run all rights would expire and everything be lost. Desperate efforts were made, and a little past midnight, on the morning of August 1, 1873, a little party of tired, nervous workers met at the

hastened to the street. The grip car was brought out and long ropes attached to it, the other ends of which were given one turn around a telegraph pole. This was to test the brakes, and after letting the car down a short distance the brakes, which were simply straight levers pressing on the wheels, were found sufficient, with great care, to hold the car.

The moment of final failure or success was now at hand. It was four o'clock, and while the darkness had yielded somewhat the fog was still up to the standard. The party consisting of Mr. Hallidie, his three partners, and a Mr. Campbell, with no little trepidation, boarded the little car. It was crude as compared with the palace cable cars of to-day, but it was the father of them all. One of the most careful employes had been selected to handle the levers. As he peered down into that bank of fog and thought of the unbroken descent of 307

feet in that half mile his courage fled and he tremblingly refused to make the trip. The other members now began to show visible signs of uneasiness. Mr. Hallidie immediately assured them all there was no cause for alarm and quickly springing to the levers picked up the cable, ordered the ropes cast off, and in a twinkling the car and its human freight had dropped out of sight in the clouds below before any of the party were scarcely aware of the start. Steadily but surely that rope let the car down the steep incline; stopped and started at the will of its driver, and altogether behaved in a most gentle and satisfactory manner. Of the event Mr. Hallidie says:

"The operation was an earnest one; there was no frivolity. The while affair was serious; and, when it was done, there was simply a mutual handshaking, and nothing but cold water drunk.

"The people were asleep, and, with the exception of one enthusiastic Frenchman, who thrust his red night-capped head out of the window as we went by on the down trip and threw us a faded bouquet, there was no demonstration.

"It was decided to make a public trip in the afternoon with grip and passenger car, and as the morning experiment had demonstrated the necessity of carrying the car as far as the engine house by the cable, we determined to extend the cable line one block further west from Jones to Leavenworth street; and for this purpose to shut down for thirty days immediately after the afternoon trip was completed.

"In the afternoon the public trip was made—grip and passenger car—the down trip without incident except to test the working of the grip and brakes. A vast number of people was assembled at Clay and Kearney streets, and it was difficult to run on to the turn table from the density of the crowd.

"The method was the same as is now practiced on the Clay street line—of switching the grip car and running it past the passenger car on to the turn table, transferring it to the up track, then running the passenger cars past the dummy and bringing it into position in rear of the grip car and coupling it on to it.

"In running the grip car, too many willing hands helped and swung it around with such impetus as to break a bolt connecting the grip to the frame. This occupied about twenty minutes to repair, during which time many expressed regret that the "thing has proved a failure;" but as soon as it was repaired the people piled into the car and on to the dummy, and hung to the guard strip and windows outside of the car; some actually climbing on top of the car. The car, which was intended to seat fourteen, and the grip car without seats, held on that trip ninety passengers, all anxious to make the first trip.

"Everything went well until the steep pitch above Powell street, of one in five, was encountered, when the car stopped. Feeling confident that I knew the cause of the trouble, I left the grip, and, through the kindness of a friend who drove me up the steep hill in his wagon, I soon reached the engine house and found that the grip pulley, through which power was transmitted from the

engine to the rope, was slipping under the rope, which had been freshly covered with tar and which acted as a good lubricator. Some lime and sawdust were fortunately near at hand, and throwing these on the rope, the car and its load were safely hauled to the top of the hill."

On September 1, 1873, the line was again started up and continued to run precisely as originally constructed until July, 1891, when the road was sold to the Ferries & Cliff House Railway Company, who extended it two miles.

Cable lines followed rapidly on other hill streets until to-day San Francisco absolutely could not part with them. They have made the city and added millions to its wealth and realty.

Chicago was the next to supplant her horses with an iron rope, then Kansas City and Cleveland, Cincinnati, Denver, Pittsburg, Washington, St. Paul, Philadelphia, Omaha, Portland, Tacoma, St. Louis and many others, and more recently Baltimore and New York City. The development of electric traction has undoubtedly forestalled a large amount of what would otherwise have been cable lines, but where there is an enormous volume of traffic, or where the grades are exceptionally severe the cable still holds an undisputed sway and will in all human probability continue to do so as long as any present system lasts.

And how about the father of the cable system? Did he live to enjoy the benefits of his energy and study? He did, and those people who threw up certain one hundred and twenty shares of cable stock lost a fortune. No citizen of San Francisco is more honored and respected than he; and none has done more for that city. As president of the Pacific Cable Railway Company and the California Wire Works, which manufacture steel cables, his time is well occupied, while his name appears as director of a large number of important business enterprises. The Mechanic's Institute of San Francisco on March 3rd 1891, passed very handsome resolutions, expressing recognition of his great services as inventor of the cable system.

And now in the full enjoyment of health and the gratitude of his fellow citizens, and in the prime of life; with a bank account in which his "all" of 20 years ago is but a drop, Mr. Hallidie looks back with just pride and satisfaction on his early struggles, and smiles a kindly expressive smile when he recalls the expressions of well-wishing but incredulous friends who "never thought he could do it."

The original grip and grip car, together with other interesting exhibits pertaining to the cable system, will be exhibited by Mr. Hallidie at the World's Fair.

SUPERINTENDENT HUMMELL, of the Milwaukee Street Railway Company, has entirely recovered from his recent attack of pneumonia. His many friends will be glad to learn of his returned health.

DURING the World's Fair, it is reported, the inventors of car starters and car couplers will hold a convention. Eighteen of the largest hotels have been subsidized to hold the crowd.



ANDREW S. HALLIDIE,
San Francisco.
Inventor of the Cable Railway.

RAIL BONDING AND THE GROUND RETURN.

PART II.

CONTINUING our investigation in near and remote parts of the country, the question of the bond wire and a satisfactory return is found to be much discussed and studied on. In our own immediate territory let us first glance at

MILWAUKEE, WIS.

The old Cream City line was obliged to abandon copper bond wire and use iron. The copper return feeders and supplementary wires which were used had to be placed in a trough and imbedded in pitch. Milwaukee is built on sand.

CHICAGO.

The Calumet Electric Railway, although having a comparatively light traffic, has had a little trouble with its return. The road as first constructed had tram rails bonded with copper. No ground plates or supplementary wires were used. There was a continual trouble with the bond wires eating off in the middle. Since the enlargement of the road last summer the present electrician, W. D. McDonald, has been installing a thorough system of ground plates. A car wheel is sunk every 1,000 feet and a galvanized iron rod driven every block. Permanent moisture is found a few feet below the surface, so that the road has now one of the best returns in the country. At the station six car wheels are sunk. Before the putting in of these plates the fall of voltage at distant points on the line sometimes amounted to 150 volts. The ground plates have reduced this to simply that which can be accounted for by the resistance of the overhead lines. The bonding now being put in is double No. 4 galvanized iron wire connected to the rails with rivets, with frequent cross connections between the rails. So far there have been no signs of corrosion. It would be interesting to know how the copper bonds would last after the installation of the ground plates. However, it seems very probable that there is some element in the soil in that region which is especially hard on copper. Electrician McDonald favors ground plates as against numerous buried copper conductors for a return, unless there is difficulty in reaching permanent moisture. He also prefers rivet to channel pin connection, because a channel pin joint is scarcely ever free from corrosion.

The Cicero and Proviso Electric Railway has been in operation about two years and has had no trouble, though the fall of voltage through the ground return is considerable, amounting at times, Electrician Fuchs says, to fifteen volts. They use single galvanized iron No. 6 riveted bonds, with cross connections between the rails and ground rods of galvanized iron pipe every 1,000 feet. Besides this a car wheel is sunk every mile. At the station, connections to the artesian well furnish a good ground. There have been no complaints from corrosion of water pipes.

BIRMINGHAM, ALABAMA.

J. B. McClary, superintendent of the Railway and Electric Company says:—

“We have had no trouble with our ground return, which is by means of 0 soft copper (bonded to rail with No. 4 soft copper) connected with negative side of generator. We have old car wheels buried in several moist places and at the station. We have had no complaint from water or gas companies. I have been using electricity about eighteen months.

PORTLAND, OREGON.

J. W. Campbell, superintendent of the City and Suburban, says they have used electricity about three years. They bond with No. 4 wire channel pin fastening and use a supplementary wire besides. They found that track bonding alone would not suffice, and are firm believers in supplementary wires, having never tried ground plates. No complaint from electrolysis of pipes.

LOS ANGELES.

The following is from Manager E. P. Clark, of the Consolidated:—

“In reply will state that in our systems we have a ground wire for each track, a majority of which is galvanized iron. On our first line we used iron bond wires and were compelled to renew them within six months, doing so with copper bonds. On portions of this line the ground wire wasted completely and had to be replaced. Upon other portions it appeared to be as perfect as when put in.

“One line of five miles has been simply bonded without any ground wire. From the point at which all lines converge to the power house we were obliged to substitute copper ground wire. We used no ground plates.

“Along the line traversed by the copper ground wire the water mains of the Water Company have given them much trouble in springing a leak, caused by wasted away water pipes; the point giving the most trouble being at the point opposite the power house, where the return wires leave the track.

“We are inclined to believe bond wires made of large copper wire and connected from track to track at intervals are quite sufficient for a return ground, dispensing with the return wire.

“Bonds made of single 0 copper, well riveted through the rails, seem to give excellent results.”

CLEVELAND, OHIO.

Vice President C. W. Wasson, of the East Cleveland Railroad Company, gives the following satisfactory reply:—

“Our road started to use electricity four years ago this present month. We have not had any trouble with track bonding in ground return since we had our road relaid with girder rail; with the strap rail the contact of course

was poor, owing to the fact that the stringers underneath the rail were badly crushed and broke the ground wire, which was laid under the rail. In laying new work where girder rail is used, we first use a copper bond, with $\frac{1}{2}$ inch iron rivet; this is riveted in a hole in the end of each rail; to this bond is soldered a continuous wire, running along inside of each rail.

"These two ground wires are also tied together by a diagonal No. 4 Stubbs gauge copper untinned wire of the same size, which runs zigzag to every other joint. Where there is a double track, every ninth rail the ground wire in each track is bonded together by two or three No. 4 wires run across and soldered thoroughly together. I think it is essential to have the same amount of copper in the ground as is overhead. Some of our lines have no ground plates whatever, only at the power house; their utility depends upon the character of the soil in which they are placed. We have not had any complaints from the gas or water companies as to the oxidization of their mains.

"I believe that the telephone company complained that their lead conduits suffered; this is where the terra cotta conduits are used, but I have been informed that this trouble does not take place when this lead pipe is turned into an iron tube."

ALBANY.

J. W. McNamara, of the Albany Railway, who seems to have a very satisfactory return system on that road says:—

"We have used electricity as a motive power since the 28th day of April, 1890.

"We have never had any trouble in bonding our rails or in securing a good ground return. We discovered that the early methods of bonding were defective, and that the wires connecting the rails were liable to break. We have kept pace, however, with the inventors of bonding wires, and believe that we are now using the best device for connecting ends of rails in use.

"In addition to connecting the ends of rails, we use what is known as the Sabold system of ground rods. It is a system invented by F. W. Sabold, formerly manager of the Western Union Telegraph Company, at this city, and now of Yonkers, N. Y. We drive a galvanized iron rod $\frac{7}{8}$ of an inch in diameter and about 7 feet long, every 30 feet between the rails of our track. Every rail is drilled at a point opposite a rod, and connection is made between each rail and a rod. We find that this is the best method of securing ground return which we have tried. We have on our new lines entirely dispensed with supplementary wires, relying entirely upon the proper bonding of rails and their connection with ground rods, as above described.

"We have no opinion as to what will be the ultimate solution of the problem of securing a perfect ground return.

"We have never had any complaints from water companies or other persons using water mains or gas mains, as to their injury by oxidization or otherwise, by our current."

The following extract from a letter written by Mr. Sabold in answer to the REVIEW'S inquiries, reveals several theories that are radically different from some now in vogue, as to what are the various elements necessary to a good return, and for that reason has interest not only in itself but because in some places where the Sabold system has come into use it has cured telephone troubles and in some cases beaten the return feeder system "at its own game."

Mr. Sabold says:—

"It is an established theory that electrolytic action takes place only where resistance is offered to the passage of the electric current, but at such points the process of disintegration and decomposition of substances is liable to be rapid, especially where the quantity of current is large as in the case of electric railway service, hence the rapid deterioration of wires laid underground and connections with the track rails to form the return circuit. The current, in escaping to the earth through the medium of gas and water pipes and other objects which tend to conduct into the lower strata, creates havoc, rapidly reducing the diameter of the wires and consuming objects encountered in its passage.

"The earth is the natural reservoir to which all free electricity tends, and a current conducted into it will not rise to follow other conductors, but the upper surface or crust of the earth being, at best, a poor conductor, and in some conditions a non-conductor, the current scatters over a large area, seeking, by means of mineral substances, metal pipes, telephone and telegraph wires and cables, to reach the lower earth. Early in the history of electric railways, almost in the very start, these difficulties developed on some roads, and they have increased and become quite general where lines have been in operation for some time. From the point of economy in operation of electric railways this has been a serious matter, as an imperfect return circuit reduces the energy at the car and tells directly on the coal pile.

"The principle of electric railway systems dependent upon the track rails or conductors laid under or alongside the rails connected with one pole of the generator, is wrong and is responsible for the interference with telephone and telegraph wires, the terminals of which are connected with the earth, as well as the injurious effect, by electrolytic action, on underground cables, gas, water and other pipes, as well as for a great portion of the imperfect and unsatisfactory service experienced by the railway companies themselves. The metallic circuit thus formed is defective in that one-half of it rests on the earth and the current is allowed, nay cannot be prevented from so doing, to leak into the earth along the entire length of the railway escaping, by means of damp earth, minerals, pipes and other conducting substances leading into the lower earth. The resistance of the circuit and, consequently the strength of current available at the car, varies as these leaks increase or decrease. The extent to which this current will scatter is probably best shown by its effect on telephone wires, which it will follow for a mile or more to reach the earth at the distant end. There

are, plainly, but two ways of avoiding these troubles; one, by completing the metallic circuit overhead, requiring a double trolley, and the other, with a single trolley line, to secure perfect contact with the earth immediately under the car, that is by a path offering no resistance, so that all the electricity set free at that point will be absorbed by the earth. The resistance of the entire circuit will then depend only on the overhead portion, insuring the maximum energy at the car. The track rails should never be connected direct with the generator."

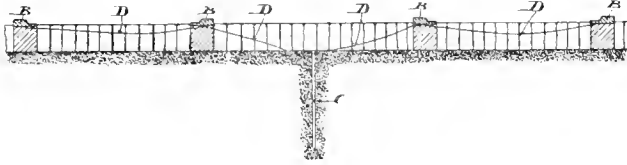

The accompanying cut shows the manner of connecting in the Sabold system.

BOSTON.

Some experiments in this field have been tried by Chas. H. Morse, the superintendent of the fire alarm and police telegraph systems of Cambridge, Mass. Mr. Morse had found that in various parts of Cambridge the power currents of the West End Railway Company, escaping from the return wires to the water and gas pipes, have prematurely corroded these pipes.

In a recent interview upon the subject Mr. Morse has said: "When I took charge of the Cambridge fire alarm and police telegraph system, some time ago, I found that men under me were having a good deal of trouble in discovering grounds, that is, contact of the fire alarm wires with other wires. Upon investigation I soon learned that the railway currents did not have a low enough resistance path upon which to return to the power station. Accordingly in April, 1892, I notified the West End company that its return wires were not sufficiently large to prevent leakage into the earth, and interference with the electric currents on other wires. The company then began to put in overhead return wires upon its principal lines.

"About two months ago water pipes near the company's power house in East Cambridge began to show leaks, and the office of the water board received constant complaints of the rapid decay and loss of these pipes. The matter was investigated, and the pipes showed electrolytic action. It appeared that galvanized iron, rustless iron, brass, and even lead pipes had all been tried in vain. Pipes would last only from one to three months, irrespective of the kind. Since then chip-stone and drain pipe have been successfully used to protect the metal pipes from the action of the electric currents.

"Regarding the actual escape of the electric current from the return circuit into the ground, we made some discoveries which may be thought surprising. For example, a number of tests which we made with suitable instruments showed a difference of potential of over 40 volts between water pipes in East Cambridge and Cambridgeport. Gas pipes showed practically the same difference of potential between these two sections of our city.

In some parts of the city water and gas pipes on the same premises, even, showed from 5 to 10 volts difference in voltage. Workmen relaying pipes have also seen arcs formed at the joints, and in some instances the electric current has actually set fire to the hemp packing used in the joints.

"To remedy these troubles the West End Company is now running many overhead return wires; and it is hoped that when the overhead system of returns is completed the injurious effects of the electric currents upon the pipes will not be noticeable."

If, as is represented, a difference of forty volts was found between one locality and another, the reason for the action of the current on the pipes is manifest. Forty volts represent a loss of energy in the return amounting to 8 per cent. This means a high resistance between points on the track and the station, and it is not strange that a large amount of current should take to the pipes along the line. Mr. Morse's tests are valuable as clearing up much of the mystery that often hangs around electrolysis of return conductors, and shows that what is often blamed to the soil is really due to a poor return.

THE MORAL.

One lesson thoroughly taught by this compilation of experience is the necessity of thoroughly studying the conditions of soil and climate before installing a system of ground returns. What is a good return in a wet region is absolutely worthless in a dry, and a metal that will last years in one soil will soon disappear in another. The experience of a few roads in the locality is worth more to the installing engineer than the experience of hundreds in another part of the country.

TESTS AS TO RESISTANCE.

As electrolysis by the return current in any given soil is in direct proportion to the energy wasted in the ground return, it is expedient, both on account of the coal pile and the life of the return conductors to make the resistance of the return as low as possible.

After determining by observation on neighboring roads the metal best suited to the soil, it is in order to consider what method, if any, in addition to the rail bonding, is to be used to provide the lowest possible resistance between points on the track and station. So then, unless it is considered expedient on account of electrolysis, to run overhead or insulated feeders, the available methods are reduced to the ground plate and the bare continuous metallic buried return. In this connection the results of tests are interesting. Of course in a dry rocky soil the ground plate method is practically out of the race, but in other places the question is still open. Unfortunately many of those who have made tests on the return resistance have kept them to themselves, so that the profession is still in a state of comparative ignorance on the subject. One rough test that shows the absence of any appreciable return resistance is the non-disturbance of local grounded telephone lines.

At Troy, N. Y., and other places where the ground rod system is used, we understand that the telephones

give a silent testimony to the practical absence of resistance in the return circuit of the railways.

In reply to a letter asking for tests on the resistance of wet earth, F. W. Sabold, from whom we quoted before, says: "There is no question as to the conductivity of the earth. All electrical tests and measurements made since Prof. Morse, fifty years ago, discovered that his second or return overhead wire was superfluous, show that any resistance encountered in the ground portion of a circuit is at the points of contact with the earth. Telegraph circuits are operated altogether on this principle, and it matters not whether the terminals of the wire are connected with the earth one mile or a thousand miles apart, the total resistance of the circuit depends only on the resistance of the wire or overhead portion. Galvanometer tests made by the Albany Railway Company, Albany, N. Y., showed that there was no resistance in the ground portion of their circuit between the power house and various points along their line distant from the power house; this proved simply that they had formed a perfect connection with the earth and, I am pleased to say, through the medium of the groundrod. Such a test, I remember, was made at one time when their power house was a mile away from their road at the nearest point, with no connection between but the earth."

WATER PIPE CONNECTIONS.

There is also apparently a great difference in opinion on the practice of connecting to water pipes. In one case which recently came under the REVIEW'S notice, a connection was made to water mains at a single place by a small road having no ground plates and depending on the rails and bonding for a return. The pipe was eaten off near the connection. The cause in this case was not far to seek. The pipe connection acted as a ground plate and as it was the only one on the line the escape to earth through it was considerable. Water and gas pipes manifestly act in two ways. They serve as ground plates if the soil is wet, and as simple conductors from one point to another if it is dry. Thus we hear it said by some that such connections eat off the pipes and by others that it tends to produce loose joints. Corrosion of pipes where there is no metallic connection to them has been before shown to be the result of a return of too high resistance. The conductivity of water pipes cannot be high, as the actual sectional area of the metal is not great.

ELECTROLYSIS AND BONDS.

Several chemists with whom we have had conversation agree in the opinion that in the case of copper bonds there are probably two kinds of action: one due to the flow of current from the bonds to the ground, which is always caused by more or less resistance and consequent loss of energy in the return; the other caused by the formation of a galvanic couple or element between the iron and copper in which the moisture of the soil acts as the solution and the iron and copper as the plates of a battery. Unfortunately there seems to be no conclusive proof as to whether the latter action by itself ever causes serious results.

The lines having the trouble from copper bonds are frequently those having a return of high resistance, and consequently one in which the railway current would have considerable action on the bonds. Neither is it fully proved that copper will not under any conditions last long enough to pay for putting in, even in the most troublesome soils. That iron bonds are not worth much in salty soils may be considered as settled, and as iron is but a poor conductor, this fact is not to be seriously regretted. That copper has undoubtedly given more trouble in some soils than others cannot be denied, but as far as the evidence goes at present it is yet to be shown that copper will suffer seriously in any soil provided there is a thoroughly good return. Additional evidence may, however, prove that copper is absolutely unfit for use in some soils.

CONDUCTIVITY OF RAILS AND BONDS.

A point which has been touched on before, but which is, nevertheless, one that does not seem to be sufficiently realized, is the conductivity of the rails in comparison with supplementary copper wires. A 70-pound rail has a sectional area of about 6,000,000 square mils, making its conductivity equal to approximately 1,000,000 square mils of copper conductor. In other words, it would take ten No. 00 copper wires to have a conductivity equal to a 70-pound rail. The efficiency of heavy bonding as against supplementary wiring is easily calculated. Suppose a mile of single track with 70-pound, 30-foot rails, to be bonded with No. 00 copper wire, each bond three feet long and the connections perfectly made. This is supposing a very favorable case, as we think most electricians will admit. The resistance of the rails alone allowing nothing for joints will be about .02 ohm, and that of the bond .018 ohm, or nearly equal to that of the rails. If such a track were insulated from the ground, so that all the current had to return through the rails, nearly one-half the energy lost in the return would be lost in the short bonds connecting the rail ends.

IN CONCLUSION.

At this point it may not be amiss to comment briefly on the methods used and the lines along which different roads are working at present. It seems rather strange at first thought that the experience of those who have been wrestling with this problem should lead them to such opposite conclusions, as to the way out of the difficulty. On the one hand we find a large number advocating the use of a large amount of copper underground, or in some cases overhead. There ought to be as much copper in the return as in the trolley feeders, they say. On the other hand there are those who say that we have in wet ground an infinitely better conductor than any that can be otherwise provided. All that is necessary then, they assert, is to make a thorough contact between points along the track and permanent moisture. As the ground has infinite conductivity, it is useless to supplement it by a metallic conductor. As upholders of this idea may be cited, the author of the article entitled, "An Argument for Ground Plates as Against a Continuous Copper Return," in our February issue, and F. W. Sabold quoted above,

Now the question arises as to the cause of this difference of opinion. The argument of the ground plate or rod advocate is unquestionably sound as far as it goes, for the resistance of wet earth is without doubt as low as is claimed. The experience of several roads depending on the ground entirely for a return has proved this unquestionably. From the evidence at hand now there are apparently two reasons why the latter theory is not more universally accepted and acted upon. One is that there are certain regions having a dry rocky soil where frequent connections to permanent moisture are either impossible or so difficult to obtain that expense prohibits them. Those operating in such soil, are perfectly justified in advocating plenty of metallic return conductors. The other reason as to why the ground is not more popular at a conductor appears to us to be the insufficiency of ground connections in places where it has been tried and condemned. We say it appears so from the evidence at hand, and are open to any new information on the subject, and would be glad if this statement would stir up enough opposition from some quarter to bring about a more thorough discussion of the matter. Permanent moisture is so short a distance below the surface in the majority of American cities, and wet earth has proved such an efficient conductor in some places where it has been thoroughly tried, that there is apparently justification in giving it a much more universal trial than it has had as yet. It seems to have been the practice in some cities to put in a few ground plates, and as the traffic increased, and they proved insufficient, to condemn them and to begin to put in copper feeders, instead of increasing the ground connections, as would seem to be the more reasonable proceeding. As electrolysis of the bond wires (in so far as it is caused by the return current, and not by the formation of a galvanic element between the bond and rail) is the result of the flow of current from the bond to the earth, the most rational way to prevent it is to make another and better path whereby the current may get to earth. The more frequent the ground connections the better. The REVIEW does not wish to pose as the champion of any particular system against all others, but with the present light on the question it simply wishes to say, give the ground plate and the ground rod a good, fair chance. A system half tried is not tried at all. If, with a return of exceedingly low resistance, there is still trouble with the bond wires, it is then, and not until then, time to blame the soil with it. Whatever the soil it is manifestly unreasonable to expect good results in the way of freedom from electrolysis until the return resistance is made very low. The accomplishment of this end has open to it two means, the continuous metallic conductor and the wet earth, and it is for the installing engineer to consider as to which is the most economical and reliable of the two. If it is found that it is impossible to maintain ground plates, even when a large area is exposed, on account of electrolysis, the only way out of the difficulty known at present is to run insulated return feeders to points along the line, though even then there will be a slight action on

the bonds. Bare underground feeders will fare no better than ground plates in such a soil.

The REVIEW hopes to present its readers with more information on the question in the near future, and meanwhile would be glad to receive from its friends any new ideas on the subject, provided such ideas are backed by facts or by actual experience.

ANOTHER SUSPENDED CAR SCHEME.

A COMPANY of Chicago capitalists are reported as having taken hold, in good faith, of the L. Johnston elevated road, a model of which was seen last summer at Wentworth avenue and Sixty-fifth streets, and adverted to by the REVIEW. The system is of the suspended car pattern, a plan that has so far been found entirely wanting in practical uses. In the first place the structure must be as strong in proportion to the weight as that of an ordinary elevated. Secondly, the structure must be higher to admit of the under running car and the danger of derailment and breakage of support will be much greater. The power to drive the cars will be every pound as great as in usual elevated line, of the same capacity. The Johnson system claims to be able to build at a cost of \$40,000 a mile. This includes wire cable bents with the posts 150 feet apart. The very dismal failure of St. John V. Day, an accomplished English engineer, backed by the best money in Chicago, to build a similar project, is still in mind. The route proposed is to the northern suburbs, and a speed of 80 to 100 miles an hour is promised with a 12-inch wheel. If our readers will kindly imagine the size of the beam necessary to sustain the weight of elevated trains on the south side, and couple that with a speed of 100 miles an hour, some idea of the impracticability of the scheme may be gained. The simple matter of reversing the position of the car does not change a single strain or principle, while the added height of the structure and the speed proposed are two additional bars. It is to be hoped that Chicago capital can be better occupied.

OPERATING OFFICERS OF THE NORTH HUDSON COUNTY ROAD.

THE new general manager of the North Hudson County Street Railway Company, of Hoboken, N. J., William H. Starr, has made final arrangements for his staff and promulgated his first general order, which took effect February 15. The superintendency of motive power goes to A. Debevoise, who has charged of all repairs, inspection of cars and cleaning, giving duplicate reports to the electrical engineer, A. K. Bonta. The electrical engineer will also furnish daily reports, examine applicants for electric service and superintend the over head construction and rail bonding. The superintendents of horse lines and the trainmaster have their duties carefully assigned, reporting to the general manager.

SOUTH CHICAGO ELECTRIC RAILWAY.

FOR the past few months work has been going quietly on in South Chicago that has resulted in one of the best designed systems of electric traction in the country. Besides having a model plant the South Chicago City Railway has a number of features of special interest. No expense has been spared to make everything first class, and the details have been worked out with great care.

THE LINE.

The track is all 75-pound girder rail. The route covers fifteen miles of street, all of it being double track. In connection with the track laying the company has put down a first-class brick pavement on Ninety-second street for a distance of over 2,000 feet in the business portion of the town. On part of the road on Commercial avenue they repaved along and between the tracks with cedar blocks.

Rails are single bonded with No. 0 copper, channel pin fastening. From Ninety-second street north to

used only on this road. The line is sectioned off according to its liability to injury, the shortest sections being, of course, in the business part of the town.

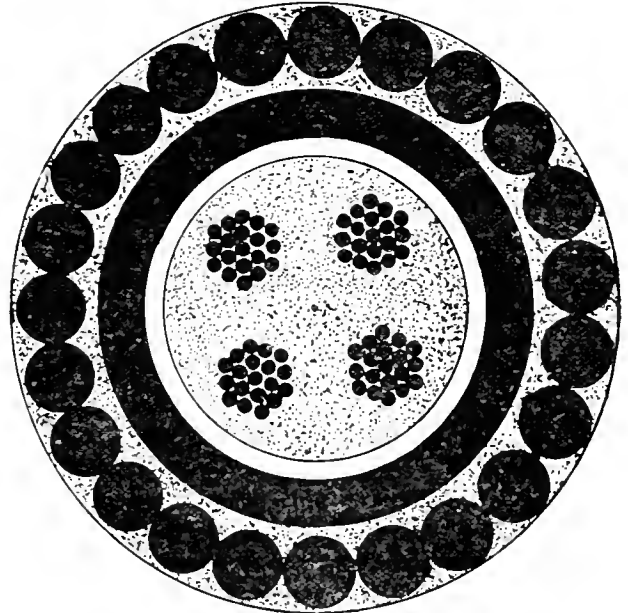

SUBMARINE CABLE—ACTUAL SIZE.

Each section has a separate feeder, and so is independent of all other sections, insuring safety in case of fire. The overhead feeders are calculated to give a max-

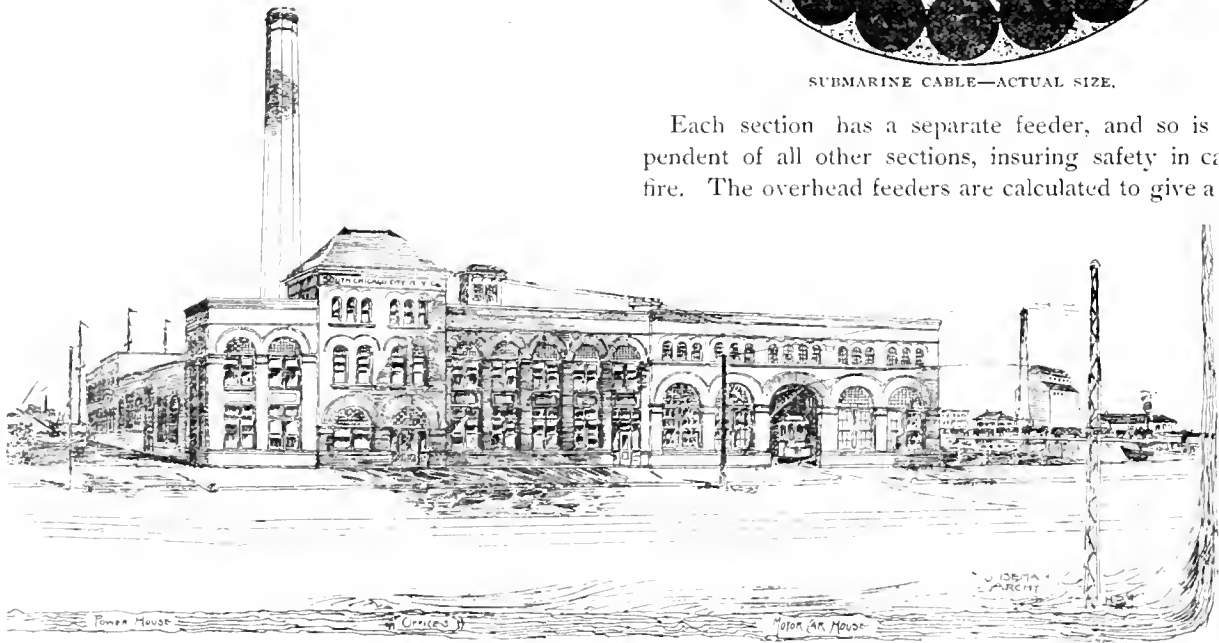

POWER HOUSE AND OFFICES—SOUTH CHICAGO CITY RAILWAY.

Sixty-eighth street every eighth of a mile an old car wheel is sunk seven feet below the surface (this being under water) and connected to the four nearest rails by No. 0 wire. At the station twelve 15-foot rails heavily connected with copper are sunk below water level furnishing an effective dynamo ground. The sand is so loose along the line that all side poles had to be breasted by putting a railroad tie at right angles to the pole, near the surface, and tamping slag and broken stone around the opposite side near the base. Besides this they are set with a 3-foot rake. Eye bolts are used exclusively to hold the span wires, which latter are one-fourth inch stranded, made by Washburn & Moen. The trolley wire is No. 1 copper, held by fixtures of special design

imum loss of about fifteen per cent. At Ewing avenue and Ninety-second street the Calumet river is crossed by a drawbridge. To get its feeders across the company had to resort to

TWO SUBMARINE CABLES.

This sounds simple enough, but when it is stated that there had to be four feeders of No. 000 copper wire in each cable, insulated from each other and from the outside the aspect changes. The cables used are Siemens submarine steel armored made by the Edison Machine Works. When finished they were three and one-half inches in diameter and naturally rather stiff to handle, but they were finally laid to rest in trenches ten feet

deep and four hundred feet long, dredged for that purpose across the river bottom. This was done to get them beyond all possible reach of injury. The trolley line is abundantly supplied with strain plates to admit the taking down of small sections without disturbing the line. The route as now laid out furnishes two lines from Jackson Park to One Hundred and Sixth street, one from Sixty-fourth street by way of Stony Island avenue, Seventy-ninth street and Commercial avenue, the other from Yates avenue and Sixty-seventh street by way of Superior,

THE STATION,

situated as it is at the junction of Ninety-second street and Ewing avenue, with a switch from all the principal roads, running coal in front of its boilers, with the possibility of unloading coal and crude petroleum from lake boats, and with the Calumet river water for condensing purposes, furnishes as good an example of carefully considered location as can be found.

The power station and offices are under the same roof,

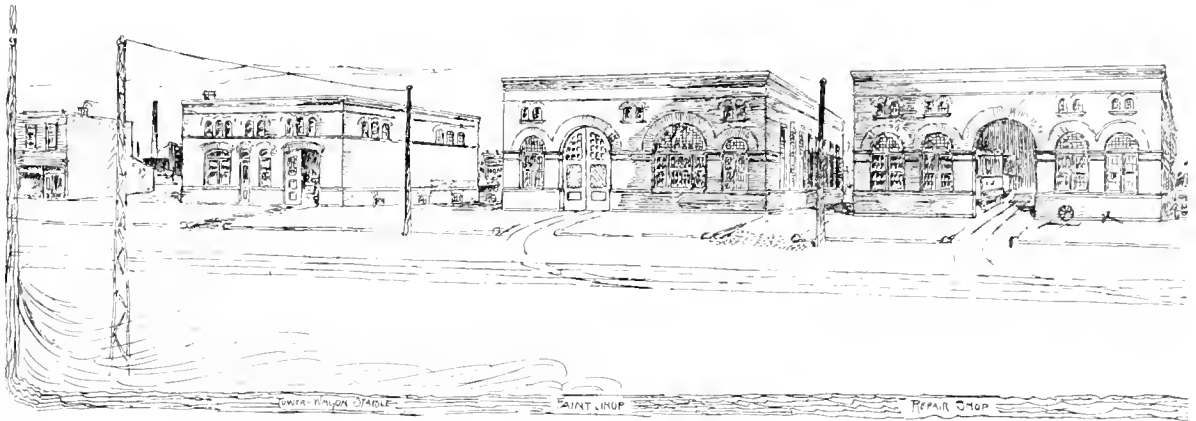

Buffalo and Ewing avenues, with cross lines at Seventy-ninth and Ninety-second streets, and on One Hundred and Sixth street from the Calumet Iron & Steel Company's works to the state line at Indiana, the proposed terminus of the Hammond, East Chicago & Whiting Electric Railway.

CARS.

The present car equipment consists of twenty-five St. Louis Car Company's 18-foot bodies (closed), mounted on McGuire 7-foot trucks, with Griffin 33-inch wheels,

and the car barn is separated from the main buildings by a 17-inch fire wall. This barn is 228x75, with a capacity of sixty-five cars. Tracks are all on trestles four feet high. The offices front on Ewing avenue, as will be seen from the ground plan, and occupy two stories. The power room, behind the offices, at present contains three Allis 22x48 simple condensing Corliss engines, of very heavy pattern. These are belted direct to three Edison bi-polar, 200 kilo-watt generators, by means of Schieren 27-inch perforated belts. The dynamo pulleys are 44-

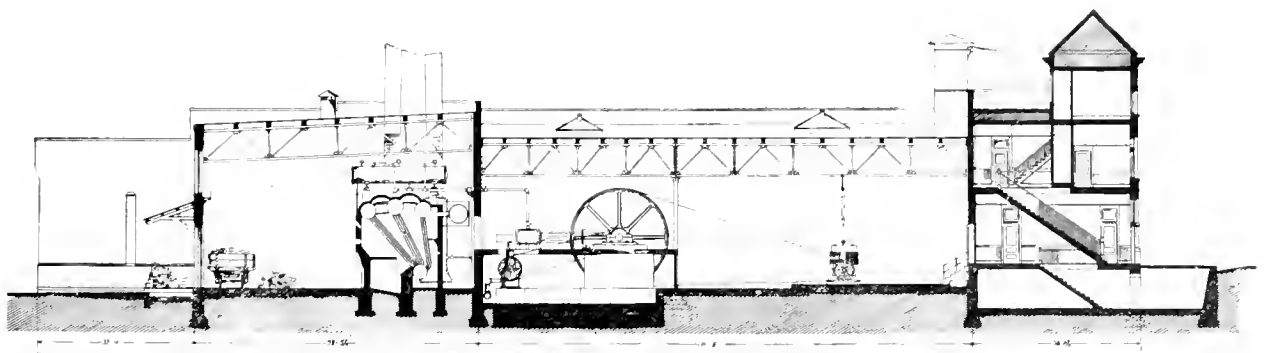

ELEVATION—SOUTH CHICAGO POWER HOUSE

These are fitted with two 25-horse-power, single reduction, Westinghouse motors. In addition, contracts have been let for twenty open motor cars (21-foot bodies) to the Brownell Car Company, and twenty-five open trailers with 25-foot bodies to another well-known company. Trolleys will be the Nuttall with steel poles. Lewis & Fowler stoves will furnish the heat.

inch and run at 450 revolutions. One feature of these units that we firmly believe is in the line of future progress is the use of very heavy built-up engine fly wheels. These are made in eight sections and weigh 45,000 pounds, or 22,000 pounds more than the regular fly wheels for such engines. They are twenty feet in diameter with 30-inch face, running at seventy-eight revolutions per minute. It

will be seen that the engine room has an ultimate capacity of five units. The engine foundations are set on a bed of concrete 100x40 by 5 thick, reaching the whole width of the engine room. On this bed, which is probably the largest one of the kind in the west, the foundations of sewer brick eleven feet high are built. This leaves room for three independent belt driven condensers under the floor.

The boiler room contains three Stirling water tube boilers, each supplied with a live steam purifier. Behind the track in front of the boilers is room for coal storage. The stranded cables from the generators are led off in shallow conduits made accessible by raising sections of the floor. The feeder distribution board, and dynamo controlling board are separate, both being of white Italian marble set five feet from the wall. Every feeder and every machine has a fuse, ammeter, switch and Westinghouse circuit breaker. Besides the station lightning arresters there is a Westinghouse type K arresster every mile along the trolley line. Arrangements are made to reverse the polarity of circuits every three months on account of electrolysis. The general arrangement of the station can be seen by a glance at the ground

plan. The difficulties of construction were very great, both on account of the quicksands on which the plant was built, and because it was originally much below the city grade. The architectural features of the buildings are due to S. S. Beman and need no commendation from us.

The company is also erecting adjacent to their power house, a large and fully equipped repair shop, paint shop and stable.

"THE storage battery is making the singing trolley tremble for its very existence," say the Los Angeles Times. Yes. Tremble with audible mirth.

ICE AS AN INSULATOR.

A SECOND case has come to our notice within the last month in which the freezing of the ground has acted to insulate the rails from the earth and consequently to overload the track feeders. In this case the road was a new one, using of course no ground plates. The man in charge of the station noticed that there was an abnormal amount of current flowing. Suspecting the cause he dug down to the track feeders and found them

red hot. A few minutes more and they might have melted, causing a shut-down; all of which goes to prove that if a road is dependent on its track and feeders for a return it should calculate its feeders to carry the maximum current ever demanded, and nothing but ground plates will obviate this necessity. It is not generally known that ice is a good insulator, but those who have tried to get current from a sleet-covered trolley wire, or those who saw the bare arc light wires at the St. Paul ice palace fastened to the walls by freezing, have no reason to doubt its insulating qualities.

AN Englishman has one resource for wounded feelings. He can rush into print. The English

papers contain in each issue, column after column of kicks, suggestions, prayers and supplications from their various subscribers. The Birmingham Daily Post recently contained a few remarks signed, "Douse that Glim," complaining that the fashion of passengers lighting candles was becoming dangerous to the safety of the other passengers, who could wait until their arrival at home to read the papers.

HISTORIC BALCH GROVE at Haverhill will be made into a picnic and pleasure ground by the Haverhill & Groveland Electric. The grounds have a history dating from 1730.

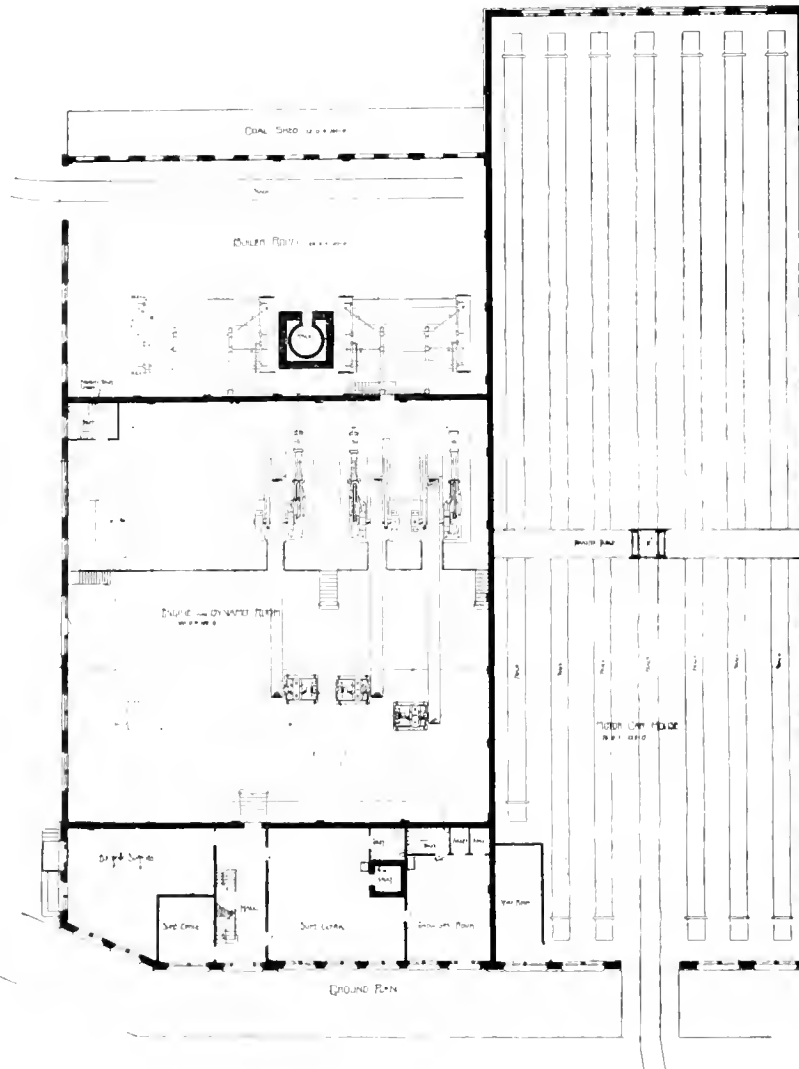

ELECTRICAL MEASUREMENTS.

By Professor George D. Shepardson, of the University of Minnesota.

PART II.

A CONTINUOUS record of the amount of electrical energy passing over a given line is often desirable, and much ingenuity and money have been spent in this direction. The chemical meter has been developed by the Edison company. Forbes has used with success the currents of air rising from a heated wire, by causing them to rotate a miniature windmill which is connected to a train of wheels that register the quantity of current passed. The clock has attracted many minds and has been used in many ways, in connection with ammeters or their equivalent. Several of the recording meters that have proved successful consist of small motors, the speed of the armature being governed by the current flowing. The armature operates a train of wheels which register the number of its revolutions and so register the quantity of current passed. This has taken a number of forms, the best known being the Shallenberger meter of the Westinghouse company for alternate currents and the Thompson recording watt-meter for either direct or alternate currents. By having part of the motor in the main circuit and part connected as a shunt between the mains, the speed of the motor is influenced both by the current passing in the main circuit, and also by the voltage at its terminals. The instrument thus measures the product of the volts and amperes and so measures and records the watts.

Motor and clock meters are subject to external magnetic influences, and cases have been known of the chemical meter being "influenced" by interested parties. It seems almost superfluous to note that all recording meters should be kept locked and so placed as not to tempt designing meddlers.

Having considered the various classes of instruments, it will be in order to compare them. Some instruments are portable, while others must be carefully set up in a fixed position. Some may be used in any position, while others must be carefully leveled and adjusted before use. Some have the scale equally spaced so that readings may be taken accurately to a fraction of a scale division. Instruments having heavy moving parts are apt to become sluggish in responding to sudden variations. Those having large masses of solid iron also are slow to respond to changes, and, on account of residual magnetism, give too high readings with decreasing current. Those having light moving parts are more sensitive to disturbances from static electricity and to draughts of air, although all instruments should be shielded. Some instruments remain quite constant for a long time after leaving the factory, while others should be tested and have a new scale made at longer or shorter intervals of time.

Instruments using permanent magnets are not suitable for alternate currents. The "permanent" magnets gradually get weaker by age, and are also weakened by

any hard knocks. When so weakened the instrument gives too large readings. Some makers have succeeded in "aging" their magnets artificially to such an extent that the weakening by age is negligible unless subjected to rough usage.

Electromagnetic instruments are suitable for direct or alternate currents if they have no iron parts, or if the iron core is small, thin, or made of a bundle of wires or plates. The spools of the coils and other metallic parts should be slit so as to avoid closed circuits for induced currents. This class of instruments is somewhat objectionable for use with alternate currents, on account of self-induction, which, however, may be made quite small by having only a small number of turns of wire and a small amount of iron.

Magnetic instruments are liable to be affected so as to give false readings (which may be either too high or too low) when near heavy currents, magnets, dynamos, or large masses of iron, especially if in motion. Such exposure is liable to have even permanent effect upon instruments using "permanent" magnets.

Some voltmeters have so high resistance that they may be left in circuit continuously without undue heating, while others must not be left in circuit longer than is actually necessary to take the readings or they will heat, and so give too low readings.

Electrostatic and electro-dynamometer (or balance) instruments, also those based on the heating effect, are used for both direct and alternating currents.

Instruments should be tested occasionally for alterations in the zero point, in sensitiveness and in their calibration. Change of the zero point is detected by shutting off the current from the instrument and may usually be adjusted, when necessary, by some simple device upon the instrument. Changes in the sensitiveness to fluctuations usually indicate themselves, and may be due to parts getting loose or to friction. Changes in the calibration may be caused by either of the other changes, by weakening of a controlling permanent magnet, or by the action of outside influences, and may be detected by comparing with instruments known to be correct.

Special devices are sent out with some instruments for checking the calibration. Thus some of the Weston voltmeters have a second scale and extra coil which may be used with standard battery cells of known e. m. f. When so ordered the Brush spring balance instruments are provided with a weight which, when placed on the solenoid core, will move the pointer to a check mark if the spring has not altered, and if required, the spring may be adjusted until the weight does give the proper reading. The Howell lamp indicators are provided with two lamps, one to be used only as a standard, while the other is used in regular work.

Measuring instruments may be tested by comparing

with some original standard: the ammeter by the chemical voltmeter; the voltmeter by standard cells of known e. m. f. Such tests require great care and skill. It is much more usual and convenient to calibrate instruments by some secondary standard, which is known to be correct from having been previously compared with an original standard.

In making calibration tests some general precautions need to be taken. Instruments should be kept at some distance from heavy currents, dynamos or other magnets which would affect the magnetic field in the instrument. If the construction of the instrument under test allows it, the current should be sent first in one direction and then in the other; also tests should be made both with increasing and decreasing currents in order to detect any errors caused by residual magnetism or otherwise. If the instrument being tested does not agree with the standard the current or voltage should be varied, and simultaneous readings taken from both instruments for each different value. Then either the correct readings may be marked upon the scale or a new scale may be constructed, or a curve may be plotted to show the relation between the observed and the true value. The method of constructing such a curve is as follows: A series of readings are taken simultaneously on the two instruments, the results being arranged in parallel columns. Two lines are drawn at right angles on section or squared paper, as "axes of reference." Distances in one direction are taken to represent readings in one instrument, distances at right angles representing readings on the other, any convenient scale being adopted. "Points" are obtained by taking on either axes distances from the "origin," or crossing of axes, corresponding to the readings of one instrument, and erecting at those places "ordinates," or lines perpendicular to the axes, whose lengths represent the readings at the same time upon the other instrument, the ends of the ordinates being the points on the curve corresponding to the several values of current. When all the readings have been thus plotted it will be found that a more or less regularly curved line may be drawn through or near most of the points, and this curve represents with great accuracy the relation between the observed and correct values of the readings. After one has had some practice it is easier to omit drawing the perpendicular lines, simply taking points whose distance from the axes of reference represent the corresponding readings on the two instruments and drawing the curve through these points.

The fact that some points do not fall exactly on the curve indicates that either the readings were inaccurate, that one scale was incorrect at that part, or that the readings on the two instruments represent different values of current or voltage. The curve must be carefully laid out so as to strike a fair average path among different points. Curves so constructed are of great use in scientific work, as they represent facts much more clearly than tables, since slight inaccuracies of individual readings are corrected by the curve, and since intermediate values may be estimated more easily and accurately than by interpolating between the values in the tables.

For these reasons it is better in re-calibrating an instrument, to construct a curve from the corresponding readings on the two instruments, and correct the old scale or make a new one by reference to the curve, than to mark the points on the old scale directly while comparing the two instruments.

In testing an ammeter it is connected in series with the standard ammeter, and currents of different strength are sent through both. The method of doing this will vary according to the circumstances. When the source of the current is a secondary battery, or constant potential dynamo, the instruments are placed in series with a variable resistance, which can be changed so as to allow more or less current to pass. In many cases this can be easily done by putting the instruments in the main circuit and turning on more or less incandescent lamps, so as to vary the current as desired. The instruments may be tested on constant current circuits by connecting a "jumper" or shunt of variable resistance around the instruments. By making the resistance of this shunt comparatively low, the current through the instrument may be changed from almost nothing up to full strength of current.

In testing a voltmeter it is placed in parallel with the standard, the corresponding terminals of the instruments being connected together so that each is subjected to the same voltage.

The keys of both instruments should be closed at the same time, and it should be noted whether the readings are the same after the current has been on for some time. The voltage may be varied by altering the potential of the dynamo or batteries, or by having a variable resistance in series with the two instruments. This resistance must be high, and in some cases may be conveniently made by a heavy lead pencil mark on a piece of paper, the resistance of which may be changed by varying the length and width of the pencil mark. A simpler method is to connect the terminals of the dynamo by a resistance that will not pass too much current. In the case of arc light dynamos, or other high potential circuits, this may consist of a number of incandescent lamps connected in series, enough of them being used so that they will not pass more than will bring them up to full candle power. If one side of the voltmeter is connected to one end of this row of lamps and the other side is connected successively to different points, we may obtain any difference of potential desired, ranging from zero up to the limit of the dynamo circuit.

If Secretary of State Foster has a fad, it is rapid transit. His particular admiration is electric traction in the future of which he has the greatest faith. In a recent communication to the *New York Advertiser* he proclaims his belief that the motor will supercede steam as it has left horses in the rear of the procession. The gentleman is not an electrician, but nevertheless he is a far seeing diplomat and financier, and we doubt not that on retiring from office he will devote some of his energy and capital to furthering rapid transit.

THE CAR STEP AND ACCIDENTS.

UNTIL recently, little or no attention, has been paid to one of the most important features in car construction. We say "most important," for the reason that the essential part referred to is necessarily used by every patron of the street railway company and undoubtedly is the cause of many of the numerous accidents which possibly might be avoided. During the recent cold weather we noticed that the step treads of most of the cars of this city were completely covered with ice, making it exceedingly dangerous to board a car, and especially so as many will try to board the car while in motion.

In Chicago a large proportion of male passengers have long indulged in the habit of swinging on to a car when under full speed, preferring to take their chances of injury rather than lose the fraction of a minute required to stop and start a train. This and the desire to "make time" has educated many drivers to a point where they are often careless about stopping even on signal. The same conditions prevail in many cities.

While it may throw the responsibility of an accident upon the party who attempts to board a car while in motion, is it not good business policy to provide passengers with a secure foot-hold when boarding a car? In our travels about the country we have noticed cars furnished with steps having treads varying in width from six to twelve inches, and the riser or distance from the tread to the top of the platform, would vary from nine to sixteen. Some high truck cars noticed in particular, were provided with double-tread wooded steps of narrow tread and high riser, projecting from the platform, that looked as if a section of a step ladder had been made to do service as car steps. Much time is unnecessarily lost each day per car, by using steps of such dimensions, as it compels passengers to use care and time getting on or off the car. Another instance was noted in a large city, of cars equipped with steps having risers of sixteen inches, and every time ladies desired to board the car, the conductor was obliged to alight and assist them on to the step and then upon the platform, and go through a similar operation when they left the car. This was no doubt very pleasing to the conductor in some cases.

How many car miles were lost each day by this road could easily be computed, if we only knew how many lady passengers they carried. We would suggest that managers of street railways give more attention to the matter of steps when ordering cars, and are surprised that this important feature has been so long overlooked.

When taken into consideration that it is by means of the step that all passengers must either board or alight from the car, it is quite evident that the step is of no small moment in car construction, and that such benefit will accrue from using steps of proper dimensions, one that possesses the advantages of a secure foot-hold in all seasons and conduces to cleaner car platforms and car floors.

THE LITTLE GIRL WHO STARTED THE CABLE.

THE ceremonies that attend the launching of big ships, opening of great enterprises and the completion of grand engineering feats, usually center around the figure of some little woman or some little girl who breaks a bottle of wine over the ship's prow and baptizes man's big work of many weary months. Or, as in the great harbor engineering masterpiece, when Hell Gate reef in New York Harbor had been honeycombed by bold divers who risked their lives and limbs, and the many thousands of dollars in making ready the charge, the chief engineer's little daughter pressed the electric button that did the rest. So with many other instances, and why not? Do not men labor in these great achievements for the little women and little girls of the world?



MISS CONSTANCE CRIMMINS.

It is not strange, then, that the ponderous machinery of the Broadway cable railway in New York City should receive its first marching orders on January 31, 1893, from the hands of Constance Crimmins, the ten-year-old daughter of President John D. Crimmins, of the Metropolitan Traction Company. Little Constance, dressed as she appears in our engraving and accompanied by her elder sister and in the presence of many representatives of the company and city press, turned with her own hands the wheel that for the first time started Broadway's cable on its endless and tireless trip. The test was highly satisfactory and before many days both power houses will be ready to begin operations. The complete subjugation of gigantic mechanical forces was scarcely ever better illustrated.

A FARE FREAK.

THE Islington Gazette funny man in his own dear, dreary, English, funny way, says: "That tram-cars should be provided with money-boxes for passengers to put their pence in. The other night—conscience makes me write this—I boarded a car whilst the conductor was on top collecting fares. He had a crowd up there to deal with, and did not come down again by the time I had reached my destination. Not wanting to be carried further I got off, and went away owing the company a penny. Nobody shouted 'Police!' or 'Stop him!' If the money-box was tacked on to the car the passenger would be able to pay without waiting for the conductor to come down. Or, better, it should not be the duty of the conductor to go an inch beyond his platform."

Oh, for just one or two specimens of this new variety traveler who will not rob a corporation! We will exhibit him at the World's Fair, or chain him in a North Side cable car as an example of honest men that really live outside of story books.

COMBINATION CAR FOR INTERURBAN SERVICE.

INTERURBAN electric lines are in their infancy, notwithstanding the large number already in successful operation. As the REVIEW has maintained from the first, the development and possibilities in this department of street railway work will rapidly grow into proportions little dreamed of even by those who believe themselves fully in touch with the times. The rolling stock for these lines will necessarily require some radical changes from the ordinary day car on city lines. We consider the cars now being delivered the Cayadutta Electric Railroad, Gloversville, N. Y., the best arranged for this interurban service of any we have yet seen. They are four in number and built by the Gilbert Car Manufacturing Company, Troy, N. Y.

The line on which they are to run, and which will open in a few days, is 10½ miles long, connecting Gloversville and Johnstown, and passes through Fonda and Fultonville. Branch lines in the first two mentioned cities

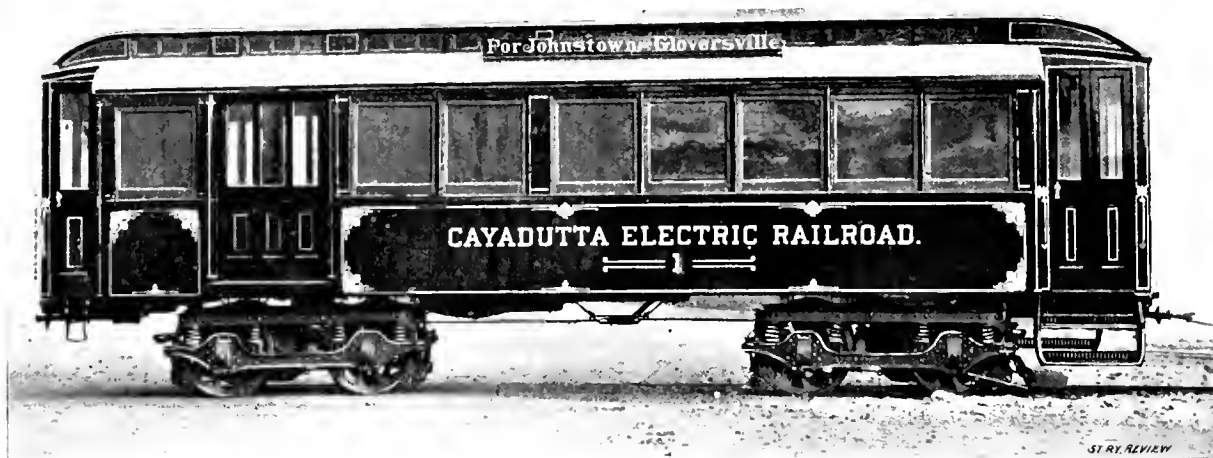

COMBINED BAGGAGE, SMOKING AND PASSENGER CAR.

SORROW TURNED TO JOY.

THE trolley line on Bainbridge and Catherine streets has defied the snow storms without interruption. The continued snow storms and severe cold weather have been very hard on the horse car lines and the scenes of struggling beasts trying to haul overcrowded cars has been truly touching and the opponents of the trolley are now as scarce as flies.—Philadelphia Taggart's Times.

A CITIZEN of Atlanta, Ga., sues the electric line for having run over his pig, causing spinal troubles, which resulted in the untimely demise of the porker. This, however, is by no means the first time railways have been called on to contribute lucre to a hog.

ALFRED DICKINSON, the inventor of the Staffordshire, England, trolley system, has just been granted a patent on the same in the United States.

bring the total mileage of the interurban system up to eighteen miles.

General Manager T. C. Frenyear is a most progressive man, and is determined to leave no stone unturned to demonstrate the splendid earning qualities of his combined "Freight and Passenger Line," as the letter head of his company reads. The equipment at the start will number eleven motor cars, four trailers and one 35-foot baggage car specially constructed to transport theatrical baggage and scenery. Eight miles of the line are built on the company's private right of way purchased for the purpose, and the grading, blasting and filling have made construction a no small undertaking. The whole system, however, has been planned with a view to a large freight traffic, and already an order has been placed for two heavy electric locomotives for the freight business, each locomotive guaranteed to handle a load of 300,000 pounds on a 3.5 per cent grade.

But to return to the passenger and express service. The illustrations convey a good idea of the appearance

and plan of the car which, as stated, was made by the Gilbert Car Company, and is mounted on McGuire maximum traction trucks with Griffin machined wheels.

Each truck is equipped with a 30-horse-power Short single reduction motor, making 60-horse-power to each car. The guaranteed speed is twenty-five miles an hour, on a level, and it is expected to make the run between Gloversville and Fonda in less than half an hour and the return trip (up grade) in thirty-five minutes. Rate of fare not yet determined, nor charges for express and baggage.

The car is 35 feet 6 inches over all and 8 feet wide. The motorman occupies an inclosed platform opening back into the baggage room, 7x8 feet. This room has on each side sliding doors 3½ feet wide. The smoking room is 6½x8 feet, with stationary seats on three sides, four large windows and a sliding door opening into the passenger room. A movable seat permits access to baggage room if desired. The passenger room has six cross seats accommodating twelve persons, and two longitudinal seats seating ten more, which, with the smoker, gives seats for thirty-one passengers. The rear platform

think that it is not advisable to build one large power station, but rather to have two, three, or four small ones. At each of these I propose to build furnaces on the incinerator or crematory principle, and inform the municipality that we are prepared to take four to six hundred cart-loads of rubbish every day. The initial expense of the furnaces will be offset by the saving in fuel. We shall mix with the rubbish a cheap combustibile which I have lately discovered, which will raise the heat unit."

Mr. Digby's venture will be watched with interest, and if the increased number of stations does not unproportionately increase the cost, economy ought to result.

A PROPHECY.

F. M. SMITH, of East Oakland, Cal., is the new luminary in the horizon of occidental rapid transit. He is many times a millionaire, absolutely controls the borax market of the United States and has his eye on Europe. His income is estimated at \$20,000 a month. Recent franchises asked by him and his agents in Oakland and its suburbs, coupled with the

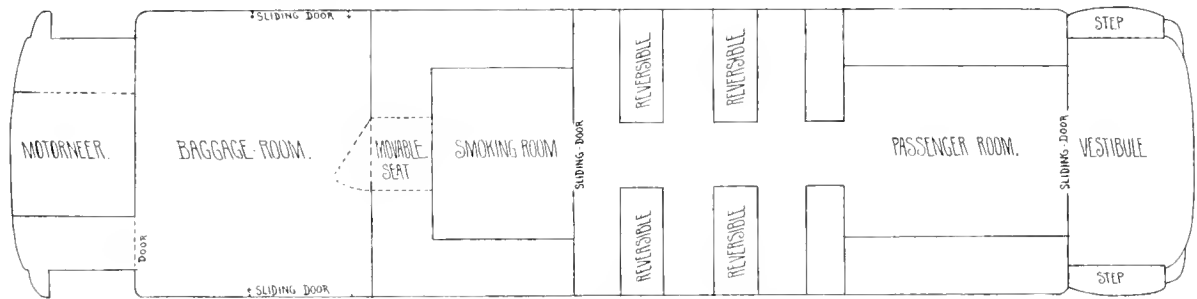

PLAN OF COMBINATION BAGGAGE, SMOKING AND PASSENGER CAR.

is also vestibuled. The interior finish is quartered oak with polished bronze trimmings, and ceilings in quartered oak decorated in gold. The cars are painted black and ornamented and lettered in silver, altogether presenting within and without a very neat and attractive appearance.

Manager Frenyear will establish three or more baggage stations in Gloversville, where express parcels may be left, and also depots in the other towns.

The REVIEW predicts that this service will grow into a business the proportions of which will be a genuine surprise to people who are little aware of the coming possibilities of the electric freight and passenger business.

A NEW FUEL.

INDIA, with its proposed electric railway at Madras, brings about a series of new conditions to be met by the power user. Fuel there, of a quality proper for such extensive use as is necessary in street railway practice, is expensive and limited in supply.

Mr. Digby, the engineer sent from London to Madras, proposes to make both ends meet in dividends by utilizing what has heretofore been not only an unproductive element but a public nuisance as well, namely, the street refuse of the Indian metropolis. Mr. Digby says: "I

fact that a number of old franchises have been bought by him, point to a magnificent scheme of consolidated electric lines. The line will skirt the foot hills to Haywards, out from West Oakland, after touching North Oakland. Turning south it will reach San Jose and go on to the base of the Santa Cruz mountains at Saratoga. Other feeders ramifying to the surrounding villages and plantations will bring every commercial interest to a head at the most convenient commercial points. It is not a rash prophesy to say that the time will come when the magnificent, but still unused water power of the Sierra will be harnessed in the service of civilization and commerce, making all the beautiful country one vast interdependent system of the country and city.

Subsidiary operations in real estate are already maturing and the millions of acres now without adequate transportation facilities will before many years teem with life and prosperity.

Cobden said once, in reply to a friend who hoped to see the day when all Englishmen would read Bacon, "And I, sir, shall hail the day when every man shall eat Bacon." So we look forward to the time when the poetry of the future will be the hum of the trolley translated into a more satisfactory life for the ruralist.

THE BALTIMORE-WASHINGTON ELECTRIC.

EVIDENCE begins to crystalize that the Philadelphia syndicate is preparing for the completion of the idea published last year of putting in an electric railway service between the city of Baltimore and the capital of the United States. Recently the Belt line in Washington was bought by the syndicate and the Baltimore lines have been well in hand for some time. This gives first class terminal facilities in both cities. All of these incidents point to the early realization of the scheme. The suburban realities of Baltimore have risen already in expectation of the building of the line.

THE recent decision in the Philadelphia trolley cases will save 8,500 quaker horses from some very hard work. Of this number the Traction Company owns 4,672.

THE MEHLING CAR.

CLEVELAND is fast becoming a leading center for the manufacture of street railway supplies, and among the more recent of the industries devoted to such products is that of car building. The G. C. Kuhlman Company, among other types of street cars, have the exclusive manufacture of the "Mehling Car," which has proved so popular on the East Cleveland road, and one of which cars is illustrated herewith, showing both sides and the interior. As will be noticed from the car illustrated, one platform is fitted up for the exclusive use of the driver, and the rear platform made specially large to better accommodate the exit of passengers, and standing loads. To compensate for the closing of the front door to passengers, a sliding side door is placed midway in the body of the car, made accessible by a



INTERIOR OF MEHLING CAR.

THE SITUATION IN INDIANAPOLIS.

THE street railway situation in Indianapolis is becoming more intricate the more it is analyzed. The latest phase is the point brought up claiming that the Citizens' Company has no rights because the sale by the Johnsons was illegal. The new owners in turn claim a perpetual franchise in the city. This position tends to shut out the new "unknown" company from any city rights. The new owners of the Citizens' have made prompt payments on the property, and took possession the first of March. Mr. Mason, the company's attorney, says that the invalidity of the Johnson sale is an old story and does not cause him any uneasiness.

running footboard. This door opens into the aisle, 22 inches wide, and extending the entire length of the car. By this means passengers can easily depart without passing out over the rear platform and those in the forward seats have only the car length to walk. The use of the side door in winter also is pronounced a great advantage in preventing strong draughts through the car. The body is 22 feet 6 inches long, 8 feet 2 inches wide, and the length of car over all 32 feet; wheel base is 7 feet 6 inches and wheels 33 inch diameter. Although the Mehling patents cover removable sides, the car illustrated has stationary panels, but the side windows are large, using glass 34 inches square, and sash drops to lower edge of sills, making practically an open car. The windows in the doors also drop. Curtains are hung on

Hartshorn rollers and fringed with Dutch leather. Interior trimmings are curly white maple for ceilings and cherry for sash and door; metal trimmings are of polished bronze, and all the glass is polished plate. Eight cross seats are provided, each comfortably seating 4 adults, giving a total seating capacity of 32, while the standing load which can be carried without inconvenient crowding brings the load up to 90 or 95.

A feature passengers appreciate, and which saves much uncomfortable twisting of necks, is the electric buttons opposite each seat which indicate on the rear platform. The conductor also has push button connection with his driver, and the use of bell cords is entirely done away with. The advantages of this where stationary registers are used will be obvious. The truck under our illustrated car will be recognized as the familiar type manufactured by

the Stanwood steel type. Taken altogether the car presents a most attractive appearance and is proving

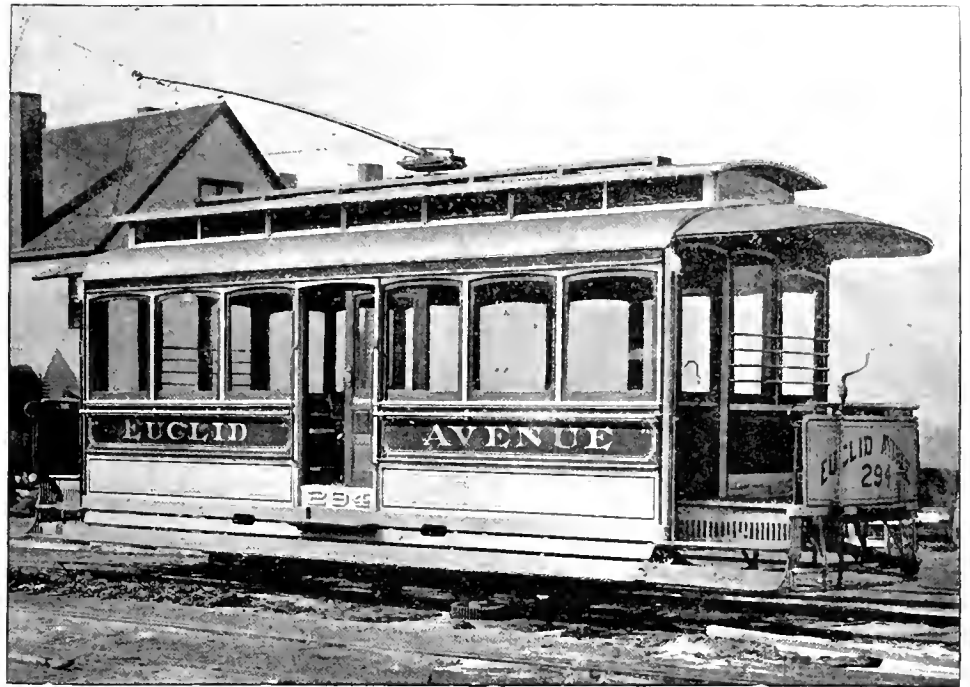

ENTRANCE SIDE MEHLING CAR.

highly satisfactory both to the railway people and the public on account of the facility with which passengers can be received and the comfort of travelers and increase of revenue consequent thereon.

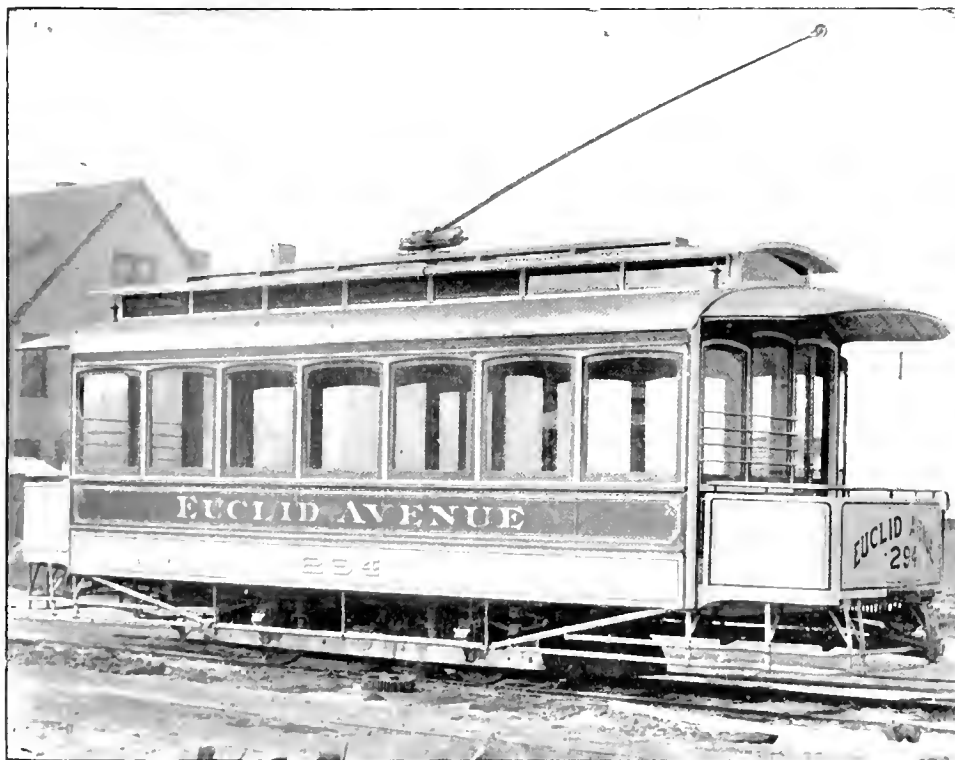

CLOSED SIDE MEHLING CAR.

the Fulton Foundry of Cleveland, in which city so many of these trucks are in daily service. The steps are of

and he haint never been no setter, fox terrier, deer hound, pointer, beagle, nor other kind of dawg!"

A MAN whose principal feature was very red hair recently mounted a Philadelphia street car with a 'cute little pup tucked under his arm. He was hardly seated when a young lady exclaimed, "Oh George, isn't he too sweet. What kind is he? George bellowed in a loud voice that the pup was setter. Another young lady was informed by her escort that the dog was a fox terrier. Another called his sisters attention to that "pretty deer hound." Several other suggestions called the animal a beagle, a pointer, and a Newfoundland. Finally the red headed man arose, a little unsteadily and remarked, "ladies and gentlemen, this yer dawg is a Scotch collie,

SHE TALKS BACK.

WE have been expecting it a long time. Now it has come. So much has been said of the ungratefulness of women, and the legal and moral ownership of a street car seat, that evidently one straw too many has at last fallen—and our spine is fractured. She's a Wisconsin woman, too, and her name is Harriet Forrester. She analyzes the terrible question with a cold, impartial analysis. Harriet does, and in such a pointed, undeniable way as to almost make one feel she is right.

Still Harriet never was a man, probably never gave up her seat to a woman no older than herself, and—take special note—she positively avoids any mention of the female who with her bundles occupies the space intended for three grown persons, or the one who holds a load five minutes on the rush trip to be informed her car heads the other way. But what did Hattie say? Just listen at this:

"I think it about time for some woman to defend her sex from the attacks made upon her behavior in the street cars by the man of to-day. It seems to be a recent grievance, and, if one is to judge from the articles written upon the subject, a serious one. I am a patron of the street car (and, needless to say, a woman). Leaving the question of the aged, and the woman with the babe out of the subject, I think it right and proper for all to be on an equal footing (We object: Chicago girls have small feet—*ERROR*) in a public conveyance, and I am sure there is not a woman but agrees with me, and would much rather stand than to deprive the man of the place for which he has paid.

"But it is the actions of the men that make the women uncomfortable. The man who takes refuge behind his paper is a blessing. It is the one that glares at the poor, unoffending, swaying creature, and begins to fidget. Of course he attracts the attention of the woman standing before him, and she no doubt glances at him, when up he leaps, points to the seat with the look of a martyr, and turns his back before the woman has a chance to thank him or smile an acceptance. I read, not long ago, of a man who made the assertion that he would be 'almost willing to marry the first woman who thanked him for giving her his place in a car.' All I say is, 'Give her a chance to thank you.'

"Now my poor, abused man, keep your seat in a car, unless, as I said before, an aged person or the woman with the babe—and, I forgot, a beautiful woman—comes in, and do not think every woman standing who glances at you wants your place. But when you are kind enough to get up and give her your seat, give her a chance to thank you, and remember.

"Sometimes not to see anything is right;
By being blind 'tis thus we keep our site."

THE street railway company at Boone, Ia., is contemplating an extensive summer resort system on the park plan. Gravelled walks, dancing pavillions, a race track and other features are in view. The railway is not yet built.

HOW A PATENT PROTECTS.

WITH pointed good sense the Railway Review of this city says in a recent issue; Speaking of the value of patents, a business man interested in such things asserts that a patent does not patent in this country. "All that the patent office does is to give you a paper with some writing on it, and if another man steals your idea, and goes to manufacturing your invention, the patent office will not lift a finger to protect you or to stand by its own decision. The fact that you've got a patent is a point in your favor, but you've got to hire lawyers and fight the thief in the courts, and if he can stand it to hire lawyers longer than you, that settles you, and you might as well make him a present of your invention. There are lots of men in the country getting rich on the discoveries of other people. All they had to do was to take 'em and fight the real discoverers into poverty. The patent office, to be respected and to be of any use, ought to have the power to cause the stealer of a patent to be sent to prison."

FOREVER AND FOREVER.

The constant drop of water
Wears away the hardest stone;
The constant gnaw of Towser
Masticates the toughest bone;
The constant cooing lover
Carries off the blushing maid,
And the constant advertiser
Is the one that gets the trade.
—*Tithbits.*

ELECTRICITY FOR STEAM ROADS.

CALIFORNIA is the first state to begin legislation tending toward the inevitable ultimate, interurban connection by electricity instead of steam. Assembly bill 697 is so drafted as to provide that every railroad operating in California by steam motive power may use electricity in the place of steam or electricity and steam in conjunction for propelling cars on such railroads or parts thereof. This will give the steam roads power to use their road bed already laid in the interests of electric service and establish what has long been advocated by the REVIEW, namely, the inauguration of longer interurban electric lines than have yet been attempted. This project brings forcibly to mind the prophecy of Frank J. Sprague, that the revolution of steam traffic will be effected, not by long lines built out of hand, but by the gradual extension and union of interurban lines.

"TAKEN insane in a street car at Buffalo the Rev. Theodore Lyman, of Cold Springs, N. Y., began preaching to the passengers." Great numbers of people have been taken insane and have begun preaching to the companies, but this is the first instance of the tables turned. We hope it is a symptom of better times coming.

FT. WAYNE'S ELECTRIC SYSTEM.

A Brilliant Success—The Men Who Made It, and How They Did It.

THE history of the Fort Wayne Electric Street Railway Company extends back twenty years, when kerosene and horse cars were regarded au fait. At that time, however, Fort Wayne was not prepared physically or financially for much greater things, and the rising generation in Fort Wayne should not look down on their pa's and ma's for patronizing these primitive institutions. This pioneer railway was operated by the Citizen's Railroad Company, which institution later was fortunate enough to fall into the hands of its present owners, John H. Bass, F. DeH. Robison and S. B. Bond. This happened in 1887.

With the change in ownership came material improvements which amounted to the re-equipment of the horse lines with all the latest idea in that style of traction. In these days, however, it became evident to the owners of the road that Fort Wayne was becoming too large and progressive a city for such things as slow-going horse cars, and another re-equipment, this time electrical,

in this way, and says that although it is not so theatrical a method as the other, it is far more satisfactory in the long run. The same method was employed in the introduction of the cable into Cleveland, O. The result of the efforts of the company is most gratifying, and to-day the rapid transit system of Fort Wayne has no superior in cities of its class.

The Fort Wayne Electric Railway system now consists of five lines; one belts the principal business portion of the city while the other four run through the main arteries of traffic. Of the through lines one opens communication north and south, the other three traversing the lines of greatest travel east and west. All lines meet for starting and transfer at the corner of Main and Calhoun streets, near the company's office. This corner is the busiest in all the lively city, presenting a very metropolitan appearance.

The road bed for the main part is over brick and wood block paved streets. The company paves the space



EXTERIOR OF POWER HOUSE.

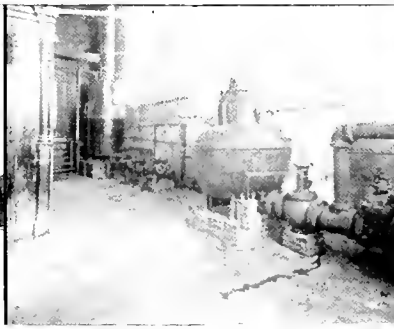

GAS METER.

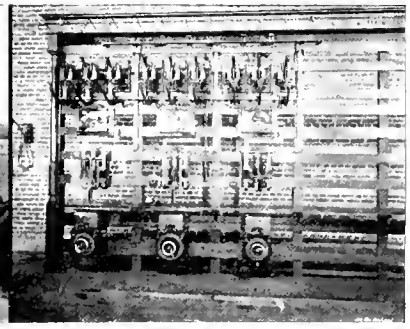

THE SWITCH BOARD.

was proposed. After the usual preliminaries of argument with the city fathers, the new regime began, and in May, 1892, M. S. Robison, Jr., of Cleveland, Ohio, commenced the good work, with his accustomed energy and foresight. The most sanguine outsider, judging by comparison of like enterprises, did not hope for the completion of the change within a year, but on the eighth day of July, 1892, the first line was run with motors, and by the first of the succeeding September the entire transformation from horses to electricity was accomplished, the doubting pedestrians of Fort Wayne's population were galvanized into a succession of electric surprises, and the road was opened. The term "succession of surprises" is used guardedly, as it is Mr. Robison's practice to teach his patrons rapid transit in a series of easy lessons. This is accomplished by retiring the horse cars one by one and introducing the cars propelled by the new motive power in the increasing ratio. This plan accomplished two desired effects; first, it accustomed women, children and horses to the new order of things by degrees, and second, it gave new motormen the necessary practice at horse car speed. Mr. Robison retained all his horse car drivers

between the tracks and unreservedly endorses brick paving. Their method is to lay a foundation of broken stone eight inches deep. Over this is spread four inches of gravel, on which the brick is laid. The cost is in the neighborhood of \$2.00 per yard, and the results uniformly excellent. One stretch of T rail track is worthy of special note, as the careless observer would declare that girder rail had been laid. The method is this: Foundations of broken stone and gravel are laid, as above described, and upon this are laid 6x8 inch white oak cross ties, spaced two feet from centers. The brick is then laid, with special "o" shaped brick next the rails. This gives almost as easy driving surface and turning out facilities to teams as girder, and all the advantages of T rail track at the same time. The rail used is the Illinois Steel Company's 60-lb. T, 5 $\frac{3}{4}$ inches deep. Johnston 66-lb. girder is used on the principal lines. This construction brings the pavement on a level with the car wheel, at the same time suspended joints obtain altogether, and two rail bonds are used.

The overhead construction was designed by the Short Company. No. "o" trolley and oooo feeders is the rule,

and the result shows a saving of two-thirds in wire, with a considerable salvage in power. The system is divided into eight separately fed sections, managed from the power house. These sections are again provided with cut-outs. Wooden poles are used, with the exception of a mile and a half of Van Dorn iron poles.

The rolling stock consists of fifty-nine handsome cars made by J. M. Jones' Sons, West Troy, N. Y., with eight more under contract from the same firm. All are lighted by ten 16-candle power electric lights, and present a beautiful appearance at night as well as by day. Lewis & Fowler stoves and headlights, and Meaker's registers, equip the cars. All motor cars carry two 20-horse-power Short's single reduction motors. Dorner & Dutton trucks, and Bass Foundry wheels, are under the cars.

lines loop out of this house, requiring no transfer table. The cars are all inspected at the house, no inspectors being required on the road.

The power house is an elegant structure 75 by 150 feet. It is built of brick with stone trimmings, with a steel trussed roof covered with slate, and is as near absolutely fire-proof as could be made. It consists of a boiler-room 50 by 75 feet, and an engine room 75 by 100 feet. Here the floor is as clean as an office, no ashes are observable, no shovels, no pokers, no stokers, and the enquiring visitor's questions are solved by two words—natural gas. The gas comes into a meter or reservoir at 60 lbs. pressure, from a 6-inch pipe. Here this is reduced to enter the furnaces at ten ounces, and, mixed with air, burns fiercely. The lone man who manages the battery of six

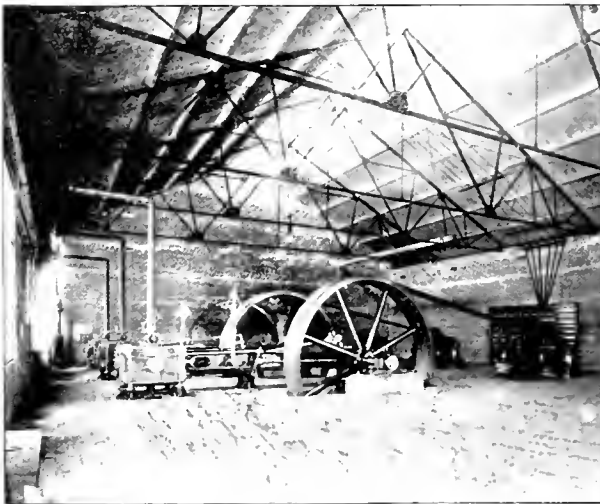

ENGINE ROOM.

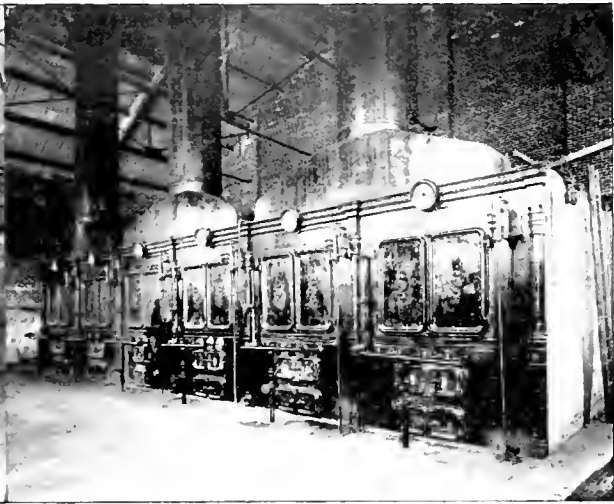

BOILER PLANT.

The car house and repair shop, at the corner of Main and Glasgow avenues, is built expressly for use. The building fronts 120 feet and is 160 feet deep. The east end is literally one great window, 528 panes of glass admitting sunlight. Here are seven tracks and pits for car inspection capable of holding thirty-five cars. The repair shops have had so little work that the name is scarcely deserved. Seven men, including blacksmiths and painters, are all the work needs. In six months only one armature has required attention, and that but little, only a part of the winding having been burned. Mr. Robinson requires each car to be varnished annually, and states that this custom keeps the paint in good condition for a period of years. A Hathaway transfer table gives the best of satisfaction. Everywhere 2½-inch cotton fire hose is convenient and affords ample protection, nozzles being always attached. The two big Lewis & Fowler sweepers have here their lair, and to their credit, and to the credit of the efficient superintendent, L. D. McNutt, be it said, that during the late fall of sixteen inches of snow, at no time was Fort Wayne deprived of street cars "on time." It required work and worry, but it paid in gold dollars and golden opinions of the public.

The car house at the corner of Railroad and Clinton streets is an iron structure 130 by 150 feet in size. Two

150-horse-power boilers, wears a clean face and hands, and could attire himself in a boiled shirt. The boilers, as represented in our engraving, are 16 feet long, 72 inches diameter. Three are kept in reserve. They were built by the Bass Foundry & Machine Works, of

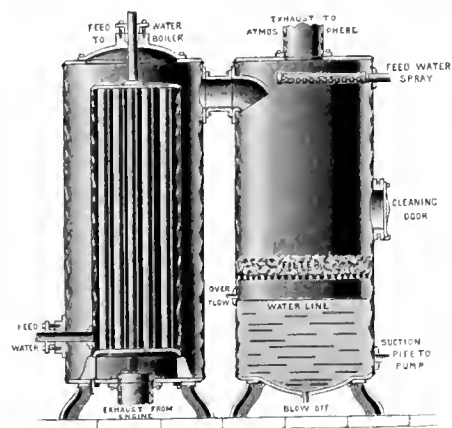

BASS WATER HEATER AND PURIFIER.

that city. Four flames of natural gas feed each furnace, which altogether require 250,000 feet per diem. The gas is piped forty-eight miles, entering the city with a 12-inch main. The piping, made by the Bass Works,

consists of a 20-inch header back of the boilers, with a 12-inch pipe to a Stratton separator. The feed water is purified in a Bass purifier, which takes out from 660 to 700 lbs. of lime weekly from the very hard spring water used. An illustration of this excellent feed water heater and purifier is given herewith. Duplex pumps feed the boilers. The engines, a detailed description of which is given below, were made by the same extensive firm, and are housed in an adjoining room 100x75 feet. They are belted direct by 24-inch Munson belts to three 200 kilowatt, 275-horse-power, Thomson-Houston multipolar generators. One engine and generator is kept in reserve. There is space left in the engine room for double the amount of power and if present symptoms may be diagnosed the waste places will be made glad before long. The three ponderous engines are very quiet in their action, and conversation may be carried on in the ordinary tone of voice any place in the room. Immediately in front of the elegant switch board the visitor sees a trap door, the mystery of which is easily explained by raising the same and descending a flight of stairs, at the same time manipulating an electric light switch. After these two actions, the stranger finds himself in a well lighted, dry, cemented vault 60 feet long, 7 feet high and 4½ feet wide. On the ceiling of the vault may be seen at a glance every feeder and return wire that comes in or goes out of the station. The switch board is of light, open construction six feet away from the wall. The electric equipment is from the General Electric Company, and consists of three multipolar 200 kilowatt generators, one always in reserve. The switch board was put in by the same company. As one of the side tracks of the P., F. W. & C. Ry. runs alongside of the boiler room, every facility for receiving coal is afforded if at any time the natural gas supply gives out, which catastrophe is not anticipated.

The three engines, which are of the Corliss type, were made and erected by the Bass Foundry & Machine Works, Fort Wayne, Ind. The cylinders of these engines are 20-inch diameter by 48-inch stroke. The driving pulleys are 16 feet in diameter, 29-inch face and weigh 28,000 pounds each. Each engine is rated at 270-horse-power, with 90 pounds steam pressure.

These engines are specially designed for street railway

work, which is, as all experienced builders know, the most trying service to which an engine can be subjected. At the street railway power house we have seen one of these engines developing 400 horse-power when not cutting off at all, owing to a momentary excessive demand for current, when suddenly, the electrical apparatus being overloaded, the current breaker would "fly out" instantly reducing the load to nothing, while the variation in the speed of the engine was not noticeable to the eye. Under ordinary conditions the extreme variations of load will come within one per cent of the speed.

This excellent regulation is due to the delicate action of the governor which is of the Porter high speed type. Very light balls are used, running at high speed, making the governor quickly responsive to the slightest change in load. The governor is highly finished, and previous to use is rigorously tested on a testing block in the shop.

One of the most prominent features of the improved Bass-Corliss engine, next to the delicate governing mechanism, is the noiseless valve gear. The releasing gear is so quiet in action, owing to its special design, that when in proper adjustment it can scarcely be heard. The dash pots are also of improved construction, noiseless and prompt in action, and are not affected by any extreme variations in load.

The guides are cast solid with the girder or frame, forming a part of it, and are bored in actual align-

ment with the cylinder, the top and bottom guides being connected with a heavy cast ring directly over the center foot, thus carrying the strains from the top guide direct to the foundation. The cross-head has adjustable gibs turned to fit the bore of the guides, and has ample wearing surface. The steam cylinders are jacketed in a neat and substantial manner with quartered oak tastily trimmed with nicked mountings. The general appearance of the engines pleases the artistic taste as much as the details appeal to the mechanical mind; in fact a more quiet and tasty engine room than the one described would be difficult to find anywhere.

A desire to know the origin of these engines took the REVIEW representative to the extensive works of the Bass Company, where the mechanical superintendent, F. A. Rider, said:

"Yes, we are proud of our engines. This design is



JOHN H. BASS.

new, has but recently been put on the market, and combines the best points of existing engines with our original improvements after careful investigation with the special object of meeting the demands of electric street railway work. We believe we are producing an engine that will satisfactorily fill the most exacting requirements of this severe and trying service."

A glimpse of the erecting floor showed numerous engines in process of construction, among which were noticed a compound condensing engine 16 and 30 by 42 inches for the World's Fair, where it will be an operative and competitive exhibit, its location being in the machinery hall; also two 30 by 60 inch for use in the manufacture of tin plate by the New Castle Steel & Tin Plate Company, of New Castle, Pa. These latter



M. S. ROBISON, JR.

engines have each a 40,000-pound fly-wheel and a shaft 20 inches in diameter by 20 feet long. The total weight of each of these monsters is 190,000 pounds exclusive of the gearing arrangement for driving the roll trains. In addition there were a large number of other engines of all sizes, in various stages of completion. These works are having a large demand for their engines, their shops being operated to their fullest capacity day and night.

JOHN H. BASS

has, perhaps, more than any one man, made the beautiful and prosperous city of Fort Wayne what it is to-day.

Mr. Bass comes of a fine old southern family, originally from Virginia and the Carolinas; his father removed to Kentucky when only two years old, where J. H. Bass, the subject of this sketch, was born at Salem, in 1835, was educated in the state, removed to Fort Wayne when seventeen years old, and soon became the book-keeper of Jones, Bass & Company, founders and machinists, in which his brother, the gallant soldier, Col. Sion S. Bass,

who fell on the bloody field of Shiloh, was a partner. In 1858 formed a co-partnership with Edward L. Force, under the firm name of Bass & Force, the business being carried on in that name and the Fort Wayne Machine Works until 1863, when the firm of Bass & Hanna was created and carried on by them until 1869, when Mr. Bass became the sole owner by the purchase of the property after the death of his partner. In the same year he established the St. Louis Car Wheel Company, still owned and operated by him. In 1873, in the face of the greatest financial panic this country has ever known, he had faith enough in Chicago to place there another branch of his business, which is now in successful operation.

In 1880 the Bass Foundry & Machine Works and allied interests became so large that it was thought expedient to establish iron furnaces in Alabama, where, under his supervision, greater care could be taken in the production of a portion of the iron used in the manufacture of car wheels, which have since become so famous.

Mr. Bass' chief interest in the street railroad was to aid in building up the city of his adoption, and enhance the value of his real estate there; but his interests do not stop here for he is also the owner of the famous Brookside farm, situated near Fort Wayne, renowned for its Clydesdale horses and Galloway cattle, president of the First National Bank of Fort Wayne, and a director of the Old National Bank.

M. S. ROBISON, JR.,

the vice-president and treasurer of the Fort Wayne Electric Railway Company, has had the most thorough and comprehensive street railway and engineering education and experience although still on the sunny side of middle age.

The foundation for his present successful career was laid in the engineering department of the Northwestern University, from which he was graduated in 1877. After several years of miscellaneous work in his profession he entered the corps of the Cleveland Street Railway Company in 1888 as office secretary. After a year and a half in this capacity he became superintendent and treasurer of this extensive horse line, and on its change to mechanical traction as the Cleveland City Cable, accepted a like office with the new corporation. The most onerous and trying work of the change of system fell upon Mr. Robison. In fact, after a long period of labor day and night in this cause he found his health so much impaired that rest was imperative. Resigning March, 1891, Mr. Robison began an extensive tour, which included all that was worth seeing in the United States, Mexico and Canada. Idleness, however, was not to the taste of Mr. Robison, and with the return of health, he became interested in the proposed electric line at Fort Wayne, in January, 1892. The success of his new venture needs no further compliment than the above account of the line.

Mr. Robison has a happy social disposition evinced in his prominent connection with the Fort Wayne Club, the Civil Engineers' Society, of Cleveland, and the small club which owns an island in Georgian Bay on the great lakes

A NEW ELECTRIC HEADLIGHT.

THE superiority of electric light over oil lamps wherever it is possible to use the former goes without saying. The American Reflector & Lighting Company, 80 Jackson street, Chicago, however, goes a step further, and claims that an electric headlight when practicable is a long step in advance over the ordinary methods of track illumination and light warning. With this end in view they have coupled to the foregoing improvements a new method of route signs.

Their electric headlight shown in our engraving is a durable, efficient and powerful illuminator, besides bearing in full view on its glowing face the route or destination of the car in strongly marked letters. These signs are revolving, so that two, three or four can be shown at various times as the route of the car or train requires. The light is as easily transferable from one to the other end of the car as an oil headlight, besides enjoying the advantages above enumerated. The route signs are changed by rotating a disc by means of the button catch shown at the left of the engraving and turning the disc. No mistakes can be made by a passenger, and the amount of satisfaction to the public more than pays for the change. On small lines where a car is compelled to travel several routes the advantages are easily seen, and on longer lines the exact termini of every train can be shown without the possibility of a mistake.

Recognizing the fact that many roads not electric, and even many electric roads may not find this headlight expe-



ELECTRIC HEAD LIGHT WITH REVOLVING SIGN.

dent, an improved form of oil headlight is made by the same company and illustrated above. Its catalog number is 167, and it combines all the superior features of the electric headlight with the oil luminant. It is easily transferable to either end of the car and gives a steady penetrating light. A cheaper article without the revolving signs is numbered as 166, but is fitted with the mirror plate or parabolic metal reflector, as is desired. The wick turns down easily and is not affected by the jolting of the car. Its clear light and freedom from objec-

tionable odor gives it great advantage over ordinary cheap headlights. It is six dollars cheaper than the foregoing. The American Reflector Company is not new in the business, as their extensive factories at 215, 217, 219 South Clinton street testify. The railway headlight



OIL HEAD LIGHT WITH REVOLVING SIGN.

branch, however, is a later venture, which their wide experience and large facilities justify. Their goods have the backing of a fair fame and fortune and deserve a warm reception from the trade. Catalogs and information on application.

THE COMBINED RAILWAY AND LIGHT PLANT AT ASHLAND.

ANOTHER consolidation of electric light and railway work is found in a new plant at Ashland, Wisconsin. It is said to be one of the finest in the northwest. About 200-horse-power capacity is devoted to the railway department and 300 to the electric light. Ideal high speed engines are used with General Electric Company's electrical machinery. The question of plants for supplying both light and railway power has been from time to time discussed in conventions and in the technical press, but has never been agitated at length. If there is economy in large plants against small ones, there ought to be economy in such combined plants.

CONCORD'S CASE.

A BIG dam enterprise is on foot in and about Concord, N. H. A syndicate of New York and local capitalists have already bought considerable land outlying Concord and West Concord village and along the Merrimac river. Across the river at Sewall's Falls a dam is to be built which will furnish the power for an electric plant, which will be utilized for manufacturing purposes, and in connection an electric belt line will be built from the city proper to West Concord, thence to the Falls, where the river will be crossed, and then through the valley to East Concord.

A RAPID SAND DRYING MACHINE.

SAND may well be used to typify the virtuous qualities in a street railway manager, which in other good people is described as salt full of savor. He must have sand and lots of it. Sand in his backbone and sand on his track.

Increase in speed has developed a rapidly increasing necessity for the employment of methods for overcoming that speed not necessary under the horse regime. Sand also comes handy in starting a motor car on an icy track. In fact, sand has been permanently added to the long and varied list of supplies needed in the operation of a street car.

George Carlson, of 112 Oak street, Chicago, and for several years connected with the City Railway, has just invented a machine intended to rapidly, effectively and economically, dry sand for car use. The illustration is in itself a very fair description of the device. From a hopper, at the elevated end of the dryer, the sand passes into

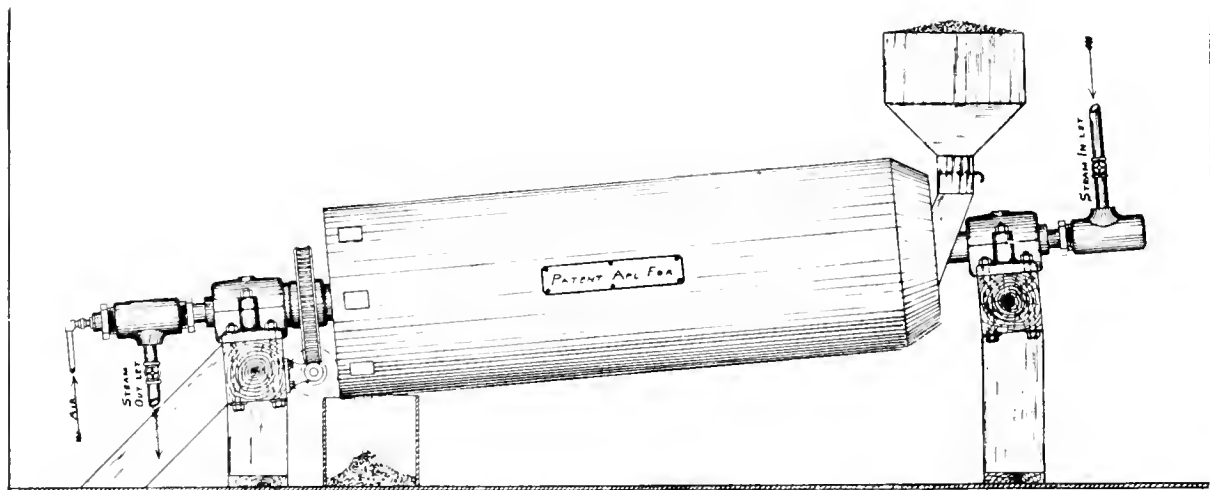

CARLSON'S SAND DRYER

a cylinder and while passing through to be discharged at the lower end is carried around and tossed about so as to expose every particle to the heating influences of the hollow shaft which is filled with steam. The cylinder is revolved by means of a worm gear at the lower end. A current of air can also be forced into the lower end of the cylinder to carry out at the farther end, all moisture and steam as fast as generated. When the sand reaches the escape holes it has traveled 300 feet, and when discharged is perfectly dried and ready for use, or may be stored under cover. The old method of drying occupies several times as much room, and is not nearly as rapid and economical as by the machine. The device is equally well adapted for the drying of grain and other commodities, as the distance traveled in the cylinder may be decreased or increased to any length required.

THE mules of the New Orleans & Carrollton Railway are now being sold in lots to suit purchaser at the lowest prices. Such is the import of the big advertisements displayed by the railway Company.

ELECTRICS AND THE SNOW

THE heaviest storm of the season visited south-central Pennsylvania and Ohio, beginning February 21. The Reading and the Pennsylvania lines were badly blockaded by the snow and all trains were delayed from twenty minutes to an hour and a half. The electric roads, however, were kept in good running order throughout the section of the country, and unquestionably demonstrated the ability of this subtle force to do all that is required of any steam lines. It is true that the mileage of the electric lines was not so extensive, but the conditions were much more trying, in that the snow from the tracks had to be entirely removed, so as not to interfere with teaming. Besides this the sweepers and snow plows on the electric lines are necessarily lighter in construction and less effective than the mammoth rotaries which plow their elephantine path over the roadway of the steam brethren.

There are few places even in the most northerly dis-

tricts, where street car traffic has been interrupted by this severest of "old fashioned" winters, and we know of no line that has suspended operations on account of the snow. Numerous managers have everlastingly earned the respect and gratitude of their fellow citizens by their heroic fight for open traffic. The public is proverbially ungrateful and the hard work and great expense of this winter will probably be forgotten before the spring rains set in, but in such case the manager will be able to solace himself with a re-reading of his winters' compliments.

THE Fulton Foundry Company, of Cleveland, is having great success with their electric trucks No. 1 A and No. 1 B. Within the last thirty days they have received orders for thirty-five or forty trucks and are receiving additional orders from companies that have tried them. There was a sharp competition with well known makers at Springfield, O., and since the first order was given they have received additional orders twice. These trucks are now among the well known and standard trucks of this country.

ELECTRICS POPULAR IN NEW ORLEANS.

IN no city in the country has the introduction of electric cars occasioned as much public interest as in New Orleans. To say all classes of citizens are delighted does not do the subject justice. For the first few days people crowded the cars, remaining on several trips, simply to enjoy the novelty, and it will be some time before all the strictly pleasure riders will have had an opportunity to say they have gone over the line.

Our illustration shows a special party, consisting of the mayor of New Orleans, Hon. John Fitzpatrick and his family and friends, enjoying a trip of inspection in a private car, accompanied by Superintendent Haile and Chief Engineer Johnston. The car is the finest on the road, is handsomely decorated within and has been named

gained his franchises and let his contracts for the immediate building of the road. The system will accommodate that great and growing section of Chicago's metropolitan area near the Indiana state line, north to South Chicago, and toward the lake to East Chicago. A line direct from Hammond to East Chicago will furnish transit between these two centers, with another line between East Chicago and Roby, the Mecca of horsemen, connecting with the South Chicago electric railway and the Calumet. A cut off line gives a direct passage between Lakes George and Wolf from Hammond to Roby. The distance to the state line, including Hammond, is 10 $\frac{1}{2}$ miles, with a total of 13 miles to South Chicago.

The contracts let, go to the following firms: Electric equipment, Westinghouse, eight car equipments of two 20-horse-power motors and one 200-horse-power multi-

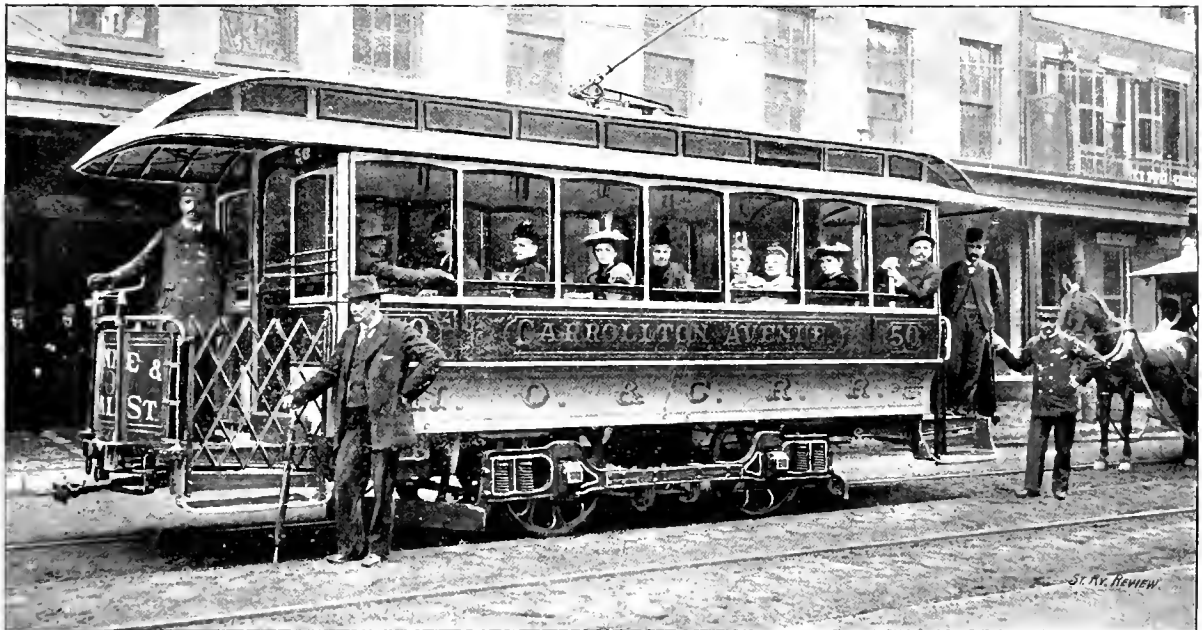

THE INSPECTION TRIP OF THE CARROLLTON LINE.

in honor of the mayor, who is a strong advocate of the new system and who takes great interest in a still further extension of electrics in the Crescent City.

HAMMOND AND EAST CHICAGO STREET RAILWAY.

ONE of the most enterprising firms of railway builders and contractors in the country is lodged in the Pullman Building as C. E. Loss & Co.

Mr. Loss, the head of the firm, is too well known to need any introduction to the street railway public, as his name has been connected for the past few years with so many enterprises in Illinois. One of his most commendable and successful ventures is to be known as the Hammond & East Chicago Street Railway Company, which will furnish rapid transit to fully 70,000 people who have heretofore walked, drove or stayed at home. These undesirable and expensive performances will soon be a thing of the past, as Mr. Loss has perfected his plans,

polar generator; Wharton will furnish 63-pound girder rail for the track; Pullman will build eight 28-foot motor cars; the Railway Equipment Company will furnish the overhead material and Ed. Ayer, Owings building, the poles; J. A. Roebling & Sons will supply No. 0 trolley wire and 000 feeder. The Ball Engine Company put in the steam plant complete, which consists of one 175-horse-power engine, duplicate battery of 100-horse-power with steam piping and fittings. The power house will be of brick, 150 by 80 feet, situated in East Chicago, midway between termini. It will cost \$25,000.

The company which is the last and successful owner of the franchise is a strong one, composed of Wm. Fitzgerald, president, Chicago; Chas. F. Griffin, of Hammond, vice-president, ex-secretary of state of Indiana; S. F. Minzesheimer, secretary; Lazarus Silverman, Chicago, treasurer, and C. E. Loss, general manager. Mr. Loss has financed the company, obtained the franchises, and retains his interest in it by building the line.

MULTIPHASE CURRENTS FOR TRACTION WORK.

ELECTRICAL development in the line of light and power distribution has gone through an evolution brought about by the necessities of the case. For distribution within a limited area direct currents at low pressure were and are still the most economical means. When the demand came for distribution over large areas the electrical engineer finally responded with the system of alternating currents sent out at high pressure and "converted" to a lower pressure by transformers near the place of consumption. This was a great step in advance, as the use of high pressure greatly decreased the amount of copper necessary in the lines. The plain alternating current has not yet been commercially applied to small motors and for supplying the demand for power distribution at a distance the three-phase alternating current is coming into use at present. This current will admit of transformation from one pressure to another and is admirably suited to motor work, though as it requires three leads, is not so convenient for lighting as could be desired. However, the three-phase system has now gained a foothold and its use for transmitting power to a distance may be considered as assured for some time to come. There are two reasons why the multiphase current has not come into use on electric railways. In the first place there have been practical difficulties in the way of making three electrical connections with a moving car. In the second place the railways now in use are so short that there has not been an excessive demand for an economical means of supplying power at a distance from the generating plant. We think, however, that the majority of electricians will agree with the ideas recently expressed by Professor F. B. Badt to a representative of the REVIEW. In his opinion the tendency of thought and invention among electrical engineers is toward the use of multiphase currents and transformers for supplying power to electric railways. Indeed with long distance lines this seems almost a necessity and it might be a great economy in shorter ones. Multiphase currents for railway work have not been tried, but their use is an implied necessity in nearly every scheme involving the transmission of the power from a distance. From the present outlook in the electrical field the multiphase motor is a most promising candidate for future use and there are good reasons for thinking that electric railway work will follow the same lines of development as electric light and stationary power.

As is well-known, Professor Badt has recently received patents on a multiphase railway system, and although he has worked out many details as to the possible ways of making connection with the car, he does not claim that the system as patented will necessarily be a commercial success, but it is to be taken simply as a step in the line of future progress and as indicating "which way the wind blows." In regard to the system, he suggests a few points of interest, showing the advantage such a method would have if put in operation. The

current is sent out from the station at high pressure, say at 5,000 volts. The amount of copper required would be then only $\frac{1}{100}$ of that necessary on the 500 volt system. At intervals along the line are transformers, which reduce the pressure to any very low voltage desirable. At this low pressure the current is led to the conductor rails, three in number, which can be on the surface of the ground, as the low pressure is easily insulated again. These rails are in sections, shorter than the car length, and all sections are out of circuit except the one under the car. The patent includes several devices for cutting in the section under each car. The advantages of such a system would be, (1) no live conductors overhead or under foot, (2) transmission of power from a distance with little loss, (3) applicability of the current to all kinds of work—both light and power, and (4) the use of a commutatorless fire and water-proof motor. The advantage of this latter characteristic will be especially appreciated by men that are in practical work at the present time. The patent also covers the two-phase alternating system which, although having the advantage of requiring only two leads, has as yet no practical motor.

George Von Siemens has also taken out a patent working toward the same end as Professor Badt. "So you will see," said the professor, "that the best talent of Europe is fighting along the same line. I have great hopes of the final issues. My patents may have no commercial importance. The next days' paper may contain news of something further along the line of the same idea, but I am sure that the electrical world is progressing towards the achievement of the ideal. Just when or how the ideal will be reached may not come for some years, but our thoughts and purposes are, perhaps, in advance of our skill."

WANTS HIS SCALP.

THE fascination which a blue coat and brass buttons has for the female heart is an old story. In Cincinnati it is said to be epidemic. Recently on a fashionable line a pretty servant girl and a certain motor-man carried on a desperate and heart rending flirtation. Never did car 717 pass the house but as if automatically a curly head appeared from a lower window and a feather duster or a towel swung greeting to the handsome possessor of badge 210. But alas! One day Mrs. Brown, who is neither young nor flirtatious but whose hair is curly, was standing accidentally at the window usually occupied by the chamber-lady. She was astonished at the actions of a motor man. She turned up her nose, but the reckless, nearsighted motor man deftly threw a kiss. It fell with a cold dull thud on the side of the house, for Mrs. Brown had disappeared. The next day Mr. Brown appeared at the street railway office. He was angry, oh very, and said with many swears that the motor man must be discharged. The next day he came with a new threat that if the offending electricity twister was not discharged that suit at law would be entered. An order is now promulgated that no conductor or motor-man shall flirt even under the most trying circumstances.

CAUGHT ON THE RUSH TRIP.

American Street Railway Association.

D. F. LONGSTREET, PRESIDENT, Denver, Col.
 DR. A. EVERETT, FIRST VICE-PRESIDENT, Cleveland, O.
 JOEL HURT, SECOND VICE-PRESIDENT, Atlanta, Ga.
 W. WORTH BEAN, THIRD VICE-PRESIDENT, St. Joseph, Mich.
 WM. J. RICHARDSON, SECRETARY AND TREASURER, Brooklyn, N. Y.
 EXECUTIVE COMMITTEE—THE PRESIDENT, VICE-PRESIDENTS, and JOHN G. HOLMES, Pittsburg, Pa.; J. D. CHIMMINS, New York City; THOS. MINARY, Louisville, Ky.; JAS. R. CHAPMAN, Grand Rapids, Mich., and BENJ. E. CHARLTON, Hamilton, Ont.
 Next meeting, Exposition Building, Milwaukee, third Wednesday in October.

Massachusetts Street Railway Association.

President, CHARLES B. PRATT, Salem; Vice-presidents, H. M. WHITNEY, Boston, AMOS F. BREED, Lynn, FRANK S. STEVENS; Secretary and Treasurer, J. H. EATON, Lawrence.
 Meets first Wednesday of each month

Ohio State Tramway Association.

President A. E. LANG, Toledo; Vice-president, W. J. KELLY, Columbus; Secretary and Treasurer, J. B. HANNA, Cleveland; Chairman Executive Committee, W. A. LYNCH, Canton, O.
 Meets at Cincinnati on the fourth Wednesday in September, 1893.

The Street Railway Association of the State of New Jersey.

President, JOHN H. BONN, Hoboken; Vice-president, THOS. C. BARR, Newark, Secretary and Treasurer, CHARLES Y. BAYFORD, Trenton; Executive Committee, OFFICERS and C. B. THURSTON, Jersey City; H. ROMAINE, Paterson; LEWIS PERLINE, JR., Trenton.

The Street Railway Association of the State of New York.

C. DENSMORE WYMAN, PRESIDENT, New York.
 D. B. HASBROUCK, FIRST VICE-PRESIDENT, New York.
 JAS. A. POWERS, SECOND VICE-PRESIDENT, Glen Falls.
 W. J. RICHARDSON, SECRETARY AND TREASURER, Brooklyn.
 EXECUTIVE COMMITTEE—D. F. LEWIS, Brooklyn; JOHN N. BECKLEY, Rochester, J. W. McNAMARA, Albany.
 The next meeting will be held at Rochester, September 19, 1893.

Pennsylvania Street Railway Association.

JOHN A. COYLE, PRESIDENT, Lancaster.
 JOHN G. HOLMES, VICE PRESIDENT, Pittsburg.
 H. R. RHODES, SECOND VICE-PRESIDENT, Williamsport.
 L. B. REIFSNEIDER, SECRETARY, Altoona.
 WM. H. LANIONS, TREASURER, York.
 Next meeting, Harrisburg, September 6, 1893.

Alabama.

MOBILE, ALA.—The council extends limit of new Mobile street railway company and grants electric rights under conditions.

Arkansas.

LITTLE ROCK, ARK.—The sheriff has released the street railway under bond. The Atlantic Trust Company has no cause for action unless interest is defaulted.

California.

OAKLAND, CAL.—Work has begun on the 12th street line, known as the Grossmeyer franchise. It is backed by F. M. Smith, the borax king.

OAKLAND, CAL.—A. A. Moore and W. F. Rudolph petition for street railway, electric or otherwise, along the county highway.

SARATOGA, CAL.—C. W. Wooska and G. Henry, of San Jose, propose a road from San Jose to Saratoga. Asked of local residents to give \$50,000. Road ultimately to reach Los Gatos.

Canada

BERLIN, ONT.—The Berlin & Waterloo Railway Company decides to put in electricity for railway purposes and supply light, heat and power.

KALSO, B. C.—Application is in the local legislature for tramway rights here

KINGSTON, ONT.—The street railway committee has recommended that a 40-year franchise be granted the company on streets now occupied.

MONTREAL, CAN.—A. J. Corriveau, local, and W. S. Williams, of New York, hold several valuable franchises, which they will begin to build on early in the spring.

MONTREAL, CAN.—The Montreal Street Railway Company has been awarded the contract in St. Louis de Mile-End. Nevertheless A. J. Corriveau will proceed with the building of the road under previous contract and trust to a law suit. Construction of power house at once.

ST. CATHERINE'S, ONT.—The St. Catherine's-Meniton & Thorwood Street Railway desires proposals for ties, poles, rails, steam plant, overhead and electrical construction.

WINDSOR, ONT.—The consolidation of the Boomer line and the Sandwich, Windsor & Amherstburg line has been effected. W. Hendrie, G. Hendrie, John Davis, et al, are the members of the company. Large extensions to be made.

Chicago.

CHICAGO.—Organized: The Chicago, Niles & Norwood Rapid Transit Company, Chicago; capital stock, \$500,000; incorporators, F. A. Bingham, 112 Clark street, Robert Leeder and John P. Maes. Road to be 9 miles long.

CHICAGO.—The Evanston council grants the Evanston & North Shore franchise, D. H. Londerbeck, president. Pullman will build the cars. The Ogden street railway will soon make application for franchise, to be an extension of the Cicero & Proviso line.

CHICAGO.—Alderman Kent has sent in an ordinance to enfranchise the Midland Rapid Transit Company. Jas. R. Keene, of New York, is at present financial head.

CHICAGO.—The Elwell-Parker Electric Construction Company has organized with a capital of \$500,000, by F. C. Phillips, Robt. L. Tatham and Chas. R. Webster. Tatham and Webster are lawyers at 45 Metropolitan block. It is rumored that the corporation is a branch of the great English house of like name.

Colorado.

BOWIE, MONTAGUE COUNTY, COL.—Head & Co. have been granted rights for street railway here. Company formed by Messrs. Head, Dryden and Tidball. Probably a "go."

DENVER, COL.—The City Park Railway Company asks for cable, horse or electric rights on several outlying streets and avenues.

DENVER, COL.—The Arapahoe Railway Company has secured the right of way and increased its capital to \$250,000.

DENVER, COL.—Thos. A. Drake is chairman of committee to secure extensions of the Tramway Company into South Denver. Tramway company wants \$10,000 bonus and will probably get it.

DENVER, COL.—The Twenty fifth avenue line will be built by the Tramway Company and operated by April 1.

FLORENCE, COL.—The Florence Electric Light & Rapid Transit Company has been organized by J. A. McCandless, H. C. Topping, J. M. Hanks, J. F. Collins, J. W. Work and J. M. Turner, of Florence; J. D. Phillips and J. H. Gillen, of Rockvale; R. S. Easton and George Wilson, of Coal Creek; William McNeil and A. P. Easton, of Williamsburg. Capital, \$100,000.

PUEBLO, COL.—H. E. Chubbuck has been elected general manager of the street railway.

PUEBLO, COL.—J. Parker Whitney, of Boston, has secured options on the street railway plant, the light, heat and power plant, and the gas plant; total selling price, \$1,600,000

Connecticut.

NEW HAVEN, CONN.—The Fairhaven & Westville Horse Railway will probably pass into the hands of a local syndicate and be equipped with electricity before spring.

Delaware.

WILMINGTON, DEL.—Five hundred employes of Edge Moor Bridge Works asks the Wilmington City to extend to that factory.

WILMINGTON, DEL.—Notice has been given in the legislature at Dover that the Chester & Wilmington Electric Railway will incorporate. Representative Day introduces the bill. The road runs to the State line near Claymont and connects with the Chester system.

Georgia.

ATLANTA, GA.—G. H. Mountain, of the Atlantic Traction Company, is at the head of a new company which will build an electric railway on several streets. The Traction Company will extend its lines.

AUGUSTA, GA.—Six mile electric line is contemplated to Murray Hill. Malone Wheelless, Washington, D. C., president; Peter F. McAnnally, secretary; Eugene J. O'Connor, treasurer, of this city. Iron is said to be already purchased.

Idaho.

POCATELLO, IDAHO.—A. A. Courtier, L. S. Keller, et al., have their franchise and are to begin work before May 1.

Illinois.

CENTRALIA, ILL.—S. N. Pierce, V. L. Joy and O. V. Parkinson are interested in the Odin-Centralia line with L. Summerville, et al., of Odin.

CENTRALIA, ILL.—Incorporated: The Marion County Rapid Transit Company, capital stock, \$75,000, to build and operate an electric railway and to furnish light, heat and power; incorporators, S. N. Pierce, O. V. Parkinson, C. B. Ellis, L. Sonnerville, John F. Sugg, S. J. Smith and J. D. Telford.

CENTRALIA, ILL.—The Central City line is to be operated by electricity and extended via Sandoval and Olin to Salem.

FREEPORT, ILL.—Chas. D. Haines, of Kinderhook, N. Y., says that Haines Brothers will install an electric railway system if Freeport will take \$20,000 in stock. The General Electric system will be used. J. B. Taylor, of the car line, thinks the matter will be consummated successfully. The provisional contract has been signed.

NASHVILLE, ILL.—Nashville Mineral Springs Company extend charter to authorize building of street railways and increases capital stock to \$15,000.

PEORIA, ILL.—Incorporated: The South Peoria Street Railway Company; stock, \$100,000; electricity, horse or dummy. Incorporators, Chas. A. North, I. M. Hornbacker, and John W. Culbertson.

PEORIA, ILL.—F. W. Horne, of the General Electric, is superintending the survey of the electric line to Pekin.

PEORIA, ILL.—The Central railway has closed a \$50,000 contract with the General Electric.

PONTIAC, ILL.—The re-organized Pontiac Street Railway Company is capitalized at \$100,000, by J. E. Morrow, D. M. Lyon, R. M. John and C. C. Strawn.

ROCKFORD, ILL.—It is reported that the street railway is about to increase its stock and rebuild parts of the line. The report is regarded as trustworthy.

ROCK ISLAND, ILL.—It is proposed to extend the Red Line and lengthen five switches a quarter of a mile each.

Indiana.

ANDERSON, IND.—Anderson and Alexandria will be connected by an electric line. A. C. Carver and Lant Runyon are right-of-way agents. Russell Harrison & Co. are backing the scheme.

CRAWFORDSVILLE, IND.—Powell & Hatch, of the Kankakee, Ill., Street Railway Construction Company, offer to put electric light and railway plant for \$60,000. Not accepted as yet, but the parties will return again.

MUNCIE, IND.—The Muncie Street Railway has been sold to Russell B. Harrison, through Walker Brothers & Co., of 35 Broadway, N. Y.

NEW HAVEN, IND.—W. S. O'Rourke and J. W. Hayden, of Ft. Wayne, with C. W. Cook, A. M. Hartzell, M. Hellswarth, et al., of this place, are trying to secure stock and interest capital in a road to connect Ft. Wayne with this place. Incorporation will be made April 1. Line estimated to cost \$225,000.

WINCHESTER, IND.—L. H. Prentice, Richmond, Ind., W. D. Riddell, Xenia, Ohio., and W. C. Hartwell, C. E. of Covington, Ky., are looking up route for electric from here to Muncie.

Iowa.

DUBUQUE, IA.—Allen & Swiney lines sold to the Old Colony Trust Company for \$225,000 to satisfy first mortgage. Probably consolidate with Rhomborg now.

IDA GROVE, IA.—F. A. Lusk, Wm. Bendse, J. W. Reed, J. T. Hallam, John Weiser, et al., of this place, are associated to build an electric light and power plant.

SIoux CITY, IA.—The new combine, it is said, will put electricity on the L road.

Kansas.

ATCHISON, KAN.—President Challiss says that New York capitalists have thirty day's operation on the street railway.

KANSAS CITY, KAN.—William J. Buckley, of Ft. Wayne Electric Light Company, has introduced ordinance granting him extensive franchises. The city attorney has been ordered to begin proceeding for annulling the West Side franchises.

KANSAS CITY, KAN.—The West Side Street Railway Company ceases operations March 1. President W. N. Coler, Jr., of New York, asks for a receiver, and it may be abandoned unless sold. Will sell cheap. Taps desirable territory; eight miles, electric.

LEAVENWORTH, KAN.—The franchise troubles are now adjusted by compromise. The new company elected Henry L. Turner, of Chicago, F. G. Jones, of Burlington, Ia., director. Electric power will be introduced and compressed air retired.

WICHITA, KAN.—The electric light and railway companies have consolidated; officers: president, C. E. Dustin, Hartford, Conn.; secretary and manager, J. W. O'Neil, of Wichita.

Kentucky.

LOUISVILLE, KY.—The Parkland, Jefferson county, trustees granted a franchise to T. H. Hayes, R. P. Gregory, M. McDonald, et al., to build an electric from Catalpa and Dumesnil streets fifteen miles to West Point.

Maryland.

BALTIMORE, MD.—Re organized: The Baltimore, Catonville & Elliott Mills Passenger Railway Company, by Geo. C. Jenkins, Michael Jenkins, Nelson Perin, J. K. Cowan, J. D. Cross, Geo. D. Pennyman and W. P. Harvey; capital stock, \$200,000.

Massachusetts.

DANVERS, MASS.—The incorporators of the Haverhill-Danvers Electric are Warren W. Potter, Hamilton L. Perkins, William II. Floyd, Charles E. Wood, Charles H. Davis, Sherman Nelson, Joseph B. Poor, M. B. Bailey and W. B. Brewster.

NEW BEDFORD, MASS.—W. M. Trafford, R. A. Soule, F. O. Dodge, S. C. Hathaway and E. S. Lewis are associated as the Fall River & New Bedford Street Railway Company. The company applies for charter.

NORTHAMPTON, MASS.—John C. Hammond, of the Northampton street railway, wishes to extend into other towns of Hampshire county. J. A. Sullivan, a director, says that with twenty miles of road thousands of people would be given rapid transit. All the outlying villages are manufacturing with no communication except by team.

READING, MASS.—C. F. Woodward, of the Wakefield & Stoneham Electric Railway Company, has good prospects of extending the road to this town.

STONEHAM, MASS.—The Melrose, Malden & Stoneham street railway is making a gallant fight for rights and charter. F. K. Sweetser, of Stoneham, principal director.

TAUNTON, MASS.—All the directors of the Street Railway Company have resigned. John N. Beckley, of Rochester, was elected president. S. M. Thomas, Geo. A. Washburn, and Henry M. Lovering are committee on extensions and changes.

WORCESTER, MASS.—The recently organized Blackstone Valley Railway Company is the last link in the great Worcester combine, called the state Central Street Railway Company. Hon. Samuel Winslow and T. M. Rogers, of Worcester; L. L. Whitney and C. D. Morse, Millbury; A. A. Pond, Boston, et al. are the chief movers.

Michigan.

BIG RAPIDS, MICH.—Campbell & Flynn, of this place, are securing right of way between Royal Royal Oak and Big Beaver for an electric.

DETROIT, MICH.—Fred H. Cozzens, president of the Metropolitan Street Railway Company, says that arrangements are perfected for seven miles of line to the county limits and also possess franchises on Ft. Wayne street. Several extensions are planned and loops proposed. Chas. W. Walton, secretary.

FLINT, MICH.—Judge Cochran, of Toledo, is canvassing the street railway question here. W. F. Davidson, of Port Huron, representing the General Electric Company, is working in conjunction with the judge.

GRAND RAPIDS, MICH.—Incorporated: The Michigan Electric Company, by John E. More, E. F. Sweet, A. C. Sekell, of this city; Charles J. Church, of Greenville, and Dr. O. C. McDaniel and Charles A. Church, of Lowell; capital, \$60,000; to develop water power at Lowell for light and power. Will begin soon to build.

Minnesota.

ST. PAUL, MINN.—The St. Paul City Railway Company propose to the city council: 1. To work double track line to Lake Como. 2. Change East Seventh street to electric. 3. Use open cars during summer. 4. Transfer. 5. Put safety device on Selby Hill. 6. Boulevard University avenue and lay curb. 7. Extend Merriam Park extension.

Missouri.

ST. LOUIS, MO.—The Manchester Road Electric, under the new name of the St. Louis, Kirkwood & Meremec River Railroad Company, has filed its papers. Length of the road is 11 miles. The directors of the company are Thomas Harvard, James Daniels, Thomas M. Gallaher and Alex B. Shaw, of St. Louis, and Matthew Orton, of Chicago. Franchise granted.

CARTHAGE, MO.—The original Rapid Transit Company will meet Feb. 10 to consider turning over charter and right of way to new company. Willard E. Winner, principal, from the East, will be here.

New Hampshire.

MANCHESTER, N. H.—Senator Higgins is the father of a bill to incorporate the Manchester Street Railway Company.

New Jersey.

ASBURY PARK, N. J.—The Asbury Park & Belmar will get its franchise from the Neptune township committee. It is reported that the Patton motor is to be investigated for use.

MILLVILLE, N. J.—Camden capitalists, W. S. Scull, G. Genge Brown and F. R. Fithian, of Bridgeton, Frank Allen, of Millville, et al., organized at \$20,000, wish to build electric two miles long in Millville and extend ten miles to Bridgeton.

NEWARK, N. J.—As predicted by the DAILY the control of the electric light interests will probably go to the Philadelphia syndicate owning the street railways.

NEWARK, N. J.—The United Traction & Electric Company, an Ohio articles of corporation by Henry W. Calhoun, of New York, Adolph H. Larkin, of Nutley, N. J., and Thorwold Stallknecht, of Orange. Principal office to be in Jersey City with branches elsewhere. Little known about it. No connection with New Jersey Traction Company.

Nebraska.

GRAND ISLAND, NEB.—Street car barn burned. Ten cars lost. W. S. Lamon, superintendent.

New York.

BINGHAMPTON, N. Y.—Court Street & East End Railway Company will change from horse to electricity.

BUFFALO, N. Y.—A new road will be built in the northern part of the city from the terminus of the Buffalo Street Railway tracks. This is the beginning of a new, large system and moneyed men, so far unknown, are back of it.

MIDDLETOWN, N. Y.—Chartered: The Middletown Street Railway & Power Company, at \$50,000, by C. Macardell, W. F. O'Neil, W. D. Stratton, et al., of Middletown. Population, 12,000.

NEWBURG, N. Y.—The Newburg, New Windsor & Balmville Street Railway Company is incorporated by B. B. Odell, Jr., J. M. Dickey, W. H. Weston, H. S. Ramsdell, C. T. Goodrich, W. T. Hilton, L. W. Y. McCroskey, W. H. Dickey, Howard Thornton, et al., at \$100,000. Electricity will be used and operations will begin this spring.

NEW YORK CITY.—J. A. McCall, president New York Life Insurance Company; Gen. Lewis Fitzgerald, of the Merchantile Trust Company, and Superintendent F. K. Hain, of the Elevated, are incorporated to build, buy and operate street railways; capital, \$5,500. President McCall says New Jersey will be the scene of their operations, owning the Paterson road and two horse lines. The company is strongly organized and will be big operators.

NEW YORK CITY.—The Third Avenue Street Railway Company petitions for a nine-mile extension. The Union Railway Company submits agreement to conditions imposed by city council for lines in the annexed district.

NIAGARA FALLS, N. Y.—The Niagara Falls Suspension Bridge & Railway Company will vote on March 1 to increase stock from \$250,000 to \$750,000. The line is to be extended and improved to the extent of the increase. President Gaskill will increase the plant 125-horse-power.

POUGHKEEPSIE, N. Y.—H. J. Hinckley, of this place, bought the city railway franchises and will begin to change to electric immediately.

ROCHESTER, N. Y.—Glen Haven Railroad bought for \$1 by holders of second mortgage. John D. Lynn, Edward W. Mauer, F. S. Minges, E. W. Huntington, James Palmer, Jr., Frank P. Crouch, Herman Behn, George Arnoldt, Leo A. Schlitzer, Thomas Rhodes, Edward J. Esler, Frank Ritter, Nicholas Brayer, George M. Glasser will re incorporate the line.

ROCHESTER, N. Y.—The capitalists buying the Rochester & Glen Haven road met with E. W. Maurer, organized and decided to equip with electricity, new rolling stock and standard gauge.

ROCHESTER, N. Y.—The Rochester syndicate, John N. Beckley, A. G. Yates, E. M. Upton, et al., has bought the Taunton, Mass., lines with 15 miles of track. Electricity immediately to be put in.

SCHENECTADY, N. Y.—The Schenectady Street Railway Company asks for rights to supply light, heat and power to the city. Probably be granted.

SYRACUSE, N. Y.—W. W. Hazard, president; W. R. Kimball, Cincinnati, and L. Flick, Wilkesbarre, Pa., with others of the syndicate, will meet here February 25.

TROY, N. Y.—The city railway accepts franchises given by city. J. J. Hagen, secretary.

North Dakota.

DEVIL'S LAKE, N. D.—Prominent citizens organize at \$50,000 to put in light and railway plant; railway to run to Chautauqua grounds.

Nova Scotia.

HALIFAX, N. S.—The Old Colony Trust Company, of Boston, Mass., acquired the Nova Scotia Power Company—plant and all. The new people will put in an electric railway.

Ohio.

BRIDGEPORT, O.—Parties said to represent the Westinghouse have bought the Bellaire horse line to electrify; freight and passenger and to extend to this place and Lenaville.

CANTON, O.—The Canton-Massillon road has increased its stock from \$200,000 to \$300,000.

CALEDONIA, O.—John Huber says that Morrow, Marion and Knox counties want an electric road and can support it.

CLEVELAND, O.—G. O. Ford, Geo. Hoyt, L. Allen, et al., ask to run a double track street railway on Willson avenue from Woodland to the lake. Ford-Washburn storage batteries to be used. The East Cleveland asks to double track parts of their line.

CLEVELAND, O.—W. C. Scofield and G. F. Scofield want to run a double track street railway to Gordon Park.

CLEVELAND, O.—It is understood that the consolidation of the East Cleveland and the Broadway will be announced shortly. E. C. enters at \$5,600,000 and the Broadway at \$2,400,000.

CLEVELAND, O.—A. L. Johnson applies for right to build the much needed line to Gordon Park. Mr. Johnson is requested by the board of control to secure the right of way.

CLEVELAND, O.—The Cleveland City Cable has gained its trolley rights on St. Clair street over the mayor's veto.

CLEVELAND, O.—H. A. Blood, J. W. Wardwell, H. R. Moore incorporate the Cleveland Transfer Railway Company; road four miles long; capital, \$1,000; steam or other power.

CINCINNATI, O.—John and Chas. Kilgour, who have acquired the stock of the Mt. Lookout Dummy System, will change it to electricity this summer. The Cincinnati Street Railway Company will make many extensions.

COLUMBUS, O.—The Westerville extension has passed the council.

COLUMBUS, O.—Crosstown Street Railway Company organized by Cotton H. Allen, Wm. F. Burdell, W. D. Park, F. W. Prentiss and N. O. Sims at \$2,000,000. Fred Prentiss, of the Clinton National Bank, says it is a "go." Two thousand dollars incorporation fees paid. Considered as a branch of the Consolidated; denied by that corporation, which says it will work in unison.

CONNELAUT, O.—E. M. Comstock is trying to get franchise for street railway on several streets for Blair, Comstock & Co. Horse or electric. Conneaut has 4,000 people.

DAYTON, O.—The Dayton-Springfield-Cincinnati electric is said to be a solid enterprise, with Ex-Governor Foraker, Gen. A. Hickenlooper, Col. L. C. Wier, W. A. Goodman and S. M. Felton at the head.

DAYTON, O.—Incorporated at \$10,000; the Dayton, Germantown & Middletown Electric Railway. Incorporators, A. E. Boone, Chas. L. Duham, F. B. Lilly, J. B. Yates and M. T. McGregor.

FINDLAY, O.—The proposed extension of the Findlay street railway to Fostoria and other points employs Wm. Norris as right-of-way agent.

LIVERPOOL, O.—The Liverpool & Wellsville line will extend 18 miles to New Lisbon and then 10 miles to Salem.

MARTIN'S FERRY, O.—Jolly Bros., of Pittsburg, A. R. Lyde, Beaver Falls, Pa., and associates will build an interurban line in this section to Bellaire. Mining region.

NORWALK, O.—Norwalk Light & Power Company reorganizes at \$25,000 with directors W. R. Huntington, of Cleveland, D. W. Vail, A. L. Osborn, Charles Suhr and Fred Colson. Increased power plant wanted.

NILES, O.—The Mineral Ridge & Niles Company loses one car in a car barn fire; insured.

TOLEDO, O.—Park commissioners have agreed to allow all necessary switching and side track facilities for park terminals, and both the Consolidated and the Robinson will extend their lines to Ottawa Park.

TOLEDO, O.—A. L. Backus confesses that Eastern and local capital seeks to consolidate electric interests here.

TOLEDO, O.—David Robison, Jr. & Sons have been granted ordinance on several streets.

WOOSTER, O.—B. M. Barr, of the Central Electric Company, has given bond of \$5,000 for the construction of the electric here.

Oregon.

EUGENE, ORE.—Petition in circulation asking the county court to grant electric road rights across steel bridge at Springfield. This means the furtherance of the Eugene-Springfield road.

PORTLAND, ORE.—J. B. Mehama, of Sunnyside, proposes to put an elevated car line on Taylor street. The single track railway, an invention of Mehama, is to be used.

PORTLAND, ORE.—Portland Consolidated asks franchises on several streets. Ordinance passed. Sale of the East Side Electric Light plant to the Portland General Electric authorized by council.

PORTLAND, ORE.—The San Francisco bondholders of the Portland Cable have been investigating the road through Prentiss Smith, of Sacramento, and F. L. Brown, of the Washburn-Moen Company, of San Francisco, with a view of foreclosing the mortgages and reorganizing the company.

Pennsylvania.

ASHLAND, PA.—W. F. Harrity and Dallas Sanders, of Philadelphia, buy the Schuylkill Traction Company.

BRIDGEPORT, PA.—Chartered: The Montgomery County Passenger Railway Company. Capital \$50,000. Incorporators, Cornelius Gallagher New York; Edward S. Perot, Yonkers; John W. Dettera, Norristown; James A. Grath and Phillip J. Crimen, Conshohocken.

DRIFTON, PA.—Chartered: The Union Electric Street Railway Company, of Drifton, Freeland and Lehigh. The directorate is Harry E. Sweeney, of Drifton, president; Horace E. Hand, Fred W. Bleckley, W. H. Jessup, Jr., and E. D. Wightman, Scranton.

EASTON, PA.—It is now known that the Lehigh Valley Traction Company is headed by A. L. Johnson, of Cleveland, J. K. and Howard Page, of New York, Charles H. Edwards, Allentown, Pa., et al. Road to begin soon to construct through a number of towns in the valley. The plans seems to be a general network of several recently organized lines. Mayor Grace, of New York, and J. F. Gwinner, of Easton, president and treasurer of another line which will join. The latter road is known as the Allentown & Philadelphia. C. J. Erdman, Allentown, and George Ross, Doylestown, are solicitors.

EAST MONONGHELA CITY, PA.—Incorporated: The Monongehela City Street Railway Company, capital \$15,000; to build two and one-half miles electric. Directors: Harry Higenbotham, Charles Hinds, W. K. Law and D. A. Cameron, of Pittsburgh.

ERIE, PA.—The Erie Motor will double track and make extensions.

HARRISBURG, PA.—Incorporated: The Citizens Railway Company, of Chester county, by W. P. Snyder, T. L. Eyre, W. G. Pennypacker and Jos. H. Baldwin, at \$50,000.

HUMMELSTOWN, PA.—E. M. Hoffer, of this place, has the contract for the building of the Gettysburg electric line. It is understood that the Philadelphia & Reading R. R. is an active promoter of the scheme.

LEWISBURG, PA.—The Union county road, from here to Mifflintown, is an assured success. Silas Patterson, of Mifflintown, H. E. Gatelins and B. K. Focht, of Lewisburg, and E. W. Tool, of Freeburg, are the directors; stock, \$100,000. Building will begin in the spring.

MCKEESPORT, PA.—The Citizen's Company will extend to Port View bridge. The electric light Company furnishes power until the power house is completed.

PHILADELPHIA, PA.—The Frankfort & Southwark Passenger Railway has practically gained control of the Second and Third streets systems. The consolidated system will have seventy-nine miles of track. Jeremiah J. Sullivan is president of the F. & S.

PHILADELPHIA, PA.—Inter-State Traction Company to do business in Gettysburg and Philadelphia, is incorporated; capital, \$60,000, by Patricius McManus, Jas. B. Reilley, I. T. Reiter, C. Aiken Jones, H. L. Chandler, Alex Sims, of Philadelphia, and E. H. Chandler and Chas. F. French, of Kansas City.

PHILADELPHIA, PA.—Chartered: The Powelton Avenue & Thirty-fourth Street Passenger Railway, organized at \$20,000; G. A. Aldridge, Audubon, N. J., president.

PHILADELPHIA, PA.—Federal Street Passenger Railway; capital, \$20,000. Organized: J. A. Rigg, president; Thomas B. Foot, Nelson Satler, et al., incorporators.

PHILADELPHIA, PA.—The Philadelphia & Delaware County Electric has organized. President, James S. Austin; secretary and treasurer, E. M. Sayen. These, together with Congressman John B. Robinson, of Media; W. I. Shaffer, of Chester; Dr. J. W. Phillips, of Primos; Samuel L. Kent, of Clifton Heights, and Edward V. Kane, of Lansdowne, are directors. The line is to be five miles long.

PITTSBURG, PA.—Geo. B. Hill says that the Pittsburg, Allegheny & Manchester will buy fifteen summer cars.

PITTSBURG, PA.—Organized: The Sewickley Valley Passenger Railway Company, at \$100,000, by F. J. Tener, of Osborne; W. B. Rommel, Pittsburg.

PHOENIXVILLE, PA.—Phoenixville Electric Street Railway Company, from here to Harveyville, capital, \$60,000. President, Francis Fleming; directors, C. K. Perot, C. P. Perot, W. C. Hannis, Philadelphia, R. W. Davis, Lower Merion.

SCRANTON, PA.—The Northumberland, Bloomsburg & Scranton Street Railway Company will aim to connect 39 Pennsylvania towns in the route named. S. R. Coyle, of Shennadoah, is president, but rumor says the Philadelphia syndicate is behind the deal.

SCRANTON, PA.—Organized: Scranton & Carbondale Traction Company, \$10,000, by Alfred N. Chandler, Philadelphia; William W. Mayfield, J. W. Noles, S. D. Pettit and H. H. Sively.

SCRANTON, PA.—Chas. Smith, of Wilmington, Del., is to be Superintendent of the Traction Company; Vice W. S. Mears resigned.

WEST CHESTER, PA.—The new street railway elects T. Pennypacker of Marshalton, president. Line to be seven miles long.

Rhode Island.

WOONSOCKET, R. I.—A 20-year franchise has been granted the Woonsocket Street Railway Company. Extensions will be made into Massachusetts.

PROVIDENCE, R. I.—It is reported that the Metropolitan Traction Company, of New York, has bought the controlling interest in the Union City Company, which has trolley rights.

Tennessee.

MEMPHIS, TENN.—The East End Dummy Line will probably be absorbed by the Citizens' Railway and made an electric. Manager Bunch is here from the East.

Texas.

DALLAS, TEX.—Chartered: The Queen City Railway Company, of Dallas, to procure franchises, construct, equip, buy, etc., street railways in Texas, especially in Dallas. Capital stock, \$40,000; directors, A. W. Childress, J. S. Armstrong, of Dallas, and B. E. Sunny and C. L. Wakefield.

Utah.

PROVO, UTAH.—C. E. Luse, S. R. Thurman and V. L. Halliday ask for a franchise, as the old franchise of the U. N. & C. Railway has been annulled.

SALT LAKE CITY, UTAH.—Nearly half a million is to be expended by the city railway in betterments. A. W. McCune has sold \$1,500,000 of bonds in New York. New rolling stock will be ordered soon and more electrical equipment is asked for.

Vermont.

BENNINGTON, VT.—Galen Moses and F. H. Twitchell, of Bath, Me., will form company under New York law and build an electric to Hoosick Falls and other near-by places.

Virginia.

RICHMOND, VA.—W. H. Palmer, T. W. Pemberton, T. M. R. Talcott are granted right to build electric street railway from Manchester to Petersburg.

RICHMOND, VA.—The Richmond & Manchester's two lines have passed into the hands of the Richmond Railway & Electric Company. Consideration \$400,000, in 5 per cent gold bonds.

West Virginia.

WELLSBURG, W. VA.—Prominent local capitalists, Sam George, Mayor McCleary and ex-Sheriff Curtis will build a street railway to connect several small towns, whose present communication is by hacks.

ELKINS, W. VA.—Davis, Elkins & Keren's Electric Light Company has been organized to light railroad shops and town.

WELLSBURG, W. VA.—Sam George and others here form company at \$35,000 to build road to Lazearville; total population about 4,000.

Washington.

SEATTLE, WASH.—Franchise extended for the Grant street line of the Ranier Electric & Power Company.

Wisconsin.

MILWAUKEE, WIS.—Capt. Fred Pabst has an elevated railway scheme on foot for his brewery and vicinity. To cost \$250,000 and use dummies

MILWAUKEE, WIS.—The Standard Car Company, incorporated by F. N. Merrill, Ezra Dedrick, and N. Merrill, will put a noiseless, smokeless steam motor on the market.

MILWAUKEE, WIS.—A. B. Myers, Richard Thomas and H. J. West incorporate Milwaukee West End Company at \$2,500,000, to quarry, make brick and build street railway line.

WAUSAU, WIS.—B. E. Jones, J. D. Ross, W. Alexander and H. Dunfield have been granted street railway franchise here, to begin work June 1 and finish in 18 months; population 10,000.

Winter Resorts of the South.

Jacksonville and Tampa, Fla., and other South Atlantic and Gulf Coast resorts can be reached with but one change of cars from Chicago, and that at Louisville or Cincinnati, where the Monon makes close connection with the L. & N. and Q. & C. Vestibule trains, running through to Florida.

The Monon's day trains are now all equipped with beautiful new Parlor and Dining Cars, while its night trains are made up of Smoking Cars, Day Coaches, and Pullman and Compartment Sleepers, lighted by electricity from headlight to hindermost sleeper.

The Monon has gradually fought its way to the front, making extensive improvements in its road-bed and service, until to-day it is the best equipped line from Chicago to the South, offering its patrons facilities and accommodations second to none in the world, and at rates lower than ever before.

LARGE HIGH SPEED TANDEM COMPOUND ENGINE.

IN the engine shown in our engraving the Ball Engine Company believe they have a winning competitor of the slow speed Corliss running, at 60 revolutions per minute and doing railway work. The engine in question is a 400-horse-power tandem compound, and is intended to run at about 210 revolutions per minute, with a piston speed of 600 to 700 feet and a steam pressure of 100 to 115 pounds. By having the rotary speed high the dynamo and engine pulleys are made nearer the same size and a larger belt contact on the pulley faces made possible. Great care has been taken to balance the parts and the long experience of the builders in making smaller engines of similar design has helped them greatly in this work. The high pressure valve is worked from the governor:

The two ninety-six inch fly wheels running at the high speed they do are equivalent to twice their weight made into a twenty foot fly wheel running at 60 revolutions per minute. These engines have been in use in a number of places over the country for a year past and have given the best of satisfaction.

THE BEST MEN KNOW IT.

A DELEGATION of the best business men in Milwaukee, composed of Patrick Cudahy, C. M. Cottrill, C. C. Rogers, T. L. Kelly and B. B. Hopkins, have made an inspection of the Villard lines at Milwaukee and make a bold and manly report on affairs, to the effect that it will be detrimental to the city's interests to adopt any harsh or restrictive legislation. This report will be formally delivered to the council at its next meet-

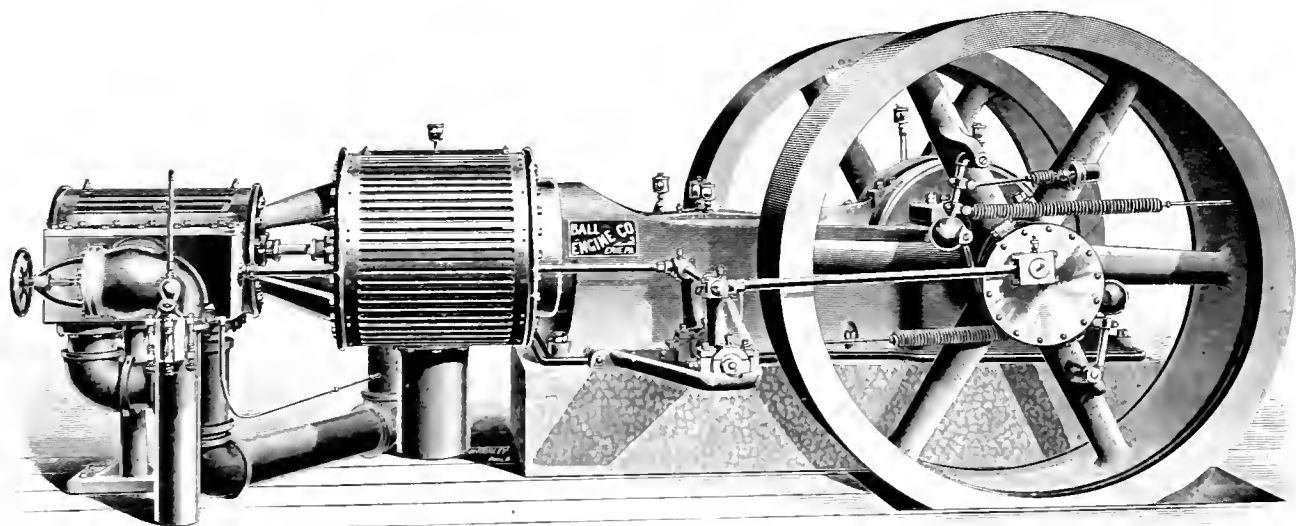

BALL HIGH SPEED TANDEM ENGINE.

and the low pressure by a direct connected eccentric on the other end of the shaft. This latter eccentric is intended to be adjusted after the engine has been run and the best position is ascertained by actual conditions. The makers consider the practice of putting the low pressure cylinder behind the high pressure, on account of the difficulties in the way of getting the valve motion to the high pressure cylinder, as analogous to putting the small piers in a bridge far out in the river and the large ones near the shore. The load in a compound engine is taken by the high pressure cylinder when light, and distributed between the low and high when heavy. These being the conditions, it is claimed that the low pressure cylinder should be put first, thereby affording a better supported and more rigid construction. The engine shown in the engraving has 18 inches low pressure and 30-inch high pressure cylinders, with 15 inch stroke. The stroke is purposely made short to give a higher rotation.

ing, when the committee will appear, urging fair treatment of the corporation. This is only one case among a hundred of the best business men, knowing the exigencies of business relations, interests and risks; appreciating a street railway. If you want to find a real genuine kicker don't go to a business man but talk it over with some sandbagging legislator, some ward-heeler, some fellow that hasn't much more than his nickel, or a sensational newspaper. There you'll find your genuine kicker.

A NEW use for electric cars has been discovered at Evansville, by a teamster, whose paraphernalia stuck in the Indiana mud and immediately across the tracks of the street railway. To remove the obstruction a motor man gently ran his car against the wagon, gradually increasing the power until team, wagon and teamster were pressed onto hard ground.

CHICAGO CABLES REPORT.

THE reports for the past year, the plans and officers for the coming twelvemonth, and the annual meeting routine have been disposed of to the following effect by the different Chicago street railway lines.

THE CHICAGO CITY RAILWAY

showed a most encouraging balance sheet for the year 1892, with receipts aggregating \$4,400,943 and cost of operating \$2,309,431, giving gross profits of \$1,591,511, less dividends, \$840,000, interest \$230,873, less depreciation \$29,500 giving a balance of \$491,137. The total number of passengers carried was 88,018,861.

To the rolling stock 130 box and 150 open cars have been added giving a total present equipment of 1,739 cars. Only 36 horses have been added giving 2,611 on hand. The cable mileage has been increased by .5 on the Michigan avenue loop, 2 miles on Forty-seventh street, 1.75 on Sixty-first, 4 on Thirty-fifth, loops on Stony Island and Sixty-third. .75 and .30 on Thirty-fifth, making a total of 9.3. Paving was laid to the amount of 37,056 square yards of granite, and 27,058 square yards of wood block.

There were laid 16.25 miles single track for the electric lines, equipped with poles and cross wires. The power plant at Wabash and Fifty-second is now one-third complete and the line will be in running order by May 1. The directors for the ensuing year are as follows: L. Z. Leiter, Jas. C. King, E. M. Phelps, D. C. Pearson, S. W. Allerton, W. B. Walker, Geo. H. Wheeler, with no change in the officers.

WEST CHICAGO STREET RAILROAD COMPANY.

At the meeting since our last issue the annual report of the West Chicago states that the receipts of the company for 1892 were \$4,620,225.30, with operating expenses of \$2,687,310, the earning being \$1,932,914. The leased roads rental equalled \$490,500, coupon interest \$253,496 and interest taxes \$151,078, leaving \$1,037,839.25 applicable to dividends, from which \$725,000 were paid out in dividends, leaving a balance to the surplus fund of \$312,839.25.

There were carried 94,518,474 passengers during the year, and 151 box and 80 open and one grip car added to the equipment, making a total equipment of 1,485 at the year's end. One hundred and twelve horses were added, giving 4,025 animals on hand. The year's construction work includes a new power house and six-story office building at Blue Island avenue and Twelfth street, a new power house at Van Buren and Jefferson streets, a new car house and horse barn at Odgen avenue and Twenty-second street, new machinery doubling the capacity of the Washington street plant, new cable loop on Franklin, Van Buren, Dearborn and Adams streets, with new tracks on Ashland avenue and Paulina street from Milwaukee avenue to Twenty-second street, on Western avenue, on Kedzie avenue, on Ogden avenue, on Chicago avenue, on Grand avenue, on Crawford avenue, on Colorado avenue, on Milwaukee avenue, and

on Lake, Eighteenth and Fourteenth streets, making a total of 185 miles of track controlled by the West Chicago Company.

The large construction work and new loop facilities give grand promise for future traffic in districts on the great west side which have not yet been afforded rapid transit facilities.

THE NORTH CHICAGO COMPANY

gathered in \$2,521,511 from passengers during 1892, and added \$89,748 to this sum from rentals and advertising, making a total earnings of \$1,277,207. The first charges were: Rental, \$263,154; interest, \$183,683; insurance, taxes, etc., \$77,822, making a total of \$524,660, and leaving a credit to the income account of \$752,546, with \$629,864 from 1892, making a total of \$1,382,411, from which \$575,000 was paid in 11 per cent dividends, leaving \$807,411 to the good of 1893, from which liabilities not heretofore charged out, amounting to \$79,001.96, gave a balance credited to income of \$728,409. With this magnificent showing it may be noted that 50,419,457 passengers were carried, with a total of 8,547,791 miles traveled. The betterments included the herculean task of relaying Clark street with Johnson girder, and car barns at Center street, Lill avenue, Limits Station and La Salle avenue.

SACRAMENTO'S SYSTEM.

THE recent changes of managements of various street railway lines have left in more or less chaotic condition the ideas of easterners as to the exact state of affairs on the Pacific coast.

One system at least has come to a thorough understanding of itself by the recent purchase of the Central Electric railway of Sacramento, by Albert Gallatin and Horatio T. Livermore, in behalf of the Sacramento Electric Power & Light Company, whose officers are at 320 Sansome street, San Francisco.

The road consists at present of 16 miles of 40 and 52 pound girder rail track, operating 24 electric cars by power furnished by the Capital Gas Company and using Thomson-Houston equipment. There is in prospect four miles more of road in the city and a large suburban extension.

The new company has in view also an unique power plant, to be situated on the American river, 20 miles distant and operated from the water-power of the Folsom Water Power Company. This will require a 20-mile transmission, for which franchises are already granted. This power will not only furnish the street railway but will light the city and give small power users the benefit of stationary motor equipment.

The officers of the company are: President, Albert Gallatin; secretary, Joshua Barker; treasurer and general manager, Horatio T. Livermore.

OSBORNE & COMPANY, of Kansas City, agents for the Eddy motors, are also agents for the Crown shade made by McIntire & Company, of Philadelphia.

A NEW STREET CAR BRAKE.

A COMPANY has just been formed at Grand Rapids, Michigan, to do business under the name of the Automatic Car Brake Company. It owns the Stillwell patents, which are considered about as strong and original as can be obtained. The action of this brake is governed by a lever on the motorman's platform and can be applied to trailers so as to be efficient on the whole train. The insufficiency of the brakes on electric motor cars has been often criticised, and it has been said that the progress in brakes has not kept pace with the progress in motive power. This brake, however, seems to be a step in the right direction. The Stockwell acts instantaneously, and does not require the time-costly process of "winding and unwinding" a crank handle, as does the common brake. Another point in favor of this improvement is the flexible connection between motor car and trailers, making a very easy starting train, besides greatly lessening the starting strain on the motor. The brake is as delicately adjustable in application and quick in action as the Westinghouse air brake, of world wide reputation. It has been tried on a number of cars on the Grand Rapids line, and orders have been placed for more equipments. Andy Beaver, formerly manager of the railway at Grand Rapids, will push the sale throughout the country. The reputation of the stockholders of the company, who are among the substantial and level headed business men and manufacturers of Grand Rapids, is a guarantee that the enterprise is not without promise of good practical results. The officers of the company are,

tion from electric roads. Cable roads, it is true, have pretty generally fitted themselves with powerful and quick acting brakes, but partly owing to the difficulty in getting

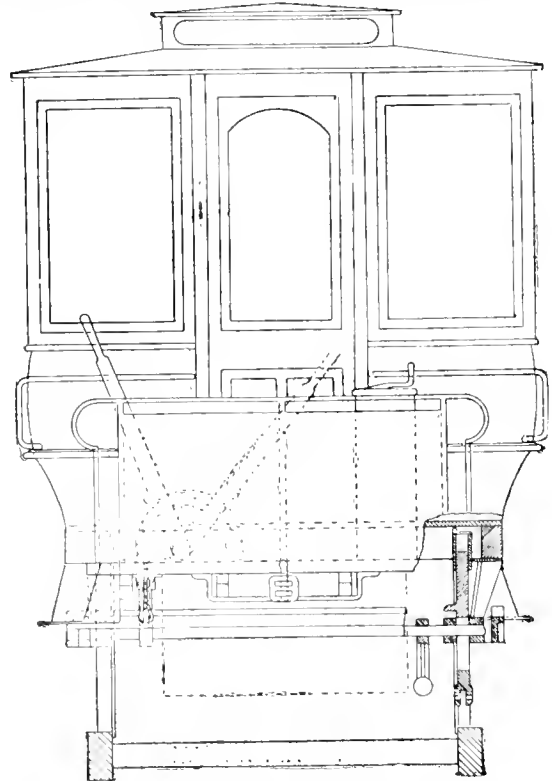

suitable levers on the platform of a motor car, "deadly electricity" has been blamed with accidents from collisions

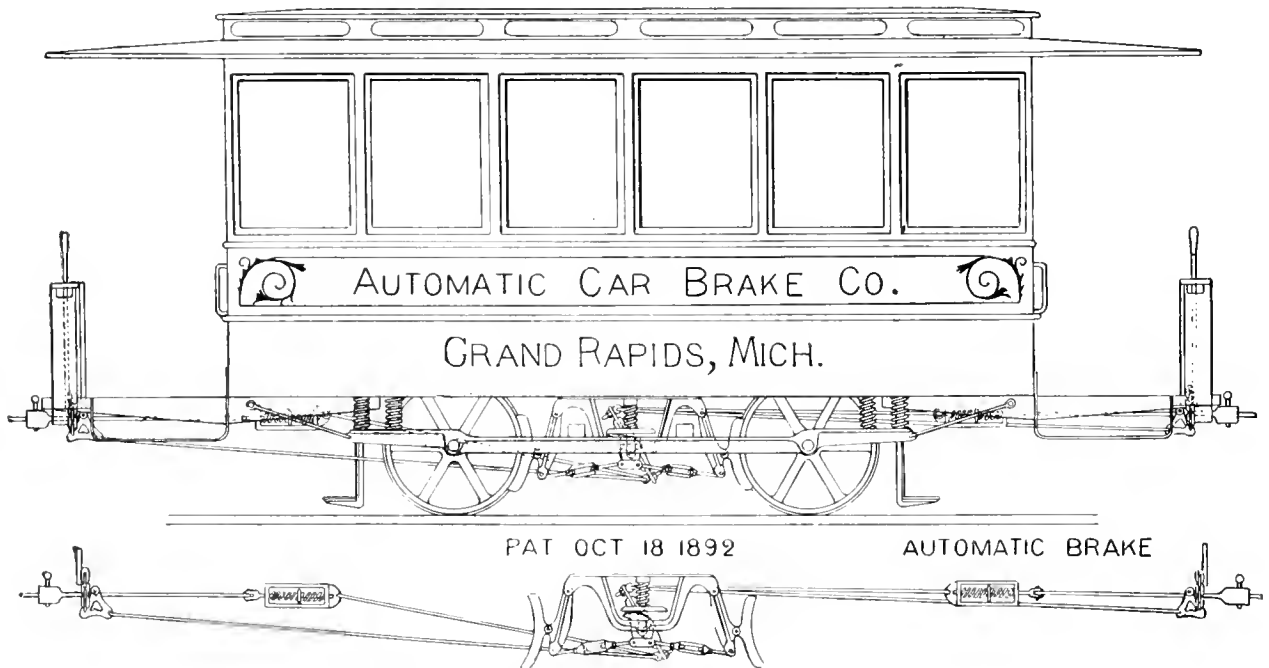

S. W. Peregrine, president; C. B. Judd, vice-president; L. W. Wolcott, treasurer; C. V. C. Ganson, secretary, and M. E. Stockwell, manager.
The brake problem has not yet received enough atten-

tion that do not belong to it, and should not have occurred with powerful brakes. The control of trailers is another subject that is worthy of consideration by every careful manager who values time.

ECHOES FROM THE TRADE.

W. E. HAYCOX, of the Fulton Foundry Company, recently sold 234 draw-bars in two days.

THE AMERICAN CAR COMPANY, St. Louis, are still having trouble to keep up with orders.

J. M. JONES' SONS, Troy, N. Y., has sold five 10-bench open cars for spring delivery to the Springfield, Mass., street railway company.

THE GRAHAM EQUIPMENT COMPANY will furnish Graham trucks, numbers 32 and 10, to the Consolidated Railway Supply Company.

THE E. P. ALLIS COMPANY, of Milwaukee, are at work on \$400,000 worth of additions. The company's contracts at present mount up to the little sum of \$2,500,000.

J. E. RHODES & SONS, of Philadelphia, have made arrangements for the increasing of their power and floor space, owing to the large amount of belts being ordered for electrical work.

THE STANDARD PAINT COMPANY, of New York, is sending out a handsome porcelain plate for use on desks. It sets forth its preservative paints, insulating varnishes, etc.

GEORGE CUTTER, 329 Rookery, Chicago, has just issued his 1893 catalog of supplies and specialties. It is very complete as well as being an elegant specimen of the printer's art.

J. P. SJOBERG & COMPANY, of 155 and 157 Eleventh avenue, New York, are crowded with orders for cars and car supplies, owing no doubt to the care with which they fill orders to the smallest detail.

TAYLOR GOODHUE & AMES are the recently appointed agents of the Campbell Electrical Supply Company, of Boston, for whom they will handle insulating points, feed wires and the Shaw radial trucks.

THE HAMMOND ELECTRIC STREET RAILWAY, Hammond, Ind., is approaching completion. The steam plant was furnished by the Chicago office of the Ball Engine Company, 506 The Rookery.

J. W. PARKER & COMPANY, Philadelphia, representatives of the Ball Engine Company, Erie, Pa., are installing an 80-horse-power Ball engine at Malden, W. Va., for experimental mining hauling.

THE BATES MACHINE COMPANY, Joliet, Ill., have increased their capital stock to \$100,000, and will continue to enlarge their facilities, which press of work has compelled them to do with most satisfactory regularity.

THE DODGE MANUFACTURING COMPANY, of Mishawaka, Indiana, have secured the contract for over a mile of steel shafting for Machinery Hall at the World's Fair. The sizes range from 3 to 6 inches.

THE FORD-WASHBURN STORELECTRO COMPANY have established a branch office at 206 Temple Court, this city, with Frank D. Rustling as manager. They handle batteries for traction and lighting purposes.

THE BLAKELY & DICKSON TRACTION COMPANY, of Scranton, will use three 300-horse-power Ball engines; and the Tampa Street Railway & Power Company have ordered a 200-horse-power cross compound.

STERN & SILVERMAN, previously well known as connected with the Pennsylvania offices of the General Electric Company, have started out for themselves at 707 Arch street, Philadelphia, and will do a general engineering and construction business.

THE GARTON-DANIELS ELECTRIC COMPANY, of Keokuk, Iowa, report that the demand for the Garton Lightning Arrester is larger than expectations, and they have been obliged to increase their force to supply orders. The demand seems greatest for street railway circuits.

THE BROWNELL CAR COMPANY, St. Louis, has a very flattering letter from President Yerkes on the satisfaction the Accelerator cars are giving on the North Chicago road. It states that all new closed cars on that line will be of the Accelerator pattern.

THE RAILWAY EQUIPMENT COMPANY, this place, is calling the attention of eastern roads to its ability to furnish everything needed on electric roads. Their type G overhead material is now a standard construction, recognized by contracting parties as of the highest grade.

EUGENE MUNSELL & COMPANY, of New York, handling micanite, to which so much attention has recently been called through a discussion of its qualities at the American Institute of Electrical Engineers, are having a great demand for that valuable insulator.

THE power station being built by the Calumet Electric Street Railway Company, Chicago, Ill., is approaching completion. The engines to be used are four 300-horse-power Cross Compound Ball engines, manufactured by the Ball Engine Company, Erie, Pa.

GEORGE CUTTER has brought two suits against the Carpenter Electric Heating Manufacturing Company, of St. Paul, on account of their car heaters and similar devices. One suit is to set aside the Carpenter patent, while the other asks for an injunction, with accounting.

THE WESTINGHOUSE ELECTRIC & MANUFACTURING COMPANY has taken the contract for the equipment of the Catherine & Bainbridge line at Philadelphia. The order calls for 600 motors and eight 500-horse-power direct coupled generators and engines. This is one of the largest orders ever placed, and is a telling compliment to the high standard of the Westinghouse apparatus.

THE PHILLIPS INSULATED WIRE COMPANY, of Pawtucket, R. I., has opened headquarters at 39 and 41 Courtland street, New York. The new president of the company is H. C. Adams, who has a large circle of friends in the electrical field.

THE NEW AMERICAN TURBINE made by the Dayton Globe & Iron Works Company, is showing the increasing use of water power for dynamo driving for power transmission. A number of street railway and electric plants are on the order books of the company.

STROMBERG, ALLEN & COMPANY, so well-known as street railway and railroad printers, have added to their already extensive business a department which promises to grow to magnificent proportions, in opening a general stationery store at 335 Dearborn street. The new department adjoins their printing establishment and will carry a complete line of office material. On account of their manufacturing facilities all orders, large and small, can be filled promptly. Street railway officials in need of office supplies, special forms and blanks and general work will do well to correspond with the firm.

THE LAMOKIN CAR WORKS are running night and day to take care of their orders. They have over one hundred and fifty cars on their order books and have refused orders on account of not being able to make deliveries as wanted. They will soon, however, be in a position to deliver large orders for September.

THE MCGUIRE COMPANY'S truck orders for the last thirty days mount up to a handsome figure. They are as follows: Consolidated Light & Power Company, Huntington, West Virginia, 4; White Line Street Railway Company, Dayton, Ohio, 7; Cedar Rapids & Marion Street Railway Company, 4; Hot Springs (Arkansas) Street Railway Company, 10; Rochester (New York) Street Railway Company, 72; Bay City (Michigan) Consolidated Street Railway, 2; Central Railway Company, Peoria, Illinois, 9; Chicago & North Shore Railway Company, 42; City Electric Street Railway Company, Mansfield, Ohio, 2; South Chicago City Railway Company, 26; Consolidated Street Railway Company, Grand Rapids, Michigan, 4; Toledo Consolidated Street Railway Company, 20; Hamilton (Ontario) Street Railway

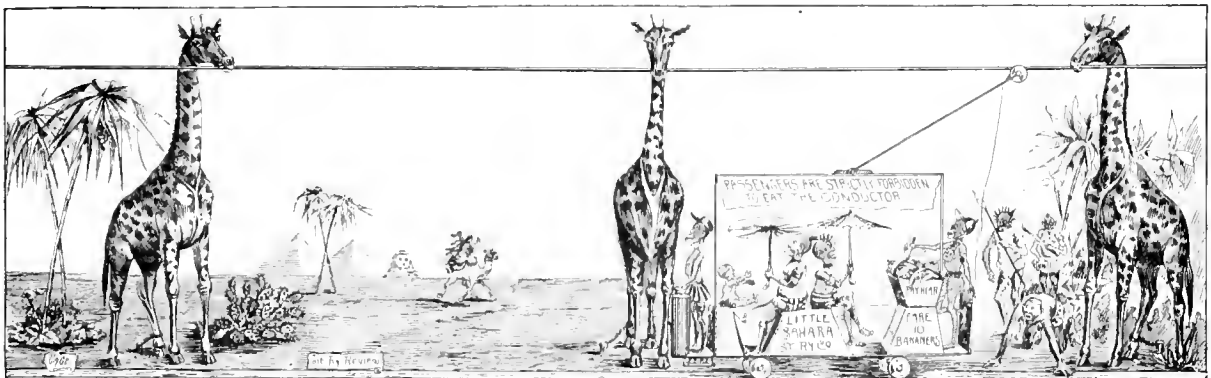

OUR PROPOSED ELECTRIC RAILWAY ACROSS THE SAHARA.

INSULLAC has met with such universal favor that electric railway plants find it a valuable adjunct to the repair shop. Its fame has spread abroad and the Massachusetts Chemical Company are in receipt of many orders from foreign countries. The company have four times increased their plant.

THE BALL ENGINE COMPANY, Erie, Pa., have made some unusually large shipments for this time of year, and report that they are crowded with orders. The following are some of their recent shipments: Calumet Street Railway Company, Chicago, Ill., four 300-horse-power Cross Compounds; Wheeling Street Railway Company, Wheeling, W. Va., three 250-horse-power Cross Compounds; Western Light & Power Company, Chicago, Ill., one 300-horse-power engine; Risdon Iron Works, San Francisco, Cal., three 150-horse-power Tandem Compounds; Hammond Electric Street Railway Company, Hammond, Ind., one 150-horse-power steam plant; Logansport Electric Light Company, Logansport, Ind., one 130-horse-power engine; besides many others too numerous to mention.

Company, 5; Austin (Texas) Rapid Transit Company, 2; Jamestown (New York) Street Railway Company, 4; La Crosse (Wisconsin) City Railway Company, 6; Sandusky, Milan & Huron Street Railway Company, 15; Twin City Railway Company, Webb City, Missouri, 4; Denver Tramway Company, 28.

THE ANSONIA ELECTRIC COMPANY (formerly the Electrical Supply Company) have contracted for the western selling agency of the Helios Arc Lamp. It is a focusing lamp, and is said to be the only arc lamp that has been constructed to successfully operate on an alternating circuit. It is the same lamp that was officially adopted by the German government, and although its introduction into this country dates back scarcely ninety days, its reception has been marked with evident approval, as over five thousand have already been sold. With the celebrated Stanley Transformers, and the Helios Arc Lamp, the Ansonia Electric Company certainly have a combination to win friends with every central station operating an alternating machine.

AMONG contracts secured recently from prominent companies are those placed by the Standard Railway Supply Company, of Chicago, for delivery during summer season of large quantities of Standard car stoves. These companies will put the stoves in their winter cars while they have ample time to do so, and without losing the use of a car, and when again required for winter service the cars will be ready at once with stoves. The Standard car stove is conceded by practical street railway men as one of the most desirable street car heaters made. The entire structure is arranged to be placed upon the seat, and requiring space otherwise occupied by one passenger.

THE Louisville, New Albany & Chicago has just added to its rolling stock two new sleeping and boudoir cars, costing nearly \$45,000 each. These cars are said to be the finest ever placed on any road in this country, and are specially designed for use during the World's Columbian Exposition. These cars are models of elegance and beauty, each compartment or boudoir being fitted with a complete toilet set, cleverly hidden from view when not in use. They are in daily service between Chicago and Cincinnati, and should be seen and used to be fully appreciated. All of the Monon's through day trains are made up of smoking cars, new coaches and parlor and dining cars.

THE numerous orders which the Ansonia Electric Company, formerly the Electrical Supply Company, are receiving for their heating and cooking apparatus, goes to show that these articles are being met with great favor by the Central Station as well as by the user. The articles can be operated both on 50 and 110 volts, and require scarcely any attention. The list comprises flat irons, goose irons, disc heaters, curling tong heaters; also broilers, tea pots, coffee pots, ovens and numerous other articles adapted for cooking purposes. It will pay street railway managers desirous of extending their business in the direction of rented power, to secure the publication in their home papers, of what the possibilities are in the line of electric heating.

THE INDIANA RUBBER AND INSULATED WIRE COMPANY announce the removal of their office from 242 Madison street, Chicago, to Marion, Indiana, from which point they will hereafter transact all business and receive all communications, and where, with telephonic communication with their factory in Jonesboro, a few miles distant, they will be better able to do justice to their rapidly increasing business. About a year ago this company opened its sales offices in Chicago for the introduction of its parantite insulations, then but comparatively unknown to the trade. Being the only manufacturers of rubber-covered wires west of the Allegheny Mountains, they found a convenient and ready market for their product, which is now sold extensively throughout all the middle and western states, and is in the hands of the best supply houses in all the large cities. The Electric Appliance Company, of Chicago, their general western agents, will continue to carry a large and complete stock of all sizes, as heretofore.

THE BALLAD OF THE CRINOLINE.



Great shades of Susan Anthony
And Bernhardt's form divine
How would they look if they were dressed
In hoops and crinoline!

'T will ruin the poor street car man,
Cold chills creep up his spine
At thoughts of increased rolling stock
"On acct' of crinoline."

Then double doors, too, must be made
To accommodate the spread
Of skirts, and the conductors
Will wish that they were dead.



Oh, sad this doleful prophesy
Of decreased dividend;
May some kind stroke of Providence
Their awful fate forefend

Come, brethern, let's bold counsel take,
Put up a bold, big sign:

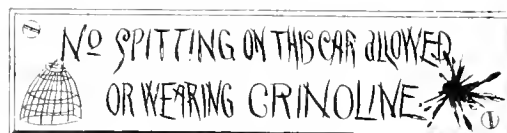

THE Gazette, of Terre Haute, waxeth sarcastic as follows: The Chicago, Grand City and Terre Haute Electric Railroad will connect at this place with a balloon line to the moon. It will cross the Wabash Ship canal, connecting the north pole and the equator, on a crank-lever bridge.

A PROFESSIONAL kicker is a character of London His name is the Rev. W. J. Johnson and he carries on a perpetual petty crusade against the tram omnibus and railway lines by showing contempt for all the rules and regulations of the various companies. The courts have not hitherto smiled on his efforts.

ST. PETER (on a summer vacation, but looking after business on the side)—See here! Why haven't you been up my way?

SURPRISED DENIZEN OF EARTH—Why, I'm not dead yet!

ST. PETER—You deceive yourself; you've been dead some time, and you are very much in the way here.

SURPRISED DENIZEN—I'll call in the neighbors to prove I'm alive and in business.

ST. PETER—That's too much trouble. Here's your local paper; show me your advertisement.

PERSONALS.

L. F. COOK, a rapid transit man of Tacoma, Wash., is in the city intending to stay through the World's Fair.

B. F. MEEK JR., formerly secretary of the Northwest General Electric, has been promoted to the vice presidency of the company.

DOX M. DICKINSON has been engaged as attorney for the Brooklyn Traction Company at a salary reported to be in the neighborhood of \$25,000 per annum.

W. E. HAYCOX, of the Fulton Foundry Company, made a welcome call at our office during a recent visit to Chicago. He is on a very successful trip as is usual with him.

J. T. VOSS, general manager of the Athens, Ga., Street Railway Company, is making many improvements in his system, bringing it to the front of southern street railway practice.

J. B. SMITH, special correspondent of the Boston Herald, accompanying the visit of the Rapid Transit Commission to Chicago, made a pleasant call on the REVIEW.

PRESIDENT BECKLEY, of the Rochester Street Railway Company, is receiving universal praise from press and public for the maintenance a superior of car service during the past severe winter.

GENERAL MANAGER RYDER, of the Bass Foundry & Machine Company, Indianapolis, favored our office with a call, and was accompanied by Harry M. Hayes, who will have charge of their exhibit at the Fair.

ALBION PEAVEY, late superintendent of the Sioux City Street Railway Company, has been presented with a gold watch by his former employes, as a token of their esteem. Mr. Peavey is at present on crutches, recovering from a broken leg.

THE death of Col. Wm. McCrory is announced at Mansfield, O. Col. McCrory was one of the best known citizens of Minneapolis, Minn., and built the old motor line there in 1879. He was 51 years of age and served through the war on General Sherman's staff.

S. M. CARPENTER, president of the Fulton Foundry Company, of Cleveland, O., one of the oldest street railway supply men in the country, is now convalescent from a severe illness. The REVIEW in common with his many other friends, is glad to hear of his improvement.

THOMAS BAKER, honorary representative of the Irish Railway Companies, Dublin, with his wife, has taken rooms at the Auditorium, and will remain until the end of the year. Mr. Baker will study American systems of street railway practice and make an extended report on his return.

A. J. BAIRD, formerly auditor of the Chattanooga Electric Railway Company and later of the San Antonio company, has severed his connection with the latter to accept the general superintendency of the Charleston, N. C., road and has removed to that city. Mr. Baird is a rising man and we watch his advancement with interest.

THE death of Geo. B. Prescott, Jr., occurred on February 12, 1893. He was well known as an electrical engineer and author, having been prominently connected at different times with the Weston laboratory, Newark, N. J., Electrical Accumulator Company and the Stanley laboratory at Pittsfield. He designed and operated the first electric car on the West End line of Boston.

CAPTAIN JOHN A. GRIER, whose familiar face has long been known in western electrical circles, has recently become associated with the Ansonia Electric Company, (formerly the Electrical Supply Company), and is at present at their factory in Philadelphia, where he is familiarizing himself with the details of the Helios Arc Lamp for alternating circuits, with a view of introducing it to the western trade.

NEW PUBLICATIONS.

THE wonderful fireproof qualities of "Salamander" wire, as shown by tests recently described in the REVIEW, has induced the makers, Washburn & Moen, to publish a pamphlet on insulated wire, giving the results of numerous tests on the "Salamander."

THE New England Magazine for March contains able articles on "Proportional Representation," by Stoughton Cooley; "The Massachusetts Prison System," by Rev. Samuel J. Barrows, and "The Importance of the Study of Local History," by Winfield S. Nevins.

THE CUTLER ELECTRICAL & MANUFACTURING COMPANY, of 27 South Eleventh street, Philadelphia, has just issued an attractive circular on its "C. S." specialties. These include a number of flush and lock wall switches that will be of value in electric car fitting.

THE AMERICAN FLORIST, of this city, recently gave an illustration of what enterprising trade journalism is like. A two days' convention was held in Pittsburgh, which did not close its sessions until one o'clock in the morning. In less than thirty-six hours our friends had their edition in the mails, containing a full report of eighteen pages with over thirty illustrations.

THE ELECTRICAL REVIEW recently celebrated its twelfth birthday, February 25th being the fateful day, it published a large edition of seventy pages, and among other good things it contained a very complete review of the progress in electricity for a year past. This enterprising journal has in the last year published much valuable matter in the line of electrical development.

JOHNSON'S ELECTRICAL AND STREET RAILWAY DIRECTORY for 1892 is the fourth one of the series published by the W. Johnson Company, Ltd., 41 Park Row, New York. The special features commending the present volume is its completeness, its legible typography and its complete indexes. The Street Railway Directory is only as complete as necessary in a work of this scope, but the telephone, electric light, mining, telegraph and trade lists leave little to be asked for. Price, \$5.00, of the publishers.

AN amusing instance of the intelligence of the average reporter comes from the LaCrosse, Wis., Press, which says that the street railway company has purchased "a battery, two generators and boilers from E. P. Allis, of Milwaukee."

THE TOLEDO TOWER WAGON.

THE tower wagon illustrated in our engravings is the design of L. H. Lincoln, the electrical engineer of the Toledo Consolidated Street Railway Company, and is the result of a long experience in practical work. It is intended both for use in the construction of lines and as a "wrecking" wagon. That it is well suited for the latter class of work is seen from the illustration showing the wagon with the tower closed. This tower is raised by a rope running over the end of the pole, at the base of which is a windlass. The rear ladder or support of the platform is free to swing, and at the different heights can be placed in the different positions shown—in the lowest position on the ground; in higher positions on different places on the wagon bottom. When necessary in heavy construction work stay rods are put on the ladders as shown. The wagons are made in two sizes—for one or two horses. The two-horse wagons have platforms 6 by 12 feet. Tool boxes are hung underneath and a gong under the footboard, making a very service-

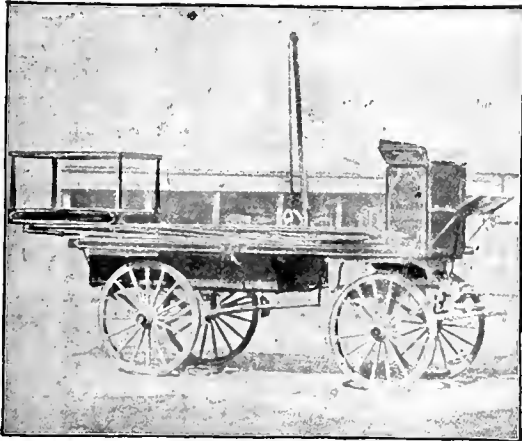

CLOSED—READY FOR A RUN.

able outfit both for emergencies and regular work. The old lumbering forms of tower wagon, with the tower built on the wagon without means for adjustment, are becoming obsolete and their places are being taken by something that is of more general use and quicker in operation. A tower wagon like that described affords a very simple solution of the question of quickly arriving at places of accident, and when there, being provided with apparatus for all classes of work likely to be required. Indeed, on electric roads it is as necessary to be prepared to make overhead repairs quickly as it is to be ready to clear obstructions on the track, while for regular construction work on the lines tower wagons are now among the indispensables. The Milburn Wagon Company, of Toledo, is engaged in their manufacture, and has received a large number of orders. Mr. Lincoln, the inventor, is acknowledged as one of the brightest young men in the electric railway service, as all who have ever met him will gladly testify, and his friends in the fraternity have a right to expect something extra good when it bears his name. The editor of this paper has

personally witnessed an exhibition run and platform mount, and the small space of time required never fails to excite surprise and admiration.

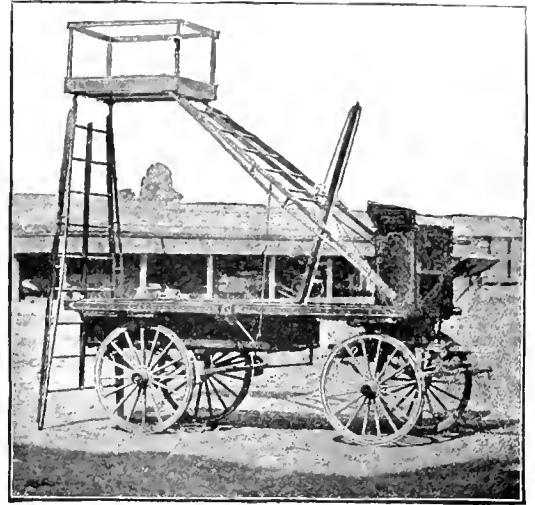

SET FOR LOW WORK.

CECIL SYDNEY SCUTTS, of England, is a recent writer on car heating and ventilation. Cecil says his treatise is the "Alexipharmic Treatment Required for Impure Atmos in Subterranean Railways"!

BERNARD M. SHANLEY, a Newark man of undoubted business capacity and energy, is reported to be chief of the executive committee of the New Jersey Traction Company.

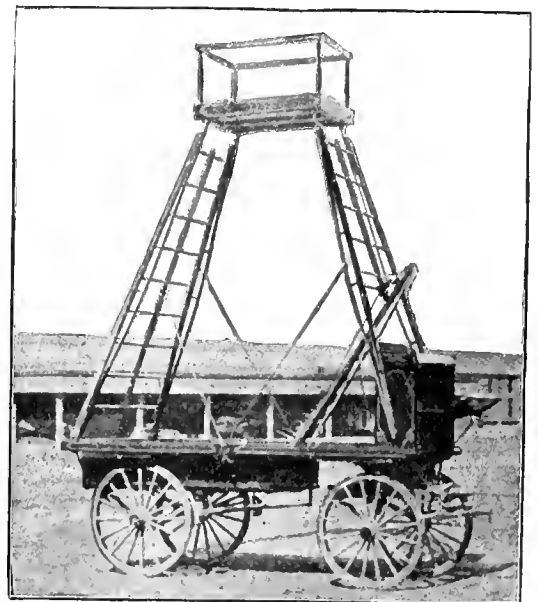

SET FOR HIGH WORK.

A PLAN is submitted by C. C. Cramp, of the Contract Construction Company, of London, to furnish the proposed Colombo, Ceylon, roads with the Mekarski compressed air system.

A NEW line has been opened by the West Chicago Company on Grand avenue.

ST. LOUIS BENEFIT ASSOCIATIONS.

THE Relief Association of the Citizens' Railway Company, of St. Louis, is one of the most flourishing in the country. The organization is commonly known as the Broadway Cable Relief Association, and it may be extended to all the employes of the McCulloch system. The society has paid out \$600 in sick benefits in the seven months of its existence. It has 200 members and pays \$10 a week to sick associates, and \$100 to his family in case of death. On March 10 the association presented a successful dramatic effort, "Three Glasses," at the club rooms over the Broadway cable power house. The affair was entirely in the hands of the men, who built the stage and set the scenery. The members worked hard to make a success of the play and it is needless to say, accomplished their end. The superiority of these associations lies in their peaceful existence and fulfillment of function.

CLEVELAND'S COMBINE.

IT is with no little interest that the street railway fraternity has watched the recent changes in the status of Cleveland, O., systems. The election of H. A. Everett to the presidency augured well for some bold strokes in policy and the explanation is read in the recent pooling of the interests of the East Cleveland and the Broadway Company.

The consolidation was brought about by President Henry A. Everett, Directors C. W. Wason, C. L. Pack, and M. A. Bradley of the East Cleveland, and President Horace Andrews of the Broadway Company. The wisecrackers are confident that the Woodland & West Side will soon enter, as J. H. Wade is a heavy holder of Woodland securities. From the fact that Tom L. Johnson is a holder of both stocks above mentioned it is thought that the Brooklyn lines will also enter the fold. These, however, are simply conjectures, but one thing is sure that Cleveland's systems are coming to an understanding with each other.

NEW JERSEY'S TROLLEY PROSPECTS.

IF the month of February, 1893, is famous for nothing else, the big traction deals consummated in its twenty-eight days ought to give it a place in history. The Metropolitan Traction Company, of New York, of which John D. Crimmins is the head, led off the procession by making what is said to be the biggest street railway transaction ever consummated. By the terms of this commercial treaty, 140 miles of New Jersey track went into the syndicate's hands, including the lines in Elizabeth and Newark. The scheme is now to unite Newark, Elizabeth, Bloomfield, Montclair and the Oranges with a system of electric roads, which will all run to one or more landings on the North River. The transfer of the lines of the Jersey City & Bergen railroad in Hudson county, which have been leased by the Pennsylvania railroad and the lines leased by the New Jersey Traction Company are

included in the deal. There were transferred in all 90 miles of horse railway, 35 miles of electric and 15 miles unoperated. All of this will now be operated as one system and the present animal power and unoperated lines changed to electric.

AS USUAL.

JUST because human nature is human nature, and the men who stand on the platforms differ in degree and not kind from the men who sit in the offices, labor organizations have no more uneventful lives than is accorded to other corporations. The dissolution of the Cleveland street railway employes' union, which died from apathy of its leaders, who would not serve their cause for glory and humanity alone, is a fine, large object lesson for similar organizations. Men are only men.

Just now a veritable hornet's nest is under the eaves of the Amalgamated Society of Street Railway Employes recently formed at Indianapolis and having its chief office in Detroit. Two factions have appeared already, and the supporters of the rival heads of the association are ready to morally knife each other whenever occasion permits.

The quarrel is the result of internal dissensions and jealousies on the part of the men who are supposed to conserve the peace of the concern. Taking the motto that "all is fair in war" the recalcitrant, and, it is needless to say, unpopular party to the trouble, is using any and all means to break up the organization. Recriminations, threats and bad language are the principal weapons so far used, but if the thing continues the courts may take a hand. Money supposed to have been misappropriated has added to the flames.

At the same time with this war of words and ink a most disgraceful strike has been in progress at Wheeling, West Virginia, where the entire city has been left at times at the mercy of a few hundred angry and unreasonable men. Not content with withdrawing from service, the employes have vigorously and forcibly resisted the attempts made by other workmen to gain a livelihood on the Wheeling Consolidated. The most dastardly and cowardly deeds of violence have here been enacted. The strikers took one non-union man and literally wrapped him to a pole with wire. Greased tracks and tight wires strung across the track chin-high are other methods used to *persuade* the company to make terms with them. A number of non-union men were coerced into the union and compelled to take enforced idleness with the rest. To add to the general anarchy, the city and county authorities have not done their duty, and assumed the usual role of the "powerless."

The company which spent a good million of dollars in Wheeling's transportation deserves better treatment than that accorded, and if shame cannot make them cognizant of their duty other means of protection should be taken.

"I'd like a pass on your father's road," said Mr. Slim-purse to Miss Coupons. "Well," replied Miss Coupons, "I don't believe you'll get it. I heard papa say they didn't pass anything but dividends."

RICHMOND & MANCHESTER CONSOLIDATIONS.

THE union that is strength has been consummated by the Richmond & Manchester and the Richmond Railway & Electric Company, by the purchase of the former by the latter named road. This deal gives the entire control of transportation in the two cities and suburbs to the buying company, including the two lines to the popular resort, Forest-Hill park.

Under the terms of the deal \$400,000 of 40-year five per cent gold bonds are to be issued in lieu of the \$500,000 in 6 per cents now in existence. Of this sum, \$250,000 is to be put into betterments immediately.

The new officers have been elected as follows: Geo. E. Fisher, president; vice, John S. Williams; directors, Geo. E. Fisher, B. H. Nash, F. J. Craigie, Dr. J. P. Munn, J. S. Williams, S. W. Middendorf and W. C. Seddon.

The changes give possession of 60 miles of track to one company, with all its attendant advantages of transfer and centralization of expenses.

SOME NEW DEVICES.

A TROLLEY switch, designed by G. W. Merkins, of Denver, Colorado, known as the "M and D," has been used on the Tramway Company's lines at Denver and on the West End road at Boston for about a year. The movable part of this switch consists of the end of the wire with flanges on each side. The trolley wheel in approaching presses the flange, turning the switch "in the way it should go." This device is non-sparking and gives a continuous contact. The Dimon & Adams Manufacturing Company, of Denver, are making it.

THE Excelsior Track Switch, made by the Fitch Excelsior Switch Company, of 45 Broadway, New York, can be operated by the motor or gripman on the moving car, thereby saving valuable time. A switch rod on the car is let down by the motorman from the car platform into a slot or channel. Into this channel the spokes of the switch operating wheel project and are caught and turned as the wheel passes through, thereby throwing the switch. The size of the switch box is only 22x18x18. It has been in operation at Steinway, N. Y., with good results.

A SASH supporter, made by W. Haskell King & Company, of New Haven, Connecticut, is a step in the direction of anti-rattle that is much needed on some cars. It acts simply as a wedge, normally held in place by springs, but when it is desired to raise or lower, the thumb lever, which is similar to that commonly seen on car windows, makes the springs of no avail. When the lever is again released the springs press the wedge or catch back into place, fastening the sash at any position desired.

A VALUABLE idea and a valuable patent to fit it is the property of B. J. Parsons, of Omaha, Nebraska, assignor to F. W. Fitch of that place. It is called a trolley catcher, the idea being to catch the pole when the trolley runs off,

so to keep it from striking the span and guard wires. The catcher is located in a box on the car roof. The rope from the pole is wound around a drum in the catcher. This drum has a spiral spring inside, with a ratchet and two pawls. When the trolley jumps and the pole flies up it gives the rope a jerk that causes it to release the spring and pull the pole down near the roof.

THE Chicago agents for the Heine Safety Boiler Company report the following sales of Heine boilers for the month: N. K. Fairbanks, Chicago, 1,000 horse-power; Chicago & North Shore Railway, 750 horse-power; South Side Rapid Transit Company, Chicago, 300 horse-power; H. D. Campbell & Sons, Traverse City, Michigan, 150 horse-power.

A WELL dressed young female with all the outward appearance of a lady recently slapped a conductor in the face because he did not stop the car at a crossing which was impossible under the circumstances. The conductor attempted an apology with the above result, when the woman sprang from the car and took a tumble into the mud. The crowd in the car were greatly incensed at her treatment of the conductor. And yet ———!

J. A. ROEBLING'S SONS report a crowded order book for all types of their wire.

Abraham Lincoln

When leaving his home at Springfield, Ill., to be inaugurated President of the United States, made a farewell address to his old friends and neighbors, in which he said, "NEIGHBORS GIVE YOUR BOYS A CHANCE."

These words come with as much force to day as they did thirty years ago.

How give them this chance?

Up in the Northwest is a great empire waiting for young, and sturdy fellows to come and develop it and "grow up with the country." All over this land are the young fellows, the boys that Lincoln referred to seeking to better their condition and get on in life.

Here is their chance!

The country referred to lies along the Northern Pacific R. R. Here you can find almost anything you want. In Minnesota and in the Red River Valley of North Dakota, the finest of prairie lands fitted for wheat and grain, or as well as for diversified farming. In Western North Dakota, and Montana, are stock ranges limitless in extent, clothed with the most nutritious of grasses.

If a fruit farming region is wanted there is the whole State of Washington to select from.

As for scenic delights the Northern Pacific Railroad passes through a country unparalleled. In crossing the Rocky, Bitter Root, and Cascade Mountains, the greatest mountain scenery to be seen in the United States from car windows is to be found. The wonderful bad lands, wonderful in graceful form and glowing color, are a poem. Lakes Pend d'Oreille and Coeur d'Alene, are alone worth a trans-continental trip, while they are the fisherman's Ultima Thule. The ride along Clark's Fork of the Columbia River is a daylight dream. To cap the climax this is the only way to reach the far-famed Yellowstone Park.

To reach and see all this the Northern Pacific Railroad furnish trains and service of unsurpassed excellence. The most approved and comfortable Palace Sleeping cars; the best Dining cars that can be made; Pullman Tourist cars good for both first and second class passengers; easy riding Day Coaches, with Baggage, Express, and Postal cars, all drawn by powerful Baldwin locomotives, make a train fit for royalty itself.

Those seeking for new homes should take this train and go and spy out the land. To be prepared, write to

CHAS. S. FEE,
G. P. & T. A.
St. Paul, Minn.

THE NATIONAL ELECTRIC LIGHT CONVENTION.

THE recent meeting of the National Electric Light Association was one of unusual interest to street railway men. The papers read were, with the exception of one or two, equally applicable to electric light and railway work. One noticeable feature of this event was the large amount of attention given to the question of the transmission of power to a distance. A year ago there was one paper on the subject and the matter was discussed in rather a general manner. This year, however, there were three papers on the subject, and the question was taken up in a way to lead an observer to think that the day of great power transmissions is not far away. One of the most practical of the papers was that of Dr. Louis Bell. He took up the question of supplying our present stations with power from a distance, and so doing away with the steam engines as now used. He suggested two plans especially suitable for electric railway stations as they are at present. One was to employ three phase motors to drive the regular 500-volt railway generators—these motors, of course, to be supplied with current from the distant source through the medium of transformers. The other plan was to use three phase currents and transform them directly into continuous currents by means of a transformer designed by C. S. Bradley. Dr. Bell had tried some of these transformers personally, and found them admirable. They were but a little more complicated than the 500-volt generator, and had a very high efficiency. He favored three phase machines in the first case because they would not be pulled out of synchronism with sudden changes of load, and so stopped. In regard to three phase motors, they were about as near indestructible as any machines in existence, the armatures being a mass of metal with no outside electrical connections. He had seen them subjected to terrible overload without a sign of burning out.

C. S. Bradley said in his paper that a plant to transmit 500-horse-power from the coal fields to a city would cost \$300,000. He thought that by the generation of the power in large quantities at the mines it could be obtained most cheaply by converting the coal into gas to run gas engines. In this way we could get more energy from a pound of coal, besides selling the valuable by-products of gas manufacture.

H. C. Myers read a paper on the "Vulcanizing Process for Preserving Ties, Cross Arms, Etc." This new process consists in heating wood under great pressure, thereby changing the natural saps and oils in the wood into a preservative compound acting as an antiseptic to prevent decay. This was claimed to be the best process for preserving wood known.

William H. Brown gave an historical sketch of the New York subways, and the results that were being obtained from them. There occurred, during 1892, 49 faults on 750 miles of underground cable operated.

Prof. Geo. Forbes was present and treated the subject of thermal storage for central stations, which has

attracted so much attention abroad lately. This idea is to put in boilers of average capacity and put in hot water tanks for the storing of surplus energy during light loads. In the discussion which followed the question of storing water power during the entire day to do service for a few hours only, was brought up. The advantage of this plan would be that a small motive power could store up energy enough in this way to do a large amount of work for a short period.

The officers of the association for next year are: President, E. A. Armstrong, Camden, N. J.; first vice-president, M. J. Francisco, Rutland, Vt.; second vice-president, C. H. Wilmerding, Chicago, Ill.; secretary, George F. Porter, New York. The place of meeting was referred to the executive committee.

SEARCHING FOR A SOLUTION.

THIRTY members of the Massachusetts senate and house of representatives arrived in Chicago February 25, to investigate rapid transit in Chicago, for the benefit of the assembled solons of the Bay state, and the edification of Boston in particular. The delegation found the straight parallel streets of the World's Fair city very confusing and could with difficulty be kept from going down every alley they could find. After getting acclimated and overcoming the idea of crooked ways, the party visited the World's Fair grounds and saw Libby Prison and War Museum in the afternoon Monday. The Chicago Fire Cyclorama entertained them in the evening. Tuesday was spent in hard work. The city's system of cable roads was thoroughly and admiringly investigated and the South Side L came in for its fair share of praise. The tunnels of the West and the North Chicago roads were studied and the mayor and other city officers catechised on probabilities, possibilities and plans. One amusing feature of the trip was the fact that the gentlemen were surprised to find that a journey to Chicago was necessary to find the original deed for Boston Common, over the preservation of which eye sore, so much good breath and valuable petition has been wasted. The document now adorns the gallery of C. F. Gunther, the candy man and curio collector.

Rapid Transit Committee was composed of: Senators Kittridge, Baker, Leary and Horton; Representatives Bliss, Charles, Nutting, Graham, Garfield, Dodge, Barnum, McCarthy, Newhall and Quinn.

Committee on Merchantile Affairs: Senators Ratskesky, Carter and Merrill; Representatives Brewer, Moriarty, Coakley, Richardson, Bryant and Darling.

Capt. J. G. B. Adams, Sergeant-at-Arms, and J. B. Smith, of the Boston Herald, accompanied the committee.

THE "Paterson Call" abuses our good friend Lawless as follows: "The success and popularity of the electric car service is very largely due to the wisdom, experience and skill of the genial and popular Manager Lawless. He is the right man in the right place."

STREET RAILWAY LAW.

EDITED BY MR. FRANK HUMBOLDT CLARK, ATTORNEY AT LAW, CHICAGO.

Street Railway Company Using Bridge Belonging to State.

A street railroad which lays its track across a bridge constructed and maintained by the state, and constituting a part of the highway on which the railroad line runs, does not adopt the bridge as one of its appliances so as to become liable for an injury to a passenger, caused by defects therein, to the same extent as if the bridge had been built by the Company.

Peckham, J.:—The defendant owns and operates a street railroad in the city of Rochester. The Erie canal intersects Main street in that city, and at the intersection the canal is crossed by a bridge built, owned and maintained by the state, and in effect the bridge forms a continuation of the highway of West Main street. The bridge was so constructed as to lift vertically by hydraulic power, when boats were to pass. In order to act as a counterbalance and thus to reduce the amount of power necessary to lift the bridge, heavy weights made of iron troughs filled with pig iron were suspended in the upper part of the framework of the bridge. They were suspended by cables fastened to the floor of the bridge, and passing through pulleys in the upper framework. The troughs were fastened by means of stirrups which were made of iron. The plaintiff was a passenger on one of defendant's cars, and while the car was slowly crossing the bridge in question, one of the stirrups gave way and let one of the troughs drop, so that the pieces of pig iron slid out, and some of them fell upon the car beneath and broke through, and one of them struck and severely injured the plaintiff.

The evidence as to the defect in the welding of the stirrup and how it was discoverable, and the plan and method of the construction of the bridge, was uncontradicted. Upon such evidence the trial judge refused to submit the question of defendant's negligence to the jury, and held that the defendant was liable, and only the question of damages was left to the jury. The court charged the jury that the defendant was bound to precisely the same liability with regard to any defects in the bridge as though it had built the bridge originally to serve as part of its railroad, and it was bound by the same rules which the law applies to every other carrier of passengers with reference to the means it adopts as part of its roadway and part of the appliances which it may have occasion to use in the transaction of its business as a common carrier.

We do not think the defendant rested under such extreme liability. It may be assumed that the defendant is a corporation organized under the general railroad act for the purpose of building a street railroad through certain streets in the City of Rochester. Under that Act it acquired no right to cross the canal on any bridge it might build; it acquired no right to build any bridge; and although it may possibly have the power of eminent domain to acquire land for some purposes, it could

acquire none to build a bridge over the canal. And its organization under the general Railroad Act for the purposes of a street railroad required it to keep to the public streets or highways, and gave it no right to lay its tracks elsewhere. The bridge mentioned was nothing more than the continuation of the city street which it connected; and although it might have been necessary for the defendant to have obtained permission of the state authorities before laying its rails and running its cars over the bridge, yet we are of the opinion that in crossing such bridge it did not thereby make it an appliance of its own to the extent stated in the charge of the court below.

We do not criticise the rule, or assume here to question it, as to the extent of liability ordinarily attaching to a carrier of passengers, including perfect roadbed and all proper appliances. We simply say that this case is not one in which to make the application of such extreme liability. We say the bridge is not such an appliance as is contemplated by the rule alluded to, and that the liability of the defendant was no greater than while pursuing its route along the public street.

(N. Y. Ct. of Appeals. Birmingham vs. Rochester City & B. R. Co. 32 N. E. Rep. 995.)

Person Driving Team in Track—Attempting to Turn Out—Injury by being struck by Car.

In an action for damages against defendant street railway company, plaintiff's evidence showed that while driving a team with a heavily loaded wagon on defendant's track, he saw one of its electric cars approaching two or three blocks away, and at once turned the team off the track and tried to have them pull the wagon off also, but owing to the snow the rail was slippery and the team was unable to draw the wagon from the track. The conductor of the approaching car made no effort to lessen its speed, and it collided with a corner of the loaded wagon, and plaintiff was injured. *Held*, That the evidence made a good prima facie case for plaintiff, and it was error for the court to direct a verdict for defendant.

(Sup. Ct. Wis. Will vs. West Side R. Co. 54 N. W. Rep. 30.)

Failure to keep Track in Repair—Upturned Rail—Personal Injury.

In an action against a street railway company for personal injuries caused by an upturned rail, to a person driving on the street, an instruction that it was the duty of the defendant to keep its track in proper repair, that this is a condition attendant on the grant of the franchise, and if defendant neglected to do so, by reason whereof the plaintiff sustained injuries, it was negligent and is liable to plaintiff therefor if he did not in any way contribute by his own negligence to the injuries sustained, is not erroneous.

Where the court instructs the jury that even if plaintiff did not see the obstruction, if it was plain to be seen, and was such an object as should have been observed by him had he exercised ordinary care and watchfulness, he was guilty of contributory negligence and can not recover "if he failed to exercise ordinary care and watchfulness," defendant has no ground of complaint.

Where it also appears that the upturned rail was loose the night before and was nailed down again, and that defendant's trackman passed over the line twice on the day of and before the accident, an instruction to return a verdict for defendant is properly refused.

(Sun. Ct. Pa. *Bradwell vs. Pittsburgh & W. E. Pass. Ry. Co.* 25 Atl. Rep. 623.)

Care Required as to Infirm Passenger—Time to Reach Seat—Negligence.

In an action against a street railway company for injury to a passenger, the evidence showed that plaintiff, an elderly lady, entered the car by the front platform, and that, before she reached her seat, the car started and she fell down. *Held*, That whether plaintiff's conduct in entering the car from the front platform and going towards a seat with her back to the horses without assisting herself by the use of the straps placed in the car for that purpose, constituted contributory negligence, was for the jury.

The driver of a street car is bound to take more care of an old person than of one in full vigor, and whether starting a car in the usual and ordinary manner after an elderly lady has entered it, is negligence, is a question for the jury.

(Sup. Ct. Pa. *Holmes vs. Allegheny Traction Co.* 25 Atl. Rep. 640.)

Master and Servant—Injury to Car-Driver—Vicious Horse.

It is the duty of the master to furnish his servant with such appliances for his work as are suitable and may be used with safety; and if a servant is injured by reason of defective appliances furnished by his master, the latter will be liable for damages unless he can show that he has used due care in the selection of the same.

The driver of a street car was given a span of horses to propel the car, one of which was a broncho that would kick when struck—which fact was known to the master, and of which the driver was not aware and was not informed by the master. The car was under the care of a conductor, who permitted the same to be overcrowded, every available foot of space both in the car and on the platform being filled. On attempting to start the car the broncho refused to pull, whereupon the driver slapped it with the lines, when it kicked him, causing death in a few hours. *Held*, That there was sufficient testimony to submit the questions of fact to the jury.

(Sup. Ct. Neb. *Leigh vs. Omaha St. Ry. Co.* 54 N. W. Rep. 54.)

Electric Railways—Negligence in Running Cars Rapidly at Night—Contributory Negligence in Leaving Wagon on Track.

It is negligence in an electric street car company to run a car in a narrow and unlighted alley, on a dark night, so fast that it cannot be stopped within the distance covered by its own headlight.

But the plaintiff's driver, by his own testimony, was equally negligent. He left his horse and wagon standing unguarded upon the track, and went into a stable near by. It was his duty to exercise the same watchful care when upon the track that the law exacts of the railway company in running its cars. The judgment for the plaintiff is reversed.

(Sup. Ct. Pa. *Gilmore vs. Federal St. & P. V. Pass R. Co.* 25 Atl. Rep. 650.)

Passenger Riding on Car Platform—Insufficiency of Railing—Question for Jury.

Standing on the rear platform of a moving street car even when there is room inside, is not, under ordinary circumstance, negligence *per se*, at least in the absence of any prescribed rule of the carrier forbidding it.

It is quite clear that the question of defendant's negligence was one for the jury. Permitting and inviting, as it did, passengers to ride on the platform, it was its duty to use all reasonable precautions to insure their safety. Under the circumstances disclosed by the evidence, it was to be anticipated that passengers might, by reason of the jolting or rocking of the car or of some other cause, lose their balance, especially when the platform was crowded: and it was a fair question for the jury to say whether in the exercise of that high degree of care required of carriers of passengers, the defendant ought not to have guarded the platform with rails or gates of sufficient height to have prevented just such accidents as occurred in this instance. The evidence as to decedent's contributory negligence was also a question for the jury. Neither the standing on the platform, nor the failure to take hold of the rail amounted to negligence *per se*; nor did the two facts combined constitute such negligence.

Whether, under ordinary circumstances, the dash and gate were of a safe and proper height for the protection of passengers, was not a subject for expert testimony, but was a question for the jury to pass upon.

(Sup. Ct. Minn. *Matz vs. St. Paul City Ry. Co.* 8 N. Y. L. Jour. 1100.)

One-Horse Cars for Sale.

We have for sale fifty-one (51) one-horse cars in good order and condition. These cars were built by Stephenson & Jones well-known manufacturers.

They are 10 feet long and seat 12 passengers. Each car is provided with a fare box.

These cars can be seen at the Company's barn, corner Florida Avenue and Eleventh Street, Northwest Washington D. C.

Price, \$100.00

CAPITOL NORTH O ST. & SO. WASHINGTON RY CO.



WINDSOR & KENFIELD,

PUBLISHERS AND PROPRIETORS,

269 DEARBORN ST., - - - CHICAGO.

Published on the 15th of each month.

SUBSCRIPTION, - - - TWO DOLLARS.

FOREIGN SUBSCRIPTION, - - - 20 SHILLINGS.

Address all Communications and Remittances to THE STREET RAILWAY REVIEW
269 Dearborn Street, Chicago.

H. H. WINDSOR,
Editor.

F. S. KENFIELD,
Business Manager.

CORRESPONDENCE.

We cordially invite correspondence on all subjects of interest to those engaged in any branch of Street Railway work, and will gratefully appreciate any marked copies of papers or news items our street railway friends may send us, pertaining either to companies or officers. Address?

THE STREET RAILWAY REVIEW,
269 Dearborn Street, Chicago.

Entered at the Post Office at Chicago as Second Class Matter.

This paper member Chicago Publishers' Association.

VOL. 3. APRIL 15, 1893. NO. 4

IN New York State the courts have ruled that the false punching of transfer checks, and subsequent turning in of the same as cash fares, constitutes the crime of forgery, and a Buffalo conductor has recently been sentenced to a term in jail for doing so.

THE Supreme Court of Louisiana has ruled that power given by a city charter to authorize the use of its streets for horse or steam railroads, before electricity came into use as a motive power, authorizes the city to grant franchises to operate cars by the trolley system.

THE United States Circuit Court in the District of Columbia decides that it is unreasonable for a city to construct sewers in that part of a street occupied by a street railway under a prior ordinance if the construction causes a suspension of the car service, or inflicts other damage to the company, provided the sewers could be laid in another part of the street.

AN important transfer ticket decision is cited in our Law Reports this month, wherein the Michigan court rules that a passenger who neglects to secure the proper transfer ticket is not entitled to transportation except upon payment of an additional fare. Conductors are not bound to accept passenger's statement that he paid on first car and is therefore entitled to a ride on the transfer car.

COMPANIES whose ordinances include a contract with the city to keep in repair that portion of the street occupied by its tracks, should look well to their repair. Recent court decisions are that it is not negligence per se for an able-bodied person to alight from a slowly moving car; but the company is liable for damage if a passenger alighting under such circumstances is injured by reason of holes in the track.

WILL there be hotel accommodations for all who visit the World's Fair City? Yes, in abundance. The hotels which will be opened for guests May 1 will accommodate nearly 150,000 people, and others nearly completed, and which will open May 15 will increase this number to nearly 200,000. In addition are the thousands of residences which will entertain relatives and friends, and thousands more which will have part or whole of their homes to spare during a good portion of the season. There will be a big crowd, but it is coming to a city accustomed to doing things in a big way.

THE car fender is a subject which may well enlist the consideration of the thoughtful manager. In several cities already, council committees have been appointed to investigate the matter with a view to the passage of municipal regulations requiring some such protection. For mechanically operated cars the fender is almost indispensable and companies will further their own interests by looking after the fender business before they are forced to do so on terms which may not be specially favorably. As a matter of economy in self-protection alone the fender would seem to admit of little argument in most cities and towns.

THAT over-much legislated city, Washington, again confronts the problem of street railway motive power. The governing forces have issued the edict that on the first day of August the overhead trolley must bite the dust. As the operation of storage battery cars has at last been abandoned on the Eckington & Soldiers' Home lines, after a most persevering and desperate effort to operate them for less than the earnings of the road, a relapse seems probable to the good old horse cars, so dear to the old school aristocrat of the Capital City. This will leave the cable as the only surviving mechanical power there, unless the various underground electric systems develop a much greater success than has been thus far shown. It is strange that the overhead system now operating in five hundred of our cities, from ocean to ocean, including every large metropolis in the nation, should develop such dangerous and unsightly proclivities as the Senate and other committees would have us believe exist in Washington. We would not entertain even the idea that promoters of underground electric which are struggling to enlist capital in their little Washington lines, could have lent any influence in the accomplishment of this discrimination; but there are people who will think so, nevertheless.

OUTSIDERS are still asking about the transportation facilities between the different districts of Chicago and the Exposition grounds. In answer we are glad to be able to say that the transportation facilities both in quantity, quality and speed will be unequalled by any great gathering in the world's history. The combined systems will transport 100,000 persons each way each hour, and on certain lines the trip from the business center of the city to the Exposition gates, eight miles, will be made in fifteen minutes. As fully described elsewhere the terminal facilities are the most perfect ever worked out by railroad and railway men.

WE cannot refrain from again calling attention to the broad and inviting field, ready and waiting, in the sale of electric power for operating machinery requiring few horse power. The statement in this issue of two well known managers are at once interesting and convincing. At Sioux City it has been found profitable to run an extra feed wire exclusively for this work. At Omaha power is furnished for a great variety of purposes from the running of fans to printing presses. As President Peavey tersely says: "The matter of stationary power is certainly one of great importance to any railway company, and a source of considerable revenue, and it is surprising to me that more companies do not give attention to this important feature."

WE illustrate, this month, an entirely new system for high speed electric elevated railway. Its simplicity is as surprising as are its practical, effective results, as demonstrated on a line 800 feet long. Indeed, there seems no reason why a speed of from 100 to 200 miles an hour should not be easily maintained. For elevated service in cities it offers particular attractions. The structure is very light, but very strong; the cars likewise; and neither obstruct light or air, and the entire operation of the road is secured by a combination of appliances already in daily use, and the utility of which there can be no question. We believe the high speed passenger service of the future will lie in a suspended car, the body of which shall be light and narrow, and offering little atmospheric resistance. Also in shorter trains, but operating at frequent intervals. We believe Mr. Cook has successfully worked out all of these requirements.

AS a sequel to the long drawn and disgraceful strike on the Wheeling, W. Va., road, the verdict of the jury before which several of the strikers were tried, affords opportunity for congratulation. The criminal acts of the leaders were established beyond any question, and already four of them have been found guilty. Indictments have been returned against fifteen others and by the time they are tried and sentenced, the strike business as conducted on the Wheeling principle will prove that it is indeed "a big wheel that never turns around." Railway managers in dealing with the troubles fomented by professional agitators should exercise the greatest caution to deal fairly and justly, and when the first overtact against

the company is made, lose no time in instituting legal proceedings, and not only institute such proceedings but follow the arrest with prosecution. It requires backbone to do this sort of thing but the lesson taught will be apt to be a lasting one. The Wheeling people deserve credit for standing firm in their demand for the enforcement of the law.

A STRIKE was indulged in by the, until that time, employes of the Carrollton line in New Orleans. It was founded on the most ridiculous claims, and as far as the company was concerned, lasted about three hours. For most of the strikers it will probably last several years. One of the surprising features of the case, not only to the ex-employes but to the company as well, was the astonishing revelation that it was not only possible, but practical, to operate electric cars, and at fairly high speed, with a crew of green men, who until that moment, had not only never been in street railway work an hour in all their lives, but who until that time, knew absolutely nothing of the modus operandi of operating an electric car. At 2:30, Friday afternoon, the first car was abandoned, and two hours later the entire service of forty-three cars had been deserted. Next morning, Saturday, fifteen cars were run out with new drivers, and increased to twenty-seven by afternoon. Sunday the entire equipment of fifty cars were in service. Another quite as surprising fact is that not a motor was burned out, and the few trifling accidents, such as broken headlights, etc., amounted to but little more than one hundred dollars.

STEAM roads find it necessary to make a distinctive department of its motive power, presided over by a man who makes a constant study of how power may be produced at the lowest possible cost, and who maintains a close surveillance on all the motor machinery. Already many electric roads are finding it advisable to enlarge their operating department by the appointment of an experienced man as superintendent of motive power. Even now too many railways are run without that detailed knowledge of cost. In a general way the manager knows the lump amount each month that represents the cost of fuel, water, power house help and repairs and inspection of motors and machinery, but when it comes to an intelligent idea of the many branches of this expense he is at sea. On a small road it is conceded the superintendent can keep a personal watch and carry in his head what would be impossible on a larger line. But on any road however small the saving to be effected by knowing the division of expenses for comparison with previous months will prove of great value. Many a road can increase its dividends without increasing its earnings one dollar, simply by a more intelligent knowledge of expenses.

BEFORE another issue of the REVIEW the opening ceremonies inaugurating the World's Columbian Exposition will have passed into history. It is human nature to anticipate so much of a widely-heralded attrac-

tion that the realization of actual inspection is apt to fall far short of the ideal and result in more or less of disappointment. But in the present instance no such regret will be expressed, for the simple reason that it does not lie within the power of writer and artist to convey anything like an adequate conception of the beauty, extent and grandeur of the World's Fair. From its inception the work has been prosecuted with that tremendous energy which has built up a city of a million-and-a-half in half a century, and whose citizens from the multi-millionaire down to the day laborer have gladly contributed according to their means and expended fifteen millions of money in providing an aggregation whose equal the sun has never shone upon before. It is but truth, and in no measure exceeding the bounds of modesty to say that what Chicago has done in this great enterprise would not, and, indeed, could not have been accomplished by any other city on the continent; nor by any city on the globe within the same time. While priding itself on all the city has done in providing a suitable home for the exhibits, Chicago fully recognizes that she is but working out the will of the whole great country in which all true Americans take as strong personal interest in the success of the enterprise. It is enough to say the Fair will be a credit to our country. But the feast is almost ready, when all car taste for themselves.

WE learn with surprise that in a good sized town in Ohio the patrons of the theater there were obliged to walk home after one of the performances because the entertainment chanced to run ten minutes past 11 o'clock, the time when the last car was scheduled to leave. There may have been some excuse somewhere, but it certainly could not be accepted as a good one, and it will be hard to offer any explanation why the patrons of the road who used the cars in going were not accommodated for the return trip to their homes. The manager may be able even to show that in this special case the available traffic would not pay the running expenses of that one trip. But in our judgment this is no argument at all. The hour was not unreasonably late, and certainly theater riding will never be encouraged and built up if people are assured they will have to walk home, or if they are not assured that they will not be compelled to walk. On a well managed road the superintendent keeps informed of the special gatherings and meetings, and not only ascertains the time when they will separate, but details some one to see that, if possible, sufficient number of cars are in waiting to provide for the business when the regular service would be inadequate. The enterprising superintendent will go further and secure an announcement to the audience that he will have ample supply of cars. This, of course, as stated, where the usual service at that hour of the night is not sufficient. This makes extra work for the superintendent, but it also makes good friends of the patrons of the road, and will inevitably result in increasing travel to a point, where if not profitable at first, soon will become so. There are many roads paralleled today which might have continued in the

enjoyment of their original exclusive business had not some moss-back stockholder or director sat down on the efforts of his more far sighted manager. We do not believe in running an owl car for one passenger, but that is a very different matter from the topic under consideration.

DURING a recent trip through the Gulf States, we were greatly impressed with the field for light electric traction in the sugar plantations. The cane ripens late in the fall, and is cut in November, December and January. At present this cane is in most cases hauled in wagons to the crushers, which during the season are kept running both day and night—the latter by the aid of electric light. The soil, which is favorable to the raising of cane, is at all times, and especially during the season named, particularly favorable to raising Cain with the wagons loaded with the saccharine stalks. From three to five pair of mules or oxen find it a slow and toilsome process to haul the broad-tired wagons through the moist, yielding soil. The more the road is used the worse it becomes, and the lighter becomes the load which can be hauled and longer the time required in transit. Indeed, so serious is this problem, one of the oldest planters in the South, a gentleman who has upward of 2,000 acres in all, informed us that there was no profit in raising sugar where the cane had to be hauled to exceed one and a half miles. As one solution of the trouble, some planters are installing smaller crushing mills, at convenient distances scattered over their fields, and thus reducing the haul. The juice, however, is pumped through a pipe line from these crushers to the main plant, where it is boiled or converted into sugar or molasses. While the pipe line promises relief in some respects, it is less desirable on many accounts than to have the entire process of manufacture conducted at one central point. While the crushers are expensive, the cost of the sugar houses with their machinery runs from \$30,000 to \$300,000, hence the explanation why they cannot be multiplied and scattered. We believe the large planters will find their solution of the question in the introduction of light railways, narrow gauge, on which small cars can be drawn by electric motors by the trolley system. As there are practically no grades and a high speed is not desired, the motors need not be of heavy construction. An abundance of tie material is always at hand in the neighboring swamps, where it can be cut from cypress, pine or white oak. Tracks can be built in sections the length of rails, with rails spiked to longitudinal stringers, and these in turn resting on the cross ties, so that the tracks could be quickly taken up, transported, and again relaid in another section of the plantation as occasion required. As labor is cheap this would not incur much expense of either money or time. For a ground return rails could be cross bonded to a short galvanized iron pipe driven into the moist earth, or bonded to a return wire. As the track would be single, and probably not more than two loaded trains moving at one time, the return current offers no serious problem. In short, the entire construction and

equipment would involve comparatively small outlay. The power would be generated at the mill, where already an electrician is required to operate the lighting plant. Indeed, both railway and lights could be supplied from the same generator. In short, the plan seems at once to offer radical relief for a most pressing evil, and a magnificent field for the constructing engineer. The REVIEW confidently looks forward to the near future, when all the cane of the large plantations will be transported in this way, and again when manufactured and in barrels and hogsheads delivered by the same method to railroad and docks where distance will permit.

A SOLUTION OF THE BROOKLYN BRIDGE PROBLEM.

SOME changes will certainly become absolutely necessary in the near future in the matter of transportation across the Brooklyn bridge. The several ferries are doing as large a business as ever, and additional boats are building now, to further increase the service. The bridge cable handles upwards of 125,000 daily.

As a substitute we believe the system of endless moveable sidewalk operated for several months experimentally in this city, and previously fully illustrated in these columns, is worthy the closest investigation of the bridge commissioners. A section 4,300 feet long will be in operation at the Fair. This system consists of three parallel and close fitting platforms. The first stationary, the second moving at three miles an hour, and the third, which is fitted with comfortable cross seats accommodating three persons each, at six miles an hour. The line here is operated by electric motors, but for use on the bridge it would be an easy matter to retain the cable system just as it is and use ordinary cable grips fastened to the platforms at suitable intervals, and which would automatically release the cable at the proper "throw offs," and take it again in the same manner at the "pick up." But one cable is required, as one of the two moving platforms ride on the periphery of the wheels which carry the other. The speed could be fixed at any rate desired. It would be necessary to enclose the platforms in a stationary wooden or light metal structure about the size of a car and reaching all the way across the bridge, but this is neither expensive or difficult.

The installation of this system should be accomplished with less than a week's delay in traffic; will not require any disturbance whatever of the present tracks, except slight changes at termini; and absolutely without change or one dollar of additional expense in the present power plant. A most important feature, and only possible with this system.

With this system operating at a six mile speed 31,680 people could be transported each way every hour, and every one would have a seat.

The question of safety will naturally first arise, but on this point the record of the thousands carried last year at the World's Fair grounds including people of all ages

from children to the infirm, and without a suggestion of an accident is sufficient answer. In fact it is difficult to imagine how an accident could possibly occur. While the moveable sidewalk is not intended to supercede surface or elevated roads, it has a wide field all its own, and in which, as on the Brooklyn bridge, it offers a service which has no equal. For a down-town loop in Chicago connecting the termini of our elevated roads and the various depots it offers a positive solution. The facilities are indeed those of cars operating on a headway of about two seconds. The moveable sidewalk at the World's Fair will constitute, we believe, the most unique and interesting exhibit in all the wide range of transportation, but unlike some others is not built for show only, but for the transportation of 40,000 passengers per hour, during the entire day, from May 1 to November 1st.

We especially commend to our New York and Brooklyn friends visiting Chicago, a careful study of this interesting, simple, comparatively inexpensive and most practical system. The highest engineering authorities in America and Europe have given it their indorsement, but to the ordinary citizen the actual and successful operation as will be witnessed on the Casino pier, will be the more satisfactory evidence of merit, and all-convincing.

UNITED STATES TIMBER TEST WORK.

ALTHOUGH all the leading railroad engineers, architects, professors of engineering and others interested in the timber tests had flooded with hundreds of letters their representatives and senators, and the committee on manufacturing, in whose hands the special appropriation was pigeon-holed, neither the committee nor the house paid any attention to this expression of public interest. The senate, however, increased the appropriations for the Forestry division by \$8,000, that is, 20 per cent of the amount asked.

Under the circumstances, the testing will be discontinued until after July, when the new appropriations become available.

Those interested in the investigation should not fail to move again when the new Congress assembles.

The first compilation of test results will probably be issued within six or eight weeks as Bulletin 8, Timber Physics, Part II. It will contain the results obtained on Longleaf pine, and will discuss in detail the results of tests and examinations of bled and unbled timber, results which in themselves justify the expenditure.

The Forestry Division will exhibit the methods pursued in this work at the World's Fair.

Another exhibit of interest to railroad engineers and those interested in reducing forest waste, will be a collection of the most approved types of metal railroad ties.

THE New York Commercial Advertiser says that, "the Rapid Transit Commission fully justifies its title in the rapidity which it causes Manhattan stock to fluctuate—but in nothing else particularly."

COOK'S ELEVATED RAILWAY SYSTEM.

THE days of the stage coach for the extensive transportation of passengers have long since faded into an illustrious past; but with all our evolution which has developed to annihilate time we have persistently clung to some of the salient features of the stage.

Addressing the Engineer's Club of Philadelphia recently, John C. Trautwine, Jr., remarked: "We may well believe that so radical an increase in speed as is now



L. F. COOK.

contemplated will demand a similarly radical departure from our present methods. When we have come to regard 80 or 100 miles per hour as an everyday affair, I believe we shall have abandoned the imitation of the stage coach, with its center of gravity several feet above its base, and our vehicles will be suspended from, rather than supported by, the rails. It is safe, too, I think, to predict that instead of heavy trains dispatched daily

or hourly, single and light vehicles will follow each other at comparatively very short intervals."

Oberlin Smith, in the *Engineering Magazine*, predicts the advent of high speed cars as operating on elevated structures, so built as to make derailment impossible, driven by electricity and with light, narrow cars, which shall cut the air like a bird.

So expectant is the civilized world to-day of the speedy solution of the rapid transit problem, both as applied to long distance and to city travel, that every new method is scrutinized in the hope that the solution has been reached. The requirements as laid down by Trautwine and Smith, above quoted, have all apparently been worked out by Lucien F. Cook, of Tacoma, Washington, who has spent twelve years in perfecting his system. Not only is it adapted for long distance high speed lines, but affords rapid service along the streets of even the largest cities. It is, of course, an elevated structure, but of such construction as to practically offer no objection in the matter of obstructing light and air.

The Cook system is simplicity itself, both in construction and manner of operation, and he does what no other inventor has ever done, namely, operates two trains in opposite directions on the same track. The entire elevated construction is light but being made of angle iron and truss girders affords maximum strength with a minimum weight. The supporting pillars are spaced from 30 to 60 feet and rest upon foundations below the frost line. These pillars may be carried to almost any desired height but preferably to 18 feet above the surface. Upon and

securely riveted to them rests the longitudinal girder with the upper surface curved in a concave form. Fastened to the bottom of the girder on either side are the beveled rails. The cars which are narrow and very light, but of any desired length, are carried on either side the girder and of course move in opposite directions. These cars operated single or in trains are suspended from an arm at the upper corner extending the length of the car. This arm is of angle iron of great strength, in which are anti-friction wheels which take the bearing. These wheels travel in the concave track resting on the girder. Should by any accident even all the wheels be broken the arm would still support the car. The driving wheel is mounted on the armature axle, and its periphery is beveled to run on the beveled rail. A guide wheel carried to run on the under side of the beveled rail renders it utterly impossible for the car to jump the track under any conditions that could possibly arise. This guide wheel can be tightly pressed against the rail by a hand lever to increase the traction. An iron shoe also travels against the rail for braking purposes and is applied with a hand lever. The driving wheel is of small diameter and actual demonstration has developed the fact that it need not have a face of more than one-quarter inch. As the speed increases this driving wheel gradually climbs the beveled rail, thereby transferring the load from the suspending wheels to itself, but is limited in its play by the guide wheel below.

The trolley wire is carried on the under side of the upper rail, where it is perfectly insulated and is rigidly attached. An ordinary trolley wheel or brush takes the current, which is led to the motor on the car floor in the usual manner. The return current is grounded through the contact of the driving wheel on the lower rail. While it may be as long as required, the car body ranges in width from 26 to 40 inches, and in height from 4½ to 7 feet, according to speed desired. For high speed it should be pointed fore and aft. While extremely strong it is very light, in fact, weighs no more than the passengers it carries. Seats may be either longitudinal or cross, and passengers enter and depart from side doors placed on the outside only, affording unequalled facilities for loading and unloading. The car heaters are, of course, electric, and at night light comes from the same source. A surprising feature of the system as actually proved by demonstration is that no car springs are required.

Until the present Mr. Cook has given his plans no publicity through the press. However, to demonstrate the practicability of his system he built in the city of Tacoma a line elliptical in shape and 800 feet long, ranging from 7 to 16 feet high, combining all the difficulties of construction to be found under all conditions. Two grades of five and ten per cent were also made as part of its features. Notwithstanding the fact that the structure was wholly of wood, with the pillars set only twelve inches in the ground, and the rail at the top was simply wood lined; with light strap iron, as was also the beveled rail below, he found no difficulty in operating at a speed of forty-two miles an hour, starting and stopping quickly and at will; and carrying twelve passengers, although the

seating capacity of the car was but eight. The curves in the experimental line would rarely if ever be found in actual practice: and on reasonably straight track, there seems to be no question that he can maintain a speed of from 100 to 200 miles per hour. A representative of the REVIEW, who participated in several of the tests on the Tacoma line, testifies to the high speed, the perfect ease with which the car traveled, and is fully convinced that with a longer and less crooked track 100 miles an hour will be an easy matter. The same car ran equally well on either side of the track, making both the in and outer curves.

The reader will naturally first ask himself why the track structure does not tip or lean to one side or the other. While to all appearances this would be the natural result, in fact the car weight is so distributed that it becomes comparatively center bearing, and the resultant is a downward thrust.

In making high speed one great obstacle has always been vibration. This has been overcome in this system by the contradictory forces (the outward bearing at the top and the

least expensive of any system of elevated roads yet devised; the same may be said of the equipment, and the time required to build a line is also very short. Further, and in conclusion, Mr. Cook calls attention to the following points of advantage:—

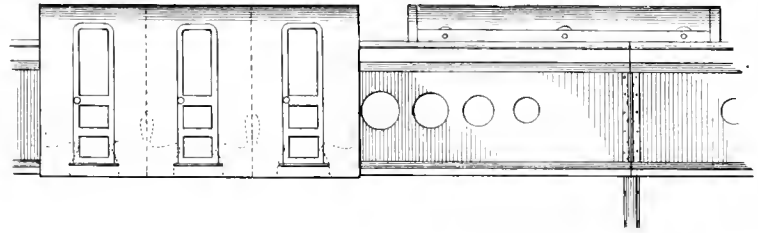

SIDE VIEW OF CAR AND SOLID GIRDER.

He meets all contingencies; he builds his structure on the angle iron principle; takes up the least room; shuts out the least light: has at all times the combined strength of his tracks and by suspending his car from

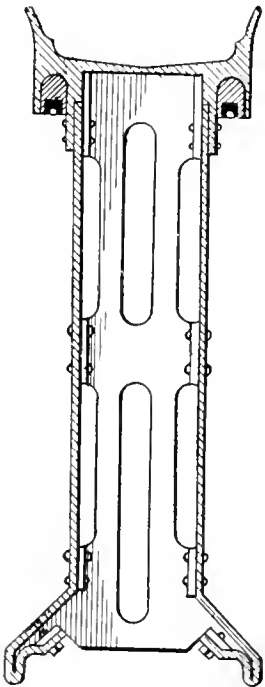

CROSS SECTION GIRDER.

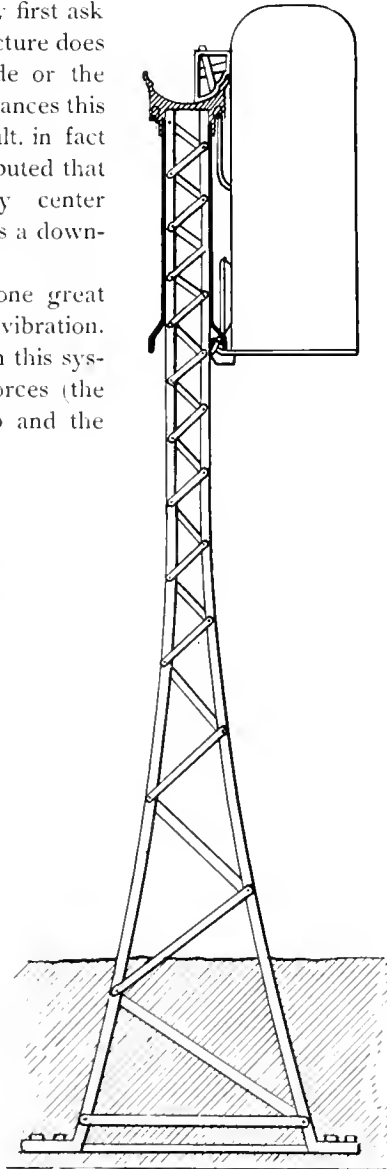

CROSS SECTION STRUCTURE.

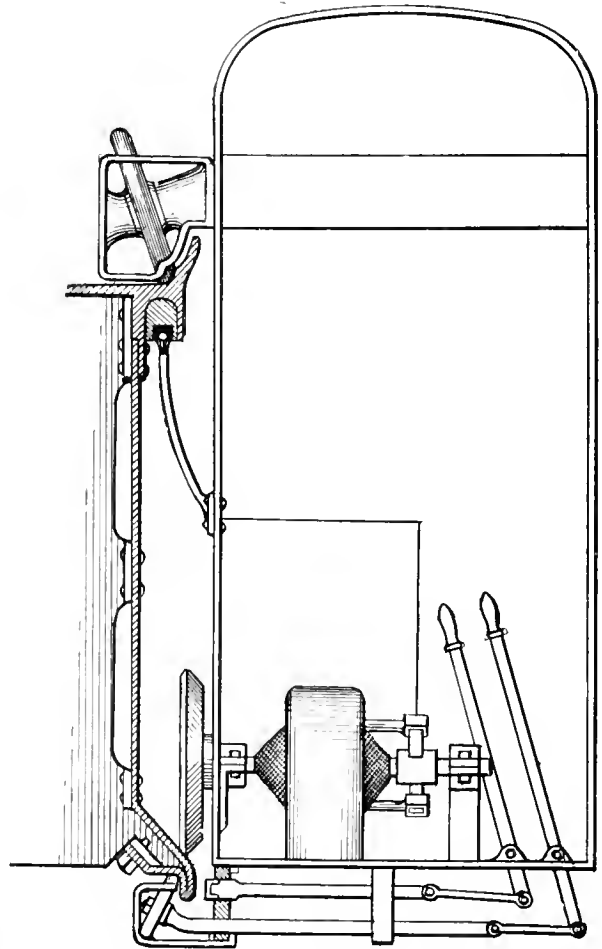

CROSS SECTION CAR—DETAILS AND MANNER OF SUSPENSION.

inward bearing at the bottom), thereby having a tendency to deaden vibration.

As will be strikingly noticed by reference to the illustrations the system throughout is marked by the utmost simplicity. The parts are all strong, extremely light and few in number. It is difficult to see where the present plans are to be bettered. Construction is by far the

the top carries less dead load; and by carrying from an upper corner is enabled to concentrate his tracks. He has greater strength in proportion to load carried than any system yet devised. Upper and lower rails compensate at all times; and the perfect gauge between upper and lower tracks is always preserved. The structure offers little resistance to air pressure. Supports may be

placed thirty to sixty feet apart. In crowded streets supports may be placed on either side of the street at the curbs and arched to the center, as in the illustration, where one or more lines may be suspended having

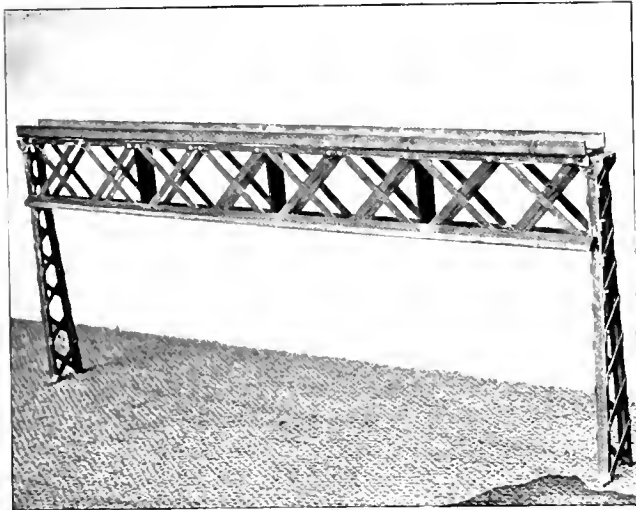

LATTICE GIRDER CONSTRUCTION.

various speeds. Narrow sidewalks may also be placed along the tracks, and second story fronts may be converted into retail establishments. Blockades or any of the other disadvantages of surface traction could not operate to disarrange the schedule and speed.

Light loads with great speed and frequency have always

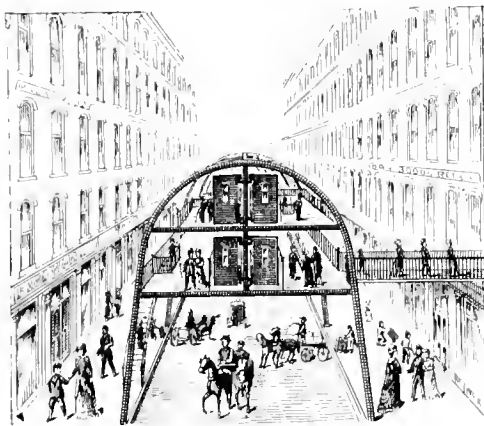

METHOD OF FOUR TRACK SUSPENSION.

been Mr. Cook's theory in pursuing this subject, thus dispensing with great strain on track, cars or machinery, and affording more convenient and profitable service. A company in which some of the best known capitalists in Chicago are included has been organized to build a line in Chicago, and as soon as the material can be made will have it on exhibition here.

The General Electric Company are building at Lynn, a portable electric welder, suited for taking out on the track and welding the rail ends. Current is supplied from the trolley wire.

POSTAL STREET CARS.

CINCINNATI is not behind the times in any respect, and Cincinnati railways and their managers are in the fore front of every enterprising movement.

The latest plan to make both ends of the car pay dividends is that now in operation on the Cincinnati Inclined Plane Railway Company, of becoming a mail route and bona fide government contractors. There are five post offices on the line of the railway, and the mail destined for the stations at Corryville, known as station "E," Ludlow Grove, (St. Bernard), Elmwood Place and Carthage is loaded on the front platform of the cars and whirled to its destination, via the C. I. P. Ry. Company's track. Other lines in Cincinnati also handle mail.

H. M. Littell began overtures last year towards this end, but the matters were closed up and contracts made by H. P. Bradford, the present general manager. The mail delivery is frequent, the cars carrying five times a day each way, and the company regards it as a successful venture.

In this same great state of Ohio there are two more progressive towns Massillon and Canton. Both are manufacturing centers and have a large migratory population, drifting from one town to the other to work, or on pleasure bent. Eight miles of good electric wire bring the towns into communion, transporting not only passengers, but freight, baggage, express and mail. To accommodate this latter traffic, the management has built a special car, designed as a counterpart of the regular steam postal cars, only smaller. The Canton-Massillon car is 18 feet long, 6 feet wide, with vestibule platforms. No passengers are carried on this car, which is an independent motor and runs in a train by itself.

Wells-Fargo express is carried from Massillon into Canton, where a new office has just been opened. Local transferring is left to the transfer companies. The mail service is from post office to post office, carrying four mails each way a day. For the mail service, the government pays the company \$43.75 a month. No extra men are required, so that the bonus is all gain. The express and baggage business is a paying service and worthy of trial on a number of the numerous interurban roads which are now webbing small towns together.

The most extensive street railway mail service is, however, found in St. Louis. Postmaster Harlow, an enthusiast in this work, is the author of the street railway mail service in St. Louis.

This system of mail distribution is made on the St. Louis & Suburban Electric Railway with a special car constructed for the purpose.

This car has the regular motor and trolley pole equip-

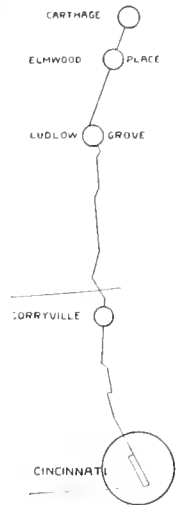

ment, but otherwise resembles the railway post offices of steam roads. Inside it is fitted with mail boxes, hooks for pouches and sorting desk. It is 44 feet in length, 7 feet 10 inches wide, 11 feet 4 inches high; car body length 36 feet, inside height at center 7 feet 9 inches, with a side door opening 4 feet. The working force consists of one stamper, one distributor and a motor man.

The car travels over a system embracing 19 miles, receiving and distributing mail en route to and from the post office building, past which it runs. The aggregate run of the car in its three round trips is 114 miles, and the time occupied in each trip is 3 hours 12 minutes.

Way stations are established at irregular intervals along the line where carriers congregate to receive or deliver their mail bags. The first trip is started at 6:25

New York and Brooklyn are considering the advisability of a like arrangement and, no doubt the cities of Baltimore, Philadelphia and Chicago will find out its advantages later.

The street railways of our cities have advantages more than one, and enterprise and pluck is all that is required to develop them.

THE EDISON ILLUMINATING COMPANY, Philadelphia, have increased their boiler plant and installed the Babcock & Wilcox boilers, which have been selected after the most careful investigation. The new boilers aggregate 1,700 horse-power and are built entirely of steel to carry 225 pounds pressure.



ST. LOUIS POSTAL CAR.

a. m. from the post office, and arrives at Cabanne at 7 o'clock. It is met at the ten or twelve stations by the carriers throughout the adjacent districts. Leaving Cabanne at 9 o'clock the mail is delivered at the post office at 9:33, and the car lies over until 9:50 when the next trip is made.

The system obviates the delay, expense and trouble of bringing local mail to the post office, distributing, canceling and receiving all along the line. City letters thus can be delivered in 30 minutes.

The amount of mail handled by the street railway postal system amounts to 5,000 letters a day. Forty-nine carriers are supplied and relieved of their post office trips and, as above narrated, three round trips are made each day.

Postmaster Harlow reports to the Postmaster General that the system is entirely satisfactory and meets the requirements of the local service to a degree of perfection unobtainable by any other method.

THE General Committee of Engineering Societies for the Exposition have made arrangements to have reception rooms at 10 Van Buren street and in the Mines building on the Fair grounds. At both of these places engineers will find a comfortable retreat with surroundings corresponding to their profession.

DISTANT mutterings are heard of a scheme to connect Brookville, Md., with Baltimore, by an electric road. Inter-urban roads know not the word "can't" in the year 1893.

HON. GEO. B. SHAW, Congressman-elect and well known in electrical circles by reason of his connection with the National Electric Manufacturing Company as its general manager, has assumed charge of the World's Fair Bureau of the Ansonia Electric Company. This bureau will have for its sole end the entertainment and assistance of the friends of the Ansonia Company at the World's Fair.

HALF FARES.

Interesting Facts from all Parts of the Country Boiled Down for Busy Readers.

SIEMENS & HALSKE, of Berlin, have just finished an electric road for Gross-Lichterfields which is now open for traffic. They are constructing one at Hanover.

THE Ashtabula case has now reached the Supreme court of Ohio. Eight years ago the city authorities tore up four miles of track, and J. N. Stewart has been after them ever since.

THE Tuscarawas Rapid Transit Company is the name of a road to be built this summer from New Philadelphia to Ulrichsville, O. The right of way is secured and work will be pushed.

THE Broadway (New York) cable is being operated above Fifteenth street. In this way an opportunity will be given to educate gripmen preparatory to opening the downtown line for traffic.

THE Ansonia Electric Company has in preparation a book of tables and other information for use in electrical work. Rumor says that some very valuable tables have been obtained at considerable cost.

ELECTRICAL ENGINEER FREDERICKS, of the Davenport & Rock Island Railway, is engaged in construction work on the Chicago & North Shore. He will probably serve as electrical engineer for both roads. Work on the latter line is progressing finely.

A COMPANY is being organized to build a road between populous factory districts in South Waukegan, a suburb of Chicago. F. W. Ganse, Calvin Dickey and Byron Y. Craig are incorporators. Mr. Ganse's office is in Chamber of Commerce, this city.

IN Wheeling, West Virginia, there is a city ordinance visiting the offenses of children against city laws on the heads of their parents and guardians. This was made use of in the recent strike when the strikers' children interfered with traffic by putting obstructions on the tracks.

THE farmers of Contra Costa county, Cal., are becoming interested in a scheme to build a network of electric roads to connect their region with Oakland, and the plan now seems reasonably sure of success. It will be a farmers' road rather than a suburban passenger line.

SIR FREDERICK BRAMWELL, the umpire appointed to put a valuation on the property of the London Street Tramways Company, which is to be purchased by the city of London, has decided that \$313,664 is a proper estimate, not taking into account the compulsory purchase.

A NEW use for the electric car was found at Springfield, Mass., recently. A fire engine got stalled going up grade on the way to a fire. A motor car came up behind and helped it up the hill on a double quick. And yet some people claim that the trolley is a hindrance to firemen!

THREE-FOURTHS of a mile of underground trolley road, designed by Malone Wheless, is being experimented with at Washington, D. C. The trolley wire which is run in a conduit is divided into sections 200 feet long. These sections are automatically connected with the feeder cable as the car goes along, being dead at all other times.

THE franchises have been granted for the Galt & Preston, Ontario, Street Railway, to operate by steam or electricity; to be built this year. R. G. Cox, St. Catharines; Thos. Todd, Galt; Fred Clare, Preston, and T. M. Bent, of the Berlin & Waterloo Street Railway, are interested. The names mentioned insure the success of the enterprise.

CONSIDERABLE interest is being excited in Chicago by the passage through the council of an ordinance granting the Midland Rapid Transit Company a franchise for either an elevated or underground road between Jackson and Madison streets, from Franklin street to the city limits, with several branches. An air of mystery hangs around the backing of the scheme that is the food for much newspaper speculation.

THE Twin City Rapid Transit Company, St. Paul and Minneapolis, have given notice that it will, on June, 1, increase the wages of motormen and conductors that have been in service more than a year from 17 to 20 cents per hour. New hands will be advanced from 17 to 18 cents. This is a fair sample of Mr. Lowry's generous and far-seeing policy. The company announces that the object of this move is to recognize the efficiency of the men and to stimulate them to further care in the observance of rules. The change gladdens the hearts of 1,000 men and increases the annual expenditure \$75,000.

THE SAFETY BRAKE SHOE COMPANY, of Boston, manufacturers of the Composite Brake Shoe, have secured the services of George C. Ewing as their superintendent. Mr. Ewing has been connected with the railway department of the General Electric Company, and accepts this position because of the encouraging developments in the sale and use of this brake shoe. He will visit Chicago soon, and other intermediate cities, in the interests of the company. They have also engaged the services of James J. Sides, who comes to them from the electrical and mechanical department of the West End Street Railway, who will travel in other parts of the country. As both of these gentlemen are practically familiar with street railway work, they will undoubtedly meet with favor from street railway officials.

PERSONAL.

E. F. SEIXAS is traveling in Italy and will be absent two months.

CHARLES HATHAWAY, Cleveland, was a recent visitor at the REVIEW office.

C. McL. PAINE has assumed business management of the Architect's Electrical Bulletin.

GEO. W. PEIRCE retires from the superintendency of the Concord, N. H., Street Railway Company.

HARRY P. BARR has resigned the position of secretary and general manager of the Sperry Electric Company.

JOHN S. PUGH, while successfully representing the merits of the Baltimore Car Wheel, called at the REVIEW office during March.

ELMER P. MORRIS, special agent of the General Electric Company, is located for the present in the Lombard building, Indianapolis.

JAS. J. SIDES has resigned his position with the West End Street Railway Company to accept one as traveling salesman for the Safety Brake Shoe Company, of Boston.

NELSON W. PERRY, of the Electrical World, recently suffered the loss of his father, who was a prominent member of the Cincinnati bar and at one time member of Congress.

A. I. JONES, formerly superintendent of the Great Falls, Montana, Iron Works, has assumed the selling agency of the M. C. Bullock engines and mining machinery, at 39 South Canal street.

A. M. YOUNG, the well known electric railway builder, of Connecticut, was one of the first in the field of electric railway work, and has achieved the success which is the just due of all pioneers.

THE venerable Henry Hanna, of Cincinnati, has resigned from the directory of the Cincinnati Street Railway Company on account of ill health. Mr. Hanna is past 79 and has earned his rest.

GEO. C. EWING, formerly connected with the railway department of the General Electric Company, has resigned to accept the position as superintendent of the Safety Brake Shoe Company, 620 Atlantic avenue, Boston, Mass.

RECENT visitors at this office include W. W. Bean, president St. Joe Electric Railway; A. E. Hay, president Robison Truck Company, Altoona; John J. Hoppes, president Hoppes Manufacturing Company, Springfield, O.; A. W. Lynn, of the Milwaukee City Railway.

W. S. NELSON, of Kansas City, well known in rapid transit circles of that metropolis, and builder of the West Side Electric Railway, nearly lost his life recently in a heroic and successful attempt to save the lives of two ladies who became panic stricken in front of a cable car.

W. J. JOHNSTON, publisher of the Electrical World, has been spending several days in Chicago, and was a welcome caller at the REVIEW office. The wonderful success of the Electrical World is fully deserved, while its constant improvement and progress reflects the highest credit on its management.

FRANK X. CICOTT, who has been managing director of the Railway World, London, since its inception, has severed his official position to engage in other business. During Mr. Cicott's connection with the World it has taken a foremost place among European publications. A. M. WILCOX, formerly of this city, who has been editor, will now add to his present duties those of managing director.

PRESIDENT ALBERT J. ELIAS, of the Third Avenue Railway Company, New York City, J. H. ROBERTSON, the well known and popular superintendent of the same line, and C. FREDERICK KOHL, vice-president of the Pennsylvania Iron Works, were visitors in Chicago during the month. Chicago's street railway lines occupied their attention, and a visit to the STREET RAILWAY REVIEW office was an incident to the visit.

DANIEL F. LEWIS, president of the Brooklyn City Railway, and whose name stands so prominent as the head of the great Lewis & Fowler Manufacturing Company's interests, was married on March 22 to Miss Mary VanVleck, of Plainfield, N. J., formerly of Brooklyn. Mr. Lewis and his bride has the best wishes of his numerous friends and acquaintances, and the felicitation of the STREET RAILWAY REVIEW in particular.

THE car was going down the st.
She stepped off backwards with both ft.
But what she said is hardly mt.,
To print in the REVIEW.

C. J. SWIFT, of the Ford-Washburn Storelectro Company, of Cleveland, has contracted for five 30-horsepower equipments for the Woodland Avenue and West Side Road of Cleveland.

W. HASKELL KING & COMPANY, of New Haven, Conn., are in the market with an anti-rattler car window fastener, described in the REVIEW last month.

THE JOHNSON ENGINEERING & FOUNDRY COMPANY, of New York, has bought the frog and switch business of Abram Ayres and will hereafter carry on that business.

AN INDIANAPOLIS RAILWAY GROUP.

BEFORE resigning from the presidency of the Citizens' road at Indianapolis, Mr. Frenzel called his executive force together and expressed his desire to have the photographer secure a picture of the group. The rest in turn consented, on condition that Mr. Frenzel would himself constitute one of the number. The engraving is from a photo 20 by 24 inches, and the various portraits will be recognized by many of our readers, owing to the large acquaintance of the Indianapolis officers.

A NEW YORK syndicate which is already operating several large systems in the east, are making strenuous efforts to secure franchises in the suburbs of Montreal, and are also reported as trying to secure the right to use the tracks of the City Passenger within the city limits.

THE Toronto & Scarboro Electric Railway is another one of the numerous proposed inter-urban roads. The plan is to construct an extensive network of lines between the towns mentioned and to sell current for power and light along the line. The management have issued a handsome prospectus.



S. F. HAZELRIGG, Pur. Agt.	H. POPENHOUSE, Clerk.	W. S. JEWELL, Elec. Supt.	A. A. ANDERSON, Sec. and Treas.	J. J. MAHONEY, Paymaster	R. F. SALTMARSH, Asst. Book Kpr.	W. E. JONES, Clerk.
E. W. MADISON, Collector.	W. T. LEWIS, Asst. Supt.	J. P. FRENZEL, President.	R. G. SWAIN, Clerk.	G. H. HERPICK, Roadmaster.	F. BRUNER, Collector.	"GOVERNOR."
	W. F. MILHOLLAND, Cashier.	T. DONAHUE, Clerk.	MRS. SALTMARSH, Stenographer.			

THE Clapham Junction & Paddington Underground Railway, of London, has struck a novel kind of a "stump" in attempting to get its bill through parliament. The professors of the City Guild's Institute and the Royal College of Surgeons objected to the proposed road because of the alleged magnetic and mechanical disturbances that would be caused by its operation near their institutions. They claimed that it would render impossible all delicate experiments. To an American the most natural answer would be for the institutions to move elsewhere, but the British committee of parliament thought otherwise and rejected the bill.

THE annual report of the General Electric Company made to the stockholders April 11, showed a net profit of \$3,356,593 for eight months.

THE Lake Street Elevated of this city is preparing to extend their structure east to Market street, to which point their franchise extends. There has been some controversy between the company and the commissioner of public works in regard to placing piers in the middle of Canal street. The company's engineer claims that a span across the entire width of the street would be unsafe.

CHICAGO.

THE old world has its legends of gnomes and giants, heroes and prophets, of Aladdin's lamp and song-set stones of Thebes. Beautiful they are and their shadows and secrets come down to the present day as an incense and a restful memory.

We westerners have no burdens of legends to carry and our minds are free to grasp where we will, and plant while we may, the wild fruit or the cultured grain, untrammelled by ancestry or ancients.

For this reason, growth to the west and enterprise to its citizenship, must take the place of fancies and cold hard figures must decorate our literary monuments.

The Columbian year and the Columbian prize poet, and the prize statue must bow before the Columbian prize hog and the Columbian prize

packer pays the bills.

Little is left our Columbian poet but the shadowy figures of Father Marquette and Pere Joliet and more of our Chicagoans know the hotels and towns named after these worthies than of the holy zeal that brought them from France.

We glory in our utilitarianism.

We rejoice in railways, our hogs and our men—real men who do and plan.

Chicago's history can be written only in figures and dates. Nothing else can unfold so rapid a growth. In 1818 Illinois became a state by virtue of a rather original method of counting the population. Eleven years later the town of Chicago was platted and in 1830 the first map was drawn showing a little strip of what is now the North Side and a generous slice of the West Town. About this time Cook county was organized and a thorough search found a dozen families as the total population. Old stories of the Fort Dearborn massacre have no place here, but the massacre and packing of a party of cattle in 1832 was an event big with promise.

So we grew.

The first census was taken in 1837 with this result: Males and females over 21 years of age, 2,645; under 21 and above five, 831; children, 513; total, 3,989 white persons and 77 colored brothers. There were 398 dwellings, 100 business houses and five churches complete the list.

Fifteen years later there were 60,000 people in Chicago. In 1865, 178,900; in 1875, 400,000; and in '85, 1,000,000. 1893 counts 1,500,000, and estimates of conservative men give 1930 as the time when the mayor of Chicago will preside over 4,000,000 inhabitants.

Thus it was not until 1837 that Chicago began its commercial history. Then no factory sent its smoke into the pure prairie air. Now thousands upon thousands of souls depend upon the causes of the smoke nuisance for their daily bread.

In 1857 fire ravished the incipient city of many of its early buildings; 1859 gave another scorch, 1866 followed and 1868 helped remove land-marks and frame disgraces. October 9, 1871, is the only day Chicago celebrates for Chicago, is in remembrance of Mrs. Leary's cow's pas suez, which sent \$300,000,000 in smoke and left thousands homeless. The Garden City became the Phoenix City, and to-day it is yours, gentlemen, to inspect, wonder at and admire.

Our railway systems we particularly celebrate. In 1853 S. B. & M. O. Walker and Parker & Co., controlled the street traffic, which consisted of eight lines of omnibus, running 18 vehicles a total of 408 trips per diem on 22½ miles of streets with 802 omnibus miles a day. Now 500 miles of street railway operate 4,000 cars and carry 300,000,000 a year.

Great is Chicago. Selah.

THE CHICAGO CITY RAILWAY.

August 16, 1858, the council granted franchises on State and Madison streets and Cottage Grove avenue to Frank Parmlee, Liberty Bigelow and Henry Fuller. A previous attempt had been made in 1856 to start a street railroad, but this was the first one destined to succeed. An act of legislature in February, 1859, approved the City Railway, but with the condition that nothing but a single track, with necessary turnouts, was to be constructed, and only on condition that the consent of the owners of two-thirds of the property in lineal feet along the line of the road could be obtained. As many property owners were opposed to the project, it was necessary to buy the consent of a large number. The first cars were run in April, 1859, on State street,

between Madison and Twelfth streets, and a month later the Madison street line, between State and Halsted streets, was opened. From this on the lines were extended rapidly in all directions, and consent to lay double track was obtained. The United States Fair at Ft. Douglas, in 1859, induced the laying of a track to that point. The streets below Twelfth were simply planked and the rails were spiked directly on top of the planks.

During the times of poor money in '61 the tickets issued by the City Railway played an important part in the monetary affairs of Chicago. Their face value being unquestioned, they were by all odds the most convenient small change available. Large numbers of them were hurriedly issued, until counterfeiters began to get in their work, when the tickets were recalled and better ones substituted.

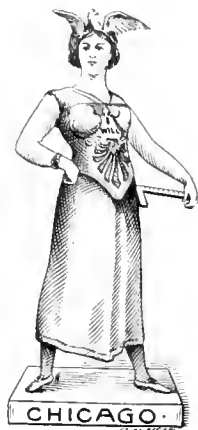

Geo. H. Wheeler, President C. C. Ry.

About 1867 the use of "bob-tailed" cars was inaugurated in order to cut down the running expenses. Their use continued until 1874, when the fastidious public refused to pay fare except through a conductor.

In 1875 the line on Wabash avenue was built, not, however, without the usual objections of the property owners along the line—so great was the objection, indeed, that it was found expedient to lay the track on Sunday.

From this until 1880 matters went on in a quiet way with the usual number of extensions and the natural increase in business. In this year, however, an incident occurred that was destined to have a tremendous influence not only on street railway work in Chicago, but in the entire United States. Appreciating the future demands of the company and with a firm belief in the possibilities of the cable, but in the face of the strongest opposition C. B. Holmes, then superintendent and afterwards president, made a thorough investigation of the San Francisco cable system and it was finally decided on as a motive power. Ground was broken June, 1881. Arrangements were made to equip the entire line on State to Thirty-ninth street and

The offices and principal power house are at the corner of State and Twenty-first streets, this power house being the largest in the city. Another is located at Cottage Grove avenue and Fifty-fifth street. South State street is supplied from one at State and Fifty-second, near which is the new electric plant. The company has 35 miles cable track, 114 of horse lines, 1,740 cars, 2,700 horses, and employs 3,820 men.

THE NORTH CHICAGO STREET RAILROAD.

In 1859, the same year that saw the City Railway started, W. B. Ogden, Jno. B. Turner, Carlos V. Dyer, Jas. H. Rees and Volney C. Turner, incorporated the North Chicago City Railway, and in August, 1859, the first cars were run between North Water street and Fullerton avenue on Clark street. Clark street was at that time planked and the rails which were center bearing, were spiked directly to the plank roadway, a simplicity of construction that will doubtless be envied by many of the roads of to-day. Another interesting feature of this primitive Clark street line was the cars. Their bodies were



F. R. GREENE,
Secretary.



T. C. PENINGTON,
Treasurer.



M. K. BOWEN,
Superintendent.

on Cottage Grove avenue to Thirty-ninth. It was not entered into as an experiment, but as if success was a matter of course, although it was the first road of the kind designed for heavy traffic and cold winters. Both the City Railway and the street railway fraternity have reason to be thankful for this bold step. The first cable train in Chicago was run on the occasion of the opening of the road in January, 1882. It consisted of ten cars drawn by a single grip and carrying 1,000 passengers. So opened a new era in Chicago's local transportation. Since the original lines were started they have been extended—the State street to Sixty-third and the Cottage Grove to Jackson Park and Oakwoods. The most important change recently made by the City Railway is the adoption of electricity on its feeder lines, which change is now being completed. The officers are: President, Geo. H. Wheeler; vice-president James C. King; treasurer, Thomas C. Penington; secretary F. R. Greene; superintendent, M. K. Bowen.

shaped very much like an omnibus. The driver sat "on the roof." When the end of the line was reached the whole car did not turn around. The truck remained stationary and the car body turned using the truck for a turn-table. Whether the truck got tired of always facing one way history does not relate.

However, as was natural with a city of 90,000 population, the road soon outgrew such methods and rapidly extended its lines. The history of the North Side road was particularly uneventful until in 1886, the North Chicago City Railway became the North Chicago Street Railroad and passed in the hands of the Philadelphia syndicate, at which C. T. Yerkes is the head. The new management soon began to plan for cable construction and in the latter part of '86 the necessary franchises, together with the use of the LaSalle street tunnel were granted and the work was begun. In March, '88, the lines were opened for traffic. Lincoln avenue has since been changed to cable. About a month after the open-

Street Railway Review

ing of the cable lines occurred one of the most serious strikes in the history of Chicago, involving as it did the daily transportation of the many thousands of people living on the North and West Sides. The North Side conductors and drivers were the first to go out. They were soon followed by those on the West Side. Then followed a time of the greatest confusion. Every available vehicle

The power houses are three in number. The principal one being at the corner of Clark and Elm streets and the others at Illinois street and La Salle avenue and Lincoln avenue and Sheffield avenue. The Connelly gas motor is also used on some of the feeder lines. The company has 19 miles of cable track; 62 miles horse lines; a total of 796 cars and employ 1,400 men.



J. B. PARSONS,
General Manager West Chicago Street Railroad.



CHAS. T. YERKES,
President North Chicago Street Railroad;
West Chicago Street Railroad.



J. WM. HELM,
Secretary and Treasurer North Chicago Street Railroad.



R. C. CRAWFORD,
Secretary and Assistant General Manager
West Chicago Street Railroad.



CHAS. NAGL,
Superintendent West Chicago Street Railroad.



F. L. THREEDY,
General Manager North Chicago Street Railroad.



J. M. ROACH,
Vice-President North Chicago Street Railroad.

was brought out and made to do service in carrying the crowds to and from their homes. There was some mob violence on the part of the strikers, but in time matters quieted down and the company came out victorious. The company at present is under the care of President C. T. Yerkes; Secretary and Treasurer J. Wm. Helm; General Manager Fred L. Threedy; Superintendent John M. Roach.

THE WEST CHICAGO STREET RAILROAD originated in the West Division Railway Company, which, in 1861, bought the franchises and track of the City Railway on the west side for \$200,000, the tracks at that time consisting of lines on Madison and Randolph streets to Union Park. They began at once to push extensions. Immediately after the fire in '71 the West Division Railway was run in con-

nection with the City Railway in order to accommodate the crowds that were continually moving between the South and West Sides.

November, 1887, saw the West Division Railway pass into the hands of the West Chicago Street Railroad, or, in other words, into the possession of the Yerkes syndicate. The Washington street tunnel having been secured, the installation of the cable was begun in 1888. It was not until the summer of 1890, however, that the traffic opened under the cable system. There are in operation at present three power houses. The one operating the tunnel loop is at the corner of Washington and Jefferson streets, where also are the general offices. Madison street has one at Rockwell running both the east and west cables on that street. The Milwaukee avenue power

house is at Tell place. The road is operated by the following officers: C. T. Yerkes, president; John B. Parsons, vice-president and general manager; R. C. Crawford, secretary and assistant general manager; S. Potis, Jr., mechanical engineer; Geo. E. Newton, treasurer; C. Nagl, superintendent. One of the largest of this company's enterprises is a new tunnel under the Chicago river, near Van



W. T. BERNARD.

Buren street, nearly completed and costing \$1,000,000. The trackage comprises 28 miles of cable track; 167 miles horse lines; 1,600 cars; 3,000 men employed.

CHICAGO AND SOUTH SIDE RAPID TRANSIT COMPANY.

The year of 1892 saw the inauguration of an entirely new work in the line of Chicago's rapid transit facilities. The "Alley L" as it is commonly known was built under the same legal restrictions and privileges as the steam railroads, securing its right-of-way by condemnation and purchase. A previous attempt had been made to secure rights to build an elevated road on State street but the scheme was not pleasantly looked upon by property owners and so fell through. Work on the "Alley L" was begun in 1890 and the opening ceremonies occurred last May. It ran at first only to Thirty-ninth street. The structure is now completed through to Jackson park. The company also proposes extensions to the southwest portion of the city. The president of the company is W. T. Bernard; vice-president, Arthur Wheeler; secretary and treasurer, John H. Glade; superintendent, H. R. Belknap; traffic-manager, A. J. McBlair; chief engineer, R. I. Sloan. The main offices are at 633 the Rookery.

THE CITY PASSENGER RAILWAY

was incorporated under the name of the Chicago Horse & Dummy Railway in 1884. In 1885 the use of the

Washington street tunnel was given this corporation. The rights were afterwards leased to the West Chicago Street Railroad. Cars were first run on the Passenger Railway in 1885. For some time past this road has been leased to the West Chicago Street Railroad. The officers are Austin J. Doyle, president, and Geo. L. Webb, secretary.

THE SOUTH CHICAGO CITY RAILWAY

was started some years ago as a horse road with but a few miles of track. The "bob-tailed" cars bobbed



D. F. CAMERON.

complacently over the route until the year 1892, when a new syndicate bought the road, secured more franchises and planned for electric traction. The final result was fully described in our last month's issue. The road was put in operation last month on the day following the first trial trip. The power plant and barns are on Ewing avenue, just south of the Calumet

river. The uptown offices are at 208 First National Bank building. The official corps consists of president, D. F. Cameron; vice-president and general manager, J. R. Chapman; secretary and treasurer, O. S. Gaither; electrical engineer, J. F. Esterbrook.

THE CICERO AND PROVISO STREET RAILWAY

is now a little over two years of age. It was organized by a few enterprising citizens of Oak Park and vicinity who were interested in

securing better transportation facilities for their district. The road at present consists of two lines, one on Lake street to the DesPlaines river, and the other on Madison street and Harlem avenue to the river. Both of these connect with the Madison street cable line at West Fortieth street. The country traversed is one of the oldest and most pleasant suburban districts in the neighbor-



T. P. PHILLIPS.

hood of Chicago, and although there are two steam roads with which to divide the traffic the electric is doing a thriving business. Extensions beyond the DesPlaines river are contemplated. The power house is near Ridge-

land avenue on the Lake street line. The present officers are president, T. P. Phillips; vice-president, T. A. Snow; secretary, F. E. Ballard; treasurer and general manager, Hiram Coombs. Men employed, 200; miles track, 22; number of cars, 51.

THE CALUMET ELECTRIC RAILWAY

was inaugurated on a small scale about two and a half years ago. Cars were first run between South Chicago and Burnside on Ninety-third street. In the early part of 1892 W. V. Jacobs secured a controlling interest and an extensive system of reconstruction and extension was begun. All of the old road was relaid and the new lines put in according to approved methods. The country through which it runs strongly resembles a swamp at some seasons, and this was especially so before it was drained. Many car loads of ballast disappeared in the mire before a road bed could be secured. Visitors will notice that the poles along the Cottage Grove avenue line are protected with "breakwaters" to prevent their loosening. This road has in its short career had several exciting experiences. One was on the occasion of the granting of franchises on East Seventy-fifth street to two companies, when the Calumet built a mile track in a day. A strike during the dedication ceremonies last fall caused some inconvenience, but through the pluck of the officers, who with the assistance of what men they could pick up, operated the road for a time—the strikers were left in the same position in which they intended to leave the company. The growth of business and opening up of new lines brought about the erection of a fine new power house, now nearly completed, at Burnside, or more exactly, at the corner of Drexel avenue and Ninety-third street. The old power house is at Stony Island avenue and Ninety-third. Forty-five miles of double track will soon be in operation. The officers are: President, W. V. Jacobs; vice-president, Jas. Carey Evans; secretary and treasurer, A. J. Whipple. General offices are at 607 Tacoma building, corner Madison and LaSalle streets.

THE METROPOLITAN WEST SIDE ELEVATED RAILROAD COMPANY

is at present at work securing its right-of-way. From Halsted street to West Forty-eighth street a majority is already secured. From Halsted street to the river, work has not actively begun. Fifth avenue is the proposed eastern terminus, though as yet the route in the heart of the city is not determined on. Much of the matter published in the newspapers regarding this road is entirely without foundation. From the rapid rate at which the legal proceedings are going on it would seem that the road would be completed before many months. The officers are, John Worthy, president; Geo. Higginson, Jr., secretary and treasurer. Offices are at 1313 Monadnock Block.

THE LAKE STREET ELEVATED RAILWAY

was organized in 1888. About two miles of track have been built west of the river on Lake street. The greatest difficulty this road has met is the securing of a down

town terminus. Many plans have been proposed and there has been talk of a common terminus for all the elevated roads, but as yet nothing has materialized. The company's headquarters are at 26 Marine Building.

THE WEST AND SOUTH TOWN STREET RAILWAY

has been in existence for some months and has laid several miles of track on West Twenty-second street. It is at work securing more franchises but no definite steps have been taken to put the lines in operation. Electricity will probably be used.

STREET RAILWAY SUPPLIES IN CHICAGO.

AS in everything else, Chicago is the greatest distributing point of street railway supplies. Many of the lines are manufactured in this city and their fame has not only extended to all parts of the land, but are known wherever street railways are in use. In addition to such supplies, a large number of manufacturers in other cities find it essential to maintain a branch office here. And this number is rapidly increasing. Any and everything necessary to an entire construction and equipment may be purchased here. It is the Mecca to which the railway manager in all the great west turns his face and to which he journeys when in search of the latest and best. Hardly a street railway in the land but is using some material or device bought in the "windy city."

In view of the fact that fully nine out of every ten railway officers will visit us this summer it is eminently fitting to enumerate the street railway supply dealers of Chicago, and as many visitors will personally meet not a few of the dealers for the first time, we take occasion to thus early offer an introduction even though it be somewhat at a long range.

On behalf of the supplymen of Chicago we can bespeak a most hearty and cordial welcome to all the visiting brethren, and assure the latter that while "it is no trouble to show goods," they need not hesitate to call for fear of being importuned to buy, as not one of them but will extend a warm personal welcome, on personal grounds only. This extreme modesty of Chicago selling agents is well known, and it was only by the purchase outright of nearly all the leading photographic studios in the city we were able to present our readers with the portraits on the following pages. We, however, challenge any line of business to furnish an equal number of as honorable, enterprising, progressive, and good looking representatives as ours.

SARGENT & LUNDY,

on the fourteenth floor of the great Monadnock, are general railway planners, equippers and builders. They also sell McIntosh-Seymour engines.

Their building operations may be seen in any western state within a day's journey of Chicago, and McIntosh-Seymour engines in Cook county are as thick as post-office applicants.

C. F. ORR & COMPANY,

the leading manufacturers of uniforms in the west, are at 126 La Salle street. Their exhibit will meet the visitor at every turn, for the street car uniforms of all the lines



C. F. ORR.

in Chicago, as well as the police, fire departments, telegraph and district messenger companies may be traced to their manufacture, while bands and uniformed societies also come in for their share. This firm probably stands in the lead of any in the country in the amount of business done and the care taken, as every uniform garment is cut from actual measure, and none are allowed to go out until

after passing a most careful inspection. Mr. Orr will be glad to welcome the visiting street railway men at his general office, 126 La Salle, which is in the heart of the city and easily accessible.

THE EDDY ELECTRIC MANUFACTURING COMPANY

will be glad to receive visitors at their pleasant offices in the Monadnock building, numbered 1417 and 1418. Here, the Kohler Brothers and their efficient assistants preside over the western destinies of this well known motor and dynamo business, controlling nearly all the western and northwestern business. They have numerous sub agencies and manage a large per cent of the total output of the Eddy factories.

The two brothers in charge are young in years but old in deeds of light and power. G. A. Kohler, the first of the firm, began his business experience in Chicago and with the North Chicago Railway Company. Afterwards he became connected prominently with several other large concerns but turned to the inviting electrical field in April, 1890. In June, 1891, the firm became Kohler Brothers & Green, but in 1892 Thos. G. Green retired, leaving the firm name Kohler Brothers, who assumed the western agency of the Eddy Company. The business of the parent company as well as of the branch has steadily in-



G. A. KOHLER.

creased so that where the Eddy motor was not known one-third of the horse-power is now Eddy.

Franklin W. Kohler began his business career in Philadelphia, following his brother to Chicago later and finally engaging in the same business. Both gentlemen are genial and cordial in all business relations.



F. W. KOHLER.

At the World's Fair a large exhibit will be placed in the Electrical building, besides 1,000-horse-power in Machinery Hall. The Eddy specialties command high prices but are first class work in the various lines of lighting and electric power.

THE B. F. CUMMINS COMPANY

manufactures hand perforating stamps exclusively. The principal product, the Chicago

check perforator is too well known both as to the advantages of its use and the perfection of its action to require introduction. Besides this, all sorts of perforating stamps for office use are manufactured by the company. A large number of the street railway men of the country have recognized their merits by purchase.

The business is almost entirely wholesale and a large and growing export trade is reported. The Chicago & Northwestern Railway, the Pennsylvania lines, west of Pittsburg, and the Chicago & Great Western lines use a Cumming's patent dating perforator for the dating and limiting of all their tickets.

The factory facilities have been largely increased during the past year.

The officers of the company are: B. F. Cummins, president, and E. W. McClellan, general manager.

THE CAR TRUCK SUPPLY COMPANY

has its home at 1007 Monadnock block, and the pleasant office is presided over by W. S. Burling, whose good natured presence is known to nearly every street railway man in the west. The company was organized three-and-a-half years ago, when the street railway field was much smaller, and has grown with the strength of its clientele until now its specialties are found from the Atlantic to the Pacific, and from Canada to the



W. S. BURLING.

gulf. Their greatest interest to the visiting street railway man are the Hubbard anti-friction side bearings, for steam and street railway use, and the famous Schuttler Ratchet Track Drill. Both these devices have been great successes, and the late sales of the drill have been phenomenally large. The visitor at Jackson Park may see their exhibit in the Manufacturer's building, and in the Transportation, in connection with other displays.

GEO. CUTTER,

325 Rookery, is familiar to every user of street railway goods. Mr. Cutter is a thoroughly experienced electrician, with an experience as long as the tails on the imps which decorate his lamp ads.



GEO. CUTTER.

He began his career in the telephone business. When Elihu Thomson started his factory Mr. Cutter joined the electric light force and won fame in the installation of the American lamp at the Crystal Palace Exhibition, London. After six years of travel in Europe, Mr. Cutter returned to America, and became interested in repair and engineering work until 1889, when he became a maker of electric specialties. He has added to his at first small business until the list of his specialties makes a 100-page catalogue. As agent for the Simplex wire he has made a fine record, and miles upon miles of Simplex have been placed by the "man in the Rookery," where he will be glad to receive all his friends.

Mr. Cutter also finds time amid all these cares to take active part in the meetings of the Electric Light Association, the Chicago Electric Club, and the American Institute of Electrical Engineers, and to write valuable articles for the various electrical papers.

STROMBERG, ALLEN & COMPANY,

railroad and commercial printers, have their retail office at 337-339 Dearborn street, where they will be glad to meet their friends during the summer. They make a specialty of engraving and printing for street railways,



C. J. STROMBERG AND J. ALLEN.

including tickets, ticket cases, conductors' punches, and general light railroad supplies. In the time that they have been in business they have built up an enviable reputation for themselves and, in fact, the name of Stromberg, Allen & Company is known the railway world over.

CHAS. A. SCHIEREN & CO.,

with an office and store room at 46 South Canal street, sell belts, as all of our readers know. The home office, at 47 Ferry street, New York, does the making and sells the eastern trade, while the western branch, under charge of Ernest Burrell, takes care of the west in general. The western branch was put in operation in May, 1888. At this time the Schieren belts were not in as extensive use as at present, but had their portion of the trade. In one year, however, the sales were tripled, and in 1892 six times more Schieren belting was in the use of western power makers.

Rearing up by the door of this well-belted establishment the visitor may see a 72-inch perforated and the smiling countenance of a long-horned steer, which latter has probably given his cutaneous integument to provide the former. Visitors are always welcome here to inspect the stock or talk belts and business.

In Chicago, Schieren belts may be seen at the South Chicago City Railway power house, where three 26-inch doubles drive the dynamos; at Maxwell's big box factory is 100 feet of 46-inch, and W. W. Kimball makes pianos with a 42-inch Schieren.



ERNEST BURRELL.

At the Fair grounds power plant a 72-inch double belt, 113 feet long and weighing 2,500 pounds, will be driven from a McIntosh-Seymour engine to a 1,000-horsepower Westinghouse generator. Another big belt elsewhere described will also be a feature. A display of belting stock at the Machinery Hall, and a Grecian temple in the Electricity building, will complete the display. The latter will be roofed with link belting. Men will be in attendance at all displays to do the Schieren honors to visitors.

N. W. HARRIS COMPANY, BANKERS,

are located at 163 and 165 Dearborn street, Chicago, at 15 Wall street, New York, and 70 State street, Boston. This house has for years been one of the heaviest buyers of municipal bonds in the country, and during the past five years has handled in large amounts strong issues of bonds on corporations operating under municipal franchises. This firm does not do a brokerage business, but confines itself to the purchase outright of total issues with its own funds. Messrs. Harris Company have lately

made a specialty of handling well secured street railway bonds, and are peculiarly well organized for the conducting of such business. The firm employes, besides a consulting engineer of high repute, a practical street railway man, who was formerly manager of one of the largest street railway systems in the United States; their facilities for the prompt and intelligent investigation of street railway securities are therefore the best. Although no exhibit of their business can be made, they will be pleased to receive business calls at their fine offices and explain their methods.



HARRY BISHOP.

THE MASSACHUSETTS CHEMICAL COMPANY.

of Boston, one of the new and pushing firms in the electrical field, is represented in Chicago by Harry Bishop, whose appointment as general western agent dates from January 1st of the present year.

Mr. Bishop is ably carrying out the policy of this enterprising concern, and the fame of their insulating compound is fast spreading throughout the west. It is being adopted by nearly all of the electric street railways, light and power stations and the electrical fraternity generally.

Though this company has had its plant in full operation only since July, 1892, it has been obliged to increase its capacity four times, and the rapidity with which its trade is increasing will necessitate the erection of a much more extensive plant in the near future, plans for which are at the present time under discussion.

The Chicago office is still young, but Mr. Bishop will be pleased to receive all visitors and apply insullac where necessary.

Their New York branch is under the management of Col. J. Frank Dillont, formerly business manager of the Electrical World. They also have branches in Portland, Cincinnati and Philadelphia, all of which branches spread the fame of insullac.

Mr. Bishop, personally, is a pleasant man to meet, and will cheerfully explain all the many uses of this excellent specialty.



P. H. CAREY.

NUTTALL RAILWAY SUPPLY COMPANY—HARRISON & CAREY

are two hustling young men, who may be found at any and all times at 801 and 802 Monadnock building. Their company was organized in October, 1892, and made the general western selling agency for R. D. Nuttall Company, of Allegheny, Pa.

The resident members of the company are E. H. Harrison, treasurer, and P. H. Carey, vice president. Mr. Harrison was, at one time, auditor of the Edison General Electric Company, of Chicago, and more recently secretary and treasurer of the H. Ward Leonard Company, of New York. Mr. Carey's experience in electric railway matters was gained in the earlier days, with the Edison Sprague interests in the west, and later in construction engineering with J. G. White & Company, of New York.

Originally intended as the western agency for the R. D. Nuttall Company, of Allegheny, the business of the new company has rapidly expanded, and among its numerous attractive specialties may be found almost every repair part, appliance or device required by an electric street railway.

The motor repair parts, such as commutators, bearings, gears, pinions and armatures, manufactured by the R. D. Nuttall Company, and the Nuttall trolley, have won an enviable reputation and are too well known to require more than passing mention.



E. H. HARRISON.

These gentlemen have recently been appointed sole western agents for the McCallen solid sheet mica overhead insulators, also the Mark Railway Equipment Company, Cleveland. Their attractive new catalogue has just been issued and they anticipate an immense demand for these most excellent appliances.

This company is always on the qui vive for improvements and specialties, and inventors will do well to correspond with them. The young men fully appreciate a good advertising medium as will be seen on the back cover of this number of the REVIEW.

These gentlemen will be pleased to see all old and new friends at any time during the Columbian or any other year, and will tell them about goods and prices, or will talk religion, politics, or horses with equal facility and intelligence.

Messrs. Harrison & Carey's many friends in all parts of the country will be pleased to know of the success attending this young firm, which is making its way into the fast growing field of electric traction.

WM. H. SMITH & COMPANY

at 63 South Canal street, are the agents for the Abendroth & Root boilers, of 28 Cliff street, New York. The firm handles all the large western business of the Abendroth & Root people, but can sell wherever the opportunity offers. A flourishing business has been done in this vicinity and the World's Fair visitors may see a fine specimen of the Root boiler at the big power plant in Machinery Hall annex. Smith & Company also are handlers of the spiral riveted piping made by Abendroth & Root, and will make a fine display of this specialty also.

Mr. Smith personally has a thorough knowledge of practical work and is a pleasant man to meet withal. He is the inventor of the Ajax feed water purifier, which he will soon put on the market. Lack of time and facilities have delayed the extensive manufacture of the Ajax, but a number are in very satisfactory operation and with the aggressive pushing of the enterprise the Ajax will take its proper place in the world. Mr. Smith has been with Abendroth & Root since 1885 and in Chicago since 1886, and enjoys a large and pleasant acquaintance among power users.

C. & G. COOPER & COMPANY

of Mt. Vernon, Ohio, have as their Chicago agent J. M. Hayes. In the two years of his agency for this company fortune has smiled upon him in the way of a very successful business, the results showing the number of engines in operation in Chicago and vicinity well up toward one hundred.

Rockford, Illinois, alone, has installed seventeen in the two years. These are figures rarely equaled. The greatest difficulty has been to build engines fast enough to supply the demand, but with enlarged capacity they hope to do better in the future. Mr. Hayes has his office at 237 La Salle street, where he will talk Cooper engines at 750 p. m.



WM. H. SMITH



J. M. HAYES.

THE M. C. BULLOCK MANUFACTURING COMPANY

has branch offices and agencies in all parts of the world, but the parent industry occupies the immense brick building at 1170 Lake street, Chicago.

Here from 150 to 200 machinists, and an army of draughtsmen, pattern makers, foundry men, boiler makers, and other helpers, plan, make, and put together the products of their skill.

The main offices of the company are here and M. C. Bullock, the president of the company, here receives his business visitors. The other officers of the company are: George Woodland, treasurer; J. S. Lane, general superintendent; N. B. Place, superintendent. By the recent death of O. H. Blanke, secretary, this office is yet vacant.

In addition to a large list of noted mining machinery, the company manufactures for electric and manufacturing purposes the Bullock-Corliss engine, Sweet's straight line engine, Willans & Robinson's central valve engine, and the Brotherhood three cylinder high speed engines. The latter is applicable for cramped space where large power is necessary. The Willans engine is a famous English machine and for direct coupling to dynamos is largely used both in Great Britain and on the continent. The Brotherhood engine is largely used on European war ships and on the merchant marine.



M. C. BULLOCK.

In Chicago and vicinity the Pullman Palace Car Company, the City of Chicago, the Cicero Gas Water & Electric Light plant, Griffin Car Wheel & Foundry Company, the Produce Cold Storage Company, and many others use the Bullock-Corliss, while numbers of others tie to the tandem compound and cross compound condensers. Our readers will remember the illustration of the Racine plant in the February issue of the STREET RAILWAY REVIEW, in which the Bullock-Corliss is more extensively noted.

The World's Fair exhibit will be a Willans central valve high speed, a Brotherhood engine and mining machinery.

Personally the firm is a strong one. Mr. Bullock has an intimate practical knowledge of the business.

THE PHOENIX IRON WORKS,

of which D. W. Davis is western manager, has a branch office at 418 Chamber of Commerce building. Mr. Davis had an extensive theoretical and practical experience in the engine and machinery line before locating here, and was connected with a prominent engine concern in the

east for a number of years, and passed through all departments, being very successful in all, which eminently qualifies him for the position he holds. He is a member of the American Society of Mechanical Engineers, and has an extensive acquaintance. Mr. Davis has exclusive control for the sale of the Dick & Church engines, boilers, heaters, etc., for the states Illinois, Indiana, Michigan, Wisconsin, Iowa and Missouri. The works of this company are located at Meadville, Pa., having ample facilities for turning out a large product in high class automatic engines, boilers and heaters. The former including single cylinder, compound and triple expansion, especially designed for driving electric machinery, street car generators, and manufacturing purposes generally. This company has installed within a recent date quite a number of plants in Chicago, among which we would mention: Wolf's Clothing House, Halsted and Madison streets; Hannah & Hogg, 83 East Madison street; Gault House; Tobey Furniture Company; General Electric Company, and The Fair. The last named plant being composed of three 200-horse-power compound non-condensing engines.



D. W. DAVIS.

This company will have a very attractive exhibit of high speed engines at the World's Fair, consisting of one 250-horse-power single cylinder, one 250-horse-power compound condensing and one 500-horse-power triple expansion condensing.

This company has just issued a neat catalogue, nicely illustrated, and giving sizes of all classes of engines, which they will be glad to mail to anyone interested in steam engineering.

THE ANSONIA ELECTRIC COMPANY

began business ten years ago in a little office on the second floor of 175 Lake street. The expansion of the business is very aptly typified in the habitation of to-day, as compared with that of a decade past, and in lieu of a portrait of any of the officers of the company we present the building as it now stands on the corner of Randolph street and Michigan avenue. Here may be found Manager F. S. Terry with his army of assistants, and also an immense store of supplies of which electric railway material is no small part. Among the articles which the Ansonia Electric Company manufacture themselves, perhaps Shield brand moisture proof line wire is the most prominent. The Wirt volt and ampere indicators, Wirt electricity meter and Wirt's dynamo brush are others of the leading specialties and to these we can add a line of street railway devices, the design and invention of M. M. Wood. For Habirshaw pure rubber covered wire, Stan-

ley transformers, Crocker-Wheeler motors, and the Helios arc lamp for alternating currents they are the general western agents, as also for Albert & J. M. Anderson's specialties. Until quite recently the business has been conducted



ANSONIA ELECTRIC COMPANY'S BUILDING.

under the trade name of the Electrical Supply Company, but for various reasons that have already been made public, it was considered wise to change the name to the Ansonia Electric Company. Under this name it will be known in the future. It has been the aim of this company to manufacture or become in any way identified with only the highest grades of electrical merchandise. This well known policy has attracted to them many of the leading articles in daily demand by the electrical trade and central stations.

THE BUCKEYE ENGINE COMPANY

of Salem, Ohio, is represented in Chicago by N. W. Robinson, at Room 60, 97 Washington street. As is well known, this company was one of the earliest in the field of high speed automatic cut-off engine building, and they have steadily increased the number of designs turned out, until their present catalogue shows no less than seven different styles of compound engines, to say nothing of the simple engines which have already made for themselves an honorable reputation. In electric light work they are very extensively and favorably known, and electric railway circles are daily becoming more familiar with them. At the World's Fair there will be six in operation



N. W. ROBINSON.

in different parts of machinery hall. This display consists of five engines of from 100 to 275-horse power of various types and a 1,000-horse-power girder bed, cross, triple expansion. The latter will attract much attention.

THE STANWOOD MANUFACTURING COMPANY

has enjoyed phenomenal prosperity, but no more than has been deserved both from the merit of the step they manufacture and the care taken to please buyers. Mr. Stanwood, the inventor, has made a most thorough and pains-taking study of the various needs of street railways in the matter of proper car steps, and has by frequent improvements brought the Stanwood step to that degree of perfection where further improvement seems impossible. He will have his step on a large number of cars



L. M. TRACY.

on the city lines, and within the grounds, and have a fine display at the factory at Clark and Seventeenth streets, where the general office is also. F. A. Stanwood, president; W. T. Smith, vice-president, and secretary and treasurer, L. M. Tracy, are the officers. The company was organized in 1889, and is now turning out 100 steps daily. This step is in use on nearly 500 street railways.

THE GOUBERT FEED WATER HEATER

has as its western agent William W. Nugent, who can be found at his office 823 Home Insurance Building. Mr. Nugent is a practical mechanical engineer and is therefore specially fitted to sell and install the Goubert heaters. Although the Chicago agency only dates back as far as January 1, 1891, this heater has been adopted in a number of places in Chicago and immediate vicinity, which is the territory covered by the agency of Mr. Nugent.



W. W. NUGENT.

THE GRIFFIN WHEEL & FOUNDRY COMPANY

have one of the most interesting plants in the country, and their wheels are known throughout the land. Their general offices are in the Phoenix building, where President Griffin and Secretary Wellington will be glad to welcome visitors.

THE RICE MACHINERY COMPANY

offices at 168 South Clinton street, are presided over by Manager M. W. Mix, who is also treasurer of the company. The Rice offices have been established in Chicago four years. For some time the Rice Company has had control of the sales of the Dodge Manufacturing Company, of Mishawaka, Ind., whose transmission specialties are so well known to all the street railways



RICE MACHINE COMPANY'S FACTORY.

men of the country. The Rice Machinery Company, moreover, makes a specialty of contracting for steam plants complete with special referenece to electric light and power stations. Among their plants in Chicago and vicinity may be mentioned the Grant Locomotive Works, the Times building, and the Oshkosh, Wis., Light & Power Company's plant, which is one of the finest equipped in the country; using the Dodge split friction clutch, wood rim, iron center pulleys and, in fact, a complete line of the Dodge specialties.

The Rice Company's display at the World's Fair includes the entire shafting and equipment for Machinery Hall, Machinery Annex, and the Agricultural Building, making in all about 12,000 feet of shafting, varying from three inches to 6½ inches in diameter. This shafting has all the improvements of the Dodge appliances and will make an elegant display. A line shaft for the Bass engines is included in the display. Mr. Mix has every reason to be proud of the work done by his company and visitors will be heartily received at the offices on the grounds.

THE INDIANAPOLIS FROG & SWITCH COMPANY

resides in Indianapolis, but J. W. Clark, 468 Rookery, Chicago, attends the city and nearby trade. The company has a fine exhibit of its best and latest construction on the Wabash line of the Chicago City Railway Company and on several steam lines.

The parent concern employs 200 men in their big shops at Indianapolis. The building floor space occupied measures 800 by 60 feet, together with ample yard facilities, and railroad tracks, frogs, crossings, switches, and all sorts of special street railway work receives prompt attention, the best of workmanship and quick delivery.



J. W. CLARK.

THE SHULTZ BELTING COMPANY

belts the world with a large export and domestic trade. A. Binz, secretary of the Curtis Manufacturing Company, 60 to 66 West Monroe street, however, belts Chicago. The Shultz goods are well known through the West as well as the East, and their export trade is increasing constantly. "We do a large business in the sawmill trade," said Mr. Binz, "as well as in the street railway and electric light field. Mr. Ferguson has just captured an order for two 30-inch belts for the Southern Electric Railway Company, at St. Louis. One other nice order comes from Denver for four 60-inch belts. A good stock is kept at the Curtis Company's store, and visitors are always welcome.

WESTERN BANK NOTE COMPANY.

This is an institution of which Chicago and the west ought to be proud. It was organized in 1864, J. Young Scammon being the first president. The other incorporators were men prominent in Chicago at that time. The only man on the first board of directors still connected with the company being Clarence C. Cheney, now the president. The company has had to fight alone the competition of the old established eastern houses on one hand and its western contemporaries doing lower grade work on the other, but it has come out victorious in the end, and its work is now acknowledged as equal to that of any concern in the world, while it is the only company in the west doing the highest class of steel engraving. They occupy their own splendid 10-story office building at the corner of Madison street and Michigan avenue. Here all their work is done and the engravers' rooms are supplied with all modern safeguards to prevent the duplicating of bonds and notes. They make a specialty of fine engraving for the use of railways. The officers are C. C. Cheney, president; C. A. Chapman, vice-president; C. Heineman, secretary; W. L. Gould, treasurer.

C. E. LOSS & CO.,

general contractors, of 621 Pullman building, began work about four years ago. Since that time they have made a specialty of the construction of electric railways. That they have done this work well, the construction of the roads at Adrian, Michigan; Kankakee, Illinois; Hammond, Indiana; and other places will testify. Mr. Loss was the builder and originator of what is now known as the Hammond Electric road of this city, but first known as the South End. The firm has a number of electric roads now under construction.



C. E. LOSS.

THE CUSHION CAR WHEEL COMPANY

although before the public for only two years have made a splendid success in their wheel service on both steam and street railways.



P. F. LEACH.

This company has extensive works at Ft. Wayne, but the Chicago office is headquarters for a large territory. P. F. Leach, the vice-president, occupies Club room No. 9 on the first floor of the Grand Pacific hotel, and here one is almost sure to meet visiting railway men when in the city. Mr. Leach will be glad to receive his street railway friends when in attendance on the Fair, as indeed, at any and all times.

Their exhibit of new and old wheels, both steam and street car, in K. North, Pillar 1, Transportation building, will be interesting.

THE STIRLING COMPANY.

of Chicago, was organized August 25, 1889, having purchased the patents and business of the International Boiler Company, Limited, of New York. In the short time since then the Stirling water tube boiler has become as familiar as if its reputation was many years older, and not a little of its increasing use is due to the extensive patronage of many of the largest street railway plants. The factories of the company are at Barberton, Ohio, a suburb of Akron, named in honor of O. C. Barber, the president of the company. The factories have a capacity of 400-horse-power of boilers per day, and are equipped with the most improved hydraulic and pneumatic machinery.



S. K. GREGG.

The railway facilities of the place are also first class. The other officers of the company are J. K. Robinson, vice-president, Thomas Deegan, secretary, and C. W. Crankshaw, treasurer, with S. K. Gregg as general western agent, with offices at 612 Pullman building. Their exhibit will be found with the other boilers in connection with the power plant at the Fair, previously mentioned in the STREET RAILWAY REVIEW.

THE Q. & C. COMPANY

has offices in the Phoenix building, where the virtues of the Bryant rail saw are cheerfully explained to all enquirers. A little over a year ago the Bryant saw was put on the market, but to-day few street railway lines are unacquainted with the virtues of their valuable appliances. The sale has been phenomenal.

BABCOCK & WILCOX.

There are few steam users in the city who cannot remember the time when water tube boilers were looked upon as the phantoms of an inventor's brain, rather than an every-day necessity of commerce and trade.

Thirteen years ago, however, when G. E. Palmer, against the advice of his friends, took the agency of the Babcock & Wilcox water tube boilers, these facts were very evident. Then Babcock & Wilcox had but 200,000 horse-power in operation, while now 2,000,000 horse-power is said to be generated by this pioneer boiler. "Yes," said Mr. Palmer, "thirteen years ago it was like pulling teeth to get steam users to believe in water tube boilers. I have worked as long as two years with one man before convincing him that the water tube was superior to the old shell. Now our yearly output is greater than the then entire horse-power. My best

friends told me that the water tube boilers would wreck my reputation as an engineer, but it has survived, I guess," and here Mr. Palmer tore open a telegram from the Cincinnati Consolidated, closing a contract for 1,800 horse-power, a fifth order from the same company.

Mr. Palmer's territory extends west from central Ohio, south, including Kentucky and Tennessee, all the west



G. E. PALMER.

and northwest to the mountains, with agencies at St. Louis, Cincinnati, Kansas City and Denver.

"In Chicago and vicinity there is a total of 50,000 horse-power in operation," continued Mr. Palmer. "among the largest of which are the Chicago Sugar Refinery 5,000; Washburn-Moen, 5,000; Baker Brothers and the Western Electric Company. At the World's Fair two plants in the main power house and one in the Intramural power house may be seen. They were both illustrated in your magazine. All of them will be oil heated, but arranged for coal supply on fifteen minute's notice. Our office will be glad to receive visitors at 45 South Jefferson street."

HALE & KILBURN.

the extensive car seat manufacturers of Philadelphia, have an immense western trade with offices in the

Phoenix building in charge of Mr. Canman, who will be pleased to receive visits from all visiting railway men. His offices contain a large assortment of sample seats of all kinds where the tired sight-seer may select a choice resting place for his weary limbs.

TAYLOR, GOODHUE & AMES.

Taylor, Goodhue & Ames, although the youngest of Chicago's electrical supply houses, have made an enviable reputation for them-

selves among electrical people throughout the country. Their house started on the first of October, 1892, in office 827 Monadnock block Chicago, and at once commenced a vigorous campaign in all parts of the United States. Their efforts have been recognized in the most gratifying manner, and it is due to this fact and that their present quarters are not suitable for the proper transaction

of their business that they have found it necessary to move into more commodious quarters. On May 1st, Taylor, Goodhue & Ames will move into their new store at No. 348 Dearborn street, between Van Buren and Harrison streets, Chicago. Besides being on the ground floor and directly accessible, they will here possess a sufficient space for the transaction of their business for some little time to come. They will also make a handsome exhibit in the Electricity building, and will practically conduct two offices—one at their

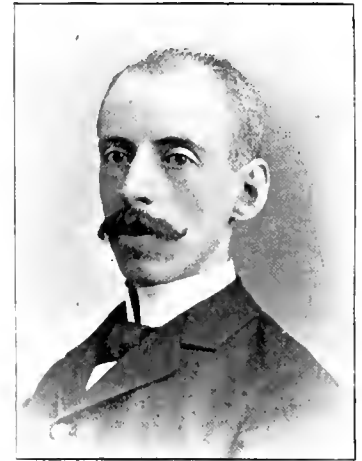

WM. TAYLOR.

exhibit at the Fair grounds and one in their down town store, so that every facility will be afforded the visiting electrician for making his stay in Chicago a pleasant and profitable one, and also affording the members of this vigorous company an opportunity of personally making the acquaintance of their out of town correspondents. The personnel of the company has suffered but little change since its organization.



WELLS GOODHUE.

William Taylor, president, and Wells Goodhue, vice-president, still occupy their positions as at the time of their organization. H. D. Ames, formerly secretary, resigned his position early in February to accept a responsible and lucrative position with another supply

house in the city. His official position as secretary has been taken by A. W. Dee, who has been for the past five years connected directly with electrical interests in Chicago. They are sole selling agents for the Burton Electric Company, Richmond, Va., and have very extended territory for the Wagner Electric Manufacturing Company's products, and the western agency for the Campbell Electrical Supply Company, of Boston. After occupying their new quarters, this enterprising house will make an active bid for all lines of electrical material.

THE CHICAGO STREET CAR AIR BRAKE COMPANY.

Although a veritable infant among the Chicago industries having started January 15, 1893, this concern has good reason to feel that it will not long remain so. It is a company that has started in response to the demand of electric roads for a quicker and stronger brake than is on the old style cars, and as the Christianson air brake seems to answer this demand the company has every reason to expect a bright future. It has been tried on cars at Detroit, Jamestown, N. Y. and Racine, Wis., and a Mil-

waukee line has ordered a number. The factory is at 44 South Jefferson street and the offices at 804 and 806 the Rookery. J. A. Kruse is president, Edward Atfield, secretary and treasurer, L. J. Genett, superintendent of shops and N. A. Christianson, consulting engineer.

to its present proportions at Schnectady and Lynn, with ramifications in all great centers, and agents everywhere. The two streams, whose confluence makes the General Electric, had their western sources in Chicago, beginning with the establishment of the Edison branch in 1881, and the founding of the Thomson-Houston Chicago house in 1883. The consolidation of 1892 united these forces and installed the combination in its present quarters at 173 Adams street.

An idea of the enormous business done in the west by the General Electric may be gathered from a few facts related to a STREET RAILWAY REVIEW representative lately. "The letter mail for one day," said the mailing clerk, "runs as high as 1,000 pieces, with an average outgoing mail of the same magnitude." Two direct telegraph wires, one Postal and one Western Union, are assisted by direct communication to Boston and New York, via the recently finished long distance telephone. Telephone service in the building and to the warehouses and works is maintained from a central station using thirty lines. Besides these facilities, a central station



B. E. SUNNY.



THEO. P. BAILEY.



GEO. K. WHEELER.

have one of the largest establishments in the city in their line, and their western business is managed by Geo. C. Bailey, who has conducted it so successfully for many years. Their building is No. 171-173 Lake street, where an immense stock of every kind of wire and cables may be seen.

JOHN A. ROEBLING'S SONS COMPANY

One of the largest of the industries connected with our trade is the

GENERAL ELECTRIC COMPANY,

whose western department is managed from Chicago.

It is an interesting study to read the romance of this great concern, from its small beginning at Lynn, Mass.,

manages a system of speaking tubes for inter office communication.

The General Electric list of employes aggregates 12,000, exclusive of construction men in service of experts. This means probably no less than 25,000 persons dependent upon the General Electric "ghost-walk." The western office carries a force of 243 employes, exclusive of construction labor.

THE RAILWAY DEPARTMENT

was founded in 1888, when it was a serious question whether electric railways would be successful in paying dividends. Theo. P. Bailey, of the lighting department, was put in charge of the department, where he remains to-day. The department has literally grown from nothing to its present proportions within the last five years. The territory controlled by this department comprehends the great and growing commonwealths of Nebraska, Iowa, Wisconsin, Michigan, Illinois, Kansas, Mississippi, Indi-

ana, Oklahoma, Texas and Louisiana. Mr. Bailey has charge of this department.

Geo. K. Wheeler is another important functionary of this department. He is an electrical engineer of many years standing, although still a young man. Under his direction are six electrical engineers.

There have been sold from this office an aggregate of 55,076 horse-power in motors and 67,714 horse-power in generators. This tremendous growth gives a faint idea of the advance of electrical industry in the west. This calls for over 2,000 motor cars and 2,100 miles of track.

The World's Fair exhibit is elsewhere noted, but will include the beautiful and unique intramural road previously illustrated.

Under Mr. Sunny's magnificent management, and under Mr. Bailey's careful supervision, the splendid electrical engineering record of the western branch of the General Electric has become a worthy monument of modern commerce and young men's enterprise.

THE HAMILTON-CORLISS ENGINE

manufactured by Hooven, Owens & Rentschler, Hamilton, O., is represented by J. J. Sullivan, whose lair is at 45 South Canal Street. Mr. Sullivan is envoy extraordinary and minister plenipotentiary of the H., O. & R. Company, and sells engines over all the western territory. He is a practical man and can build an engine as well as sell one. He was a marine engineer in the United States navy for many years during and after the war. Mr. Sullivan is as well known as the engine he represents, having had his headquarters in Chicago for seven years and travelling extensively through all the adjacent territory.

Twenty Hamilton-Corliss engines may be seen on duty at Swift & Company's big establishment. It is used also at the Purington & Kimball brick works and at various other large power plants in Chicago.

THE DETROIT ELECTRICAL WORKS

has a history more brilliant than long. In fact, it was not until December, 1891, that Louis E. Meyers was made a special agent and adopted Chicago as headquarters and the Rookery as his place of abode. The new office has, however, a most successful venture and the sales keeping pace with demand for Detroit goods, larger quarters soon became imperative, and the Monadnock building was chosen for its next resting place. This was in April, 1892, and Mr. Meyers was made district manager in recognition of his successful career. The Detroit offices now number 917-918-912-913, with a competent corps of assistants, electricians and accountants. The district controlled by this branch comprehends the growing country bounded on the East by Pittsburg, on the South by Cincinnati, on the west by Salt Lake City, and on the north by Canada.

In this section, in the short time above noted, there have been installed large plants at Sioux City, Salina, Kas.; Dubuque, Iowa; Racine, Fort Howard and Green Bay, Wis.; Omaha, Nebraska, and at Cairo, Kankakee, Chicago

and other points in Illinois. The Calumet road in Chicago is perhaps the most important of these and will make a part of the Detroit company's visit at the World's Fair.

This road is equipped throughout by the Detroit people and contains some interesting points.

At the World's Fair grounds the exhibit will consist of generators in Machinery Hall, generators and motors both stationary and street railway in the electrical building. A general line of electrical work will be included, and competent men will be on hand to do the honors. Besides this the



L. E. MYERS.

down-town office will make it pleasant for all the friends of the Detroit.

The home office of the company is, of course, at Detroit, and the officers are: President, Hon. Hugh McMillan; vice-president, Louis Warfield; secretary, J. E. Lockwood; assistant secretary, W. H. Van Husen; treasurer, Thos. Muir.

RAILWAY EQUIPMENT COMPANY.

The continued prosperity of the above company naturally makes its earlier history very interesting to its patrons. Some three years ago W. R. Mason and a few others purchased the merchandise business of the Sprague Electric Equipment Company, and organized the Electrical Equipment Company, with offices at 11 Adams street, Chicago. Owing to the practical experience of those interested, their acquaintance with the trade, and to their judicious decision to deal in "electric railway supplies only," and to judicious advertising this company, within a few months took a very prominent position among the representative supply houses in the country. After being in business some two years the name of the company was changed to the Railway Equipment Company and commodious offices and store rooms were engaged in the Pullman building, one of the best locations in the city. During the time that the company has been in business it has furnished equipments for a majority of the



J. A. CORBY.

electric roads in this country, and it speaks well for the management that the earliest customers of the house without exception continue to do the bulk of their business with the new company. They carry a very large stock not only of equipment material, but also of all kinds of supplies needed for operating electric roads. It is so well known that every thing in this line can be had promptly, that a great many roads even in the extreme east find it satisfactory to deal with this live Chicago house. Orders are in most cases filled on the day received. It has always been the policy of the company to furnish, as far possible, the best class of material obtainable, giving the matter of cheapness a secondary place. At the same time prices are as low as consistent with the best material and workmanship. The type G overhead material brought out during the last season has had an unprecedented sale and is being called for throughout the eastern country. The company was the pioneer in introducing electric heaters and continue to occupy a prominent position in this growing industry. The house also represents W. W. Allen's safety car brake and the Chas. Scott Spring Company. The officers of the company are Joseph A. Corby, president; W. R. Mason, vice-president and general manager, and C. M. Barclay, secretary and treasurer.



W. R. MASON.

THE M'GUIRE MANUFACTURING COMPANY

came into prominence in steam railway circles about nine years ago as manufacturers of the celebrated "Star" grain door, that is said to have had the largest sale of any specialty that has been invented for very many years, being in use on nearly every road in America and Canada, and amounting to a total sale of about 600,000. About five years ago the company went into the manufacture of street railway trucks, and were, therefore, in at the birth of the electric railway business, and are now generally recognized as one of the largest manufacturers of street railway trucks in America, and the fact that their entire works run night and day goes to show that their product



W. A. M'GUIRE.

is appreciated. They give employment to 225 men, and their factory takes in nearly a complete block, and is situated a little over a mile from the center of the city and convenient to all shipping points. The officers of company are: W. A. McGuire, president and treasurer; W. J. Cooke, vice-president, and F. Byrne, secretary. The trucks are in use in every part of this country and Canada. Their pressed steel truck is well known, the particular advantages claimed for its use being flexibility, great strength, and fewness of parts. The sales agents of this company are among the most popular of America. At the head is W. J. Cooke, vice-president of the company, the Chesterfield of American salesmen; J. A. Hanna, the tireless traveler, for many years with the Brill Company; Moses G. Hubbard, the Apollo Belvidere, and the president, W. A. McGuire, also



W. J. COOKE.

sometimes takes part in this department. F. E. Ely represents the company in New York City in the grain door department. In 1888, this company did truck business to the amount of \$150,000; in 1892, the trade in this line was about \$500,000, and the sales for the first three months of 1893 surpasses in amount the trade of the first six months of 1892. In five years this company has built four additions to its original plant, and has now purchased the ground for an addition that will be equal to one-half of the present plant.

THE HEINE SAFETY TUBE BOILER COMPANY

opened a Chicago office eight years ago. At that time water tube boilers were at a decided discount and the Heine was at the same disadvantage as the rest. The business has increased from the beginning however, and this company has no cause of complaint on that score. The first Heine boiler installed in Chicago was in Mc Vicker's theatre building, the same building that is now the home of the agency, which is located in room 26, with J. H. Harris at the head. The territory covered by this agency includes



J. H. HARRIS.

Minnesota, South Dakota, Michigan, Wisconsin and parts of adjoining states.

THE BALL ENGINE COMPANY

have their branch office at 506 the Rookery, with C. C. Keen in charge. This branch office has been in existence about a year. Mr. Keen taking charge last August. The

last few months has shown a tremendous increase of business over all previous, the orders exceeding many times those received during any corresponding period formerly. Their exhibit at the Fair will consist of a 500-horse-power tandem compound engine, driving two Edison dynamos, supplying light for the electric fountain. It will be located near the east end of Machinery Hall. The large



C. C. KEEN.

installation of their engines at the Calumet station at Burnside will also doubtless attract much attention from visitors.

The Ball exhibit in Chicago is a large one, many factories throughout Cook county depending upon this company for the power to make all sorts of merchantable products.

Besides this, outside of Chicago's area hundreds of Ball's are making their daily and nightly rounds of duty as tireless as the energy of the manufacturers and salesmen who made and placed them.

E. B. PRESTON & CO.,

one of the oldest and best known manufacturing companies in Chicago, were established in 1869, and two years

later began manufacturing on their own responsibility. This was long before belting was thought of as an adjunct of street railway service, so that when mechanical traction began to be established as a definite thing, E. B. Preston & Co. were early in the field.

Mr. Preston's business sagacity and enterprise has built up a magnificent business, which occupies the block on Fifth avenue, numbered



C. E. JENKINS.

103 to 117 inclusive, of which 103 is the office and the remainder is devoted to manufacture and storage. The location among the great trunk line railway depots gives the company the best of shipping facilities.

Leather belting in all sizes and for all purposes is manufactured by the company, and when the STREET RAILWAY REVIEW representative went through the shipping room two 36-inch doubles, twelve 14-inch dynamo belts and a big 60-inch three-ply main, 150 feet long, stood there awaiting shipment.

Among a number of larger plants belted by E. B. Preston may be mentioned particularly Siemen & Halske factory, at the corner of Paulina street and Blue Island avenue.



E. B. PRESTON.

An exhibit at the World's Fair grounds and larger display at the factory will be open for all comers. At the factory the competent general manager, C. E. Jenkins, will do all in his power to make the visitor welcome. Mr. Jenkins has been with E. B. Preston & Co. six years, for the last two as the successful general manager, and well knows the needs of power users. In addition to the belting supplies, all kinds of rubber and cotton hose for fire protection is kept in stock.

THE WILLIAMS' ENGINE AND CLUTCH WORKS

has its chief contracting office and sales-agency at 63 South Canal street, where E. P. Rogers is ever ready to talk power and transmission. The office has been established 4½ years, and is the successor of the Eclipse Clutch Works of Beloit, Wis., to whose factory specialties and reputation the present firm is heir. Mr. Rogers has no definite territory, but goeth where he listeth, and his goings have been remarkably successful. The Williams' Engine and Clutch Works have on practical exhibition in Chicago, the entire equipment of the Chicago Light & Power Company, supplying the engines, clutches, shafting, and, in fact, the entire steam plant. It has also equip-

ped the Central Electric Company's plant, at 25 Plymouth Place, and the Dexter and Leiter buildings. The company is now building the Wheelock-Corliss engines



E. P. ROGERS

Wheeler is general manager, G. F. Wheeler, traveling representative.

THE PECKHAM MOTOR, TRUCK & WHEEL COMPANY

is at home at 213 Phoenix Building. Here P. S. Bemis makes things interesting for his customers and contemporaries. Mr. Bemis is said to be the best looking man in the trade, with the exception of Payson Andrews. Mr. Bemis is authority for this statement and he ought to know. No state boundaries confine Mr. Bemis' actions but he sells wherever he finds customers, and by the list lying on his desk this seems to be a successful method. The list includes 100 more trucks for the Atlantic avenue road, of Brooklyn, N. Y., making 350 now ordered; 4 for Columbus, Ohio; 6 for Rockford, Ill.; 4 for Indianapolis, Ind.; 4 for Peoria, Ill., and 6 for Joliet, Ill.

At the World's Fair, four Peckham trucks will be shown in the Transportation building, free of motors, with interchangeable wheels. Besides this the Calumet Electric Railway will have a running exhibit of Peckham trucks. All visitors will be welcomed at the office or at the grounds, where a desk and stenographer will be supplied gratis.

THE WASHBURN-MOEN COMPANY

has its western office at 107-109 Lake street, as well as a western factory at Waukegan, Ill. The western railway supplies, such as bond and trolley wire, is presided over by their Mr. Smith, whose geniality is well known to many of our readers. There is, besides the western department, the main eastern office and agencies and salesmen all over the world. The company will be pleased to talk wire at any time during, before, or after the World's Fair.

THE STANDARD PAINT COMPANY,

of 2 Liberty street, New York, is ably represented by P. H. Hover, at 543 Rookery. Mr. Hover energetically

and enthusiastically represents to the western trade the many virtues of the P. & B. compounds, comprising P. & B. preservative coatings, P. & B. armature varnish, P. & B. insulating paper and P. & B. insulating tape. These compounds are well known to the electrical world. A pamphlet containing letters of recommendation and praise from users and supply agents is furnished all applicants who wish to investigate the virtues of the various insulating compounds. The factories at Bound Brook, New Jersey, covering five acres, are kept busy all the year furnishing a supply of these special ties for a widely extended and rapidly widening trade. Mr. Hover will be glad to see his friends at his offices. At the World's Fair grounds a large quantity of the insulation is used. There it can be seen in actual and satisfactory use by many of the practical electrical displays there to be inspected.



P. H. HOVER.

THE STANDARD RAILWAY SUPPLY COMPANY

is nicely situated at 1117 Monadnock building. Here Garson Myers, president and general manager, is ready to explain the virtues of car heating by the Standard stove, and the particular advantage of "not cutting the car seat." The stove is a very handsome piece of furniture, and has been applied to many street railways with success.

The claims of neatness, adaptability and economy that are made, Mr. Myers is prepared to prove to all visitors. The Chicago City Railway and the North Chicago Railway Company have used the Standard during the past winter.

This house also represents the Pittsburg Steel Hollow Ware Company. Visitors at the World's Fair will be interested in seeing this stove in the Transportation building, and will take pleasure in meeting Mr. Myers at the offices of the company, where the virtues of Standard stoves and "no seat cutting," will be cheerfully explained to any desired length or shortness by the officers of this company.



GARSON MYERS.

THE MEAKER MANUFACTURING COMPANY.

of 134 W. Washington street, is one of the best known of our industries. It was in 1885 that the company began the making of registers, with factories at Waterbury, Conn., and offices in Chicago. Since that time the fame of the portable and stationary registers has spread to all parts of the country and even into foreign lands.

The assembling and testing of registers is done under Mr. Meaker's personal supervision at the Chicago office, and we present to our readers a view of the assembling room and of the packing room whence go registers to all people.

THE ILLINOIS STEEL COMPANY,

is the result of a rather complicated series of changes and consolidations. It traces its ancestry back, however, to Ward's Rolling Mill, established in North Chicago in 1857, by Captain E. B. Ward, well known as the owner of a line of steamers then running between here and the east. Later this mill, which was on the site of the present "North Works" of the company, became the North Chicago Rolling Mill Company, owning mills also at South Chicago and Milwaukee. The Illinois Steel Company was formed in 1889, by the consolidation of the North Chicago Rolling Mill Company, the Union Steel Com-

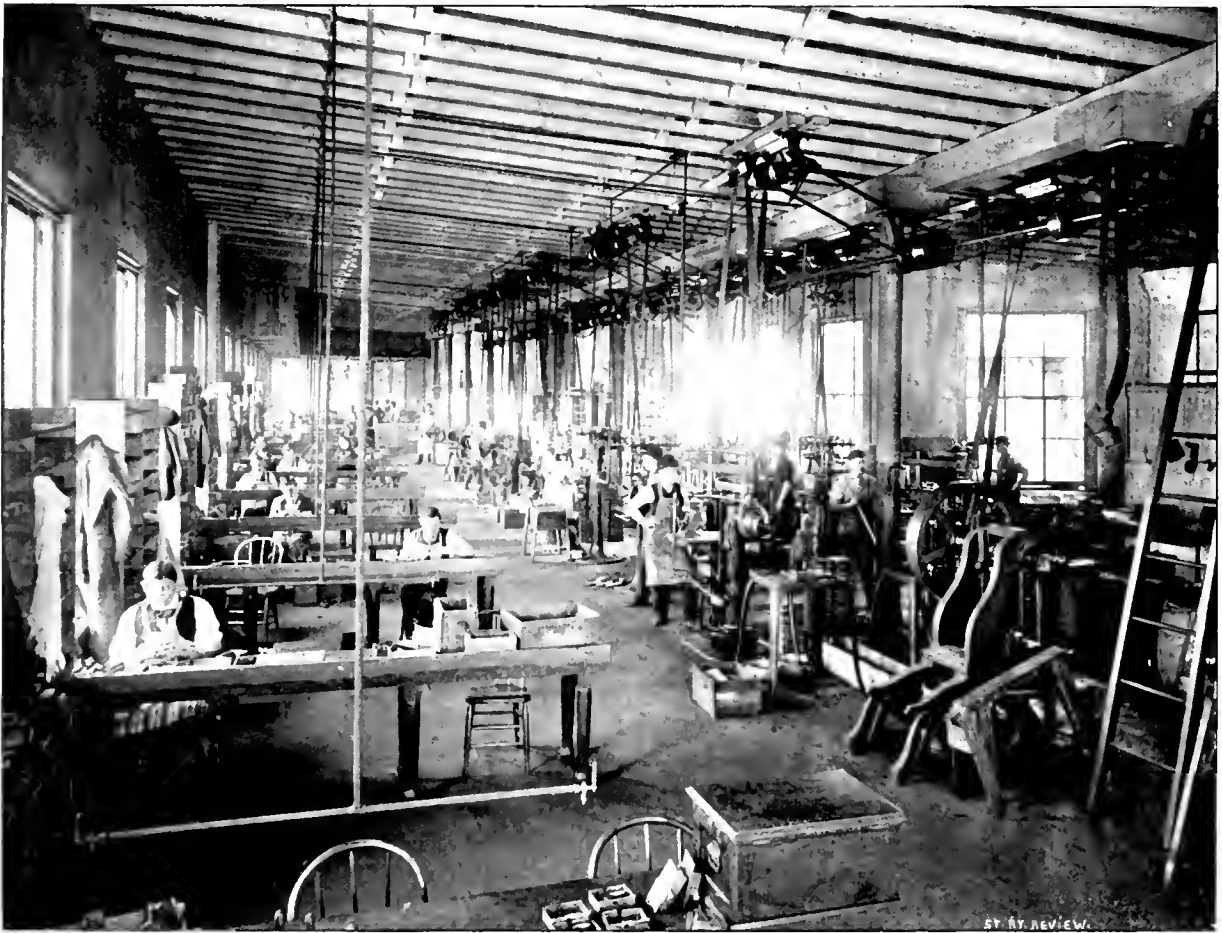

FACTORY SCENE IN THE WORKS OF THE MEAKER MANUFACTURING COMPANY, CHICAGO.

Associated with President Meaker in the office management are his two sons, possessing the same fine business capacity which characterizes the chief executive of the company. The other officers are: H. R. Bean, vice-president; E. L. Brewster, treasurer, and H. L. Norton, secretary. The offices and factory are opposite the general offices of the West Chicago Street Railroad, and visitors to that power house will find it very convenient to inspect the works of the Meaker Manufacturing Company, where a genuine surprise will be given railway men in viewing the interesting process by which registers are made and put together. The assembling of parts is carried on with the same military precision that is followed in a big watch factory.

pany, of Chicago, and the Joliet Steel Company. Besides this the company owns numerous coal fields and coke ovens in Pennsylvania. The authorized stock is \$50,000,000, of which \$19,000,000 is issued. The principal output of the various works is in the form of rails, but for the last few years they have turned their attention to other kinds of iron work. "The North Works" are situated on the north branch of the Chicago river—the site occupied by Captain Ward's Mills, which were burned in 1866. It now consists of two blast furnaces, a Bessemer plant, and two blooming mills. The "Milwaukee Works" also trace their origin to Captain Ward. They are located on the shore of Lake Michigan at Bay View, a suburb of Milwaukee. It was designed espec-

ally for receiving ore from the Northern Michigan region, but now turns out several kinds of finished iron and steel work. "The Joliet Works," which before its connection with the Illinois Steel Company was the outcome of a number of other consolidations, has the advantage of a cheap supply of coal to counteract its distance from the lake. Its product is principally Bessemer metal, in the shape of rails and rods. "The Union Works" are in southwest Chicago, on the south branch of the river. They were started in 1863, and have the honor of making the first Bessemer steel made in the west. The output consists entirely of steel rails and billets. The "South Works" are the youngest and also the largest of this numerous family, having been started in 1880 as an adjunct to the North Chicago Rolling Mills. They are at South Chicago, near to the Calumet river. With the completion of some extensions now being made this will be the largest plant of the kind in the country.

The general offices occupy the entire tenth floor of the Rookery, and have excellent telephone and telegraph connections with all the works. Julian L. Yale, the general sales agent, is a most genial and accomplished gentleman and a manager of unusually fine executive ability.

SOUTHWARK FOUNDRY AND MACHINE COMPANY.

The western office of this company is in the Rookery



CORNER IN SHIPPING ROOM MEAKER MFG. COMPANY, CHICAGO

where Frank W. Bunn will be found in charge. As is well known this company are the makers of the Porter-



G. L. REIMANN.



J. A. MOSHER.



J. A. SHERIFFS.

THE MOSHER ELECTRIC COMPANY

was organized under its present name, September 1, 1892. Previous to that time J. A. Mosher, from whom the company was named, had been in the arc lamp business on a small scale. At the time of the organization of the company a set of new lamps were announced, which were the result of a great deal of experiment and practical experience in the arc lamp line. The new Mosher lamps for railway circuits have met with great success and are giving excellent satisfaction wherever used. The factory and offices are at 125 Ontario street, where will be found a fully equipped plant for manufacturing and testing lamps. The officers are G. L. Reimann, president; J. A. Mosher, vice-president and electrician; J. A. Sheriffs, secretary and treasurer.

Allen automatic engines. Previous to the installation of this office January 1, 1892, they were little used throughout the west. Since an effort has been made to push them, however, they have had no difficulty in making their way on their merits. They have a large number in rolling mill work, which is very similar to that on street railways. The Lindell road, St. Louis, has ordered three 400-horse-power tandem compound non-condensing. The new Chicago Edison station, to be the finest and largest lighting plant of its kind in the country, will use the Porter-Allen direct connected triple expansion engines. The Illinois Steel Company has five very large engines of this make at its South Chicago works. The Southwark Company make a specialty of designing engines for different classes of work.

WESTINGHOUSE, CHURCH, KERR & COMPANY.

The western office of this firm is presided over by H. E. Longwell, and is located on the ground floor at the north-east corner of La Salle and Lake streets. As is



H. E. LONGWELL.

well known, they deal in Westinghouse engines and Roney mechanical stokers. For the manufacture of this latter article they have in this city the largest mechanical stoker plant in the world. It is located at the station of Cragin, on the Council Bluffs division of the Chicago, Milwaukee & St. Paul. Here on a plat of ten acres are located the five buildings, one 100 x 200 feet and two stories high, and the others 60x90 feet. The Roney stokers are at present supplying 30,000 horse-power of boilers in street railway work in the west. The most notable plant using the Westinghouse engines is that at Minneapolis, where the Twin City road uses 2,600 horse-power. Since the western office started, the yearly business has increased to about six times the output of the first year. The principal exhibit at the World's Fair will be six 1,000-horse-power Westinghouse engines, directly coupled to the ten 10,000 light alternators that are to furnish the greater part of the Exposition's light. Besides this there will be a number of smaller engines in the lighting plant.

THE WESTINGHOUSE ELECTRIC & MANUFACTURING COMPANY

needs no introduction to our readers. Their Chicago headquarters are on the ground floor of the Pullman building. The presiding genius of the railway department is B. F. Stewart, who previous to taking charge of this work, May 1, 1892, had twelve years of experience in electric work, including the early experiments of VanDepoele. The railway work of the Westinghouse Company is but little over two years old. In the short time that the Westinghouse apparatus has been on the market, over 5,000 single reduction motors have been put in use, over 200 roads being on the list. That this is an immense



B. F. STEWART.

showing goes without saying. The Westinghouse "iron clads" have made a reputation for themselves wherever they have gone, while the fact that it is made in



J. S. TEBBETS.

standard designs that are not continually being changed, allows the accumulation of a large stock from which orders from the western office can be filled, as Mr. Stewart expresses it, "with a quickness that will take your breath away." In the department of general railway supplies the company is also in the front rank. Visitors will experience no difficulty in finding the office, it being only one block from the

cable and Illinois Central lines of cars to the grounds.

Among the interesting installations of this office convenient for inspection by World's Fair visitors are the South Chicago City Railway, the Hammond Electric Railway, and the Chicago City Railway, whose electric power house is at Fifty-first street and Wabash avenue. Here four Westinghouse generators of 700-horse-power each are already installed, provision being made for ten in all, when the station output will be 7,000-horse-power. The manager of the Chicago office is J. S. Tebbets, who devotes special attention to the lighting department. Chas. S. Cook is electrical engineer, and has been with the Westinghouse Electric Company since the organization, having formerly been connected with the engineering department.



C. S. COOK.

THE GENNET AIR BRAKE COMPANY,

at 11 to 23 South Jefferson, is guided and controlled by M. L. Rothchild. The factory, at the time the STREET RAILWAY REVIEW man visited it, was crowded with work. New machinery is, however, being added and by June 1 the factory will have a capacity of 400 brakes a month.

W. R. MacDonald is superintendent of the company, and James H. Moore is the mechanical engineer. The New York office is at 150 Broadway, under the charge of Mr. Neuberger.

THE FALLS RIVET & MACHINE COMPANY

has placed Geo. B. Merrill in charge of its Western branch, situated at 8 South Canal street. The company has been represented in Chicago for eight years, but only two years ago put in a special stock and manager. Mr. Merrill is a very young looking man; in fact, a caller would not suppose him more than 22, yet this guess is six years less than his twenty-summers and winters.



G. B. MERRILL.

The home office and factory is at Cuyahoga Falls, O. while the Chicago branch takes care of the west and northwest, west of Indiana and Michigan. The visitor may see a fine example of the Falls Rivet work in the Masonic Temple, this city. Besides the various city plants the company will exhibit at Machinery Hall, World's Fair, a line shaft 30 feet long, six inches in diameter, arranged with a driving pulley, clutch pulley, cut-off coupling and ring oiling bearings for the support of shaft. Visitors will be welcome at the office, or at the Fair grounds, where a representative will be in attendance.

TERRE HAUTE CAR & MANUFACTURING COMPANY,

whose extensive works are located at Terre Haute, Ind., have long held a prominent position among the makers

of both steam and street car wheels, although the wheel trade is but one of the several departments of their business.

A Chicago office has been established within the past week, and will be in charge of D. B. Dean, who is well known to railway men throughout the country, having been connected with the Electric Merchandise Company, and more recently with the McGuire Manufacturing Company, which



D. B. DEAN.

position he resigned to accept his new connection.

A branch office is also maintained in St. Louis, under the management of Anson D. Hartwell, at 321 Commercial Building.

The company use the well known Barr contracting chill process in the manufacture of all their street car wheel work, and the metal is carefully selected with special view to long life under the exacting conditions of electric motor work. The officers of the company are all efficient men.

THE STREET RAILWAY REVIEW

deserves a front seat among the forces which have been already named in promoting street railway interests. Its first number bears the date of January, 1891, and, with the present issue, is now 28 months old. What it lacks in age is more than compensated for by the energy and progressive spirit which has always characterized it. Its success has been phenomenal in the annals of technical journalism, and today it is acknowledged as the leading street railway publication. The REVIEW occupies commodious quarters in rooms 502



HENRY H. WINDSOR,
Editor.

to 508, inclusive, at No. 269 Dearborn street, a location convenient to the post office, all down town hotels, and depots. It is headquarters for visiting railway men, and

World's Fair visitors will be welcomed and tendered the hospitalities of the office. A register will be kept of the presence and address of railway visitors during the Fair, and our friends are invited to have their mail and telegrams addressed in care of the REVIEW. In addition to a reception room, competent stenographers will be ready at all times for letter writing "while you wait." Remember the number 269 Dear-



FRED. S. KENFIELD,
Business Manager.

born, opposite the great Monadnock.

For nearly a year the REVIEW has issued a daily edition, containing important advance news of enterprises, destructive accidents, extensions, consolidations, changes in management, and, in short, a complete daily record of the street railway happenings of the country. This daily edition will, during the fair, also contain a full roster of visiting street railway officers in the city, and their stopping places.

The REVIEW will take a personal interest in its visitors and will be pleased to render all possible service in the way of personal introductions, and such similar service as our long residence here and wide acquaintance makes possible and eminently fitting.

THE PIER MOVABLE SIDEWALK.

At the World's Fair—A Practical Demonstration of this Most Remarkable Transportation Exhibit—A System Wonderful in its Simplicity and Capacity.

READERS of the STREET RAILWAY REVIEW will remember the December, 1891, issue as containing, among other good things, a description of a novel transportation scheme called the Columbian moveable sidewalk.

For the benefit of those who did not read the REVIEW in 1891, it may be explained that the moveable sidewalk is the result of many years study and the invention of Max E. Schmidt and J. L. Silsbee, both of Chicago.

This system has its foundation principle in the simple fact that the top of a moving wheel moves with exactly twice the speed of the axle. Hence two rails carried on the periphery of the wheel move with twice the speed of the axle. By reference to the engraving it will be seen that the moveable sidewalk consists of two parallel platforms. One is carried on the axle of the truck while the other is driven forward by a rail resting upon the periphery of the wheel. When the right hand platform moves at six miles an hour, being carried by the rail marked *a*, the left hand platform moves at the speed of the truck, or at

Here east of the surpassingly beautiful Peristyle and lively Casino, and surrounded on three sides by the glit-

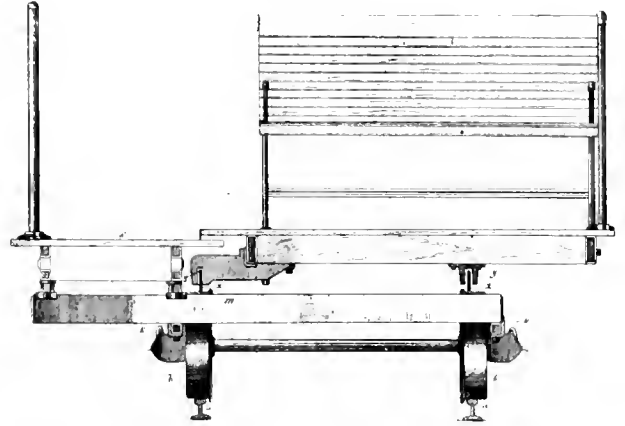

SECTION OF SIDEWALK SHOWING FLEXIBLE RAIL.

tering expanse of Lake Michigan, the new line is under construction.

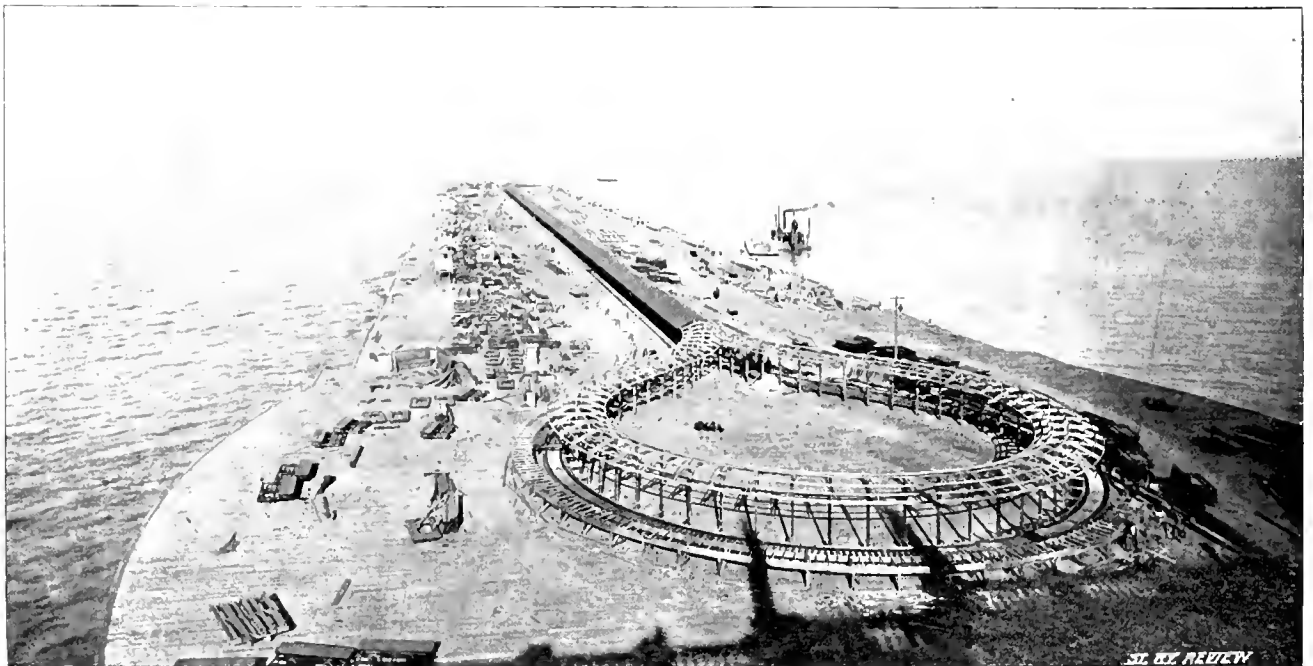

BIRD'S EYE VIEW OF PIER AND SIDEWALK FROM THE CASINO.

three miles an hour. This principle has been known for many years, but the connecting of platforms into a continuous line and the employment of an endless rail is the principal claim for newness, and the only means of utilizing the principle. This continuous rail can make any desired curve and the platforms be extended indefinitely.

Encouraged by the success of the experimental road, and assured of the success of a greater enterprise and longer line, Mr. Schmidt organized a new company and acquired rights in the Casino Pier at Jackson Park.

The constructing company is a solid one; J. L. Silsbee, the architect, is president; Max E. Schmidt, C. E., is general manager and engineer; W. E. Furness is secretary; W. E. Gookin, treasurer, while R. McC. Smith, formerly of the C. B. & Q., is traffic manager. The contractors for the structure are H. B. Herr & Company, of Chicago. With these men and \$150,000 capital, the Pier Movable Sidewalk Company enters the lists as the most unique and one of the most interesting rapid transit exhibits at the Exhibition.

The length of the structure is 4,300 feet, all double tracked. The straight length is 1668 on each side of the partition, giving 3336 feet. Each loop is 482 feet long, with minimum curves of 64 feet 9 inches radius and maximum curves of 80 feet. By this means the space of the pier can be economized, and the possibilities of the system show to its best advantage. The bird's-eye view of the pier and sidewalk gives a fair idea of the small space occupied by the system.

Beginning with the track, the stationary rail is ordinary 30-pound T, made by the Illinois Steel Company, and the gauge 45 inches. The track is spiked on ties laid 14 inches from center to center, held secure by brace chairs on curves, with steel guard rails, to make derailment

end will be anchored and the power turned on to pull them taut. Washers will then be fitted to the draw bars, making the whole train pull evenly and stop as one car. The platforms over the truck are 11 feet 6 inches by 3 feet 1 inch for the slow or outside platform, and 11 feet 6 inches by 5 feet 10 inches for the fast ones. The fast moving platforms are provided with seats (see illustration) which will seat three adults and a child each. Each fast platform will carry four seats. The slow platforms are available for passengers who wish to travel slowly and stand up.

The flexible rail, the "open sesame" and keystone of the system is $\frac{1}{2}$ inch thick by 4 inches high of mild steel. It is welded in lengths of 130 feet. Each joint is



VIEW ON THE PLATFORM OF THE PIER SIDEWALK.

impossible. On this rail runs a single line of trucks for the fast and slow moving platforms. These trucks, as well as the other rolling stock, are made by the Pullman Palace Car Company. The motor cars have 6-inch channel steel frames, 11 feet $3\frac{1}{2}$ inches long by 7 feet 3 inches wide. The motor platforms carry two ballast receptacles of a capacity of 1,600 pounds of lead each, making the total weight about six tons. The trail cars have rigid wood frames and weigh, including seating platforms, 2,800 pounds each. The wheels under the trucks are chilled steel, made by Griffin, and 18 inches in diameter, 3-inch tread, and $\frac{7}{8}$ -inch high flange. The wheel base of the motor is 6 feet 5-16 inches, and of the trailers 3 feet 9 inches. The platforms are 351 in number, of which ten are motors. As it is necessary that there shall be as little "slack" as possible in the train, one

18 inches long, dovetailed and riveted with fifteen $\frac{3}{8}$ inch Swedish iron rivets. The joints are furnished by the U. S. Car Company. Carnegie made this rail. The total length of the endless rail is 8,600 feet. It was found that no rail bonding is required as the endless rail is better than the best bond.

The platform above the pier is 5 feet, and 10 feet above the platforms is the shelter roof seen in our engraving.

The method of managing the crowds is well planned. Twelve set of exits and entrances are arranged, ten at the straight sides and two at the loops of the system. A short flight of steps lead to and from the stationary platform to which the passenger steps through a gate where an attendant relieves him of his ticket. Having stepped to the slow platform he may enjoy the lake breeze and the

view of the white city at the rate of three miles an hour, or if business presses he may step to the six mile platform without a jar and travel more swiftly to his destination. No overhead wire, no track in sight, no cable apparent, in fact nothing but the motion betokens a method of transit.

Tickets are sold at Kiosks at intervals along the sides of the walk. These tickets are collected as above narrated and passed over to the Columbian Exposition for destruction.

Aside from the utter simplicity of the sidewalk the thing that strikes the observer as most wonderful is the tremendous carrying capacity of the platforms and the small amount of power required to attain the end sought. First as to capacity the statement is this: Every passenger can catch his car. Geometrically, a train leaving a given point every half second is infinitesimally near to a train leaving all the time, and no one waits for a car. To overload the train it would be necessary to have the entire sidewalk every second surrounded by its fullest capacity. For instance on the Casino Pier there is a mile of seats, 500 persons passing a point each minute, 6,000 seats on the entire platform. or 35,000 an hour. For crowded districts—say Brooklyn bridge, Boston's down-town area, or Broadway—what a resolvent for congested traffic.

As for the power required, it may be stated that the Columbian Exposition will furnish 300-horse-power, of which 250 will start the train and 150 will keep it in motion while loaded. As there will be no interval stops, the starting torque once a day is all that is required.

The cost of the pier structure is about as follows: Electric installation, \$50 a horse-power; structure, the same as a narrow gauge railroad. With these possibili-

T. HACKWORTH YOUNG.

THE subject of this sketch has divided the duties of Willard Smith and relieved that gentleman of a heavy burden by becoming superintendent of the railway division, which includes street railway exhibits.



T. HACKWORTH YOUNG.

Mr. Young's experience has been altogether in steam lines, in which his education is most thorough, having

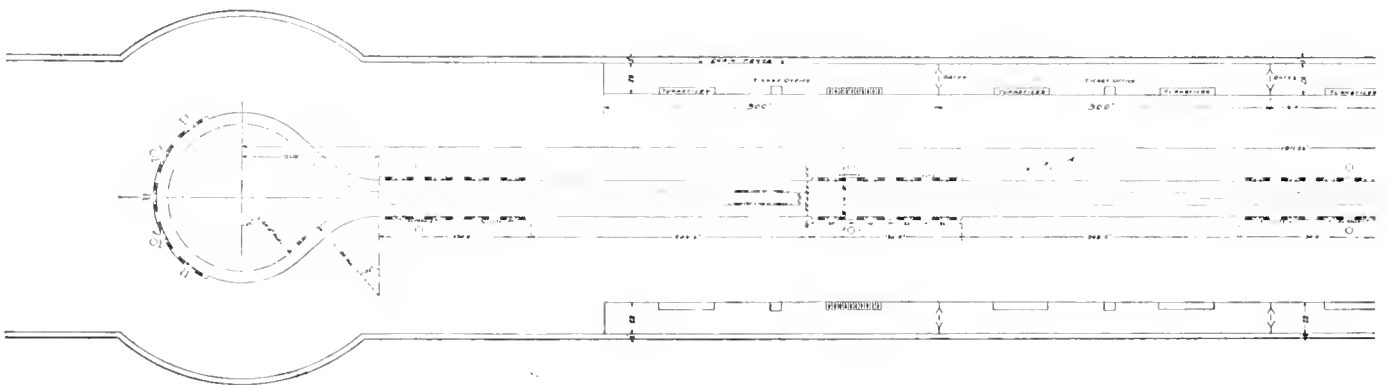

PLAN VIEW OF PIER SIDEWALK SHOWING ONE-HALF.

ties and these advantages of structure, safety and cheapness, the moveable sidewalk ought to take its place in the rapid transit world. It will not displace, it will not revolutionize; it will simply fill a gap—a desideratum never before successfully met.

THE Capital Electric Railway Company, of Baton Rouge, La., was opened to the public, April 5th, with appropriate ceremonies, including the driving of a silver spike by President B. F. Mayer.

served his apprenticeship in the shops of Kitson & Company, Leeds, England, the builders of steam street motors and engines.

In 1879 Mr. Young came to the United States and has been connected with several leading railways, besides making a trip to Central America as mechanical superintendent of the Costa Rica Railroad.

For the past five years he has been the master mechanic of the Chicago, Milwaukee & St. Paul. Mr. Young is well posted in street railway matters as well.

THE ELECTRICITY BUILDING.

HAMMERS and nails, saws and wires and boxes and tugging, and shirt-sleeved men have so far been the principal attraction of the beautiful electrical building at Jackson Park. This has been no fault of the electrical managers, however, but the natural and unavoidable delay attending the gorged switches, terminal railway and transportation facilities. Chief Barrett and his hard working assistants have done their level best to get things in shape, and have spent long hours at the anything but easy task of giving the exhibitors, each and every one, the best location in the building.

Finally, everything is pretty nearly finished and acceptance handed in for space, so that the installing force may begin their more satisfactory task.

To build up a new department without precedent is no easy task, and this was the work laid upon Professor Barrett. His work was not diminished either, by the action of the local board, in transferring to the Machinery Hall the power plant, occupying 180,000 square feet of space.

A large number of exhibits wishing to be classified in

INTRAMURAL CARS AND MOTORS.

BY C. H. MACLOSKIE, E. E.

THE cars for the Columbian Intramural were designed and built by the Jackson & Sharp Company, Wilmington, Del. They are of the open type, with cross seats and sliding doors. The doors are attached to iron rods running the whole length of the car, so that as the rods are moved by levers at the ends, all the doors are thrown open at once, admitting of rapid loading and unloading of passengers. The length of the cars over all is about 50 feet, the width 8 feet 7 inches. They are mounted on trucks of 5-foot wheel base and 32-foot truck centers. The trucks are of the same type as those in use on the New York and Chicago Elevated, but have been changed somewhat from the original designs in accordance with the present requirements. The motors have been built specially for the elevated service, combining speed with capacity for great horizontal effort. They will give 2,000 pounds horizontal effort each at a speed of 25 miles per hour, and correspondingly higher efforts for lower speeds, thus allowing for larger accelerations. The motors are of the same four pole

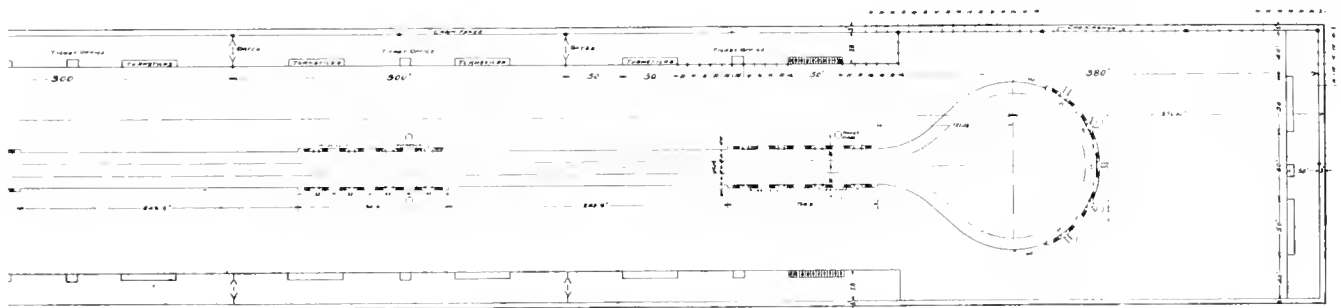

PLAN VIEW OF PIER SIDEWALK SHOWING ONE-HALF.

the electrical department have been very properly transferred to the Transportation Building annex, where street railway specialties are shown.

The sharp competition for space, consolidations, transfers and injunctions have, delayed progress in this department, but finally after much labor and pains the actual telling work has begun, and installation now goes on merrily. The booths of the Bell Telephone and the Western Union Telegraph Company are now built and occupy prominent places on the first floor. At the center, too, the General Electric has already on the floor a fine display of dynamos and light machines. This exhibit is in charge of Lieutenant Spencer, of the Boston office.

There are now qualified 68 Chicago firms, 7 from Cleveland, 37 from New York, 12 from Boston, 9 from Philadelphia, 71 miscellaneous, and the large separate exhibits of Westinghouse, Pittsburg, the General Electric, and the Fort Wayne Electric Company.

Foreign nations are represented in electrical industry by Austria, Brazil, Canada, England, France, Germany, New South Wales, Russia, Spain, Monaco and Italy.

type, with the General Electric Company's toothed armatures and cross connected commutator connections. The gearing is single reduction, steel gears and pinions being required to withstand the strains on the teeth. Each motor weighs about two tons and is capable of supplying 133 horse-power as a steady load. The first car on each train is fitted out as a motor car, the trucks and axles reinforced so to stand the excessive strains. The controlling apparatus have been designed for this service; it is of the semi-parallel type, throwing the four motors into series, then into a two and two combination and finally at full speed into parallel. As the controlling apparatus is very large it was found necessary to handle it by means of compressed air. The revolving cylinder is connected through a rack and pinion to a pair of pistons, which are moved by compressed air, and are controlled as to action by oil passing through a valve. The compressed air is taken from the air brake reservoirs. The air brake employed is the "straight air" brake with annexed cylinder, manufactured by the New York Air Brake Company. A small oscillating pump directly coupled to a 3-horse-

power motor compresses the air required for braking and controlling purposes. This motor is automatically started or stopped as the air pressure is below or above the normal pressure. A small whistle is employed in connection with the compressed air for signaling.

Four cars constitute a train, and fifteen trains the equipment. The schedule time for the round trip is forty-five minutes. The test trip was made April 15th and found the motor and station equipment entirely satisfactory.

PASSENGER TRAFFIC TERMINAL FACILITIES AT JACKSON PARK.

PERHAPS the most perfect terminal facilities ever attempted for handling passenger traffic has just been planned for the Jackson Park terminus of the Chicago & South Side Elevated. The conditions are perhaps more peculiar than ever before in the history

The Alley L enters the Park at Sixty-third street, in common with the steam roads, and the station about to be described is within 100 feet of the terminal. The "L" terminal shown in our engraving is on the roof and to the west of the Transportation annex, the intramural road crossing the annex. This is about 400 feet from the Stoney Island fence, and the platforms run parallel north and south of the place. Near by is the grand station where the steam roads discharge their passengers. The Alley platform itself is 250 feet long and 80 feet wide, and, as stated, runs north and south. It is covered with a light iron roof and surrounded by a picket fence 7 feet high. The platform is divided by two tracks 36 feet apart, making a center platform 36 feet wide and two side platforms each 22 feet wide. The track runs within 30 feet of the platform on the south side. Access to the grounds from the platform is obtained by three stairways which are continuations of the platform, one in the

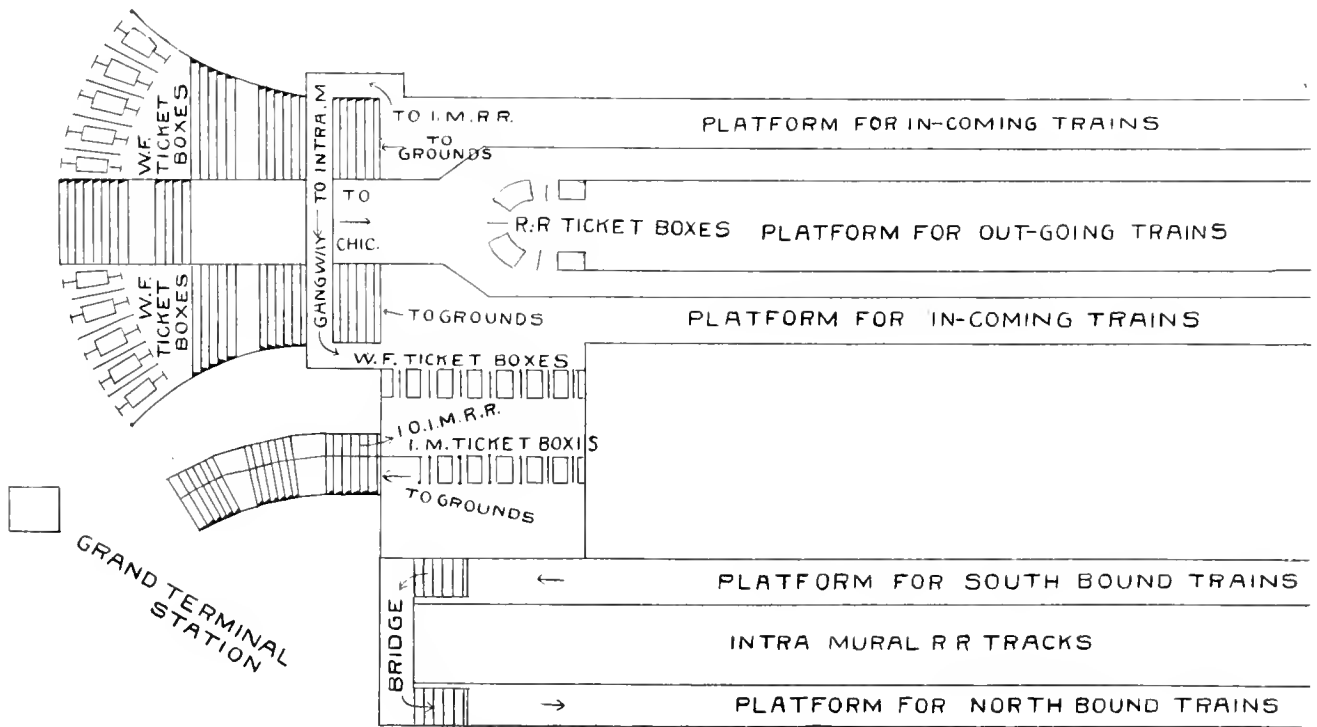

PLAN VIEW OF WORLD'S FAIR TERMINAL OF ALLEY L.

of urban transportation, but the means to meet the surroundings seem equal to the task.

The system briefly described is a complete interchange of traffic from the Alley L, the intramural elevated, the great terminal station and the Exposition grounds. Engineering skill, executive brains, and money have not been spared to make the arrangement not only a complete system of terminal transfer and discharge, but also one of the most complete and interesting exhibits on the grounds.

The last section of the Elevated extension into Jackson Park has been placed and a large force of men has been steadily at work and has now almost completed the building of the terminal platforms, stairways, entrances, cross overs and exits.

center and one at each side, the side stairways curving away from the center one. The center way is 36 feet wide, broken in the middle flight by an 8-foot landing.

Coming into the grounds the trains will run onto the south track, and in going out take the north track. At the north end of the track a simple cross-over switch takes the train to its proper place. Thus all trains can discharge passengers and be cleared in a very few minutes. On the ground in front of the curving, or into-the-ground stairways, will be set World's Fair turnstiles, where Alley L passengers may obtain tickets for the Exposition. At the head of the straight stair there will be a set of four ticket boxes and eight ticket choppers. These are on the middle platform. This divides the

crowd. The intramural station is just west of the Alley L, as noted, and passengers coming from the L go over a bridge, pass the World's Fair ticket boxes, buy and deposit their intramural tickets, and are transported to any point on the intramural line without touching foot to ground.

The simple operation of the system is well shown in the accompanying engraving, redrawn and simplified from the official tracings by the kindness of President Barnard.

To facilitate traffic, a four minute headway is to be established and several terminal stations will be placed along the route, at Thirty-seventh street and Twelfth street notably. Here trains will be turned so that way passengers may find more comfortable cars and seats as well as the through and traffic. If necessity require, a minute headway can be comfortably accommodated by this means. The road has now 11,615 feet of siding, so that switch and storage facilities are complete. The road is equipped by the Union Switch & Signal Company, with their system.

The road will have a capacity of 37,500 passengers an hour and a rolling stock equipment of 320 cars.

President Barnard, Chief Engineer, R. I. Sloan and staff, deserve great credit for the organization of these facilities, and the fact the traffic has more than doubled in six months shows that their efforts are appreciated by the public.

THE Barre Sliding Railway has tided over its financial difficulties, acquired some more solid capital and will complete and operate its World's Fair line.

DANIEL COOLIDGE, vice-president of the Johnson Rail Company, has been making an extensive western trip, touching at Indianapolis, Chicago and New Orleans.

THE following from the Chicago Tribune of April 15th would indicate the Tribune man had tarried too long at the fountain. It says:—

▲ S. Littlefield and Daniel Coolidge, of Johnstown, Pa, were at the Grand Pacific yesterday. They represent a syndicate of Eastern capitalists and are on the way to St. Louis to close a deal for the street railway plants of that city and Omaha. The negotiations represent about \$50,000,000, and will place the street railways of both cities under one corporation.

TO ILLUSTRATE the evolution of the dynamo, the Ansonia Electric Company will exhibit in its pavilion at the World's Fair the four first dynamos of their respective types constructed or operated in the United States. The old Wallace-Farmer machine, which was continuously in operation at the Centennial in 1876; the Telemachon, which is well known to students of the history of electricity in the United States; the Gramme dynamo, built by Prof. Anthony, of Cornell University, in 1874, and exhibited in Philadelphia in 1876, and which is now running and doing good work as a motor in the Department of Physics at Cornell; some of the original sawed carbons first used in electric lighting, and other machines and appurtenances will be exhibited, and will be a very pleasant study for the electrical engineer.

EXHIBITS AT AMERICAN STREET RAILWAY ASSOCIATION.

AS already illustrated and described in the REVIEW, the facilities for exhibits at the next annual convention, at Milwaukee, October 18, 19 and 20, will surpass any in the history of the association. The secretary has issued instructions to exhibitors which set forth the ample provision for exhibits, all of which will be under one roof, and in the same building as the business sessions. Floor space will be charged at 10 cents

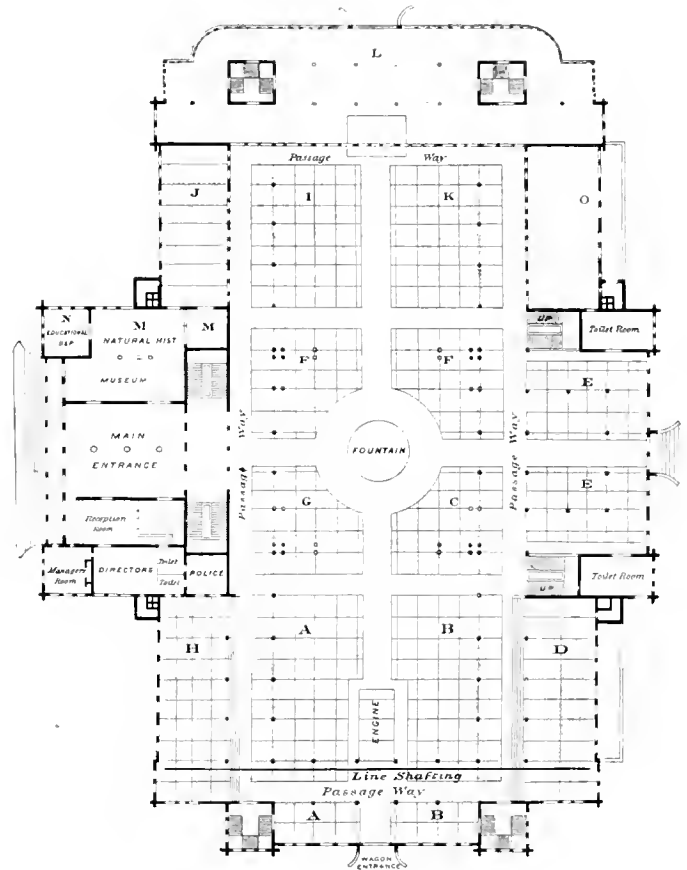

PLAN OF EXPOSITION BUILDING, MILWAUKEE.

per square foot, with a minimum space of 100 and a maximum of 2,000 square feet, except by special permission. Steam power will be furnished at actual cost and prorated among users. Applications should be made at once. Space will be allotted May 10. Address all communications to W. J. Richardson, Secretary, American Street Railway Association, 166 Montague street, Brooklyn, N. Y.

THE RAILWAY EQUIPMENT COMPANY, of this city, has issued a cordial letter, inviting visiting street railway men to avail themselves of the hospitalities of their office during the Fair. A register will be kept of railway men in town.

THE Janesville, (Wis.), Street Railway Co., will erect a handsome station and waiting room.

WORLD'S FAIR TRANSPORTATION.

WE present on the page herewith a correct view of the terminal facilities of the great arteries of urban transportation for the World's Fair. The plan does not include, of course, the several hundred boats, and the cabs and carriages without number, which will do a heavy business with those whose time is not reckoned by the minute. The best facilities are always inadequate for the sudden transportation of

vast numbers, but a glance will show that the terminal facilities alone will be a tremendous avenue for the distribution of the people.

The most interesting part of the map, however, is probably the intramural railway known as the Western dummy system of elevated electric. This is under charge of the General Electric Company. The more extended article upon the same subject, contained in our last issue, shows the capabilities of the various systems of transportation.

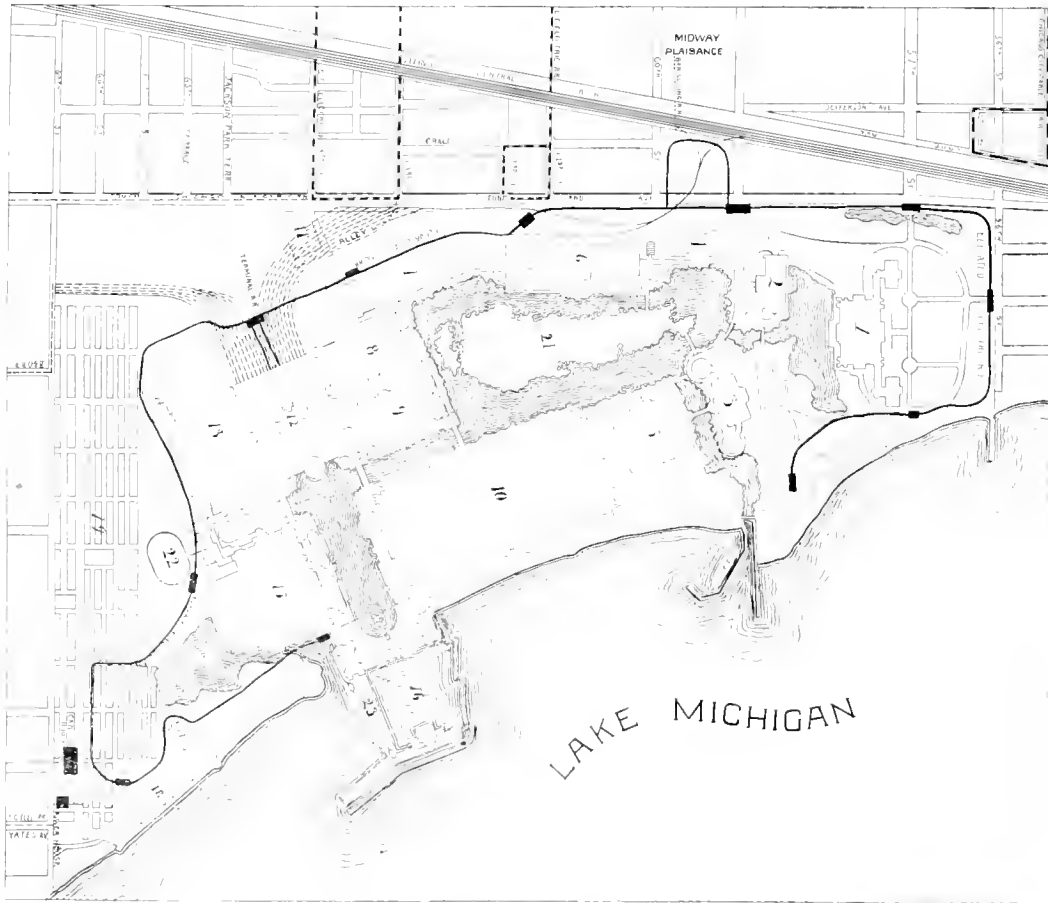

MAP OF JACKSON PARK RAILWAY FACILITIES.

- 1. Art Gallery; 2. Illinois Building; 3. Fisheries; 4. Women's Building; 5. Government Building; 6. Horticultural; 7. Transportation;
- 8. Mines; 9. Electricity; 10. Manufactures and Liberal Arts; 11. Service; 12. Administration; 13. Machinery;
- 14. Machine Shop; 15. Agricultural; 16. Harbor for Pleasure Craft; 17. Dairy;
- 18. Forestry; 19. Stock Exhibit; 20. Naval; 21. Wooded Island;
- 22. Stock Pavilion; 23. Pier Movable Sidewalk.

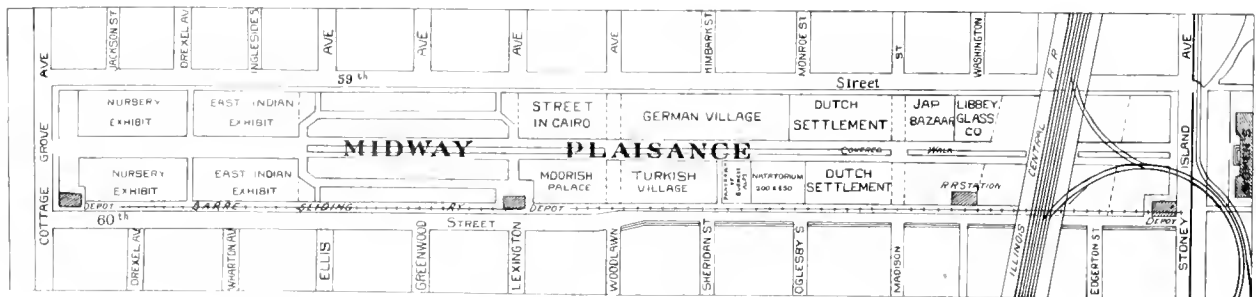

MAP OF THE PLAISANCE

SELLING POWER FROM TROLLEY CIRCUITS.

THE number of railways selling power from their trolley circuits is surprising to those that have not investigated the matter. The business has grown in a quiet way, generally requiring little effort on the part of the road, and so it has attracted but little attention. We could name a half dozen roads within 100 miles of Chicago that have a good income from this source.

There are many reasons why the average electric road can sell power from its trolley circuit more cheaply than the electric light stations in the same town. In the first place the power business in the majority of moderate sized towns, such as the greater part of the electric roads of the country operate in, is either so scattered or so small that it is only at great expense that the lighting companies can handle it. In order to supply these scattered customers, the electric light company has either to install a special high pressure circuit and dynamo for its power work, or to invest a large amount in copper to bring its low pressure incandescent system to such customers. In either event the result is rather unsatisfactory to the company, and an investment is required over and above that necessary to the regular business of the plant. The running of a small engine and dynamo simply to supply a few consumers with power is liable to be unprofitable either to the company or the consumer. If the power is supplied from lighting circuits, the variations in load on the larger motors does not conduce to steady light. Then, too, there are generally plants of some size that want power, but it is impossible to generate electricity and supply it at some distance and make it more economical than direct steam, unless the generating station is very large.

With the railway the case is different. It has an immense power capacity installed and running at the time when it is wanted. Its outlay per horse power of steady power generated is very low. Its lines are strung all over the city, and the ground helps furnish a return, so that the cost of installation is small. In short, what may be a very unsatisfactory business for the lighting companies may be a very satisfactory one to the street railways.

It is not advisable, of course, for the railways to enter into cut-throat competition with the electric light companies, but if the field is undeveloped there are good reasons why the railways can give the cheaper service. Such business generally does its own canvassing when once started.

The only objection that can be made to running stationary motors from railway circuits, is from the fact that one side of such circuits is grounded. Several years ago this objection would have had more weight than at present. The large Edison illuminating companies are now advocating and practicing the grounding of the middle wire of their three wire circuits, thereby making them practically no better than the trolley wire as regards safety from fire and shocks. Many engineers claim that it is easier and safer to maintain the insulation of a single conductor from

the earth, than to maintain the insulation of two conductors, either one of which may become grounded without the knowledge of those in charge. With the one wire plan the fuses and switches are simplified and on the whole a carefully constructed system with one side grounded is not nearly as dangerous under our present perfection of construction as the old installations were with a completely insulated circuit. A few years ago a great howl would have been raised at the idea of grounding a circuit but to-day it is not considered anything startling, and with careful wiring is perfectly safe.

When supplying power in this way it is at least safe to adopt the custom of many companies now in the regular power business and insist on a regular inspection of the motor and the surroundings by the employes of the company, even if the wiring and motor installation is done by the user. In this way many dollars worth of reputation may be saved through the prevention of accidents, which though they may be entirely the fault of the consumer, have a tendency to arouse the public fears of everything electric.

One of the most successful roads in the power selling business is the Omaha Street Railway Company. W. A. Smith, the general manager, makes us the following contribution on the subject which will be read with interest: "We are furnishing power to everyone that wants it. Among our customers are carpet cleaners, overall factories, tin manufacturing companies, paint factories, box factories, laundries, printing companies, broom factories, fans for hotels, carpenter shops, button factories and dentists. The amount of power they use runs all the way from one-quarter horse-power to 25-horse-power. We charge by the horse-power. When a man puts in a motor and puts it to work we put our ampere meter on and see how much power he is using and charge accordingly. Motors are taking the place of small engines; they take but very little room; you can hang them on the wall or stick them in a corner and they will do the work and make no dirt."

Another road doing an extensive business in this line is the Sioux City Street Railway. President James F. Peavey is an enthusiastic advocate of this method of increasing the earnings and sends the following account of it:

"I find the furnishing of power for stationary motors to be one of good profit to our company. In fact our revenue from this source practically takes care of our fuel bill for the entire operation of our plant and is constantly growing. We do not use meter rates, but have an established monthly rental based upon the rated horse-power of the motor. For instance, if a man puts in a 5-horse-power motor we charge him 5-horse-power rates, although he may not use to exceed half this amount. We do this after the experience of knowing that many concerns will put in a much larger motor than their present needs warrant, in anticipation of a growing business, and have been asked many times to permit the putting in of, say a

5-horse-power motor, and charge on a basis of what is now being used, say a maximum of 2-horse-power, but we have in such instances found that our customer, unintentionally of course, neglects to inform us as his business may increase, and he finds it necessary to use the entire capacity of his motor. In a good many instances we connect direct to our railway circuit, although in the majority of cases we are furnishing power from off the direct and independent wire. We do this as on our railway circuit a fuse may blow out and would be of considerable inconvenience to the user by stoppage. We are furnishing current for motors used in all classes of work, light factory work, grocery stores, machine shops, elevator purposes, etc. Our schedule rates are as follows:

For one horse-power.....	\$ 8 00
" two "	15 00
" three "	21 00
" four "	26 00
" five "	30 00

All sizes above 5-horse-power \$5.00 per horse power per month.

We have made an arbitrary rule of collecting invariably in advance and disconnecting immediately upon the non-payment of any account due. The matter of stationary motor power is certainly one of great importance to any railway company, and a source of considerable revenue, and it is surprising to me that more companies do not give more attention to this important feature."

A THREADED TROLLEY WIRE SPLICER.

THE Ansonia Electric Company are the manufacturers of the trolley wire splicer shown herewith. It is simply a tube threaded on the inside with right and left hand threads. The wire is threaded with a tool furnished for the purpose. If desired the splicer is furnished with slots to admit of soldering, but this is said not to be necessary as some tests made on the Chicago City Railway showed the breaking strain without solder to be 3,000 pounds. In these tests it was the trolley wire that broke, the splicer remaining intact and the threads being unstripped. This splicer is so small that it makes almost a continuous wire of the joined ends. It has been in use for over a year and is indorsed by all roads using it.

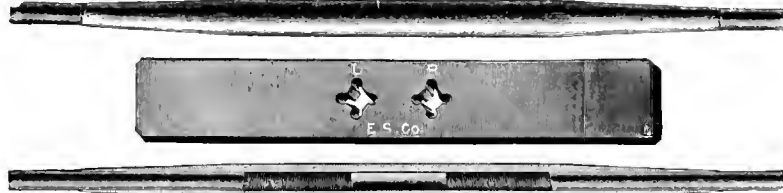

THREADED TROLLEY WIRE SPLICER.

ON March 22, President Cleveland appointed John S. Seymour, of Norwalk, Connecticut, Commissioner of Patents. He is about 45 years old, a lawyer by profession, and recently a member of the Connecticut legislature.

THE street railway lines of Bridgeport, Conn., and Stratford are to be consolidated by the Rochester syndicate under Col. Heft.

DR. PARKHURST ON THE CAR.

THE New York divine who has been before the public so much lately, enjoys a good story as well as anybody, and is willing to tell it even at his own expense.

"I was riding in a Broadway car when a stranger took a seat next me," he says, "and after looking at me for a moment, said that, although unknown to me, he wished to thank me personally for something I had done for him."

Dr. Parkhurst says he wasn't proof against the subtle flattery of the greeting, and blandly asked what favor he had performed.

"Well," replied the stranger, "I own a lot of flats uptown which didn't rent for more than \$20 a month each. Your crusade against vice has driven all the wicked people uptown into flats, and I am now getting \$50 a month rent for each of my flats."

What with rapid transit and Dr. Parkhurst as civilizing elements, New York ought to become a highly respectable village.

STREET CAR ADVERTISING IN NEW YORK.

WE want to remark first that we "see that hump," "Do not tobacco spit our life away." know that some articles of diet "are best and go farthest" in Chicago. New York signs, however, go us one better as to the impertinent and startling. Not long ago a Brooklyn man turned suddenly and blurted out unconsciously to his neighbor, "Are your hands dirty?" "That's a nice question," said the man addressed. "Of course they're not." Thereupon the interrogator laughed and pointed to a sign over the window, where the very personal remark was displayed in large black letters on a white ground, and the seeming impertinence was shifted from his shoulders to that of some unknown personage. "I'd never tell that fellow if they were," remarked the other man.

LONG DISTANCE TRANSMISSION NOTES.

THE well known electrical engineer of the Pasadena & Mt. Wilson railway is one of the pioneer movers in long distance transmission in America, and as a result of his ideas a light and power plant will be installed at Redlands, California, on the three-phase system; the generators to be coupled direct to the turbine shafts and electrically in parallel.

In connection with the harnessing of Niagara Falls the Hamilton Radial Electric Railway Company, of Hamilton, Ontario, has been formed with the idea of using

power transmitted from the Falls to operate an extensive system of electric railways around Hamilton. Tenders have been received from well known companies for the transmission at various pressures, ranging from 10,000 to 50,000 volts, and at losses in the neighborhood of 30 per cent from the turbines to the motor. Matters are reported to be progressing favorably.

INSULATORS FROM THE BOTTOM OF THE SEA.

THE street railway supply firm, Albert & J. M. Anderson, of Boston, who are makers of the strain insulator herewith illustrated, are congratulating themselves on the excellent way in which it has stood up under tests recently made. Some of these insulators

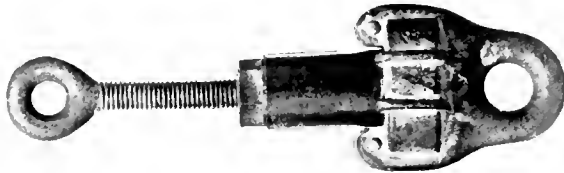

were on board a steamer which was sunk in Boston harbor recently. After twelve days some of them were recovered and submitted to tests for insulation resistance which showed 160 to 600 megohms apiece at first and after ten days drying this increased from 25,000 to 300,000 megohms.

A TIMELY WARNING.

NOT long ago a street car conductor in Buffalo, N. Y., was arrested and convicted of falsely punching, and turning in transfer checks as cash fares.

In sentencing him Judge Sievers said:

"Mr. —, you have been brought here to answer for a very serious crime, the crime of forgery. This is a crime in which the Court could imprison you for a good long term if it saw fit to do so, but we are met here by the fact that you are the first person that has been found guilty of this crime, and while it is an important matter to the railway company, they have kindly come in here and said that it being the first case they desired that the Court should be lenient.

"We are also met here with the statement that you have got a wife and family depending upon your support, and the Court is inclined to think that perhaps it will answer the purpose by dealing leniently with you. At the same time they desire to say to you as well as to all others, that they must not judge by this punishment that is given to you that it is the punishment that this Court will inflict in any future cases that may be brought before it, but under all these circumstances the Court is inclined to be lenient, and the sentence is that you may be confined in the Erie County Jail for three months."

INTERNATIONAL TRAMWAYS.

IT is announced by the secretary of the International Tramways Union that its session, which was to have been held at Buda-Pesth last September but was prevented by cholera, will meet at Buda-Pesth early in September, 1893. The original programme will be carried out, and a most interesting conference ought to result. As the regular publication of the report of this Union has been temporarily suspended, owing to the postponement of the meeting, the society has published in the meantime a detailed account of the Cologne Tramways Company, prepared by H. Geron, manager. The society proposes to follow this with descriptions of other important continental lines.

NORTH CHICAGO CLEANS HOUSE.

ALONG with the revival of street-cleaning, duck-hunting and love-making, the North Chicago road begins house-cleaning and re-fitting. Twenty-five carloads of new rails have arrived for rebuilding the road on Wells street, in the tunnel, and on side lines, and the work will be completed about May 1.

Gas motors from the Connelly factory will be put on the cross town lines, and the total output of the company for some time will be taken up with the West and North Side roads. The Connelly Company is turning out two motors a day. There will be about thirty motors ready May 15. The gas factory site is already bought, and will have a capacity of 36,000 cubic feet a day.

The rolling stock has been materially increased, and 1,000 cars will be ready for service by May 1.

ST. PAUL AND MINNEAPOLIS AGAIN.

THE twin cities are rapidly becoming a Siamese twin with a good strong connection of railways and electric wires between the two hearts that beat as one. Already the various steam lines and the Twin Cities Rapid Transit Company's electric give good service to the large traffic.

Now the terms of agreement are signed for another through electric line. The negotiations were made through A. R. McGill, H. C. Pratt, W. W. Clark, A. C. Bruce, J. B. Jett and W. McMurrin and others with the Twin Cities Company. The new line is agreed to be similar to the interurban, and is to extend from the present terminus of the Minneapolis Street Railway line at the corner of Fifteenth avenue and Como avenue, and connect with the Como line in Minneapolis, and extend by the way of Como avenue and the county road to the brick school house near the present terminus of the St. Paul City Railway Company system, at the corner of the county road and Langford avenue, in St. Paul. Word is sent out that the building is to be rapidly pushed.

The cars are to be run from 6 a. m. until midnight, and the line is a citizens' affair.

A CHAPTER ON PAVING.

PART I.

AS all street railroad companies are interested in the paving question, and as probably very few managers have the time to read the large amount of current literature on the subject, we have thought best to prepare the following article which is an attempt to give, as briefly as possible, the present status of different kinds of paving among those who are engaged in the business, and who have made such matters a special study. The matter herein presented is not intended for paving men, but for those who have not, from the nature of their business, had the opportunity to keep abreast of the times on paving subjects.

The popular pavements in America are limited to five—granite block, cedar block, asphalt, brick and macadam. There are plenty of other kinds in use, but popular favor seems to have rested on these especially, and to such an extent that there are comparatively few miles of any other in use.

Before discussing the different kinds of paving it is important to note the foundations used. It is admitted that the foundation is an entirely separate affair from the wearing surface or pavement proper. The poorest kind of pavement may be laid on the best of foundations and vice versa. If a good foundation is laid any kind of wearing surface can be laid on top of it, and relaid as fast as it wears out without great expense. A foundation must be chosen with regard to the weight of traffic passing over it, the materials most easily available, and the time it is likely to remain down without disturbance. Foundations are ranked in the order of their solidity and lasting qualities, as follows: Hydraulic cement, bituminous cement, tarred boards, pounded stone and sand. Sand and pounded stone are used as bottom filling, with cement and board foundations. Foundations for use with brick will be spoken of later. Foundations for cedar blocks should be chosen with special reference to under drainage. It is absurd to expect a pavement to last without a firm foundation, and it is therefore important that the leveling, rolling and tamping in this work should be thoroughly and carefully done.

Having considered the foundation, the question of the wearing surface, or, in other words, the kind of pavement, comes up for settlement. While there are those who harp on the excellencies of one kind of pavement to the exclusion of all others, common sense paving men know that each pavement has its place, where it will serve better than any other.

GRANITE BLOCK

paving is to well known to need much mention. It costs \$2.75 to \$4.00 a square yard, according to the foundation and filling used, and the distance from a quarry. For wearing qualities it is admittedly at the head. This is, perhaps, the best thing that can be said of it. It is

rough, slippery, noisy and hard on horses. Notwithstanding these facts, it is the only pavement that will last any length of time under the heavy traffic on some streets of our great cities. The foundation may be any of those before mentioned. The filling is usually either sand or bituminous cement, which latter will be mentioned later under the head of asphalt. Granite blocks must be of equal size or trouble is likely to ensue from unequal settling.

CEDAR BLOCK

paving is not very extensively mentioned in paving literature. Nevertheless the cedar block, like the trolley, seems to be the only thing in many places. Until the advent of brick paving it has been about the only cheap and reasonably durable pavement available for smaller cities requiring something more lasting than macadam, and less expensive and noisy than granite. It is commonly laid on a foundation of boards and sand, though, of course, any foundation is available. Cost is from \$1.25 to \$1.50 a square yard. The filling should be of bituminous cement and gravel. A novelty in the cedar block line introduced in late years is the sapless block. An ordinary block has a dry center with a sap soaked outside. This causes the edges to wear down making a round "nigger head" out of every block. Sapless blocks it is claimed do not wear this way. Cedar blocks are not suited to wet climate and soil as they will soon rot out.

ASPHALT

is a bituminous material found in a natural state. In paving, or in acting as a filler for other kinds of pavement, it is used in combination with coal tar, petroleum, gravel, etc., the proportions of these ingredients being such a variable quantity in different specifications that it is impossible to strike an average. Asphalt is found in a pure state in the island of Trinidad, and is also found mixed with lime and sandstone in California and France. Trinidad asphalt is the most popular and widely known, and has been found more reliable than most other kinds. California asphalt is used extensively on the Pacific coast. It is very soft, but this does not seem to have prevented its use. The objections to asphalt are that it is very susceptible to changes in temperature, and will bulge or crack in a climate such as exists in many of our northern cities, where there are extremes of heat and cold; it is soft in a warm day, and hard and slippery in a cold; it smells bad when under a hot sun, and absorbs so much heat as to make it painful to horses, besides increasing the liability to sunstroke. On the other hand it is the smoothest and cleanest pavement known. A force that will haul a ton over granite will pull three over asphalt, to say nothing of the lessened wear and tear on the vehicle. The cost of cleaning asphalt is much less than any other pavement. A first-class asphalt pavement should have a foundation of cement. Hydraulic cement

is the most solid, but it does not have the same ratio of expansion as the asphalt wearing surface, consequently the asphalt will tend to come loose from the cement when expanding or contracting under heat and cold, with the result that patches come off and the foundation is exposed. When bituminous cement is used the top coating and the foundation are of the same nature, making practically a solid mass. If there is any trouble in this case it will be caused by the bulging of the whole pavement, making soft ridges at the place where this occurs.

Asphalt and allied substances are generally applied at a temperature of 200 degrees Fah. or over, whether they are for filling, foundation or wearing surface. For cities where the temperature is warm and even, and the traffic light, asphalt makes almost an ideal pavement. Its cost ranges from \$2.30 to \$4.50 a square yard.

The Warren-Scharf Asphalt Paving Company has recently introduced a new method of paving in connection with T rails. Along each side of the rail a row of blocks is laid, preferably of asphalt or some allied compound. The paving outside of the blocks may be of any kind. Along between the rail and the blocks hydraulic cement

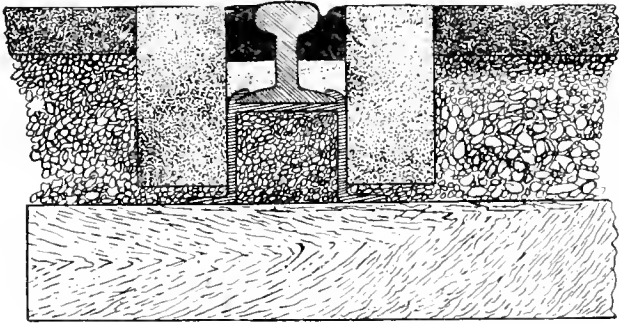

PAVING TO T RAIL WITH ASPHALT.

is filled in to about half the height of the rail, as shown in our sketch. On top of this a compound of melted asphalt is poured in and tamped. While the compound is yet plastic a truck is run over the track making the groove for flange. In this way the rail is made as good as the grooved rail, as far as the hindrance to vehicles is concerned, and at the same time there is a strong bed surrounding the rail and helping to stiffen it. Our sketch shows this method as used in connection with asphalt paving.

MACADAM

is simply a combination of pounded stone with thorough rolling, good foundation and good drainage. It is suited only to suburban roads where the traffic is very light.

WOOD STEEL

pavement has never been extensively tried. The idea in this case is to make a pavement easily removable for underground repairs. On a smooth sand foundation the perforated plates of steel are laid, and to these are fastened the wood blocks. A section of pavement can easily be taken out without disturbing the rest.

BRICK.

Brick paving is the infant of the paving industry, and it is a growing one. It is not as young as many suppose, having been used in some places, where the proper kind of brick could be easily obtained, for nearly twenty years. Although it has been cracked up by some of its supporters as the cure-all of paving evils the exaggerated notions of its good qualities do not seem to have caused a reaction against it after actual use, which fact is probably its strongest recommendation.

Being in its infancy the brick paving industry has naturally had many experiments to make and many mistakes to correct, but the fact that the cities that have tried a properly laid brick pavement are making arrangements for more, shows that the results, as a whole, have been satisfactory, and this pavement is no longer an experiment. It only remains then to investigate what has been successful in practice.

It is generally admitted by unprejudiced engineers that good brick comes next after granite in the matter of wear, and so, on account of its low first cost, and many other qualities in which it excels granite, is more desirable than granite for the majority of places. Brick will wear long enough for all practical purposes in all streets except the most crowded parts of our largest cities. As for cleanliness, quietness and smoothness brick comes next after asphalt, while it affords nearly as good a foothold as granite. The first cost of brick pavement is from \$1.25 to \$2.30 a square yard, depending on the foundation, filling and distance from brick kiln. It has been claimed by some advocates of brick that it could be relaid as fast as it wore out and still be cheaper than granite, even for heavy traffic, because of its low first cost and the saved interest on money invested. The situation seems to be that while the old forms of pavement have each a particular point of excellence, brick in a large degree combines all these desirable qualities.

Foundations for brick pavements may be of as solid material as is used for the best granite or of very cheap material. The foundation is, as was said before, entirely distinct from the wearing surface. In some places where macadam has been used and worn out it has proved a good foundation for brick. Brick has been laid directly on a sand foundation and given fair satisfaction under light traffic. Hydraulic or bituminous cement is, of course, as good a foundation as can be obtained. Under such conditions a layer of sand between the foundation and brick greatly cushions the pavement. One very common method is to place a layer of soft brick on top of a base of sand or pounded stone, and on top of this to place the paving brick, running at a different angle with the foundation. It goes without saying that joints should always be broken in laying brick pavement.

After the brick has been laid and rolled the next consideration is the filling. Bituminous cement makes the most solid filling, and is used where there are heavy requirements, though fine sand serves well in many places.

The angle at which the courses are to be set with reference to the street is a question of controversy. The most common way is to lay the long way of the brick at right angles to the direction of the street. By laying at 45° to the street some claim that the wear is decreased and draught made easier, and point to the wear on bridge planks laid by the two methods for proof of their theory.

(TO BE CONTINUED.)

EDISON'S SAND.

SHARP sand for use in railway and street railway work is not always easily obtainable. The article manufactured by Neptune & Co., on the sounding sea shore is so rounded by the action of the waves that it is next to useless and really inferior to the grit taken from river banks and prehistoric lake beds, although this also presents the same difficulties. Our own Mr. Edison at this juncture comes forward with an improvement on nature, a sand that has never been subjected to the action of the elements. He makes it as a by-product of the ore separating process at the Ogden mine, Sussex county, N. J., where crushed lean iron ore is made to yield up its last by means of heavy magnets. The residue is powdered rock, heavier than ordinary silica and sharper than sedimentary sand. As it is already thoroughly dried it requires no roasting. It does not cake. Many carloads are sold every day, and the demand is on the increase.

THE BLOCK SYSTEM.

THIS is not a technical paragraph, but is a true story at the same time. It happened in Harrisburg, Pa., on an electric line. The snow was coming down in chunks, and the sweeper was on its rounds, rather disconcerting the electrics at times. The car was crowded with passengers on their way to church and was speeding along merrily, when all at once it stopped short. There was a look of surprise on one petulant old lady's face who sat near the stove, and after waiting some time and seeing no move on the part of the motorman to go ahead, she turned impatiently to the gentleman who sat near her and said:

"My goodness, what's the cause of the delay?"

"I understand the track is blocked," answered the gentleman politely, and turned away.

"I knew it!" said she; "that terrible block system again. I've heard of it on the railroad, but never before on the motor line. It may be a good thing, but I'm sure somebody'll be killed." And leaning back she shut her eyes until the electric sweeper, a square distant, had proceeded on its way, and the motor followed in its wake.

POSTMASTER ANDERSON, of Cleveland, is planning for an electric railway mail service. The unquestionable success of this plan in St. Louis is leading many postal authorities to consider the matter.

A CONNECTICUT NIGHT HORSE.

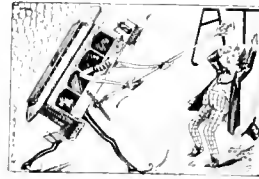

a recent committee meeting in Connecticut one of the most vehement obstructionists to electric railroad building was one Hiram Jacobs, of New Haven. He wanted to make each town responsible for any damage claims which might arise through the operation of electric cars, and as a parting salute Hike struck an attitude and with upraised hands declared: "I would much rather encounter a locomotive any time on a highway than one of these electric cars. On the locomotive you have an engineer who has been educated to his business; who understands it thoroughly, and who is competent. How is it about these motormen? Who are they? Why! I venture to say that you can go to Castle Garden today and get a man there and convert him into a motorman tomorrow. Or take the heathen Chinese and put him on as a motorman with his pig tail for a bell pull."

The gentleman's own words should be the best argument in support of the simplicity with which an electric car can be operated. Man-afraid-of-a-car Jacobs must have enough moss on his back to stuff a car seat, and be a direct descendant of the witch-burners.

WATERTOWN'S MUTUAL AID.

THE commendable spirit of mutual aid evinced among so many of the employees of the larger companies has been further exemplified in the Watertown, N. Y., Mutual Aid Society. This association is totally independent, and organized solely for sick and accident benefits. It was organized March 1, of the the present year, with thirty-two members. There is no expense attached to the administration of affairs, and consequently no quarrels as to whom the offices and emoluments shall go. The initiation fee is \$1.00 and the dues 50 cents a month in advance, payable the first of each month. A committee waits upon the applicant for aid and reports to the society, when \$5.00 a week is allowed from the funds. A member must be sick or injured three days before he can draw indemnity. The officers of the company are: Geo. W. Adams, president; M. Harigan, vice-president; R. McClenathen, secretary and treasurer, and an executive and an investigating committee.

THE WORST YET.

A GOOD many brilliant things are claimed for electricity, but Dr. E. Hutchinson is reported to have made the following statement before the Royal Institution, of London, England. Dr. Hutchinson said that with the electric motor a speed of one thousand miles an hour could be obtained, "though beyond that point they perhaps entered the region of projectiles rather than of locomotives."

HENRY MELVILLE WHITNEY.

THE builder of the West End street railway system of Boston, Henry Melville Whitney, and one of the most successful business men of Massachusetts, comes of a distinguished family, is thus another proof of the old adage that blood will tell. His grandfather, Stephen Whitney, was for several years the representative from Deerfield in the General Court of Massachusetts, and he also held other public positions of trust. Stephen Whitney's wife, Mary Burgess, was an aunt of the Hon. Henry L. Dawes, who has just closed a long career as United States Senator from Massachusetts. The family name was well sustained by James S. Whitney, who like his father Stephen, served in the state legislature. Indeed, it was the vote of James Whitney which decided the election of Charles Sumner to the United States Senate. James S. Whitney, who at first kept a country store at Conway, soon became a leader of the Democrats of Massachusetts; he was appointed by President Pierce superintendent of the Springfield Armory, and by President Buchanan collector of the port of Boston. Long previous to this he had organized the state militia, and had acquired the title of general, which he ever afterwards bore.

General Whitney had two sons, William Collins and Henry Melville. William Collins Whitney, the famous secretary of the navy under Cleveland's first administration, is a man whose name is known from one end of the country to the other almost as well as that of the president himself. In natural ability, the younger brother, Henry, is in no wise inferior.

He was born October 21, 1839, at Conway. After attending the public schools for a time, he was sent to Williston Seminary at Easthampton. Young Whitney was not, however, fond of study, and so at the expiration of a year he returned to Conway to work in his father's store. Soon he entered the Conway bank, where during a service of three years as clerk he began the development of those business talents which have since given him his power.

When General Whitney removed to Boston in 1860 to take up his duties at the customs house, Henry accompanied him. The young man passed two years in the Bank of Redemption, became clerk in the naval agent's office, and then engaged in the shipping business in New York City. In 1866 he came back to Boston to assume the agency of the Metropolitan Steamship Company, in which his father was largely interested. This company operated steamships which ran on the outside line between Boston and New York. In 1879 Mr. Whitney obtained control of the stock and became president of the company, a position which he holds to this day. By the time he had reached this presidency Mr. Whitney had demonstrated in a dozen different enterprises his superior executive ability and business capacity.

Early in 1866, Mr. Whitney, who had long foreseen the possible development of that part of Boston bordering on Brookline, purchased large tracts of land along the subur-

ban extension of Beacon street. In midsummer, when he found that he had invested \$800,000 in the enterprise, and that the load was more than he cared to carry alone, he formed the syndicate known as the West End Land Company. The next step was to build a street railway connecting the company's tract with Boston. For this purpose Mr. Whitney organized and headed the West End Street Railway.

The West End had been operating its eight miles of road but a few months, when the question of street blockades, which has long been a cause of annoyance in Boston, began to be more discussed than ever. At the time the Metropolitan, the Cambridge, the South Boston and the Consolidated, as well as the West End, centered in Boston. The streets of this city are so narrow and crooked that at best car blockades are almost unavoidable; but when companies whose interests clashed had to send many cars close together over the same tracks, the impossibility of hearty cooperation made blockades the rule rather than the exception. Something evidently had to be done, and Mr. Whitney was the man to do it. He planned and carried out the great undertaking, which was nothing less than the consolidation of all these lines.

It was in this same year, 1887, that the electric railway in Richmond, Virginia, attracted wide attention. Mr. Whitney, after going to Richmond to study the system, returned to Boston, convinced of the future of electric power. In the following year he tried both the underground conduit and the overhead trolley on a line between Park Square in Boston and the suburban town of Brighton. The part of the road operated by conduit proved to be a failure; and accordingly Mr. Whitney began to equip the West End lines with the trolley system. In February, 1889, twenty motor cars were put on the line from Bowdoin Square in Boston, to Harvard Square, Cambridge. So successful was this venture, that six months later Mr. Whitney gave to the Thomson-Houston Electric Company an order for six hundred additional motors.

It hardly need be added that since that time Mr. Whitney has done everything to keep the West End abreast of the times; he has watched for every new improvement and development in street railway operation, in the hope of more efficient service; he has tried costly experiments; he has met bitter opposition and borne it down by force of effectively presented facts, by pen and tongue—weapons of which he is a perfect master—and by deed as well he has successfully combated the popular prejudice that corporations have no souls. To enumerate the benefit these labors have brought to the community at large is, of course, impossible; but an indication of one phase of this benefit lies in the fact that suburban property reached by the West End system has enormously increased in value, in some cases having doubled and even trebled.

For a man of Mr. Whitney's tireless energy to confine himself to any one enterprise, no matter how extensive, would be an anomaly. Accordingly Mr. Whitney is now giving his attention to a dozen and one other matters, and in each he is highly successful. He is a trustee of the

Street Railway Review



HENRY M. WHITNEY,
President West End Street Railroad Company, Boston.



West End Land Company, president of the Neverslip Horseshoe Company, president of the Boston & Gloucester Steamship Company, president of the Hancock Inspirator Company, and president of the Dominion Coal Company, Limited.

His winter home is in Brookline, his summer home at Cohasset. In 1878 he was married to Miss Margaret Foster Green, by whom he has had one son and four daughters. His large fortune enables him not only to maintain a beautiful home, but to give much to various charities.

ELECTRIC CAR HEATING.

ALTHOUGH the electric car heater days are over now for a few months the wise street car man will soon be planning for next winter, and one of the things worthy of his consideration is the electric heater of the Consolidated Car Heating Company, of 936

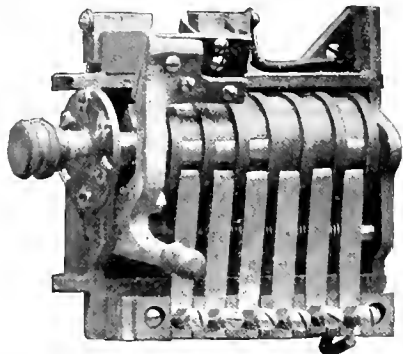

REGULATOR—FRONT VIEW.

Broadway, Albany, N. Y., and 200 Phoenix Building, Chicago. The essential features of the method of electric car heating exploited by this company are the large number of heaters used to a car, and the unusual amount of provision for regulating the heat. The plan is to put six of these heaters to a car—three under each seat, evenly distributing the heat near the floor where the passengers most need it. Cold air always comes in along the floor



EXTERIOR OF HEATER.

and at the ends of a car so that the wisdom of this distribution of heaters can not be doubted. The hot air from the heaters is obliged to pass up and warm the passengers instead of going up near the middle of the car. The heaters themselves consist of galvanized iron wire wound spirally on a suitably grooved porcelain cylinder. This is covered with an asbestos lined wooden box as shown in the engraving. The theory of the makers is

that an electric heater should be large enough to give the required amount of heat without necessitating a high temperature of the wire. The regulating switch may be

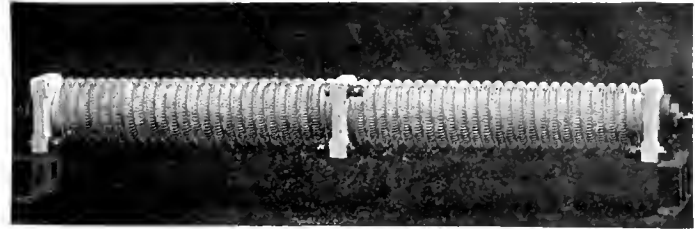

INTERIOR OF HEATER.— $\frac{1}{2}$ SIZE.

compared with the "series multiple controller" for motors. It has five points for regulating the intensities of the heat—the first position having all the heater coils in series and the last having them in multiple series of three. The maximum current at 500 volts is twelve amperes and the minimum two.

This regulator, which is shown in our three engravings, is so fixed that the connection with the trolley is broken while the handle is in motion from one point to another, so preventing sparking and decreasing danger from shocks. As to cleanliness these heaters are unsurpassed. The heating surfaces are porcelain and galvanized iron, and the temperature is so low that nothing can be scorched thereby.



OUTSIDE OF REGULATOR

In regard to the energy necessary to heat a car, the makers believe that it has been underestimated in the past, but that with a little more current, and an even dis-

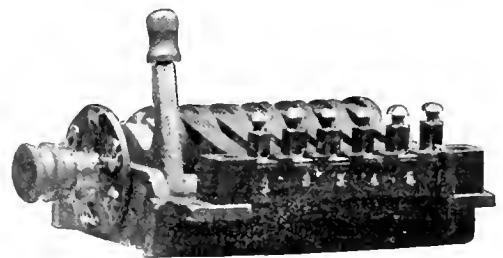

REGULATOR—SIDE VIEW.

tribution of heat, electric heaters will become still more favorably known. The original idea with regard to electric heating was that its possibilities of even distribution would help to compensate for its expensiveness, but the Consolidated Car Heating Company seems to have been the first to embody this idea in a practical form.

STREET RAILWAY LAW.

EDITED BY MR. FRANK HUMBOLDT CLARK, ATTORNEY AT LAW, CHICAGO.

Passenger Failing to get Transfer Ticket:

A passenger who fails to ask or obtain any written transfer or other evidence of his right to ride in a street car which he enters, after leaving one in which he has paid fare, may be lawfully ejected if he refuses to pay fare therein, and the conductor is not obliged to take the passenger's statement as evidence of his right to ride.

Grant, J., delivered the opinion of the Court:

Plaintiff entered one of defendant's cars on Michigan avenue, going west, intending to go to Thirty-third street; he paid his fare to the conductor. The car he took did not go to Thirty-third street, but stopped at defendant's barns, near the railroad crossing. This was near the city limits, and it appears that only certain cars went the entire distance. Upon the stoppage of the car the driver unhitched his horses, and was driving them to the opposite end, when plaintiff, perceiving this, said to the conductor that he desired to go further. To this, the conductor replied: "You can go back in this car, and take the next car up, or get off here, and take the next car up." Plaintiff decided to get off there. A car soon came from the barns, and started westward. Some employee asked him if he was going on that car, meaning evidently to ask whether he intended to return to the city on the same car. The terminus of the road was but a short distance from the barns, and plaintiff's destination was only five blocks from where he alighted from the first car. Plaintiff replied, "No," that he had come up on another car. He was then informed that he would have to pay. This he declined to do. Meanwhile the car had gone about two blocks. He was then told that he must pay or get off. One of the plaintiff's employees then approached him, took him by the lapel of his coat, and thereupon he alighted from the car. No force was in fact used, other than this, and plaintiff claims no injury except to his feelings. Plaintiff did not ask for a "change-off" from the first conductor, nor did the conductor offer him one. Plaintiff brought an action of tort to recover for his alleged unlawful and forcible ejection from the car. The learned court sustained his right to recover, and directed a verdict for nominal damages, holding that it was plaintiff's duty to pay his fare and save any injury to his feelings.

It is insisted by the plaintiff that he had a valid contract for carriage from the point where he took the car to Thirty-third street, and that his ejection from the car was therefore unlawful and tortious. If it be granted that he had such a contract, still he had no evidence of it, except his own statement, and the question is, "What was his duty under the circumstances?" If the conductor was under legal obligation to accept his statement that he had such a contract, then his removal was unlawful; otherwise it was not. Counsel has cited no authority, nor have I found one which holds that a stranger may enter the car of either a railway or street car company without any evidence that he has paid his fare, and secure passage by his own statement to the conductor that he has

positively paid it to some other authorized agent. It is the duty of the passenger to secure evidence of such payment, or to pay when his fare is demanded. The business of such companies cannot be carried on upon any other basis. This certainly is common sense and experience.

It is apparent that in the present case plaintiff possessed no other or different right from that which he would have possessed had he procured evidence of payment, which had been lost or destroyed. In the one case his contract to ride would be complete, but the only written evidence he had would be lost, while in the other his contract might be equally good, but he had neither asked nor obtained any evidence thereof to show to the conductor in charge of the other car or train, which must serve as a voucher in his settlement with the company.

(Sup. Ct. Mich. *Mahoney vs. Detroit Street R. Co.* 18 L. R. A. 335.)

(NOTE.—It is held that under the ordinances of the city of St. Paul, when a passenger is given a transfer check that fails to designate a route on which it is to be used, he is entitled to transportation on any connecting line. Supreme Court of Minnesota. *Pine vs. St. Paul City R. Co.* 2 Street Railway Review 358. In the case of *Heffron vs. Detroit City R. Co.*, 2 Street Railway Review 640, the Supreme Court of Michigan sustained a regulation of the street railway that transfer slips should be used within fifteen minutes of the time designated.—ED.)

Injury to Workman in Street—Negligence of Street Car Driver.

At the time plaintiff received the injuries complained of, he was engaged with other workmen in the employ of the City of New York in laying water pipes near the defendant's railway track. A cut had been excavated to the depth of about four feet for the purpose of receiving a six-inch pipe twelve feet long and weighing about four hundred pounds. Plaintiff's fellow workmen had placed the pipe in close proximity to the cut with the hub end of the pipe against the track, when one of defendant's cars came along, and the step of the car struck the hub end of the pipe and whirled it around over and across the cut. At this time the plaintiff was standing between the cut and the pipe at a point near the middle of the pipe, with his back to the approaching car, when the pipe thus put in motion struck him on his feet and caused the injuries under consideration.

It was not claimed on the trial that plaintiff was guilty of contributory negligence. A careful examination of the record fails to disclose evidence of any negligence whatever on the part of the plaintiff. The circumstances of the case as developed by the testimony warranted the trial court and jury in concluding, as the conduct and result of the trial indicate they must have done, that the plaintiff was free from any fault contributing to the injury. It was the duty of the plaintiff to prove by satisfactory evidence that he did not contribute to the injury by any negligence on his own part, and this requirement of the law of negligence was fairly met.

The evidence does not disclose negligence on the part of the fellow workmen of plaintiff. It was necessary for them to have the pipe where it was, that they might place it in the cut which had been prepared for it, and so far as appears from the evidence, they did what they could to avert the accident. Any reasonable and temporary occupation by them of defendant's tracks was justifiable, and could not be made the basis of a charge of negligence. A street railroad has not the *exclusive* right to the use of its tracks, but simply a *paramount* right and the *preference*. While a person may not recklessly, carelessly, or wilfully obstruct the passage of the cars of a street railroad, he is not bound to keep off the tracks, and if he fairly and in a reasonable manner respecting the paramount right of the railroad company temporarily obstructs the track when necessarily engaged in the prosecution of a lawful business, and is without fault on his part injured by negligence chargeable to the railroad company, he may maintain an action for his damages.

The superintendent of the defendant testifies that he had placed a watchman at this point when the cut came near to defendant's tracks, to look after the interests of the company, and "see that our horses got safely by the opening, and that there were no obstacles in any way." At the time of the accident this watchman was temporarily absent. The car came along and passed the cut at the rate of six miles an hour, and continued on its course without stopping. A fellow-workman of the plaintiff, apprehending danger, put up his hand to stop the approaching car; if it was seen by the driver it is certain that he did not heed it.

The act of the driver of defendant's car in approaching and passing this point where the conditions were such as to cause the defendant to apprehend danger and consequently place a watchman on guard, at the rapid rate of speed at which the uncontradicted testimony shows he was driving, together with the other circumstances disclosed by the evidence, warranted the jury in concluding that the driver was guilty of negligence.

(Superior Court N. Y. *Lahey vs. Central Park & R. Co.* 8 N. Y. L. Jour. 1431.)

Street Railway Franchise—Advertisement and Sale by City.

A franchise granted to a street railway company under a city charter requiring publication of the terms and specifications of the franchise, is void as to a street sixteen blocks in length not mentioned in the publication, although such street was substituted for one mentioned in the publication, on which tracks had already been authorized.

Power given by a city charter to authorize the use of the streets for "horse and steam railroads," before electricity came into use as a means of propulsion, authorizes the city to grant a franchise for operating a street railway by electricity on the trolley system.

(Sup. Ct. La. *Buckner vs. Hart.* 52 Fed. Rep. 825.)

Injury to Person Crossing Street—Negligence of Employee of Street Railroad.

Plaintiff, while crossing a street, was injured through the alleged negligence of an employe of defendant cable car company, who, it was claimed, so carelessly threw down a crow-bar that it struck plaintiff. Plaintiff did not cross at a regular crossing, because it was muddy, but was passing diagonally over the street. *Held*, That evidence that it was very unusual for women to cross the street at this point was properly admitted. Such evidence was not competent for the purpose of showing contributory negligence in plaintiff, for she had the right to cross there; but was admissible to show that a greater degree of caution was required on her part than if she had crossed at the usual place.

(Sup. Ct. Mo. *Henry vs. Grand Ave. R. Co.* 21 S. E. Rep. 214.)

Rights Under Charter—Abandonment of Franchise—Contract with City.

A street railway company which, under authority of its charter, had constructed and operated street railways on certain city streets, entered into a contract with the city to re-establish itself with electric power instead of animal power within two years. One of the streets included in the contract had been used by the company for a spur track and turn-table only, and in the construction of the new tracks no track into that street was laid or was proposed until after the company had obtained the surrender to itself of bonds deposited with the city as security for compliance with the contract. *Held*, that these facts, the two years limited by the contract not having expired, did not show an abandonment of such street by the company, nor preclude it from making use of the street at any time within the two years to the full extent of the right granted by the charter.

(U. S. Cir. Ct. W. D. Tenn. *Citizens' Street R. Co. v. City of Memphis.* 53 Fed. Rep. 715.)

Street Railroad—Damage to Franchise by Construction of Sewer—Rights of Mortgagee.

The location of a sewer in a city street must be reasonable with respect to the rights of a street railway the construction of which was authorized by a prior ordinance and whose property might be damaged by the construction of the sewer; and such location, if made in a part of the street occupied by the railway so as to compel it to suspend operations or inflict great damage upon it, is unreasonable, when other parts of the street are equally suitable for the sewer.

A mortgage upon a street railway is as much entitled to protection from unlawful injury by such action on the part of the city, as any other property.

(U. S. Cir. Ct. D. Wash. *Clapp v. City of Spokane.* 53 Fed. Rep. 515.)

Failure to Keep Street in Repair—Action by Person Injured—Alighting from Moving Car.

A street railroad company which has contracted with the city as a consideration for its franchises, to keep a

portion of its streets in good order and repair, is responsible in a direct action by any person who suffers special injury from its unlawful failure to do so.

It is well settled that it is not negligence *per se*, or as matter of law for a person to get on or off a horse car while it is in motion; but the question of negligence depends upon the circumstances of each particular case, such as the speed of the car, the activity or infirmity of the person, and the like.

A petition claiming damages from the railroad company bound to keep its streets in repair, resulting from plaintiff's stepping into a hole in the crossing, dangerous and negligently left by the company, notwithstanding full notice, is not amenable to the exception of no cause of action, because it recites that the injury resulted while plaintiff was alighting from the car moving slowly and with slackening speed prior to stopping. And also that

plaintiff was an active and vigorous person accustomed to alight in this way, and showing no unfavorable conditions tending to render the act exceptionally rash or hazardous.

(Sup. Ct. La. Ober vs. Crescent City R. Co., 11 S. Rep. 818.)

Negligence of Street Car Driver—Evidence of what occurred when Passenger Boarded the Car—Injury when Alighting.

In an action against a street car company to recover compensatory damages for personal injuries alleged to have been caused by the sudden starting of the car while plaintiff was alighting, evidence as to what occurred when plaintiff got on the car, tending to prove malice on the part of defendant's driver, is inadmissible.

(Sup. Ct. Wis. Grisim vs. Milwaukee City Ry. Co. 54 N. W. Rep. 104.)

A SUBURBAN POWER PLANT.

WE illustrate from the architect's perspective a power station recently designed by Westinghouse, Church, Kerr & Co., engineers, for the Newton & Boston street railway, Newtonville, Mass. The especial interest attaching to this design, is from the fact that it was originally prepared in view of the location of the station on an attractive residence street

The proposed location of the station was such as to make desirable a neat building in harmony with the general surroundings, but without involving any considerable increase of cost. The entire annihilation of smoke was an imperative consideration. An iron stack with guy rods was inadmissible from its vulgarity, and a brick chimney stack, always expensive, was particularly so in

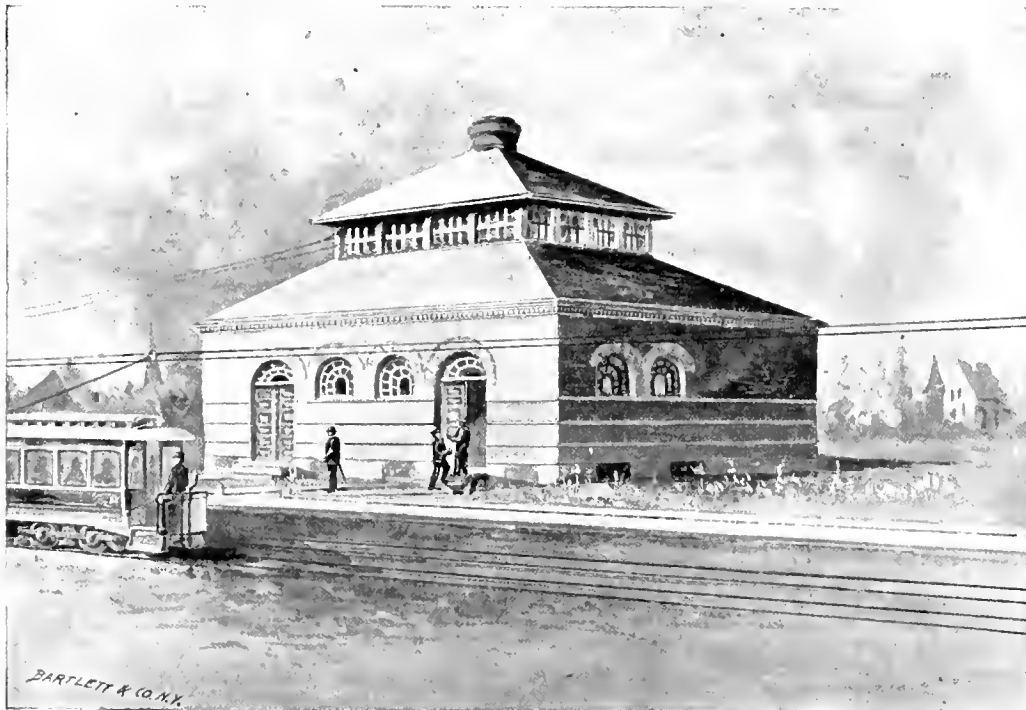

in one of the most beautiful suburbs of Boston. A lot was subsequently determined upon where space and appearance was not important, and the station was re-designed and constructed on a different plan. There is enough that is unique and suggestive in this preliminary design to warrant its publication, notwithstanding the fact that it was not carried out in this form.

this instance, from the uncertain nature of the foundations. The plan was finally worked out so as to effectively conceal the chimney stack, and, indeed, to so disguise the building, that while retaining the general appearance of practical solidity appropriate to its work, it should at the same time in its suburban architecture be suggestive of a pumping station, if not of a public library.

The outside dimensions of the building are 55 x 58 feet, which space serves to contain a generating plant of 580 rated horse-power with relay boiler capacity, economizer, stack, condenser, and all the usual auxiliaries. The building is 20 feet in height to the roof line, rising to a total height of 40 feet at the top of the stack. The walls are faced with cream-colored brick with blue stone trimmings. The roof is of iron, inexpensive in construction, from the fact that the building is divided by a parti-wall between the engine and the boiler-room, thus reducing the span of the truss one-half. The roof hips from the corners, and is slate covered and finished on the inside with wire lath and plaster. A monitor, 28 x 30 feet, affords abundant light and ventilation to both the engine and boiler-room, and at the same time makes a convenient tower from which to lead away the feeder wires. The latter are accessible from an interior iron gallery, reached by an iron wall-ladder. As this power house was to be located on a street on which there was much pleasure-driving, it was thought best to make the machinery invisible from the street, and so avoid the frightening of horses. To this end, the windows were raised to a height of 8 feet above the floor-line, and were effectively treated from an architectural standpoint to harmonize with the general subject.

The generator-room, 28 x 53 feet contains one 100 horse-power and three 160-horse-power "Kodaks," any piece of which can be handled from an overhead trolley-fall and tram. In this particular station it seemed necessary to have one small unit of 100-horse-power available for the all-night service demanded by the residence character of the city. Ample space is left at one end of the room for the switchboard and for the engineer's desk.

Passing from the engine-room, we first come to the pump-room, containing two independent condensers, double feed pumps, and a fore-heater for condensing the exhaust from the auxiliary pump cylinders, condensers, etc. The boiler-room, 27x53 feet, contains four hori-

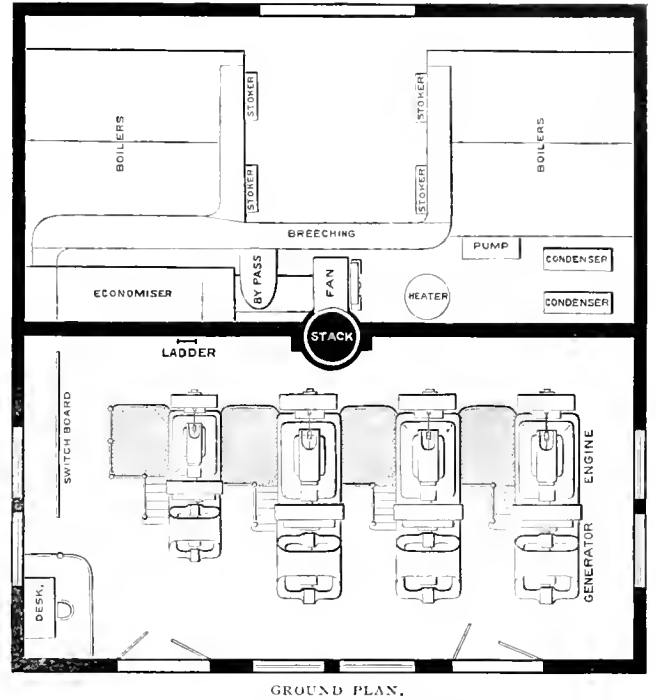

zontal return tubular boilers, to carry 125 pounds steam pressure, (Babcox and Wilcox boilers were subsequently used, three of which represent the capacity of the entire plant, the fourth being relay. Each of these boilers is fitted with a Roney mechanical stoker for the purpose, in part, of securing the necessary smokelessness, and in part, for the sake of its superior economy in burning cheap mixed fuels. No coal or ash handling machinery was employed on account of the small size of the plant.

The smoke connections from all four of the boilers unite and pass to the rear of an economizer, through which the gases are drawn by a large, slow running exhaust fan, driven by an independent engine using about 1/2-horse-power. The smoke connections are heavily covered with non-conducting material, in order that all heat of the boiler gases may be utilized in the economizer. A by-pass is provided direct from the breeching to the fan inlet in case of repairs to the economizer. The fan discharges directly up into the bottom of a stack 5 feet in diameter, and lined with one course of common brick. The stack is of steel and supported on an entablature carried in the parti-wall; the base of the stack being 10 feet six inches above the floor line. The stack is in the exact center of the building, in order that its top shall appear as a finial at the peak of the monitor roof. In this position, one-half of the stack shows in the generator-room, where it is covered with non-conducting material, and painted to correspond to the walls.

The general plan here shown, is one on which, with appropriate variations, all Kodak stations can safely be

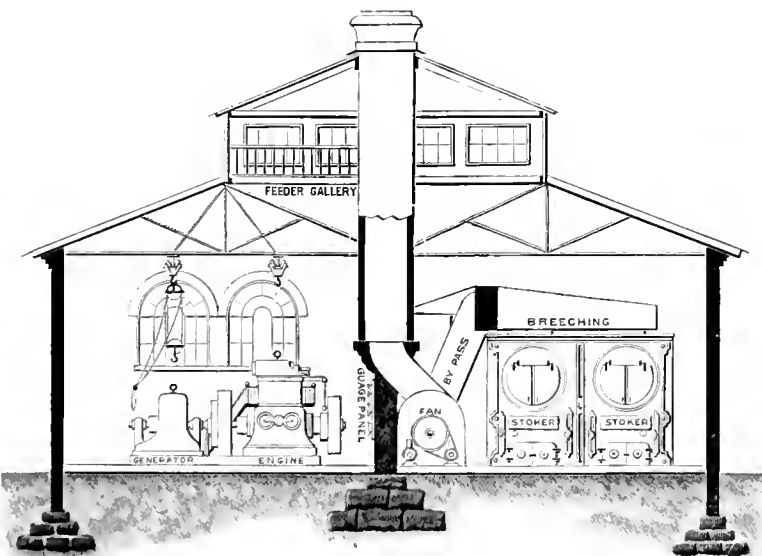

ELEVATION OF POWER PLANT.

The interior walls are left in the plain finish of the brick and painted. On the pilaster underneath the chimney stack is displayed a black marble gauge board, containing a clock, steam and vacuum gauges, and a manometer gauge showing the draft in the stack.

based. The cost of the building is reduced to a minimum; other things being equal. The defect of this particular type of building is, that it does not admit of ready extension, and is, therefore, in the form here shown, desirable only when the ultimate capacity of the plant can be safely pre-determined. For this reason, as much as any other, it was finally decided to locate the power station of this particular road in a less conspicuous position, and re-design the plant on different lines, so that indefinite extension could be provided for to meet the unknown growth of suburban railway traffic.

WHERE HORSES RIDE.

WE are able to illustrate, this month, one of the most amusing features of rapid transit in the world—a street car line upon which the horses as well as passengers ride. The fortunate quad-



WHERE HORSES RIDE.

rupeds illustrated were photographed as they stand on every trip down the grade of Thirty-fourth avenue, Denver.

This line was built by Col. J. Cook, Jr., a live real estate man, in order to give direct communication with the Welton Street Cable Line, from Mr. Cook's new addition to Denver, Col.

The line is about 1½ miles long, and the grade varies from 2 to 5 per cent. As the entire line is on the grade, Col. Cook concluded that it was simply a waste of good horse power to have the animals walk down hill, and so arranged the little platform stock car to accommodate the equines in their descent. The car is built of ash, shorter than the 16-foot box trailer, and runs on light 12-inch wheels. It is very light in weight. A gate at either end allows the horses to walk on to the car at one end and off at the other. The horses soon become used to the ride and enjoy it hugely, smiling large expansive smiles frequently, and sometimes bursting out in a horse laugh when some fellow equine observes their aristocratic

prominence. Although the descensus is extremely facilis, the up trip is proportionately difficult. The car runs from 6:30 a. m. to 11:30 p. m. The traffic on the line is good, as the novelty of the affair attracts many strangers and much of the pleasure seeking populace of Denver.

A similar line is in operation at Ontario, California, but the Denver line will attract the most attention from the fact that it is a city line.

A MIGHTY SYNDICATE.

THE age of syndicates has produced many changes in street railway management and affairs until the outsiders are fain to enquire, Where are we at? New Jersey laws seems favorable to the formation of combinations, and the latest report brings news of the formation of the New England Street Car Company, with

a capital of \$5,000,000, which may be increased to \$50,000,000.

The list of directors includes the names of many prominent New England capitalists. The principal ones being as follows: John R. Bullard, president of the Dedham, Mass., Savings Bank and National Bank; Jas. C. Etmo, president of the Shoe & Leather National Bank, at Boston; Col. J. H. Cummingham, banker of Chelsea, Mass.; W. B. Ferguson, president of the Gloucester Street Railway, Gloucester, Mass.; W. H. Leonard, banker, of Boston; Dr. A. F. Mason, capitalist; Mayor A. C. Pond, president New Haven & West Haven Street Railway Company; A. R. Mitchell, of the New England Trust Company, Boston; T. T. Robinson, of the West Leicester & Spencer Street Railway Company, Boston; Jas. B. Dill, of Dill, Chandler & Seymour, New York, counsel of the company.

THE early advent of fine spring weather has been very favorable to construction work.

READING ROOMS.

THE railroad department of the Young Men's Christian Association of Minneapolis is making a special effort to interest the men in the employ of the Twin Cities Rapid Transit Company. No difference is made between conductors and motor men and the shop and office men.

The meetings and lectures take practical turns upon air brakes, train orders and like subjects, and all the leading technical papers are kept on file in the reading room, including, of course, the STREET RAILWAY REVIEW. Theo. F. Judd, the secretary, a practical and able man, has charge of the work.

RAPID TRANSIT IDYL.

"Move up," the fierce conductor cries,
 And the man in fear obeys;
 But the woman fashionably garbed
 Reposes nowadays,
 And the man will hardly blame her
 However much he grieves—
 For she needs a couple of seats at least,
 Or she will spoil her sleeves.
 --New York Recorder.

PRIZES FOR EFFICIENT WORK.

THE new management of the East Cleveland Railway has adopted a system of prizes, which President Henry A. Everett thinks will be conducive to the betterment of the service. The total sum to be divided is \$3,000. Fifteen hundred dollars will be distributed July 1, 1893, and a like amount January 1, 1894. Ten first prizes of \$50.00 each will go to motormen making the largest number of miles run to July 1, free from accident, under the rules of the company.

A similar offer is made to the conductors, with the same conditions. The second prizes will be ten in number, of \$25 each, for the motormen, with the same number of the same amount for conductors. The prizes will be awarded by three judges, one chosen by the company, one by the employes and one by these two. In event of disagreement on the third judge the Senior Justice of the Court of Common Pleas will name the third man.

President Louderback has inaugurated a prize system on his Davenport, Iowa, lines, and has regular monthly drawings. There are two first prizes of \$10—one for conductors, the other for motormen; also a second prize of \$5 for each. The prizes are awarded to conductors for getting all fares promptly; keeping neat and accurate trip reports; politeness to passengers; personal neatness; helping motormen to gather up as many passengers as possible; helping motormen to keep car on schedule time, and general observance of company's rules. The results of only a few months' trial have stimulated the men to a much improved discipline, and the improvement is noted and appreciated by the public.

SMITH, OF NEW YORK.

IT is very much to be suspected that the author of "Mr. Barnes of New York," "lifted" the very taking title of a very taking book from an advertisement that has become a household word to so many managers throughout the country and which has appeared in every number of the STREET RAILWAY REVIEW, namely, Smith of New York.

Coeval with the pioneer Stephenson, Willard H. Smith, of New York, began the manufacture of street railway specialties on the site occupied at present by Lord & Taylor's Grand-street store. This was in 1842. People



CHARLES G. SMITH.

traveled in primitive manner then and were lighted in a primitive way by primitive lamps made by the pioneer, Willard H. Smith. They thought it was all very fine, and so it was for the times, but what a change from style No. 1, if there was such, to style No. 50! From a whale oil beacon to a grand combination electric and kerosene illuminant! The cars then, have been illustrated by this magazine and the only regret is that we cannot show also the evolution of car lighting.

Mr. Smith of New York, was an honest, upright man and fruits of honesty and uprightness came to maturity with the extension of street railways until where ever on this round globe street cars are known, Smith of New York is known also.

From Grand street, New York, Mr. Smith moved his factory to 42 and 44 Fulton street, Brooklyn, the older quarters becoming too small for a rapidly increasing trade. The factory was first established in 1842, but in 1869 a second call for more space made Mr. Smith seek room more according to his strength. So the five story building at 350 to 352 Pearl street, New York, was

schools and his business training in his father's office. Having thus mastered the essentials of the trade, he spent eight years in extensive travels through the United States and Canada, seeing all that is of interest and profit in our wonderful country.

Mr. Smith is an active, energetic and accomplished business man. His capabilities are not alone those of an

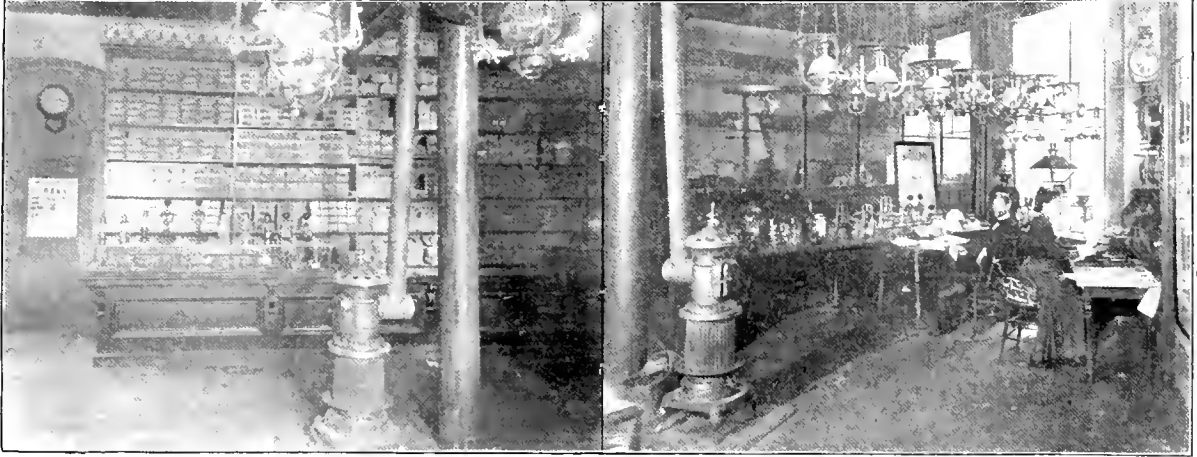

OFFICE AND GENERAL SALES ROOMS, SMITH FACTORY.

secured, and from that day to this, 24 years, the Smith manufacturing interests have there resided. From this factory lamps have gone to the four corners of the earth and nations in darkness have been able to read the evening newspaper on their way home on account of the enterprise and workmanship of Smith, of New York.

Besides being undoubtedly the first manufacturer of street railway lamps, Smith of New York, claims the introduction of the center lamp in street cars.

Willard H. Smith died December 5, 1882, and upon

office man and manager but as a commercial traveler and inventor. In the former vocation he has been a distinguished success, having sold one of the largest bills of goods ever contracted for at one time in this line, namely, \$6,000 worth to the West End Street Railway Company, of Boston, shortly after the consolidation of that system. In the latter mentioned role he has devised and patented a number of improvements in the car illuminating line.

A STREET RAILWAY REVIEW artist obtained the views herewith given of the Smith factory. The first en-

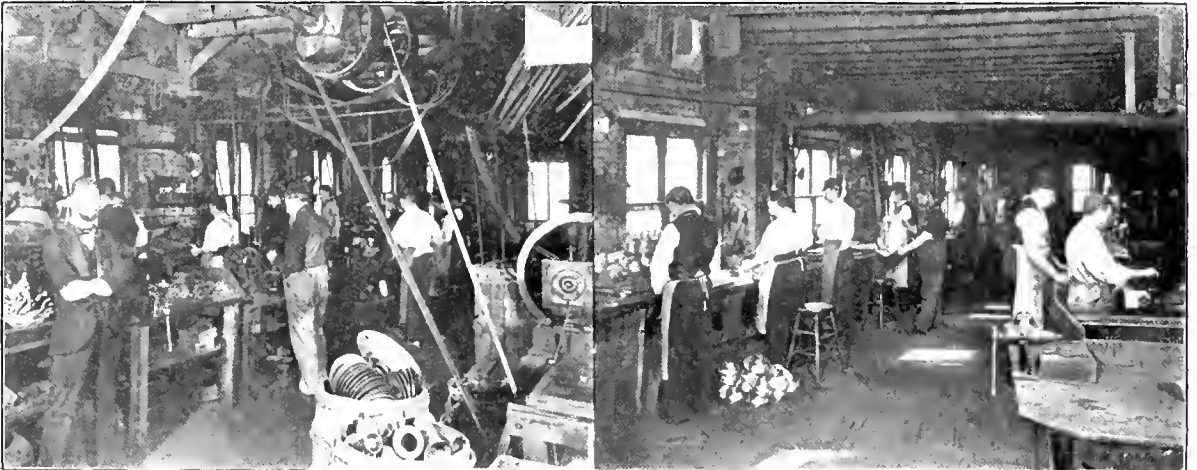

SCENES IN THE SMITH FACTORY.

his demise his widow, Mrs. Josephine D. Smith and his son Charles G. Smith, took up the business. The active management of course devolved upon Charles G. Smith, who was born in 1861, and was therefore but 21 years of age at the time of his father's death. Charles G., however, was well fitted to follow in the business, having obtained his education in the excellent Brooklyn public

graveing represents the neat office with its display of lamps and fixtures, while to the left is the sample room, whither the purchaser is conducted to make his selections from the stock. The engraving of the operating rooms of the factory give only selections of the busy place where so men are employed, giving light to the world that would otherwise perhaps travel in darkness.

CAUGHT ON THE RUSH TRIP.

American Street Railway Association.

D. F. LONGSTREET, PRESIDENT, Denver, Col.
 DR. A. EVERETT, FIRST VICE-PRESIDENT, Cleveland, O.
 JOEL HURT, SECOND VICE-PRESIDENT, Atlanta, Ga.
 W. WORTH BEAN, THIRD VICE-PRESIDENT, St. Joseph, Mich.
 WM. J. RICHARDSON, SECRETARY AND TREASURER, Brooklyn, N. Y.
 EXECUTIVE COMMITTEE—THE PRESIDENT, VICE-PRESIDENTS, and JOHN G. HOLMES, PITTSBURG, Pa.; J. D. CRIMMINS, New York City; THOS. MINARY, Louisville, Ky.; JAS. R. CHAPMAN, Grand Rapids, Mich., and BENJ. E. CHARLTON, Hamilton, Ont.
 Next meeting, Exposition Building, Milwaukee, third Wednesday in October.

Massachusetts Street Railway Association.

President, CHARLES B. PRATT, Salem; Vice-presidents, H. M. WHITNEY, Boston, AMOS F. BREED, Lynn, FRANK S. STEVENS; Secretary and Treasurer, J. H. EATON, Lawrence.
 Meets first Wednesday of each month.

Ohio State Tramway Association.

President A. E. LANG, Toledo; Vice-president, W. J. KELLY, Columbus; Secretary and Treasurer, J. B. HANNA, Cleveland; Chairman Executive Committee, W. A. LYNCH, Canton, O.
 Meets at Cincinnati on the fourth Wednesday in September, 1893.

The Street Railway Association of the State of New Jersey.

President, JOHN H. BONN, Hoboken; Vice-president, THOS. C. BARR, Newark. Secretary and Treasurer, CHARLES Y. BAMFORD, Trenton; Executive Committee, OFFICERS and C. B. THURSTON, Jersey City; H. ROMAINE, Paterson; LEWIS PERLINE, JR., Trenton.

The Street Railway Association of the State of New York.

C. DENSMORE WYMAN, PRESIDENT, New York.
 D. B. HASBROUCK, FIRST VICE-PRESIDENT, New York.
 JAS. A. POWERS, SECOND VICE-PRESIDENT, Glen Falls.
 W. J. RICHARDSON, SECRETARY AND TREASURER, Brooklyn.
 EXECUTIVE COMMITTEE.—D. F. LEWIS, Brooklyn; JOHN N. BECKLEY, Rochester.
 J. W. McNAMARA, Albany.
 The next meeting will be held at Rochester, September 19, 1893.

Pennsylvania Street Railway Association.

JOHN A. COYLE, PRESIDENT, Lancaster.
 JOHN G. HOLMES, VICE PRESIDENT, Pittsburg.
 H. R. RHODES, SECOND VICE-PRESIDENT, Williamsport.
 L. B. REIFSNIEDER, SECRETARY, Altoona.
 WM. H. LANIONS, TREASURER, York.
 Next meeting, Harrisburg, September 6, 1893.

Alabama.

MOBILE, ALA.—Light and railway companies consolidate as the Mobile Light & Railway Company. Officers, John Wilson, of Leavenworth, Kansas, president; J. H. Wilson, of Mobile, vice-president and general manager, and A. J. Peaper, secretary.

MOBILE, ALA.—R. Semmes, of the Street Railway Company, has made all his electrical contracts in New York.

Arkansas.

PINE BLUFFS, ARK.—Car house of Citizens' Street Railway burned with seventeen new cars, harness, tools, etc. Loss \$20,000, insurance \$2,000.

Canada

TORONTO, CAN.—Toronto & Scarboro Electric Railway will build two miles of road from Woodbine. Tenders called for.

California.

YUBA CITY, CAL.—Marysville and Y. C. Railway Company granted franchise over city streets.

Chicago.

CHICAGO.—Organized: American Reflector & Lighting Company by Perry Landis, W. A. Toles, Robert L. Tatham.

CHICAGO, ILL.—Incorporated: The American Car & Railway Construction Company; capital stock, \$1,200,000; for the manufacture of rolling stock, appliances, and supplies for railways. Incorporators, Watson Tranter, William A. Conover, and J. G. Wolf.

CHICAGO.—The Jefferson Railway ordinance has been recommended for passage.

The Chicago & Englewood Electric Street Railway ordinance amended and recommended for passage.

Southwest Chicago rapid transit ordinance passed.

Chicago & Hammond Railway Company granted its franchise.

CHICAGO.—Organized: The Citizens' North Side Rapid Transit Company; capital stock, \$5,000,000. Cable or underground, electric cable or elevated railways in Chicago, by Edward A. Blake, 362 Dearborn, Augustus Neuman, J. L. Flannery, A. W. Ring, R. S. Elder, John C. Morper, and William Hudson.

Colorado.

DENVER, COL.—The Arapahoe County Railway asks for franchise to the business district of Denver.

DENVER, COL.—Franchise granted the Denver & Westminster Railway to use horse, cable, or electric. H. T. Mayham and J. W. Downing give \$10,000 bond.

DENVER, COL.—The Coalfax council grants town franchise to the Denver, Lakewood & Golden.

TRINIDAD, COL.—It is reported that the new company here will extend to Starkville and Sopris; \$50,000 is to be subscribed here.

Delaware.

DOVER, DEL.—The Peninsula Electric Railway, Light & Power Company asks incorporation. Wants to run line of railway the whole length of the state and establish light and power plants.

LONACONING, DEL.—J. H. Johnway, Jr., and J. Oliver Stokes, of New York City, and J. J. Bell, of this place, have laid out electric line here.

WILMINGTON, DEL.—Permits issued to the Traction Company to build on Thirteenth and Fifteenth streets and to Gray's Ferry.

Illinois.

ALTON, ILL.—New electric railway people will make several extensions.

AURORA, ILL.—The street railway will run cars to Elliott Grove next summer.

CENTRALIA, ILL.—President S. N. Pierce, of this city, is vigorously working for the Centralia-OJin road.

COLCHESTER, ILL.—The Colchester Electric Light & Power Company increases its capital to \$12,000.

JOLIET, ILL.—The Joliet Street Railway Company has increased its capital stock to \$300,000 for the purpose of improvements and extensions.

JACKSONVILLE, ILL.—Organized: The Springfield, Jacksonville & Winchester Electric Railway. Principal office here. Jas. F. Self, Geo. F. Huffaker, Warren Case, Jacksonville; John Gibbs, Scott County, and S. S. Dewes, Alexander.

PEORIA, ILL.—The Wyoming Electric Light & Power Company, at Peoria; capital stock, \$15,000; operate electric light plant in Wyoming, Ill., furnish light heat, and power; incorporators, E. B. Hillman, H. T. Hays and L. B. Bradley.

PEORIA, ILL.—Property owners subscribe \$18,000 for a line on Elizabeth street and appoint J. W. Hill, Delos Brown, H. T. Cotes, L. A. Houghton, W. C. Edwards and R. M. Hanna a committee to arrange with any company or person for building and operating the line.

PONTIAC, ILL.—Incorporated: The Pontiac Electric Light, Heat & Power Company; capital stock, \$40,000; incorporators, Henry A. Foster, C. M. Hamilton and A. P. Foster.

SPRINGFIELD, ILL.—The City Railway sold to a syndicate represented by G. Van Ginkle, of Des Moines, Ia., and C. K. Minary, of Louisville C. K. Minary will be general manager.

Indiana.

EVANSVILLE, IND.—A new car shop and repair shop is to be built by the company here about April 1.

GOSHEN, IND.—Indiana Electric Power Company granted franchise for electric here. Company will run independent lines to Elkhart, Ten miles distant.

JEFFERSON, IND.—The Jefferson Electric Company has incorporated with a capital stock of \$20,000; officers are George Grimm, president; Jos. Stoppenbach, vice president; Geo. J. Kispert, treasurer.

LOGANSFORT, IND.—The Logansfort Electric Street Railway has secured right-of-way to fair grounds. The same company will build a new power house soon.

MARTINSVILLE, IND.—H. Stevenson, of Indianapolis, is here to survey and plan for thirty miles of electric to Indianapolis. Eastern capital.

MUNICE, IND.—Lew Wallace, Jr., of New York, representing Munsie Motor Line, asks for more franchises and permission to electrify.

PERU, IND.—The Peru Street Railway Company regularly incorporated by H. Brownell, R. A. Edwards, R. H. Bouslog, G. H. Geves and W. S. Mercer. The Elmwood Land and Improvement Company, of Miami county, filed articles with \$40,000 capital stock. The directors of it are the three first named directors of the Peru Street Railway Company.

PERU, IND.—Peru Street Railway Company organized by R. A. Edwards, president; S. C. Mercer, vice-president; R. H. Boustog, secretary, and C. H. Brounell, treasurer. The capital stock of the company is \$50,000. The company is to give the city a bond for \$10,000 before beginning work.

RICHMOND, IND.—Isaac A. Gorman is the new superintendent of the street railway. Four miles new track is to be laid shortly.

RICHMOND, IND.—The street railway here sold by J. C. Shaffer to St. Louis parties. John F. Miller, of this place, will probably be superintendent and extensions and betterments will be made.

Iowa.

DUBUQUE, IA.—Allen & Swiney lines sold to the Old Colony Trust Company for \$225,000. Company will be re-organized and entire new equipment supplied. Some say this means consolidation. J. S. Cummings and Joseph Burry, both of Chicago, represent the Old Colony and the General Electric.

FT. DODGE, IA.—E. G. Larson, et al., apply for electric railway franchises.

IOWA CITY, IA.—The Haines brothers and Sam. J. Tilden, Jr., of New York, through their attorney C. S. Ranck, of this place, asks street railway franchise.

MUSCATINE, IA.—T. L. SeEVERS has been made manager of the Street Railway Light & Power Company.

TOLEDO, IA.—T. L. SeEVERS, of Oskaloosa, Ia., has accepted the Toledo-Tamaa franchise and will build road soon.

WATERLOO, IA.—The Waterloo Street Railway Company contemplates electricity. G. A. Whitney, president.

Kansas.

ATCHISON, KAS.—President Chaliss says capitalists will buy dummy line on Main street. Will be equipped for the freight line. Steam dummies and freight cars needed.

JUNCTION CITY, KAS.—C. C. Adams, of Kansas City, with two hydraulic engineers and an electrician, were looking at the Fogarty dam and the electric railway route, and making estimates last week.

KANSAS CITY, KAS.—The L road will present ordinance for extensions.

KANSAS CITY, KAS.—The elevated filed acceptance of ordinance giving extensions.

WICHITA, KAS.—At last the electric street railway will extend to Linwood Park. The extension is to be made this summer.

WICHITA, KAS.—The Citizens' Electric Light Company and the Electric Street Railway Company consolidated. Chas. E. Dustin, of Hartford, Conn., president; J. W. O'Neill, secretary and manager.

Kentucky.

COVINGTON, KY.—H. H. Hardy and attorney Mack have been granted 20-year franchise on certain streets. Must operate in twelve months.

LOUISVILLE, KY.—The New Albany council will concede use of electricity to the K. & I Bridge Company. Col. B. H. Young says will begin immediately.

MAYSVILLE, KY.—U. S. Marshal, D. J. Burchett will sell the Maysville Electric, March 25, to satisfy damage claim of \$2,000. Road three and one-half miles, Westhouse system, seven, c.; Secretary R. A. Cochran.

Louisiana.

NEW ORLEANS, LA.—The Carrollton Railroad Company will apply for permission to extend to Southport.

Massachusetts.

BOSTON, MASS.—Lee, Higginson & Co., and other bankers in New England, offer subscription of \$5,000,000, Providence & Pawtucket Street Railway bonds, 5 per cents.

BROCKTON, MASS.—Four street railway companies organized: Brockton & Bridgewater Street Railway Company: Capital, \$200,000; directors, Hosea Kingman and J. C. Leach, of Bridgewater, Alfred A. Glasier, J. P. Campbell and Allston Burr, of Boston, J. H. Morse and H. B. Rogers, of Brockton. Brockton & Stoughton Street Railway Company: Capital, \$150,000; directors, Charles Tenney and George F. Walker, of Stoughton, Alfred A. Glasier, Geo. H. Campbell and Allston Burr, of Boston, J. P. Morse and H. B. Rogers, of Brockton. Brockton & East Bridgewater Street Railway Company: Capital, \$100,000; directors, Aaron Hobart and R. P. Harris, of East Bridgewater, Alfred A. Glasier, Geo. H. Campbell and Allston Burr, of Boston, H. B. Rogers and John R. Morse, of Brockton. East Bridgewater & Bridgewater Street Railway Company: Capital, \$100,000; directors, James C. Leach and Hosea Kingman, of Bridgewater, Aaron Hobart and R. O. Harris, of East Bridgewater, Alfred A. Glasier and Geo. H. Campbell, of Boston, H. B. Rogers, of Brockton.

CLINTON, MASS.—Meeting of the Clinton Street Railway Company at the office of Harold Parker resolved on the revision of franchise and beginning of work.

DARTMOUTH, MASS.—The Dartmouth & Westport Street Railway applies for franchise on Dartmouth streets.

WORCESTER, MASS.—Worcester Construction Company organized to build street railways and pave streets. Capital, \$20,000. Officers: President, C. A. Richardson; treasurer, C. O. Richardson; clerk, W. L. Kendall; offices in the Case Building.

Michigan.

BAY CITY, MICH.—Officers of the Bay City elected; W. B. McKinley, Chicago, president; H. H. Norrington, West Bay City, secretary.

DETROIT, MICH.—The Citizens' Street Railway Company will spend \$500,000 in betterments, especially new track work.

DETROIT, MICH.—The village of Royal Oak has given franchise on its streets to the Metropolitan Street Railway Company, of Detroit.

GRAND RAPIDS, MICH.—The North Park Electric Railway Company will make an important extension across the river. New bridge to be built. Entire cost of extension will be \$25,000. Geo. W. Thayer and C. C. Comstock director's committee.

PORT HURON, MICH.—J. H. White, F. L. Wells, L. A. Sherman, Harvey Sparling, S. T. Boyce, et al., granted exclusive franchises for an electric line.

PORT HURON, MICH.—L. A. Sherman, one of the promoters of the Port Huron-Marine City line says that the Grand Trunk is not interested and that the line has good prospects.

Minnesota.

DULUTH, MINN.—Duluth Street Railway Company will change all incline machinery this summer. E. P. Allis will put in the new plant. New track will be laid from Fourth to Superior on Twelfth.

DULUTH, MINN.—The Duluth lines have absorbed the Superior and West Superior roads.

ST. PAUL, MINN.—A. R. McGill, C. H. Pratt, W. W. Clark, A. C. Bruce, J. B. Jett, W. McMurrin, et al., will run an interurban to Minneapolis, electric. Twin City Rapid Transit Company agrees to proposition. Work to begin soon after April 1.

Missouri.

CARROLLTON, MO.—The council has granted a franchise to F. T. Crouch for a dummy line between Carrollton and the Wabash depot.

CARTHAGE, MO.—Ordinance granting C. L. Bartlett electric lights on Carthage streets passed over mayor's veto.

CARTHAGE, MO.—F. G. Flanagan, G. B. Paxton and S. A. Hemingway, of the Joplin, and S. O. Hemingway, of St. Louis, incorporate the Joplin & Rex Street Railway Company at \$50,000.

KANSAS CITY, MO.—Forest Hill Electric Railway Company funds nearly raised. Papers soon to be applied for.

KANSAS CITY, MO.—Indiana avenue horse line abandoned and track torn up. Metropolitan has always operated the road. A. B. Smith, New Bedford, Mass., nominal president.

KANSAS CITY, MO.—Preparations made to build additions to power house of West Side road. Extension from Minnesota avenue to be made in sixty days.

LOUISIANA, MO.—A St. Louis syndicate, represented by Jas. O. Broadhead, W. J. Dougherty and O. C. Brison, has secured an eighteen mile franchise between Louisiana and Ashley. Work begins immediately.

OREGON, MO.—A street railway of some kind would do paying business between Oregon and Forest City. Two hack lines make money. Population of Oregon 1,000. Forest City 500.

ST. LOUIS, MO.—D. G. Hamilton, Chicago, and Robt. McCulloch and S. P. Galt, of St. Louis, incorporate the South Western Railway Company at \$3,000.

Montana.

BUTTE CITY, MONT.—Montana Electric Company incorporated by John O'Rourke, G. T. Schmelzel, S. B. Smith, W. T. Jackson, V. E. Poissant and C. L. Smith. Capital stock, \$50,000. Principal office at Butte. Business to be done in Silver Bow County and other places, in railway, light and power plants of every kind.

Nebraska.

OMAHA, NEB.—The Courtland Beach Company has let contract for the building of this new line. Assistant General Manager De Loog, of the East Omaha Company, has made several contracts for material in St. Louis.

OMAHA, NEB.—The Sprague Electric Motor Company and the Western Engineering Company bring suit against the Plattsmouth Street Railway Company for debt on equipments.

New Hampshire.

CONCORD, N. H.—Henry E. Chamberlain, formerly of the Boston & Maine railroad, elected superintendent of the Electric railway.

LACONIA, N. H.—Bela Keniston, superintendent street railway company, says that extensive improvements are considered, including electricity, in a short time.

New Jersey.

JERSEY CITY, N. J.—Hudson & Bergen Traction Company, capital \$5,000,000, organized by Myles Tierney, Theophilus Butts and Albert C. Wall. Will try to obtain thirty-six routes in Hudson and Hoboken, buying the North Hudson Company Railway.

NEWARK, N. J.—New Jersey Traction Company formed with E. F. C. Young, Jersey City, supposed to represent the Hudson county lines; Bernard Naughton, representing Elizabeth lines, and Jeremiah O'Rourke, Newark. Spencer Weart, the counsel for the Crimmins syndicate, paid the \$30,000 fee.

NEWARK, N. J.—The car house of the Newark & Orange Electric Railway, at Raseville, burned. Loss, \$150,000.

ORANGE, N. J.—W. A. Tucker, Boston, banker, Alfred P. Foster, Cincinnati, and Frank W. Child, Orange, have taken control of the Orange, Crosstown & Bloomfield and the Orange Valley Street Railway. Will build long extensions.

RAHWAY, N. J.—The Canada Car Company, of Carteret, will build electric railway to unite with the Rahway Electric, which is incorporated by C. W. Boynton, Henry Mauerer, Henry G. Wolcott, William Howard, N. E. Mead, Jr., D. K. Rybo and Jackson Jacques. Population of Rahway is 7,100.

RAHWAY, N. J.—Two companies fighting for franchises, one made up of C. W. Boynton, William Howard, Jackson Jacques, the other by E. S. Savage, banker, Rahway, Harry Simmons, Thos. Potter, Chas. Oliver, et al., Rahway.

TRENTON, N. J.—Option for thirty days given to Boston parties on the Orange Crosstown & Bloomfield Railway Company equipment. Road to be extended and electricity introduced.

New York.

ALBION, N. Y.—A citizen's meeting, at the office of Signor & Wise resolved to build a street railway from Albion to Westport.

BUFFALO, N. Y.—Buffalo & Niagara Falls Road organized at \$1,000,000; W. Caryl Ely, of Niagara Falls; Frederick Swift and Wendell Goodwin, of New York City; Willard P. Whitlock, of Elizabeth, N. J.; George H. Wirth, James W. Norton and John S. Shepard, of Brooklyn, and Joseph A. Powers, of Lansingburg.

GRAVESEND, N. Y.—Coney Island & Gravesend Railroad Company organized at \$350,000, to operate thirty-five miles of street railway. President, S. S. Williamson; treasurer, John Curran; secretary, Fred E. Bader; counsel, Geo. W. Roderick. Much of the track will be laid outside of Coney Island.

JAMESTOWN, N. Y.—The Jamestown & Gloversville Horse Railway has voted the issue of \$50,000 additional bonds.

KINGSTON, N. Y.—Benjamin Van Steenburgh, 53 Broadway, buys the Platz Pike and will turn it into an electric railway and put in electric light plants.

SYRACUSE, N. Y.—W. R. Kimball, Cincinnati, says that Salina street will be equipped soon with electric; this begins the new system.

North Dakota.

FARGO, N. D.—J. H. Bowman, representing St. Paul and Eastern parties, applies for electric franchise between Fargo and Moorhead.

Ohio.

AKRON, O.—The J. F. Sieberling Company granted franchises for a line to Cuyahoga Falls.

BUCYRUS, O.—A Mr. Beatty, of Springfield, Mo., agrees to build the Galion-Bucyrus line of the two cities. Will give \$10,000.

CINCINNATI, O.—President Kilgour, of the Consolidated, says that the company will put on two hundred open cars this summer and change existing horse lines to electric.

CLEVELAND, O.—The entrance of Tom L. Johnson's lines into the combine will make several extensions and new lines necessary.

CLEVELAND, O.—The Cleveland Electric Railway Company has organized as the successor of the E. C. & B. N. Electrics. Capital stock \$6,500,000. Of the stock the East Cleveland stockholders will receive \$4,500,000 and the Broadway stockholders \$2,000,000. The property will be bonded for \$1,500,000, of which \$449,000 will be the share of the Broadway Company. The officers of the new company will be as follows: President, H. A. Everett; vice-president, Horace A. Andrews, secretary, R. A. Harman; assistant secretary, L. E. Beilstein; treasurer, James Parmelee; electrical engineer and purchasing agent, C. W. Wason; superintendent, John J. Stanley. The executive committee is requested to consider some large extensions and improvements.

CLEVELAND, O.—Major I. S. Fate, this city, is working up an electric line to Powderly.

DAYTON, O.—The Fifth Street Railway Company has ordinance under way extending life of franchise and obtaining rights on new streets.

DAYTON, O.—Stockholders of Dayton Traction Company organize with president, Dennis Dwyer; vice-president, O. B. Brown; Wm. Huffman, general manager; Walter M. Smith, superintendent; Fred. Reibold, treasurer; O. M. Gottschall, secretary.

GREEN SPRINGS, O.—B. F. Myers, of Tiffin, applies for franchises of village streets. B. M. Reed, town clerk.

KENTON, O.—D. Flanagan, of this place, says his railway is a sure thing.

MASSILLON, O.—Chas. Stesse, W. K. L. Warwick, W. B. Humberger and Otto Young intend to build an electric line to Navarre.

NAPOLEON, O.—W. H. Dore, attorney for the great Ohio Electric Railway Combine is getting right-of-way in this section. G. W. Kerper Cincinnati, R. W. Brown, Tiffin, and Ex-Governor Foster are interested

NAVARRE, O.—Until April 20 proposals will be received by E. J. Walker, village clerk, for construction and operation of route number 1 of street railway for twenty-five years. Bids must be so marked. Bids will also be received by Walker for a line from Massillon to Navarre over the highway. Bids must be so marked.

NORWALK, O.—Organized: The Norwalk & North Fairfield Electric Railway Company, by Hon. Jno. A. Williamson, Harry H. G. Hoyt, Hon. C. P. Wickham, Rev. Dr. T. F. Hildreth, J. F. Lanning, Hon. S. E. Crawford and Frank H. Evans. The road will eventually connect with the Big Four road later on to Mansfield and other points. Line will be built and controlled by Norwalk men.

PIQUA, O.—Chief Engineer W. T. Calwell, Cincinnati, and force begin operations on the Troy-Piqua line.

TOLEDO, O.—A. M. Woolson proposes to utilize the street railway tracks on Orange street, now abandoned, and turn it into a steam suburban line.

TOLEDO, O.—It is said that J. K. Tillotson has placed \$600,000 in bonds with the General Electric for the Put-in-bay Southern long line

UPPER SANDUSKY, O.—J. B. Sprague has completed right-of-way for the Port Clinton & Upper Sandusky Electric Railway.

WARREN, O.—The Trumbull Electric Railway granted franchises on a number of new streets.

WELLSTON, O.—Wellston Belt & Street Railway Company incorporated at \$160,000. Henry Wells, president.

ZANESVILLE, O.—The Electric will be extended from Seventh street to the Brown works.

Oregon.

THOMASVILLE, GA.—A. T. McIntyre, Jr., Dr. I. McIntyre, W. H. Mitchell and T. C. Mitchell are directors of the new Electric Railway Company. Hold property, franchises, etc., of the old horse line. To begin immediately to change.

Pennsylvania.

ALLENTOWN, PA.—Mayor Lehr has signed two franchises giving the Lehigh Valley Traction Company and the Philadelphia & Allentown trunk line permission to enter city. Power house to be built here.

BETHLEHEM, PA.—The Allentown & Bethlehem Rapid Transit Company contemplate extensions on Main street.

BRIDGETOWN, PA.—The Rapid Transit Company has decided to accept the franchise recently granted for the Bridgetown & Millville road.

DOYLESTOWN, PA.—The Philadelphia & Allentown Company franchise here passes second reading.

EASTON, PA.—The Easton Transit Company leases the College Hill road, owned by H. C. Hand and W. H. Jessup, of Scranton. New owners will rebuild the road.

EDINBORO, PA.—Cambridge & Edinboro Street Railway Company organized by Dr. S. B. Hotchkiss, Edinboro; W. D. Rider, Jr., Cambridge; Chas. Fahr, Dr. Cyrus See, John Shyrock, H. H. Thompson and F. R. Shyrock, of Meadville, at \$50,000. Total population 1,300.

JENKINTOWN, PA.—Franchise granted to the Electric Trolley Railway. Work will begin soon.

JESSUP, PA.—Organized: The Jessup Rapid Transit Company to build four-mile road, by John J. Sweeney, Michael Gallagher, P. J. Burke and P. B. Gilmartin, Winton Borough; W. G. Robertson, Dunmore, and J. W. Smith, Peckville; D. H. Barry, Scranton.

MEADVILLE, PA.—Organized: The Meadville Street Railway Company, to run through the streets of Meadville; capital, \$30,000. The officers are George D. Trawin, president; H. H. Thompson, John J. Shyrock, Charles Fahr, F. R. Shyrock, Dr. Cyrus Lee, Meadville.

MIDDLETOWN, PA.—The officers of the new electric road are: President, John W. Rife; vice-president, Walter H. Kendig; secretary, Geo. H. Grove; treasurer, Edward M. Hoffer.

PITTSBURG, PA.—A line from Natrona to Parnasus is on the tapis. The line will be six and one-half miles long, and the officers are: President, J. C. Whitla; vice, E. G. Waters, general manager of the Pittsburg branch of the General Electric; treasurer, John T. Reeves; directors, G. F. Greenwood, superintendent of the Pittsburg & Manchester Street Railway, et al. Capital, \$400,000. To build a big bridge.

PHILADELPHIA, PA.—N. H. Larzelere, of the Schuylkill Heights Railway Company, has secured rights from here to Conshohocken.

PHILADELPHIA, PA.—The Manayunk & Wissahickon Electric Railway Company, organized in 1891, will begin construction within two weeks. Officers of the company, Peter Liebert, president; Isaac Wilde, vice-president; John Flanigan, secretary and treasurer.

PHILADELPHIA, PA.—The Philadelphia & West Side; Forty-second Street & West Park; and the Forty-ninth Street & Westminster Avenue Railway Companies granted rights to lay tracks and use the trolley.

RIDGWAY, PA.—Organized: The Kettner, Elbon & Shawmut Railroad Company, Ridgway; capital, \$500,000. The officers are: B. E. Cartwright, president; D. Dalliver, W. H. Newton, C. S. Tucker, H. A. Miller, John W. Hall, Alfred Herdman, H. W. Childs, Ridgway.

ROYERSFORD, PA.—Incorporated: The Royersford & Spring City Street Railway, to run from Royersford across the bridge over the Schuylkill river to Spring City; capital, \$12,000; directors, G. Mortimer Lewis, Wilkesbarre; Henry M. Brownhack, Norristown; C. J. Lewis, Philadelphia; Henry G. Kulp, Pottstown; E. L. Hallman, Royersford, and Wm. Albright, Spring City.

SOUTH BETHLEHEM, PA.—J. K. Page and A. L. Johnson, of Cleveland, of the Lehigh Traction Company, will build line of two miles, here to Copley.

Rhode Island.

WOONSOCKET, R. I.—Corporations committee of the legislature reports favorably the bill to authorize the Woonsocket Street Railway Company to use electric power, increase stock to \$400,000, and extend to Cumberland and North Smithfield.

South Carolina.

CHARLESTON, S. C.—President Passaliague, of the Enterprise Street Railway Company, says that the Great Western Electric Company, of Chicago, makes an offer to gain control of the line and electrify. M. K. Jessup, of New York, who now owns control will accede.

FLORENCE, S. C.—Columbia street railway plant here bought by the Florence Street Railway & Suburban Company. Mr. Moise, C. E., of Sumter, is now laying out new lines; four and one-half miles track already built and six cars.

South Dakota.

DEADWOOD, S. D.—Anson Higby, cashier Deadwood National Bank promotes a scheme for electric to Lead City. Franchise is granted, and road said to be backed by Nebraska parties.

Tennessee.

CHATTANOOGA, TENN.—All of struction removed and President Divine will extend street railway to Base Ball Park.

Texas.

GALVESTON, TEX.—Chartered: Texas City Improvement Company at \$2,000,000, by A. B. Wolvin and six others, of Duluth, Minn. F. B. and F. L. Davidson, of Galveston, and E. B. Fredrick, of Michigan, to build street railway and electric light plants and other enterprises on the west shore of Galveston Bay.

HARRISBURG, TEX.—J. M. Dorrance, C. H. Milby, T. J. Collins, Andrew Dow and H. A. Jones, of Houston, and G. W. Smith, of Bryan, will build electric from Harrisburg to Houston.

TYLER, TEX.—The street railway has been levied on for a small deed of trust in favor of the Galveston Street Railway Company. Matter will be adjusted, says Major Douglass.

Utah.

LOGAN, UTAH.—J. Z. Stewart, Jos. Kimball and Edward Hanson asks for franchise on Logan streets.

Virginia.

NORFOLK, VA.—Street lines sold to Arthur Luetchford and Murray A. Verner, of Rochester, N. Y., who will electrify.

Washington.

SEATTLE, WASH.—E. F. Whittler and Fred E. Sander ask for permission to lay an electric line to connect Walla Walla with the Edmiston road.

West Virginia.

WHEELING, W. VA.—Lewis Steenrod, Thos. O'Brien, John Clator et al., plan an extensive suburban addition to city with street railway, pike road, etc.

Wisconsin.

MILWAUKEE, WIS.—The Cudahy Belt Line incorporated at \$60,000, by Hugo Kocfler, E. E. Rogers, G. B. Seaman, A. L. Gilbert and H. A. Martin.

MILWAUKEE, WIS.—H. C. Payne and C. C. Rogers are said to be interested in an interurban between Chicago and Milwaukee to join the new Evanston road and the Milwaukee Consolidated. First section is to be built to Racine from Milwaukee within two years.

MILWAUKEE, WIS.—BONUS of \$100,000 been raised and Wauwatosa Motor line to extend to North Greenfield immediately.

MILWAUKEE, WIS.—Col. Paul McWhorter is organizing an electric road to Waukesha.

MILWAUKEE, WIS.—Richter Schubert and Dick have incorporated the Wauwatosa Street Railway Company (electric); capital \$25,000.

NEENAH, WIS.—Council grants the street railway company right to use any motive power but steam.



ESQUIMAUX AT JACKSON PARK.

Abraham Lincoln

When leaving his home at Springfield, Ill., to be inaugurated President of the United States, made a farewell address to his old friends and neighbors, in which he said, "NEIGHBORS GIVE YOUR BOYS A CHANCE."

These words come with as much force to day as they did thirty years ago.

How give them this chance?

Up in the Northwest is a great empire waiting for young, and sturdy fellows to come and develop it and "grow up with the country." All over this land are the young fellows, the boys that Lincoln referred to seeking to better their condition and get on in life.

Here is their chance!

The country referred to lies along the Northern Pacific R. R. Here you can find almost anything you want. In Minnesota and in the Red River Valley of North Dakota, the finest of prairie lands fitted for wheat and grain, or as well as for diversified farming. In Western North Dakota, and Montana, are stock ranges limitless in extent, clothed with the most nutritious of grasses.

If a fruit farming region is wanted there is the whole State of Washington to select from.

As for scenic delights the Northern Pacific Railroad passes through a country unparalleled. In crossing the Rocky, Bitter Root, and Cascade Mountains, the greatest mountain scenery to be seen in the United States from car windows is to be found. The wonderful bad lands, wonderful in graceful form and glowing color, are a poem. Lakes Pend d'Oreille and Cœur d'Alene, are alone worth a trans-continental trip, while they are the fisherman's Ultima Thule. The ride along Clark's Fork of the Columbia River is a daylight dream. To cap the climax this is the only way to reach the far-famed Yellowstone Park.

To reach and see all this the Northern Pacific Railroad furnish trains and service of unsurpassed excellence. The most approved and comfortable Palace Sleeping cars; the best Dining cars that can be made; Pullman Tourist cars good for both first and second class passengers; easy riding Day Coaches, with Baggage, Express, and Postal cars, all drawn by powerful Baldwin locomotives, make a train fit for royalty itself.

Those seeking for new homes should take this train and go and spy out the land. To be prepared, write to

CHAS. S. FEE,
G. P. & T. A.
St. Paul, Minn.

THE C. W. HUNT COMPANY, 45 Broadway, New York City, is doing a big business in its industrial railways for light and power stations. The uptown power house of the Broadway Cable is using the Hunt system for conveying ashes and coal to and from the boilers.

ACME SHIELD FOR MOTORMEN.

AMONG the many recent inventions tending to increase the comfort of motormen perhaps none will be more acceptable and appreciated than the "Acme Shield." An occasional shock, and even blood poisoning has been known to result from the driver grasping the brass handle when suffering from a scratch of skin abrasion on the hand.

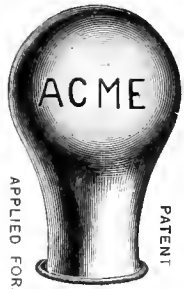

The Acme shield is made of rubber, to conform to the shape of the handle; can be easily slipped on and removed and fits the handle tightly. It is a complete insulator, and in addition to safety and comfort, will soon pay for itself in the saving on gloves. C. C. Lewis,

Cornhill and Washington streets, Boston, is the manufacturer.

THE IDEAL STEAM OIL REFINER.

THIS improvement in oil filters is the design of Albert C. Darragh, manager of the well-known Purity Oil Filter Manufacturing Company, of Pittsburg. From his seven years' experience in the business, he is well qualified to invent such a refiner. Referring to the illustration, the dirty oil is poured in the receiver A., and is strained down into the tube B and passes to the bottom of the chamber E., rising through water until it reaches the top of the tube F., when it runs down to the bottom and rises through cold water in I., ready to be drawn off at J. Steam is turned through the coil in the bottom of E., so that the water is kept hot. This latter feature is the peculiar characteristic of this filter, the oil being refined in hot water. It is claimed that the oil has greater lubricating qualities after passing through this purifier than when new. There is nothing to get clogged about this device, and it can be cleaned in ten minutes when it is thought best to do so. It is then as good as new. The simplicity and non-clogging qualities of this refiner recommend it to all who want something to work year in and year out without trouble or repairs. Over 500 are in use, though it has only been on the market a short time.

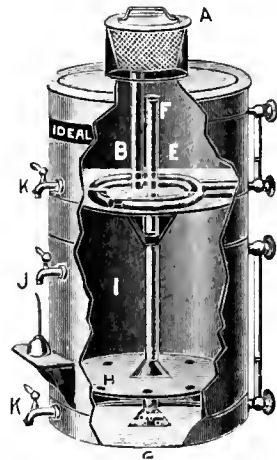

THE gripmen of Philadelphia have organized as the "Railway Employe's Protective Association of Philadelphia." The association expects to bring all Philadelphia traction employes into the association to the number of 500.

THE CHICAGO & ST. LOUIS ELECTRIC RAILWAY.

IT is something over a year since this pioneer high-speed electric railway was formally started, although such a route had been projected by Dr. Wellington Adams several years prior to this. As soon as it had been formally organized, however, the work of laying out the route and obtaining the franchises was begun.

The promoters of the enterprise considered that the route between Chicago and St. Louis offered exceptional facilities for this sort of a line. In the first place, it was thought that if the time could be shortened between the two cities, the passenger traffic of any line would become very profitable. With a straight line across a country almost as flat as a billiard table, upon which lay the richest veins of coal for furnishing the motive power, it is easy to see that this route possessed many valuable features.

Last season a portion of the road-bed near the main power-house at Edinburg was started in order to demonstrate the feasibility of the proposed multiphase system. Even so recently as this the announcement that a multiphase system of electric motors would be employed caused many cautious engineers to declare the plan impossible or at least improbable. Dr. Adams is deserving of the greatest credit for the untiring zeal with which he has carried the enterprise through to the prospect of immediate success.

It is not difficult to see that the ordinary 500-volt, continuous current system, such as is universally employed on the electric roads of this country, would not come up to the requirements of a line of such length as this. However high the potential might be raised at the power houses, it would be well nigh impossible to keep it at such an even pressure as would be required by the motors for effective service, without an immense outlay of copper. It was really the question of the ability of electricity to become the motive power for the future high speed and long distance railway.

It will be remembered that in 1891 several hundred horse-power were transmitted from Lauffen to Frankfort, a distance of 108 miles, at an efficiency of 72 per cent. German manufacturers were the only ones who would undertake to build multiphase equipment for railway work at that time, and the order for the first trucks for the Chicago & St. Louis electric road were placed in Germany. Recently the General Electric Company have announced their willingness to furnish the entire line with multiphase motors and guarantee them to travel at a speed of 100 miles per hour with perfect safety. It is understood that negotiations with this company are pending, and that their apparatus will be used on the line.

Construction work on the road, which has been suspended during the severe weather of the past four months, has been resumed on an extensive scale, under the recent contracts with Garvey Bros. and Bagnell Bros., of St. Louis. These call for the completion of the entire

track construction within a year, at a cost of \$5,500,000. It is stated that a large force of engineers and graders are to open the work in ten different places along the line. A great deal of road bed material has recently been purchased. The company intends to push the work as rapidly as possible, and expects to have a considerable portion in operation by August, while the Fair is in progress. The line will be double tracked at first and later on two additional tracks are to be laid.

NARROW GAUGE MOTOR.

THE needs of the narrow gauge railway have as yet escaped the close attention of the electrical companies. The General Electric Company, however, has recently designed and placed on the market a new type of single reduction motor, designed especially

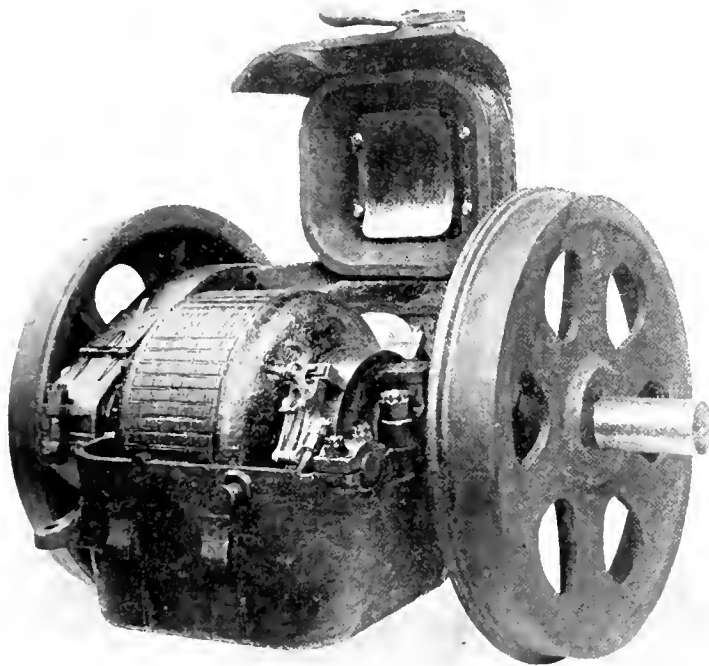

NARROW GAUGE MOTOR.

for use on tramways and other places where a narrow wheel gauge is desired. In general principle of design this motor closely resembles the standard W. P. type, with the exception that it has four poles, the two salient ones of which are top and bottom and the two consequent poles at the side of the frame. The armature, field spools, commutator, brushes and all the trimmings of the motor are entirely enclosed by the frame, and the armature bearings are so designed as to allow of only a bare clearance between the wheel of the truck and the sides of the motor. These motors are wound for either 220 or 500 volts, and are rated at about 250 pounds horizontal effort on a 20-inch wheel. The extreme outside width is only about 15 1/4 inches, so that the motor may be used on a road of but 18-inch gauge. The total weight of the motor with gear and gear case complete is 680 pounds.

STREET RAILWAY PATENTS.

Selected list of patents relating to Street Railway Inventions, granted during the past thirty days, reported especially for the STREET RAILWAY REVIEW, by Munn & Co., Patent Attorneys, 361 Broadway, New York, N. Y.

ISSUE OF MARCH 14, 1893.

Street Car, G. B. Bolton, Waverly, Mass.....	493,212
Side Guard for Vehicles, F. O. Blackwell, Boston, Mass.....	492,327
Electric Locomotive, T. A. Edison, Llewellyn Park, N. J.....	493,425
Elevated Cable Rail Road, W. R. Heylman, Rich Hill, Mo.....	493,500
Cable Grip, J. S. Patten, Baltimore, M. D.....	493,514
Cable Grip, S. A. Kneeder and O. Kneeder, Philadelphia, Pa.....	493,551
Electric Railway Conduit and Contact, J. Davis and R. M. Huntington, Denver, Colo.....	493,615
Electric Railway System, T. Harris, Detroit, Mich.....	493,623

ISSUE OF MARCH 21, 1893.

Conduit Electric Railway, H. P. Feltrow, Columbus, O.....	493,695
Insulator for Trolley Wire, M. H. Hathaway and J. Kelleher, Manchester, N. H.....	493,713
Conduit System for Electric Railways, E. Hazelton, Lansing Mich.....	493,716
Trolley for Electric Railways, J. F. Saitz, Baldwin, Pa.....	493,789
Converter System for Railways, A. DuBois-Reymond, Charlottenburg, Germany.....	493,914
Electric Locomotive, P. Philipsborn, Berlin, Germany.....	493,942
Electric Locomotive, P. Philipsborn, Berlin, Germany.....	493,943
Closed Conduit for Electric Railways, G. W. Von Siemens, Berlin, Germany.....	493,948
Electric Car, C. Brown, Basle, Switzerland.....	493,999
Car Starter, K. J. Pibl and O. W. Hult, Brooklyn, N. Y.....	494,026
Elevated Railway Car, H. T. Pruyt, Hoosick Falls, N. Y.....	494,051

ISSUE OF MARCH 28, 1893.

Sanding Device for Cars, D. A. Ghent and O. S. Colbran, Burlington, Canada.....	494,136
Rail for Street Railways, W. T. Jennings, Toronto, Canada.....	494,144
Street Car Fender, T. C. Rice, Worcester, Mass.....	494,165
Track Sanding Device for Street Cars, C. W. Sherburne, Boston, Mass.....	494,283
Electric Railway, J. C. Henry, New York, N. Y.....	494,477
Driving Gear for Motors, J. C. Henry, New York, N. Y.....	494,478
Electric Car Truck, J. C. Henry, New York, N. Y.....	494,479
Car Fender, H. T. Field, Boston, Mass.....	494,524

ISSUE OF APRIL 4, 1893.

Cable Railway Curve, E. S. Hildebrandt, Baltimore, Md.....	494,635
Fender for Street Cars, L. Pffingst, Boston, Mass.....	494,689
Electric Railway Trolley, E. Martyn, Detroit, Mich.....	494,721
Trolley Pole Catcher, E. L. Langhein, Brooklyn, N. Y.....	494,871

SOMETHING TO BE PROUD OF.

THE complimentary sentiments expressed by the Hon. Thomas B. Bryan, of the Columbian Exposition, in reference to the magnificent limited train service between Chicago, St. Paul and Minneapolis, are but the publicly uttered similar views of a great multitude of other American citizens who have journeyed between the Great Lakes and the Twin Cities of the Northwest, via the Chicago, Milwaukee & St. Paul Railway.

We are a great people, who demand and obtain the best of everything which can be purchased with money, and the railway companies of the United States—particularly of the west—are quick to respond to the desires of the traveling public.

In no part of the world are there more superbly equipped, electric-lighted, and steam-heated vestibuled trains than those which run every day between Chicago and St. Paul and Minneapolis, and between Chicago and Omaha, via the Chicago, Milwaukee & St. Paul Railway.

WORCESTER CONTRACTS.

STOCKHOLDERS, in session, of the North End Street Railway Company, of Worcester, Mass., have awarded contracts to a number of firms. The contracts for the rails for the extension have been awarded to Lewis & Fowler, of Brooklyn, N. Y. The contract for six open cars and one box car has been awarded to Lewis & Fowler. The company has already received three new Jones cars.

The company has asked the railroad commission for an increase of capital from \$60,000 to \$110,000. This increase will be used to make an extension to Clinton if a franchise can be secured.

A BIG BELT LOAD.

96 INCHES is a big width for a belt. C. A. Schieren & Company thought so and the railway company that hauled it thought more so. No box car was large enough to receive the burden, so



the affair was loaded on a flat car to take its place at the World's Fair.

The belt used the hides of 450 cattle and required twelve men to put it together.

SEATTLE NOTES.

A DEAL has been recently closed by which D. T. Denny and his two sons, John B. and D. Thomas Denny, who own the stock of the Rainier Power & Railway Company, acquire control of the Seattle Consolidated Street Railway Company. The latter has grown out of a primitive horse car company, until it now owns about twenty-five miles of electric lines, radiating all through the northern part of the city. Mr. Denny was one of the original incorporators, but in 1887 L. H. Griffith, of this city, and H. T. Blunck, of Davenport, Ia., bought the controlling interest, and in 1890 re-organized it and bonded it for \$1,200,000. In the last two years Mr. Denny has paralleled the lines of the Consolidated Company in the most thickly populated part of its territory with those of the Rainier Company, building a sys-

tem reaching from the heart of the city to Ravenna Park, the most north-easterly suburb, eight miles out. As the Consolidated line comes down Second street, the Rainier line down Third street cut into the heart of its business, while it had competition also from the Front street cable and the West street electric roads. The consequence is that all the roads mentioned have been losing money. The Consolidated Company has recently been turned over to Mr. Blunck and the other eastern stockholders to manage, as they had been complaining of "Irish dividends." Mr. Denny has now taken it off the hands of both Mr. Blunck and Mr. Griffith by buying their stock and bonds, and will practically consolidate the two systems, running cars alternately on the parallel lines, operating the whole from one central power station, building branch feeders, and arranging a system of transfers in all directions. Great economy will result from the centralizing of the power supply, as the Rainier power house adjoins the Western mill, also owned by Mr. Denny, from which he will obtain fuel without cost by using the sawdust and slabs.

M. Denney has just obtained an extension of the franchise of the Rainier system to fifty years, and has arranged with some Boston capitalists to float bonds covering the whole of the two systems, with an aggregate of over thirty miles of line. He is now negotiating with the other two companies whose lines parallel his—the Front street cable and the West street and North End electric—with a view to securing control, and will then have all the lines running north from the business center. As all four lines traverse a section of the city which he located as a donation claim forty-two years ago, when he came here as one of the first party of settlers, and a large part of which he still owns, he will be developing his own property by perfecting the street railway system.

WOODEN HAND STRAP HANDLES.

WOODEN handles have been added to the hand straps in use on the Broadway, New York, and are found to be very convenient. These handles are pear shaped, as shown in the illustration. The first few days they attracted considerable attention, but it did not take the passengers long to grasp the situation and the handles.

THE use of oil as a fuel brings up the question of the manner in which it is applied under the boiler for purposes of combustion. One method is that of burning the liquid directly, a rather smoky and unsatisfactory one under boilers. Another consists in forming a gas from the liquid before it enters the combustion chamber, a method not extensively tried as yet. The third by "atomizing," or breaking the liquid up into fine particles by means of steam or air jets. Steam jets seem to be the most popular on account of their convenience, air requires the use of a compressor.

THE NEW HAVEN CAR REGISTER.

AMONG the recent candidates for railway favor, and a concern whose device is attracting no small attention, is the New Haven Car Register Company, of New Haven, Conn. In the construction of this register it has been the aim of the makers to produce a strictly high-class, compact and durable machine, and also to make its exterior attractive and ornamental, so as to be fully in keeping with the finest class of cars built. An absolutely positive action is guaranteed, as an automatic device controlling the operation of registering and ringing makes it impossible to register without ringing, or to ring without registering. And yet this has been accomplished with a very simple construction, and parts all interchangeable and made of the finest selected materials only. The exterior is specially attractive, being made of solid cast bronze, either polished and lacquered, or nicked, as desired, which will retain the same finish when in use as when first unpacked. Dials are of finely beveled French plate glass.

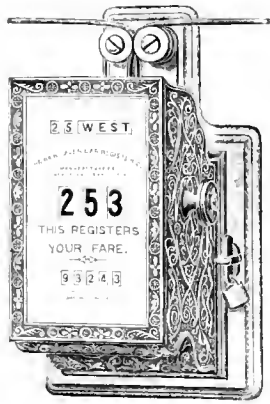

Compactness has also been considered in this register, which is only $8\frac{1}{2}$ inches high by $5\frac{1}{2}$ wide and 5 inches deep. The numerals are plain, and can be read in any part of the car. They are 1 inch long for the fare and 5-16 inch for the totalizing numerals. The latter may be concealed or not, as desired. The completeness of registration is noticeable and will be appreciated. It registers the number of trips; shows the direction; indicates trip fares to 1,000 and totalizes to 100,000. The number of registered trips makes the compilation of car mileage an easy matter.

A locking device prevents fares from being rung up during absence of the conductor. Each register has a four-tumbler lock and special key. Before leaving the factory each machine is carefully tested at the rate of 185 fares a minute. The works and offices are at 218 George street. Already the company are in receipt of testimonial letters from various roads, and have every reason to expect a large and prosperous business.

INAUGURATION CROWDS.

WASHINGTON railways' biggest day comes once in four years, when a president is inducted into office, and all loyal Americans who are on the right side of the political movement and can bear the expense, go down to the nation's capital to behold the pageantry of democracy or republicanism triumphant.

The urban transit facilities are at this time crowded to the utmost, and every vehicle in the district is pressed into service. Since Mr. Harrison ascended the steps of the White House there has been a radical improvement in Washington's street railways made by the opening of the Washington & Georgetown cable line. Curious to know how mechanical traction handled the crowds the STREET RAILWAY REVIEW obtained a photograph of one of the cable trains and a statement of the traffic on these eventful days. The engraving explains itself and the statement gives the following for the nine days from March 1 to March 9.

In 1889 passengers carried 622,564, average per diem 69,174; 1893 passengers carried 817,825, average per diem 90,870.

The increase of about 30 per cent carried must be attributed to the advantages of mechanical traction, as the other conditions of political importance were precisely the same. The W. & G. road may also be complimented

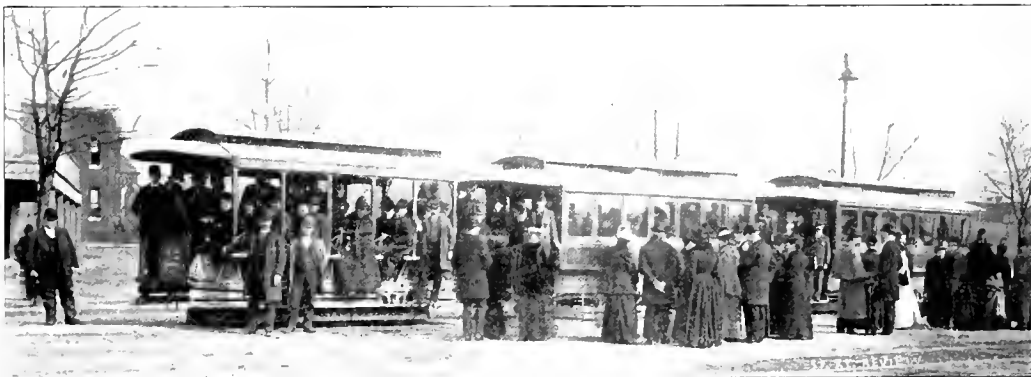

CABLE CAR SCENE—INAUGURATION DAY, WASHINGTON, D. C.

Registers are arranged for cord to pull from either side. The main registering train is returned to zero at the end of each trip by pulling out knob and turning once around, the knob springing back and locking in position. This at the same time changes number and direction of trip.

upon their entire freedom from accident with all this crush the unfamiliarity of the crowd with rapid transit, and the number of strangers and grangers in town. So much superior was the new method that despite the increase the cars were not uncomfortably crowded at any time.

THE NEW FOWLER CAR COMPANY.

A NEW car building company has been organized and will very soon be in the market for its share of the large and increasing demand for modern street cars. At the head of the enterprise and as president, is none other than John W. Fowler, whose name as former president of the Lewis & Fowler Manufacturing Company is so familiar to all railway men. A large and specially well located tract of ground has been purchased at Elizabeth, N. J., and here the extensive works will be built. Shipping facilities both by rail and water are excellent. The plant will cover nearly 100,000 square feet of surface and the capacity of the works will at the start be 120 cars per month.

Associated with Mr. Fowler in the management will be R. C. Swan, secretary, and John W. Cooper, of Brooklyn, treasurer. Mr. Swan was for a long time connected with the Lewis & Fowler Company. The new concern will have attractive offices in New York at 26 Courtland street.

The long experience of Mr. Fowler in car building together with his large personal acquaintance insures for the new company a successful and prosperous career. The works will open about Thanksgiving time and employ 800 men.

LYON'S BRUSH HOLDER.

LYON'S Patent Brush Holder for No. 6 Edison motors herewith illustrated, is the one adopted by the East Cleveland Railroad Company and was referred to by Vice-President C. W. Wason at the Cleveland Convention. This holder is very solid in

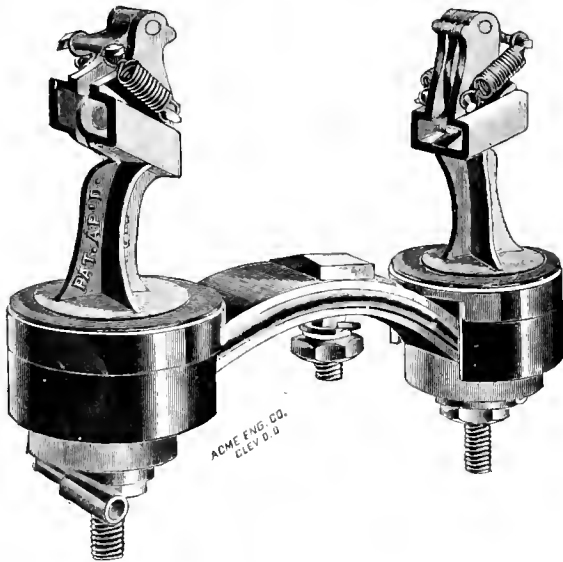

THE LYON BRUSH HOLDER.

mechanical construction. Poor brush holders are about the worst nuisance ever perpetrated against an unoffending railway electrician, and this substantial device will be appreciated by them all. The details have been carefully worked out, and testimonial letters from users con-

firm all the claims made by the manufacturers for its many good qualities. The Fulton Foundry Company, Cleveland, are the makers.

GARTON ARRESTER DISCHARGING.

OUR engraving shows a phenomenon that many of our readers may have seen, but it is very doubtful if any have in mind a clear representation of its exact appearance. It is a photograph of the Garton-Daniels lightning arrester at the moment of discharge.

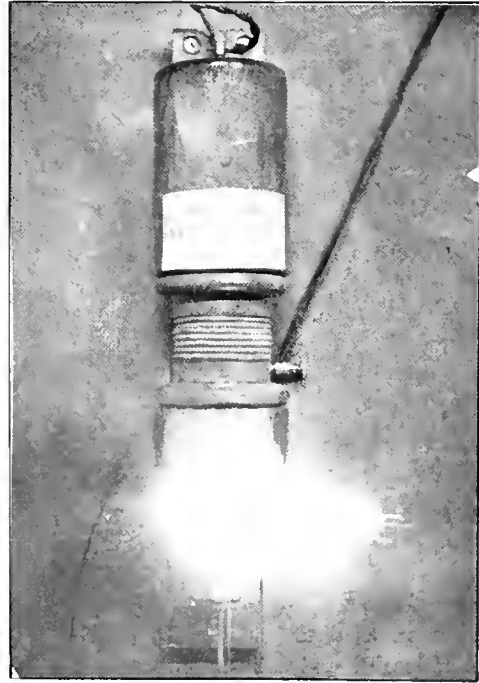

GARTON ARRESTER AT THE INSTANT OF DISCHARGE.

STORAGE BATTERIES FAIL AGAIN.

ANOTHER reminder that perfection is a growth, comes to us in the News that the Eckington & Soldiers' Home Passenger Railway Company of Washington, has ordered horses to take the place of the much vaunted storage batteries. Our Washington correspondent says that a thorough test was made of the storage system under the most favorable of circumstances but the old story of expenses is at the bottom of the failure.

During the traction fight in Philadelphia these storage battery cars were held up to an undecided public as perfection in rapid transit. Now discarded street car horses from Philadelphia are sent to Washington to wear out the balance of their lives, while Philadelphia's citizens ride comfortably and speedily in the "trolley car."

There can be no question as to the honesty of the endeavor made in Washington to give the storage system a more than fair trial. But it is beyond the accomplishment of the best manager to earn expenses with any storage system which has thus far been offered.

Storage batteries carried in cars as a means of motive power have lost what little grip they ever had.

ECHOES FROM THE TRADE.

W. W. ALLEN, Red Wing, Minn., has just shipped an order of his safety brakes to the Robinson Machine Company, Altoona, Pa.

THE ANSONIA ELECTRIC COMPANY are furnishing the overhead equipment for the new electric line of the Chicago City Railway.

ALFRED G. HATHAWAY, of Cleveland, recently put one of his 100-ton wheel presses in the station of the West Side Street Railway, of that city.

THE LEWIS & FOWLER GIRDER RAIL COMPANY has secured a large number of spring orders for straight rail and the special work department is full of business.

JOSEPH DE RYCKE, 145 Broadway, New York, reports a large number of sales for his centrifugal separators and aggrease extractors. The devices are efficacious and economic.

THE AMERICAN CAR COMPANY is just completing two new erecting shops, 200 by 300 feet and 150 by 200 in dimensions. Their capacity is taxed to the utmost. Hence these additions.

BIG HOLE RIVER, Montana, is to be utilized by John Noyes, John O'Rourke, et al., to furnish power for Butte City. The transmission will be thirty miles and the cost of the plant will reach \$1,000,000.

THE WROUGHT IRON BRIDGE COMPANY, of Canton, O., and 218 La Salle street, Chicago, contemplates putting a new patent pole for electric railways on the market soon. They will have facilities for a large output.

THE NEW HAVEN FARE REGISTER, manufactured at 218 George street, New Haven, Conn., by the company whose name the register bears, is one of the most attractive designs ever offered the trade. A full description will be found elsewhere in this issue.

JAMES F. MANN, manufacturer of the Leary automatic switch, at Utica, N. Y., has received testimonials from a number of lines speaking in flattering terms of this switch. This device provides a continuous rail at the frogs of switches and so saving a great deal of pounding.

J. K. TILLOTSON, of Toledo, O., has issued a prospectus of the proposed Put-in-Bay & Southwestern Electric Railway. It gives a detailed statement of the population, industries, traffic, pleasure resorts, etc., along the route. The plan is to connect Ottawa City, Port Clinton, Fremont, Fostoria, Tiffin, Findlay and Upper Sandusky.

THE ELECTRICAL INSTALLATION COMPANY has been organized in Chicago for installing all kinds of electrical work on trolley railways. The officers are: President,

Jackson I. Case, Racine, Wis.; vice-president, C. H. Holmes, Racine, Wis.; secretary and treasurer, L. E. Myers, Chicago; general manager, Allen Shewman, Racine.

THE HEINE SAFETY BOILER COMPANY has among its numerous recent sales, 600-horse-power to the Altoona & Logan Valley Railway; 300 to the South Chicago City Railway; 750 to the North Shore Electric Railway, Chicago; 1,000 to the Joliet Works Illinois Steel Company; 1,000 to the National Carbon Company, Cleveland, O.

DURING the January blizzards of the far north-west, Charles W. Cobb, the genial and jocund traveller for the Ansonia Electric Company, "did up" the electrical people of Montana and the Pacific coast. He reports a very satisfactory trip, and carried in a grip full of special orders for Shield Brand Wire and Habirshaw Rubber Covered.

THE ROBINSON RADIAL CAR TRUCK COMPANY has brought suit against the West End Company, of Boston, for infringement of its radial truck patent. It seems that the West End road has been making its own radial trucks without paying license to the Robinson Company. The suit will be watched with interest, as the Robinson Company seems to have fundamental patents.

THE RIES ELECTRICAL SPECIALTY COMPANY announce that they have designed a motor that will work efficiently on alternating current circuits, and it is claimed one that will be of slow enough speed and powerful enough torque to serve in railway work. A commercial motor for alternating currents has been the mecca towards which electricians have been striving for some time.

A. GROETZINGER & SONS, Allegheny, Pa., writes of a satisfactory business in dermaglutine. The railway part of the business is taxed to the utmost. A fine display of dermaglutine will be exhibited in the Electrical Department of the World's Fair, together with the Chas. Munson belting exhibit, which latter manufacture has recently come into the hands of A. Groetzing & Sons.

THE EDDY ELECTRIC MANUFACTURING COMPANY, of Windsor, Connecticut, has moved its New York office to new quarters at 1,212 Havemeyer Building. This is one of the finest of New York's office buildings, and Fredric C. Ross, the New York manager, will be at home to the many friends of the company in a pleasant abode. The Jewell Belting Company will occupy the same suite.

THE ST. LOUIS REGISTER COMPANY, of St. Louis, reports a good business. Some of the larger orders recently shipped supply registers to the West End, of Boston; two big orders to New Orleans; the Southern Electric Railway Company, of St. Louis; Lindell, St.

Louis; Lowell & Suburban; Central Railway Company, Baltimore; and the Mobile, Ala., Electric Railway Company.

THE LEWIS & FOWLER MANUFACTURING COMPANY, of Brooklyn, N. Y., writes: "We have extended our plant considerably, taking in an extra large plot of ground to facilitate the work in our track department, in which branch we are very busy. We hope to move into our new office quarters, Nos. 26 and 28 Sanford street, within the next two or three weeks. We are extremely busy in all departments.

P. F. LEACH, vice-president of the Cushion Car Wheel Company, has just sold a second order to the Joliet Street Railway. The first order has been in constant service under electric cars making 145 miles a day, and have not missed a trip since the start, a year ago last January. The most careful inspection fails to disclose any perceptible wear. A large order has just been taken at Paterson, N. J., for cushion wheels.

THE SHORT ELECTRIC RAILWAY COMPANY elected officers March 22, as follows: B. F. Miles, president, S. H. Short, vice-president; W. B. Bolton, general counsel; S. M. Hamill, general manager; Wm. Hazelton, 3rd, assistant general manager. It is reported that this company will become intimately associated with the Brush Electric Company, and that both the general and district offices of the two will be merged into one.

TWO HUNDRED AND SEVENTY CONSOLIDATED CAR HEATING COMPANY electric heaters have been in use on the Union Railway in New York city and 99 of the same heaters have been in use by the Albany Railway. This represents the complete equipment of 61 cars, all of which have the regulating heater switch of the Consolidated Car Heating Company. Their electric heaters are also in use to a considerable extent on several other important electric roads.

C. & G. COOPER & COMPANY, of Mt. Vernon, O., have had a remarkably large sales list lately, aggregating 15,100-horse-power and including 2,000-horse-power for the East Cleveland Railway Company, Cleveland, O.; 2,400 for the Atlantic Avenue Street Railway, of Brooklyn, N. Y.; 1,200 for the Allentown & Bethlehem Rapid Transit Company, Allentown, Pa.; 1,000 for the Union Railway Company, New York City, and 600 for the Robison lines of Toledo.

THE GENERAL ELECTRIC COMPANY through F. W. Horne, of the western department, has recently closed contracts with the Salt Lake City Railway Company for eight 50-horse-power motor equipments; with the Muscatine, Iowa, Street Railway Company for five cars and a 100 kilowatt generator; with the New Orleans & Carrollton Street Railway Company for twenty 25-horse-power car equipments and with the Shreveport, Louisiana, City Railway for a 100 kilowatt generator.

THE MCGUIRE MANUFACTURING COMPANY, through J. A. Hanna, has received an order for 75 "Columbian" motor trucks from the Rochester City Railway. The "Columbian" is the latest product of the McGuire factory. The new factory at St. Catherines, Canada, supplies Canadian roads at American prices. Mr. Cooke, of the McGuire Company, has just sold a second order of 20 trucks to the New Orleans & Carrollton Electric, where their trucks are giving unbounded satisfaction.

THE SHULTZ BELTING COMPANY, of St. Louis, keeps up with the large belt demand of the country. A late delivery was that of an 80-inch belt for the Toledo Electric Railway, of Toledo, O., and a 72-inch for the St. Louis & Suburban, besides the installation of two 54-inch doubles at the power house of the Union Depot line at St. Louis. Their regular power and mill business flourishes and foreign commerce is assisted by orders of 5,000 feet for Europe, besides a recent shipment of 4,000 to Moscow, Russia.

THE LAMOKIN CAR COMPANY, of Philadelphia, is building cars for Philadelphia Traction Company; Baltimore Traction Company; Williamsport Passenger Railway Company; Richmond County Belt Line; Belle City Railway Company, Racine, Wis.; Union Passenger Railway Company, Chester, Pa.; Wilmington City Railway Company, Del.; Schuylkill County Traction Company; Chester & Media Railway Company, Pa.; Rome Street Railway Company, Ga. Their World's Fair exhibit will be a fine one and is already shipped.

THE STEEL MOTOR COMPANY, of Cleveland, O., announce the perfection of their Steel Clad Motor. A sample equipment was such a success that a sample equipment was ordered for the Brooklyn Street Railway, of Cleveland. The test was severe but satisfactorily passed by the Steel Clad. A multiple series controller is in process of perfection and will be used with the motor. The company is sanguine of success, and promises some good reading in the way of guarantees. They will soon be ready to fill all their numerous orders.

THE BROWNELL CAR COMPANY had a silver celebration on March 9, in honor of Frederick B. Brownell, who entered the shops of the Wight car building establishment twenty-five years before. He was at that time sixteen years of age. He afterwards became a partner in the firm and later president of its successor, the Brownell Car Company. The jubilee passed off very pleasantly. Mr. Brownell was presented with a handsome desk by the office force and in his words of acceptance recalled some of his earlier experiences in the business.

THE J. T. SCHAEFFER MANUFACTURING COMPANY, Rochester, N. Y., brings out a new appliance for straightening car axles. The device consists of an appliance which can be attached to the yoke (movable beam) of any hydraulic wheel press. Can be put in posi-

tion in less than one minute, and is a very satisfactory device. Also equally as desirable for straightening shafts, or to use as a rail-bender. Another repair device made by the same company will remove old car wheels from axles on which a large gear is located near the wheel. This is also to be used on any hydraulic press.

THE RAILWAY EQUIPMENT AND MACHINERY EXCHANGE is the title of a new institution at 408 Neave Building, Cincinnati, Ohio. It is under the management of H. B. Deas and will aim to carry in stock everything necessary in the construction and operation of railways both steam and street. Besides this they have a large supply of second hand material including rails, locomotives, engines, boilers, street cars and machinery of all descriptions. In other words it is as its name indicates, an exchange where railway men can go and have their wants supplied, on reasonable terms and know that they are dealing with reliable men.

year round; are heavy enough to give good traction and are the only cars on the road that will plough through in an ordinary snow or sleet storm before the tracks have been cleared. The cars are also very satisfactory to the patrons. John J. Shipard, of the Cincinnati, Newport & Covington, says that during February their Accelerators averaged 240 passengers a day more than the 16 foot cars and are giving entire satisfaction. President Yerkes, of Chicago, gives them warm commendation and says that "in the future all box cars that we purchase or manufacture will be after the Accelerator pattern."

THE HOPPES MANUFACTURING COMPANY, of Springfield, Ohio, maker of live and exhaust steam feed water heaters, has recently passed into the control of Robert Johnson, who is prominently connected with other industries of Springfield, and J. A. Hayward, a former prosperous lumber merchant of that city. The officers will be as follows: John J. Hoppes, president; Robert John-

TROUBLE ON THE HAY MOTOR LINE.



1.—Motor grounded.



2.—Tries the Switch.

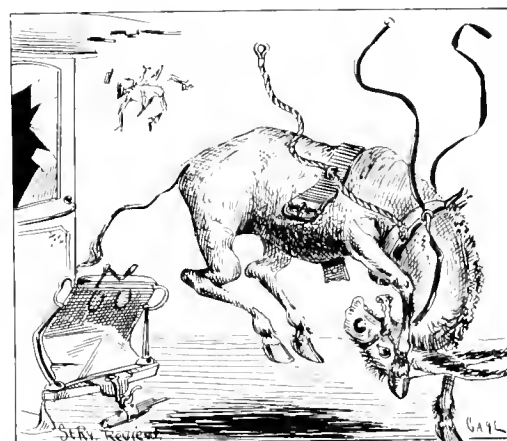

3.—Motor bucks.

THE ANSONIA ELECTRIC COMPANY (formerly The Electrical Supply Company), report a very pleasing reception for their latest specialty, the Helios arc lamp, for alternating circuits. They have just closed a contract for a plant for municipal and commercial lighting, in which a single alternating dynamo is to be used. From off the one circuit will be run the Helios arc lamps for street lighting, also the incandescent lamps for interior lighting. The Stanley Transformers will be used in this connection. From every one who has used the Helios lamp comes expressions of the very highest satisfaction and admiration for the work done.

THE BROWNELL CAR COMPANY, of St. Louis, are constantly receiving the highest endorsements of their "Accelerator" cars from roads using them. General Manager S. L. Nelson, of the Springfield (Ohio) Railway Company, writes that they are highly pleased with the Accelerators for the reasons that they facilitate the discharge of passengers, are roomy, and suitable for use the

son, vice president; E. C. Gwyn, secretary; J. A. Hayward, treasurer. The company report a good line of orders, among which are the following horse-powers of feed water purifiers: 60 (second order), to the South Bend, Indiana, Gas Light Company; 125 (second order), to the Cibola Creek Mill and Mining Company, Shafter, Texas; 625 to the Claremont Abattoir Company, Baltimore, Maryland; 150 to the West Chester, Pennsylvania, Cold Storage & Ice Company; 100 to the Garside Manufacturing Company, Peoria, Illinois; 900 to the Sandusky Portland Cement Company; 700 to Wm. Sellers & Company, Philadelphia; 400 to the Bay City, Michigan, Union Railway; 300 to the National Smelting & Refining Company, Chicago; 200 to the Hudnut Company, Pekin, Illinois; 500 to the Delaware, Ohio, Electric Light Company; 250 to the Richmond Distillery Company, Milton, Kentucky; 625 to the Edison Illuminating Company, Monmouth, Illinois; 200 to the Hutchinson Cooperage Company, Peoria, Illinois; 150 to the Peoria, Illinois, Cooperage Company.

J. F. MANN, Utica, N. Y., is meeting with very satisfactory success with his overhead switches, and other line and electric specialties.

THE FITCH EXCELSIOR SWITCH COMPANY, 45 Broadway, New York, are meeting with good success with their automatic track switch, which can be operated from the front platform by the driver pressing a lever with his foot.

SAWYER, MANNING & COMPANY, leading manufacturers of uniform clothes, are supplying many of the largest street and steam railways in the country, and among recent contracts taken by C. L. Bowler, manager of the uniform department, is that of the Atlantic avenue road, Brooklyn.

THE BERLIN IRON BRIDGE COMPANY, East Berlin, Conn., are receiving most complimentary letters from railway managers, expressing entire satisfaction with the manner in which they erect their steel truss roofs for power houses, car sheds and barns. Their work may be found in all parts of the country and is rapidly increasing in volume.

WONDERFUL EFFECT OF THE MULTIPHASE TRANSFORMER.

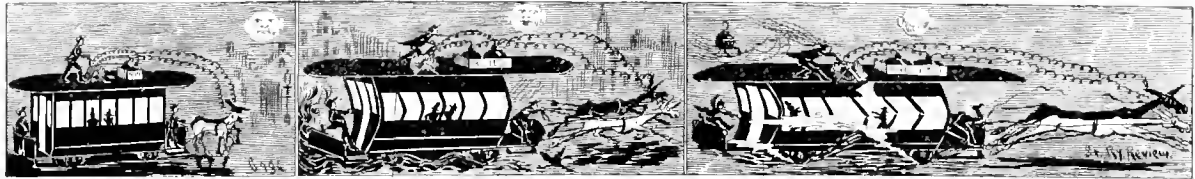

500 VOLTS.

5,000 VOLTS.

50,000 VOLTS.

THE FISH BROTHERS WAGON COMPANY, of Racine, Wis., whose wagons are so popular, are manufacturing a tower wagon for electric railways, which in appearance and strength leaves nothing to be desired. Their long experience in wagon building places them in position to turn out a very superior wagon for railway use.

THE LACLEDE CAR COMPANY, St. Louis, report their shops as crowded, and future deliveries extending clear through the year, and will keep them very busy. The capacity of the works has been enlarged to such an extent that they can turn out 1,000 cars per annum without recourse to any night work. Since January 1st they have shipped 250 cars, and the outlook grows better all the time for a continued large demand for their work.

THE FUEL ECONOMIZER COMPANY, of New York, are receiving an increasing number of inquiries and orders from street railways. Managers are more and more coming to realize the importance of enforcing economy in the production of steam, and the apparatus of the Fuel Economizer afford results which are fully in keeping with its name. Its exhibit at the World's Fair is already attracting wide attention. Put this down on your list as one of the things not to be missed.

THE FULTON FOUNDRY COMPANY, Cleveland, has done an enormous business during the last three months. Their truck shop has been crowded to its utmost capacity, and they are about to add more room to their works. They have also manufactured a large number of railroad crossings, and orders for switches, turnouts and cross-overs are looming up very nicely. For the last half of March orders have been taken for nearly 500 of their patent draw bars. Their wheel orders have been very great, especially on their patent double tread wheel.

ALBERT FISHER, of the Watertown Steam Engine, has been making some big sales of engines through the west lately. His reputation as an engine salesman is an enviable one, and aided by the good qualities of the Watertown engines, the sales have been something remarkable. A partial list includes one 100-horse-power to the Cleveland Nickel Works; 40-horse-power to the Albert Landreth Seed Company, Manitowoc, Wis.; one 140-horse-power to the Muncie, Ind., Light, Heat & Power Company. Mr. Fisher's well known experience and ability and the high grade of the Watertown machinery assure success in this western territory.

THE CUSHION CAR WHEEL COMPANY reports several orders from roads in the vicinity of Chicago. Mr. Leach made a successful western trip last week.

C. J. SWIFT, of the Ford-Washburn Storelectro Company, of Cleveland, has contracted for five 30-horse-power equipments for the Woodland Avenue & West Side Road, of Cleveland.

W. HASKELL KING & COMPANY, of New Haven, Conn., are in the market with an anti-rattler car window fastener, described in the REVIEW last month.

THE MCGUIRE MANUFACTURING COMPANY in order to fill orders for April must ship 437 trucks. Of these 353 are "Columbian," 56 "Bicycle," 28 double trucks "No. 208." The majority are duplicate orders and all of them call for steel frames. Among the larger roads ordering in the last month are the New Orleans City & Lake, the West Side Railway, Kansas City; the Toledo Consolidated, the Duluth Street Railway, the Tacoma Railway & Motor Company, the Detroit Citizen's, the Calumet Electric, of Chicago, the Cedar Rapids & Marion, the Chicago & North Shore, and the Cicero & Proviso, Chicago, besides others too numerous to mention.

TOWER WAGON.

ONE of the most necessary conveniences possessed by the Bell City Company, of Racine, is a handsome tower wagon, made by the Fish Brothers Wagon Company of that city. It is nugatory to state the manifold advantages of tower wagons in general, as every live manager knows that prompt assistance in the case of a ground means the saving of dollars towards the end of the street railway dividends.

The Fish tower wagon is a beautiful vehicle with a body length of 8 feet, 5 inches, 14 inches deep with high seat for driver 4 feet wide. It is all brass mounted with patrol steps in the rear and fenders over the hind wheels. A good loud gong gives notice of its approach and Manager Shewman says that two horses can make

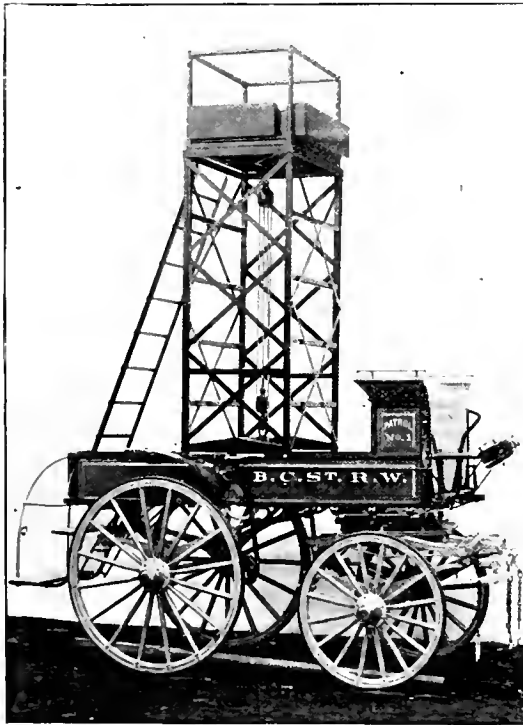

FISH BROS. TOWER WAGON.

race track time with the entire machine and three men. The tower is of angle iron the width of the box by two feet at base and thirteen and one-half feet high, closed. A windlass and pulley raises it to nineteen and one-half feet. Four tool boxes well arranged in the bed and three more in the tower give plenty of room for repair equipment. The wagon is strikingly painted with light orange body and light cream running gear striped with gold. The gear is full platform. The Fish Brothers' Company is preparing to make an extensive canvass of railway companies and the design will undoubtedly meet with as hearty approval from other managers as from Mr. Shewman.

It is stated the price at which Ross and McKenzie took the Montreal contract was \$30,000 per mile including car equipment.

WEST END TROLLEY.

THE object of the peculiar form of construction of the trolley wheel here illustrated is to prevent the inconvenience caused by the dropping off of the flange when the groove in the wheel is worn through to the outside. When the groove is worn through in this



NEW.



WORN THROUGH.

wheel the ribs still hold the flange, and it can still be used long enough to get to the barn, whereas the flange dropping off, disables the car and causes much inconvenience. These wheels are made by Albert and J. M. Anderson, of 21 Hamilton street, Boston.

GRIP 688.

IN all the annals of the great Mohawk cable railway never was car so "hoodooed," bewitched, possessed of the devil and generally unfortunate as was grip No. 688 of the aforementioned line. In the space of two hours, on one trip and controlled by the same gripman, this misguided and reckless piece of furniture decreased the foreign population by fatally injuring a Polish count, then assuming the incognito of a brick layer, stuck in the slot, knocked a coal wagon to very small smithereens, derailed its irresponsible self and ran up to the very gates of a prominent down town hostelry and ended its career by causing the death of a valuable horse.

Of course the dear people called it running amuck, but a veracious and intelligent car shifter assured our scribe that the rolling stock in question was "hoodooed." With a triumphant shriek and squeal of twisting bolt and turning steel the desperate car unceremoniously and unconventionally removed John Kossiknekqski from the face of the earth and the track. Then with a self-satisfied grunt the grip stuck hopelessly in the slot. After considerable hot language and crow bar had secured its release it dashed gaily into a baker's wagon. A pile of splinters and crumbs marks the spot. Then it recognized its old enemy the coal wagon placidly halting in the middle of the track, trusting in its ponderous security. The teamster knew it was loaded but that availed not. As they exhumed him later in the day he remarked, "Whoa! Get up! —! —! —! Where am I at?" and then again relapsed into insensibility. This caused the wild and woolly grip an instant's digression, which ended on the sidewalk of the Bellington hotel, beside the remains of a fine horse. But its race was run, the evil spirit had departed and grip 688 meekly followed two horses back to the barn.

Who says a car can't be "hoodooed?"

OBITUARY.

EDWARD G. GILBERT.

Died, March 9, 1893, Edward G. Gilbert, of Troy, N. Y. This announcement takes from the street railway supply field one of its best known members. Mr. Gilbert



E. G. GILBERT.

was born in 1847, at Troy, the son of the Hon. Uriah Gilbert, formerly mayor of that city. After graduating at the Rensselaer Polytechnic Institute he began immediately the active business career which built up the Gilbert Car Manufacturing Company and placed it in the front rank of Troy's manufacturing interests.

Mr. Gilbert was a man of high principles, a thorough gentleman and possessed the esteem of all who knew him. His death was caused by angina pectoris, of which he had had previous attacks. He leaves a wife and four children.

D. A. ANDREWS.

The necrology of 1893 includes the sudden and unexpected death of D. A. Andrews, president and treasurer of the Pettingill-Andrews Company, of Boston. Mr. Andrews attended the inauguration festivities at Washington, contracting a heavy cold, which resulted in a fatal attack of acute rheumatism.

Mr. Andrews was a highly respected citizen of Boston and was regarded as a man of brilliant prospects.

J. L. VALENTINE.

J. L. Valentine, widely known as the secretary and treasurer of the Central Park, North & East River Railway Company, of New York, died of pneumonia, March 13.

Mr. Valentine's long service of 27 years and his many personal charms make his death a matter of the greatest regret to his circle of acquaintances and friends.

Entering the service of the company at the age of 22 he became successively paymaster, receiver, secretary and treasurer. All his duties were discharged faithfully and honorably with credit to himself and profit to the capital represented.

EDISON'S FEEDER PATENT.

A PATENT granted Edison September 19, 1882, and practically covering the system practiced by nearly all electric railways, of running feeders from the generating station to centers of distribution at different points along the line, was sustained by Judge Greene in the U. S. Circuit Court at Trenton, New Jer-

sey, March 28. The suit was between the Edison Electric Light Company and Westinghouse, Church, Kerr & Company. This gives the General Electric Company another important monopoly.

Fortunately the system is not absolutely necessary to the operation of an electric road. The case will probably be appealed.



CHICAGO WAREHOUSE GENERAL ELECTRIC COMPANY.

THE Aurora, Ill., Street Railway Company has leased Elliott Grove, three or four miles out of the city, and proposes to fix it up for a summer resort and run their cars to it.

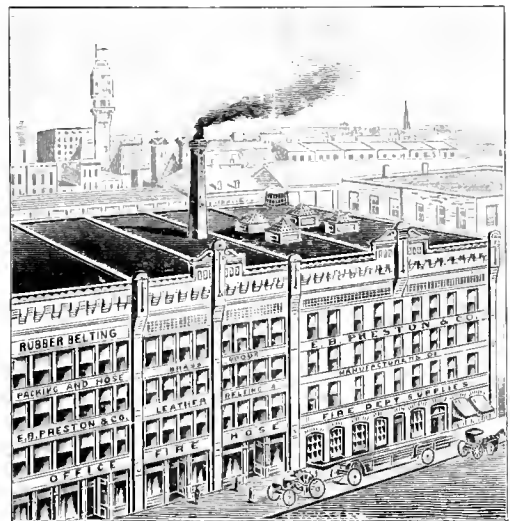

PRESTON BELT FACTORY, CHICAGO.

A HORSE sale at Cleveland sent 300 Woodland avenue animals to New York to work on the Third avenue lines there. The average price was \$100.

THE fifty miles of the Louisville, Ky., Railway recently paid a 2½ per cent dividend on its preferred stock. By September, 10 miles more will be added to the mileage.

CHESTER, Pa., citizens all ride on the electric cars now when they shop at Media. The steam road traffic has fallen off to such an extent that the local service is to be abandoned.

THE MOSHER RAILWAY CIRCUIT ARC LAMP.

ARC lighting from railway circuits promises to be nearly as fruitful a source of revenue as selling current for motors. Since lamps for this purpose were first turned out there has been a great improvement in their construction. In fact all kinds of arc lamps have been greatly simplified and the number of parts reduced. The Mosher Electric Company of 123-127 Ontario street, Chicago, are making a lamp for running from five to ten in series of 500 volt circuits, that combines the desirable qualities of simplicity and the ability to give good service under the care of inexperienced hands. Referring to the illustration of the mechanism (Fig. 1) the two top coils are in series with the arc and each other. The one on the right is the starting coil. When the current is turned through the lamp these two series coils pull up the feeding mechanism and separates the carbons. The armature remains stationary against the electro-magnet on the right. The other end of the armature which effects the feeding is magnetically suspended between the series coil on the left and the shunt coil immediately below it. As

and ready work required with railway circuits the simplicity of the Mosher lamp is just the thing and it is becoming better understood every day that a lamp does not need to be a Chinese puzzle requiring a man long experienced in that make of lamp to take care of it.

NEW PUBLICATIONS.

THE PHOENIX IRON WORKS CATALOG, of the Dick and Church engines, is a fine specimen of the printer's art as well as an exhaustive treatise on the performance of their different types of engines. A large number of specimen indicator cards are given.

GOOD roads is a subject that has awakened much interest lately, but not as much as it deserves. Workers along this line presented a memorial to the Fifty-second Congress on a "Road Department at Washington, D. C., and a Comprehensive Exhibit of Roads, their Construction and Maintenance, at the World's Columbian Exposition."

THE FIXTURE CATALOG of the Ansonia Electric Company is a novelty in catalog design and ought to meet the approval of patrons. It is supplied with a number of plates, illustrating the designs now carried by the house. As new designs are brought out they are furnished to customers and room is left in the catalog for binding them in, so that it is always up to date.

A GEAR LIST, recently published by the Walker Manufacturing Company, of Cleveland, is a handsomely bound volume of 311 pages, containing besides the price list and testimonials a large amount of useful information on the subject of rope transmission and numerous tables of value to the mechanical engineer. The present list is the tenth edition of the volume.

DRY STEAM—THE FOUNDATION OF ECONOMY, is the title of a new catalogue issued by the Goubert Manufacturing Company, 32 Cortlandt street, New York, makers of the Stratton Steam Separator. It is a handsome publication of about forty pages, finely illustrated, and as its title implies, contains valuable information on the subject of dry steam and the merit of the Stratton separator in its relation thereto. Copies of the catalog will be gladly furnished upon application.

CASSELL'S FAMILY MAGAZINE for April contains many instructive and interesting subjects. "Through London on a Barge," "The Island of Six Shadows," "A Talk with Sir George Reid, P. R. S. A.," "An Old Maid's Secret," "New Mount Mellick Work," and "Chit-chat on Dress" are some of the subjects given. The Duchess of Fife's portrait adorns the first page. This number of the Magazine is full of good practical articles such as everyone enjoys.

STREET RAILWAY MOTORS.—An entirely new work, just from the press, by the well known railroad authority and author General Herman Haupt. Extensive research has been made to get at the actual operating expenses of all the various methods of street railway motive powers, and for the first time all these figures are offered in a comparative form. Haupt has made a careful study and presents the results in a form at once concise, interesting and fully classified and indexed. Pp. 225, 12 mo. \$1.75.—STREET RAILWAY REVIEW

ELECTRICAL MEASUREMENTS AND OTHER ADVANCED PRIMERS OF ELECTRICITY, by Edwin J. Houston. Price, \$1.00 This is one of the most comprehensive and thoroughly up to date work of its kind ever published. As its name applies it is an advanced primer. The subjects chosen include all the principal modern applications of electricity, treated in such a way that the non-technical reader will have little difficulty in understanding, while at the same time the electrician does not feel on reading the book that the information given is chosen in a haphazard way and is deficient on vital points, as is the case with so many popular books on electricity. W. J. Johnson Company, New York.

THE ELECTRIC RAILWAY IN THEORY AND PRACTICE. W. J. Johnson Company, 41 Park Row, New York. \$2.00. This is the second edition of this well known work of Crosby and Bell. It has been revised and re-written, bringing it to date as near as possible, and it is now probably one of the best works on this subject extant, as it covers the field as fully as is possible in a volume of its size. Appendix F. calls attention to two appliances that have come into practical use since the book was first written—the bevel gear motor connected to both axles and the series multiple controller. Appendix G. gives a hitherto not generally known method of measuring the resistance of trolley wire insulators while they are on the line.

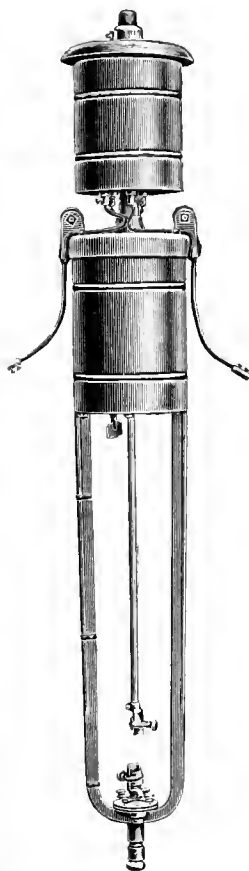
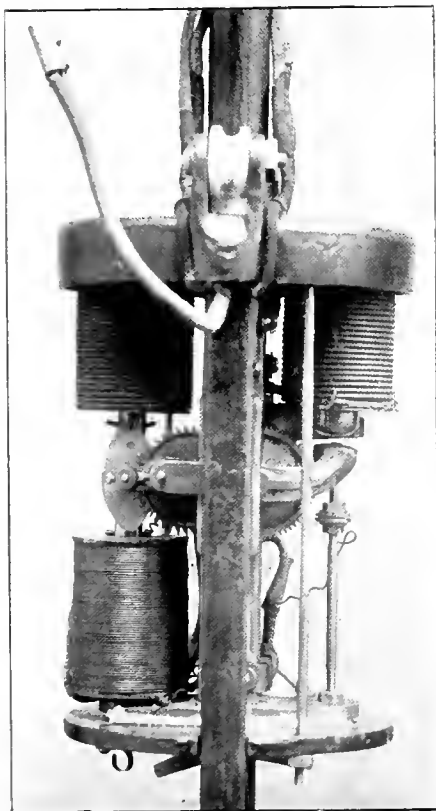

INTERIOR AND EXTERIOR VIEW OF MOSHER ARC LAMP.

the arc burns out long, its increased voltage forces more current through the shunt coil, while at the same time the series coil tends to weaken. The armature is then let down and releases the rack and pinion feeding mechanism. This mechanism is very simple—more simple indeed than many clutch feed lamps. By balancing the feed between the series and shunt coils the lamp is made suitable for circuits with great variations in voltage. About one ohm resistance is put in series with each lamp. The reostat shown in Fig. 2 is wound with two circuits, one consisting with the one ohm steading resistance always in circuit and the other a resistance equal to that of the arc. This latter is automatically cut in when the arc is not burning so that any lamp in the series thrown out of action by accident or by intention will not disturb the others. Two kinds of railway lamps are made, one for from eight to ten amperes, the other for five to eight amperes. All lamps are adjusted for the current and voltage for which they are ordered before leaving the shop. All that the user needs to do is to trim it and keep it clean. For the rough

BRICK FOR STREET PAVEMENTS, by M. D. Burke, C. E. Robert Clarke & Company, Cincinnati. Price, 50 cents. This little pamphlet, which will be of special interest in this age of brick, contains tests of fifteen samples of brick submitted to the author, together with an uncommonly valuable treatise on brick paving in general, giving pointers to the practical engineer that will be of use in his work.

THE JONSON ENGINEERING & FOUNDRY COMPANY, of New York, has bought the frog and switch business of Abram Ayres, and will hereafter carry on that business.

THE UNDERWOOD MANUFACTURING COMPANY, of Tolland, Conn., are in business in their own name in New York at 38 Cortlandt street, having cancelled their contract with the Engineering Equipment Company.

An old lady on an Albany street car recently looked curiously about to discover the source of the heat which she distinctly felt. Finally reaching down under the seat she touched the electric heater, and turning to a tall, lank young man who was standing by her, said: "Sit down, John, there's a warming pan here under the seat."



A BARE POSSIBILITY.

—Flugeude Blatter.

A MISS' MISTAKE.

It was cruel to laugh, but everybody did laugh except the pretty girl who set her white teeth into her pouting lower lip until the blood almost came. The car was crowded when she stepped on and festooned her pretty form on a strap, with a bewildering smile. She evidently knew that everybody was admiring her pleasant face, stylish suit and blonde hair. But pride must have a fall. The warm mittens that covered the small gloved hand were cumbersome and destroyed the sense of touch. This caused the blunder. When the car stopped she gathered up what she supposed was her train and started out of the car. But the train didn't come, so she gave it a vicious jerk. Then a masculine voice said, "What can I do for you, Miss?" She turned and saw that the mittened hand firmly grasped the folds of a man's thick ulster instead of her own habiliments. And one cruel voice remarked "The wrong train that time" as she fled from the car.

LAST September a road was projected between the city limits of Buffalo and Williamsburg. To-day the road is in operation—a very quick construction considering the severe winter. F. W. Arend, the leading spirit of the company, presented the village of Williamsburg with twelve acres of park land at the time of the opening of the road.

Oh, merchant in thine hour of e e e,
If on this paper you should e e e,
Take our advice, and now be y y y,
Go straightway out and advert i i i.
You'll find the project of some n u u,
Neglect can offer no ex q q q.
Be wise at once, prolong your d a a a.
A silent business soon d k k k.

--Tit-bits.

One-Horse Cars for Sale.

We have for sale fifty-one (51) one-horse cars in good order and condition. These cars were built by Stephenson & Jones well-known manufacturers.

They are 10 feet long and seat 12 passengers. Each car is provided with a fare box.

These cars can be seen at the Company's barn, corner Florida Avenue and Eleventh Street, Northwest Washington D. C.

Price, \$100.00

CAPITOL NORTH O ST. & SO. WASHINGTON RY CO.

WANTED.

Original Tables, formulae, and other information of service in electrical work for new book shortly to be issued. When sending your manuscript, state the price, and we will promptly remit if accepted, or will return. Will consider strictly confidential all such information submitted.

THE ANSONIA ELECTRIC CO.

CHICAGO, ILL.

FOR SALE.

HORSES AND CARS.

800 Sound Street Car Horses, A 1 condition, weight, from 1,100 to 1,300, also 50 16-foot horse car bodies, in use from one to four years.

Address:

WOODLAND AVE. & WEST SIDE ST. RY. CO.

Cleveland, O.

FOR SALE.

In adopting Electricity we have taken up ten miles of 32 pound Johnson Girder Rail that has been laid a short time and on which only light horse cars have been run. The rail is practically new, and the ends are not hammered. Will sell all or part, and deliver F. O. B., St. Louis.

Address

Cass Ave. and Fair Grounds R. R.,
ST. LOUIS.



WINDSOR & KENFIELD,
PUBLISHERS AND PROPRIETORS.

269 DEARBORN ST., - - - CHICAGO.
Published on the 15th of each month.

SUBSCRIPTION, - - - TWO DOLLARS.
FOREIGN SUBSCRIPTION, - - - 20 SHILLINGS.

Address all Communications and Remittances to THE STREET RAILWAY REVIEW
269 Dearborn Street, Chicago.

H. H. WINDSOR, Editor. F. S. KENFIELD, Business Manager

CORRESPONDENCE.

We cordially invite correspondence on all subjects of interest to those engaged in any branch of Street Railway work, and will gratefully appreciate any marked copies of papers or news items our street railway friends may send us, pertaining either to companies or officers. Address:

THE STREET RAILWAY REVIEW,
269 Dearborn Street, Chicago.

Entered at the Post Office at Chicago as Second Class Matter.

This paper member Chicago Publishers' Association.

VOL. 3. MAY 15, 1893. NO. 5

Our headquarters at the World's Fair, are in the Transportation Annex, aisle M, South Side, Post 6, where we have something of interest to street railway men, and where we shall be glad to meet visitors.

A SMALL boy dove under an electric car in Philadelphia and was killed in a quarter of a day. On this basis a city paper estimates the probable fatalities for a year at four times 365 and proudly points to a discovery in prognostications.

WIDESPREAD attention has been accorded the "good record" of one of the western street railway plants, published in the REVIEW for February. Our English contemporaries have given the article special attention and distinction. Such statements of expense and income furnish the best recommendation for mechanical traction.

GREAT credit is due Chief Willard Smith, and his assistant in the railway department, J. Hackworth Young, for the energy with which exhibits in the Transportation Building have been assembled, placed and made ready for the public. While other departments, have in some instances, been crippled by delays over which they had no control, the fact remains that on the opening day the Transportation exhibits were more nearly complete than any other department. The gentlemen named have labored incessantly and their courteous and impartial treatment has deserved the uniform gratitude expressed by exhibitors in their department.

ON several occasions demented New Yorkers have cast themselves before the elevated trains and so put the coroner to a lot of bother. The last was that of a young girl and a daily paper calls for fences and gates on the L platforms. Why not require would-be suicides to wear a wire cage or crinoline, instead of increasing the already too numerous discomforts which surround people who are doing their level best to stay alive?

TWO important events will date their history from this Columbian month of May, and doubtless are the forerunners of the day when electricity shall have won its place beside the locomotive. One was the opening of the Lake Roland electric elevated road, at Baltimore; the other the Intramural elevated electric road at the World's Fair. Both furnish a type of transportation in which they are pioneers in this country.

THE legislative committee has decided on a definite proposal for Boston's rapid transit. It is the idea of C. C. Coffin. The city is to provide a clear right of way through alleys and narrow streets and receive proposals for the construction, which is elevated. Then the system would be let for 25 to 50 years to the highest bidder, at the end of which time the ownership and control would revert to the city. The cost of double track structure is estimated at \$1,000,000 a mile.

DURING the month past several paper roads have come to grief. It would be better if more such "died a bornin'" instead of stalking through the financial centers of the land disguised in full grown garments. Such promoters are of unspeakable harm to legitimate enterprise, which is made to suffer and is placed under the ban with the bad. There are desirable investments in plenty, safe, secure and promising, but the inexperienced investor will do well to secure the opinion of a competent advisor before taking chances on a property the workings of which he knows little or nothing.

IN an article commenting on the utility and future of interurban electric railways, the Baltimore Herald says: "The trolley system has been perfected until it has attained a high degree of efficiency. It promises to form a connecting link between the ordinary wagon and the steam railway. Unless all experience is for naught it can be made to subserve a most useful purpose in supplying a means of communication between points where steam railways could not be built, and would not pay operating expenses if they were constructed. When a beginning has been made there can be no end until much more has been done in the way of developing this kind of transit than has yet been projected."

AMPLE transportation was afforded on opening day to and from the grounds. While there will be few occasions during the Exposition which will draw a larger crowd than the inauguration events, the facilities will be improved and increased. On that occasion the World's Fair traffic was:—Illinois Central, 200,000 passen-

gers; the elevated road, 189,000; the cable lines, 140,000; while 20,000 went by water. As previously stated in these columns, the transportation facilities both for speed, accommodations and cheapness, far exceed any attempt ever made, anywhere. The arrangements reflect great credit on the respective companies, and are in every way in keeping with that largeness and enterprise which characterize Chicago undertakings.

WE have recently referred to the vexatious restrictions which have thus far so greatly hampered the progress of the trolley system in England. S. Sellon, C. E., in a recent address before the Tramways Institute of Liverpool, takes as his text, "Tramways vs. Telephones," and shows that the opposition largely springs from the telephone companies. Mr. Sellon calls upon the telephone companies to adopt the metallic circuit. The ruling of the courts in this country where there are an hundred electric railways to one in Britain ought to carry much weight. We are strongly convinced, however, the English public will soon be heard on its own and the railway's behalf, when a few thousands of Englishmen shall have visited America this summer and received an ocular and self convincing argument of what the electric railway really is and does.

ALTHOUGH street railway managers are busy with their "spring work" and find it little less difficult to leave their roads than during the demands of the snow season, still quite a number have already paid their respects to the great World's Fair. All such have but convinced themselves that nothing shall prevent a second and longer visit. At present writing the finishing touches are being given the walks, streets and other exterior works which the unprecedented bad weather of the present late winter have rendered impossible at an earlier date. In the buildings ten thousand busy workmen have toiled unceasingly by day and night and the transformation each passing twenty-four hours has been simply inconceivable to other than daily visitors. We suggest our visitors defer their visit until after June 1st, but from that date we urge an early and long attendance. A week will afford a very satisfactory idea of the Fair, but six months will not suffice for a careful study of every department. But every one should come if only for a day. Indeed a single hour will well repay a trip of a thousand miles, for to look upon the White City is to discover a "new world."

THE importance of the World's Columbian Exposition was fitly demonstrated in the presence of nearly one-half million of people to witness the formal opening, by the president of the United States, of the greatest event of its kind history has ever known. The day, the hour, the very minute, appointed over two years ago was observed with the utmost exactness, and thus did Chicago keep her pledge. True the Fair in all its completeness will not have become a finished creation for two weeks yet, nevertheless all concede that it was inaugurated in a more perfect and orderly condition than any of its predecessors. This, in view of its immensity, for the Lib-

eral Arts building alone contains more than the entire Centennial, is a remarkable occurrence. When to this is added the almost unprecedented bad weather of the two past winters, particularly the last, during the greater part of which outdoor labor was rendered utterly impossible much of the time, the wonder is increased. The calling into life of this great museum of all arts and sciences was executed with bewildering precision, and the great transformation scene which started the motive powers, threw fountains high in air and unfurled a thousand banners to the breeze was accomplished in the twinkling of an eye. While the hushed multitude paused to expect, it was done, and the doors flung open to the world of the greatest treasure of knowledge ever known.

AN effort is making in Massachusetts tending toward legislative enactment which shall abolish the crossing of steam roads by electric and horse railways at grade. Such a protection is certainly a most desirable one, not only for surface lines, but for the protection of any street, wagon road or other steam road crossing a steam road at grade. In England this has already been accomplished, but it will be many years before a similar condition can be hoped for in this country. Indeed, there exists in many cases so little necessity at present for abolishing the grade crossing that the ordinary care which every manager should exercise is abundantly safe and secure. As a matter of fact most surface lines already have—and all should have—a rule requiring the conductor to go ahead and signal the driver when to cross steam tracks. Of course in large cities and where a dozen tracks have to be crossed there is danger in this, but to one such place there are fifty where no such peril exists. Some of the ardent advocates of the no grade crossing are raising the argument that in the case of electric lines the necessity for overhead tracks is much greater than when the same lines were formerly operated by horses. In this we cannot fully agree. Horses are liable to fright at just the critical moment when they are most needed, and the very impending danger is what renders them unmanageable. With mechanical power, however, no such emergency can arise. Of the numerous grade crossing accidents in this city during the past few years we recall but one to cable cars, and that without loss of life, while horse cars have frequently suffered; several accompanied with frightful fatalities. In this, as in many other respects, we believe mechanically operated cars the safer.

THE disinclination of capitalists to hire competent engineering talent, especially on smaller undertakings, is the source of much comment in the technical press; but the disregarding of the advice of engineers and experts already employed is worthy of still more surprise and comment. In fact, not a few directors seem inspired with the idea that they are accomplished mechanical and electrical engineers simply because they have been so far successful in engineering money matters. A case recently came to our notice where an electrical engineer

was hired at a good salary to supervise the construction and initial operation of a road. Under the circumstances it would be supposed that his advice would be followed (unless he was incompetent and this would not be consistent with the fact that he was employed by the road). As a matter of history his advice was not followed on several important points. The management knew more than he did. The result was a plant that no engineer with any care for his reputation would be connected with and his resignation of course followed. This is cited only as an instance of what is constantly occurring on a small scale. Such action not only makes the salary of an engineer a useless expense, because his advice is not followed, but it generally results in a bungling job which is a constant source of annoyance and expense to the company. The sooner capital gets rid of the deep rooted idea that engineers are created solely for the ruination of the companies employing them by recommending expensive construction the better it will be for all concerned. The engineer's interest is necessarily the company's interest, for his reputation depends on the commercial success of his work.

THE California legislature has passed a bill requiring that hereafter all grants of franchises by cities and towns to street railways shall include a concession from the company permitting mail carriers to ride free on all of said companies lines while in the discharge of duty. It is yet an open question whether the bill relating to concessions covering lines already operating and built under former ordinances not requiring any such conditions, can be enforced. In our judgment it cannot. Furthermore, it should not; either as relating to old or new lines, though for the latter there seems to be no relief. There is no valid reason why street railways should bear the burden of transporting Uncle Sam's boys, any more than an omnibus, hack or transfer company should do so. Or, to carry the argument out to its completeness, little more reason in this than making it legal for the carriers to hail a private conveyance going their way and demand passage. The street railway does more toward maintaining the streets than all the others named put together. They pay taxes but so does the railway. If it can be required to carry the United States mail in small quantities placed in a leather sack and the sack hung around a man's neck, why not carry the big leather sacks which require two men to lift. Or, if they carry an aggregate of one hundred small sacks at intervals during the day, why not carry the hundred sacks at one time? The steam roads with a few scattering exceptions in the case of large land grant roads are paid a big price for this service. Why then should the street railway perform this carrier service free? The company enjoys the protection (sometimes) of municipal government and has its being in the free air of liberty; but no more than the manufacturer of gunny sacks, or plows or likethem contributes a big sum in taxes to help run the aforesaid government. In the case of the police and fire departments there enters a wholly different element, namely the fact that in the per-

formance of duty for which they are paid, there is the ever present danger to life. A policeman is called to help the conductor eject a drunken person who may temporarily be a maniac; the fireman enters the burning car house and may be asphyxiated, or a large piece of water may fall on him; but the letter carrier is the most thoroughly protected man in town. With that U. S. bag on his arm the whole government is pledged to his protection, and he scarcely needs an accident policy. No reduction is made to street railways in anything the government has to sell; why then should the reciprocity be all in one direction?

AN editor in Toledo, Ohio, in a moment of desperation for something to help fill his paper, bows three times toward the East and proceeds to torture himself with the self-imposed question: "Why should not street railways pay a wheel tax on their cars?" Sure enough; why not? A moment since we could have solemnly deposed there was no possible avenue through which the street railway could be further taxed. Now cometh the deponent editor with his pesky wheel tax. Just why the said tax should be paid on the cars instead of at the office of the city treasurer we are not informed, but doubtless for some good and suitable reason. But the wheel tax pleases us. The more we think of it the better it seems. Only it falls far short of its possibilities. Before this wheel tax can aspire to the full vigor of sturdy manhood it must be extended and ramified. For instance, there is the trolley wheel; there should be a tax on that; and the wheels in the fare register; to say nothing of the wheel believed by many old women to exist in the conductor's head. But why stop at wheels? Why not tax the steps and the two platforms; the doors and floor mats? Also the seats and the lamps, the window blinds and the sash curtains. All of these are more or less indispensable to the operation of an electric car. For cable lines add to the above the pulley wheels in the conduit, and not to slight the time honored horse lines, let there be a hoof tax at so much a hoof. Any and all of these items commend themselves equally with a wheel tax. The company furnishes the rail on which its cars run, and paves between its rails, the latter effecting a large saving to the city. For pure, unadulterated assininity, to the champion of the wheel tax should the medal be awarded.

PRESIDENT W. MCKENZIE of the Toronto (Canada,) Street Railway Company, has recently returned from an extended trip through the Holy Land.

J. A. HANNA has just returned from a remarkably successful Eastern trip in the interests of McGuire trucks. He will help start the World's Fair, and go on another journey.

THE steam road's agitation at the thought of being paralleled by electric roads is proof enough that more than a casual thought has been given to the subject by the steam road people. Legislation to prevent as far as possible inter-urban lines has begun in Connecticut and California.

TOUCHING THE BUTTON.

IT would take a camera as large in diameter as one of the California big trees which form a part of the exhibit of that state to have caught all the people who were massed in front of the Administration building on May 1st. The REVIEW artist, however, captured a little handful, and our illustration was secured at the very moment when President Cleveland touched the button and shows the Spanish colors as they shot

HOW TO SEE THE TRANSPORTATION BUILDING.

IT will be noticed by glancing at our map of the Transportation building on page 273 that the building and annex are very capacious and to "see" everything will require more time than is at the command of the ordinarily busy street railway man. Our map of the building is the most legible of any guide published and is correct, being taken from the plat furnished by the department.



"THE PRESIDENT WAS SURROUNDED BY HIS CABINET AND WORLD'S FAIR OFFICIALS."

into the air. The president, surrounded by his cabinet and World's Fair officials, stands immediately behind the little table which is seen to the right of the center flag-staff. The crowd back of the president is composed of invited guests and are ranged on a gently rising platform which reaches to the Administration building. The building in the background stretching to the left is Machinery Hall. Some conception as to the size of the buildings can be obtained by noticing the workmen grouped on parts of the statues.

The object of this article is to point out to the visiting street railway man the best and quickest manner of seeing what will most interest, amuse and instruct him in a walk through the Transportation Building. We do not intend to be absolute in our suggestion, nor do we claim to have the best method, we simply tell others a method that has been followed by a busy street railway man.

If your time at the Exposition is limited, and what street railway man's is not, go immediately to the Annex, entering at the east or golden gate and going due west.

About here you will find aisle M, south side, next to the Johnson rail display and A. & J. M. Anderson's exhibit, a desk, space and register of the STREET RAILWAY REVIEW. Enter your name on the register and greet the REVIEW man; he will be glad to see you and not try to sell you anything.

In this immediate section of the Annex will be found the street railway specialties and equipments. Two tracks here are filled with cars and car brakes, car heaters, special motors and other large and small things to be hereafter described and pictured by the REVIEW.

The street railway aisles should be thoroughly canvassed, beginning at the west end so as to be sure of a definite starting point. If your time is very short probably the most interesting display is to the north where the British railway exhibits and old engines lie. If your time is not so short, turn south and examine the foreign railway supplies, engines and trains. Here also are the magnificent engines of the Baldwin, Brooks and other types from American shops and a few locomotive curiosities from various parts of the United States. These are easily seen and will not occupy a great amount of time.

North of the street railway dividing line are to be found the steam road exhibits continued. Here, rearing their huge bulk beside the more delicate street cars, are monster packing houses on wheels from the various cold storage plants, chicken cars, fruit cars, gravel cars, snow plows, railway velocipedes, fish plates, track construction, and in fact, every appliance in heaven above or on earth beneath, or in the waters under the earth that will please our steam road brother's heart and rejoice his soul.

A special fish belly rail construction is one of the most interesting historical sights. The rail is set direct on stone piers by means of spikes let into recesses in the stone. This was one of the earliest attempts at a permanent way and soon given up on account of the great cost and the terrible rigidity of the road bed.

The London ticket offices of the English roads with their big maps of the line and their quaint phraseology, will be well worth seeing.

Near the English exhibit is the car heater man in all his glory, and particular attention is called to the Consolidated Car Company's history of car heating as portrayed in the photographs and drawings.

All through these exhibits are small but interesting displays of rail joints, fish plates, switches and smaller fish of the railway school.

On further north is the wagon and truck exhibit, which is very quickly seen as its nature admits of ready display. The exhibit is mainly American here.

This finishes our cursory view of the Annex, and going east we come to the

MAIN BUILDING,

where more carriages, pony carts, and beautiful sulkies will give the horse men pleasure. There are several hearses there, so magnificent in size and so beautiful, that a sentimental young lady was overheard by the REVIEW to say that she almost wished that she could die in order to get to ride in them. Horses and ponies in plaster

stand hitched to the pretty carts and carriages of all the manufactories of the world. The historical photographs displayed are very interesting and instructive. Canadian and English builders are fond of placing their price mark on the vehicles in American money notation. Whips of beautiful and costly material, and horse clothing of various styles and makes are ranged down the east side. To the west is the exhibit of the Westinghouse Air Brake Company, and further west is the Crane brake, a new device now for the first time placed on the market.

Foreign boats are modeled and exhibited near here, as are also the war ships of various nations. Cooke's excursions, with all the wonders of a trip up the Nile, are in a booth by themselves with Arab attendants.

At the center of the building we come upon the elevator shaft, octagonal in shape and running eight elevators to the top of the building. The round trip is ten cents and well worth the time and trouble as a magnificent view is obtainable from the dome of the building, looking eastward over the grounds.

Don't linger there too long though, but turn still southward toward the marine exhibits, passing under the big trip-hammer model of the Bethlehem Iron Works. Next to this, to the west, is seen the model of the model town of Pullman and new array of railway wheels and specialties. Next comes the boat array. Boats big and boats small, for hand, naphtha, gasoline, steam and oil propulsion are made by German, English and French manufacturers. All are worth seeing. This brings us past the model of a French man of war, where a lot of nice, peaceable looking French sailor lads carry bloody looking, naked cutlasses in their belts.

Past more boats and a few bicycles we reach the south door and are out of the building to return by the Golden Gate and ascend the stair or elevator to the entresol, where saddlery and bicycles, light canoes and curiosities are to be beholden in profusion. Down again and out of the building for lunch and then for the Electricity building, which be ready next month.

No model of the street car horse has yet been placed on exhibition, although it should have its place among the curiosities of a decade ago. There is time yet for some horse man to embalm the memory of the hay motor and give it a place with the sedan chair and jinricksha. The next Columbian Exposition will surely want some memory of the car horse, to show our wondering grandchildren how their parents used to ride.

THE JOHN STEPHENSON exhibit was among the last of those now installed to arrive. One closed car, a grip after the Broadway pattern, No. 100, is now on the Annex floor. This one is beautifully finished, varnished with Valentine's varnish, and finished in a gloss that is the pride of agent Pugh's heart. The Earle patent grip and brake are used on the car, with the addition of track brake, sand box, Smith lamps and Stephenson perforated ceiling. The car is set low and finished in orange. We shall give fuller description next month. Another car and a truck are yet to arrive.

KEY TO THE MAP OF EXHIBITS.

BY reference to the opposite page it will be seen that aisles L and M are devoted to the street railway interests entirely, while O, Z, X and Y claim a few scattering. The notations following the name of the aisle represents by the letters N and S, the north or the south side of the aisle, while the Arabic numerals show the post near which the exhibits are placed.

The group of street railway appliances is catalogued as 81, and embraces classes 504, cable roads and cars; 505, electric railway cars with accompanying devices; 506, horse and other means of propulsion and 507 elevated and underground railways.

It is the just due of this department to say that the classes have been arranged with good judgment and sense of the eternal fitness of things.

The street railway manufacturer as a rule has appreciated the benefits to be derived from a display at the World's Fair, although all have not desired classification under the head of department G, Transportation, and many have been satisfied with joint exhibits in the displays of manufacturers using their specialty in actual use.

Department J, Electricity, claims a large number of the strictly electrical details of electric traction, and the exhibit tracks outside will show a number of operative exhibits.

A number of manufacturers making both steam and street railway supplies prefer to be classed under the steam group, 80. This does not make them the less important as manufacturers, but excludes their mention in the group to which we pay the strictest attention.

CATALOGUE OF GROUP 81.

Anderson, Albert and J. M., Boston; electric railway switches, insulators, and fixtures, L. n. 6.

Baltimore Car Wheel Company, Baltimore, Md.; electric motor truck, R. n. 13.

Bass Foundry & Machine Works, Ft. Wayne, Ind.; electric motor, I. S. 3 and 4.

Bemis Car Box Company, Springfield, Mass.; truck.

Boyle & Colleton, Grand Rapids, Mich.; street car motor, Exhibition track.

Brownell Car Company, St. Louis; street cars, truck, L. n. 7-8.

Burnam & Duggan Railway Appliance Company, Boston; trolley wire brackets and insulators, W. n. 3.

Burrowes Car Shade Company, Portland, Me.; shades and curtains for electric cars, K. n. 3.

California Wire Works, San Francisco; wire cable and Hallidie's first cable car, and cable railway appliances, models, photos and grips, L. n. 16-18, and M. s. 16-18.

Chicago Naptha Motor Company, Englewood, Ill.; street car motor, W. s. 11-12.

Curtis Electric Manufacturing Company, Jersey City, N. J.; electric motors, exhibition tracks (outside).

Cushion Car Wheel Company; electric motor wheels, K. n. 3.

Duplex Street Railway Track Company, New York; track and track material, L. s. 3.

Elevated Suspension Electric Railway Company, Chicago; model of electric railway (suspended) over aisle W.

Frost Veneer Seating Company, New York; street car seats and backs, D. 8-16, (main building).

Genett Air Brake Company, Chicago; air brake, Z. 4.

Hale & Kilburn Company, Philadelphia; seats for cable, electric and horse car seats, D. 3-18.

International Fare Register Company, Chicago; fare registers, L. n. 11.

Johnson Company, Johnstown, Pa.; street railway appliances and track, L. n. 4-5.

Jones, J. M. West Troy, N. Y.; street cars, L. s. 18-19.

Lamokin Car Works, Philadelphia; cars, car gate, etc., L. n. 9-10.

Ludlow, G. M., Elgin, Ill.; model of electric car and track, O. n. 17.

McGuire Manufacturing Company, Chicago; motor trucks, L. s. 15.

Murray, Jasper, Cleveland, O.; street car brake, L. s. between 10-11.

New Jersey Steel and Iron Works, model elevated railway, same as Trenton Iron Works.

Norton, A. O., Boston; jacks for street and electric cars, U. s. 3-4.

Peckham Motor Truck & Wheel Company, Kingston, N. Y.; electric motor trucks, L. s. 16.

Porter Tramway Switch Company, Cleveland, O.; railway switch and trucks, L. s. 12.

Price Railway Appliance Company, Philadelphia; rail joints, Arcade system, W. s. 5-7.

Pullman Palace Car Company, Chicago; street cars and Patton motor, R. s.

Reliable Manufacturing Company, Boston; mechanical track switch, electric heater, etc., L. n. 14.

Robinson Electric Truck & Supply Company, Boston; exhibited in Electricity building.

Street Railway Review, Chicago; itself, M. s. 6.

Standard Fireless Engine Company, Chicago; ammonia motor, L. n. 12.

Standard Railway Supply Company, Chicago; street car stove and specialties, L. n. 12.

John Stephenson Company, Ltd., New York; cable cars, electric car and a truck and appurtenances thereto, with picture of first car of 1831, L. s. 4 to 7.

St. Louis Car Wheel Company, St. Louis; street car wheels, I. s. 3-4.

Suspension Transportation Company, Boston; elevated electric railway in service.

Taylor Electric Truck Company, Troy, N. Y.; motor truck for electric and cable railways, L. s. 18.

Tilden B. E. Company, Chicago; car replacer, wrecking frogs and switches, X. n. 9.

Trenton Iron Works, Trenton, N. J.; wire ropes and cables of every kind both steel and copper exhibits, by Cooper, Hewitt & Company, New York; Y. n. & Z. s. 4-5.

Valley, John N., Jersey City, N. J.; model of elevated railway, W. s. 10-11.

Wheeler, Harris A., Chicago; street car seats, D. 8-17.
 Whitney, A. & Sons Car Wheel Works, Philadelphia;
 boxes and pedestals for street cars, K. n. 3-4.
 Wharton, Wm. Jr., & Company, Philadelphia; track
 material, frogs, switches and other appliances, L. n. 3.

start before May 1st. The electric motors and work of
 the General Electric Company will prove one of their
 best exhibits in propelling this novel, and, for its intended
 purposes, very practical system of transportation. Our
 readers cannot afford to miss seeing the moving sidewalk

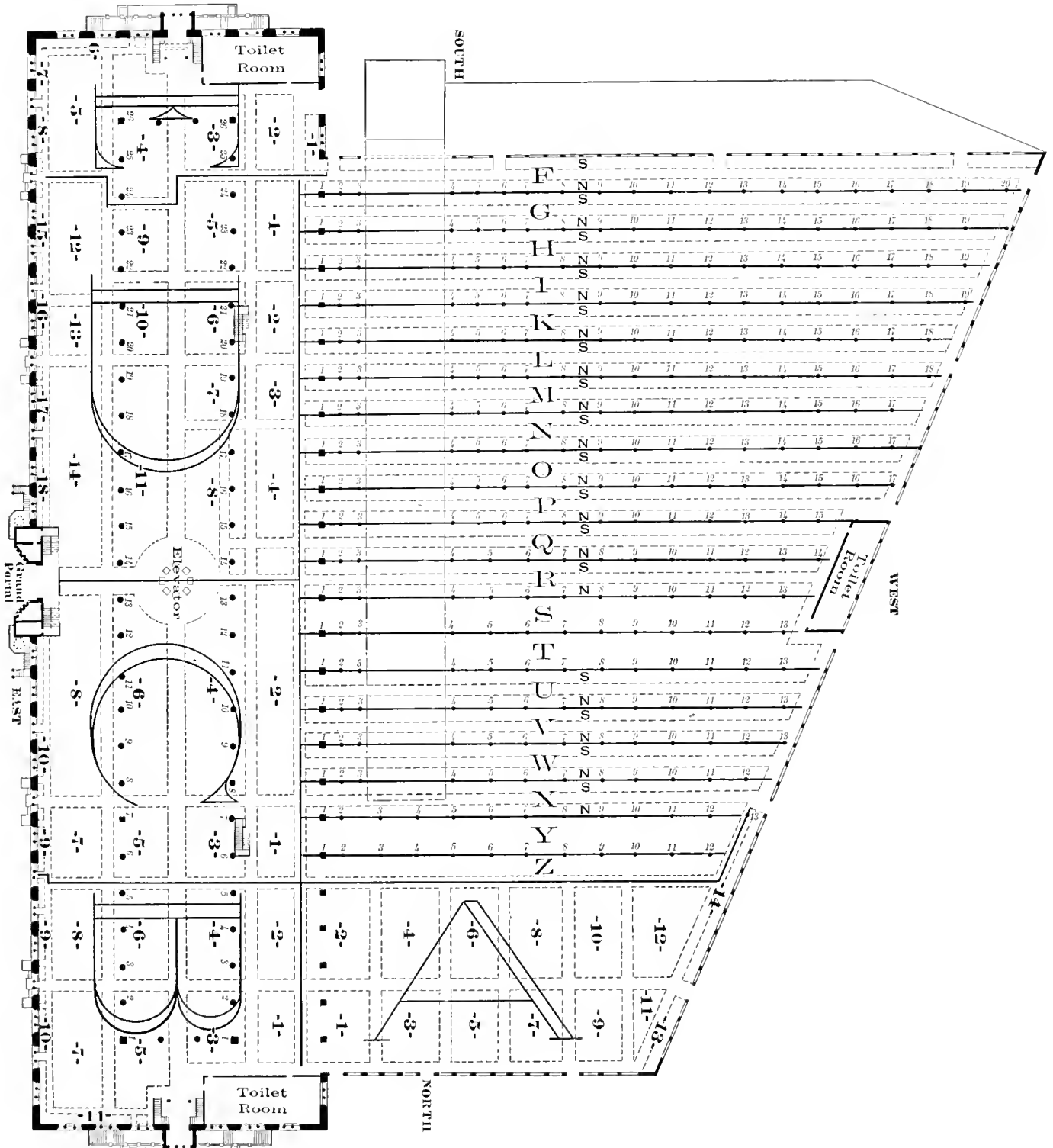

PLAN OF TRANSPORTATION BUILDING AND ANNEX. MAIN BUILDING MARKED B, C, D, E.

THE movable sidewalk was completed and in readiness
 to run on April 15th, but owing to a delay in Machinery
 Hall, from which electric power is rented, was unable to

and will find the ride of 2,000 feet out into the lake a
 charming one, affording a splendid view of the White
 City.

THE FERRIS WHEEL.

ALMOST like a part of the anatomy of a big watch, the giant Ferris wheel looms up into the sky above the Plaisance. It is intended for an observatory and to this end G. W. G. Ferris has planned it. The wheel proper will be 250 feet in diameter, built of structural iron and the top will be 264 feet above the ground. There will be practically two wheels, 28 feet 6 inches apart and connected by bracings. The wheel will turn on a steel axle of enormous size, 33 inches diameter, 45 feet 2 inches long and weighing 89,320 pounds. It cost \$35,000. It was forged at the Bethlehem Iron Works and shipped to this city in March. The passengers will sit in plate-glass-window cars and travel the full circumference of the wheel. The cars are always dependent and self-equalizing.

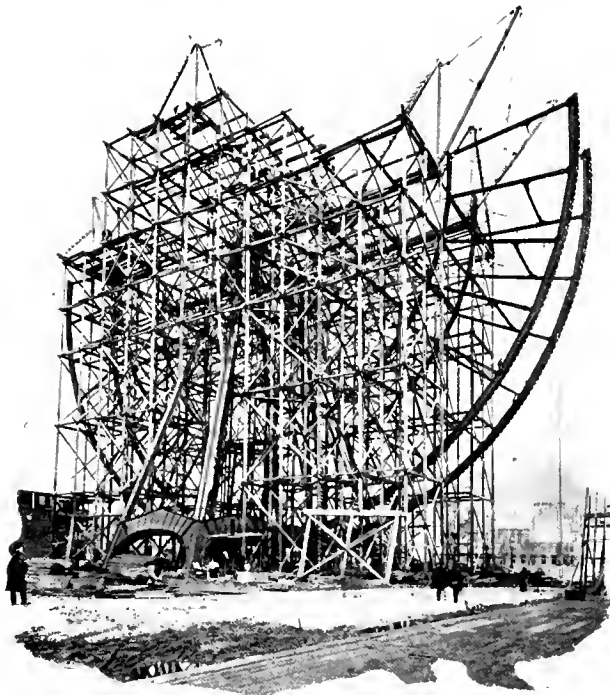

THE FERRIS WHEEL.

The axle is supported on steel towers 137 feet high, each having four main columns, the two inner ones vertical and the two others inclined. The towers are 50 by 40 feet at the base and 6 by 5 feet at the top. They are set on masonry piers, having pile and concrete foundations with a load of not over 2,000 pounds per square foot at base.

There will be 36 passenger cars arranged on the rim of the wheel. Each car accommodates 60 persons. Passengers will be given two complete whirls, occupying about 20 minutes and going about one-third of a mile.

The total weight of the structure is 4,300 tons, 60 per cent of which will be in motion. Two reversible engines aggregating 2,000-horse-power will be used to turn the wheel, driving a train of gearing wheels 12, 14 and 16 feet in diameter. F. J. McCain & Company, Chicago, have the contract for construction and the total cost will be about \$300,000.

JOHN STEPHENSON COMPANY, New York, send out an elegant Broadway grip car and electric car and a truck in charge of Sales Agent Pugh. They are fine in finish and practical in appearance.

COVERED in its black night robe, the Brownell accelerator is awaiting the finishing touches that Brownell's decorators know so well how to put on. The ceiling of this car will be a work of art worthy of special place in the art gallery, but much more appropriately placed in Brownell's beautiful closed car. A Brownell truck stands west of the car. They are both recent arrivals.

THE J. G. BRILL COMPANY had a catnip fit and withdrew their application to exhibit because the Chief of the Transportation Department could not give them the largest and best space in the building. The space thus vacated was eagerly secured by another exhibitor of various street railway appliances, and both the Transportation Building and, indeed, the World's Fair was opened on time just the same as if nothing had happened. Now the Brill people are trying to move heaven, and earth and the Chief of Transportation Department to get in. We do not see how it can be granted in justice to other exhibitors, some of whom, by reason of unavoidable delay, were forced to curtail their expected display in order to comply with the "everything in by April 30th" order. Two prominent car builders, however, have remarked they regretted the absence of the Brill exhibit, as they had no fears that their own would suffer any by comparison.

THE condition of the Electricity Building at the World's Fair, is, as we go to press, in a sadly deplorable state, and reflects little credit on the executive management of that department of the Exposition. The excuse now advanced that the foundry where the staff work is made was slow, simply begs the question. Hundreds of packages now remain untouched, and the exhibit as a whole is in a chaotic condition. The order issued by Chief Barrett on May 9th, that after May 14th no further work would be allowed, and exhibits then unpacked or unmounted must so remain, should have been given long ago. The eyes of all the world are turned toward the electrical exhibit as promising the greatest interest of any department, and thousands daily have already been turned from its doors in disappointment. While the blame is mutual as to chiefs and exhibitors, the fact remains that the heads of other departments found a way—and where they could not find a way made one—to have their buildings in at least a presentable condition two weeks ago, and Chiefs Barrett and Hornesby might have followed the example of the Transportation Department with profit. Credit is due the gentlemen named for the classification and grouping of their exhibits, which is excellent, and for having drawn the line wisely in barring out electrical "fakes"; but the laxity which has governed exhibitors now results in mortification alike to exhibitors and management.

A STROLL THROUGH THE TRANSPORTATION BUILDING.

IT is not without interest to read the artistic and architectural details of the Transportation temple as related to a REVIEW correspondent by a prominent Chicago artist and architect.

"The building is considered," said the gentleman, "an exquisitely refined and simple piece of architecture, beautifully in proportion and fittingly interpreting its function. Its elaborate detail does not overcome the simple and pleasing effect of the whole. The style savors of the Romanesque, although the design on axial lines and the proportions show the methods of composition followed by the Parisian School of Fine Arts.

Viewed from the dome of the Transportation the grounds may be seen to the most artistic advantage.

The main entrance on the east side of the Transportation is the already noted Golden Gate, which consists of a magnificent single arch enriched to an extraordinary degree with carvings, bas reliefs and mural paintings, the entire forming an exquisite effect, rich in coloring but quiet.

The Roman basilica is the motif of the interior, with its wide nave and aisles.

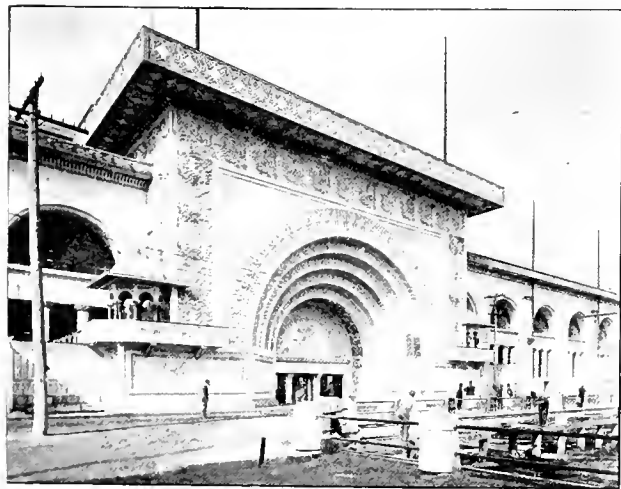

THE GOLDEN GATE.

Three divisions form the roof, the middle being the highest and terminating in a dome. The three form an arcaded clear story. The cupola rises 165 feet above the ground. Here is a bank of 8 elevators set in octagonal space and running to the dome, and form a part of the transportation exhibit. The galleries of the second floor of the building are easy of access on account of three elevators and as they contain the bicycles and other light and popularly attractive goods, will be centers of great interest.

The main building is 560 feet east front, north and south, by 250 deep, east and west. However, to the west extends the Annex so often previously described, which runs to the Stoney Island avenue fence.

The Annex is 425 by 900 feet and covers 5.8 acres, the Transportation proper covers 5.6 acres, making a total of 11.4, at a cost of \$370,000.

The exhibits here are now nearly all in position and without doubt the Transportation department deserves the distinction of being the most nearly completed. The transfer table gangway has been already closed, and the big engines, little engines, cable cars, ammonia motors, rails, ropes and rigging are all standing up and looking their best while awaiting the first prize, which all confidently expect.

Wandering over to the Annex the first thing that will attract the visitor's attention is the beautiful and graceful mountains of iron and steel from the engine works of Baldwin, Brooks, and those of English make. It seems as if a push of the hand would cause them to start into life.

Not less interesting are the palace coaches from Germany and England. In the former especially the small department marked "Nichtraucher" warns the pipe lover that his pet meerschaum must repose in his grip while traveling there. The side entrances of the English coaches with the little kennel for the "guard" are objects of surprise to the strictly American traveler, whose first trip has been the one that landed him in Chicago.

Set in their little glass houses the naval displays of models are thronged by crowds who are anxious to familiarize the eye with the proportions, colors and conveniences of ocean travel or whose war like spirit rejoices in the murderous looking minatures of big guns.

Swing bridges and draw bridges, railway bridges, and all kinds of bridges are collected in the lower part of Transportation proper, while divided by the titanic trip hammer, marked Bethlehem Iron Works, stands a rack of pipes showing how Geo. Westinghouse brakes the speed of 100 cars. The latter exhibit is correct to an inch and forms one of the most interesting of sights.

The foreign nations show pictorially and practically their means of transporting passengers and freight. The snow-capped Alps in a panoramic view, the path of the English roads through the historic shires of England, miniature booking office, railway guides and every department of traffic makes the big red building a mass of conventions and a grand round-up of world wide traffic experience.

THE GOLDEN GATE.

of the Transportation is the most remarkable and beautiful feature of the building. Under its low portal drift the thousands who come thither to behold, to many, the most interesting of all the exhibits. The rich coloring and appropriate bas reliefs are finished in silver. At the right of the arch in golden letters appears the legend:

"There be three things which make a nation great and prosperous: a fertile soil, busy workshops and easy conveyance for men and goods from place to place."—Bacon.

At the right appears the following inscription from the words of one of the greatest of Englishmen:—

"To all inventions, the alphabet and the printing press

excepted, those inventions which abridge distance have done most for civilization."—Macaulay.

Then there might have been inscribed the voice of all modern political economists, saying: "He who affords a city rapid transit giveth its inhabitants freedom from the landlord's slavery, healthy and happy homes, pleasure and profit."

THE ELECTRIC LAUNCHES.

INTRAMURAL transportation by water is legitimate copy for the World's Fair editor of the STREET RAILWAY REVIEW, and it may be also of interest to the storage battery people, expectant, as well as to the overhead trolley people, exultant.

The launches, one of which we show herewith, when in their native element, are combinations of grace, elegance and noiseless motion, unexcelled on earth or in history, gliding swiftly, surely and silently in the waters of the lagoon, the poetry of motion and the perfection of

construction was the conception of Frederick L. Olmsted, landscape gardener for the Exposition. The lagoons give three miles of roadway or rather waterway, all double tracked. No bonding of waves is required.

The general dimensions of the boats used are 35 feet 10 inches by beam of 6 feet 3 inches. They will carry 30 passengers each, and have a draft of 28 inches. The Consolidated Storage Battery Company furnished the batteries, and the General Electric Company the specially designed motors for the craft. The batteries and motors are placed beneath the seats and flooring. Each boat will cover an average of 40 miles a day, with one change, giving a total of 2,000 miles to the fleet, daily. Six miles an hour is the speed allowed for the boats, but two miles more is at the control of the skipper if emergency requires it. The motors are 4-horse-power and connected directly to the propeller shaft. The controlling device consists of magnetically controlled switches operated by a lever. Four speeds ahead and two astern are found to



ELECTRIC LAUNCH ON MAIN LAGOON, WITH HORTICULTURAL BUILDING AT LEFT AND ILLINOIS STATE BUILDING (WITH DOME) IN DISTANCE.

grace. The poet of the future will some day be compelled to pigeon-hole his ballad of the brown armed fisher lad pulling at the ashen oar and sing a song after this style:

Oh! 'lectric launch, thy praise I sing,
While skimming swiftly o'er the wave,
As on thy breast I safely rest,
As battery grids my back aches save.
Forgive me, goddess, that I sang,
When I was young, of ashen oars,
For now I hail the rheostat
And praise the "bats" with 'lectric stores.

To return to our mutton after this ecstatic flight: the electric launch fleet numbers 50 sail, or rather "bat," owned and operated by the Electric Launch and Navigation Company, of New York. The launches are of the pattern of the prize winning Electra of last years' fame.

General C. H. Barney, of New York, is reputed the originator of the idea, and the general plan of lagoon

fill all requirements of naval storage battery practice.

Fifty-two volts is the required pressure for the regulation speed, for which the batteries are grouped in three divisions of 26 cells in series. When in operation there is a discharge of 42 to 45 amperes, aggregate.

THE five big electroliers in the manufactures building are 60 feet in diameter and accord in size with the hall in which they are placed. They weigh nine tons and hold 78 arc lights. The largest one, which hangs in the middle of the floor, weighs twelve tons and supports 110 lamps.

THE Arab guide in the booth of Cook's excursion men, attracts no little attention, and more than one woman, who has made remarks about him, has been metaphorically knocked down by his Arabship's tender voice, saying: "Zis, madame, is ze great Pyramid," etc., etc.!

ROLLING CHAIRS.

NOT only invalids and ladies, but the tired world in general, may be expected to patronize the conveniences offered by the Columbian Rolling Chair Company, whose vehicles are represented by the accompanying engraving. The chairs are 2,400 in number, and were made by the Wakefield Rattan Company and the Haywood Rattan Company. The bodies of the chairs are made of rattan with cane seats. The wheels resemble those used on bicycles and have $1\frac{1}{4}$ inch rubber tires. The chair is very light, strong and durable. The wheels are four in number, the front ones being pivoted for guides, and can be lifted clear of the ground when ascending or descending hills. Double chairs for wedding parties, with two attendants, are also awaiting occupants and will probably be in large demand.



ROLLING CHAIR—(GOSPEL CHARIOT.)

These chairs will be the only surface conveyances allowed within the grounds and will no doubt claim their share of patronage. The rates are very reasonable, varying from 75 cents an hour for single chairs to \$1.00 for double chairs, with attendants. If your wife or friend desires the company of yourself alone, 40 cents an hour will be charged for the single chairs, an hour, and 60 cents for the double ones.

The attendants are all physically capable, young theological students from various colleges, who wear a neat blue uniform and are well posted as to the what's-this-ness and why's-that-ness of the Columbian Exposition.

The method of timing the chairs is unique. At the fourteen various chair stations on the grounds, are placed

clocks, regulated perfectly. When a ticket is bought it is stamped with the day, hour and minute, by means of an automatic time stamp, regulated by the clock. By this means all contention as to time and price will be obviated.

CONSOLIDATED CAR HEATING COMPANY'S EXHIBITS.

THIS is the letter of the aisle, on the south side of which, occupying posts 1, 2 and 3, the Consolidated Car Heating Company, of Albany, N. Y., has its exhibit already installed. The display is in two parts, one an oak case 50 feet long by 14 feet high and the other a model of a railway train showing all the Consolidated methods.

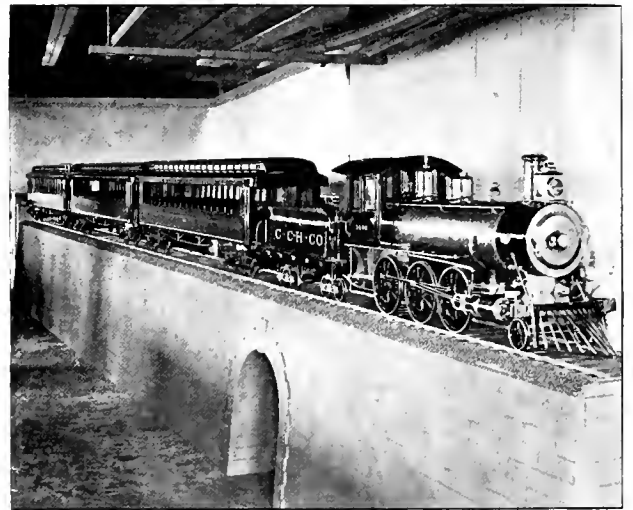

PART OF C. C.-H. EXHIBIT.

The oaken case, which is upright, has seven panels, each separated by mullions all finished in natural oak. The effect is artistic and by means of these panels the successive details of car heating are shown.

Far to the right as the visitor faces the case is the "commingler" system shown with its fire-proof heater. This, together with the next panel, which contains full sized details of the temperature, regular and direct steam system, will be of interest to steam road men. Next comes the hot water heater, represented by the C. C. H. Company's multiple circuit system, which is shown in general and in detail, with all appliances used for regulation. Engineers will see here also steam gauges for the locomotive, pressure valves full size and sections of relief and large throttle valve. Next the details of the commingler system are arranged for inspection and last and of greatest interest to our readers, the details of the electric heater described at length in the April issue of the REVIEW. The various parts are so shown that each is seen in full detail, and to help the imagination, a longitudinal section of a street car is placed on the floor beneath, giving in full size and ensemble the heater as it is placed in the riser. The only evidence to the eye of a

system of heating is the wire grating which is rather ornamental than otherwise, but to the feelings of cold passengers last winter on a goodly number of lines the evidence of the effectiveness of the Consolidated Car Heating Company's electric heater was both plain and pleasing.

The next to the last plant is a curiosity as it contains the pictorial history of car heating from the early box heater of 1847 to the scientific commingler system that provides for every exigency by adopting all the latest knowledge of calorics. Lastly to the east end of the

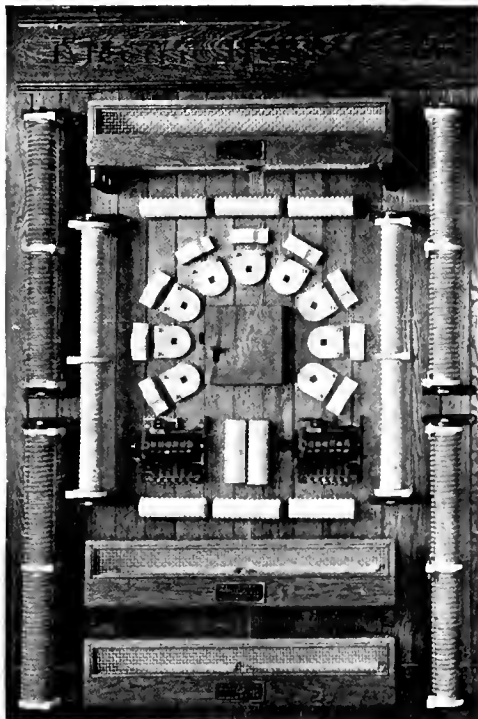

PANEL OF C. C.-H. CO.'S. EXHIBIT, SHOWING PARTS OF STREET CAR HEATERS.

board stands a full exhibition of the multiple circuit system in full.

Standing on an imitation stone viaduct with culvert track, road bed, rails, and all complete, is a train of an engine and three cars. They are all one-eighth size to scale. The show the steam connections and methods of heating by the Consolidated Car Heating system, three in number, two hot water and one steam. The train is perfectly lighted by ten 2-candle-power incandescent lamps on electroliers with a small lamp under each hood. The engine alone cost \$1,600 and the beauty of the exhibit collects a large crowd both of railroad men and lay brethren and sisters.

E. J. McElroy is engineer in charge of the exhibit. He will take pleasure at any time in talking C. C. H. to all comers.

RUSSELL HARRISON and his eastern friends are actively engaged acquiring Indiana roads. The Terre Haute line is the latest bought.

THE GENERAL ELECTRIC DISPLAY.

ALL visitors to the World's Fair during the month of May were not a little surprised to find the Electricity building still in a stage of incompleteness. The various causes working trouble have been sufficiently explained before and need no repetition here. One main exhibit is, however, pretty nearly completed.

The space on the main floor near the center of the building and radiating north, south, east and west is devoted to the energies and resources of the General Electric Company. Under special commission from the Lynn factory, Lieutenant E. J. Spencer has charge of the General Electric's magnificent historical and manufacturing display.

The offices of the company occupy the space on the east of the center way catalogued as offices and comfortably situated. Directly in front of the offices in the south center of affairs is the railway display, which consists of several trucks upon which are mounted General Electric motors. The catalogue of the trucks, which are tracked in semi-circle, read as follows: One McGuire carrying two single reduction F, 30-horse-power motors; one Taylor carrying two water-proof 30-horse-power motors and a Genett air brake; one Bemis truck with two water-proof 50-horse-power motors, and a Stephenson truck equipped

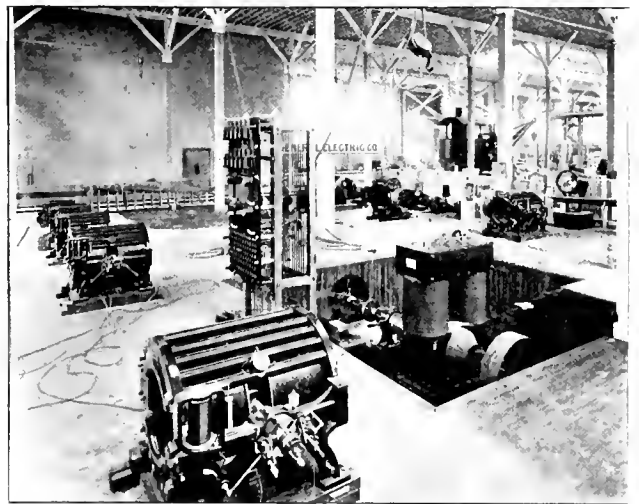

OPERATIVE ARC LIGHT PLANT IN GENERAL ELECTRIC EXHIBIT—ELECTRICITY BUILDING.

with two new L. W. P. 60-horse-power, four pole type. A Jackson & Sharp intramural railway truck is also represented with a full complement of controlling apparatus described in the last issue of the REVIEW. In the center of this circle stands a Robinson radial truck frame complete, without car body, carrying an equipment of two water-proof 50-horse-power motors. The Wm. Wharton track work upon which the truck stands is a fine specimen of modern construction. Wharton girder rails and chairs are used with frogs and cross overs.

Standing in a row in front of the trucks are three railway generators. The center one is a 300 kilowatt multipolar flanked on each side by two smaller of 100

and 200 kilowatt each. The large units of 500 to 1,500 kilowatt are found in the Intramural power house. The whole exhibit is a complete showing of the best and most widely known products of General Electric genius and the display is arranged with both artistic and mechanical effect.

Next to the railway display are to be seen every variety of special motors for house, factory and mercantile use. A complete line of Edison and Thomson-Houston special motors are in this space set forth ready to pump, pull, push or supplement the honest toil of any motor using man.

Opposite the railway display on the east is an arc light plant in actual operation, furnishing arc lights for the building. Diagonally opposite the center and under the same gallery is the isolated light department, displaying the standard type incandescent machine and the new types of direct driven isolated lighting machinery. The alter-

direct machine made, and loaned to the General Electric by the New York Illuminating Company. It has been in service 11 years and will be returned to again take up hard labor.

The Edison column of light, which forms the central attraction of the main floor, is planned after the German tower of Victory. Below in the colonnade the beautiful display of electric glass ware and the surmounting glass lamp of 30,000 pieces forms a never to be forgotten sight.

The total space occupied is 300 by 350 feet in the Electricity building, besides the track space south of the Transportation and the exhibits within the latter building. The intramural road and power house is also catalogued as an exhibit.

Lieutenant Spencer's work has been magnificently carried out and the grand display will attract the thousands it has meant to touch and thrill.

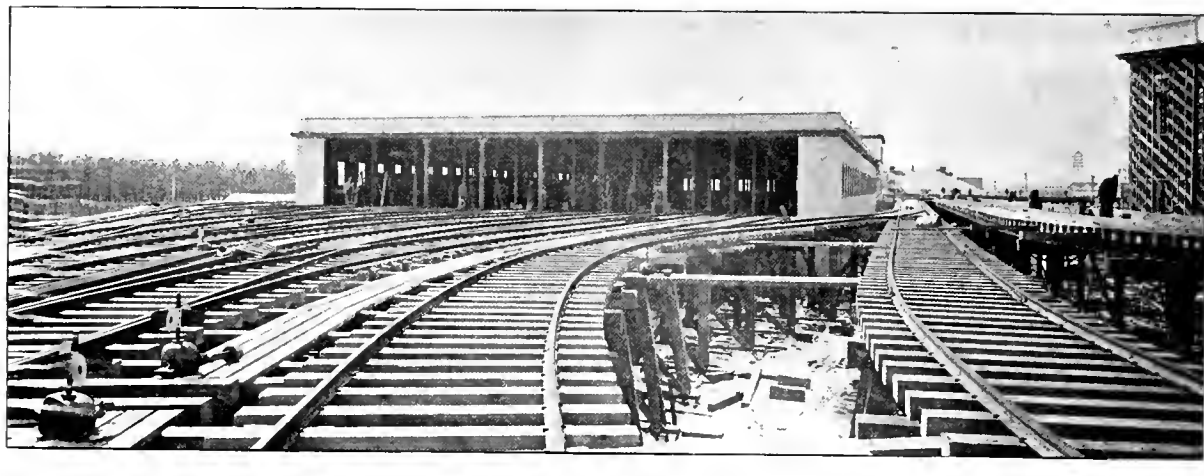

CAR HOUSE AND TRACKS OF THE INTRAMURAL RAILWAY—SHOWING CURVES.

nating plant east of the center includes a direct driven alternator in connection with a McIntosh-Seymour engine.

In the same class of display are also actively operated the Edison type engine, the Lake Erie, and the M. C. Bullock engines directly to General Electric multipolar generators, which have the latest iron clad armatures. This engine-generator exhibit is in machinery hall and forms a very interesting feature of the initial power supply.

At the end of the east display is the very interesting marine exhibit, here are shown the ship lighting plants both direct and belt driven, and search lights, with the projector recovered from the U. S. S. Trenton, wrecked off the Samoan Islands.

There is also a fine display of hoist, drill and electric locomotive specialties in the space to the Northwest of the center. The three phase apparatus is well represented.

North of the center is the incandescent three wire system. The grand center piece here is Jumbo, the first

INTRAMURAL OPENING.

ON Thursday, April 27, occurred the formal opening of the intramural elevated electric railway at Jackson Park. The REVIEW has from time to time described the progress of the work of the engineers and electricians upon this unique road; and anything descriptive would be only repetition. Suffice it to say, that the machinery in the very compact and elegant power house is now in actual service and the verdict of the public is "very good."

Perhaps few power houses are blessed with as much power per square foot of floor room as the intramural, which is estimated at 1.87-horse-power per square foot. Mr. Matlock's structure is worthy of his experience and hard work as also are the results of the electricians C. H. Macloskie and G. K. Wheeler.

At the invitation of General Manager W. E. Baker, fully 150 guests assembled at the Fifty-seventh street station of the intramural. Among those present were B. E. Sunny, T. P. Bailey, Geo. K. Wheeler, B. J. Arnold,

Engineer C. P. Matlock, C. H. Macloskie, Lieut. E. J. Spencer and others of the General Electric Company, with their wives; the daily press of the city, correspondents of foreign papers, and the technical press represented by the Western Electrician, the Street Railway Journal and Gazette, the Electrical Industries, and the STREET RAILWAY REVIEW, besides a few representatives of the general public.

The easy, steady motion with which the train starts is highly commendable, and although the sinuosity of the line renders high speed undesirable, the trip affords in many respects a larger conception of the grounds and buildings than can be obtained in any other way.

Four cars, each seating 100 passengers, comprise a train. The motor car, which is similar to the others, carries over 500-horse-power, divided among four motors, two on each truck. The same general plan of fare collections and handling of passengers is employed as on other elevated roads.

THE MAMMOTH SWITCHBOARD.

REACHED by two galleries, the magnificent switch board in Machinery Hall, will be the most visited point in this interest crowded room.

There are really two boards, both constructed of beautiful white marble and arranged in tiers. The upper board holds the switches, controlling the exciter machines which are four in number and rejoice in the appellation

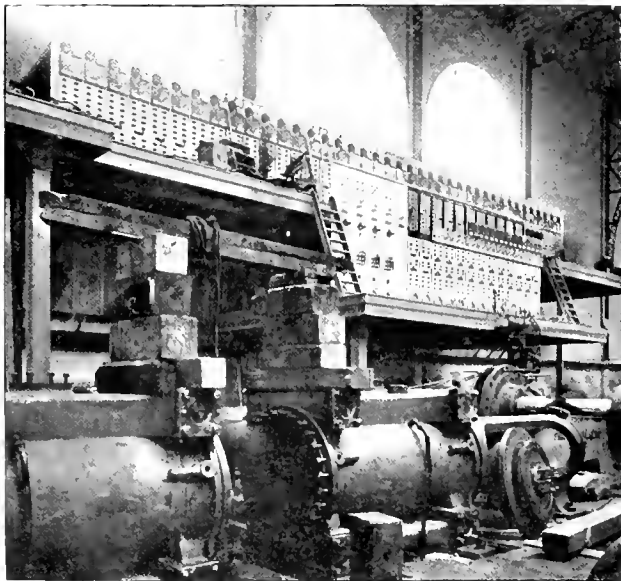

THE WESTINGHOUSE SWITCHBOARD—MACHINERY HALL.

of the "direct connected kodak type." They are wound for 250 volts, and have a capacity of 400 amperes each.

These four machines furnish the "excitement" for twelve 10,000 light and two 4,000 light alternators, which, together, compose the Westinghouse lighting plant. They work in multiple. This board is known as the standard Westinghouse board.

The other, or dynamo board, is divided into 26 panels, all seemingly alike, and each controlling a separate generator. As each of the 10,000 light generators is really two machines, it requires two panels to each of them. As there are twelve of these, a simple arithmetical equation of $2 \times 12 = 24$, accounts for all but two panels and these control, each, one 4,000 light machine.

Two field rheostats, field switches, dynamos, changing switch, ammometer, pilot lamp and voltmeter, compose each panel.

The feeder system attached to the switch board is complete in every detail and will be examined with interest by every visiting electrician.

The Westinghouse board is 71 feet long by 9 feet $3\frac{1}{4}$ inches high, while the lower board measures 38 by 11 feet $1\frac{1}{4}$ inches.

Our engraving represents the board as well as photographs can paint the resplendent marble and glittering brass. The Westinghouse board was constructed by a special commission from the Pittsburg factory.

SOUTH AMERICAN OX CART.

SOUTH AMERICA contributes to the curiosities of transportation by sending in the remarkably light and graceful chariot represented in the engraving herewith presented. The heavy wheels and

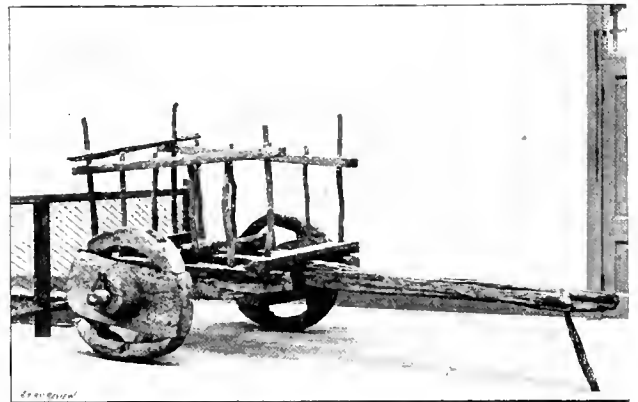

SOUTH AMERICAN OX CART—TRANSPORTATION.

rustic body of the vehicle are set in strong contrast by being placed in the entresol, next to the latest and lightest bicycles. This vehicle attracts considerable attention.

THE TROLLEY PATENT AGAIN.

THE patents recently granted to Chas. J. Van Depoele, (deceased), and assigned to the Thomson-Houston Electric Company, are claimed to be fundamental ones on the trolley. The patents are said to cover the underneath contact made by a rolling wheel or a sliding spoon, the overhead contact by wheel or spoon and the reversibility of the trolley pole, allowing the contact to be made on either side of the trolley wire. Fundamental patents on the trolley seem to be numerous but the name of the distinguished inventor, Van Depoele, would probably add value to this patent.

WESTINGHOUSE REPRESENTED.

THE Pittsburg people are in no wise careless of their representation at the world's jubilee of arts and sciences, and have placed before the throngs at Jackson Park a full view of the works wrought by Westinghouse.

The installation of the company's exhibits come under two general divisions, active and displayed, while these two are again divided by location into five parts and distributed appropriately over the grounds.

The five main exhibits of the firm come in equal prominence under the jurisdiction of Professor Barrett in

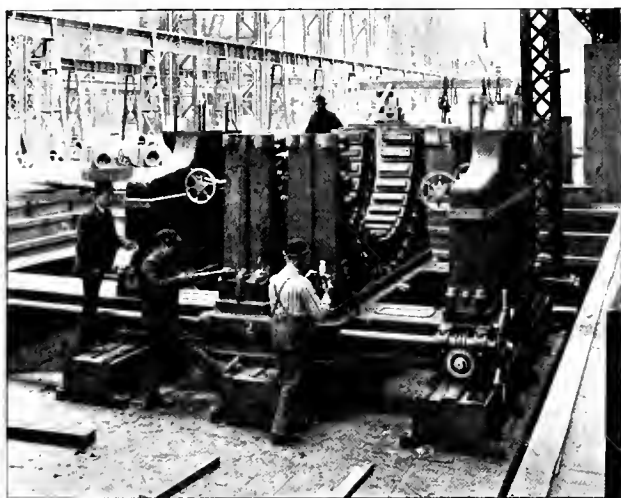

ERECTING WESTINGHOUSE GENERATOR—MACHINERY HALL.

the Electricity Building, and under Chief Robinson in the Machinery Hall, which latter holds the most generally interesting of the features and the greater portion of the working exhibit.

In Machinery Hall are installed the twelve 1,000-horse-power alternating machines, and 700-horse-power direct current dynamos in active operation to the end of furnishing light to the grounds and buildings, as further noted in the description of the Westinghouse switchboard. Part of the arc lamps, about 2,000 in number operated, also run from this regular lighting plant, being run from economy coils connected to secondaries of the transformers. We show in our engraving a view of this installation in process of erection.

H, 1, of the Electricity Building, means that the Westinghouse Electric & Manufacturing Company has a space so marked where the railway department will place its wares on exhibition.

Two types of their railway generators will be here exhibited, both of 500-horse-power, and both turning, one as a generator and the other as a motor. An interesting feature of this exhibition is the "Kodak" outfit, in which the company takes particular pride. This installation purports to show the minimum of space and maximum of power possible by the direct connecting of a 500-horse-power multipolar generator, 375-kilowatt, with a Westinghouse Machine Company engine. A complete out-

fit of motors and cognate specialties will be shown in this connection, both in active operation and in detail.

In J, 2, is the electric arch, clustering upon which are hundreds of incandescent lamps, glowing like stars upon the magnificent arc which divides the two plants of the long distance transmission exhibit. These two, known as the generating and receiving stations, will be centers of interest to every electrician who visits the Exposition. A multiphase 500-horse-power motor here in the receiving plant drives a generator giving both direct and alternating currents. Every method of power will be illustrated, from the belt drive and direct connected engine to the just mentioned long distance transmission, and a generator direct connected to a Pelton water wheel. Examples of long distance transmission will be also shown, either with alternating or direct current, obtained at any point of the distribution at will. Tesla motors will be shown in this connection, operating various industrial machines, besides a railway motor truck running from direct current circuit, obtained from a portion of this long distance transmission of power apparatus.

B, 1, of the Electricity, is the section devoted to the interests of meters, transformers, and accurate measurement apparatus generally, while B, 2, will strive to set forth direct current types of machinery and supplies.

In the regular transportation exhibit there will be found on the display tracks south of the Transportation Building two cars equipped with Westinghouse motors and material.

After this short sketch of what may be expected it is useless to remark that the displays of the company will

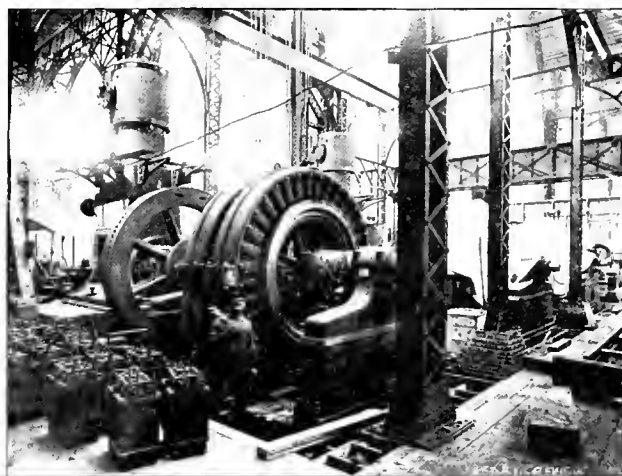

WESTINGHOUSE GENERATOR—MACHINERY HALL.

be of intense interest. In fact, the whole range of electrical thought, workmanship and mastery has been brought out by the various electrical companies to instruct the electrician, please the industrialist and capitalist, and astound the lay public.

The Westinghouse exhibit is in charge of E. E. Keller, of the Pittsburg office, who is here the manager and general superintendent of the Westinghouse electric lighting installation. O. H. Baldwin, of Pittsburg, has charge of the exhibits in the Electricity Building.

THE LAMOKIN OPEN CAR.

BACKED by the sturdy exhibit of the big and handsome cars of their steam brethren, the great number of street railway cars are most advantageously displayed on either side of aisle L of the Transportation annex. The large skylights above give an abundance of light, and, as hinted, the effect is heightened by the proximity of the steam cars exhibited in the background. On the north side, occupying spaces 9 and 10, stand the creations of the Lamokin Car Works, of Chester, Pa., of which concern E. H. Wilson & Company are proprietors.

Wilson & Company have certainly done themselves great credit in this exhibit, which consists of an open and a closed car, the former of which will demand our attention this month.

The style of the open car is one much favored by the Lamokin people, having vestibuted ends with large win-

The curtains are, in addition, wadded across to prevent blowing in. The side festoons of the interior are of gold draping, tastily arranged close under the side ceiling.

The car is well constructed below as above. It is wired for the Westinghouse system having, ten electric lights, two of which are arranged for service behind the signal at either end. These signals are of three colors of Cochran's patent device. Two of Cochran's sand boxes are on the car and the brake is of the lever type.

The side sills are steel plated their whole length to the thickness of half an inch. A noticeable feature of this car is the Stanwood steel perforated tread step, which runs the whole length of the car on each side. These steps are the first introduced by the Stanwood Company and add much to the beauty of the car as well as to the safety of the passenger and employe. The car is fully equipped with radial bars, headlight and foot gongs, while the trolley board on the roof is the latest patented device of Mr. Cochran. This trolley board is solidly fastened at either

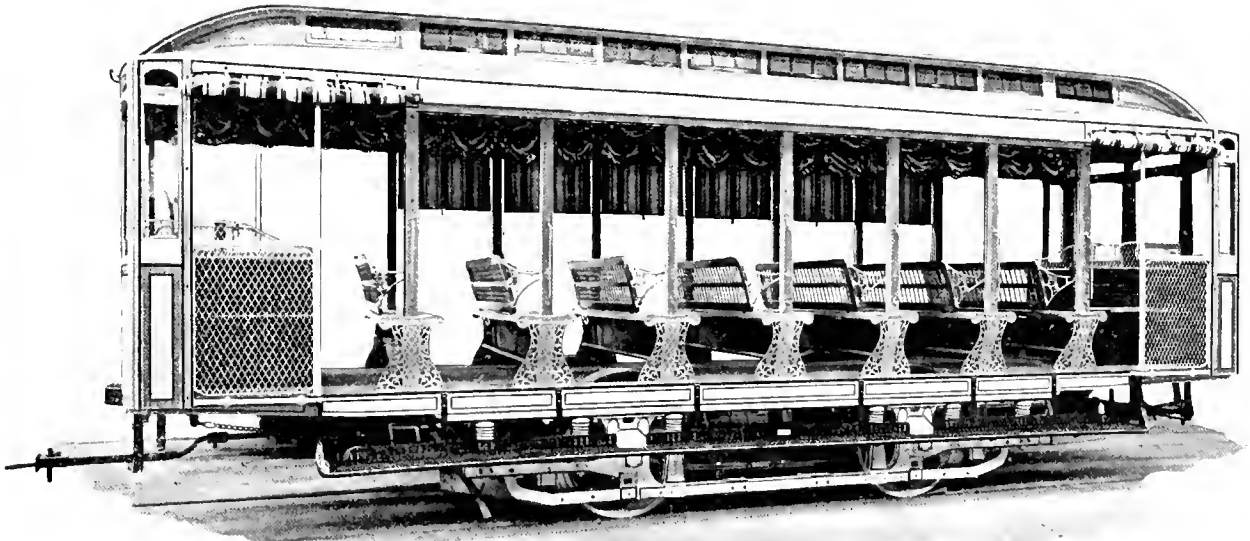

THE LAMOKIN OPEN CAR—EXHIBITED AT WORLD'S FAIR.

dows and drop curtains. The vestibule is rounded and has a box for the motorman at either end. By reference to the accompanying engraving the arrangement of the side seats on either side of the motorman's box may be seen. These seats will hold two passengers each. The other seats, seven in number, are reversible and have, in common with the rest of the construction, bronze fittings.

The ceiling in the main part of the car is of oak in antique finish, handsomely decorated by a new process of silver stamping into the wood. The ceilings of the vestibule ends are done in fancy colors and stripes. The deck sash, by which the car is ventilated, is glazed and ornamented with frosted decorations.

The side spring roller curtains, on either side, are arranged to run in slots which are cut into the posts, by which means the curtains are not allowed to jump out.

end of the car on the roof to the end roof timbers, saving the car roof to a great degree.

The truck upon which the car is mounted is furnished by the Robinson Machine Company, of Altoona, Pa., and is their well known motor truck type. It is a joint exhibition with the Lamokin car.

The car is 28 feet long, over all, painted in ivory and striped with gold, with open work, solid brass side seat panels and a galvanized iron wire screen at the sides of the vestibule, in fact the entire car is such as the Lamokin works would be expected to exhibit, and one in which Sales Agent Pratt can take delight and profit.

STANDING committees named include the one for Electricity, as follows: R. C. Clowry, chairman; C. K. G. Billings, C. H. Wacker, C. L. Hutchinson, Mark L. Crawford.

ELECTROLYSIS OF WATER PIPES.

Abstract from A Paper Read Before the New England Water Works Association, by C. H. Morse,
Inspector of Wires, Cambridge, Mass.

WHEN electric cars were first put in operation in Cambridge they depended upon mother earth, the water pipes, the gas pipes, and anything over which the current could flow, to convey it to the station or act as a sewer. No thought was given to the loss which would result to the company from doing this, to say nothing about the effect upon our pipes. I can, perhaps, illustrate this loss by saying that three months ago, in parts of Cambridge, the loss of pressure due to the power which was required to force this current back over this uncertain path was 20 per cent. Now when I tell you that the central stations of the West End Railroad Company have a maximum capacity of 12,000-horse-power, which would give sufficient current for 24,000 arc lamps the same as are used in our streets, or 120,000 incandescent lamps, such as we have in this building, you get an idea of the power which is being sent out. When you think of that current returning, as it has been obliged to return, you can see that there must be an immense amount transmitted over our pipes.

When the railroad company put in their power plant, they ran large numbers of feeders, as we call them, and one wire between the rails, and attached the two rails to this return wire, so that the current, as I said before, will go to the car through the motor to the wheels, to the rails, and get along as best it can back to the station. This becomes very soon an uncertain path, as it was found that electrolytic action took place upon this wire and it disappeared in places. They thought at first that it was due to something in the soil, but it was very soon traced to the same enemy which you have to contend with, that is, electrolytic action. I remember the practical experience we had with these dead rails, as we call them. When this wire was eaten off and a car came on to that section, if by any chance you placed one foot upon the rail and another upon the ground near it, shocks could be obtained. That happened simply in this way: The current must get back to the station, and it would take to the rail, which was not well grounded, would go up one leg of the man who stood on the rail and down the other to the earth, especially if the earth was a little moist, dividing again inversely according to the resistance.

The effect was so great that the West End Railroad Company made a complete change and reversed the conditions. It would be as if you started with your water works system by pumping the water from the sea into the sewer, forcing it up out of the sewer pipes and back through the faucets and through the mains to the reservoir. That is, they attached the other pole to the earth to remedy this difficulty, and instead of sending the current out over the feeders, they commenced about

a year and a half ago to force it out through the ground, have it go up through the cars and back through the feeders.

Mr. Nevons and I went to the different places where we had traced these difficulties, or where they had been called to our attention rather, and found that lead pipes had disappeared in a short space of time, some even in six or eight weeks. Iron pipes had been tried with the same result, also galvanized iron; brass pipe had been put in and deterioration was noticed at once. Rustless iron was tried, and it did rust decidedly. (Laughter). Well, it was not the work of any mysterious agent, but was the result of what almost all of you have seen in school experiments, that is, the decomposition of water. The current left the West End power house at East Cambridge, it flowed through the ground, and, of course, divided according to the resistance, and took to whatever conductor came in its way. It took to the rails, the water pipes and gas pipes. Now we get no action except at what we call the positive pole. That is where the current is flowing out of the pipes; where it takes to the pipe there is no action. The current flowed along on the pipes, and in this particular case it got down on to Bridge street, which is near Charles river, and flowed along our supply pipes on the wharves and here it had to get across the river to propel the cars in Boston. Where it left those pipes action took place.

Well, the remedy, the quick remedy for that, of course, was very apparent, that is, to reverse the current. So the officials of the West End Railroad Company were invited to a conference with the Water Board and myself, and I am pleased to say the company were willing and anxious to do anything in their power to obviate this difficulty. A certain amount of credit belongs to them for that, although, of course, they had a reason for wanting to do it themselves. They were losing anywhere from 5 to 20 per cent of their power in this return; and when you reckon the loss on 12,000-horse-power it is quite an item; if they could save 5 per cent of that by the investment of a large amount of money it was very desirable for them to do it. They were consequently perfectly willing to take hold of this matter.

Observations were made by several of the water works employes unintentionally. Some of the other gentlemen present could tell you about those, perhaps, better than I. Such an immense amount of current was flowing over the pipes that upon attempting to make a joint by putting oakum around the pipe, it was found that the electric arc was sufficient to set fire to the oakum, frightening the men considerably, I imagine. This, of course, would not necessarily indicate a very high potential, but proved the presence of a large quantity of current in the earth. Tests were made in different parts of the city by means

of instruments adapted for the purpose, and we found between North Cambridge, Harvard Square, Central Square and East Cambridge a fall of potential all the way from 25 to 45 volts. Now, you can reckon the percentage as well as I. There should be no fall of potential, but there was a loss, as I said, of from 25 to 45 volts, from 500 volts, which is the maximum pressure, making more loss than can be allowed with economy. When we attached to the negative pole of the machine and made our tests from Harvard Square, we found a loss of 100 volts, or 20 per cent of the pressure. You can now see, as I said before, why the company was very ready to take hold of this matter.

How are we to remedy the difficulty? I know of no way by which we can use the single trolley wire system and overcome this difficulty without putting up an immense amount of overhead returns, through which the resistance will be reduced to almost nothing. How far the company will be willing to go in this I cannot say. Their spirit has been so admirable in the past I have no right to suppose but what they are willing to carry it to that extent. Certainly, the city will require it carried to such an extent that the pipes will be in perfect safety. The maximum amount of current which can be allowed to go over them I am unable to tell you at present but a series of experiments are being conducted now at my house to determine this. I have some pipes buried in the earth, the current flowing over them, and I am watching carefully the deterioration daily. I am in hopes to make a report soon to the Water Board upon the maximum amount which can be allowed to flow upon iron pipes from which we will have no effect.

By doing what we did do, reversing the current and attaching our water pipes to the negative pole of the dynamo, we hurt one of our old friends seriously, that is, the Gas Company. You see the effect. The current will flow on the water pipes, and it has an easy chance to leave them through their connection with the negative pole of the dynamo. Now it flows along on a gas pipe, and as soon as it can it will leave the gas pipe to take to the water pipe. I felt it my duty to make this clear to the president of the Gas Company, and called his attention to it, saying that something ought to be done to protect him, and a conference was had between the railroad people and the Gas Company, and I was invited to be present. At that time we made an arrangement with the company which will help it somewhat in that direction, and help us as well as them. We propose now to connect the gas pipes and the water pipes together in all parts of the city. It will be done in buildings. A man from the West End Company has been appointed who goes as a gas man to the different stores and factories, and in those places he will solder a wire to the gas pipe and also to the water pipe. This can do no injury to either, but will decidedly help both companies.

You will be a little interested, perhaps, to know of one or two experiments which we have tried in East Cambridge when investigating this subject. Mr. Nevons will be perfectly familiar with the new engine house at East

Cambridge. It is not yet occupied. There is an old supply which comes in from one street that connected with the old house, and a new supply comes in from Otis street, I believe. The mains are connected together at the corner of Third and Otis street, and this engine house is on the corner. Now there is sufficient difference in potential between those two pipes so that if connected together by a medium sized copper wire, about a No. 18, it will heat the wire so hot that you can't bear your hand upon it. There is sufficient power to run a good sized motor, and I suggested to the engineer that he put a motor in there and run a planing mill and a few other little industries to help out that section of the city. It is a matter of fact that if we could save all this energy which is being thrown away, we could run a large factory. In fact, if we run a copper wire from East Cambridge to Harvard Square I think at times there would be no difficulty in running the whole University Press by this wasted power.

It was a little surprise to me the way they attempted at first to return the current. Iron carries a current of electricity not as readily as copper; it has seven times the resistance. Now, there are girder rails, that have, we will say, 10 square inches, some of them have as high as 14 square inches sectional area. That would have a carrying capacity equal to a piece of copper 2 inches square. And yet these rails are bonded by a No. 4 copper wire, a wire smaller than a lead pencil. It seems quite ridiculous that they should ask this little bit of fine copper wire to carry as much current as a big rail, where they could have a piece of copper wire, as I said before, for these big rails, of at least two square inches sectional area.

There is another remedy also which we hope to carry out early in the spring, and that is to abolish completely this return wire between the rails, by cutting it into sections of about 400 feet, and connect each of these sections with the return wires. Most of the current will then return by these copper wires. Of course, some of it, as I said before, will flow over the water pipes; that cannot be helped as long as one side of the machine is connected with the earth.

Another remedy which is to be adopted, is a special line of feeders attached only to the water pipes; that is, a feeder will be run from the central power house to the different parts of the city, which will not be connected with the machines at all, but will be connected with the water pipes at the central power house and with the pipes in all sections of the city. This will also materially reduce the electrolytic action.

THE well known English engineer, W. Wosby Beaumont has designed an electromagnetic clutch for connecting street car motors to the driving shaft. The motor runs at nearly constant speed, whether the car is running or not. The clutch connects the motor through a frictional contact with a slow speed gear, which is changed over to one of higher speed. The regulation is effected entirely by varying the strength of the electromagnet.

CHAPTER ON PAVING.

PART II.

THE following abstracts of specifications for brick paving in several cities have been chosen as good examples of the different kinds of practice.

Detroit has adopted these specifications:—

1. Roadway brought up to grade and rolled.
2. Tile drain two feet below surface on each side of roadway.
3. Six inches of concrete, allowed to set thoroughly.
4. One inch clean sharp sand.
5. Single layer of paving brick set on edge at right angles to direction of street, rolled and tamped.
6. Top dressing and filling of ten per cent Trinidad asphalt mixed with coal tar cement distilled at 600 degrees Fahrenheit, with enough still wax to prevent softening or becoming brittle under heat and cold. This to be applied at 300 degrees.



CROSS SECTION DETROIT SYSTEM.

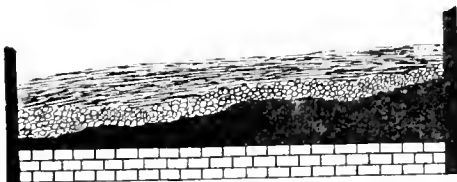

PLAN DETROIT SYSTEM.

Bloomington, Illinois, furnishes an example of another common method.

1. Roadbed brought to proper grade and shape and rolled.
2. Layer of cinders rolled.
3. Layer of sand. (2 inches).
4. A course of brick with their long axes parallel to street. (These, of course, need not be as hard as the surface brick.)
5. An inch of screened sand.
6. Paving brick laid edgewise with long axes at right angles to street.
7. Filling of sand swept in. The whole pavement is then rolled.

Hale's patent system is used considerably in the east, and consists of

1. A layer of sand.
2. Tarred boards laid parallel to the street.
3. A layer of sand.
4. Paving brick, laid in the ordinary way.

Cleveland pavements have recently been laid under specifications requiring the brick to be kept a short distance apart, either by ribs on the brick itself, or by strips of wood put between in laying. The filling used

in this case is bituminous cement. The object of setting the brick a distance apart is to afford a foothold for horses. In regard to this practice, the REVIEW has written to C. P. Chase, city engineer of Clinton, the well-known advocate of brick paving. The following is his reply:

"I have noticed several sets of specifications which call for a quarter of an inch space, more or less, between each line of brick. If there is any advantage in so doing, where is it? When separated it is harder to lay the brick, costs more, is not as healthy and does not give any better foothold.

The prevailing and present custom of placing the brick as close together as they will naturally set is better in many respects. They cannot set so close that there will not be enough room for the ordinary filling of fine sand, tar, or asphalt to enter. If there is a question of health, it is in favor of smaller spaces, especially in sand-filled pavements. It may be claimed that the wide crack gives a better foothold, but it does not, as the sharp corners soon chip off for a quarter of an inch, which leaves too much space when the brick are separated and takes away from its smoothness. The close set brick wear longer."

The Springfield, Mass., street railway has a method whereby the necessity for a girder rail is done away with. This is accomplished by the use of a special form of brick which is laid alongside the rail. The Purington Brick Company, of Galesburg, Illinois, are the makers.

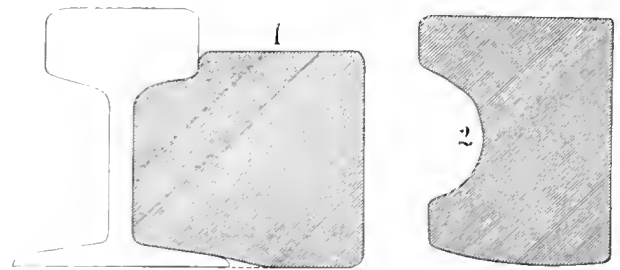

RAIL PAVING, SPRINGFIELD, MASS.

It is made so as to fit snugly against the web of the rail. One form is made to accommodate the fish plates and bonds. Both forms are shown in the illustration.

At Columbus, Ohio, the Hallwood paving block is extensively used. This block is simply a large brick made of specially fine ground and hard compressed clay. The foundation used is eight inches of pounded stone thoroughly rolled. On top of this is put two inches of fine sand, and the blocks are laid directly on this. These blocks are made in two sizes ($2\frac{1}{2} \times 9 \times 4$ and $3 \times 9 \times 4$) and have chamfered corners and two grooves running in a horizontal direction around the brick when it is laid. The object of the groove is to hold the brick firmly in place when a filling of coal tar or bituminous cement is used. Fifteen

miles of street track are paved in this manner, and N. B. Abbott, president of the Ohio Paving Company, says of it:

“The work is from one to six years old and its condition is good. We would like to have any party who is interested in a serviceable street pavement see this work. I have done about all the street railroad track paving here. All kinds of paving have been used in tracks, and I think it is conceded by all here that our block is the most suitable material. We have tried various methods of joining the pavement to rails, and have demonstrated that the

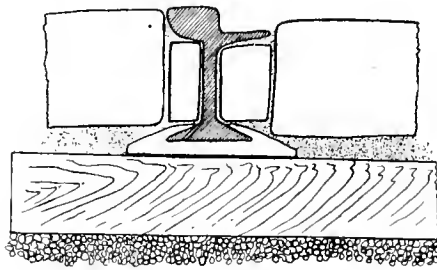

USE OF FILLER, COLUMBUS, O.

best plan is what we now use; namely, a brick “liner” in the groove of the rail as per sketch. The Johnson girder rail is used, and by filling the grooves with this brick liner made to fit the groove and fill it out so as to present a solid bearing for the end of the paving block to butt against, the best results are obtained. The prevailing theory is that tracks are built so solid that they will not move up and down, but the fact is, very few tracks are built so perfectly solid that at some point the rail does not move. This is especially true where electric motor cars are used. There should, therefore, be a joint between the rail and pavement so made that if the rail moves it will not disturb the paving. At the same time it should be the best possible joint if the rail does not move. Such we find this plan to be after trying a good many others.”

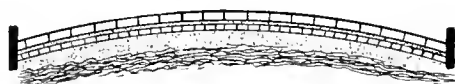

CROSS SECTION, BLOOMINGTON SYSTEM.

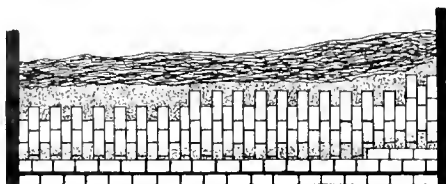

PLAN, BLOOMINGTON SYSTEM.

The question of the kind of brick to be used naturally comes up as an all-important one. The demand for paving brick has led to such search and experiment on the part of brickmakers that there are few parts of the country that cannot now obtain supplies of brick within

reasonable distance. There are many kinds of clay which when burnt hard enough are good for paving. Shale clay makes a smooth, hard brick, but is deceptive in its appearance as to breaking strength, for clays of coarse grain prove to stand as much or more. There is a difference of opinion among brick makers as to whether a brick should be burned to vitrification or to a point just below. A vitrified brick is one that has been heated to a point that melts the iron, magnesia and alkali in its composition, thereby fusing together into a solid mass the alumina of which the clay is largely composed. Vitrification, or a near approach to it, is necessary not only to give strength and toughness, but to prevent the absorption of moisture. The common standard of absorption is that a brick should not absorb more than one-tenth its weight of water after ten days soaking. The necessity of this is seen in a moment when it is considered that it must withstand freezing.

After burning, a brick should be annealed by allowing to cool slowly. If this is not done there is danger that the brick will be brittle like glass. The buyer should be on the lookout in regard to this matter, as there is a temp-



CROSS SECTION, HALE'S SYSTEM.

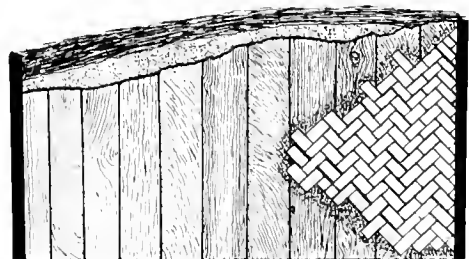

PLAN, HALE'S SYSTEM.

tation on the part of the manufacturer to hasten matters by letting the kiln cool down too quickly. Another matter that needs attention in purchasing is the even quality of the brick. A few soft brick in a pavement will make trouble unless they are removed soon after laying. For this reason it is advisable for the buyer not only to take special precautions to secure an evenly burned lot of brick, but to provide for the watching and repairing of pavement for a month or two after it is laid.

We might append a formidable array of figures on the analysis, breaking strength, abrasion, etc., of the multitude of paving bricks on the market, but our readers will probably be better satisfied if we simply say that an average of 10,000 pounds per square inch is a good showing for crushing strength, although there is a great difference in bricks of the same lot. The increase in quality and uniformity of brick has been almost four-fold in the last ten years, this being brought about by the increased competition and demand. The analyses of clays used are of little interest to purchasers, and, indeed, the best tests are

as more than one brickmaker says, in the results of actual use. There are very few parts of our country that do not now have a paving brick yard within economical shipping distance, and there are fewer locations still that do not have suitable clay near at hand.

FLORIDA'S FIRST ELECTRIC.

THE fountain of eternal youth, once sought by the great Spanish adventurer in the new world, was supposed to be situated in what is now the state of Florida. De Leon died, but the search goes on, and every winter season the frozen Northland is deserted by its opulent residents and sunny Florida gains the difference. Jacksonville, while not distinctly a winter resort, affords, over and above its business enterprise the same advantages of climate as St. Augustine and other towns of like fame. It is conveniently situated on the St. John's river, 250 miles east of Tallahassee, and of course, was named for the stalwart statesman, Andrew Jackson.



S. B. HUBBARD.

As the capital of the state the city enjoys political distinction, and its population of 17,000 entitles it to the name of the metropolis of the state. The steam railway facilities are ample for all

ized in 1883. Horses were then, of course, the moving element, and for a town of 8,000 even this showed the enterprising spirit of Jacksonville's citizenship. Progress did not stop here, however, and as the city grew the demand became more and more urgent for better and more rapid transit, for a road in fact that would afford a luxurious as well as a modern system, one in keeping with the dignity of Jacksonville.

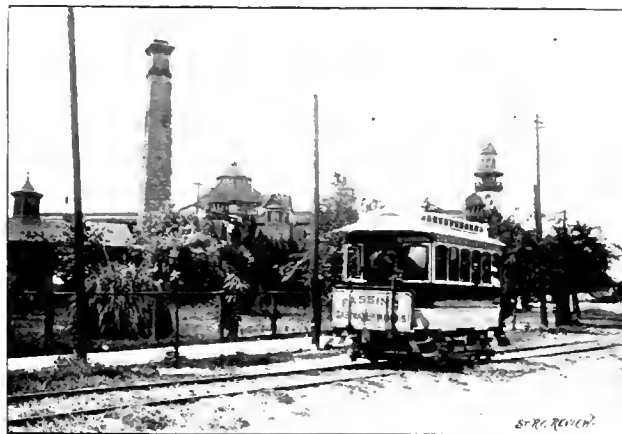

JACKSONVILLE WATER WORKS.

So, in 1892, President Samuel B. Hubbard, treasurer, Arthur F. Perry, and secretary and general manager, Henry S. Ely, of the Springfield company, decided that electricity should carry, as well as light, the inhabitants and the strangers within the gates of Jacksonville. No other road in Florida had yet attempted the new system and the question of "how it would take" was a graver one than usual. But, suffice it to say, a franchise was acquired for the new traction, and contracts let for the remodeling of the road. On February 23, 1893, Florida's first electric was opened, to the joy of the citizens and the triumph of the company.

The road is not a large one, but from the fact of firstness should command wide attention in the north as well as the south.

The length of the line is 2.52 miles of 4 foot 8½ inch gauge, laid with 40-pound T rail, made by the Cambria Iron Company and the Johnson Company, of Johnstown, Pa. The gradients are hardly worth mention, as the streets are universally well graded and level.

John Stephenson made the five cars which are 12 feet long and carry one 15-horse-power Thomson-Houston motor each. The cars are set on Bemis trucks and run on Bemis wheels, which, of course, contribute to the



HENRY S. ELY.

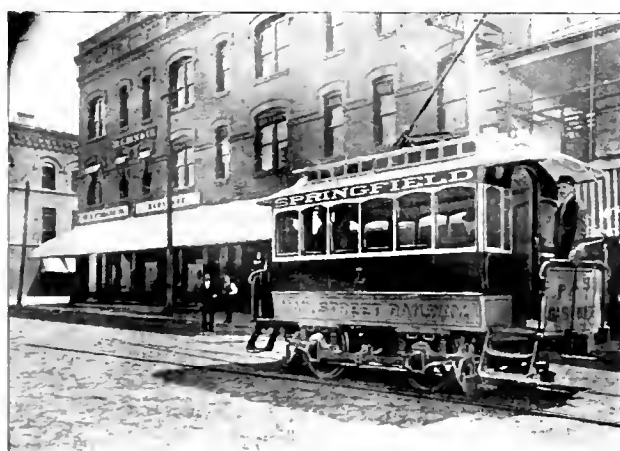

MAIN STREET, JACKSONVILLE.

purposes, and the St. John's river give it communication to the sea.

Considerable capital is employed here in various industries, both agricultural and manufacturing enterprises, but to its latest acquisition we must address our attention.

The Main Street Railroad Company is an old institution, as southern street railroads go, having been organ-

easy riding of the cars. The accompanying engravings bespeak the handsome appearance of the cars and road-bed.

Power is as yet rented from the Jacksonville Electric Light Company, as the traffic does not warrant a separate plant.

Our engravings show a portion of the business section of the city with car No. 1 in the foreground, while the other gives a view on the line, taking in a portion of the city water works on the left hand and the sub-tropical exposition building on the right. We are also pleased to introduce the moving spirits of the Springfield Company, which operates the line, S. B. Hubbard, president, and Henry S. Ely, secretary. The event of the road is more important in the promise of longer and larger interests of a like kind than in immediate returns from this line, which will undoubtedly be the precursor of other electric railways under the brilliant sun of our tropics.

ON THE GRIP.

CHAPTER II.

WHAT one woman sees," gripman Perry continued. "is the result of long practice and natural inclination. In this line she can give a man all the odds and beat him. No speed of rapid transit can keep one woman from minutely observing the style, color, texture and detail of another woman's clothes, even if the other woman is seated on a car going in the opposite direction and both at full speed. A man, on the other hand, can't tell whether his acquaintance's clothes are light or dark; here all men must bow to the superior observation of the gentler sex.

If there is one thing above another that puzzles the conductor, however, it is the source of the pennies handed him by lady passengers. Constant experience with the penny habit makes it less annoying, but the new conductor suffers untold agonies from it.

Where do women get so many pennies?

Fully one quarter of the ladies pay their fare in pennies, and consequently very few ladies wish pennies in change. In fact, very few men like pennies, and the company does not like them either. This makes a very bad state of the change market, and the only escape is to "work them off" on the ladies, from whom the most of them come. Hence, another thing that goes to make a conductor's life miserable. It causes more wars of words than theology, and the smoothest conductor is not exempt from the disdain heaped upon the purveyor of small change.

I remember once a lady who sat on one of the single seats of the grip who asked the conductor in a very sarcastic tone of voice, "What shall I do with these pennies?" An unlucky spirit moved me then and I said, "The butcher or groceryman will be only too glad to have them ma'am." She turned on me spitefully and said, "Just 'tend to your own business, the conductor and I will finish

this question." That conductor in the meantime took occasion to occupy the rear platform and I had to bear the tongue scorching all alone. Since then I don't help out in such cases.

My advice is, boys, don't get into a dispute with a woman who is angry. Any word you can get in edgewise only gives her a chance to get her breath and go at it again with renewed vigor. Never argue with a woman is the best policy. "The-sturdy-oak,-and-clinging-vine" theory may be well enough for women in some countries, but Chicago women are best represented by the arms-akimbo "I Will" statue of Mr. Holloway.

Women have another distinguishing trait—they can't be hurried. For instance a woman spies a car at the corner. She may be a half block or two blocks away from the car but that's the car she wants. She signals the driver who stops for her. As soon as he stops she loses all hurry and takes her own time in coming after the ride. Oh how mad she is if a car goes past her.

This same trait is observed in their exit from the car. I suggest that the company supply every car with a mouse, boxed up and ready to jump. This box can be easily carried and when the mouse is liberated the car will be cleared in no time. The saving of time on each trip will doubly repay the outlay.

When a woman gets an eccentric idea she is fonder of it than the worst cranks of the other sex are of their fads. In the coldest days last winter I observed a woman that invariably took a seat on the grip car. Wind and snow did not affect her. I thought at one time that she perhaps was practicing for a polar expedition or a game of freeze out. However, this thing continued for a long time and to all questions she replied, "Oh no! It is perfectly lovely and I'm quite warm. I am not so liable to take cold here as in the car, the air is so close there." One day as our train halted near the starter's stand at Hyde Park I was sitting in the car reading a paper. Our grip woman was also in the car, not the grip this time. Finally she gave a shudder, went up and felt of the stove-pipe and then gave me a business-like glance. That day we had a poor fire and the conductor had spent his laying over time for two trips in remedying matters, but as yet with little success. Consequently 'fire' was a dangerous subject of conversation with the aforesaid conductor. The conductor was not in the car, so madam made me her target, and remarked several things not flattering to my personal character, and wound up by saying that she had been the means of having four men discharged during the past month. She then took my badge number, the number of the car and the time of the trip, quite like a lawyer, but just then—but it's getting late and I'll have to stop until next trip.

H. D. HYDE, counsel of the West End, of Boston, has a proposition for an elevated railway for Boston and its suburbs. The West End directors formulated the idea. The capital is fixed at \$25,000,000, and land is to be taken by right of eminent domain.

RAIL BONDING.

A Paper Read by C. W. Wason, before the Electric Club of Cleveland.

MR. CHAIRMAN AND GENTLEMEN:

I do not know but what the gentlemen will think I am appearing before them too often, but this is a subject I am very much interested in, and consequently have written this paper to start you to thinking and perhaps to get some suggestions from you. This matter of rail bonding is very vital to the interests of street railroads. I am confident that this important branch of the electrical equipment has not been given sufficient attention. I am convinced that a metallic return circuit of equal capacity to overhead feeders must be provided, and that care and attention must be given to the joints in order to reduce resistance and make the metallic circuit perfect in itself. One of the most serious difficulties to be overcome is the electrolytic action which takes place when two metals of dissimilar character are brought into contact, provided moisture is also present; the latter, as I understand, being absolutely necessary to produce the disintegration of the metals.



C. W. WASON,

is the Vice-President and Electrical Engineer of the Cleveland Electric Railway Co. and Vice-President of the Cleveland Electrical Club, and one of the recognized authorities on practical Electric Street Railway work. Although a young man, his electrical experience has been long and varied.

will speak up. This sample (No 8) is a section of a Johnson 93 pound rail, such as the Cleveland Electric Railway has adopted as its standard in the city. It is a 9-inch girder, and of course resting on the ties. In the center of the rail, that is, longitudinally, I have drilled a

In order to present to the Club ideas other than your own, I have written to electric engineers of several other principal electric roads in the country, and have here before you the rail bonds which they advocate and use, together with a few words explaining the use of the same. For convenience I have numbered each sample and will when speaking of them use the numbers as here indicated.

I will first explain and illustrate to you what I consider the best railbond. If any of you think otherwise, or have any suggestions to make, I hope you

about as tight as you can turn it with this. Now, we set that torch going on that until it melts the solder, using rosin as a flux. When that has cooled the bolt and the washer will be soldered together, being tinned on the inner side. Then the bolt you see comes through about $\frac{1}{4}$ of an inch, and that will be upset to further insure against the probability of its working loose. Now, one reason for not putting the rail bond at either end of the rail as has commonly been done; the rail, no matter how stiff as this section would appear, will give or spring at the end. That will in a measure work the wire and possibly get it loose. That is one reason for putting this in the center of the rail; then one rail bond is all sufficient to each rail, and only one hole is necessary in each rail. After the nut is set up tight the joint is painted with shellac, covering the bolt and terminal and the wire for a short distance out, say three or four inches, and after that has dried two coats of asphalt varnish is applied. The reason for putting the shellac on is that the asphalt varnish does not seem to cling to the iron as the shellac, and after coating it with shellac the asphalt varnish will adhere to that better than it will on the bare iron. I think a joint of very little resistance is secure. Thus, of course, the bolt is practically a steam-tight joint, and I do not see how it can corrode if it is put together as it is designed to be. Of course it is necessary to have some one on the ground to superintend this, as it should not be left to the ordinary track man to attend to.

On the 16th of March, in order in a measure to test these joints I had two pair made in this way. (Indicating.) This one is a common boiler rivet that was soldered to the wire, and one of these joints painted with asphalt and the other laid bare. This joint was put in a saturated solution of salt water and remained there about twenty days, with a constant current of ten amperes passing through it. I did that to see whether there was any perceptible difference in the two joints or the two connections, one painted with asphalt and the other not. In the first place the time was not long enough to show any perceptible result, but I think that the asphalt has in this case (indicating) proven of benefit. In the case of this one (indicating) which was buried in the ground at our power house, through which was a constant current averaging 30 amperes passed, made up in the manner I spoke of, one of these that was covered with asphalt shows signs of the asphalt having chipped off. In this case the joint was not painted with shellac. The other end of this section does not seem to have changed at all. I hardly expected to

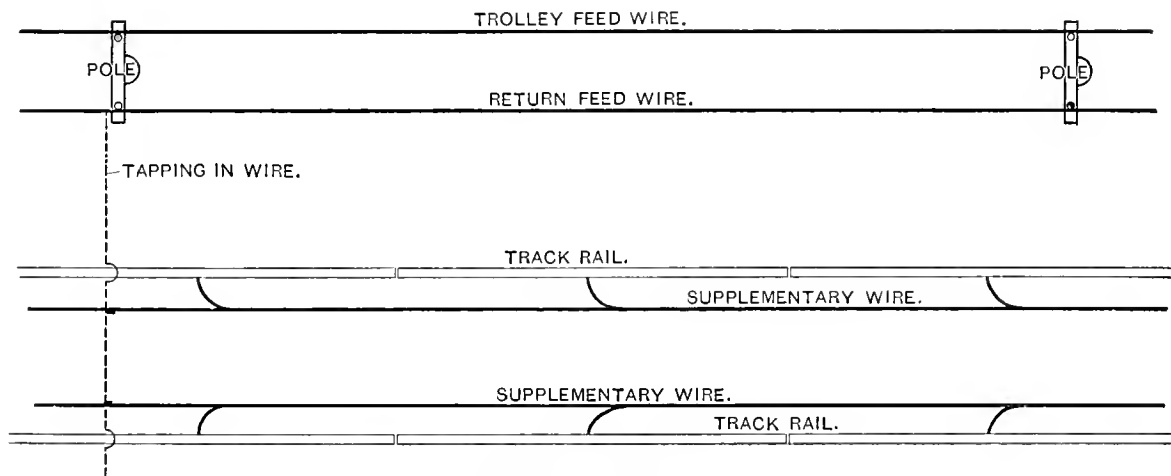

DIAGRAM OF WASON'S METHOD.

$\frac{3}{8}$ inch hole, about two or three inches from the bottom of the rail. When placed in position on the track on the ties, this hole is then tapped out with a $\frac{5}{16}$ inch taper tap. At the shop we prepare a rail bond, one end of which is soldered into this terminal of brass about $\frac{3}{8}$ inch thick and $1\frac{1}{4}$ inch diameter with a $\frac{5}{8}$ inch hole through. This is tinned carefully all over, and then this bolt (indicating), which is galvanized and $\frac{3}{8}$ inch by $\frac{3}{8}$ inch—the reason we have this galvanized is to prevent it rusting—and then screwing this into the newly tapped hole, the threads of course will fit it, and being tapered this will be screwed home and make a fairly tight joint, even without any solder. Now this we screw tight with a 14 inch or 16 inch wrench; (illustrating) this is just

see any change in so short a time. (Indicating.) This section was put in a pail of fresh water for the same length of time, twenty days, with ten amperes passing through it. In this case the asphalt seems to have protected it. There is a little bit of action on the copper of the other where it left the iron, or in the immediate vicinity of it and not the bolt head. Of course how long that would last is a problem.

Here is a sample of wire that I took out of a curve in the public square that had been down almost three years. It was a tinned wire, and the tin has not entirely disappeared; so that there has been very little electrolytic action there.

Here is a sample of wire that was taken from underneath an old strap rail which is very badly used up.

Here is another piece that was outside of the track some three miles from the power house, and had been down possibly two years; it shows some electrolytic action, which, of course, depends upon the nature of the soil and whether there is moisture present, as to the length of time that it will last.

Now, assuming that we have a durable connection with the rail, we must now provide copper of sufficient capacity to carry the return current back to the power house or nearly so. The rail can be figured to take a portion, but each year it will conduct less and less owing to the corrosion at the joints. Where expensive pavement is laid, means must be provided to take care of the current, which is bound to increase in any growing city as more cars are added on the line.

I have drawn a little diagram here which will possibly illustrate my idea of track wiring. (Referring to diagram on blackboard.) We will call from the left to the right of this sketch 500 feet. The rails you see are attached to the ground wire in the center of each, in the manner I have shown, and each 500 feet a No. 0 copper wire is connected to each of the four ground wires, or supplementary wires, and run to the pole on the side of the street. Better if this wire is laid in a box filled with asphalt and run through a pipe which is also filled with asphalt up to the pole. These connections run up at about every 500 feet; they may end there for the present. Heretofore, as the traffic increases on the electric road, an additional feed wire is run out, and in six months or a year another one is run out. Nothing is done with the underground wiring; that remains the same as it was when started. As a matter of fact, it is getting worse and worse each year, and still nothing has been done to re-enforce it. My idea is, as you add feeders, to add return wires and connect these number 0 wires which have been run up the pole when the track was laid. In that way you have got enough copper and metal in the ground to take care of any possible amount of current that

poor there would be trouble from water pipes. Personally Mr. Smith says that he has installed some four or five electric roads, and has found that good track bonding is necessary, and that the return cannot be too good. He has tried the feeder system and also tapping onto water pipes, but does not consider the latter good, as it injures the pipes.

The following is from "J. F. E."

(For this article see pages 117 and 118 of our February issue. The last paragraphs quoted by Mr. Wason are as follows:)

"This melting of the connections would only have occurred by reason of excessive current passing through them, which being the fact, occurred because the rails alone were conducting approximately the entire amount of current necessary to operate the system back to the station. This could only occur when the earth was in a condition offering great resistance, as compared with the rails, or when the rails were insulated from the earth, for usually under normal conditions the "return circuit" offered by the rails is greatly supplemented by the earth itself.

"On account of the exceedingly low resistance of damp earth as an electric conductor, it being in fact infinitesimal, and as electricity in flowing back to the dynamos chooses the path of least resistance, and as the return circuit presented by the rails is of enormous resistance as compared with the earth, the greater part of the current chooses the earth as a means of returning to the station in preference to the rails, as offering it finitely less resistance."

Now, right here I think the above is sufficient argument to put in copper enough to guard against the road being stopped in this manner. Where you depend upon the earth for a return circuit, and have the conditions such as they were in this instance, you are liable to paralyze your entire road. Consequently I do not think it safe to depend on the earth for a return. Possibly the initial expense is greater in installing the road. Local conditions of the earth should also be taken into consideration. This man evidently believes in making the current of the earth carry a portion of the return. "Thus," he continues, "with most of

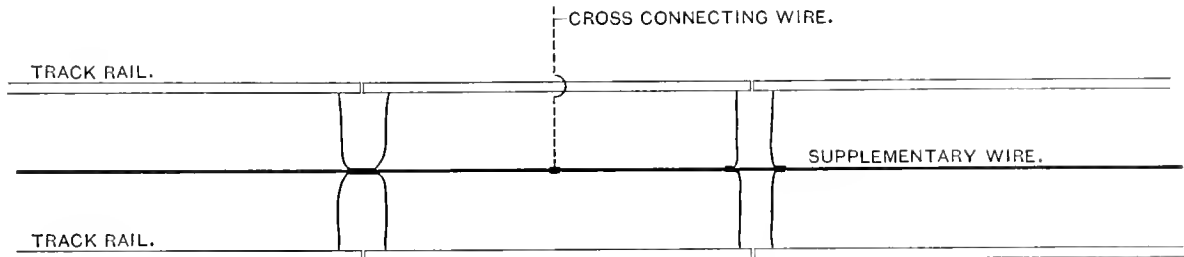

DIAGRAM OF LINDELL RAILWAY METHOD.

you will need to take care of between these 500 foot points. If you filled that track full of cars and started them all at once, which is, of course, a very improbable and almost an impossible condition, you would still have enough metal to carry the current required. Then by having your feeders proportionately large you will relieve the heating and burning out of joints that might be otherwise overloaded.

I think the entire system should be entirely independent of the earth for its return circuit; that a return circuit should be provided with copper equal to that which distributes, if you can use these terms. I will read an article in the STREET RAILWAY REVIEW, of February, by "J. F. E."; also portions of a letter in the March number, together with letters I have received from some of the most prominent companies in this line of work. There are a great many who differ with me on this point, and I discovered after I announced that this paper would be read that the STREET RAILWAY REVIEW had started this ball rolling in February. I find that I, myself, answered some questions that I had forgotten. However, I do not think that I have to take anything back from what I said there. I gave our experience, and as far as it went it was all right. I think that the views here given are an improvement on our present mode of track wiring. Among questions asked by the STREET RAILWAY REVIEW are these: (For these questions see page 97 of our February issue.—EDITOR.)

Answers to these questions were received from quite a number of persons. Here are several of them from Salt Lake City. Salt Lake City, as you would well imagine, and that vicinity, is pretty hard on copper and iron in the ground; it all disappears very shortly. Jas. N. Smith, electrician of the Salt Lake City Railway Company, says that they use a No. 4 copper wire bond, with cross bonds at every joint. They had tried dispensing with ground plates and using track feeders alone, but it was not satisfactory, and they had found that if the track bonding was

the current returning through the earth and very little through the rails, and as the only current that concerns the track feeder is that returning through rails alone, if this wire is of moderate size, under ordinary conditions the current returning through it is not sufficient to heat it, much less to melt its connections."

Then in the March number of the STREET RAILWAY REVIEW there are more letters in answer to the queries that the editor sent out.

Manager E. P. Clark, of the Los Angeles Consolidated, says: (See page 151 of the March REVIEW.)

J. W. McNamara, of the Albany railway, uses Mr. Sabold's scheme of driving pipe down into the ground every so often without any continuous wire. That might do in a marshy country, but I don't believe it would work where there are sewers.

The letters that I would like to read are first, one from A. W. Morrell electrical engineer of the Lindell Road, in St. Louis; he was formerly connected with the Minneapolis and St. Paul railroad. He says:

"I do not think there has been enough attention paid to the important question of rail bonds and track feeders by the street railway companies generally. I think a good return is very important. The rails are oftentimes of ample capacity to return the current back if they were properly bonded. I have never thought very favorably of the plan of riveting in bond wires, neither the use of channel pins, as there is too much chance for corrosion." The channel pin is that sample (indicating) which is used by a great many roads, and this sample was sent me by the manager of the Buffalo Street Railroad. "My plan would be to use a number 00 bare wire," as represented in this yellow line through the center of the blackboard sketch, "as a supplementary wire. This for a double track road would make two 00 wires extending to and connecting direct to the ground plate at the station." My reason for using two wires instead of one in the track is to double the chance, or to lessen the

chance by one-half of the continuous metallic circuit being broken. There is more sectional area of the copper in these two than in this one, but if this section is broken you are dependent upon the rail to carry you by that break. Here one-half would be carried. The difference in the labor is possibly all the additional cost. "In addition, I would use a No. 0000 wire connecting each of the four rails direct with the ground plate; for bond wires I would use a No. 1 copper wire of sufficient length to connect rail to supplementary wire. I would use a bond of this kind at or near each end of the rail, making two bonds to each rail. I would electrically weld the ends of these bonds to the rail and make a half connection with the other end to the 00 supplementary wire between the rails; securing the bond wire to the rail in this way would be cheaper than riveting, besides having the advantage of making perfect contact without liability to corrosion. All you would need would be a rheostat of sufficient carrying capacity to handle the current necessary to make the weld. Where the bond wire is connected to the supplementary the joint should be thoroughly soldered. I think number 1 wire is as small as should be used, and should be soft drawn copper, at intervals of 200 feet. The supplementary wires should be connected together by a number to cross wire. In this arrangement you would get full benefit of all rails. Enclosed please find sketch showing arrangement." That is the sketch I have drawn on the blackboard.

Here is another letter from George W. Baumhoff, the general superintendent of the Lindell Railway Company, the same road:

"I send you by express one of our sample rail bonds, which will require no further explanation as to the manner of fastening. In addition to this we run a continuous size 0 copper wire the entire length of the track and connect the same with the rail about every 500 feet."

The following is from H. H. Littell, vice-president and general manager of the Buffalo Railway Company:

"I have this day sent you by mail sample of rail bond. We use No. 0 copper wire with channel pin, and make the bond as short as possible. Where we are putting down the deep rail, $8\frac{7}{8}$ inches with 6 inch bottom flange, the holes are drilled three inches from the end of each rail in the bottom flange."

In my opinion they are making a mistake, in making that so close. If there is any spring to the rail that surely will break that bond in a short time.

The following letter is from the superintendent of Line Construction of the West End Street Railway, Boston. This, as you all know, is the largest electric system in the world, where they have a good deal of experience:

"I send you by express a sample of each kind of our bond wires. The large ones we use for girder rails, and the small ones for old tram rail. We do not rivet the large ones as you see they taper, and I find better results by not riveting them in the rail. We rivet the small ones in all tram rails coming up through the rail from the under side about two feet from the end. We use supplementary No. 0 wire between rails and connect to it with our bonds. We use overhead returns connected from the supplementary about every 600 feet. We get better results from this than by depending upon the supplementary wire alone."

That is practically the same as shown on the blackboard. They have absolutely found it necessary there to run these overhead wires, owing to the manner in which the water pipes have been attacked.

Here is quite a long letter from Charles A. Leib. He is connected with the General Electric company, and has been given charge of the line work in general. The sample sent by Mr. Leib as stated in the letter is made entirely of one piece either of iron or copper, as the customer desires; it is all formed from one piece in the machine.

"I am sorry to say that I cannot send you the kind of samples I would like to. I have one sample which I send you herewith made in dies that have not been hardened, and perhaps the same look rather crude, but will show you exactly what we are driving at. We intend to make our standard rail bond of $\frac{3}{8}$ inch iron or copper wire, with a $\frac{3}{8}$ inch rivet, that is, the rivet will be about $\frac{3}{8}$ inch on the smallest end and $\frac{1}{2}$ inch larger under the head, so that it will drive very tight in a $\frac{3}{8}$ inch hole. In my mind, this will make the most satisfactory rail bond that has ever been made. As to how the bond should be applied, this has been a matter of considerable study and discussion. On a girder rail, the latest "fad" is to make the rail bonds about 8 inches long, one on each side of the joint into the base of the rail. At Buffalo, Mr. Littell will drive the rail bonds from the bottom of the base and rivet them, of course, on the top. This would necessitate cutting out the tie where these rail bonds are if the tie is to come directly under the joint. They can, of course, be driven from the top of the rail base and riveted on the bottom. This would avoid cutting out the ties, but makes it rather inconvenient to apply the rail bonds. By making these rail bonds 21 to 30 inches long

(30 inches will be our standard) the rail bonds can be applied in the usual way, and we recommend that two of these rail bonds be put in at each joint, regardless of the point of application. Personally, I would recommend in every case, whether iron or copper be used, and especially copper, that the point where the rail bond is riveted to the rail be well painted with asphalt after the bond is applied. This will keep the moisture away and prevent deterioration at this point; in fact, if the whole bond is well painted with asphalt, it will help to preserve it for a considerable length of time. I think that you will agree with me that the shorter the rail bond is the better, on account of the resistance, etc. For that reason where the short bond can be used I would favor it, although we run some chances of this bond breaking on account of its shortness where the joints are not well held up. There is another bond that we are experimenting with, and that is on the principle of the flexible connection used on the Edison three-wire underground system. It is composed of a large copper cable made of fine copper wire secured in large copper rivets. In this case it will be necessary to make a special fish-plate, which will be hollowed out, as it were, or have a hollow box forged into it, so that after the rail bond, made of flexible cable, is riveted to the rail, the fish-plate will cover the same. It was my idea then to fill up this box, after, of course, the fish-plate and rail bond have been secured with asphalt, thus protecting the whole thing. This will, however, be rather an expensive appliance, and, on the whole, I think that the new rail bond that I am sending you will be the most satisfactory.

There is still another way and that is to run a supplementary wire the whole length of the track, and connect with the rail somewhere near the middle of each length of the track. (I suppose he means length of rail.) This would absolutely do away with the rail bonds, making really an independent return. This wire can be secured to the track in various ways, of course, by making a special brass casting to be riveted to the rail, and the wire secured to it, and if well protected with asphalt I should think would last for a long time. This really is a compromise between using the ground on one side and returning with an overhead wire. The latter, in most cases, I am in favor of, as the ground wires invariably are eaten off. In my own mind, I believe that a complete metallic circuit, in most cases, the most satisfactory and economical. As you are fully aware, a number of roads have an excessive amount of feed wire in the air and are choked off on the return, whereas if they divided that and used one-half of their feed wire for a return circuit, they would get much more satisfaction without any additional expense. In making ground connections, as well as in rail bonding, I feel confident that the simple method of applying asphalt at all the joints and connections will tend to prolong the life of all these connections, and much longer than would at first be assumed.

There is another rail bond that the Minneapolis Street Railway Company are going to apply this season, which consists of copper casting, which is a plate about two inches wide, five inches long and one-eighth inch thick, and has cast on to it, and integral with it, two copper pins five-eighths inch in diameter and about three-quarters of an inch long, and between these pins the copper plate is corrugated. The intention of this corrugation is to allow for expansion and contraction. They intend to rivet this rail bond which is a rail bond all in one piece, directly to the rail, and then screw the fish-plate on the outside. I have my doubts about this rail bond being satisfactory, because of the movement of the rails at the joints. If there should be any perceptible movement, it seems to me that these pins or rivets will be sheared off, because when the fish-plates are screwed down on this bond there can hardly be any elasticity."

ABSTRACTS FROM THE DISCUSSION.

Mr. Roberts.—I would like to ask Mr. Wason if he used rosin entirely for his solder, or solder salts in any case.

Mr. Wason.—We have used, heretofore, soldering salts, but I am going, this summer, to use rosin entirely for underground work.

Mr. Foote.—I would like to inquire what results have been reached with the iron ground wire. I understand that during the last year and a half, perhaps, iron wire has been used considerably for ground work.

Mr. Wason.—I think that if you read through the letters that have been returned in answer to the queries sent out by this periodical, the STREET RAILWAY REVIEW, you will find that in many cases the iron wires have disappeared and been renewed with copper. This I claim to be due not to electrolytic action, but to corrosion. I am adverse to the use of iron, owing to the difference in conductivity, which is six to one, or about that. And surely the iron wire will last not much longer, if as small, and you have only one-sixth of the amount of conductivity. I think that one reason it is used is to do away with that electrolytic action that is supposed to take place and does take place. But if you can protect it from moisture—I had the idea in this case of having a

little form made to fit here (indicating) and filled this full of asphalt. We took up the pavement to make a sewer connection at our power house last week and this section of the rail, this part right in that hollow (indicating) was filled full of tar, such as is poured in with block pavement, so that the connection there would be absolutely water-proof where that kind of paving was used, and they took pains to pour tar next the rail. I think that would secure the desired result if it was painted with asphalt first, or even if the asphalt was not used and the tar filled in there it would surely keep the water from that joint.

Mr. Roberts.—In reference to that matter of rosin and soldering my belief is that a rosin joint is very much better than a solder-salt joint, if properly done. In order to make a rosin joint you have to heat it to a higher temperature and much more carefully, and if you use rosin and get a good joint you will get a much better one. The solder-salt creeps terribly.

ELECTRIC HAULAGE IN COAL MINES.

ELECTRIC haulage has but recently received the attention it deserves from mine owners, but it is now coming into prominence and bids fair to become as popular as it has on street railways. In fact

way one can get shocked is to stand on a rail and touch the wire. I have been shocked several times myself while handling the locomotive, through thoughtlessness. The other day a balky mule ran into the wire with his head. He was knocked down. He got up and ran into it again three times and was dropped in every instance. After that he simply turned around and went off to his work. I ought to remark that the shock does not knock a man down or burn him. The only description I can give of its effect from personal experience is a tingling sensation lasting, in the heaviest shock I received, not more than one or two minutes afterward in the hand that made the contact."

THE Street Railway Company at Montreal has moved into new quarters at 20 James street, until the erection of the new building.

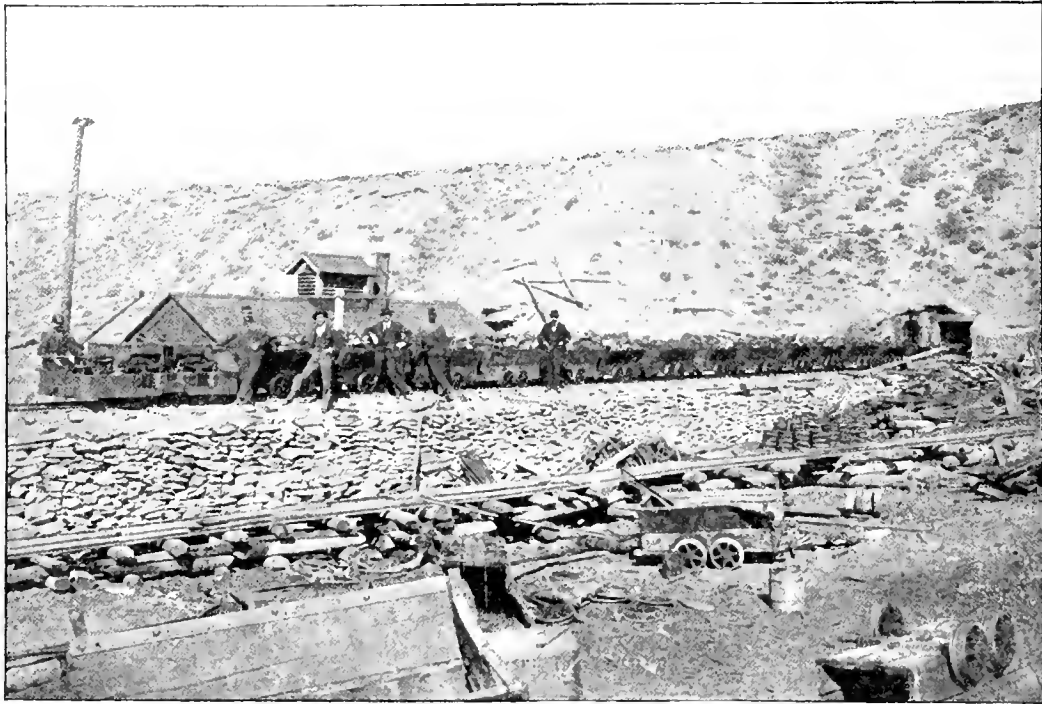

HAULING COAL CARS BY ELECTRICITY.

mine haulage has a history strikingly similar to that of street railway traction. First the mule, then the cable, then electricity. A plant installed at the Rock Springs (Wyoming) Coal Mine has the station one mile from the shaft. The voltage used is 550 and the current is carried to the shaft with 10 per cent loss. The motor used is 60-horse-power and it hauls ordinarily about thirty cars weighing 3,000 pounds apiece. The saving in time over the old method is no small factor in the economy of the new. The expert gives some particulars in regard to shocks received from the trolley wire, which will be of interest, because the potential is the same as that used on outdoor railway lines. He says: "Several men have been shocked since our plant has begun operating, but the effect is only momentary and the men laugh at it. The result has simply been to remove all fear they had of it. * * * This is a very dry mine and so the only

NEW WHEELS ON CURVES.

IN speaking of the difficulties incident to the opening up of a new line and getting the new machinery "limbered up," an engineer with whom a REVIEW representative was talking recently remarked that the condition car wheels are in when they leave the factory is not conducive to easy running on curves, and this consequently adds to the numerous trials that accompany the starting of a system. "The trouble is," he said, "that the very part that bears hardest on curves is left rough by the builders. I refer to the inside of the flange. It is left rough and has to wear off as best it can. Meanwhile the amount of power used on curves is something enormous, and on a new road this is quite an item, and greatly increases the maximum load on the station. It's a rather expensive method of smoothing flanges."

PUT-IN-BAY & SOUTHWESTERN INTER-URBAN.

OHIO is a great state. It is over-brimming with presidential possibilities, enterprise and electric railways. Two or three long interurban lines have already begun to spread their webs of tracks, and other and longer lines are contemplated.

At least one of these latter is well planned, and well backed financially and intellectually, so that there seems little doubt but that it will become a factor in the commerce of Ohio. This road is the Put-in-Bay & Southwestern, contemplated by J. K. Tillotson, of Toledo.

This road, when finished, will comprehend 106 miles of track, some already built and the rest to connect the urban lines now in existence.

Put-in-Bay, whence the road starts, is a summer resort

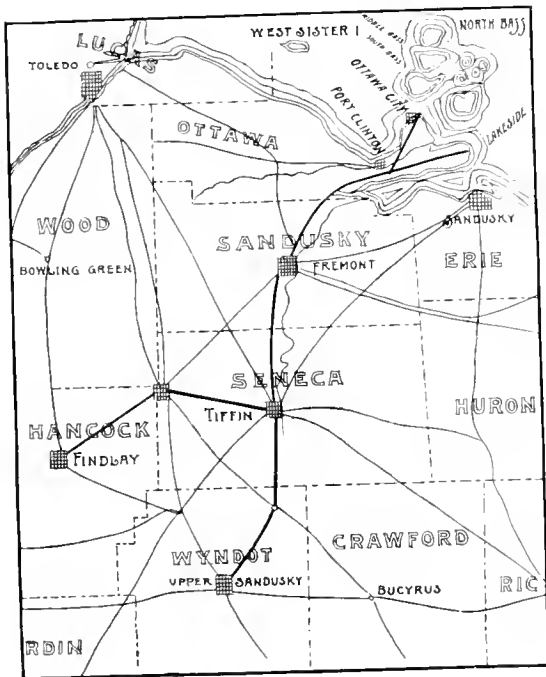

MAP OF PUT IN BAY LINES.

of some note, and has already an electric railway. The islands in Lake Erie near this point only lack transportation facilities to make them the general meeting place of all the pleasure seekers in this populous section.

The system will include the towns of Fremont, Fostoria, Findlay, Tiffin, and Upper Sandusky, having roads already in operation, and a total population, together with intermediate villages, of nearly 90,000. The total population of the counties represented is about 175,000. Steam road connections number fourteen, and for five months in the year the excursion business will be a large item in the receipts. The total interurban income is estimated at \$230,000 per annum, which, with the total local, freight, express and mail business, will make the year's business equal \$250,000.

The map of the situation above given shows the territory touched and the arrangement of trunk and branch lines.

The winter traffic will be large and paying, and the road is intended to be in no respect a summer affair.

Geo. B. Kerper, of Cincinnati, is president; H. S. Sneath, Tiffin, is treasurer; J. K. Tillotson, Put-in-Bay, vice-president; R. W. Brown, Tiffin, secretary.

The right of way is now being secured, and the intention is to push the system to completion.

A CAR BELLE.

A CERTAIN metropolitan young lady on a recent rainy day essayed the vulgar surface car as a method of locomotion. It was towards evening and a number of working people were on board already so the young lady stood on the platform. It was Lent and Miss Manhattan saw an opportunity to mortify the flesh as an old Irishwoman came aboard with a large, corpulent basket in her cold, red hands. Loudly lamenting the weather the old lady finally said, "Me hands'll be froze aff, bejabbers." Here was the lenten opportunity, so Miss Manhattan said sweetly, "You can keep your hands warm if you will let me hold your basket."

The old woman struck a meditative attitude and gazing over this tailor-made assistant shook her head decidedly. "Oi guess not. Me pocket book's in thot basket."

The blushing penitent thought this too mortifying even for Lent, especially when a rough fellow opposite followed with "Ah, she's all right."

PEORIA POWER PLANT.

THE Central City Railway Company, of Peoria, Ill., as will be remembered, lost its entire equipment by fire January 16, 1893. At 7 a. m. the power house was in ruins and the directors in executive session.

By 9 o'clock horse cars were in motion on all the principal lines giving the best service possible under the circumstances. Immediate preparations were made for rebuilding and since then Manager John Finlay has been the hardest worked man in Peoria. A temporary current was obtained January 17 and the new power house started abuilding. April saw the completion of the plant in better quarters than before.

The new plant has an engine and generator room 80 by 95 feet; a repair shop 95 by 40 feet, separated by a closed fire wall from the power room and a car barn 136 by 60 feet, also separated by a fire wall into two equal parts. Each part contains three tracks with a total capacity of 15 cars, making a barn capacity of 30 cars.

EASILY MOVED.

A WOMAN in a State street car the other day was visibly affected by the sight of a dray horse which had fallen down. "Women are easily moved," observed Blabbs, as he stood on the back platform talking to the conductor. "You would not think so if you had to stand back here and clear the car for three days," said the man of sorrows and brass buttons.

PLANS OF THE NORTH CHICAGO RAPID TRANSIT COMPANY.

THE latest North Side rapid transit idea for Chicago is called very distinctly the North Chicago Rapid Transit Company, and the promoters asseverate the chief object of the company will be to obtain rapid transit for the North Side citizens who have the price.

The company is capitalized at \$10,000,000, by William Loeb, Geo. W. Claussenius, and Abraham Gottlieb, the civil engineer. The plan is for an elevated structure after the fashion of the Alley L, to traverse private property to be condemned after right of way has been secured. The line is to start from a point between Clark and Franklin streets, near Washington street, and cross the river near La Salle. Here the line will continue between Franklin and Wells to Wisconsin street, then north, spreading into two branches at Garfield avenue. The ordinance has been presented, and awaits action and —reaction.

PROSPERITY AND EXTENSIONS ON THE CICERO AND PROVISO RAILWAY.

THE Cicero & Proviso lines in this city have enjoyed a constantly increasing business from the start.

During the past few months a large and in every way modern power house has been completed and now the management is making further improvements in the system by a five mile extension west of the Desplaines river. This new track will connect the growing villages of Maywood and Melrose Park, and gives a continuous ride of eight miles from the city terminus at Fortieth and Madison streets, on one five cent fare. The power plant is being doubled by the addition of a 600-horse-power Bullock-Corliss engine and two No. 80 Edison generators. Additional cars have been ordered and will be put on July 1st. at which time it is expected to have the new line in operation.

The company is changing over its box cars, putting in cross seats with an aisle down the middle, in place of the common side seats. The object of the change is principally to make a more comfortable car for summer use, while at the same time one that can be used in winter. In warm weather the windows are taken out making a very pleasant open car.

For suburban service this is undoubtedly a good arrangement, as the "galloping" of an electric car is much less noticeable with cross than with side seats, and the facility of receiving and discharging passengers is not of great importance.

Great credit is due the able general manager, George Butters, for the progressive manner in which the interests of the road are handled, and which shows an increase in business for the past year, of 35 per cent, with no increase in miles of track.

The Citizens' line at Indianapolis has decided to equip all horse lines with electricity.

CAPTAIN C. H. SMITH GOES TO THE SCRANTON LINES.

CAPTAIN CHARLES H. SMITH, the new general superintendent of the Scranton Traction Company, is a Philadelphian by birth. In the year 1854, at the age of fourteen he moved with the family to Delaware City, Delaware, where some years later he was married and engaged in pedagogical pursuits till the opening of the war, when he entered the service as mate on the United States transport steamer "Diamond State." In this capacity he passed through many of the exciting scenes of the war on the Potomac, James and Rappahannock rivers. After the war, in 1866, he was employed as master of a small revenue cutter under the collector of customs of the Chincoteague Island district in Virginia, and two years later took charge of a light house on Assateague Island. The year 1873 found him at Wilmington, in his old



CAPT. CHAS. H. SMITH.

state, with the buoy store houses and docks at the mouth of the Christiana River under his keeping. A year later the United States light house tender "Rose" was put in his charge, and he was engaged in the survey of the Delaware Bay and river for the purpose of locating the range lights now on those water ways. It was during his command that those range lights were built. The captain now wears a silver medal presented him by the United States government as a recognition of an act of bravery in the rescuing of a drowning boy during his service on the Delaware river. The lad had sunk for the last time when the captain dived and brought him safe to the surface. This is but an incident to show the "stuff" of which the subject of this sketch is made.

In 1881 he was transferred to the light house engineers office of the fourth district at Philadelphia, as superintendent of construction of the fourth light house district, a position giving him charge of all building and repair work over an extensive territory. He quit the light house service in 1883, and when he entered on his career in the line of street railway work as assistant manager of the Wilmington City Electric Company, it will be seen that it was not without a large and varied experience. During the time that he was with this company the station was increased from 160-horse-power to 700-horse-power. In November '90 he became cashier and assistant superintendent of the Wilmington City Railway. Just two years later, H. H. Archer having left to take the place of manager of the Scranton Traction Company, Captain Smith took his place as superintendent. When Messrs. Archer and Smith entered the service

of the Wilmington road, stock was quoted at \$8, par value \$10. When they left stock was selling at \$24. On the first of last February Captain Smith left Wilmington to be again associated with his former general manager, H. H. Archer, and it is to be presumed that the prosperity attendant on his connection with the Wilmington road will now become the lot of the Scranton Traction Company.

THE CHRISTENSEN AIR BRAKE.

NCESSITY is the mother of invention and the necessity of air brakes for use with heavy and fast running electric cars has brought out several devices in this line. One of the simplest and most effective is the Christensen air brake, made by the Chicago Street Car Air Brake Company of the Rookery, Chicago.

The brake apparatus exclusive of the pump is simply a "straight" air brake, the air being admitted from the main air reservoir to the brake cylinder by the controlling valve at either end of the car, and let out of the brake cylinder when the brakes are released. The chief interest centers around the compressing pump, which is gov-

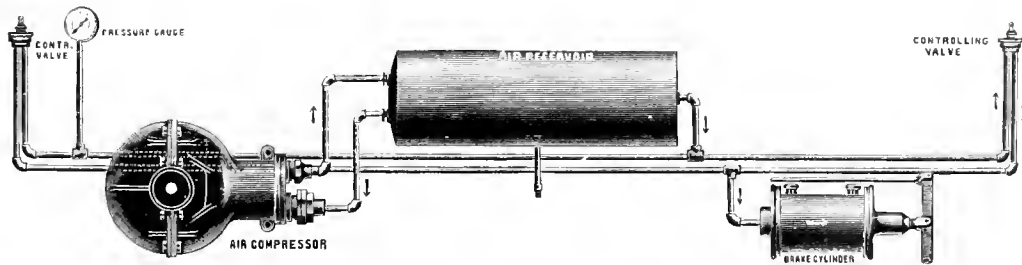

THE CHRISTENSEN AIR BRAKE.

erned in its action by the pressure in the main reservoir. This pump works from the axle, but when the pressure reaches the proper amount the governor removes the seat of the suction valve and the pump works against no resistance until the pressure is again lowered by the application of the brakes. The reservoir is of sufficient capacity to supply a trail car if desired. One application of the brake reduces the pressure 1½ pounds. The brake is being tried on several roads and so far has worked with satisfaction to all concerned.

COST OF OPERATING ELECTRIC CAR HEATERS.

THE Consolidated Car Heating Company, of Albany, New York, has just issued a table giving numerous figures on the cost of generating electrical energy under different conditions. The ultimate object, of course, is to get at the cost of running electric heaters, but the table has some interest aside from this. The cost of 1-horse-power hour at the car is given at \$.01355 under the most unfavorable conditions, viz.: with coal at \$3 per ton and high speed simple engines. This includes all the operating expenses—taxes, repairs, etc. The cost with

triple expansion slow speed condensing engines is given as \$.00718 with \$2 a ton coal. With the heaters using 8.09 amperes, which is the amount usually required in average winter weather, with the outside temperature between 20 and 0°, the highest cost per hour would be \$.03649 and the least \$.00913. This table has been compiled by the company's consulting engineer, James F. McElroy, from data given by Charles E. Emery, in the March 1893, Transactions of the American Institute of Electrical Engineers. It is computed on the basis of running 20 hours a day 365 days in the year. The table gives figures on over 500 items and will be found of great interest to those who are getting figures from their own plants as to cost per year of different items.

GAS MOTORS ON CHICAGO STREETS.

THE Connelley gas motor is now doing regular service on the Sheffield avenue line of the North Chicago Street Railroad, and is to all appearances doing good work. The company's own gas works, at the corner of Larrabee street and Garfield avenue, are now in operation. The gas is compressed in tanks at about 200 pounds pressure, and is hauled to the southern

terminus of the motor route, where it is supplied to the motors after each 25-mile run. An explosion occurred last month, due to a leaky hose connection, which allowed the car to fill with gas, while charging the tanks. A second explosion occurred May 1, but caused less damage although the engineer was burned somewhat. The regular operation of the motor has suggested several improvements in mechanical details, as is the case with all new machines, and these improvements are now being carried out. They are at present hauling one car, and acting only as feeders to the cables: not being run down into the heart of the city.

OUR PREDICTION FULFILLED.

SOME time ago the STREET RAILWAY REVIEW bore tidings prophetic of a large street railway deal in Oakland. The principal was F. M. Smith, the "borax king." Mr. Smith was thoroughly interviewed on the subject as soon as the REVIEW met the gaze of Oakland newspapers. The interviewer was told that the REVIEW was mistaken, but on April 25 it was announced that the Consolidated, of Oakland, had passed into other hands, together with large tracts of land near Berkeley and purchases for other lines.

STREET RAILWAY LAW.

EDITED BY MR. FRANK HUMBOLDT CLARK, ATTORNEY AT LAW, CHICAGO.

Liability of Corporation for Fraudulent Issue of Stock Certificate by Secretary.

A corporation is liable to the bona fide holder of a stock certificate which is signed and countersigned by its secretary and transfer agent, and which appears to be genuine, although the secretary has forged thereon the name of the president.

Plaintiff was a domestic banking corporation, and loaned one Hoefele \$15,000 upon his individual note payable in three months, and secured by the pledge of an instrument which upon its face purported to be a certificate for 160 shares of stock of the defendant, a domestic railroad corporation having its office and principal place of business in the same city with the plaintiff. It was subsequently discovered that this certificate was spurious and that the signature thereto of the defendant's president had been forged by one Eben S. Allen, secretary, who also was its treasurer and transfer agent, and who had in these capacities signed and counter-signed the certificate and delivered it to Hoefele, who was his partner in business, for the purpose of raising money on it to be used in the firm undertaking. We are required on this appeal to determine how far the defendant company is liable for the loss sustained by the plaintiff in consequence of this fraudulent and criminal act of one of its principal officers.

The good faith of the plaintiff in the transaction by means of which it became possessed of the forged certificate seems to be satisfactorily established. Hoefele was a stranger to the officers of the bank, they had no knowledge of his business relations with Allen, or that the latter was in any way interested in the proposed loan. Before acting upon Hoefele's application for a discount, the plaintiff's president sent a confidential clerk to the office of the defendant with the certificate, who, pursuant to instructions, showed it to the person in charge of the office, who was then unknown to the clerk, but who proved to be Allen, the secretary and treasurer, and who was asked if it was genuine and all right, and if Hoefele was a stockholder of the company—to which an affirmative reply was given, and a description of Hoefele, from which the bank might identify him as the person who had presented the certificate and sought the loan on the strength of it. The clerk reported the result of the interview to the plaintiff's officers, who thereupon discounted Hoefele's note for the sum named, payable in three months, and accepted the certificate as collateral security, in the usual form, for its payment, and for all other present or future demands of the bank against him.

The defendant was incorporated under the General Railroad Law. Its books relating to the issue and transfer of stock consisted of a certificate book, a transfer book, and a stock ledger, which were all kept by the secretary and were in his immediate custody. When stock was issued, the engraved certificate was taken from

the certificate book and filled up by the secretary, presented to the president and treasurer, who signed it, and it was then countersigned by the secretary as transfer agent, and sealed by him with the seal of the corporation and delivered to the stockholder named in it. The secretary at the same time inserted the proper data in the stub remaining in the certificate book, and made the necessary entries in the transfer book and the stock ledger. The certificate received by plaintiff from Hoefele had been taken from the certificate book; it appeared upon its face to be perfect and regular in every respect; it had the name of the president and treasurer signed to it; was countersigned by the transfer agent, and bore the impress of the corporate seal. It recited that Hoefele was the owner of 160 shares of \$100.00 each of the capital stock of the company, contained the usual provisions in regard to the mode of transfer, and declared that no certificate should bind the company unless signed by the president and countersigned by its treasurer and transfer agent. It is very clear that under the regulations adopted by the defendant, and pursuing the mode of procedure which it had prescribed, the final act in the issue of the certificate was performed by its secretary and transfer agent, and that when he countersigned it and affixed the corporate seal, and delivered it with the intent that it might be negotiated, it must be regarded, so long as it remained outstanding, as a continuing affirmation by the defendant that it had been lawfully issued, and that all the conditions precedent upon which the right to issue it depended had been duly observed. Such is the effect necessarily implied in the act of countersigning.

The rule is, we think, correctly stated in Beach on Private Corporations: "When certificates of stock contain apparently all the essentials of genuineness, a *bona fide* holder has a claim to recognition as a stockholder if such stock can legally be issued, or to indemnity if it cannot be done. The fact of forgery does not extinguish his right when it has been perpetrated by or at the instance of an officer placed in authority by the corporation, and entrusted with the custody of its stock books, and held out by the company as the source of information upon this subject."

(Ct. App. N. Y. Fifth Ave. Bank of N. Y. vs. Forty-second St. & Grand St. Ferry R. Co. 8 N. Y. L. Jour. 1521).

Injury by Electric Car—Negligence of Teamster—Leaving Team Standing Across Track.

It was obviously unnecessary for the appellee to drive upon and occupy the railway tracks as he did, for the purpose of unloading the safe. It was twelve feet and two inches from the curb to the nearest rail, and it sufficiently appeared from the evidence that it was practicable to remove the safe from the wagon to the store without encroaching upon the railway in any manner.

It is essential to a correct appreciation of the situation to bear in mind that it was on a dark night in April; that the obstruction was directly across the track of a railway on which the cars were driven by electricity and at a point where they ran on a descending grade. In the presence of these conditions, well known to the appellee, and in the absence of adequate cause therefore, his action in obstructing the appellant's road was negligent and reckless. It was not only an unjustifiable interference with public travel, and an inexcusable exposure of his own and the company's property to injury and perhaps destruction, but it imperilled the limbs and lives of the company's employes and passengers. If his horses were injured while in the position described by him, he is without just claim to compensation for the injury, because it was the direct result of his own negligence.

(Sup. Ct. Penna. *Winter vs. Federal Street & Pleasant Valley Pass. Ry. Co.* 23 Pitts. Leg. Jour. 302).

Right of Way of Street Railway Company—Paving—Special Assessment.

By ordinance of a city a street railway company was required to pave its right of way, being sixteen feet along a street. By another ordinance the paving of the street its entire width was required, and the commissioners appointed for that purpose reported that they had made an estimate of the cost of such improvement. *Held*, that the cost of paving the center sixteen feet of the street was wrongfully included in the estimate of the cost of the improvement to be charged upon the property benefitted, and that judgment of confirmation of the assessment roll was properly denied.

In such case the ordinance for the improvement of the entire street is not void, if so much was required for the public convenience; but the city having required the street railway company to fill, grade, pave, and keep in repair during all the time it has the privilege of using the street, sixteen feet in width, when a double track is used in accordance with such ordinance as the city council may pass respecting such fillings, grading, paving or repairing, and requiring the same to be done by the railway company with like material in like manner and at the time as required in respect to the rest of the street, the cost of paving so much of the street should have been excluded from the estimate.

When a street railway company is required to pave its right of way in a street required to be paved, such company should not be assessed for benefits arising from the paving of the balance of the street, in the absence of proof showing that the expense of paving the right of way would not be a fair and adequate apportionment of costs according to benefits accruing to property of the railway company in the street by the improvement.

(Sup. Ct. Ills. *City of Chicago vs. E. A. Cummings & Co.* 25 Chi. Leg. News 254.)

Injury to Person Standing in Street.—Car Rounding Curve.

A street railway company is not liable for injury sustained by one who was struck by the handle on the rear

dasher of a car as it rounded a corner where she was standing near the track waiting for the car to pass and saw it before it reached her, but thought she was far enough from it to be safe, and there was no defect or improper management in the car or its equipments or in the track.

(Sup. Ct. Mass. *Widmer vs. West End St. R. Co.* 32 N. E. Rep. 899.)

Injury to Child on Track—Negligence of Gripman.

A gripman who, at the time of running over a child which suddenly runs upon the track, is standing upon one side of the cab looking towards the houses and not having hold of grip or brake, is guilty of negligence.

(Sup. Ct. Pa. *Schmur vs. Citizens' Traction Co.* 25 Atl. Rep. 650.)

Driver Removing Passenger from Car—Action for Death—Person Having Heart Disease.

A street railway company is not liable for the death of one who, during an attack of heart disease, was rudely and roughly removed from the car by the driver, under the mistaken impression that he was drunk, and placed on the sidewalk where he soon after died, where there is nothing to show that it was not the disease that killed him, or that the driver's wrongful acts in any manner produced or hastened his death.

(Sup. Ct. Minn. *Briggs vs. Minneapolis St. R. Co.* 53 N. W. Rep. 1019.)

Injury to Passenger by Being Pushed from Car by Fellow Passenger—Excitement Caused by Negligence of Street Railway Company.

A street railway company is not rendered liable, as matter of law, for injuries to a passenger pulled or pushed off a car by other passengers, by the fact that such injured passenger has been surprised or excited and bewildered by the negligence of the company.

(Ills. App. Ct. *Joliet St. R. Co. v. McCarthy.* 42 Ills. App. Rep. 49.)

Newsboy Riding on Street Car—Care Required of Company.

A newsboy was injured while clinging upon the front platform of a street car as the result of the car running off the track; this court holds that in an action brought against the street car company to recover damages for the injuries received, as the evidence failed to show that the street car company or its employes were guilty of gross negligence, the boy, who was not a passenger but a mere licensee, could not recover.

(Ills. App. Ct. *North Chicago St. R. Co. v. Thurston.* 43 Ills. App. Rep. 587.)

THE Southwestern Missouri Electric Railway Company, connecting Cartersville and Webb City with Joplin, plans to extend to Carthage, Baxter Springs and Kansas City, making the most complete interurban and urban connection in the southwest.

PURIFYING STEAM WATER.

VERY few electric railways, or other steam users, are able to secure a really desirable water in its natural state for steaming. Hence, the wide field for the manufacturer of feed water purifiers. The following illustrations, which are reproduced from the annual catalogue of the Hoppes Manufacturing Company, Springfield, O., discover a very interesting deposit which was the result of a 42 days' run on a plant in that city.

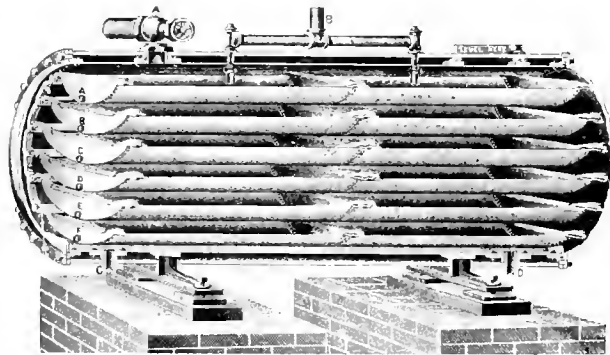

SECTIONAL VIEW OF PURIFIER.

As shown in the sectional view of the purifier, the water enters the upper pan (below the water level of the pan to prevent the steam entering the feed pipe) and overflows from one pan to the next lower in a thin uniform sheet. The bottom of the pans afford settling chambers for the heavier solids, but the most interesting feature is the formation of sulphates and silicates of lime and magnesia which gather in a crust on the under side of the pan as shown in the illustration. Anyone who has ever spent any considerable time in the Yellowstone National Park, could not but have been impressed with the rapid build-

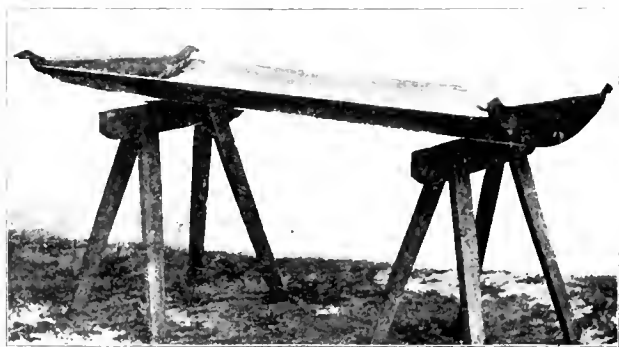

CLEAN PAN BEFORE USING.

ing up of the formation on the mountain side directly in front of the Hot Springs Hotel. There great pools of boiling water, clear as crystal, but full of deposits, overflow in a film of water scarcely thicker than the paper on which these words are printed, and following the contour of the formation builds it up at a rate easily distinguishable from day to day. Mr. Hoppes has adopted Nature's methods, although he drew his idea from the stalactite

formation in caves. An interesting feature of the pan deposit is that the scale from the under side of the upper



SAME PAN AFTER FORTY TWO DAYS' RUN.

pans while thicker than those below is less hard, the last two pans yielding a scale extremely hard and almost transparent.

THRILLING EXPERIENCE OF MAN-AFRAID-OF-AN-AD.

A TRIVIAL incident at Columbus, Ohio, the other day, was the unintentional cause of much teeth gnashing and caustic resolutions. It seems the Columbus Street Railway has a motor freight car and a number of flats, which are used in transporting ties, rails and other heavy construction material to any part of the lines where repairs are being made. This is done chiefly at night. The same cars are also used in hauling coal to the various car houses where it is converted into car propelling electricity. On this particular occasion a car load of coal was standing on the side track waiting the arrival of the motor car. Meanwhile the coal company which furnishes fuel to the road, tacked upon each side of the car a business card 12 by 16 inches, advertising their coal.

Ordinarily this occurrence would have occasioned no special notice or comment, but it chanced that on this particular day a convention of advertising and newspaper men were in convention at Columbus. The sight of this car passing through the streets with a couple of innocent cards tacked on was as salt to a wound and as a crimson fabric to a male bovine. And thereupon the object of the convention was lost sight of in the discussion of street railways infringing upon the rights of "legitimate advertisers." By their own action these publishers placed a higher standard of value on street car advertising than their own sheets, and altogether made a ridiculous spectacle of themselves. Street cars are excellent places to advertise many things, as shown by the liberal use of the cars all over the land by the largest and most judicious advertisers in the country. What bothers these country editors is to find as many readers for their papers as the street railway company furnishes its advertising patrons.

A COMPLETE CLASSIFICATION OF ACCOUNTS.

THE Chicago City Railway is now operating by cable, electric and horse systems, and to provide for the new expense items created by the adoption of electricity a complete revision of its accounting system has been made by J. F. Johnson, for many years connected with the road and one of the most experienced railway accountants in the country.

So detailed is the distribution that it cannot but prove of interest, and suggestive to officers contemplating a change in their own system of accounts. We give the classification in full, as follows:

GENERAL INSTRUCTIONS.

It is of absolute importance that the accounts of the company should be kept in an accurate and systematic manner, so as to show not only general results, but also the many details, that comparisons may be made between each of our systems, and with different periods.

In the accounts of this company two divisions are made as follows:

No. 1. EXPENSE ACCOUNTS,—which includes the cost of operating and renewals classed under the following general headings, viz:

- General Expenses.
- Transportation.
- Motive Power.
- Maintenance Track, Roadway and Buildings.
- Maintenance Rolling Stock.

No. 2. CONSTRUCTION, IMPROVEMENT, AND PROPERTY ACCOUNTS,—which includes cost of construction, improvement and addition to property.

- The systems referred to are
 - Horse—which includes all lines operated by animal power.
 - Cable—which includes all lines operated by cable power.
 - Electric—which includes all lines operated by electric power.

In Division No. 1, should be included all disbursements for service, labor and material, employed and used in operating and maintaining the systems, and charged to accounts representing the particular thing for which the expenditure was made.

In Division No. 2, should be included all disbursements for service, labor and material, employed and used in construction of new track, buildings, machinery, etc., improvements to all equipment of a permanent nature, and additions to property.

Renewals of track, buildings, machinery and equipment should not be construed as an addition or betterment to property, but included in Division No. 1, under repairs and renewal of property to which it belongs. Example:—A new sheave wheel is placed in cable machinery plant to replace one worn out, which is a renewal, as it leaves the plant in its original condition; while the addition of a new sheave wheel to the plant would add to its value and efficiency, and bring it under Division No. 2, being a permanent improvement to cable machinery, No. 103. Same example will apply to rails, frogs, crossings, equipment, cars, etc., etc.

Depot Foremen, Timekeepers and others, at depots where cars are handled for operating two or more systems, should use especial care when certifying expenditures, or keeping time, to have same show to which system, as well as the account to which it belongs.

Example:—Pushers, Townmen, etc., who handle cars on all systems should be entered on time book as

John Doe, Towing, Horse	.4
" " " Cable	.3
" " " Electric	.3

showing that he worked four hours towing horse cars, three hours on cable cars, etc.

Horse Shoers time should show amount of work done on horses belonging to track department.

Blacksmiths time should show amount of work done on each,—cars, grips, wagons, etc. and not lumped as "Blacksmith."

Time of Watchman should show where service was performed, in car house, stable, street, or elsewhere.

Parties handling coal, or certifying to accounts and labor for same, should show the kind of coal and how used, whether for depot, cable or

electric steam plants, buildings, stoves, heating cars, horse shoeing, machine shop, pits, drying sand, etc., etc.

Especial care should be used in classifying expenditures for electrical car equipment and repairs from those incurred for other cars or purposes.

A "car" means the body, trucks, etc., or everything except the motor or electrical appliances.

A "motor" means the machinery attached to the trucks of the car, and all electrical appliances for regulation and transmission of electric current from trolley wire to motor, including trolley pole and base, rheostat, etc.

Division No. 2 —In construction of new tracks, buildings, machinery, cars, etc., additions to real estate, improvement of plants and equipment, an account should be opened for each, indicating by title the nature and extent of the construction, etc., to which all expenditures should be charged until same is completed, when it should be transferred to its proper account as shown herewith.

Example. "Construction 55th Street, State Street to Western Avenue."—"Construction 47th Street, Halsted Street to Ashland Avenue, (electric), divided as follows:

- Surface Construction.
- Underground "
- Overhead "

"Construction Archer Avenue, State Street to River (cable)" "Real Estate, Stoney Island Avenue, and 63rd Street"—"Cable Power Plant, 39th Street"—"Car House, Root and Halsted Street"—"50 Box Cars."—etc., etc.

All preliminary expenditures such as engineering, draughting, removing heavy material and obstructions, making tools, drawing papers and procuring abstracts for real estate, obtaining right of way, building permits, etc., etc., should be charged to respective accounts for which same was incurred.

Heads of departments, foreman, timekeepers and others having charge of the approval and distribution of time, or certifying to the expenditures for material, should familiarize themselves with the classification herewith, and in case of any doubt apply to the auditor or secretary for instructions, or, if they are not readily accessible, state the nature of labor and where performed, or describe the material and state how and where placed.

The distribution of all amounts by the various departments will be examined carefully by the auditing department, and the heads of all the departments will be held accountable for errors and omissions.

DIVISION No. 1.

Expense Accounts.—General Expenses.

OPERATING.

1. **General Superintendence.**—Includes salaries of all officers whose duties and jurisdiction extend over the entire system of the Company.
2. **Wages, Clerks and Employes, (General Office).**—Includes wages of clerks whose duties pertain to entire system, and employes of general office, policemen, watchmen, etc.
3. **Miscellaneous General Expenses.**—Includes general office expenses not otherwise provided for, such as donations, directors' meetings, telegraph and messenger service, traveling expenses, etc.
4. **Printing and Stationery.**—Includes cost of printing department and all general printing and stationery *that does not belong to a specific account*, books, paper, envelopes, postage stamps, rubber stamps, pens, ink, pencils, etc., advertising, subscriptions to papers, periodicals, etc., etc. See transportation general expenses, damages, legal expenses, etc.
5. **Telephone Service.**—Rentals, salaries of operators, cost of moving instruments, lines, etc.
6. **Office Expenses.**—Wages of janitors, elevator men, cost of heating and lighting office, soap, towels, etc., repairs of desks and furniture.

FIXED.

7. **Insurance.**—Cost of insurance on the property of the company
8. **Taxes.**—All personal and real estate taxes on the property of the company, and taxes or license fees as provided by city ordinances.
9. **Damages.**—Includes expenses and payments on account of injuries to persons, and damage to property, wages of persons while disabled, medical attendance, funeral expenses, cost of witnesses and testimony outside of court; also salaries of claim agent, assistants and clerks; and books and blanks used in this department.

This account should not include lawyers' fees, court expenses, or damage to the company's property.

10. Legal Expenses.—Includes fees, and all expenses of attorneys, witnesses, and all court expenses; also, salaries of counsel and attorneys, (exclusively in service of company), clerks, cost of books, printing, etc.

11. Interest.—Interest, discount, premium and commission paid on all paper of the company, except bonded indebtedness.

TRANSPORTATION.—TRAIN SERVICE.

12. Wages, Conductors.—Includes wages of conductors on all systems. Wages for operating car on two or more systems to be apportioned to each according to mileage made.

13. Wages, Drivers.—Includes wages of drivers on all horse car lines.

14. Wages, Gripmen.—Includes wages of gripmen on all cable lines.

15. Motormen.—Includes wages of men operating motors on electric lines.

16. Wages, Starters.—Include wages of all starters.

17. Wages, Flag and Trapmen.—Includes wages of all flag and signalmen at railroad and street crossings, boulevards, etc., and trapmen at cable pick-ups.

18. Wages, Towmen, Signalmen and Couplers.—Includes wages of towmen at all points, reliefmen, signalmen operating electric signals in connection with gravity switches at depots, couplers at cable junctions with other lines, to be charged to systems on which work was done, in proportion to labor performed for each.

19. Wages, Pushers and Elevator Men.—Includes wages car pushers and elevator men handling cars at depots, to be charged to each system in proportion to work done.

20. Wages, Depot Clerks and Receivers.—Includes wages of clerks at depots who keep time and records of trainmen, and wages of receivers handling receipts from conductors, taking register statements, etc.

Timekeepers for depot men, store room clerks, etc., should not be included in this account.

21. Cleaning Cars.—Includes wages of men washing, sweeping and dusting cars, cleaning windows, cushions, platforms, etc., and cost of all supplies for this service, such as soap, brushes, dusters, scrubs, hose, etc.

GENERAL SERVICE.

22. Oiling and Lighting Cars.—Includes wages of men and cost of supplies for oiling car journals, brakes, grips, etc., oil, wicks, etc., for lamps.

Lighting electric cars and lamp repairs should not be included in this account.

23. Heating Cars.—Includes wages of men starting and drawing fires, cost of coal, kindling, etc., and expense of handling and hauling same, putting in and removing heaters and pipe at beginning and end of season.

Repairs to heaters and pipe should not be included in this account.

24. Wreck Wagon Service.—Includes wages of men operating same and cost of repairs and renewal of tools, equipment, etc.

25. Registers. Includes rental and expense of registers, indicators, etc.

26. Inspection. Includes wages and expenses of inspectors, and cost of all inspection connected with transportation.

27. Miscellaneous Car Service.—Includes cost and expense of conductors and drivers, badges, punches, stamps, etc., flags and decorations for trains, printing bulletins, orders, etc., for trainmen, time table blanks records, etc., and all expense for car service not otherwise provided for.

28. Supervision.—Includes wages of time table superintendent, supervisors, their assistants and clerks.

29. Transfers.—Includes labor and material for printing and distributing transfers, wages of transfer agents, etc.

DEPOT EXPENSES.

30. Wages, Foremen and Assistants.—Includes wages foremen, assistant foremen, timekeepers for depot men, store room clerks, etc.

31. Wages, Watchmen and Janitors. Includes wages watchmen; and men sweeping, cleaning and keeping in order car house, office, etc.

32. Wages, Engineers and Firemen.—Includes wages engineers and firemen employed on steam plants at depots, for operating elevators, heating buildings, drying sand, cutting feed, etc., to be apportioned to different accounts, and to each system, in proportion to work done for each.

33. Repairs Engines, Boilers and Equipment.—Includes cost of repairs and renewals of engines, boilers, gearing, tools for use of same at depot.

34. Fuel.—Includes cost of fuel for depot steam plants.

35. Oil, Waste, Water and Supplies.—Includes cost of oil, waste, polish, water and supplies for depot steam plants.

36. Electric Lighting.—Includes cost of electric lighting at depots, repairs and renewal of lamps, dynamos, electric equipment, wires, etc.

37. Miscellaneous Depot Expenses.—Includes expenses of fuel, heating and lighting depots (except 34 and 36) and all depot expenses not otherwise provided for.

MOTIVE POWER, POWER HOUSE—Cable.

38. Wages, Engineers, Firemen and Helpers.—Includes wages of all engineers, firemen, helpers and oilers of engines and machinery employed in cable power houses.

39. Repairs and Renewals Engines, Boilers and Machinery.—Includes cost of repairs and renewals of engines, boilers and appurtenances, machinery for operating cables, tools for use of same and all equipment in cable power house; except electric light equipment.

40. Oil, Grease, Waste, Water, Etc.—Includes cost of all oil, grease, waste, polish, water, etc., used for maintenance and operation of cable power house plant (See 39) except electric light equipment.

41. Fuel.—Cost of fuel for boilers furnishing steam for operating cable power house engines and machinery, and expense of delivering same to power house.

42. Electric Lighting.—Includes wages of operators, cost of repairs to electric engines, dynamos, switch board and apparatus, lamps, globes, wire and supplies for maintenance of electric lighting plant. All buildings supplied with this light should be charged with their proportion of these operating expenses.

43. Miscellaneous Cable Power House Expenses.—Include expense of handling cinders, and all other expense not otherwise provided for.

POWER HOUSE.

Electric Steam Equipment.

44. Wages Engineers, Firemen and Helpers.—Include wages of all engineers, firemen, helpers and oilers of engines and machinery, employed on steam equipment of electric power house.

45. Repairs and Renewals, Engines, Boilers and Machinery.—Includes cost of repairs and renewals of engines, boilers and appurtenances, machinery for operating electric equipment, tools for use of same, and all repairs connected with steam equipment of electric power house—electric lighting excepted.

46. Oil, Grease, Waste, Water, Etc.—Includes cost of all oil, grease, waste, polish, water, etc., used for maintenance and operation of steam equipment, electric power house. (See 45) Electric lighting excepted.

47. Fuel.—Cost of fuel for boilers furnishing steam for operating steam equipment electric power house, and expense of delivering same to power house.

48. Electric Lighting.—Includes wages of operators, cost of repairs to electric engines, dynamos, switch board and apparatus, lamps, globes, wire and supplies for maintenance of electric lighting plant. All buildings supplied with this light should be charged with their proportion of these operating expenses.

POWER HOUSE.

Electric Equipment.

49. Wages, Electric Engineers and Assistants.—Include wages of electrical engineer and assistants, and of all labor employed in operating electrical power equipment. Wages for operating electric light equipment should not be included in this account.

50. Repairs and Renewals of Generators.—Includes cost of repairs and renewals of generators or dynamos and their parts, such as armatures, fields, commutators, oilers, bearings and boxes, belting, brush holders, brushes, etc., also all labor for removing and replacing damaged parts.

51. Repairs and Renewals of Switch Board and Equipments.—Includes cost of repairs and renewals of switch board and switch board equipment, station switches, rheostats, wiring and connections, and all apparatus for measuring and regulating electric current, also all labor and expense removing and replacing damaged parts.

52. Repairs and Renewals, Miscellaneous Electrical Equipment.—Includes cost of repairs and renewals of power house electrical equipment not included in 50 and 51.

53. **Oil, Waste and Supplies.**—Includes cost of oil, waste, polish, supplies, etc., for the operation of power house electrical equipment.

53 **A. Miscellaneous Power House Electric Expense.**—Includes cost of books, blanks, records, etc., and all expenses not otherwise provided for.

HORSE SERVICE.

Any Expense for Teams Used in Track Services Should Not be Included in This Account.

54. **Wages, Stablemen.**—Includes wages of all men employed in care of and handling horses for train service and auxiliary thereto, such as grooms, changers, feedmen, haymen, watermen, watchmen (stable), nurses, veterinary, whitewashers, teamsters (stable service), etc.

See 30 depot expenses for wages foreman assistants to be charged each system in proportion to service for each.

55. **Grain.**—Includes cost of grain used by company for feeding horses and all expenses incurred in delivery to place used, wages of miller, commissions, tools, etc.

56. **Hay.**—Includes cost of hay used by company for feeding horses, and expenses incurred in delivering to place used, teaming, commissions etc.

57. **Loss on Horses.**—Includes loss and gain on horses sold, died or given away, being the loss or gain between the value of such horses, and amount realized for same.

58. **Horse Shoeing.**—Includes cost and expense of shoeing horses, such as wages of shoers, cost of shoes, nails, calks, transportation charges on same, tools, etc.

59. **Repairs, Harness.**—Includes cost of repairs and renewals of harness used for transportation, and auxiliary service, wages of repairers, etc., including whiffletrees double and single, blankets, whips, etc.

60. **Repairs, Stable Tools and Equipment.**—Includes cost of repairs and renewals of stable tools and equipment, such as feed cutters, feed carts, wagons (for stable use), forks, shovels, brooms, oil and grease for lubricating, etc.

61. **Medicines, Water and Bedding.**—Includes cost of medicines, drugs, surgical instruments and apparatus, linseed meal, bran, salt, etc.; water used for stable purposes; and bedding of all kinds for horses.

62. **Miscellaneous Stable Expenses.**—Includes all expenses not stated above, fuel for stable use, lighting building (except electric lighting), books, records, blanks, etc.

MAINTENANCE TRACK, ROADWAY AND BUILDINGS.

SURFACE.

63. **Repairs and Renewal of Tracks and Road Bed.**—Includes cost of material and labor, and all expense for maintenance of all surface tracks and roadways.

New rails, ties, splice bars, nuts, bolts, etc., used to replace those removed, with cost of transportation, and labor employed in removing and replacing same.

Also, cost of labor and material, and all expense for repairs and renewals of paving on tracks, or street where same is to be maintained by the Company.

Wages of trackmaster, foremen, timekeepers; cost of records, books, blanks, etc., and all expense for maintenance of track and roadway not otherwise provided for should be charged to this account.

Repairs of underground cable, and those of an electrical nature should not be charged to this account.

64. **Repairs, Track Equipment and Tools.**—Includes cost of repairs and renewals of all equipment and tools used in maintenance of tracks and road bed, such as wagons, forges, drills, bars, shovels, picks, etc.

Also, repairs and renewals of snow-plows, sweepers, salters, sand drying equipment, and all tools for track cleaning equipment

65. **Cleaning Tracks.**—Includes cost of all labor, and expense for removing snow, ice, mud, dirt, etc., from track; and also the use of sand, cinders, etc., for slippery tracks, cleaning cross-walks, and hauling snow from streets, hauling and drying sand, cost of salt and hauling, refreshments for laborers, etc.

66. **Feed and Care of Track Horses.**—Includes cost of hay, grain, and all labor and expense in care of horses used for track service exclusively, such as wages of grooms, feedmen, watchmen, nurses, etc.; loss on horses; horse shoeing; repairs harness; blankets, whips, etc.; repairs and renewal of barn tools and equipment; medicines, water, bedding, lighting and heating stable, and all expense connected with care track horses not otherwise provided for.

UNDERGROUND CABLE.

67. **Oil and Grease for Pulleys and Cables.**—Includes cost and expense of all lubricating oils, grease, compounds, etc., used on pulleys, sheaves, pit machinery, and all underground cable equipment, and cable rope.

68. **Repairs and Renewals of Yokes, Pulleys and Pit Machinery.**—Includes cost of labor and material for repairs and renewals of yokes, pulleys and frames, pit machinery and gearing, and all underground equipment.

69. **Wages, Oilers, Pit and Ropemen.**—Includes wages of all men employed in oiling pulleys, cable rope and underground equipment; men in charge of pits and pit machinery, and men employed for splicing and inspection of cable rope, removing old rope from and placing new rope in conduit.

70. **Wear of Cable Rope.**—Is the depreciation of cable rope from original cost when unfit for use or removed from conduit; amount received from sale of same should be credited to this account.

71. **Handling Cable, Old and New.**—Includes wages and expense of moving new cable rope from railroads to our depot, reeling, repairs of reeling equipment and tools; handling and reeling old cable rope after removal from conduit, cutting same, and repairs of cutting equipment and tools, delivering same to depot when sold.

72. **Cleaning Conduit.**—Includes wages and expense of cleaning cable conduit, removing and dumping, repairs and renewals of cleaning tools and equipment.

73. **Miscellaneous Underground Cable Expenses.**—Includes all underground cable expenses not otherwise provided for, cost of heating and lighting pits, etc., etc.

ELECTRIC.

Electric Underground Construction.

74. **Repairs and Renewals.**—Includes cost of all labor and material used in repairs and renewals of supplementary wire and connections, drilling rails, cost of wire, solder, and all tools used in repairing underground electrical equipment. Repairs, renewals and changes of switches, frogs, ties, etc., should not be charged to this account. See 63.

Overhead Electric Construction.

75. **Repairs and Renewals.**—Includes cost of all labor and material for repairs and renewals of poles, cross-arms, feeder, guard and trolley wires, and all devices of an electrical nature used in overhead construction. Expense of repair wagons, and cost of tools and implements necessary for this work should be charged to this account.

76. **Miscellaneous Electric Line Expenses.**—Includes all expenses applicable to overhead electric line equipment not otherwise provided for.

REPAIRS AND RENEWALS OF BUILDINGS.

77. **Repairs of Buildings, Docks, Etc.**—Includes cost of repairs and renewals of all buildings used by the company. Power houses, depots for cars and horses, office buildings, shops, mills, sheds, etc.; and all stationary fixtures of same, foundations for engines, dynamos and machinery, chimneys, smokestacks, tracks, turn and transfer tables for car houses; elevators, stationary feed bins, vaults, stationary forges, oil rooms, coal bins; also gas and water pipes and connections.

Repairs and maintenance of docks, wharves, etc., should be charged to this account.

MAINTENANCE ROLLING STOCK.

GENERAL.

78. **Repairs and Renewals of Cars.**—Includes cost of repairs and renewals of all cars (except see S1 and S2), such as car bodies, trucks (except see S2), wheels, brakes, axles, painting, varnishing, upholstering, signs and lettering, track scrapers, bell cords, lamps, heaters (not electric) and pipe, mats, straps, gongs, etc., etc., everything pertaining to a car and its equipments except those of an electrical nature. The cost of new cars to replace those worn out and destroyed should be charged to this account.

Wages of master mechanic, assistants, timekeepers and clerks should be included.

79. **Repairs and Renewals, Shop Tools and Machinery.**—Includes cost of repairs and renewals of all fixed and heavy tools and machinery, lathes, planers, shapers, cranes, anvils, bellows, portable forges; engines, gearing, etc., also cost of all small tools such as chisels, hammers, bits, brushes, etc., and expenses of oiling machinery, gearing and tools.

80. Miscellaneous Shop Expenses.—Includes cost of heating and lighting shops, water; books, records, blanks, etc., and all expenses not otherwise provided for.

ELECTRIC.

81. Repairs and Renewals of Motors.—Includes cost of material, labor, and all expenses for renewals and repairs of gears, pinions, trolleys and their parts, field coils, lightning arresters, switches, fuse boxes, armatures, rheostats, brush holders, yokes and springs, motor pans, controlling stands, motor frames and arms, button boards, bolts, carbons, etc., also expense of all wiring of car except that for electric lighting; in fact, all electric repairs and renewals, except trucks and electric lighting.

Cost of books, blanks, etc., for record of motor and parts should be charged to this account.

82. Repairs and Renewals of Motor Trucks.—Includes cost of repairs and renewals of motor trucks

83. Repairs and Renewals, Miscellaneous Electric Car Equipment.—Includes cost of repairs and renewals of electric car equipment not included in No. 81 or 82, such as wiring for electric lighting and heating cars; cost of globes, lamps, etc., parts for heaters, repairs and renewal of same, and all equipment pertaining thereto not otherwise provided for.

84. Inspection of Electric Cars—Includes wages of men inspecting and examining electric cars and equipment; and cost of books, blanks, etc., used for that purpose.

CABLE.

85. Repairs and Renewals of Grips.—Includes wages, cost of material and all expense for repairs and renewals of grips, and all parts pertaining to same; wages moulders, lathemen, cost of steel, iron, copper, brass, bolts, etc., and all expense connected with same.

DIVISION No. 2.

Construction, Improvement and Property Accounts.

100. Construction.—Includes cost of grading, surfacing, ditching, filling, paving, sewer connections, rails, chairs, splice-bars, ties, stringers, rods, spikes, switches, crossings, yokes, braces, iron, pulleys and frames; poles, wires and all miscellaneous material used for construction of all tracks, horse, cable and electric; cost of labor and teaming for placing material in position.

Where required to grade, ditch, fill surface, pave, or improve any portion of street or roadway outside the lines of our tracks, cost of same should be included in this account.

101. Real Estate.—Includes cost of all real estate, improved or unimproved, purchased by the company.

102. Buildings.—Includes cost of all labor and material used in construction of buildings of all kinds; power stations, car houses, stables, storehouses, waiting depots, offices, etc.; also, cost of docks and wharves.

All fixed equipment, such as foundation for engines and machinery, car house tracks, transfer and turn-tables, elevators, stationary forges, stalls, bins, vaults, water, gas and electric lighting fixtures, etc., should be charged to this account.

103. Cable Machinery.—Includes cost of engines, boilers, steam pipes and fittings, all power house and pit machinery for operating cable lines, and cost of labor and teaming for placing same in position.

104. Electric Machinery.—Includes cost of engines, boilers, steam pipes and fittings, wires, all power house steam and electric machinery, and equipment for operating electric lines, and cost of labor and teaming for placing same in position.

105. Tools and Machinery.—Includes cost of all heavy and fixed tools for shop, tracks and depots, such as lathes, planers, shapers, cutters, power drills, etc., rail benders and saws, heavy jacks, etc., etc., portable engines, and engines, boilers, and machinery connected therewith for operating plants at shops, depots and office buildings; also, engines, machinery generators and electric lighting equipment, and cost of labor and teaming for placing same in position.

106. Miscellaneous Equipment.—Includes cost of all snow-plows, sweepers, salters, etc., built or purchased; also, wagons and vehicles of all kinds, and rolling stock and equipment not otherwise provided for.

107. Passenger Cars.—Includes cost of all cars for passenger service, purchased or built, with all equipments pertaining to same, such as motors and all electric appliances, trucks, brakes, scrapers, gongs, heaters, lamps, straps, etc., etc.

Freight charges and cost of delivering cars to our depots should be included in this account.

108. Horses—Includes cost of all horses purchased and expense of delivering same to our depots.

109. Cable—Includes cost of all cable rope purchased and expense of delivering same to our depots.

110. Office Furniture and Fixtures.—Includes cost of office equipment of a permanent character, such as safes, desks, counters, railings, etc.

111. Supplies.—Includes cost of supplies and material purchased for future use, or more than required for the current month, such as grain, hay, lumber, rails, ties, poles, wire, car wheels, etc., to be charged to the respective accounts to which they belong when used.

112. Uniforms.—Includes amount paid for uniforms for trainmen.



U. S. MAIL CARS ON THE CINCINNATI INCLINED PLANE RAILWAY.

Abraham Lincoln

When leaving his home at Springfield, Ill., to be inaugurated President of the United States, made a farewell address to his old friends and neighbors, in which he said, "NEIGHBORS GIVE YOUR BOYS A CHANCE." These words come with as much force to day as they did thirty years ago.

How give them this chance?

Up in the Northwest is a great empire waiting for young and sturdy fellows to come and develop it and "grow up with the country." All over this land are the young fellows, the boys that Lincoln referred to seeking to better their condition and get on in life.

Here is their chance!

The country referred to lies along the Northern Pacific R. R. Here you can find almost anything you want. In Minnesota and in the Red River Valley of North Dakota, the finest of prairie lands fitted for wheat and grain, or as well as for diversified farming. In Western North Dakota, and Montana, are stock ranges limitless in extent, clothed with the most nutritious of grasses.

If a fruit farming region is wanted there is the whole State of Washington to select from.

As for scenic delights the Northern Pacific Railroad passes through a country unparalleled. In crossing the Rocky, Bitter Root, and Cascade Mountains, the greatest mountain scenery to be seen in the United States from car windows is to be found. The wonderful bad lands, wonderful in graceful form and glowing color, are a poem. Lakes Pend d'Oreille and Creur d'Alene, are alone worth a trans-continental trip, while they are the fisherman's Ultima Thule. The ride along Clark's Fork of the Columbia River is a daylight dream. To cap the climax this is the only way to reach the far-famed Yellowstone Park.

To reach and see all this the Northern Pacific Railroad furnish trains and service of unsurpassed excellence. The most approved and comfortable Palace Sleeping cars; the best Dining cars that can be made; Pullman Tourist cars good for both first and second class passengers; easy riding Day Coaches, with Baggage, Express, and Postal cars, all drawn by powerful Baldwin locomotives, make a train fit for royalty itself.

Those seeking for new homes should take this train and go and spy out the land. To be prepared, write to

CHAS. S. FEE,
G. P. & T. A.
St. Paul, Minn.

NEW ORLEANS & CARROLLTON
ELECTRIC LINE.

MENTION has already been made in former issues of the opening of this, the first electric railway in New Orleans. An inspection of the line by a representative of the REVIEW discloses so much of interest we are constrained to give a more complete account of the system and its workings.

The New Orleans & Carrollton road lies entirely in the American quarter of the city and has its down town terminus—if the term down can appropriately be used in a city as level as a floor—where Baronne intersects Canal street, the great business artery of the city and the dividing line between the French and American districts.



THE OAKS—300 YEARS OLD.

From this point the line follows Baronne a distance of ten squares to the Lee circle which it passes on a long and symmetrically constructed reverse curve leading onto St. Charles street. This it follows to Carrollton avenue, four miles and a half, and turning northeast on Carrollton reaches the company's extensive car sheds, shops and general offices. Two branch lines leave St. Charles and run to the river over Jackson and Napoleon avenues, each about one mile long. All these lines are double track.

St. Charles street is the finest residence street in the city and 120 feet wide, with a parkway in the center occupied exclusively by the car tracks, bordered with grass plats and shaded by magnificent trees which unite in a canopy over the cars. The driveway extending to either curb is boulevarded and mansions set back from the walks and surrounded by lawns filled with magnolias, palms and beautiful flowers afford a picture to be found nowhere else in the country. St. Charles is one of the oldest streets in the city and was first improved during the war by General Butler who made it a shell road. Property has made large advances in value since the conversion of the line to electricity. The World's Fair was reached by this line, some of the buildings of which are still standing on the spot known as Audabon Park. Our illustration of the giant live oaks, 300 years old, mark this spot which was in time of yore and "honor" the favorite dueling resort. In easy walking distance is the Home of the Flowers, a beautiful floral exhibit drawing thousands of visitors. The main or Carrollton line is now operating thirty cars, and the Napoleon and Jackson

avenue lines ten each. Twenty additional cars have been ordered and are already greatly needed. The two avenue lines are also choice residence streets.

THE POWER HOUSE

is located at Napoleon avenue and the river. This site was selected on account of fuel supply and with a view to using the river water for the condensers, although the water from the river is so full of sand and grit that it is not entirely satisfactory and artesian wells have been substituted. From this latter source a supply is secured at a depth of 500 feet. The artesian water while excellent for steam and similar uses is so impregnated with sulphur as to be undesirable for drinking purposes. This station is a handsome brick structure, 85 by 125 feet, and throughout splendidly arranged and equipped. It certainly is one of the finest in the country. The boiler room is light and high, 50 by 93 feet and contains 1,100-horsepower of Babcock & Wilcox boilers in two batteries, and duplex pumps.

The stack is 125 feet high, 90 feet of the upper portion being 5-foot diameter iron stack resting on brick which reaches above the roof.

A large yard gives ample storage capacity for fuel, which is soft coal, and which does not seem to slack in that climate, even when left uncovered for a considerable time. These boilers are giving most satisfactory service

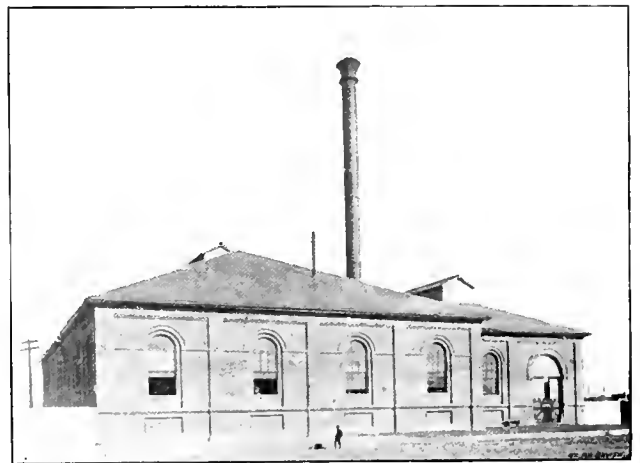

THE POWER HOUSE.

and cause no trouble in using the artesian water. The engine room is lighted with large windows on three sides, and separated from the boiler room by a heavy brick fire wall extending to the roof. Our illustration best describes the distribution of engines, main shaft and generators. The building admits of a still further increase in boiler and driving machinery and this will be added soon.

The order to equip the plant was given in one contract to the Lane & Bodley Company, of Cincinnati, to include foundations and all machinery (except electrical), and the prompt and thorough manner in which the contract was carried out has occasioned much favorable comment. The engines are three in number of 300-horse-power each. They are the Lane & Bodley tandem-compound

Corliss, each 16 and 30 inch cylinders with 48 inch stroke, with independent jet condensers placed beneath the floor. The connection to line shaft is such that any one of the three 200-kilowatt T-H generators can be driven with either engine, or two engines can drive all three generators if necessity demands.

The fly wheels are 18 feet diameter, 34 inches face and each weigh 40,000 pounds; making 70 revolutions per minute.

The shafting stands are of the design brought out by the Lane & Bodley Company last year, with self-oiling boxes constructed so that they may be removed without interference with anything on the line shaft. Aside from the artistic finish of the engines which the ample room of the plant display to good advantage, it is an interesting sight to watch two of them driving the same shaft. They take the variations in the load without any effort and run in almost perfect unison. The plant is operated with a high degree of economy, although at present, owing to the insufficiency of artesian condensing

at the center top and forming a most symmetrical and finished appearance. Track gauge is standard.

THE CARS

are from Brill and St. Louis Car Company, on McGuire and Brill trucks with Griffin wheels. They are 18-foot bodies. All the fifty cars are motors, twenty running with 15 and thirty with 25-horse-power General Electric single reduction motors. They secure full speed readily, stop easily and quickly, and attain a speed of nearly twenty miles an hour on a good portion of the line. The attractive exterior and handsome interior have attracted general attention and are highly praised by both the New Orleans public and the railway company. So well pleased are the latter a second order for twenty new cars is now being built by the St. Louis Car Company, although in this instance the McGuire truck is specified for the whole order.

THE BIG CAR SHED, SHOPS AND OFFICES

are located in Carrollton, and are all the heart could



CAR SHEDS.

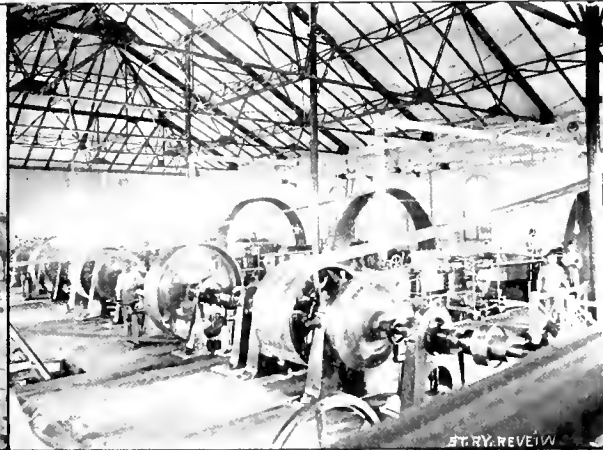

INTERIOR OF POWER HOUSE.

water, the supply for the condensers must be pumped twice.

The switch board is a very handsome affair of marble, and in addition to the usual meters and safety devices has a Johnson safe and automatic current disconnecter. The superintendent of motive power is W. N. Sheaff, a prodigious worker and a most experienced and practical expert. His thorough and painstaking work is seen everywhere, and the fact that the line has been in operation four months, including a three days' strike when the road was operated with entirely green men without the burning out of a single armature in all that time, is a no small compliment to Mr. Sheaff's ability and executive management. He is a most genial and accomplished gentleman and is making a grand success.

THE TRACKS

are 70-pound Johnson girder and 60-pound Duplex except on St. Charles avenue where the road occupies an exclusive right of way and where 50-pound T is used. Overhead construction is center pole with feeders carried

desire. The offices have just been moved from the downtown location and occupy a one-story detached building of brick, 30 by 175 feet. This allows large windows on each side its entire length, and looks out upon the shops and car shed, from which it is separated by a large yard. This latter will be set with shade trees and made attractive. Private offices handsomely furnished are assigned each of the company's officers. The safety vault is 10 by 10 feet, lined with steel. Distant three hundred feet and parallel to the offices is the shop, presided over by master mechanic F. C. Rojo, who is also quite an inventor. The shop is 175 feet long and 45 feet wide at one end, and widening to 62 feet at the rear. It is divided as shown in the plan, and equipped with wood and iron working machinery. An electric motor furnishes the power. Adjoining are the water tanks, one above the other, the larger holding ten thousand gallons, the lower five thousand, and used for drinking water. An artesian well 820 feet deep flows eighty gallons per minute. Like all wells along the gulf coast, the water is strongly impregnated with sulphur, which, however, loses its

strength on exposure to the air. Beneath the tanks is a good sized oil room. The top of the water tower is sixty feet above the ground.

Not the least interesting feature of the company's property is the immense car shed, open on the sides to a distance of 18 feet from the ground, and at the ends 30 feet. The line enters at the rear, using the shed as a loop, and entering cars can be switched onto any of the ten tracks, or again to the main line when they depart at the front. Storage is provided for 100 cars, and the inspection pit, 50 by 140 feet, has six tracks. This pit, which is four feet deep, is lined at sides and bottom with three rows of brick laid in cement, and the entire inside

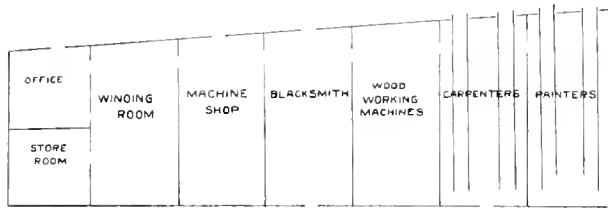

PLAN OF SHOPS.

walls and floor plastered with cement to keep out the water. Both the roof on the power house and the entire car shed were built and erected by the Berlin Iron Bridge Company, of East Berlin, Conn. The car shed, especially, is a notable piece of work, being 128 by 265 feet, constructed of steel columns supporting a truss roof covered with inch Georgia pine and corrugated iron. It is one of the neatest and most conveniently arranged car sheds we have ever seen, and although there is no fear of a snow fall to test its strength, has a sustaining strain of 40 pounds to the square inch. There is nothing in the structure which can easily burn, and altogether presents a building strong, sightly and durable. The company were greatly pleased with the prompt manner in which the structure was erected.

A president's car, of 18 foot body and vestibuled ends, is one of the finest ever built. It is resplendent with beveled plate glass, rich carpet, satin covered chairs, and elegant curtains. Nickel and inlaid woods heighten the effect. It will be used by the president to entertain distinguished guests, and occasionally chartered to select theater parties. It was built by the St. Louis Car Company.

THE long eared mule and the long legged horse, for farm work, have lost their occupation. Two Kansas city men have invented a small motor that can be hid under a man's hat, but powerful—oh, my, powerful enough to run a whole farm—shell the corn, shear the sheep, plow corn, dig potatoes, milk the cows and spank the children. Of course, it will be exhibited at the World's Fair.

THE section of the Broadway cable line between Houston and Fifth streets, was started May 6th. The last delivery of new rope was made the same day by the Roeblings, and is now in the conduit; it was 18,941 feet long and weighed 10 tons.

AN IMPORTANT DECISION.

AN important decision was rendered by Judge E. C. Billings in the United States Circuit Court, at New Orleans, on March 25. It granted an injunction against the notorious amalgamated council which inaugurated the great strike in that city last November. The strike found its beginning in a demand by the warehousemen and teamsters for more pay and shorter hours. This was refused, and the strike spread until all the labor organizations of the city were involved, including all the lines of street railway. As matters progressed the amalgamated council stated that they were willing to arbitrate on hours and wages, but that the question of "none but union men to be hired when available, from and after the final adoption of tariff and hours" to be accepted without arbitration. The challenge was also boldly made at the same time that if the demands could not be secured peaceably, force would be resorted to. That this was no idle threat was shown by subsequent events, and the entire business of the city was paralyzed, its streets and business houses left in utter darkness at night and the water works shut down. The mayor issued a call to swear in as special officers the law-abiding citizens, and the governor issued a proclamation. The strikers held out a long time, but eventually lost. In the meantime an injunction was sought in the United States court on the ground of interference with interstate commerce. This in brief brings us to the decision in question. Without citing it in full, the court stated that the fact that the immediate causes which led to the desired injunction having been removed did not alter the question of right in the least, and sums up the case in the following words:

"A difference had sprung up between the warehousemen and their employes and the principal draymen and their subordinates. With the view and purpose to compel an acquiescence on the part of the employes in the demands of the employed it was finally brought about by the employed that all union men, that is, all the members of the various labor associations, were made by their officers, clothed with authority under the various charters, to discontinue business, and one of these kinds of business was transporting goods which were being conveyed from state to state and to and from foreign countries. In some branches of business the effort was made to replace the union men by other workmen, this was resisted by the intimidation springing from vast throngs of the union men assembling in the streets, and in some instances by violence. So that the result was that by the intended effects of the doings of these defendants not a bale of goods constituting the commerce of the country could be moved. The question simply is 'do these facts establish a case within the statute?' It seems to me this question is tantamount to the question, 'Could there be a case under the statute?'

It is conceded that the labor organizations were at the outset lawful. But when lawful forces are put into unlawful channels, i. e., when lawful associations adopt and further unlawful purposes and do unlawful acts the associations themselves become unlawful.

The evil as well as the unlawfulness of the act of the defendants consist in this that, until certain demands of theirs were complied with, they endeavored to prevent and did prevent everybody from moving the commerce of the country. What is meant by restraint of trade is well defined by Chief Justice Savage in the people vs. Fisher, 14 Wendell, p. 18. He says: 'The mechanic is not obliged by law to labor for any particular price. He may say that he will not make coarse boots for less than \$1 per pair, but he has no right to say that no other mechanic shall make them for less; should the journeymen bakers refuse to work unless for enormous wages, which the master bakers could not afford to pay, and should they compel all journeymen in a city to stop work the whole

population must be without bread, so of journeymen tailors or mechanics of any description, such combinations would be productive of derangement and confusion, which certainly must be injurious to trade.

It is the successful effort of the combination of the defendants to intimidate and overawe others who were at work in conducting or carrying on the commerce of the country in which the court finds their error and their violation of the statute. One of the intended results of their combined action was the forced stagnation of all the commerce which flowed through New Orleans.

This intent and combined action are none the less unlawful because they included in their scope the paralysis of all other business within the city as well.

For these reasons I think the injunction should issue."

HALF FARES.

Interesting Facts from all Parts of the Country Boiled Down for Busy Readers.

AN electric railway, it is said, will be one of the features of travel between Dallas, Tex., and Ft. Worth within a few months. E. E. Perkins, of New York, is interested.

THE Cleveland Electric Railway Company divides its shares thus: East Cleveland Electric gets 67 per cent plus \$167,500, the Brooklyn & South Side, 33 per cent minus \$167,500.

THE Frankfort & Illion Street Railway for the first quarter of '92 shows assets of \$21,231, profit and loss surplus of \$6,946 and capital stock of \$14,275. The net earnings were \$308.62.

A SECTION boss on the Lake Shore Railroad, at Kalamazoo, Mich., undertook to cut the trolley wires on the street railway which crossed the steam tracks and received a shock which threw him from the top of a 20-foot ladder. His head struck on the rails causing death.

CONDUCTOR LEACH, on the Cottage Grove cable line of the Chicago City Railway, was standing on the foot board of an open car when the shaft of a delivery wagon pierced his side, passing almost through his body. The horse had been left unhitched and walked near the track.

THE New York L trains will wage a fierce war against cholera this summer. Sanitary inspectors will travel the lines hunting for microbes and disinfectants will be everywhere available. Quarantine stations will be established at intervals and rolling stock will be regularly cleaned and fumigated.

THE Massachusetts house of representatives always has a rapid transit microbe working at its vitals. Sometimes it's Boston common, sometimes it's storage battery. The examination before the committee brought out the fact that the storage battery had so far been too expensive for common use, even that much vaunted one at Milford. However, in the face of all this, the bill to allow storage batteries to be run over the West End tracks in Cambridge was supported.

AS AN interurban electric railway center, Norwalk, O., bids fair to become a leader. The line to Sandusky, 16 miles long, is nearly completed and other lines are being pushed, and by next fall will aggregate 50 miles, radiating in all directions. The influence on town and farm property along the lines is already felt, and prices of realty are rapidly advancing.

THE road is unusually blessed that has no history. The Little Rock, Ark., road isn't like that. It has been in history ever since it began to turn a wheel. Just at present it enjoys two receivers, the latest one being appointed by Judge McClure to assist Col. Fordyce, of St. Louis. The new receiver is Allen W. Johnson, suggested by the General Electric Company, one of the large creditors.

THE Chicago Electric Club elected officers April 20th, as follows: President, J. P. Barrett; first vice-president, F. W. Parker; second vice-president, E. Baggot, third vice-president, F. W. Cushing; fourth vice-president, Geo. Cutter; secretary, F. L. Perry; treasurer, J. W. Johnson. The club will probably have its hands full entertaining visitors this year, but we can assure out of town friends that the new regime will do it handsomely.

A HOWLING tempest of snow and sleet succeeded a very rainy week at Minneapolis, on April 20. All snow plows in the city had been filed for future references, and a blizzard with 18 inches of snow in its trail played particular hob with traffic. Manager Hield, however, did his best and opened up the more important lines in good time. The suburbanites suffered the most from the storm, but all received the inevitable with the following little "pome-?"

This weather ought to please poets
Wherever those articles grow;
For sure it's a rare combination
Of "Spring" and the "Beautiful Snow."

WORLD'S FAIR CONGRESSES.

THE world's symposiums are arranged to meet upon the following dates, to discuss the subjects noted:

- May 15—The Progress of Woman.
- May 22—The Newspapers.
- May 29—Medicine and Surgery.
- June 5—Temperance.
- June 12—Reforms—Social and Moral.
- June 19—Finance and Commerce.
- July 3—Music.
- July 10—Literature.
- July 17—Education.
- July 31—Engineering.
- Aug. 7—Government.
- Aug. 14—Horticulture.
- Aug. 21—Science.
- Aug. 28—Labor.
- Sept. 4—Religion.
- Sept. 28—Sunday Rest.
- Oct. 13—Sanitary Affairs.
- Oct. 16—Agriculture.

The street railway men will be interested in Engineering, Science, Labor, and perhaps, in municipal reform. These congresses will be held in the new Art Institute on the lake shore at the foot of Adams street.

Street Railway Review



CHARLES B. THURSTON,

President Jersey City & Bergen Railroad, Jersey City, N. J.

LAKE ROLAND'S ROAD.

ON the second day of May, about the time that Chicago men were eating late lunch, the first elevated railroad south of New York, and the third electric elevated railway in America was opened for traffic.

The personnel of the party making the first trip is as follows: At the motor, Superintendent L. N. Fredericks and William Miller, electrician; President J. L. McLane; J. P. Smith, general manager; E. Scott and S. M. Jarvis, Kansas City stockholders; R. R. Conklin, E. B. Stewart and T. B. Gamble, of the Pennsylvania railroad; also stockholders and a score of other lay brethren prominent in real estate and railway circles.

HISTORICAL.

The Lake Roland Elevated Railway is the result of the consolidation, April 16, 1892, of the North Avenue Railway Company and the Baltimore, Hampden & Lake Roland Railway Company. The former had secured a franchise for electricity along North avenue, and the B. H. & L. Railway had in sight a line north to Lake Roland. Since, a franchise to build an elevated structure.

On April 30th of the same year, the Jarvis-Conklin syndicate, of Kansas City, buying the controlling interest, made S. M. Jarvis, of Kansas City, president. It was then resolved to pursue the construction of the road to the lake and make the present beautiful park.

On June 15, 1892, the Pennsylvania Steel Company was awarded the contract for the elevation over the Baltimore & Lehigh Railroad, in all about two miles of elevated, double track.

The power-house at Stony Run is a solid building 122x56 feet in dimension, built of granite. Its foundation extends 22 feet below the surface, and is 6 feet wide at the base, tapering to 3 feet at the top. The building is fire proof, except the roof. Two tandem, compound condensing engines, of 650 horse-power each, made by the Corliss Engine Company, of Providence, will run four General Electric multipolar dynamos, with a joint capacity of 1,200 horse-power. The main crank shafts of the engines weigh 19 tons, and the fly-wheel, 15 tons. The latter is 20 feet in diameter, and runs at the rate of 70 revolutions per minute, normal. The fly-wheel has a 40-inch face.

The elevated portion used 3,500,000 pounds of steel in its construction, and the trains have roofed stations with regular stops. The cars are 21-foot body and are constructed for heavy "L" traffic.

CHAMPS ELYSEE, the beautiful French thoroughfare, will be modeled and displayed by a Parisian electric company. The miniature will be brilliantly lighted by small incandescent lamps, and a number of little automatic figures will be introduced to add local coloring. The display will be one of the prettiest in the building.

AN alderman, J. M. Kelly, of Rochester, N. Y., has invented a safety fender.

LOS ANGELES AND PASADENA ELECTRIC.

A PROMINENT Los Angeles promoter has been in Chicago for some weeks and has just completed arrangements for an electric railway line to be built between the city of Los Angeles and Pasadena. This line will take the course of what is known as the "Mission Road," in order to obtain low grades and make quick time, and it is anticipated that cars will make the run within twenty-five minutes. This line will go through Bacon Rancho upon the grade of the old Rapid Transit line. Seventy pound rail will be used throughout. It is expected that this line will also handle freight as well as passengers, and arrangements will be made with other existing lines both in Pasadena and Los Angeles for the concentration of business. The length of the entire line will be ten miles, double track. Siemens & Halske long distance transmission will be used with Westinghouse motors, the line will be equipped throughout with Pullman vestibule cars. The California Engineering Company, of Chicago, Ill., have obtained the contract for building the power station, which will comprise improved Greene engines, direct connected armatures of the Siemens & Halske type, Scotch Compound Tubular Boilers. The power station will be located near Macy street, Los Angeles, where condensing water will be obtained from the river. An elevated structure will span the flat and river leading from Main street to Mission Road. It is expected to have this line in complete running order on or before January 1st, 1894.

CONTINUOUS RAILS.

MANY a street railway man has watched with anxiety the discussion that has been going on for sometime in regard to continuous rails, and it is safe to say that many a manager would have tried the experiment long before this if an electric welder for such work had been accessible. At last it is announced that one has been constructed by the Thomson Electric Welding Company, at Lynn, for the Johnson Company. In a trial, at Lynn, it successfully welded 8½ inch girder rail joints, having 25 inches cross section. The power required was 200 horse-power for the heaviest work. The current was taken from a trolley wire of the Lynn & Boston Railroad, and transformed to the proper voltage.

ONEIDA'S EARNINGS.

ONEIDA, N. Y., makes public the following statement of its street railway operations for the quarter ending April: Gross earnings from operation, \$1,640.85; operating expenses, exclusive of taxes, \$1,220.71; net earnings from operation, \$420.14; income from other sources, \$25.00; taxes and rentals, \$166.84; net income, \$279.40.

KANSAS CITY roads show a gratifying increase in the fares.

CANADIAN NOTES.

MONTREAL'S street railway company has a rival in the Corriveau-Williams syndicate heretofore mentioned in the REVIEW. Mr. Williams was beaten by the city company in the franchise asked, and under advice of Mr. Corriveau, paid strict attention to the outlying districts and suburbs. This has been done, and an attempt to get right of way through Montreal will be made. Mr. Williams is now in New York perfecting plans for the syndicate. He expects to interest \$1,000,000. Montreal men will also take stock, and an offer will be made to the city council.

PLEASANT VALLEY'S STREET RAILWAY BRIDGE.

PITTSBURG people, Pleasant Valley passengers, patriotic Pennsylvanians, press and public passed, by representation, over the new bridge of the Pleasant Valley Traction Company, on March 2, 1893, signaling the completion of the new line to Bellevue, and its connection with the Pleasant Valley main line by the bridge which this article celebrates.

The inauguration trip was arranged by President D. F. Henry, and passed off without a marring incident.

Five cars made the first trip, and all were filled with

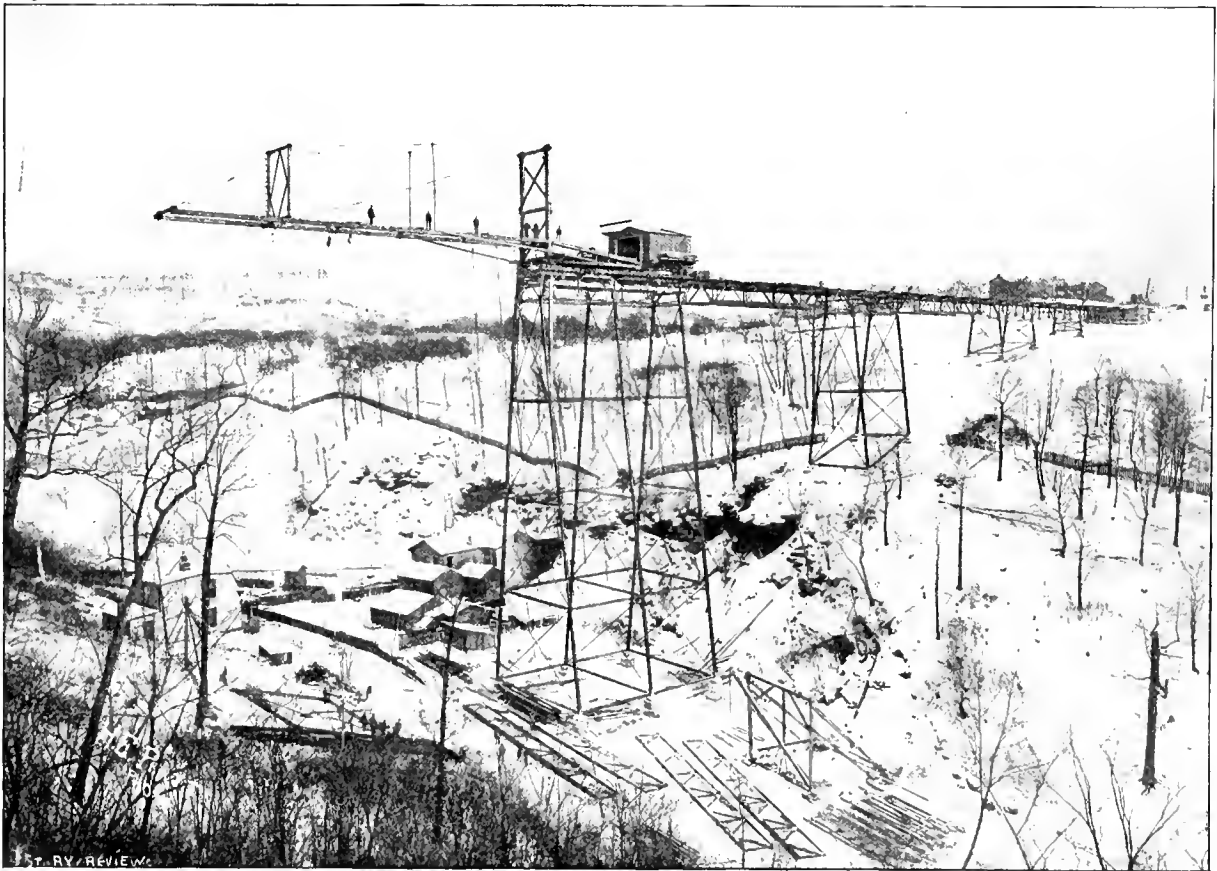

"THE TRAVELER EXTENDED OUT 115 FEET, HOISTING MATERIAL FROM THE VALLEY BELOW."

The Montreal street railway has received four cars from the Cobourg factory.

Notre Dame des Neiges has given a 20 years franchise to the Montreal Street Railway Company. The fare will be 6 cents for five years and 5 cents thereafter. This is a victory over the Corriveau-Williams syndicate.

A temporary construction power-house for the Montreal street railway is now being erected at the cost of \$30,000, to supply 1,000 horse-power until the regular plant is completed.

The Brockton Street Railway Company, of Brockton, Mass., has ordered a 600-horse-power cross compound engine from Ball, of Erie. The Quincy & Boston has also ordered a 350-horse-power tandem.

the prominent street railway men of Pittsburg, including among others Superintendent W. C. Smith, of the Central Traction Company, Superintendent Miller Elliott, of the Pittsburg & Birmingham Traction Company, R. H. King, Wm. Roseberg and F. B. Smith, Pleasant Valley stockholders, Secretary W. H. Graham and Assistant Superintendent Foster, of the company, and Chief Electrician Rummell, of the Birmingham Traction Company.

The cars were met at various points by bands, and popular demonstrations of delight, and all the motors were decorated with streamers of various colors, and large cards bearing the inscription: "High Bridge & Bellevue." All along the route mirth reigned, until the bridge was reached, when everyone looked out 167 feet below and—thought.

Fully 1,500 people cheered the advent of the car into Bellevue.

The big bridge over Jack's Run, connecting the Washington & California line of the Pleasant Valley road with the new Bellevue section, is one of the few large bridges built by street railways. It cost \$65,000. The bridge proper is 740 feet long, with approaches of over 800 feet and the roadway is 167 feet above the valley. The bases of the principal columns are 60 feet square.

The bridge is 27 feet wide over all, having 17-foot roadway and two 5-foot walks for people foolish enough to prefer foot travel.

In our engraving we show the traveler that assisted in construction, for the steel bridge was built without false work. The cost of false work would have been about

CHICAGO'S GRAND CENTRAL COMPANY.

SOME solid citizens of Chicago, incorporated as the Grand Central Railway Company, have recently proposed the most extensive system of rapid transit yet devised. The scheme comprehends both elevated and surface lines, city and suburban, in every direction from the common center, and Chicago's business area.

The men interested are: William J. Richardson, John V. Farwell, Robert Meadowcroft, Chas. J. Meadowcroft, Frank R. Meadowcroft, William Temple, Frank H. Starkweather, Andrew Petersen and Edmund Knauer, all of Chicago. Mr. Richardson is a real estate man, the Meadowcrofts, bankers at 100 Dearborn street, and John



OVER JACK'S RUN, 167 FEET ABOVE THE VALLEY.

one-fourth of the cost of the bridge proper. The reader will notice by the engraving that the road was built in midwinter. The traveler represented extended out 115 feet, hoisting iron from the valley below.

The sidewalk is cement laid and the driveway paved with asphalt. The general public as well as the press and citizens directly interested, feel the utmost thanks are due the private corporation that afforded so great a public benefit.

THE Holy Communion Church, of St. Louis, has established a reading room for street railway employes in the church parlors. The church is directly opposite the Missouri Cable Company power house. Rev. Father Robert is the originator of this commendable enterprise.

THE German official electric exhibit is in charge of Wilhelm Dohn, secretary of the chief post office of Germany. The postal telephone and telegraph service will be modeled in full.

V. Farwell is the great Chicago merchant. The capital stock is fixed at \$15,000,000.

The first road to be built will be on the North Side, and run north and west, with franchises, to city limits in various directions. One line reaches Bowmanville, Niles Center, Jefferson, Desplaines and Norwood Park to the south line of Lake county; through the counties of Lake and McHenry to a point on the boundary of Illinois and Wisconsin to Lake Geneva, Wis. Another branch, to Ravenswood, Argyle, Edgewater, Rogers Park, South Evanston, Evanston, Winnetka, Glencoe, Ravinia, Highland Park, Lake Forest to Waukegan, thence to the State line. Another branch, southerly in direction, is to extend to or near Pullman, to South Chicago, and thence to the Indiana line. Lines west will take in Cicero, River Forest, Moreland, Linden Park, Austin, Ridgeland, Oak Park and other villages.

F. R. Meadowcroft says that elevated roads in the down town districts, and on the North Side, will extend and connect with surface roads out in the suburbs.

THAT INDIANAPOLIS GAS ACCIDENT.

A VERY singular occurrence took place at Indianapolis some weeks ago which, although unlikely ever to occur again, brings up some points worthy of consideration and is besides an interesting story in itself as showing how a long chain of cause and effect will act to bring about an unexpected result. The accident has been the cause of many ludicrous statements not among the lay press, as is generally the case, but among some of our technical brethren who ought to have known better. The accident happened as follows. A leak in some way occurred between an iron center pole and the wires carried on it, either from a worn out insulator or a contact between the pole and feed wire. That this must have been the cause is manifest from what happened later. As the iron pole was set in cement, which is a tolerably good insulator and would prevent a short circuit between the overhead

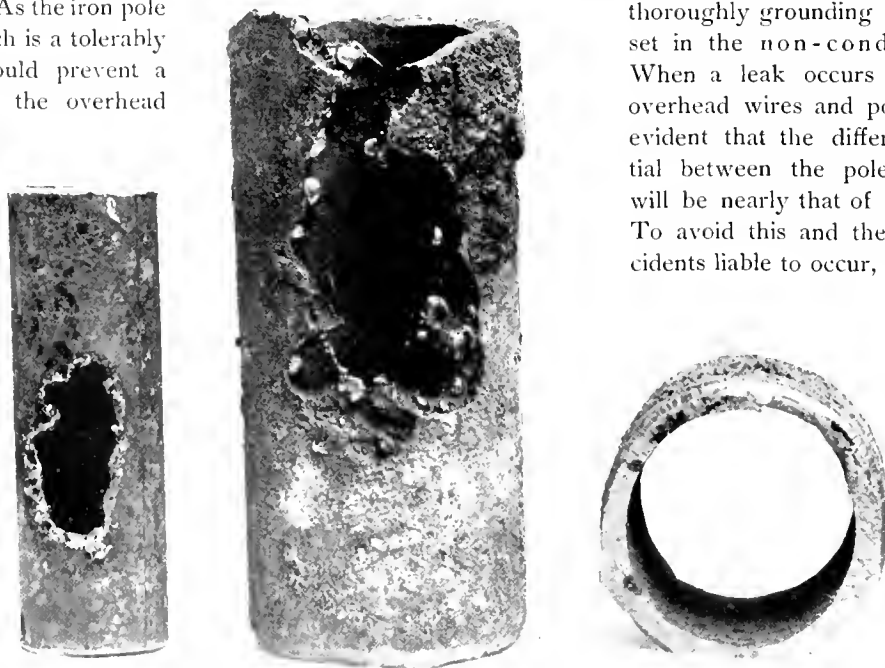

"HEAT ENOUGH WAS GENERATED TO MELT HOLES IN THE MAIN AND IN THE POLE."

lines and the ground, nothing extraordinary would have occurred had it not been that there was a slight contact between the base of the pole and an abandoned cast iron gas main. This allowed the current to leak from the pole to the gas main and in so doing (as the contact was poor) heat enough was generated to melt holes both in the main and in the pole. About three hundred feet away the old gas main crossed a natural gas pipe and as this natural gas pipe afforded an exceedingly easy path back to the power station the current took to it, and in so doing melted the pipes at the point of crossing. As soon as the natural gas pipe was punctured the gas escaped into the old artificial gas main and from there escaped to the air by means of the hollow center pole. On reaching the air it was ignited whether by a spark between the overhead lines and the pole or the heat of the melted metal at the base of the pole will never be

known. At any rate the gas caught fire and then, of course, the street in that vicinity was lighted free of charge for some time following. That the pipes were literally melted there is no doubt. Many globules of melted iron were found around the base of the pole. That this accident has nothing to do with the ground return and may be regarded as simply a freak of electricity that will probably never be repeated, will be evident to every electrician. It was simply a very peculiar result of what is technically termed a "ground" between the iron pole and the overhead line. The most striking thing about the accident was that such a "ground" should occur without sooner throwing open the circuit breaker at the station. The question of permanent interest brought up by this incident is as to whether it is advisable to provide means for thoroughly grounding iron poles when set in the non-conductor cement. When a leak occurs between the overhead wires and poles so set it is evident that the difference of potential between the pole and the earth will be nearly that of the trolley line. To avoid this and the consequent accidents liable to occur, it has been sug-

gested that the pole be connected directly to the rails. If this was done, the breaking down of an insulator would make a short circuit through the pole and the circuit breaker would immediately act. This plan would have the disadvantage that the value of the cement as an insulator would be lost. As to the better method of the two there is room for discussion.

THE Youngstown O., Street Railway, are installing a third engine, giving them a total of 750-horse-power, and are constructing an extension of three and one-half miles. Eight new motor cars are on the way.

"IS THERE anything the matter with your little boy," asked the inquisitive old lady of the young woman with a sleeping baby, on the street car. "Oh, no," was the reply, "it's simply a case of kidnapping."

PRATT PORTABLE REGISTER.

IN the illustration below is shown the improved Pratt Portable Register as manufactured by the International Register Company, 302 Dearborn street, Chicago. The various improvements recently made in this machine give it a place of high honor among portable registers. The details of the mechanism have been so perfected as to be practically indestructible and thoroughly reliable. One of the many merits of this machine is its lightness and compactness, the whole weighing but



PRATT PORTABLE REGISTER.

eighteen ounces; making it very convenient for conductors to carry during the hot summer months.

That the register is a strictly first class and reliable device is demonstrated by the large number of street railway companies that have adopted it. While on the market but a comparatively short time there are now over fifty roads using the machine; among them the West Chicago Street Railroad Company which has purchased 200 machines outright. The machines are sold outright or leased on royalty.

THE Alley L is experimenting with a high picket fence for platform protection. People still persist in crossing the tracks.

THE GENETT FACTORY.

THE accompanying illustration is a view taken from the machine room of the Genett Air Brake Company, in this city. This factory was started less than ten months ago to manufacture a limited quantity of air brakes for street railway service, but the phenomenal success of their work has compelled the management to enlarge the plant, which is being done as fast as possible. The present capacity is taxed to the utmost, the entire floor space being covered with brakes and material in course of manufacture, in order to fill the orders they have taken. Additional room has been engaged and new machinery has been ordered from the east; large orders for material have been placed and when the factory is completed to its fullest capacity it will be capable of turning out 400 brakes per month and give

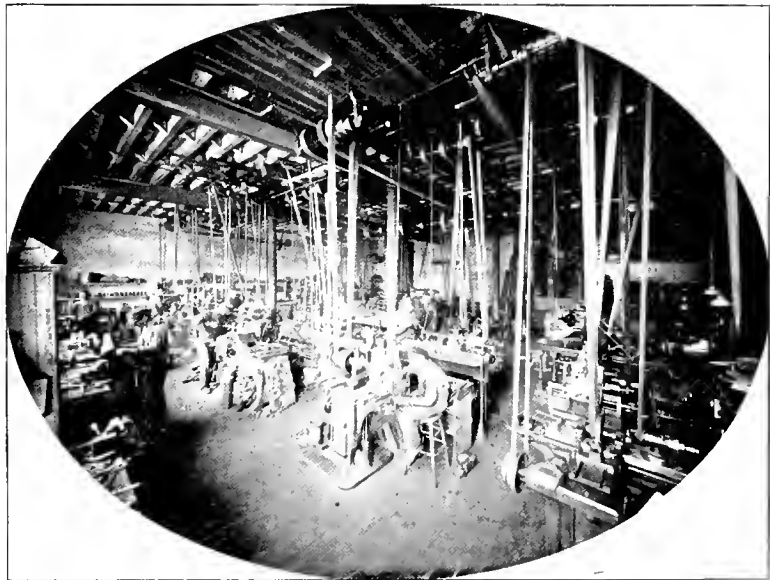

SCENE IN GENETT FACTORY.

employment to 150 men. A large force of tool makers are constantly employed on ingenious devices and tools necessary to render the different parts of their product interchangeable and to facilitate its manufacture. In the manufacture of air brakes a high degree of mechanical skill is required, in order to render the work perfectly air tight, and work must be finished to the thousandth part of an inch. It is the constant aim of the company to keep up the high standard they have established, and furnish only reliable, well made and efficient brakes, each one of them being carefully tested by competent experts on a special designed testing machine before leaving their works. The company having purchased all the patents of Genett, Moore & Rothschild, they are sole owners and control these valuable improvements in air brakes as applied to street railway cars.

The business of the company is in charge of M. L. Rothschild, general manager; W. R. McDonald, superintendent, and Jas. A. Moore, master mechanic. The New York office is at 33 Wall street, in charge of I. Neuberger.

RAILWAY "RETURN CIRCUITS."

BY J. F. E.

THE differences of opinion that exist, both in theory and practice, regarding the most efficient manner of providing for electric railways a so-called "return circuit," it would seem, are due in the majority of cases either to a too literal acceptance of the term "return circuit," or in not giving proper attention to the provision of a "return circuit" which shall operate consistently with the generally accepted theory and absolute laws, regarding electricity in general and relative potential in particular.

In order to gain a clear conception of the function of the "return circuit" of an electric railway; that its fundamental purpose is not to actually return the current to the generator, from which it emanated, after it has passed through the motors; but rather that it shall constitute an easy path, of little resistance, for the current to merely return again to the earth, its natural reservoir, and from which reservoir the generator draws electricity in varying quantities, as demanded by the motors it has to supply, the following may conduce to a clearer conception.

Current constantly seeks to establish an electrical equilibrium between connected bodies which are at different electrical potentials.

This electrical equilibrium is established by electricity flowing from the body of higher electrical potential to that of the lower potential, until the potential of both bodies is the same.

The earth, as in fact all other bodies in the universe, contains at a definite potential a static charge of electricity, which is practically infinite in quantity.

Bearing, then, the above in mind, it is obvious if a body is at a higher potential than the earth, and connected thereto, a flow of electricity will take place from that body to the earth; and conversely, if a body is at a lower potential than the earth, and similarly connected, then electricity will flow from the earth to that body, in each case until electrical equilibrium is established.

The armature of a railway generator, the negative pole of which is grounded, and the positive pole connected to the trolley wire, in operation, creates exactly these same relative differences of potentials, between its positive and negative poles and the earth: or in other words, the positive pole is at a higher potential than the earth, and current will flow from this pole to the earth, connection being made; the negative pole, being at a lower potential than the earth, current will likewise flow from the earth to the negative pole, always seeking to establish an equilibrium. But this is never obtained, for the rotating armature constantly keeps a difference of potential between these three bodies. Thus, current constantly flows from the earth to the negative pole of the generator and from the positive pole, along the connected trolley wire, through the motors, back again to its natural reservoir, the earth.

To assume that all, and the same, current, which flows from the positive pole of a railway generator, flows

directly back, through the earth, rails or "return" wires, which are in contact with the earth, until it finally reaches its original source of energy, is unreasonable and fallacious, for if this assumption were true, the law that electricity *only* flows under a difference of potential and *always* flows where there is that difference, would be nullified.

To make use of a simile, it would be just as reasonable to assume that a pump, the suction of which was in a lake of water, five miles distant from the end of the discharge pipe, which discharged into the lake again, that the same water thus discharged, found its way through the water of the lake, back again to the suction pipe of the pump; that in fact, there would be an isolated current of water, flowing through the water of the lake in a straight line between the discharge and suction of the pump.

Having then before us the true functions of the "return circuit," manifestly its efficiency depends upon the facility with which current can flow, from the earth to the generator, and from the car motor to the earth again; thus a theoretically perfect "return circuit" would consist in having each car in operation continuously connected by means of a conductor of infinite cross section to the earth, as well as having the ground connections of the generator in the station connected in the same manner.

Moist earth has a resistance very much less than dry or frozen earth. It is, most assuredly, not without some resistance, however, and as the resistance of any conductor varies inversely as its cross section, if it is considered that the moist earth, in contact with the car motor, or connections thereto, serves as a conductor for the current to establish an equilibrium between an infinite number of points, the magnitude of the cross section of which depends upon the area in actual contact with the negative pole of the car motor, or the connections therewith; obviously, the larger this area in actual contact with the earth, the less resistance it will offer to the flow of electricity, and the more efficiently will it perform its office.

Therefore, in order to construct a practical "return circuit" that is in accordance with the electrical laws bearing upon this subject, and which shall combine maximum economy in operation with minimum initial investment, the following plan, which is in the line of constructing a theoretically perfect "return circuit," as stated above, is advocated.

To an iron or copper plate, presenting a large superficial area, buried deep in the moist earth, connect, by means of heavy conductors, one pole of the generator; and as the rails of the line of the road, in the aggregate present in themselves a large area in contact with the earth, it is well to supplement the dynamo ground plate, and to make use of these rails by running branch conductors to the track.

Provide a thorough and perfect system of track

grounds throughout the entire length of the line in this manner; cross bond both rails, if a single track, and all four rails if double, with a copper wire, not smaller than No. 6, B. & S.; make connection with this bond by means of the same size wire to a plate, or any other conductor which will serve the same purpose, an old car wheel, for example, sunk well beneath the frost line and in moist earth. If circumstances will admit placing these track grounds at every rail, so much the better; in any event, they should not be further apart than five hundred feet, in which case particular attention should be given to the rail cross bonding; the latter should be placed at least every fifth rail, and care should be taken to make the joints as perfect and durable as possible.

The fact is that a wire buried in the ground, of the size commonly used for a continuous "copper return," presents, even in the aggregate, comparatively very little area in contact with the earth. If the method of providing efficient track grounds is consistently carried out, the uselessness and unnecessary expense of this "copper return" cannot but be apparent.

If the true function of a "return circuit" is clearly comprehended, that its efficiency within practical and commercial considerations is not dependent upon actually returning the current after it has passed through the motors back again to the generating station; but rather upon the facility with which it can be conducted from the motors to the earth and from the earth to the generators; if this is appreciated, the unnecessarily great expense and superfluous initial investment of erecting a copper return in the air, whether it be of a size more or less than the distributing feeders, cannot but be apparent also.

In an interesting article bearing upon this subject, recently published in the *Electrical Engineer*, in which the results of actual tests for the resistances of railway return circuits, are given, the author concludes, in comparing the relative resistance between return circuits, (one made by plain track bonding, and another by track bonding with supplemental copper return) by saying, "that the use of a continuous wire with each rail in addition to bonds, commonly recommended as best construction, is not only much more expensive, but considerably less efficient than thorough bonding alone."

ONE ON SOLOMON.

Solomon said it, or he ought to have said,
At least the idea should have entered his head,
If his mind so much could comprehend,
"To the making of railways there is no end."

THE space in the Electricity building assigned to the Detroit Electrical Works has been given to the Westinghouse Electric Company. The Westinghouse will thus be able to make a much more creditable exhibit.

COUNTY commissioners count out J. F. Wilson, et al., who wanted a street railway between Warren and Niles, O. The much talked Trumbull road has also been knocked out.

CHICAGO CITY'S ELECTRIC PLANT.

BEFORE May breezes cease, the Chicago City Railway will have in operation a part of the electrical cross-town line equipment. The Sixty-first street line is now ready for the May moving. The Sixty-first street line is about one mile long, the Forty-seventh street line two miles and two miles on Thirty-fifth street, all double track.

The power house, fronting on Wabash avenue and lying between Fifty-second and Fifty-third streets, has already one unit installed. This consists of a pair of Wheelock engines, improved pattern, with an 18-foot fly wheel weighing 5,000 pounds. The horse-power developed is 1,400, at 100 revolutions per minute and 100 pounds boiler pressure. The cylinders are 24-inch by 48-inch stroke.

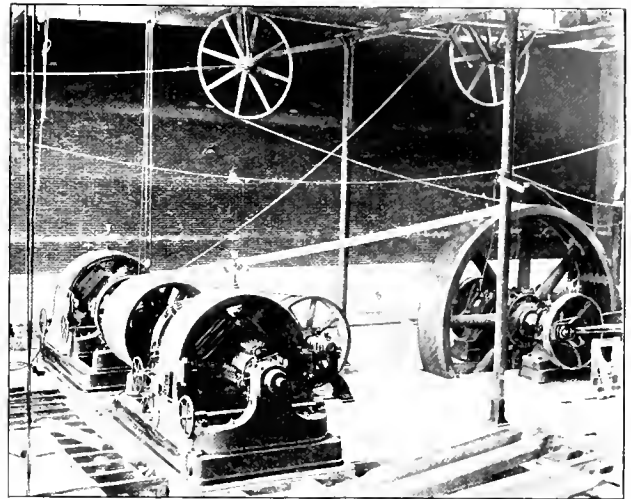

ONE ROPE DRIVE UNIT—CHICAGO CITY RAILWAY.

Each fly wheel has a 39-inch face, but is grooved for 21 wraps of 1¼ inch imported rope for the rope drive, a departure in dynamo work which will be watched with great interest. The plan of the drive is a combination of the Dodge, Hitzeroth, Williams, McDonald and Hoadley patents and known as the compound wind.

The driven pulley is of 72-inch diameter at 300 r. p. m., grooved for 32 wraps and driving in turn the two 700-horse-power Westinghouse generators so well shown. The compound multiple winder is 72 inches in diameter, grooved for 11 wraps and is seen directly behind the dynamos. Overhead the 84-inch carriage tightener may be seen. The plant will attract great attention from visiting street railway men and reflects much credit on the California Engineering Company's power plant and the Westinghouse electrical equipment. A fine switch board is placed immediately above the east door of the building.

THE Sioux City Rapid Transit Company, the elevated road, has gone into the hands of a receiver. A. M. Jackson, of Sioux City, was so appointed by Judge Gaynor under \$10,000 bonds. The King Bridge Company, of Columbus, O., is principal creditor of the \$250,000 under contract.

ALL STEEL RUNNING BOARD FOR CARS.

THE Stanwood Manufacturing Company, Chicago, have just brought out a very handsome and desirable substitute for the old time wooden running or foot board for open cars. Every manager knows the tendency of the old board step to splinter, with the consequent danger to lady passengers, while in wet weather it soon becomes covered with mud and often so slippery as to be a constant source of danger. This new Stanwood step contains no wood, being made entirely of rolled or pressed steel, of which latter material the end hangers are made. The step is a perfect self cleaner and prevents mud from being carried into the car.

The surface of the tread is slightly raised above the front frame, while the first row of the crimp strips is slightly beveled, producing a non-slipping edge. Step brackets are furnished with each step and the work of attaching to a car is very slight and simple. Openings for the wheel boxes can be made at any place desired and conform to any requirements as to distance from hangers. The step is many times stronger than wood; is practically indestructible and in point of appearance is a

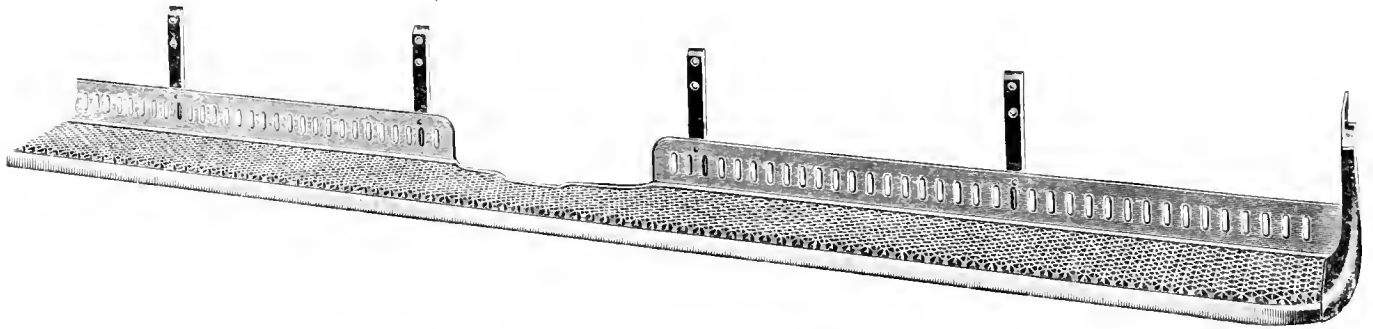

STANWOOD'S ALL STEEL RUNNING BOARD FOR OPEN CARS.

positive addition to any car. Visitors to the World's Fair will find these steps on the open car exhibited in the Transportation annex, by the Lamokin Car Company, and managers who make a trial of these steps will be almost certain to follow the same course which has marked the use of the Stanwood platform step—once used, will have no other.

PHILADELPHIA CHANGES.

THE resignation of Robert N. Carson from the presidency of the People's Passenger Railway Company has caused some surprise in traction circles. Mr. Carson is succeeded by Henry C. Moore, who is president also of the Omnibus Company General, but will resign the latter post. Mr. Carson has been for a number of years a director and one of the principal stockholders in the Passenger Railway Company, and has held the presidency since April 15, 1892, succeeding H. A. Stevenson. Mr. Moore is a native Philadelphian and 41 years of age. He has been vice-president of the Newark, N. J., Passenger Railway Company as representative of the Philadelphia Syndicate, and for two years president of the Omnibus Company General.

INDIANAPOLIS HISTORY.

IN speaking of the recent street railway complications at Indianapolis a short search into the history of the Citizens' line shows that the first street railway was established in 1864. This was on Illinois street and built by William H. English, who sold out shortly afterward to Messrs. Johnson & Dupont. These gentlemen operated the line eleven years and sold it five years ago to the Chicago syndicate represented by J. C. Shaffer. Under Mr. Shaffer's management the change to electric was made and some fifty miles of track laid. The system now embraces 15 separate lines covering 80 miles of track and employing nearly 1,000 men.

The present troubles are not considered serious by Mr. Mason, the president incumbent.

THE legal war between the General Electric and the Westinghouse companies is becoming more personal and interesting. Meanwhile the electrical fraternity look on and try to guess what the next development will be. The probabilities are that the real issue is very different from those points on which the fight is apparently being made.

VICE-PRESIDENT H. C. PAYNE, of Milwaukee, is constantly perfecting his plans for the entertainment and success of the next convention. He authorizes us to state that special facilities will be offered car builders to exhibit their cars in actual operation, and such will be kept in constant service between the leading hotels and the Exposition building. They are to be used exclusively for the guests of the Association, and will afford a splendid opportunity for display. Another interesting feature will be a visit of inspection to the magnificent works of the Allis Engine Company, and Manager Reynolds intimates that on that occasion the neighbors are not unlikely to send in a little something good to eat.

THE FULTON FOUNDRY, Cleveland, have every reason to be proud of the testimonials furnished by roads which have used their trucks. A single truck which will carry a 32-foot car at high speed and without oscillation will certainly do the same with smaller bodies. S. M. Carpenter, who is at the head of the Fulton Foundry Company, is a veteran in the manufacture of street railway supplies, and the output is the result of study and experience instead of theory only, and the ends arrived at prove both theory and practice.

American Street Railway Association.

D. F. LONGSTREET, PRESIDENT, Denver, Col.
 DR. A. EVERETT, FIRST VICE-PRESIDENT, Cleveland, O.
 JOEL HURT, SECOND VICE-PRESIDENT, Atlanta, Ga.
 W. WORTH BEAN, THIRD VICE-PRESIDENT, St. Joseph, Mich.
 WM. J. RICHARDSON, SECRETARY AND TREASURER, Brooklyn, N. Y.
 EXECUTIVE COMMITTEE—THE PRESIDENT, VICE-PRESIDENTS, and JOHN G. HOLMES, Pittsburg, Pa.; J. D. CRIMMINS, New York City; THOS. MINARY, Louisville, Kv.; JAS. R. CHAPMAN, Grand Rapids, Mich., and BENJ. E. CHARLTON-HAMILTON, Ont.
 Next meeting, Exposition Building, Milwaukee, third Wednesday in October.

Massachusetts Street Railway Association.

President, CHARLES B. PRATT, Salem; Vice-presidents, H. M. WHITNEY, Boston, AMOS F. BREED, Lynn, FRANK S. STEVENS; Secretary and Treasurer, J. H. EATON, Lawrence.
 Meets first Wednesday of each month

Ohio State Tramway Association.

President A. E. LANS, Toledo; Vice-president, W. J. KELLY, Columbus; Secretary and Treasurer, J. B. HANNA, Cleveland; Chairman Executive Committee, W. A. LYNCH, Canton, O.
 Meets at Cincinnati on the fourth Wednesday in September, 1893.

The Street Railway Association of the State of New Jersey.

President, JOHN H. BONN, Hoboken; Vice-president, THOS. C. BARR, Newark, Secretary and Treasurer, CHARLES Y. BAMFORD, Trenton; Executive Committee, OFFICERS and C. B. THURSTON, Jersey City; H. ROMAINE, Paterson; LEWIS PERBINE, JR., Trenton.

The Street Railway Association of the State of New York.

C. DENSMORE WYMAN, PRESIDENT, New York.
 D. B. HASBROUCK, FIRST VICE-PRESIDENT, New York.
 JAS. A. POWERS, SECOND VICE-PRESIDENT, Glen Falls.
 W. J. RICHARDSON, SECRETARY AND TREASURER, Brooklyn.
 EXECUTIVE COMMITTEE.—D. F. LEWIS, Brooklyn; JOHN N. BECKLEY, Rochester.
 J. W. McNAMARA, Albany.
 The next meeting will be held at Rochester, September 19, 1893.

Pennsylvania Street Railway Association.

JOHN A. COYLE, PRESIDENT, Lancaster.
 JOHN G. HOLMES, VICE PRESIDENT, Pittsburg.
 H. R. RHODES, SECOND VICE-PRESIDENT, Williamsport.
 L. B. BEIFSNEIDER, SECRETARY, Altoona.
 WM. H. LANIONS, TREASURER, York.
 Next meeting, Harrisburg, September 6, 1893.

Alabama.

MOBILE, ALA.—Wm. Agar and F. G. Gasquet, of New Orleans, sign the reorganization papers of the Mobile Street Railway Company.

Arkansas.

HOT SPRINGS, ARK.—Ed Hogaboom and J. B. Jones have gained their contract with city for street railway.

LITTLE ROCK, ARK.—Court places the street railway into the hands of S. W. Fordyce, of St. Louis. This is a victory for H. G. Allis.

California.

LOS ANGELES, CAL.—Electric Consolidated asks franchise on certain streets. Referred.

D. K. Trask, receiver of Pacific Railway, asks extensions on certain streets. Referred.

OAKLAND, CAL.—The Twenty-third Avenue Railway obtains the Meek franchise by assignment. The Twenty-third street line is subsidiary to the Haywards line.

OAKLAND, CAL.—The Alameda, Oakland & Piedmont Railway puts up \$3,000 forfeit for faithful performance. The Highland Park & Fruitvale does the same.

OAKLAND, CAL.—D. L. Smoot, J. M. Stone, A. Hemme and Vincent Young are about to build a road into Contra Costa County.

OAKLAND, CAL.—The Haywards line has made its survey and begun track laying to San Lorenzo.

OAKLAND, CAL.—It is reported that F. M. Smith has acquired the Oakland Consolidated, as prophesied by the STREET RAILWAY REVIEW.

PASADENA, CAL.—Captain John Cross, of Los Angeles, applies for street railway rights from Pasadena to Los Angeles. Two other applicants for franchise.

SAN FRANCISCO, CAL.—The Thomson-Houston file replevin suit to recover possession of electrical equipment of the San Francisco & San Mateo Electric Line.

SAN FRANCISCO, CAL.—San Francisco and San Mateo is in a stock holders' war; will be probably settled by a sale to eastern parties. Some say to the Union Trust Company.

SAN FRANCISCO, CAL.—The San Francisco & San Mateo bring suit against the Thomson-Houston and S. S. Electric to enjoin removal of machinery from power house.

SAN JOSE, CAL.—Work has begun on the University line from Mayfield to Palo Alto. J. M. Loucks and C. F. Hayne hold the franchise.

YUMA, CAL.—W. H. Carlson, of San Diego, and D. C. Reed, Yuma, president of the San Diego, Yuma & Phoenix Electric Railway Company, held enthusiastic mass meeting. Prospects good for line.

Canada

HAMILTON, ONT.—Hamilton Street Railway is allowed extensions to South Side.

MONTREAL, CAN.—Montreal Street Railway moves offices to 20 St. James Street.

OTTAWA, CAN.—The street railway people gain the franchise on Sparks street, known as the front route.

WATERLOO, ONT.—Engineers finish survey of the Galt & Preston Street Railway. Meeting of stockholders May 11. T. M. Burt, Waterloo; Thos. Todd, Galt; R. G. Cox, St. Catherines directors.

Chicago.

CHICAGO.—The Englewood & Chicago ordinance has passed the council by unanimous vote.

The North Side Elevated ordinance was introduced by Alderman Muelhofer.

CHICAGO.—South Chicago City Railway elects D. F. Cameron president and O. S. Gaither secretary and treasurer and D. M. Cummings new director.

CHICAGO.—The California Engineering Company, Monon Building, of this city, asks bids for boilers for a 900-horse-power street railway plant at New Haven, Conn.

CHICAGO.—P. H. O'Hara Air Brake Company organized at \$100,000, by Jas. Wood, P. L. Randall and H. C. Pooley.

CHICAGO.—Chicago Midland franchise passes council. Electric elevated

CHICAGO, ILL.—The Lake Street "L" increases capital stock from \$5,000,000 to \$10,000,000 and mortgages the property for \$6,500,000.

CHICAGO.—Mayor signs the Jefferson Street Railway franchise ordinance. A. H. Hill and Henry Wulff are bondsmen in \$25,000.

CHICAGO.—Organized: Chicago Electric Transit Company, Chicago; capital stock, \$1,500,000; John Casselman, Henry Wulff and Alonzo H. Hill.

Grand Central Railway Company organized by Wm. J. Richardson, John V. Farwell, Robert Meadowcroft, Chas. J. and F. R. Meadowcroft, Wm. Temple, et al, at \$15,000,000. Proposes long lines on North Side Elevated and surface, running out to Wisconsin towns, Illinois suburbs north and south. The road is said to be bona fide and independent and the men involved are all reliable business men.

Colorado.

DENVER, COL.—It is reported that Jas. H. Brown, attorney for the Tramways, has succeeded in selling control of these lines to an eastern syndicate.

DENVER, COL.—H. T. Mayham is in the East to place Westminster University Electric bonds.

LITTLETON, COL.—R. B. Archerdt, J. E. McHale, et al, are raising bonus for street railway.

Connecticut.

NEW HAVEN, CONN.—President Corey, of the State street road, says that he will equip with electricity.

Delaware.

DOVER, DEL.—The Delaware Senate passed the Brandywine Springs Electric Railway bill in mutilated shape. Two other electric bills struck snags.

WILMINGTON, DEL.—Wilmington & New Castle Electric elect president, Dr. Howard Ogle; vice-president, James B. Toman; secretary and treasurer, Harry H. Billany; solicitor, Peter L. Cooper. The stockholders' meeting will be held July 1. Subscription books will be opened in a few days.

WILMINGTON, DEL.—Dr. Howard Ogle is chief promoter of the New Castle road which will be built soon.

Florida.

TALLAHASSEE, FLA.—Council grants electric street railway rights to the company.

Georgia.

ATLANTA, GA.—Atlanta Consolidated applies for new streets and for electric rights on old routes, also extensions.

MACON, GA.—E. H. Hamlin, Chattanooga, asked to survey for a \$50,000 bridge in First street.

Idaho.

OGDEN, UTAH.—W. A. Paxton, of Omaha is said to be the capitalist backing the Power Dam Company.

SALMON CITY, IDAHO.—The Salmon City Electric Light & Water Company is organized by E. C. Johnson, president; W. F. Boxwell, Jr., Ed. Mungle and J. Egan; stocked at \$40,000.

Illinois.

AURORA, ILL.—The Aurora Street Railway Company has decided to build a line to Batavia, seven miles. Will extend to Geneva.

DECATUR, ILL.—The Street Railway Company has decided on improvements and extensions that will cost \$2,000—wire, switchboard, etc.

ELGIN, ILL.—Elgin, Fox River & Aurora Street Railway now a sure thing. All right of way secured and work will begin soon.

PEORIA, ILL.—The Peoria Heights Street Railway has been granted its franchise; Geo. C. Murray, T. J. Wasson, R. J. Cooney et al, committee of the council.

SPRINGFIELD, ILL.—The new syndicate has bought the People's Electric Railway. They now control all lines in the city.

WAUKEGAN, ILL.—The South Waukegan Electric Railway Company, Shields Township; capital stock, \$100,000; incorporators, Franklin W. Gans, Chicago, Calvin J.ickey and Bryant Y. Craig.

WAUKEGAN, ILL.—C. A. Newcomb, a wealthy Detroit man, and other real estate owners decide on a \$100,000 electric to South Side factories.

WINCHESTER, ILL.—W. & S. Hinsfather, W. Neal, et al, organize electric company at \$14,000.

Indiana.

BRAZIL, IND.—Robt. J. Smith, of Terre Haute, has been again knocked out of court, leaving the field to Van Ginkle, et al.

INDIANAPOLIS, IND.—Indianapolis-Martinsville Electric Railway incorporated at \$50,000, by Benjamin C. Stevenson, Oscar Matthews, James Stevenson, James C. Dervore, Henry A. Smock, John Hardwick, and E. F. Branch. James Stevenson, Martinsville, is president, and Elliott F. Branch, secretary. President Stevenson states that \$1,500,000 will be expended in building and equipping the road.

INDIANAPOLIS, IND.—The Citizens Railway Company announces that all existing horse lines will be changed to electric as soon as possible.

INDIANAPOLIS, IND.—Judge B. K. Elliott submitted the successful bid for the new franchise, giving 10 per cent gross for five years, 12 for the next five years, and 13½ per cent for the remaining fifteen years of the franchise. The Citizens' Company will probably litigate the matter.

INDIANAPOLIS, IND.—It is reported that R. T. McDonald, Ft. Wayne, has acquired of Verner & McKee the controlling interest in the Citizens' Street Railway plant. It is said that \$3,000,000 of bonds will be issued and the entire road and branches and extensions electrically equipped.

INDIANAPOLIS, IND.—R. T. McDonald withdraws from the fight of the Broad Ripple franchise.

LA FAYETTE, IND.—T. Levering Jones and D. Beeber, of Philadelphia, buy land for new power house 128x126 feet. Engine bought, Hamilton Corliss.

MARTINSVILLE, IND.—Martinsville Street Railway Company incorporated by Henry A. Smock, Harry Dryden, Elliott F. Branch, Minor G. Branch, Matthews and Robert H. Branch. It has a capital stock of \$25,000, and purpose operating an electric line in the town of Martinsville. The incorporators are also stockholders in the Martinsville & Indianapolis Electric Railway, which is now being constructed.

MARTINSVILLE, IND.—H. A. Smock, Oscar Matthews, and E. F. Branch are directors of the new line to Indianapolis. Survey is begun by County Surveyor Goss.

MICHIGAN CITY, IND.—Lake Cities Railway Company will probably put in a new line on Michigan street.

SHELBYVILLE, IND.—John J. Vance, of New York City, attorney for contracts, closed contracts for the Shelbyville line before August. Judge Hord, president; Edward Major, secretary, and W. Scott Ray, treasurer.

TERRE HAUTE, IND.—The Street Railway is reported sold to eastern syndicate under Russel Harrison. The new company will extend ten miles immediately.

Iowa.

BLOOMFIELD, IA.—Christian Winter, of Oskaloosa, Ia, is here in the interests of a street railway scheme. He asks \$2,000 bonus from the citizens and will put in a horse line. Winter is about the only man in the business in this very tempting section of the country.

BOONE, IA.—Boone Electric Railway & Light Company is about to issue \$45,000 six per cent mortgage bonds to build and equip light plant and railway. Solid men of Boone have subscribed liberally. President, L. W. Reynolds; secretary, J. L. Stevens; treasurer, C. E. Rice.

COUNCIL BLUFFS, IA.—Suit now begun to annul franchise of the Omaha & Council Bluffs Railway & Bridge Company.

DUBUQUE, IA.—The Dubuque Light & Traction Company, successors to the Dubuque Light & Power Company, files incorporation papers; capital, \$600,000.

STOUC CITY, IA.—Judge Gaynor appoints A. M. Jackson, Sioux City, receiver for the Sioux City Rapid Transit Company under \$10,000 bonds. Company's indebtedness is \$256,000, held mainly by the King Bridge Company, Columbus, O.

Kansas.

KANSAS CITY, KAS.—Fred Hutchings, secretary and attorney West Side Electric, sails for Europe to place \$500,000 in bonds. Ordinance has been presented asking wide grants of streets.

LEAVENWORTH, KAS.—The H. L. Erie and the Putnam interests have been consolidated. Col. Turner is president of the road, Mr Putnam, manager.

NEWTON, KAS.—Until May 4, H. H. McAdams, city clerk, will receive bids for electric lighting of city.

Kentucky.

LOUISVILLE, KY.—J. F. Gebhart, president of the Highland Electric Railway Company, has resigned. Phil Helfrich is powermaster and Geo. Tuley roadmaster.

LOUISVILLE, KY.—Power house of the Louisville Power Company totally destroyed by fire; loss, \$200,000.

Louisiana.

MONROE, LA.—The council grants electric rights to Messrs. Hawkes Bright McLain, Hudson and Knight.

NEW ORLEANS, LA.—Judah Hart franchise was sold provisionally by Comptroller Kennedy to the N. O. Traction Company by M. J. Hart. St. Charles street road files protest.

Hon. J. Hernandez, president of the Carrollton road, is dead.

Maryland.

BALTIMORE, MD.—Geo. Yakel has been chosen president of the Washington-Baltimore Boulevard Electric. H. J. Berkeley, secretary.

BALTIMORE, MD.—To cover purchase of new lines and extensions of old ones, the Baltimore Traction Company has increased its stock to \$10,000,000, double its previous capital. Large interurban extensions are to be made.

MIDDLETOWN, MD.—E. L. Miller states that northern capitalists are ready to furnish three-fourths the capital for the Middletown-Frederick Electric, and subscriptions will be taken locally for the balance.

Massachusetts.

BOSTON, MASS.—The State Street Railway Committee grants Milton Ellsworth, et al, right to incorporate as the Essex County Street Railway Company and build a road through Newburg, Ipswich and Rowley. The Boston & Lynn Railway granted rights to extend.

BROCKTON, MASS.—K. W. Mansfield has been appointed superintendent of the East Side Division.

FALL RIVER, MASS.—The people are anxious for extensions of service here, which will probably be granted by the company.

LOWELL, MASS.—The Haverhill and Groveland and Merimac Valley roads pass to the Lowell, Lawrence & Haverhill Company. Extensions will be made in several roads and streets.

MARLBORO, MASS.—Marlboro Street Railway will build extensions new power and car houses and buy cars. President E. R. Alley, S. H. Howe and J. T. Murphy, committee.

NEW BEDFORD, MASS.—Union Street Railway secures franchise in Kempton street.

NEW BEDFORD, MASS.—The Dartmouth & West Port Railway elects F. W. Brightman, Fall River, president; A. P. Smith, of New Bedford, vice; executive committee, Smith, Brightman, and R. S. Goff, Fall River, who will buy supplies. Order to be placed for eight cars; poles bought.

NORTHAMPTON, MASS.—John Olmsted, A. E. Smith and N. D. Winter, of Springfield, have bought a large interest in the Northampton Street Railway. The Northampton road will change to electric immediately.

WOONSOCKET, MASS.—Street Railway Company elects James P. Ray, Woonsocket, president; Willard Kent, secretary; Walter Whittlesev, Boston, treasurer; J. M. Klingelsmith, Chelsea, general manager.

WORCESTER, MASS.—The State Central Electric Railway granted extended rights in city, but with many crippling restrictions.

Michigan.

BAY CITY, MICH.—President McKinley, of the Consolidated, says that the street railway will be extended to Wenona, seven miles.

DETROIT, MICH.—A net bridge will be built over Conner's Creek. Supervisor Schattler. The street railway along the Gratiot road is assured.

DETROIT, MICH.—S. Hendrie, J. R. McLaughlin, E. J. Owen, et al, are prepared to push the Detroit, Rouge River & Dearborn Railway to completion. Six miles to be built this year.

Minnesota.

MINNEAPOLIS, MINN.—T. B. Walker, of the Minneapolis Land & Investment Company, is head of the company to operate and build two lines to Lake Minnetonka. This line is stated to be independent of the Minneapolis Street Railway Company.

WINONA, MINN.—Winona General Electric places \$400,000 mortgage on its property in favor of the Old Colony Trust Company.

Missouri.

FROSTBURG, MO.—J. J. Bell and Col. G. A. Pearre appeared for the Electric and gain franchise from city; road to be completed by January 1st, 1895.

JOPLIN, MO.—The Southwest Missouri Electric Railway Company, connecting Cartersville and Webb City with this place, will extend its lines to Carthage, Baxter Springs, and Kansas City. Road to be forty miles total.

KANSAS CITY, MO.—Central Traction Company chartered as a branch of the Elevated. Will build loop down town. Robt. Gillham, S. L. Conklin, W. D. McCloud, O. H. Dean and David D. Hogg, incorporators.

KANSAS CITY, MO.—Organized: Lewellyn Heights Land & Improvement Company, Kansas City, by C. V. Morrill, D. L. Haskell, Geo. S. Graham, et al.

LOUISIANA, MO.—J. O. Broadhead, Charles S. Broadhead, of St. Louis, et al, incorporate a gravel road to be leased to St. Louis parties for an electric line road bed.

PALMYRA, MO.—Citizens meet and talk electric road from Hannibal to Palmyra. Fund has been raised for preliminary survey.

RICHMOND, MO.—Richmond Electric Light Company incorporated at \$18,000, by T. N. Lavelock, Robt. Hughes, John Gibson, et al.

ST. JOSEPH, MO.—It is said that Westinghouse, Church, Kerr & Company, Chicago, are bidders for the St. Joseph road, to be sold May 16.

ST. JOSEPH, MO.—Wm. Harrison, of New York City, is the head of a \$1,700,000 company organized to buy the St. Joseph system, which will be sold at trustee's sale May 16. Good property and prospects.

ST. LOUIS, MO.—The Manchester Road Electric Railway accepts its ordinance.

ST. LOUIS, MO.—Power house fire damaged Citizens' Cable plant \$1,000.

Mississippi.

VICKSBURG, MISS.—A consolidation of the Vicksburg Street Railway & Hill City Electric Company will probably be consummated in the next two weeks.

VICKSBURG, MISS.—Electric Lighting & Transit Company files mortgage in favor of Farmers' Loan & Trust Company, of New York, to secure issue of \$200,000 bonds.

VICKSBURG, MISS.—The Vicksburg Street Railway Company and the Hill City Electric Light companies consolidated. This means an electric railway.

Nebraska.

LINCOLN, NEB.—S. E. Hostetter, Sioux City, is elected president of the Street Railway Company. Geo. K. Brown, of Lincoln, will be general manager. Improvements will be made.

OMAHA, NEB.—J. E. Markel, secretary of the Metropolitan, asks for lines into South Omaha. The company has determined to extend its N street line to Albright.

New Jersey.

JERSEY CITY, N. J.—Jersey City & Bergen re-elects board of directors and resolves upon improved service.

ORANGE, N. J.—The Orange common council grants the Suburban Railway rights for overhead system. Latest improvements required, also fenders.

RED BANK, N. J.—P. Sherwood, New York; C. T. Cobart and W. W. Conover, of Red Bank, asks right-of-way for electric line to Long Branch.

TRENTON, N. J.—The Park commissioners sign the extension petition for the electric road.

New York.

BROOKLYN, N. Y.—Franchise for the James Slip Ferry Street Railway sold to Austin Corbin for \$8,000; Houston Street Ferry to Grant street, Brooklyn, to J. C. Howard, of the Nassau Ferry Company, at \$9,000.

BROOKLYN, N. Y.—Brooklyn Bath & West End Railway Company apply for rights to use electricity instead of steam.

BUFFALO, N. Y.—Gatling, suburb, is to have the Beecher Single Rail Railway Company shops. Will make, sell and lease all kinds of motive power. C. A. Seaver and Lina Beecher, of Batavia, A. J. Hibbard, et al of Buffalo, in the scheme.

BUFFALO, N. Y.—Crosstown Street Railway Company desires to make extensions, and are trying for right of way.

GLOVERSVILLE, N. Y.—B. T. Keever assumes superintendency of the Fonda, Johnstown & Gloversville Railway, vice L. Caten, resigned.

JOHNSTOWN, N. Y.—The J. G. & K. Horse Railway elected G. C. Burr, of Gloversville, president; secretary, J. M. Russell, Johnstown.

NEW YORK CITY.—Staten Island Rapid Transit Company elect Chas. F. Mayer, Thomas Nutting, et al, for the board of directors.

Houston, West Street & Pavonia Ferry increase capital from \$1,000,000 to \$7,000,000.

NEW YORK CITY.—Petitions are before the board of aldermen to extend the Ninth avenue line.

NEW YORK CITY.—Structural iron men will be interested in the iron and steel structure contract to be awarded by the "Board of Improved ment of Park Avenue above 106th street." Address for particulars and blanks, C. W. Dayton, Room 4, 132 Park avenue, New York.

RHINECLIFF, N. Y.—Incorporated: The Rhinecliff-Rhinebeck Street Surface Railway Company, at \$30,000, by A. H. Hoffman, G. Esselstyn, E. M. Harris, W. A. Tripp, Rhinebeck; J. L. Williams, T. J. Swift, R. H. Hunter, E. A. Wilbur, Poughkeepsie; and R. M. Hoffman, Red Hook.

ROME, N. Y.—Rome City Street Railway Company complete arrangements for buying the line and elect J. S. Wardwell, president; W. P. Rayland, secretary and treasurer. No immediate prospect for electricity.

SYRACUSE, N. Y.—Syracuse Street Railroad Company organized at \$4,000,000 to unite Syracuse, Geddes and Onondaga. Board includes Edward M. Moore, of Cleveland, Ohio; Charles E. Spencer, Edwin B. Tozier, Eugene Petit, Douglas E. Petit, George J. Gannon, Peter L. Ryan, Edward S. Tefft, and George A. Roff, of Syracuse.

North Dakota.

FARGO, N. D.—C. W. Bowman, of Madison, arrived in Fargo to propose an electric street railway for this city.

Nova Scotia.

HALIFAX, N. S.—Halifax Street Railway in arrears on interest to Boston and New York men. M. Wallace appointed receiver.

Ohio.

AKRON, O.—Electric railroad interests consolidated. Capital stock of new company, \$1,000,000. Extensions to Cuyhoga Falls and Ravenna said to be assured.

CANTON, O.—Canton-Massillon Railway accepts franchise to Navarre.

CANTON, O.—Mr. Ruchti, of Dennison, O., is right-of-way agent for the extension of the Canton-Massillon to Louisville. The extension will now be made.

CINCINNATI, O.—The Mt. Adams & Eden Park Railway Company has bought the Erie avenue horse line and will electrify; price, \$10,000. It is said that Boston men will put in a line to Harrison.

CINCINNATI, O.—Cincinnati Street Railway Company will receive proposals for masonry foundations for incline in route 23 at office of B. L. Baldwin, 227 Main street.

CINCINNATI, O.—The consolidated wants franchise of certain lines extended twenty-five years. Will electrify same.

CLEVELAND, O.—O. D. Miller, the Cleveland representative of the Public Square-Euclid Heights Elevated road, is back from New York and reports favorable reception of his scheme.

CLEVELAND, O.—The Cleveland Electric Railway form executive committee of A. L. Johnson, H. A. Everett, A. E. Andrews, R. A. Harrison and C. W. Wason; capital stock, \$12,000,000.

CLEVELAND, O.—T. S. Gerhard, of Independence, asks for franchise for road between two places.

CLEVELAND, O.—St. Clair street contracts awarded by President F. DeH. Robison to extent of \$300,000. New York firms.

CLEVELAND, O.—The Storelectro Street Railway has met with fierce and unexpected opposition.

CLEVELAND, O.—Geo. Hoyt, the Storelectro Company, and L. A. Cobb want a crosstown line for storage batteries.

COLUMBUS, O.—Madisonville & Cincinnati Street Railway Company incorporated at \$100,000, to operate by any motive power, by George W. Losh, C. L. Metz, C. M. Settle, W. H. Little, James Julien and C. S. Muchmore.

DAYTON, O.—C. T. Ferneding, president street railway company, says that the Dayton Street Railway Company will largely extend and apply electricity. Storage battery proposed.

FINDLAY, O.—J. K. Tillotson and George B. Kerper have consolidated their interests here in favor of the Northwestern Ohio Electric Road.

HARRISON, O.—The street railway scheme to Cincinnati is still alive. The Boston syndicate seems earnest.

MADISONVILLE, O.—The Madisonville & Cincinnati Street Railway Company organized at \$100,000, by Geo. W. Losh, C. L. Metz, C. M. Settle, W. H. Little, Jos. Julien and C. S. Muchmore. Office of the company at Madisonville.

MARTIN'S FERRY, O.—The Wheeling Electric Railway enjoins the new Martin's Ferry line, claiming that the franchise belongs to the Wheeling Company.

MT. VERNON, O.—Road now assured and money raised for line to Gambier.

NORWALK, O.—New officers of the Norwalk & Fairfield are: President, J. A. Williamson; secretary, J. F. Laning; treasurer, F. H. Evans. Enterprise is well backed.

NORWALK, O.—T. S. Maxwell, the Cleveland capitalist, has secured right-of-way through the place for the Lakeside-Ottawa City Interurban. This is the third line in Norwalk.

NORWALK, O.—Books are now open for subscriptions to stock in the Norwalk, Fairfield & Southern Railway Company. President, John A. Williamson; secretary, J. F. Laning.

NORWALK, O.—The Sandusky, Milan & Huron gives mortgage of \$100,000 to Marine Bank, Cleveland, to secure bonds at 6 per cent.

TOLEDO, O.—Franchise will be granted to T. P. Brown, of this place, for an electric to Maumee.

TOLEDO, O.—Put-in-Bay & Southwestern organizes: Geo. B. Kerper Cincinnati, president; H. S. Sneath, Tiffin, O., treasurer; J. K. Tillotson, Put-in-Bay, vice-president; R. W. Brown, Tiffin, secretary.

YOUNGSTOWN, O.—Youngstown-Canfield road organized by J. W. Canfield, S. O. Ewing, John Delfs, Alexander Dickinson, Allen Calvin, H. M. Osborne and John Senzerbacher, all of Canfield. The capital stock will be \$65,000, and over \$10,000 has already been voluntarily subscribed outside of Youngstown.

Pennsylvania.

BEAVER FALLS, PA.—Beaver Valley Traction Company, H. P. Brown, manager, will build two miles extension this summer.

CHAMBERSBURG, PA.—It is reported that local capital will put in an electric to Fayetteville. Franchise will be applied for shortly.

HARRISBURG, PA.—Incorporated: The Sheridan Terrace Passenger Railway Company, of Chartiers township, Allegheny County, capital \$12,000. Hollywood & Grand View Passenger Railway Company, capital \$24,000.

MCKEESPORT, PA.—McKeesport-Braddock Street Railway chartered at \$50,000, by J. D. McCune, Wilksburg, A. N. Hunter, Knoxville et al.

MCKEESPORT, PA.—The car barn of the White Electric Traction Company, situated at the Duquesne end of the McKeesport-Duquesne bridge burned, destroying \$1,500 worth of property.

MONONGAHELA, PA.—H. C. Johnson, engineer, is here inspecting the electric railway right-of-way. Scheme now assured success.

NORRISTOWN, PA.—The Chestnut Hill & Norristown Railway Company applies for rights on Norristown streets, through James Rawl president; H. C. Boyer, solicitor, and Geo. Brill, of the Brill Car Company.

NORRISTOWN, PA.—The Norristown Railway Company is restrained from increasing stock by Judge Swartz.

PHILADELPHIA, PA.—Harry C. Forrest, Robt. A. Welsh, Robert Libberton, A. H. Harley, W. L. Martin, William Hill, incorporate the Delaware & Schuylkill Railway Company, of Philadelphia: capital, \$50,000.

PHILADELPHIA, PA.—The Frankfort & Southwark Passenger Railway has been arranged for electrifying Second, Third, Tenth and Eleventh streets. President Jeremiah J. Sullivan, Alex. M. Fox, Geo. S. Gandy et al. incorporators say that \$8,000,000 will be spent.

PHILADELPHIA, PA.—Samuel Hart & Sons have contract for building new power house for Philadelphia Traction Company.

READING, PA.—Reading City Passenger Railway Company has been formally transferred to the Philadelphia syndicate. The new people will equip entirely with electricity.

READING, PA.—A fight is on for possession of the City Passenger Railway. Stockholders try to prevent lease to Philadelphia Traction, and Boston want to buy.

WINTON, PA.—Mt. Vernon Street Railway Company, of Winton; capital, \$24,000; organized by John Ward, president; Thomas Langan, Thomas Redington, Patrick C. Walsh, John Fagin, John Byrne and Patrick Lally.

WESTCHESTER, PA.—J. H. Lindsay, B. Kelig, L. E. Miller and B. Witgus, Philadelphia, consult with Joseph H. Baldwin in regard to the D. & W. C. Electric Railway.

Rhode Island.

PROVIDENCE, R. I.—The Woonsocket Street Railway Company elects E. K. Ray, president, Walter Whittlesay, of Boston, as treasurer, and J. N. Klingelsmith, of Chelsea, as general manager. The latter represents Boston electrical interests, although it is understood the Rays hold and will continue to retain a controlling interest in the company.

South Carolina.

CHARLESTON, S. C.—W. P. Williams, of the Great Western Electric Company, Chicago, closes deal for the Enterprise Street Railway. Reported that New York parties have bought the other roads here.

Tennessee.

ATHENS, TENN.—It is said that the street railway here is to be reorganized.

CHATTANOOGA, TENN.—Large extensions now under way here. Considerable building to be done soon.

GALLATIN, TENN.—The Gallatin & Nashville Turnpike has been purchased by local capital and will be converted into an electric road twenty-six miles long. Horatio Berry, Geo. Seawright and Robert Graves of Hendersonville are interested. Cars are expected to run by July.

KNOXVILLE, TENN.—West End Railway changes to electricity. Contracts closed. J. C. Duncan, Knoxville, will make a road bed.

MEMPHIS, TENN.—F. S. Jones has assumed the duties of manager of the road here.

MEMPHIS, TENN.—Fire April 26 destroyed Citizens' Street Railway barns. Loss, \$50,000; insurance, \$12,000; 70 old cars burned.

NASHVILLE, TENN.—O. L. Bannard, of Continental Trust Company, of New York, buys the Nashville Electric Railway & Power Company plant for \$20,000, by order of court in the case Detroit Electrical Works vs. the Nashville Railway & Power Company.

Texas.

DALLAS, TEX.—E. E. Perkins, of New York City, announces the assurance of the electric line between Dallas and Ft. Worth. T. L. Marsalis has sold through Louchelm & Company, bankers, Philadelphia, the Dalla & Oak Cliff Belt Line, which will become part of the new system. Negotiations are begun for right-of-way.

FLORESVILLE, TEX.—Ed Goldstein has been granted rights for a street railway in this city. Scheme considered good.

FT. WORTH, TEX.—The line here will be sold to Kansas City parties and changed to electric before long.

SHERMAN, TEX.—H. C. Morrow resigns as manager of the Rapid Transit lines.

Utah.

OGDEN, UTAH.—C. E. Mayne is reported to have gained control of the Henderson-Brinker Street Railway franchise in the interests of eastern capital. The Ogden Power Dam Company is to be reorganized by this company and consolidated with the railway. Capital placed at \$250,000.

SALT LAKE CITY, UTAH.—The stockholders of the Salt Lake City Street Railroad Company re-elects old officers. A. W. McCune, president; W. P. Read, superintendent.

Washington.

SEATTLE, WASH.—Front street line and the North Seattle organization elect D. T. Denny, president; John B. Denny, vice; D. T. Denny, superintendent; A. Dunn, secretary.

room. Passengers are not allowed to leave station until their proper car arrives and as the time limit is in no case more than 10 minutes it affords a system hard to beat. These exchanged tickets are punched in quantities for each line, in the superintendent's office, and delivered in quantities of a day's supply for each line to the exchange

12 midnight	10 00	NOT GOOD FOR PASSAGE. PRESENT TO AGENT -AT- TRANSFER STATION and get check for continuous trip. This Slip Not Good Unless presented ON DATE and within time indicated.	THE TOLEDO CONSOLIDATED ST. RY. CO. LINE No. DATE 20 Conductor No.
12 30 am	10 00		
1 00 am	10 00		
1 30 am	10 00		
2 00 am	10 00		
2 30 am	10 00		
3 00 am	10 00		
3 30 am	10 00		
4 00 am	10 00		
4 30 am	10 00		
5 00 am	10 00		
5 30 am	10 00		

TOLEDO EXCHANGE TRANSFER.

clerk. He and the public cannot know in advance what form of punch will be used on any succeeding day. These books of transfers are placed in racks with brass strips over each book. These strips have sharp cutting edges, and when the exchange man issues one he tears it from

12 midnight	10 00	GOOD for this DAY 2 TRANSFER TICKET. Good for one continuous trip on any street car, if presented by conductor on date and within time indicated. Holder must take First Car that arrives and NOT LEAVE STATION while waiting for same.	THE TOLEDO CONSOLIDATED STREET RAILWAY CO. BROADWAY and LOWER SUMMIT GOOR STREET and EAST BROADWAY RONKOW & ADAMS BELT LINE WESTERN AVE. and OAK STREET FUNEST CEMETERY and UNION DEPOT IRONVILLE OHIO CENT DEPOT UNION DEPOT
1 00 am	10 00		
1 30 am	10 00		
2 00 am	10 00		
2 30 am	10 00		
3 00 am	10 00		
3 30 am	10 00		
4 00 am	10 00		
4 30 am	10 00		
5 00 am	10 00		
5 30 am	10 00		

TOLEDO TRANSFER TICKET.

the book so as to leave the desired hour and minute at the end of portion given passenger. This enables him to exchange very rapidly. The plan, however, as stated, is one of those excellent for places where the local conditions are such as in this case, to made the method available.

ENTIRELY USELESS.

The street car hog 's a curious beast,
 His case, indeed, is hard;
 He's too much hog to be a man,
 Nor hog enough for hard.

LAMP PATENT SUIT AT ST. LOUIS.

INCANDESCENT lamp matters took an unexpected turn at St. Louis, April 21. Suit was brought against the Columbia Incandescent Lamp Company, of St. Louis, asking for an injunction to close the Columbia factory. The injunction was denied by Judge Hallett. This decision was based on the want of novelty of the Edison patent, on account of the prior manufacture and use of the incandescent lamp by Goebel. The Goebel defense as made by the Beacon company was overruled in a recent similar suit made before the Circuit Court of Massachusetts, but additional evidence was brought in the St. Louis trial which fact influenced Judge Hallett's decision.

DAY'S ENDLESS CHAIN CARRIAGE.

TO avoid the necessity of terminal loops and as a substitute where loops are impossible, Augustus Day, of Detroit, has invented a device herewith illustrated. An endless chain propelled by sprocket wheels drives a flexible floor carried on stationary rollers and which has four tracks. This movable floor track may be operated from the main cable on cable roads; by

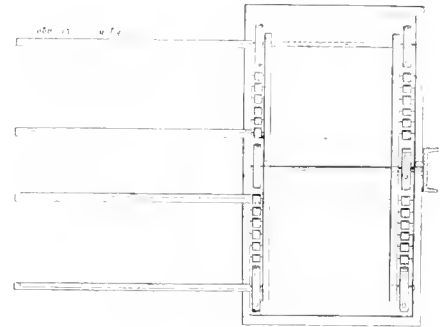

PLAN OF CARRIAGE.

a small stationary motor on electric lines and with a ratchet lever for horse roads, as it requires little power. To illustrate, the motor car is run on to the table, the carriage put in motion moving the car to a point where



CROSS SECTION AND END VIEW OF CARRIAGE.

it will run back on the other track. While it is being run off the trail car is run on and quickly moved to run behind the motor. Mr. Day states a car can be shifted in from five to ten seconds. The illustrations do not show Mr. Day's plans in complete detail but give the general principles.

The Chicago City Railway at present employs 3,820 men divided as follows: Conductors, 920; drivers, 800; depot men, 620; car repairs, 610; track, 600; engineers and firemen and helpers, 90; miscellaneous, 180.

HOT SPRINGS, ARKANSAS, VIA THE WABASH.—A few weeks now in this great health and pleasure resort may make a difference of many years in the length of your life. The Wabash Railroad is the direct line from Chicago. They sell railroad and sleeping car tickets through. Fine compartment sleepers, parlor cars and free chair cars. Write for full information. Ticket office, 201 Clark Street.

THE NEW OFFICERS OF THE INDIANAPOLIS CITIZENS' COMPANY.

PERHAPS no road in the west has been before the public as prominently as the Indianapolis Citizens' line. The full allowance of troubles that some fiend deals out to managers has been given to the Citizens', and the same number of triumphs has ignominiously routed the fiend and left the road in better condition than before. For the past few months the efforts of the McKee-Verner syndicate to gain control of the road have been noted in the REVIEW. These efforts have culminated in the acquisition of the controlling interest by the Pittsburg people, and the consequent withdrawal of the Chicago interests.



A. L. MASON.

On the fifteenth of March the new officers of the line were introduced to their respective duties. The officers are now: President, A. L. Mason; vice-president, W. L. Elder, of Indianapolis; A. A. Anderson, secretary. A. L. Boyd has assumed the superintendency, abolished under Mr. Frenzel; purchasing agent, S. F. Hazelrigg.

AUGUSTUS LYNCH MASON,

the newly elected president of the Citizens' Street Railroad Company, is about thirty-five years of age. He is by birth a Hoosier, and attended college at DePauw University, Greencastle, Indiana, graduating from there in 1879. He became a student of law in the well known office of McDonald & Butler, at Indianapolis, Indiana, of which ex-Senator Joseph E. McDonald was the senior partner. In 1882 he became junior partner in the firm, which from that time was known as McDonald, Butler & Mason. His professional work has continued uninterruptedly at the bar of Indianapolis since that time, consisting almost entirely of corporation practice. Mr. Mason's most important work was in connection with the foreclosure of mortgages and the re-organization of ten or twelve railroad properties lying in Indiana, Ohio, and Illinois. His connection with street railway matters has, however, continued for some years, acting at times as counsel of the company of which he is now president.

In Indianapolis, Mr. Mason is well known as the author of the city charter under which that municipality now exists. A reform movement started among the citizens some three years ago, and Mr. Mason was employed as attorney to draft a city charter embodying the latest theories of municipal government, which service he per-

formed, acting in connection with a citizens' committee, of which George G. Tanner, president of the Board of Trade, was chairman.

Mr. Mason is one of the most respected of the citizens of Indianapolis, and will mark his administration by firmness, justness and legality, as by these virtues he has built up his previous successes.

A. A. ANDERSON.

Associated in the toils of office with Mr. Mason is Secretary A. A. Anderson, whose business life is intimately connected with the Indianapolis street railway system since horse-car days.

Mr. Anderson began his earthly existence September 1, 1859, in the state of Missouri, but immediately after the war removed to Jacksonville, Ill., with the family, consisting of his widowed mother and three children. After a brief residence in Jacksonville the Andersons again removed, this time to Indianapolis, where they have since resided.

Mr. Anderson relates that his first street railway experience came to him at the tender age of eight years, when he was forcible removed by the conductor's foot for stealing a ride on the rear platform of one of the cars of the road with which he now is connected officially. This incident may or may not have shaped his future career, but at least we know that it made a lasting impression.

After completing a common school education, Mr. Anderson became an employe of Tom L. Johnson, in the street railway office, putting up change and counting nickels. This was in 1878. Since this time Mr. Anderson has been steadily engaged in the street railway business at Indianapolis, surviving the several changes of administration.

His thorough knowledge of the details of the business, his accurate and complete knowledge of the public mind at Indianapolis, peculiarly fit him for his position.



A. A. ANDERSON.

THE Twin Cities Rapid Transit Company's power house was the scene of a peculiar accident lately. Chas. Warren, chief clerk of General Manager Hield, was paying a visit to James Holstrom, who has charge of the switch-board in the dynamo room. James undertook to explain lighting arresters and in some way connected the circuit, blowing out the fuse in a fierce blaze. Both men were burned in a frightful manner, being denuded of hair, eyebrows and whiskers.

ECHOES FROM THE TRADE.

HOOVEN, OWENS & RENTSCHLER, of Hamilton, O., are building an addition to their present foundry. The new room is 100 by 100 feet.

THE BERLIN IRON BRIDGE COMPANY has the contract for the frame work of the new 58 by 90 foot plant of the Watts-Cambell Company.

GEO. C. EWING, formerly of the railway department of General Electric, will hereafter represent the Boston Safety Brake Shoe Company.

THE J. H. & D. LAKE COMPANY, of Massillon, O., is sending out a neat glass paper weight, showing a cut of its well known friction clutch pulley.

THE PHOENIX IRON WORKS have removed their Chicago office to room 519, the Rookery, where old and new friends and strangers may now find them.

THE MILBURN WAGON COMPANY has sold late orders of their tower wagon to the Calumet Street Railway Company, Chicago, and several for export.

THE VILTER MANUFACTURING COMPANY, of Milwaukee, has enlarged its facilities and is prepared to manufacture Corliss engines for dynamo driving.

THE SULLY MANUFACTURING COMPANY, of Allegheny, is already well crowded with work. Specimens of commutator work are shown at the World's Fair.

GEO. CUTTER has removed his office to 851-855 Rookery. The new quarters give better facilities for shipment and storage, which an increased trade demands.

THE RAILWAY REGISTER COMPANY, New York, writes us that their new clock register is successful beyond their expectation and that business is brisk in all lines.

THE PITTSBURG HOLLOWWARE COMPANY, of Allegheny, Pa., has taken new and larger quarters in Diamond street. Larger demand calls for larger facilities.

F. R. CHINNOCK, of the New York office of the Ball Engine Company, Erie, Pa., has recently closed a contract with the Virginia Hot Springs Company, Hot Springs, Va.

THE CONSOLIDATED CAR HEATING COMPANY, of Albany, has placed 270 heaters for use on the Union Railway of New York City and 95 for the Albany Railway.

THE ELLIOTT FROG & SWITCH COMPANY, of East St. Louis, are full of orders and have found it necessary to again enlarge their facilities, this time by the addition of a new erecting shop 200 by 60 feet.

THE WALKER MANUFACTURING COMPANY, of Cleveland, is doing its regular large business in every department. Walker's shops are always full of heavy work, and the spring of '93 is no exception.

THE CHAS. SCOTT SPRING COMPANY have a brush holder and trolley spring which they claim to be superior to any on the market. The late sale in these specialties have been large and the result gratifying.

WM. H. SMITH & COMPANY, agents for Roots' spiral riveted pipe and water tube steam boilers, have removed from 62 South Canal street to the first floor of the Springer building, at 197 South Canal street.

ROBERT POOLE & SON COMPANY, of Baltimore, have about finished the Baltimore City contract. Gearing and transmission machinery trade is rushing and several government contracts help to keep the work going.

THE AMERICAN CAR COMPANY, St. Louis, reports orders so large that every facility is taxed. A new erecting shop, 150 by 200 feet, and new storage sheds are being built. The present output is eight cars a day.

WESTINGHOUSE, CHURCH, KERR & COMPANY have the contract for the power house of the Newton & Boston Street Railway at Newtonville, Mass. Babcock & Wilcox boilers will be used, with a 130-pound steam pressure.

THE GENERAL ELECTRIC COMPANY has secured the temporary use of the Crescent Beach loop of the Boston & Main Railroad for the purpose of carrying out a series of experiments relative to the application of electricity to steam roads.

THE SHULTZ BELTING COMPANY, of St. Louis, reports a very large business both in street railway and manufacturing lines. The Shultz Company in one case received an order for which a competitor bid \$1,500 under the Shultz price.

THE ANSONIA ELECTRIC COMPANY's Wood's new adjustable switch has met with great success among street railways. The switch is made with adjustable tongues, which allow its use as a right, left or diamond turnout. Its construction is strong and durable.

THE LACLEDE CAR COMPANY, St. Louis, is compelled to put up a new shop 250 by 50 feet in dimension. Among recent orders are 150 cars for Philadelphia Traction, 65 opens for Minneapolis, 100 for Baltimore, 50 for Worcester, Mass., and scores of smaller lots.

THE WASHINGTON CARBON COMPANY, of Washington and Pittsburg, Pa., is doing a good business among the

street railways. Samples of used brushes show good results. The Central Electric Company, Chicago, has an exhibit of the Washington brush at the World's Fair.

HILL & WELLS, of Indianapolis, Ind., have sold the following railways one each of Hill's patent tower wagon. Field Engineering Company, New York; Brooklyn City & Newtown Railway Company; Lake Roland Elevated Railway Company; Camden Horse Railway Company.

THE PENNSYLVANIA IRON WORKS have practically completed the great Broadway & Seventh avenue. New York, contract, and are now engaged on the Sixty-fifth street power station of the Third Avenue Company. Their shops are full of work with its accompanying good feeling.

FALLS RIVET MACHINE COMPANY has equipped a large number of plants lately with their ring oiling bearings and line shafting, and clutch pulleys. One order from the General Electric Company was for equipping three plants. The new folder of the company is neat and comprehensive.

THE CUSHION CAR WHEEL COMPANY has removed from Clubroom 9 Grand Pacific Hotel, to 334 Rookery. Deacon P. F. Leach will hold services now at the latter number and keep the cushion car wheel going. Several nice large orders of late give cushioned wheels more mileage.

HARRISON & CAREY, of the Nuttall Railway Supply Company, 801-802 Monadnock Block, have been appointed agents for the Security Fare Register manufactured by St. Louis Register Company. It is claimed for this register that it is an absolute check and never gets out of repair.

THE ST. LOUIS CAR COMPANY, St. Louis, scores several large orders. The Atlantic Avenue, of Brooklyn, the Piqua, O., Street Railway, the Wilkesbarre & Wyoming Valley Traction Company, and a handsome equipment of 100 cars for the Cass Avenue & Fair Grounds are among the number.

C. E. WOODRUFF & COMPANY is the caption of a new firm established at 285 Lake street, Chicago. Andrew Shillinglaw, C. E. Woodruff, and John Figel compose the company, which will handle the western business of the Globe Rubber Company, Bradford Belting Company, and the American Circular Loom Company's wires and cables.

LEARY AUTOMATIC SWITCHES, made by Jas. F. Mann, Utica, N. Y., have been sold to the Binghamton (N. Y.) Railroad Company; Mineral Ridge & Niles (O.) Street Railway Company; Schenectady (N. Y.) Street Railway Company; Erie (Pa.) Electric Motor Company; Ottumwa (Ia.) Electric Street Railway; Weygadt Mountain Railway Company, Easton, Pa.; Freeport (Ill.) Street Railway Company.

DICTIONARY OF TECHNICAL TERMS.



AN UP TRIP.



COLLECTOR RINGS.



A CENTER BEARING RAIL.



AN AX-L.

THE NATIONAL CONDUIT COMPANY, Times Building, New York, is doing a large and increasing business. Over \$100,000 worth of its cement lined conduit is now under contract. The Buffalo, N. Y., Street Railway Company has ordered 50,000 feet, and the Philadelphia Traction Company calls for 2,300,000 feet of 2½ and 3-inch conduit. All of these contracts have been secured since January 1, 1893.

THE PHOENIX IRON WORKS have just sold the Saginaw, Mich., Power Company two 300-horse-power Dick & Church tandem compound engines. These will be each coupled direct to a 200-kilowatt generator. The Detroit River Railway has also invested in a 150-horse-power compound. They have closed contracts also for eight horizontal tubular boilers for the Allentown, Pa., Street Railway plant.

THE HEALY MOTOR, of Detroit, Mich., has now carried passengers over 200,000 miles in regular service, doing away with many objectionable features, and, it is stated, at a large economy over other forms of street car traction. The first cost and results have been so unexpectedly favorable, that a mining company in the East have contracted for a special build of this motor that will be less than four feet in height. Messrs. Dorner & Dutton, of Cleveland, Ohio, are building the frame and drivewheels for this new departure in mine motors. Experts who have examined the plans say there is not the least doubt of success, as well as a large saving of time and money.

THE WESTINGHOUSE MACHINE COMPANY have been running night and day for a year. The Philadelphia Traction Company will use eight of the Westinghouse 600-horse-power compound engines for direct coupling to multipolar generators. Besides this the six 1,000-horse-power engines for the World's Fair have helped to keep them busy.

W. F. & JOHN BARNES, of Rockford, Ill., report a large trade during the past few months. They will make a very complete exhibit of their tools at the World's Columbian Exposition and will show there one or two new tools which they have not as yet placed on the market. Their location will be in the annex of Machinery Hall, column J 36, section 14.

F. A. SCHEFFLER, who is so well and favorably known in electric light and power circles, has resigned his position as general superintendent of the Brush Company, of Cleveland, O., and has accepted the position of general sales agent of the Stirling Company, manufacturers of the Stirling water tube boiler, with office at 74 Courtlandt street, New York City.

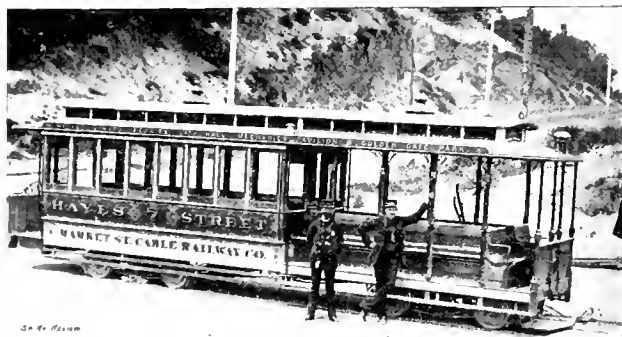

COMBINATION CABLE CAR—MARKET STREET LINE, SAN FRANCISCO.

WM. W. NUGENT, contracting and consulting engineer, has succeeded J. M. Hayes as western manager of the C. & G. Cooper Engine Company, of Mt. Vernon, O. Mr. Nugent has had a long and successful career as an engineer and contractor with the advantages of a technical education and practical work. His office will be at 823 Home Insurance building.

THE ANSONIA ELECTRIC COMPANY announces that its new Sunbeam incandescent lamp is now ready for the market and claims several advantages over other lamps for electric railway car service. The new Sunbeams are said to be adapted to hard service. The company has also the contract for the Miami Valley, O., electric railway overhead structure and reports a total of 200 miles of railway so equipped in the last three months.

THE DETROIT ELECTRICAL WORKS have furnished four direct connected multipolar generators of 15 kilowatt, 125 volts at 550 revolutions, for two new boats of the Detroit Navigation Company, and have shipped to Geo.

Beatty, Boston, one 10-horse-power and one 7½. An organ company in Detroit bought one 45 kilowatt while a number of other firms have invested in motors of from 7½ to 15-horse-power.

I. H. RANDALL, Boston, writes that there is an increasing demand for his well known motor truck, designed for 16, 18 and 20 foot box, and 8 and 10 seat opens. The truck, including motor hangers, weighs 3,500 pounds. Easy access for adjustment of brushes, and simplicity and durability are the chief claims for the truck, which is in use on the Quincy & Boston, Knoxville, Tenn., Brooklyn City and other roads.

THE NEW CASTLE CAR COMPANY, of New Castle, Pa., reports work so brisk that an addition to their shops of 100 by 40 feet of space was found necessary. The manufacturing capacity of the firm has been doubled as has also the working force. A new private switch to the Pennsylvania tracks is now laid and the best of shipping facilities thus afforded. The best of style, finish and inspection is given to every car. Large orders are now under way and more coming.

THE BALL ENGINE COMPANY, of Erie, Pa., report the following recent shipments to street railways: Alameda (Cal.) Street Railway Company, two 150-horse-power tandem compounds; Tampa (Fla.) Street Railway Company, one 200-horse-power cross compound; Niagara Falls Street Railway Company, one 130-horse-power simple engine; Everett (Wash.) Street Railway, one 150 and 200 and one 125-horse-power simple engine, besides about 2,000-horse-power in other lines of work.

THE STEPHENSON COMPANY LIMITED, of New York has just delivered to the Coney Island & Brooklyn Railroad ten 18-foot closed motors mounted on their improved truck and furnished with the improved bridge. These cars were equipped with 50-horse-power Thomson-Houston motors. Another order is ten new 16-foot cars for Forty-second Street Manhattanville & St. Nicholas Avenue Railway Company, furnished in mahogany. Ten 16-foot vestibules were also furnished to the Citizens' Rapid Transit Company, of Pittsburg.

THE Buffalo & Williamsville Electric Railway has been opened for traffic with great ceremony. The road is well built, laid with 56-pound steel rail and connects the village with the city. James Chalmers, of Buffalo, vice-president of the road, was master of ceremonies and made a happy speech on the occasion. Previous to the electric a stage line did a large business.

ED. HAAKINSON, the storage battery road owner, of Sioux City, has assigned. Among the assets were found \$90,000 in stocks of the Bradbury-Stone Storage Battery Car Company. The failure was a large one and affected Sioux City packing interests mainly. No other Sioux City railway securities were affected by this failure.

PERSONAL.

T. J. MINARY, of Louisville, Ky., was a visitor at the World's Fair grounds during April.

JOHN R. MARKLE, of the Cincinnati branch of Siemens & Halske, was an April visitor in Chicago.

JOHN LITTLE, of Hamilton, Ont., has been elected superintendent of the Windsor Electric Railway.

J. J. HAGEN has been elected secretary and treasurer of the Waterford & Cohoes Street Railway Company.

LOUIS E. ROBERTS, of the Lewis & Fowler Girder Rail Company, of Brooklyn, paid Chicago a visit in April.

JAS. H. BROWN, of Denver, Col., attorney for the Denver tramways, was a Chicago visitor during May. He had been east on business.

C. N. PARKER, president of the Brainerd, Minn., Street Railway Company has been elected also president of the Brainerd board of trade.

W. B. ALLEN, of Brownell Car Company, St. Louis, spent a few minutes with the REVIEW recently. Mr. Allen and his family will reside in Chicago this summer.

PRESIDENT DANIEL F. LEWIS, of the Brooklyn City road, has bought the property at 128 Remsen street, Brooklyn, for a home. Mr. Lewis and his bride will occupy it soon.

COL. O. M. CARTER, of Omaha, president of the Omaha & South Texas Land Company, recently paid a visit to the Houston, Tex., Electric Railway, in which he is largely interested.

PRESIDENT BARNARD of the "Alley L" road tendered a special train to members of the press on World's Fair opening day. Also another special to official representatives of foreign countries.

CHAS. F. BAKER, for many years chief engineer of the Pillsbury flouring mills, Minneapolis, has accepted the position of chief engineer for the steam plant of the West End Street Railway, Boston.

FRANCIS G. DANIELS has resigned his position as electrical engineer of the Evansville, Ind., Street Railway Company to accept a similar position on the State Street Railway, of New Haven, now equipping with electricity.

ERNEST W. HEINRICHS, of the Westinghouse Electric & Manufacturing offices, Pittsburg, called at the REVIEW office during his late visit to Chicago in the interests of the Westinghouse denomination. Mr. Heinrichs spent several days at the World's Fair grounds inspecting the magnificent Westinghouse display and taking in the opening week generally.

C. DENSMORE WYMAN, vice president, secretary and treasurer of the Central Park, North & East River Railway Company, has resigned to take the management of the Electric Launch & Navigation Company, of Chicago, mentioned elsewhere in this issue.

H. R. BELKNAP, superintendent of the operating department, has been made traffic manager of the Alley L. A. J. McBlair, formerly traffic manager, becomes superintendent of the operating department. Mr. Belknap's request is the cause of the transfer.

W. H. DOANE, Cincinnati, spent some time in Dubuque last month in the interests of his Eighth Street Motor line. E. P. Griswold and J. C. Harper, his attorneys, were also in consultation. The line is to be newly equipped and not consolidated with Allen & Swiney.

J. P. FRENZEL, ex-president of the Citizens' Street Railway Company, of Indianapolis, has recently become connected with the Indiana Trust Company, recently organized at three-quarters of a million dollars. Mr. Frenzel is also president of the Merchants' National Bank of Indianapolis.

L. M. DE LA MATER contributes to the press a most interesting account of the street car manufacturing industries in general, and a history of the Stephenson Car Company in particular. The matter is evidently of great public interest as it has been copied in every large daily on the continent.

JOHN PUGH was a recent caller at the REVIEW office. Mr. Pugh at this time informed us that he wanted a favorable review of his new book, which is about to be issued from the press, on "Why Rats Gnaw Stringers." The material is said to have been gathering for several years and to be well worth perusal.

F. S. TERRY, of the Ansonia Electric Company, was the recipient of a banquet tendered him by the heads of the various departments of the Chicago branch, April 19. The Union League club room was the place of meeting and Hon. Geo. B. Shaw presided at the table. The event was occasioned by Mr. Terry's lately promulgated information that each of his employes would receive a two weeks vacation and every Saturday afternoon for World's Fair sight seeing.

THE electric light coronas in the Manufacturers' building are brilliant examples of the skill of arc lighters. The coronas number five, and are so arranged as to give an equal display of light to all parts of the great building. A magnificent clock tower in the center of the building, beautiful booths and displays on all sides, and the brilliant rays of electric light will make Manufacturers one of the grandest sights of the century.

THE FISHKILL LANDING MACHINE COMPANY, Fishkill-on-the-Hudson, N. Y., reports an increased demand for the Fishkill Corliss engine.

COMBINATION BRAKE AND CAR CONTROLLER.

A VERY commendable effort to render more simple the duties of the motorman, and decrease the danger of straining the motors when under the care of a new or careless man, has been made by W. P. Coldren, of Lebanon, Pa., the inventor of the combination brake and switch here illustrated. The brake and controller are both operated from the same wheel, greatly

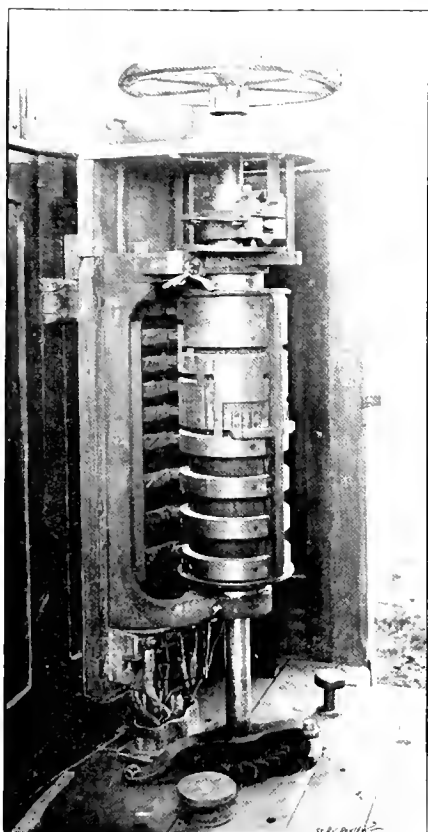

COLDREN'S COMBINATION BRAKE AND SWITCH.

simplifying the motorman's duties, and making it impossible to have the current and brakes both on at the same time. The engraving shows the controller at the position where both the current and the brakes are off. Turning the wheel one way from this position applies the brake; turning it the other way starts the car. To make it possible to reverse the motors the knob at the left of the staff is pressed. It is then necessary to turn the wheel in the opposite direction from that before to apply the brake, and vice versa. To reverse quickly when the current is on, pressing the knob and turning the wheel about seven-eighths of a turn applies reversing current. This apparatus ought to greatly simplify the motorman's duties, and should prevent many accidents both to people and motors.

THE Aurora, Ill., Street Railway has secured franchise for extension to Geneva, a distance of 9 miles. They have also purchased a 100 acre park at Mill Creek, on the Fox River, at a point about midway between the two cities and will establish a delightful pleasure resort.

STORAGE BATTERY BUCKLED.

THE end of the long and interesting chapter, of which storage battery cars in Dubuque was the subject, seems now to have been reached. A brief history of the case is as follows: In 1890 President Rhomberg visited Europe, inspected storage batteries there, and returned to replace horses with batteries. The Accumulator Company, of Philadelphia, took the contract. On May 29, 1891, the first car started. Six out of nine contracted for were finally got in operation. The event was widely heralded throughout the country. The Accumulator Company guaranteed the expense of renewal of each cell not to exceed \$2.50 per annum. The cost was found to be about \$4 per cell per sixty days, with eighty cells to a car. After running six months the railway abandoned the system and installed the overhead trolley. Collateral bonds in the amount of \$24,000, and notes for \$23,000, had been paid the Accumulator Company by the railway. The suit was on the ownership of these securities, which, with interest, amounted to \$53,000. It was a complete victory for President Rhomberg.

BIG ADDITION TO THE LAMOKIN CAR FACTORY.

THE necessity of enlarged quarters in which to carry on a business is certainly one of the best evidences of prosperity. Such a necessity has required the Lamokin Car Company, at Chester, Pa., to build a new erecting shop, 100 by 400 feet in dimensions, and a new mill 64 by 124 feet. For the month ending May 10th, General Sales Agent Pratt had sent in orders for 296 cars. The Lamokin Works are not only extensive, but are doing the bulk of the new work for Philadelphia and securing a large trade in the southwest.

OBITUARY.

GROSVENOR P. LOWREY.

The well known corporation lawyer, Grosvenor P. Lowrey, died, April 20, of an apoplectic shock, at his home in New York City. Mr. Lowrey was born at North Egremont, Mass., in 1831, and was admitted to the bar in 1854. After living for several years in Kansas, Mr. Lowrey went East, and began the brilliant career as a patent and corporation lawyer, upon which work rests his chief fame. He is best known in his connection with the Edison litigation, particularly that respecting the lamp patents. Mr. Lowrey leaves a number of brochures on professional subjects.

THE really latest newspaper railway is the one reported as fathered by Senator Jas. McMillan and Millionaire Joy for an electric between Toledo, O., and Detroit, Michigan. It is said that the capital stock will be placed at \$600,000 and passengers can be carried at \$1.50 between the two points. The present fare is \$2.50.

CHICAGO CABLES CROSS.

ONE of the engineering difficulties which perhaps more than any other call forth the skill and ingenuity of the cable engineer, is to provide a satisfactory crossing of one cable by another.

Hitherto Chicago cable railways had no crosses except those inflicted by the general public. Engineer S. Potis, of the West Chicago Street Railway Company, is, how-

way Company. By the terms of this agreement the Chicago City withdrew its opposition to the West Side loop on State and received in return the use of the West Chicago tracks on Michigan avenue for the route of their Wabash avenue and Cottage Grove cars. The Chicago City Company finished their part of the work last summer, but the much more difficult task of affecting the West Side change has not been completed until this month.

The work of construction was of the most difficult and

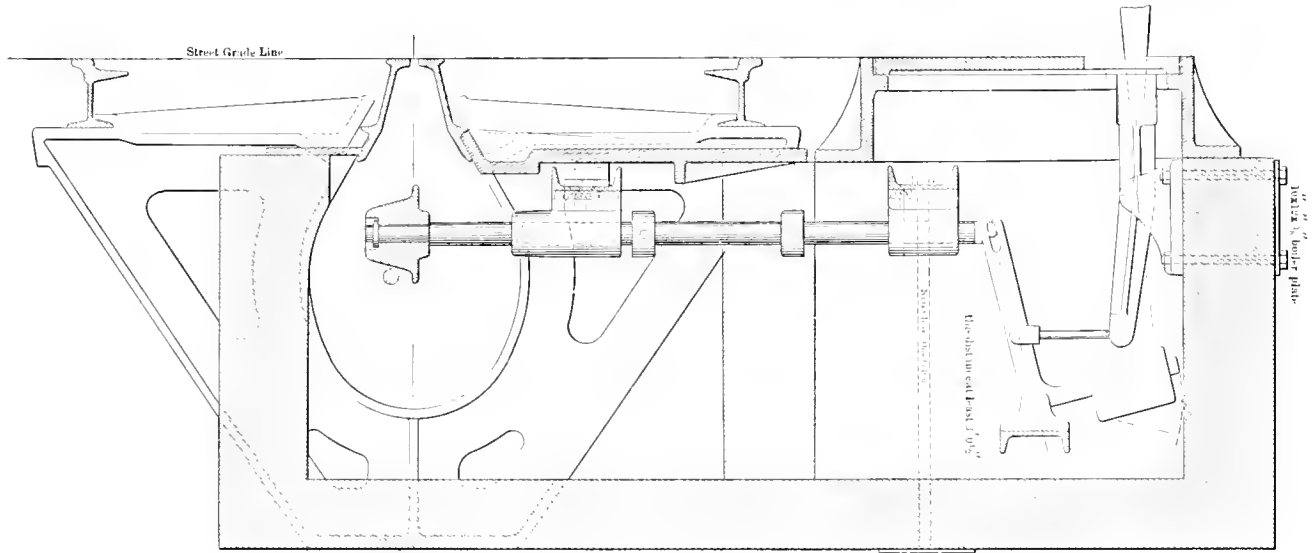

SPECIAL SAFETY DEPRESSION DEVICE—WEST CHICAGO STREET RAILROAD.

ever, the author and builder of the latest cross and first crossings, which are incident to the lately constructed West Chicago loop previously mentioned in the REVIEW.

This new loop along Fifth Avenue and Madison, State and Randolph was the one originally proposed by the West Side Company and constructed, with the exception

tedious nature, as all underground Chicago seems to have its particular nesting place under the streets required for the new work. The network of underground conduits of every description, such as telephone, telegraph, electric light, fire alarm, and police call wires, sewer connections, water pipes and gas mains, made life a particularly

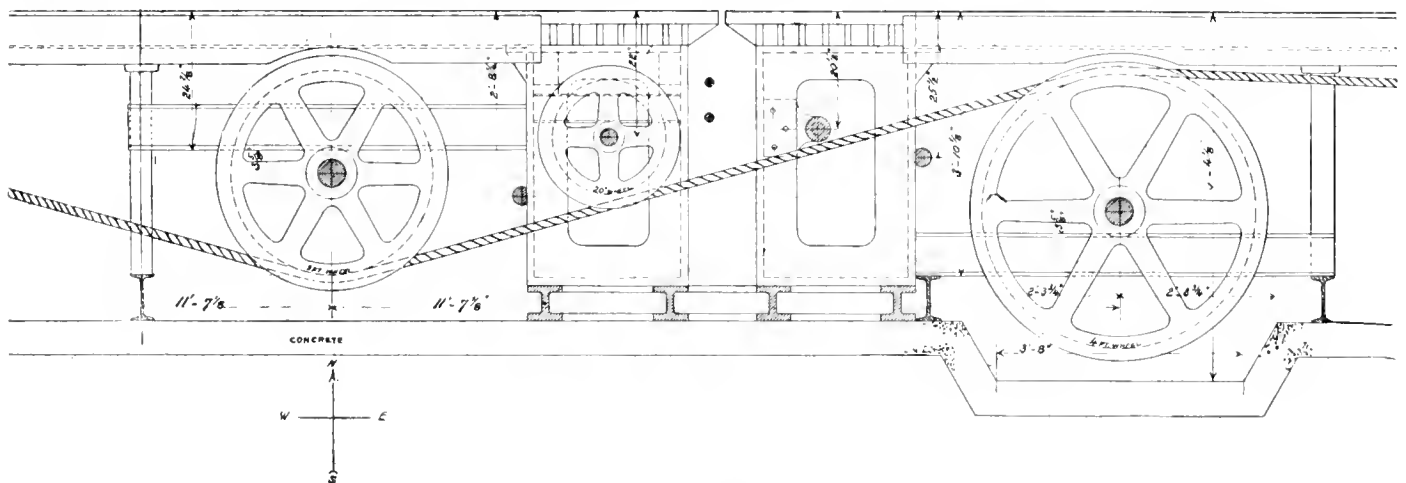

ORDINARY CABLE CROSSING—WEST CHICAGO STREET RAILROAD.

of the portion on State street, in 1889. The State street part was enjoined by the Chicago City Company and work suspended. The loop along Fifth Avenue and Madison, LaSalle and Randolph streets has been in use ever since. The completion of the new loop on State street is the result of a compromise effected last summer between the Yerkes system and the Chicago City Rail-

roadway Company. All the difficulties were met and vanquished, however, to the rejoicing of all concerned. Our engraving represents a street scene during the work.

The new West Chicago loop rope will cross the North Chicago cable at the corner of LaSalle and Madison and again at the corner of Madison and Dearborn streets,

returning by State and crossing the North Side Company's tracks again at LaSalle and Washington, besides passing the old West Side loop cable at the same intersection. The old West Side loop will be devoted to the inhabitants of Milwaukee avenue, ja wohl, while Madison street cars will utilize the new convenience.

In every case the new rope passes under the North Side cable in the manner hereinafter set forth.

The crossing as shown in the accompanying engraving is accomplished by means of three sheaves, two elevating the cable and one depressing it.

The first elevating pulley is 48 inches in diameter with a $1\frac{3}{4}$ inch groove, running on a $4\frac{1}{8}$ inch steel shafting



CURVE CONSTRUCTION, STATE AND WASHINGTON STREETS—WEST CHICAGO STREET RAILROAD.

set in a special bearing, the bore of which is of 4 inches, with a brass shell. The pulley rim is interchangeable and has wrought iron ring forming groove. The wheel itself is cast iron.

The depressing pulleys vary in size from 30 to 36 inches diameter with a $1\frac{3}{4}$ inch deep groove. The second elevating wheel which raises the cable again is like unto the first in dimension. The west rope is depressed 9 inches below the north cable, and 4 inches intervene between the parallel West Side ropes.

The momentum required by the West Side trains must enable them to clear 15 to 20 feet at the single crossing and from 30 to 40 feet at the double crossing.

The safety device protecting the rope from the carelessness of gripmen who fail to raise their grip is a "dead man" of special construction. For the benefit of the elec-

trical brethren it may be well to explain that the "dead man" is a steel shaft jutting into the conduit at the height of the rope. So placed because a broken grip is less expensive than a broken cable. The gripman who fails to release his cable runs into this deceased individual very much to the salvation of the rope and the sorrow of the driver. The dead man in this case is a steel shaft, varying from $6\frac{1}{2}$ to $4\frac{1}{2}$ inches in diameter. It projects across the conduit and under it runs the rope.

To further protect the rope a man will be stationed at each crossing ready to depress the North Side rope so that no vibration will interfere with the West Side grip then passing.

The cost of the improvement was \$120,000 in return for which greater convenience as to headway, distribution of terminal facilities and consequent increase of traffic will result.

HOT-RIVETING RAIL JOINTS.

MUCH interest was occasioned at the Cleveland convention by a statement of C. W. Wason, of the Cleveland Electric Railway, that he had laid quite a section of track with the rail joints fastened by the use of red hot rivets. This track has now been down upwards of nine months, and so far has proved very satisfactory. Mr. Wason made an examination of the joints during the winter, at a time when the thermometer had stood at not less than 8 below zero for several hours. He could discover very little change in the opening between the rail ends, and since frost has left the ground, joints do not seem to have yielded in the least. He can only come to a final decision when the other extreme has been reached, and note what effect is produced when a July sun sends the mercury sailing up around in the nineties. From all appearances, however, he sees no reason to expect a disappointment in this latter test.

NEW SHORT LINE ROAD TO DETROIT.

Wabash Officials Make a Tour of Inspection Over the Road.

E. P. Reynolds, one of the contractors for the Wabash short line to Detroit, who arrived here yesterday morning on the first passenger train that went over the new line, states it was an official inspection made by General Manager Hays and officers of the company's construction department. The train consisted of four coaches pulled by a Wabash passenger locomotive. No effort at fast running was made. The train was stopped frequently to allow the officials of the company to properly inspect the work done by the company. At times, however, the train made fifty-five miles an hour. They found the road bed and tracks in excellent condition, and everything in first class shape. Grade crossings have been avoided when possible by going overhead, and when grade crossings could not be avoided, they are provided with interlocking safety appliances. The line is particularly free from curves, and in no place does the grade exceed twenty-six feet. It is the shortest line by thirteen miles between Chicago and Detroit, the distance being 272 miles. The new line leaves the old Eel River road at Montpelier, near the Indiana state line. Among the towns it touches are Hamilton, Wolcottville, Ashley, Hillersburg, New Paris, Lakeville, North Liberty, Westville and Hammond. It is expected that the new line will be opened for business May 1.

From Chicago Tribune, April 22.

NEW PUBLICATIONS.

THE NEW ENGLAND MAGAZINE for May contains a choice menu touching both the taste of the man of the day and the mental palate of the historian and dreamer of dreams. W. H. Dowens, art critic of the Boston Transcript, contributes on the World's Fair

ROBERT POOLE & SON COMPANY, Baltimore, send out a new edition of their valuable book called "Gearing." The volume shows sizes, types and forms of their well known machine moulded gears, the reputation of which is so thoroughly established. "Gearing" is well illustrated and will be appreciated by the manufacturing and power using public.

RAILWAY SUPPLIES, a little booklet issued by Harrison & Carey, 501-502 Monadnock, shows the various types of the W. T. C. Macallen Company's solid sheet mica insulation, for which Harrison & Carey are agents. The book is nicely illustrated and will be sent gratis on application.

FACTS AND FIGURES INTERESTING TO ELECTRIC RAILROAD MEN, (third edition), is published and sent out by Charles Henry Davis, C. E., consulting and constructing engineer, 120 Broadway, N. Y., and 308 Walnut street, Philadelphia. The volume contains some 50 pages filled with wire tables, material estimates together with some street railway mileage statistics taken from the census reports. Some pretty pictures in the back of the book advertise the firm.

LIPPINCOTT'S for May has a delightful table of contents. The many admirers of Rosa Nouchette Carey will be gratified to learn that the complete novel in the May number of Lippincott's is from her facile and well-ried pen. Its title is Mrs. Romney. James Cox furnishes a full and glowing account of "New St. Louis," illustrated with cuts of a dozen of the new buildings which have lately risen in that thriving and progressive city. Professor L. M. Haupt has a brief article on "Colone Pope and Good Roads." M. Crofton, in "Men of the Day," gives a sketch of William Morris, the poet, Archbishop Satolli, and Secretary of War Lamont.

SIX THOUSAND MILES THROUGH WONDERLAND is the title of one of the most artistic and interesting little books on American travel ever issued. Starting at the Great Lakes it describes the varied and unsurpassed natural wonders which like a train of attractions border the line of the Northern Pacific Railway all the way to Puget Sound and then taking the elegant steamers of the same company stop only at the icy barriers of the frozen north. The illustrations of the Yellowstone Park and Alaska are specially fine and the book will be a welcome addition to any drawing room table. Mailed free on request to Charles S. Fee, G. P. & T. A., Northern Pacific Railroad, St. Paul, Minn.

ALTERNATING CURRENTS OF ELECTRICITY, by Gisbert Kapp; price, \$1.00; W. J. Johnson Company, Times Building, New York. It is with a decided feeling of relief that the electrician looks inside the covers of this book. Works on alternating currents have hitherto been nothing but mathematical treatises that none but the lover of mathematics or those possessed of considerable will power could wade through. "Kapp's Alternating Currents," however, is a radical departure from the established rule, and discusses the subject without the use of long unexplained formulas. Multiphase currents are deservedly given a long chapter. This popular treatise on alternating currents will undoubtedly fill a long felt want.

STREET RAILWAY MOTORS, with description and cost of plants, and operations of various systems in use or proposed for motive power on street railways, by Hermann Haupt, C. E. Two hundred 8 by 5½ inch pages give some valuable researches in this still almost untouched field. The aim of General Haupt has not been to furnish a complete treatise, but rather to give a "simple statement of principles and their application that will be readily comprehended by persons of limited scientific attainments." The subjects considered are horse, steam motor, cable, electric, compressed air, ammonia, hot water, gas and carbonic acid traction. It is not proposed to give details of mechanical construction or furnish illustrations, but rather to show results and explain principles. The book is well worth perusal, and as a matter of reference will be found particularly valuable. For sale by the STREET RAILWAY REVIEW, Price, \$1.75, postpaid.

STREET RAILWAY PATENTS.

Selected list of patents relating to Street Railway Inventions, granted during the past thirty days, reported especially for the STREET RAILWAY REVIEW, by Munn & Co., Patent Attorneys, 361 Broadway, New York, N. Y.

ISSUE OF APRIL 11, 1893.

Electric railway trolley, F. Heath, Minneapolis, Minn.....	495,035
Curve device for cable railways, J. H. Pendleton, Brooklyn, N. Y., and C. Tiers, New York, N. Y.....	495,056
Tramway, W. W. Baird, Bloomington, Ill.....	495,146
Suspended railway, B. J. Gagnier, Detroit, Mich.....	495,246
Car construction, G. W. McNear, Oakland, Cal.....	495,261
Electric street railway sweeper, J. W. Fowler and J. Hutton, Brooklyn, N. Y.....	495,321
Truck frame for street cars, H. E. Haddock, Philadelphia, Pa.....	495,326
Overhead contact and switch, C. J. Van Depoele, Lynn, Mass.....	495,383
Traveling contact for electric railways, C. J. Van Depoele, Lynn, Mass.....	495,443
Conduit electric railway, W. R. De Voe, Shreveport, La.....	495,456

ISSUE OF APRIL 18, 1893.

Cross-over switch for electric railways, F. B. Rae, Detroit, Mich.....	495,615
Life saving device or fender, W. E. Holmes, Boston, Mass.....	495,632
Rail circuit closing contact, F. von Hefner-Altenbeck, Berlin, Germany.....	495,674
Trolley wire fender, C. G. Cleminshaw and W. H. Brandt, Troy, N. Y.....	495,692
Electric railway trolley, W. Duncan, Allegheny, Pa.....	495,695
Cable grip, H. A. Shipp, Atwater, Cal.....	495,843
Safety attachment for cars, R. Bustin and T. J. McMakin, Boston, Mass.....	495,928
Elevated bicycle railway, G. F. Brott, Washington, D. C.....	495,927
Electric trolley, J. W. Kenevel, Chicago, Ill.....	495,940

ISSUE OF APRIL 25, 1893.

Street car track scraper, J. Goodfellow and H. A. Newell, New York, N. Y.....	495,968
Fender for street railway cars, L. J. Hirt, Boston, Mass.....	495,972
Car coupling (street cars) J. M. Leitch, Amesbury, Mass.....	495,981
Closed conduit for electric railways, W. P. Patton, New York, N. Y.....	495,996
Street car heater, G. Myers, Chicago, Ill.....	496,091
Street car fender, H. B. Williams, Rochester, N. Y.....	496,146
Elevated friction cable railway, L. F. Cook, Tacoma, Wash.....	496,188
Elevated railway system, L. F. Cook, Tacoma, Wash.....	496,189
Summer car, J. M. Schatz, St. Louis, Mo.....	496,232
Cable railway, J. B. Smithman, Oil City, Pa.....	496,236
Brake for elevated railways, J. N. Valley, Jersey City, N. J.....	496,237
Electric railway trolley, W. W. Pritchett, Ogden, Utah.....	496,280
Electric locomotive, C. J. Van Depoele, Lynn, Mass.....	496,330

ISSUE OF MAY 2, 1893.

Fender for cars, G. Lowe, Buffalo, N. Y.....	496,424
Grip for cable cars, D. E. Washington, Lumber, Texas.....	496,499
Elevated railway, A. C. Albertsen, Chicago, Ill.....	496,505
Double pole trolley, T. E. Adams, Cleveland, O.....	496,631
Semaphore for street railroads, L. E. Clawson, Battle Creek, Minn.....	496,639
Switch operating device, Benjamin Bartemes, Brooklyn, N. Y.....	496,715
Street railway switch, Daniel F. Doody, Brooklyn, N. Y.....	496,725

CARBONIC ACID GAS is the latest in the list of smells strong enough to propel a street car. Geo. H. Chappelle, 143 Elm street, New York City, is author and finisher of this device and declares that it will drive all other motive power off the track. He uses carbonic acid gas, compressed into liquid and gets 750 pounds pressure to the square inch when in liquid form. Heating raises it to 2,300 pounds. The engine, Mr. Chappelle declares, is a self oiler, self cleaner, automatic and powerful enough for any street car and so cheap that any one may have a street railway in his back yard.

TROLLEY traction triumphs in the case of the management of the Brooklyn Bath & West End Road.



WINDSOR & KENFIELD,

PUBLISHERS AND PROPRIETORS,

269 DEARBORN ST., - - - CHICAGO.

Published on the 15th of each month.

SUBSCRIPTION, - - - TWO DOLLARS.

FOREIGN SUBSCRIPTION, - - - 20 SHILLINGS.

Address all Communications and Remittances to THE STREET RAILWAY REVIEW
269 Dearborn Street, Chicago.H. H. WINDSOR,
Editor.F. S. KENFIELD,
Business Manager

CORRESPONDENCE.

We cordially invite correspondence on all subjects of interest to those engaged in any branch of Street Railway work, and will gratefully appreciate any marked copies of papers or news items our street railway friends may send us, pertaining either to companies or officers. Address:

THE STREET RAILWAY REVIEW,
269 Dearborn Street, Chicago.

Entered at the Post Office at Chicago as Second Class Matter.

This paper member Chicago Publishers' Association.

VOL. 3.

JUNE 15, 1893.

NO. 6

THE courts in Oregon have ruled that cities and towns cannot grant exclusive franchises to street railway companies without first having secured special authority from the state legislature so to do.

ACCORDING to a recent ruling of the supreme court in Nebraska, companies operating under franchises received from a city which latter had in turn been empowered by legislature to fix the rates of fare; must keep its conductors at all times supplied with tickets to sell passengers, where tickets are sold in quantity at a less rate per ride than is charged for the single cash fare ride.

CONSIDERABLE stir has been made over the construction of an electric railway into the Gettysburg battle field. Such a line certainly would enable thousands to visit the grounds where hundreds do now, and while there should be no such defacement of the present contour of the field as to radically change the old landmarks we believe the line can be built without inflicting any material damage.

A practical illustration of the direct advantages of inter-urban electric lines is afforded in the statement of nineteen months' business of a road in Massachusetts. The saving to passengers in fares paid the electric as against what would have been paid the coach company under the old method was \$44,468. This does not take into consideration the thousands of dollars saved in time, which is worth fully as much more.

THOSE persons who have been waiting to come to Chicago until the Fair should be "ready," have certainly now no object in longer delaying their visit. Nearly all the exhibits are now in place, and the building least complete contains more than one can intelligently see in a week. We can assure our readers they will not be disappointed in any department, and that they cannot now come too soon or remain too long.

THE Minnesota courts have decided that even a street railway company has no authority to permit a house-mover to blockade its tracks to the serious inconvenience of the public where city ordinance declares that the tracks must not be obstructed. That while the ordinance is of great value to the street railway it was passed primarily in behalf of the traveling public, whose rights the company as well as others are bound to respect.

AFTER spending \$115,922, and nearly three years of more or less valuable time, four of the five members of the Rapid Transit Commission of New York have resigned. To all appearances rapid transit would be just as far advanced if the commission had resigned before they were appointed. In the meantime Broadway has been cabled, and some real first class rapid transit, without any commission, has been placed on tap.

THE liberal action of the Minneapolis park board, which has allowed the Twin Cities Railway Company wide latitude in introducing concerts, boats, and amusement facilities at Lake Harriet, should be followed in other cities. The board lacks the necessary funds to equip the lake properly, while the railway is willing to do so on a large scale, and in return is allowed to charge a reasonable rental for the boats, and an admission fee for reserved seats at the band concerts. In this way the public are served with a large amount of entertainment which costs them nothing.

THE Department of State, in its June report from consulates, publishes among other statements, one from Buda Pesth, in which the cost of the underground system of the Siemens-Halske Company, including rails, paving, masonry, and all other materials, is given as \$2.880 per mile of single track. There is not so much wonder that the daily press, or even the Department, should have allowed the error to have passed unnoticed, but it seems strange that several technical journals accepted the figures without question. As a matter of fact, the single item of either rails or paving would equal the amount quoted as the cost of the entire construction, which was fully ten times the figures named above.

ANOTHER grade crossing accident in Chicago. Fortunately the small number of passengers in the car—six—limited the disaster somewhat, but one lady was instantly killed and her body so mutilated as to be unrecognizable, and three others seriously injured. As usual it was a car drawn by horses, which the daily press of

some cities still hold up to us as so much safer than an electric or cable car; notwithstanding that statement of the wisest of men that a horse is a vain thing for safety. Had the wrecked car been propelled by electricity for instance, the driver could have crowded on sufficient power to have cleared the space, instead of struggling with a team of frightened horses which terror had almost robbed of strength; nor would he now be lying in a hospital with bruised body and broken bones. This crossing is one of that class on which we commented last month as dangerous and which ought under no circumstances to be crossed at grade. The legislators in Massachusetts, however, who are seeking to discriminate against the crossing of one or two steam tracks by electric lines in unfrequented places, and basing their action on an increased danger of electric cars over the old horse cars on such crossings, will not find much to bear out their claims in the unfortunate disaster mentioned.

AMERICANS who live in cities are too fond of riding in street cars," comments an eastern daily, and thereupon proceeds to demonstrate that most of the ills which afflict modern man and woman are due to the street car riding habit. This is emphasized by the statement that one and a quarter million passengers are the daily average business of the surface and elevated roads in New York City alone. Short riding particularly comes in for special censure, and the "loss of appetite," "active circulation of the blood," and "strengthening of the muscles" which the rider would have received had he traveled as did his great forefathers, is greatly lamented. The busy business man of to-day is not in business for his health. To him minutes have an actual monetary value which he can figure out to a cent, and he rides not so much to save his strength as to save his time. For the laborer who has been laying bricks all day in a hot sun, or the shop girl serving time behind a bargain counter, or the clerk in bank and office, that "strengthening of the muscles" process to be derived from a four or five mile walk home after 6 o'clock does not present the rosy hue that exists in the eyes of the theorist. Modern city life has unfortunately increased the number of those who must labor indoors, and greatly restricted the hours and opportunity for living in fresh, pure air. But right here the mechanically operated street car steps in, and by greater speed reduces the time formerly required in travel, and not only increases by an hour or more per day the time which the worker may spend at home, but provides inviting carriages which, for a very small charge, afford a long ride to parks and inviting breathing places. The moral and sanitary advantages which the improved systems of street car transportation have brought to the great mass of working people is neither fully appreciated nor realized. The undisturbed conditions under which the early Knickerbockers strolled about their shady gardens and farms 200 years ago are very different to a plunge into the teeming arteries of trade, where excitement fills the air, while the pedestrian is carried along hard stone walks under a broiling sun. Short riding is

heaviest in business districts, and in such we fail to see how the walking habit is greatly to "prolong life, lessen doctors' bills, and render people more happy and contented."

THE action of the United States court in closing the gates of the World's Fair on Sunday is little less than a public calamity. It is a significant fact that with the exception of a feeble minority, those who have been most urgent in demanding the Sunday closing are people who have not yet seen the Exposition, and as they will be convinced when they do come, are not now in a position to judge the question in any spirit of fairness. Of our personal knowledge we know not of a few cases where visitors who are very strict in their observance of their religious convictions, who when they had been here a few days and began to realize the beauty and majesty of the fair, became as pronounced in their expression that it would be as great a sin to shut the gates on Sunday as they previously believed it harmful to open them. The press of the city, the business and professional men, a very large proportion of our largest churches and the influential clergy unite with the great army of workers in the demand for open gates. The most urgent objectionists are a few narrow-minded bigots and the combined strength of the gamblers, the saloonkeepers, and those who are operating resorts of the lowest and most pernicious character. The closed gates of the Fair cannot but divert thousands into these gates of hell, as has already been demonstrated, and result in the accomplishment of more evil than the misguided moral objectors can undo in years, if ever. The closing of the World's Fair on Sunday is a national calamity.

A GREAT deal has been said and a very erroneous impression gained as to the extortionate charges levied on visitors to Chicago and the exposition. This has been partly due to the determined and overzealous stand taken by the Chicago press in showing up and denouncing extortion wherever attempted, and the result has been a general correction of abuses where such existed. While of course in a great city like Chicago there are always costly accommodations for which patrons may go as high as the most extravagant may desire, it is but fair to state that such accommodations and prices exist throughout the year and cut no figure whatever with the great mass of the traveling public. Our accommodations are more than ample, and the erection of new hotels has been carried to such an unwarranted extent that their very number has solved the question of rates in the consequent competition. The thousands of private residences which have offered desirable rooming facilities has had a beneficial effect on room-rates, and the restaurants have made no effort to elevate prices. Not a few of our callers at this office have expressed great surprise at the reasonable charges which are being made, and the satisfactory quality of entertainment received. It is a further item of information that for private rooms and restaurant board the cost for parties of two is but slightly in excess of what is usually charged for one, and as a well known street

railway man who is here with his wife remarked to us the other day, "It is cheaper than living at home and we shall remain three weeks instead of one as we intended."

THE famous litigation in the case of the Los Angeles cable road reached a decision, though by no means a final one, on May 11th, being handed down by Judges Wade and VanDyke sitting in joint session.

The Los Angeles Cable Railway Company was organized under the California laws, on July 13, 1887, and the company proceeded to cable several horse lines which it had absorbed. When the new construction was well under way the cable company found itself unable to complete the road and in January of 1889 the property was purchased by eastern capitalists, mostly of Chicago, with C. B. Holmes as president.

After purchasing the road it was discovered that the peculiar laws of California, unlike those of other states, makes a stockholder forever liable for his pro rata of debts incurred by a company during the time he is a stockholder of record thereof. Hence a new corporation was formed August 22, 1889, under the laws of Illinois, and entitled the Pacific Railway Company. The stockholders of the \$2,500,000 of Los Angeles cable stock exchanged it for an equal amount of Pacific Railway, between the dates of September 1 and December 20, 1889. On April, 1890, the road was turned over to a representative of the Pacific Railway and on the next day the new company entered into possession of the property, retaining it until placed in a receiver's hands which was on February 20, 1891.

While the company's rights and property are attacked from various directions, the litigation clusters largely around a suit brought by the Northwestern National Bank, for the recovery of \$100,000, which that institution loaned the old Los Angeles Company in June, 1889, taking its pay in a note given by the Pacific Railway under date of October 16, 1890. When this note came due it was extended on July 21st, 1890, and the non-payment of this note occasioned suit to determine the responsibilities of the stockholders.

The court rules that the organization of the Pacific Railway Company was illegal, and that the Los Angeles Cable Railway Company is still in existence. That the acts of the Pacific Railway were illegal and void as are also the transactions founded upon the same. The loss to the Chicago stockholders is over \$2,000,000. The road has been ordered sold.

THE citizens of Detroit and the Detroit Citizen's Street Railway are deserving of great sympathy; the municipal government of that city of the highest censure. Detroit plodded along for years with the street railway service of an overgrown country town. At last eastern capital was interested in its behalf and the old Detroit City and several smaller lines were sold to the new syndicate—the Citizens'. The chief factor in the sale was an extension of thirty years which the old

road secured about two years before its corporate existence expired. Acting in perfect good faith the new company was allowed to enter into possession and to invest a large amount of money. Then began a systematic warfare on their new benefactors, and every possible effort, in which Mayor Pingree specially distinguished himself, was made to hamper and cripple the new enterprise. A crisis was finally reached May 29 last, when the United States Court handed down a most remarkable decision, Judge Swan dissenting, in which it was declared the new company ceased to hold operative title to all but two minor lines, on May 9, 1893, which was the date of expiration of the state charter of the old Detroit City Railway. The mayor and city authorities indulged in a ghost dance of ghoulish glee over the victory (!) and proceeded to give the thumb screws another twist by offering one-sided terms to the new company. As a startling violation of good faith and common business honesty the action of Detroit is unparalleled. Had the gentlemen who were led to invest their several millions in giving the city the biggest boom it has ever had, supposed they were to be sandbagged in this manner, no inducements could possibly have secured a penny of their money, and Detroit would still have been twenty years behind the times. The effect is not confined alone to that city, but affects several others in the state of Michigan.

Within the past week the people of that city have been slowly awakening to a realization of the true condition of affairs, and to quote from a Detroit daily, "Dullness is no name for the condition of the real estate market, and disgust fairly expresses the frame of mind in which the dealers find themselves." The chief reason given is the "street car trouble." Not another dollar can be expended in continuing the gigantic system of improvements already well under way, under the present condition of affairs. Apparently the advance in values in real estate amounting to many millions, and due wholly and entirely to the construction of electric lines by the new company, count for nothing. As a splendid instance of stupidity and short sightedness this Indian-gift policy of the city is supreme. Mayor Pingree by his over zealous, misguided and fool policy has much to answer for, and it would serve the city right were such a thing possible, for the Detroit Citizen's to withdraw every dollar it has invested there. The only honorable action left for the city council is to immediately pass a new ordinance giving the new company an exact conveyance of rights equal in every way to that given the old company and extending for the balance of the thirty years, which the old ordinance of 1889 was supposed to give. The case will undoubtedly be carried to the supreme court of the United States. In the meantime business and values are unsettled and the business men of Detroit are beginning to see the error of their ways. The results of this grasping policy on the part of the city should furnish a moral and an example to other cities which fail to see that in dealing fairly and liberally in the grant of franchises to railway corporations they are advancing their own interests in a certainly larger ratio.

HALF FARES.

Interesting Facts from All Parts of the Country Boiled Down for Busy Readers.

BALTIMORE'S City & Suburban Electric was successfully tested May 18.

THE Baltimore City & Suburban opened its North avenue electric line May 18.

BALTIMORE street cars must all be equipped with fenders within the next 100 days.

NEWARK'S Consolidated Traction Company wants to lay track on 18 routes, new and old, if the Board will allow it.

IT is counter report current that Pasadena's electric roads are not consolidated, but that the scheme is being worked.

A SILVER spike was the first to be used in the new Goshen-Elkhart line in Indiana. President Newall officiated at the mall.

A BILL is pending in the Pennsylvania legislature limiting the carrying of freight on electric railways to 200 pounds for each package.

THE Erie Avenue Passenger Railway Company, of Pittsburg, dissolves after six months of corporate existence. J. H. Riggs was president.

C. W. WETMORE, of the Rockefeller syndicate, is the newly elected chairman of the executive committee controlling the Villard system in Milwaukee.

THE Buffalo, North Tonawanda & Sanborn Electric has elected L. F. W. Arend, president; Lewis I. Payne, vice-president; Lee R. Sanborn, secretary.

W. P. BENDING, of Columbus, Ohio, is the inventor of a new life guard, which consists of a netting of wire surrounded by a strong frame. It is being tested locally.

THE cable and Wooland avenue consolidation at Cleveland has acquired the sobriquet of the "little consolidated." Napoleon said that the truly great had nicknames.

ASBURY PARK, the New Jersey summer resort, finds new use for its railway circuit in "filling" up storage batteries for the various electric launches, now becoming popular.

THE electric railway now being built at Muscatine comprises six miles of track to be laid with 48 pound T rail. The General Electric 30 horse-power motor equipment will be used.

THE Midland ordinance, which has so long worried Chicago councilmen, has finally fessed up its backers, who are ex-county clerk M. W. Ryan, Henry McGurran, and William Fitzgerald.

CLEVELAND detectives recently apprehended two line-men who confess to the robbery of the Canton, Ohio, Street Railway Company. Money to the amount of \$125 was taken in several small quantities.

ANOTHER railway scheme appears at Indianapolis in the person of Geo. W. Stone and Hiram W. Miller. These gentlemen are said to be promoting a syndicate that is promoting a road through the suburbs.

G. WILBUR HUBLEY, electrical engineer of the Citizens' Traction Company, Pittsburg has resigned his position to accept the position as superintendent of the Louisville Electric Light Company, of Louisville, Ky.

THE transfer system of the Baltimore City Passenger will be changed when all cars are running. The present system pays for transfers and extends them a day. The new system will be free transfers and time limits.

THE new syndicate that consolidates the roads of Dayton, Ohio, is officered as follows: President, D. B. Coffin; vice-president, C. B. Clegg; secretary, W. H. Simms. The company is known as the City Street Railway Company.

A SMOKELESS oil burner, the invention of the Rev. Wm. H. Ziegler, of Anderson, Ind., is now on exhibition at 1440 Broadway, New York. The machine is said to take up little space and of course, is powerful enough to run the earth.

THE New York Electrical Society reports 309 members and the following officers: President, Jos. Wetzler; vice-presidents, F. B. Crocker, Nikola Tesla, M. M. Davis, C. E. Emery and C. O. Mailloux; secretary, George H. Guy.

A NEW YORK L guard recently found a can of what proved upon expert examination to be brains. It is supposed that some medical student left them in the car by accident. In gentle irony can and contents were sent to the rapid transit commission.

THE Oakland & Alameda electric is now in operation and the following officers chosen: President, W. M. Rand; vice-president, Colonel F. H. Meyers; secretary, S. H. Bass; directors—E. S. Denison, V. H. Bailey, W. M. Rank, F. H. Meyers and H. Bass.

A PHILADELPHIA lawyer's wife recently stopped the progress of setting railway poles by spreading her crinoline skirts over the newly dug holes. Ten hours she stayed, but during the night the enemy came and sowed 30-foot poles and her labor was for naught.

THE Pittsburg Electric Club elects officers, May 6, as follows: Morris W. Mead, president; vice president, John Campbell; house committee, Dr. Adolph Koenig, Prof. H. P. Ecker, E. P. Austin; membership committee, John E. Ridall, G. H. Blaxter and D. W. Dunn.

ON A horse line in Kansas the following story is told of an elderly gentleman who rode out to a cemetery one Sunday. When asked by the driver if he wished to return to the city he replied: "No, I am too old to undertake the trip. The graveyard is handy, and I guess I will stay right here."

PRESIDENT D. F. LEWIS returns to Brooklyn City duties after a pleasant two weeks at the World's Fair and declares the same to be "the biggest thing ever put together by the hand of man." Mr. Lewis refuses to talk on the recent lease of the Brooklyn City or upon his future relations with the same.

A NEW YORK JOKE.—On a Broadway car recently the driver was looking very intently at the new cable working in the slot. A driver of a green car coming from up town noticed him and said: "Hello, there! Whatcher doin', droppin' a nickle in de slot to see de cable work?" "Naw; I'm lookin' fer Jake Sharp."

ECLAR does not explain the character of the opening of the electric road at Muncie, Ind. The beauty and chivalry, eloquence and intellect of the town was simply opened wide to welcome the electric current that takes the place of the steam dummies. O. S. Kelly, of Springfield, O., is one of the chief backers of the company. George F. McCulloch is general manager and W. C. Gotshall, superintendent.

SOME fiendish fool has from time to time amused himself by throwing stones through the windows of the Canton-Massillon, O., interurban cars. The local authorities efforts ended fruitlessly, so President W. A. Lynch, three policemen and twenty-five angry and armed citizens laid in ambush for the miscreant. He was not caught, however, but a permanent patrol is now watching the line. Four attempts have been made to wreck the cars.

SOMETIMES loose frogs interfere with schedule time, but the New York cable railway was stopped by a lot of speckled perch, weighing from a half pound to a pound. When the engineer attempted to turn water into the boiler at the power house the water wouldn't run, and to investigate, the man unscrewed the pipe connection with the Croton main, to discover the pipe filled with the above mentioned specimens of piscatorial research.

SYNDICATE after syndicate is being formed and the latter part of May sees the coagulation of \$4,000,000 capital to handle the produced power (that is to be) of Niagara. The bill gives rights to the company to transmit power, heat and light for any purpose, at any voltage, and in any quantity, anywhere in New York state. Rochester, Syracuse, Utica, Rome, Schenectady and New York will be in the line of the first attempts.

SIoux CITY'S failures of the last month affected street railways to a greater extent than was at first suspected. On May 15, A. F. Nash, a heavy stockholder in the Sioux

City Street Railway, asked for the appointment of a receiver and Jas. S. Peavey, was qualified under \$50,000 bonds to fill that position. The total liabilities are \$750,000. The company owns among the best franchises in the city and 35 miles of operated road, equipped electrically. The stock is held mainly in Sioux City.

THE street railway employes are in a hard, hard row of stumps. Their labor organization is split in twain, and each of the two disinterested "friends of the laboring man" that lead the respective factions make it hot for the fellow that doesn't hold his ticket. To avoid these unpleasant results a number of the men have taken out tickets on both factions. Law and Bowen are the leaders of the factions, and the former, strangely enough, seems to be the "bowen of contention," while the latter will not conform to the "law."

LARGEST SUBURBAN SERVICE IN THE WORLD.

THE perfected arrangements of the Illinois Central Railroad for operating through express trains between Van Buren street and the Exposition grounds are undoubtedly the most extensive and complete ever made. Two tracks, extending close to the lake all the way, are devoted to this service, and as no



"TEN CARS ARE DRAWN IN ONE TRAIN."

streets are crossed at grade, trains are run through without stop, making the eight miles in twelve to fifteen minutes. As many as 10 cars are drawn in one train; each car seating 96 persons. The terminal facilities are such that a full train load has been discharged frequently in 22 seconds and loaded in 30. The cutting off the engine and attaching another at what was the rear of train occupies but 37 seconds, hence the ability of the company to operate trains of 10 cars each every two minutes. Were all their 300 special cars in use the seating capacity would be 57,000 per hour, or over a 1,000,000 per day. The local suburban trains stopping at each station are good for 200,000 more a day. There has not been a day since the Fair opened in which the transportation facilities were not more than ample.

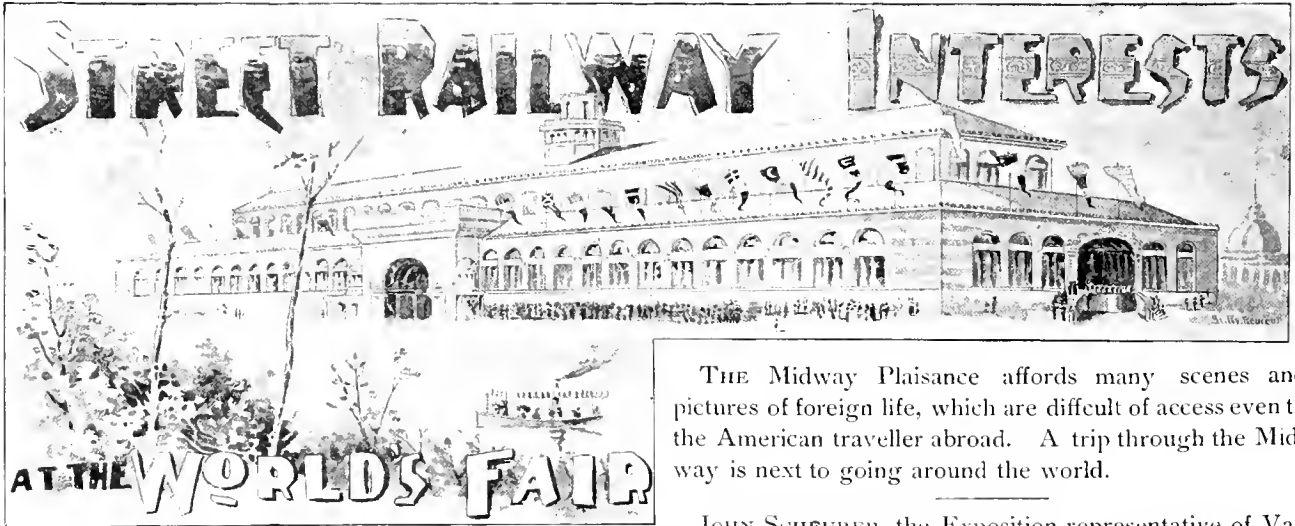

F. C. MASON, of Brooklyn, N. Y., was a World's Fair visitor of the past month.

P. C. ACKERMANN, of the American Electrical Works, was a late Exposition visitor.

W. J. JOHNSTON, wife and family of New York, were June visitors at the Exposition.

R. J. B. SHARPE, of Dick, Kerr & Company, London, represents that old established firm at the Exposition.

THE attendance is constantly increasing and the total receipts for May exceed the first month of the Centennial by \$125,000.

GEORGE DAULTON, of the Peckham Motor Truck & Wheel Company, assists Sales Agent P. S. Bemis at the Peckham exhibit.

WATERMAN STONE, superintendent and general manager of the Kansas City Elevated, spent a few days during the month at the World's Fair.

PAUL H. PAGES, New York, is holding the fort for John Stephenson Car Company, Ltd., in "street car row." Mr. Pages is an artist of repute.

FRANK C. MASON, late of the Telegraph Bureau of Police and Excise, New York, is honorary assistant of the Bureau of Electricity of the World's Fair.

JOHN STEDMAN, of Rochester, N. Y., has a beautiful transfer ticket of his own design on exhibition in the "Row." It is in use on thirty roads. The model is done in silk and is five feet long.

PRESIDENT PAGE, of the Page Belting Company, Concord, N. H., and one of the national commissioners of the World's Fair, spent several days in Chicago, on both official and personal business.

THE Midway Plaisance affords many scenes and pictures of foreign life, which are difficult of access even to the American traveller abroad. A trip through the Midway is next to going around the world.

JOHN SCHREURER, the Exposition representative of Van Der Zypfen & Charlier, the German car builders, has returned to Germany to stay until the last of August. Mr. Charlier will spend two months in Chicago.

W. C. CLARK, general agent and assistant treasurer of the Westinghouse Electric & Manufacturing Company, Pittsburg, spent a few days of last week in Chicago visiting the World's Fair and starting his family for California.

C. S. VAN NUIS was a June visitor in street car row. He was arranging the exhibition of a fine line of his Ajax switches, Fulmen lightning arresters, and the complete display of the specialties made by A. and J. M. Anderson, of Boston.

THE flag pole in front of the Washington state building is 260 feet high, top tapering uniformly from a diameter of only 32 inches at the base to 14 inches at the top. It was cut from a fir tree 300 feet high, weighs sixty tons, and one mile of rope was required in raising it to present position.

THE Fair is now open on three evenings in the week, Tuesday, Thursday and Saturday, until 11 o'clock p. m. Nearly all the buildings are open and lighted, and band concerts, search lights and the electric fountains contribute to the splendor of the White City, which is even grander at night than in the day.

SOME aesthetic thief had the good taste one night recently to purloin and maliciously convey away one of the very pretty lamp shades of the Jones closed car in the Transportation annex. The lamps and shades were furnished by Smith of New York, and the thief is hereby assured that he got a good article.

THE exhibit of the Standard Railway Supply Company is not only a credit to that company, but is attracting a great deal of attention from both street railway men and the public. Their handsome car heaters suggest visions of warm rides next winter, and no visiting manager should fail to see this display, which is in aisle L, N, between 11 and 12, Transportation Annex.

THE BARRE SLIDING RAILWAY.

THE curiosity aroused by the wooden superstructure stretching the full length of the Midway Plaisance on the south side, is now assuaged by the news posted in various quarters that it is the Barre Sliding Railway, described in particular by the STREET RAILWAY REVIEW last year. The final completion of the Barre slider has been until lately problematical, but the floating of new bonds and the settling of some minor matters, brought in enough of the very necessary money to complete the arrangements.



A. BARRE.

The power house for the system is now ready to begin operations, and the tanks and outlets for the water are about settled in position. The pipe line and condensers have been in position for some time.

The view presented here shows the motor truck with the reserve condenser in position, together with the skates and rails.

portrait of Mr. A. Barre, the French engineer who has followed out the details of this work and perfected it under his own name. Mr. Barre and his son are both



BARRE SLIDING CAR.

connected with the construction of the line. The line will be interesting both as a novelty in traction and as demonstrating methods new in this country.

THE World's Fair visiting list of the Railway Equipment Company, Pullman building, is as follows:

- Wm. B. Given, president Columbia (Pa.) Electric Railway.
- Arthur Bergtheil, Bergtheil & Young, London, Eng.
- Frank Bloom, manager Tiffin (O.) Electric Railway.

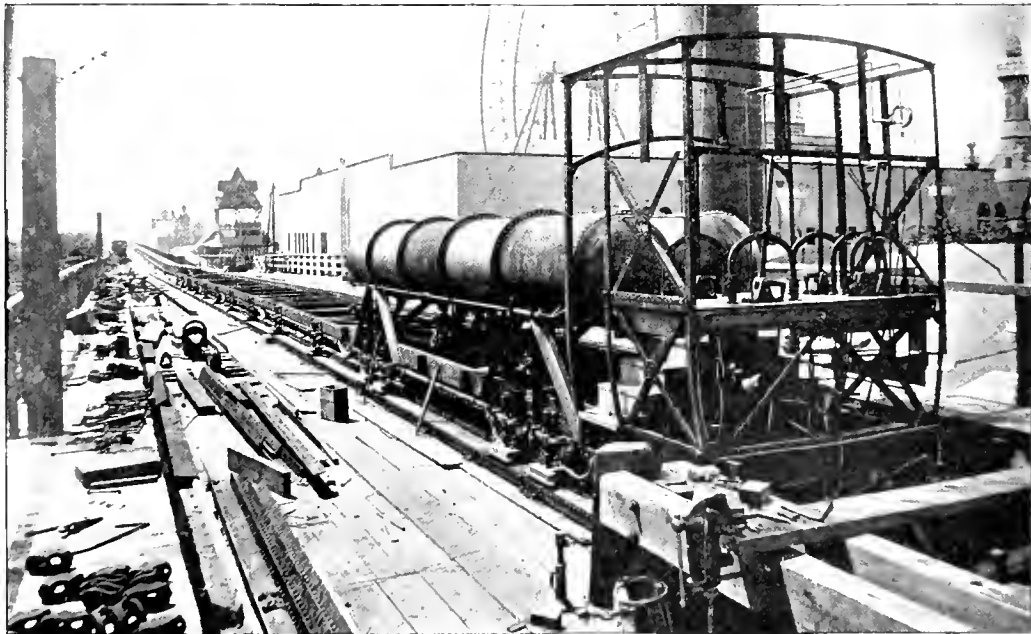

MOTOR TRUCK AND CONDENSERS—BARRE SLIDING RAILWAY.

Further down the track may be seen four cars, substantially as shown in our engraving. The cars are made by the American Car Company, and follows the European plan of side opening. They are good, solid, substantial cars, and well furnished besides, as all the American Car Company's cars are. Without doubt there is something in a name, for each car bears the name of one of the four cities of Chicago, New York, St. Louis and Milwaukee.

The new management promises that the finishing touches of the work will be placed by July, and all comers to the Plaisance may then take a hydraulic ride to the ends thereof. We are pleased to present this time a

- S. Russell, Duplex Rail Company, New York.
- Wm. S. Downey, Schuylkill Traction Company, Pottsville, Pa.
- R. F. Ogilvey, Field Engineering Company, New York.
- W. A. Stadelman, manager Bristol (Tenn.) Belt Line Railway.
- James A. Jackson, Sioux City (Ia.) Rapid Transit Company.
- F. B. Black, Citizens' Street Railway Company, Mansfield, O.
- A. B. Wetmore, Detroit Citizens' Street Railroad Company.
- F. G. Jones, manager Citizens' Street Railroad, Memphis, Tenn.
- Guido Panteleoni, Westinghouse Electric & Manufacturing Company, St. Louis, Mo.
- James Lillie, Escanaba (Mich.) Electric Railway.
- Witten McDonald, president North East Street Railway Company, Kansas City, Mo.
- W. R. Proudfoot, superintendent Janesville (Wis.) Street Railway Company.
- C. H. Cobb, president Kankakee (Ills.) Electric Railway.
- William McKinley, Bay City (Mich.) Consolidated Railway Company.

THE ELECTRICITY BUILDING.

NEXT to the Mining Building and facing the lagoon on the north stands the Electricity Building, the artistically useful expression of the idea by Van Brunt & Howe, architects, Kansas City. Standing next to the Mining Building, which seems of the same architectural significance to the common people, the building does not show to its best advantage in a general view, although to a particularized glance the detail is apparent to the most ignorant.

The length of the building north and south is 690 feet, with a width east and west of 345 feet. It is 114 feet high, and has a floor space of 76,000 square feet in the gallery, and of 128,000 on the main floor, giving in all an expanse of $5\frac{1}{2}$ acres of floor on which to place exhibits. The beautiful south entrance is a hemicycle, flanked on each side by a loggia 115 feet long, giving a porch of 230 feet. In the middle of the hemicycle stands the

of the structure is shown by a test of 200 pounds to the square foot on the ground floor and 150 pounds on the gallery floor.

The working force of the department is now: J. P. Barrett, chief; Dr. J. Allan Hornesby, assistant chief; J. W. Blaisdell, general superintendent; W. W. Primm, engineer; N. S. Hawley, assistant to Mr. Barrett; T. R. Lombard, assistant to Mr. Barrett; and Geo. J. Henry, also assistant and master of the rolls, to whose kindness we are indebted for our correct list of the exhibitors, and to whose knowledge of affairs exhibitors say they are saved much tribulation from the dense ignorance which prevails in some quarters of the department.

IN THE GALLERY.

The doctor and newspaper man rubs shoulders with the French and German purveyor of pianos and cymbals, and the hungry multitude in general find a modern mecca here.

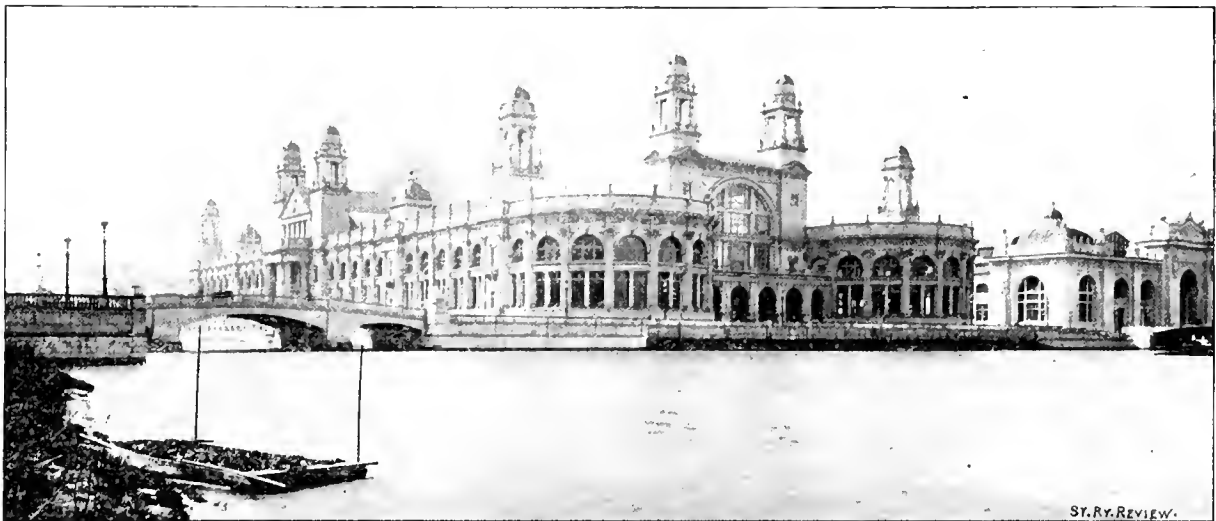

ELECTRICITY BUILDING. NORTH FRONT, VIEWED FROM THE NORTHWEST.

gigantic statue of Franklin, representing the great American triumphant, with the kite string in his hand and touching the key. Carl Rohl-Smith is the author of this magnificent work. On the border of the hemicycle stands the legend, *Eripuit Caelo Fulmen Sceptrumque Tyrannis*. Above in the panels appear designs of tasty and appropriate conventionalities, and below appear the names of Daniel, Ampere, Galvani, and others of the famous, while on the sides of the building and at the north end the same idea of the roll call of electricity is carried out.

The building is of the Italian renaissance school, being a combination of the Corinthian and Ionic orders.

The north view, which shows in our engraving, gives us two bays and a small porch, fronting on the lagoon, and a favorite lounging place for the tired sightseer of an afternoon. The building was begun February, 1892, and finished September of the same year. Its contractors were Arthur Johnson & Bro., of Omaha, and the strength

THE ATLANTIC CABLE.

In the gallery on the west side, the Commercial Cable Company has an exhibit which seems to be placed there with the exclusive intent of destroying our childish faith in the legend that cable messages are received by flashes of light. The Commercial Company, to accomplish this object, has a neat booth in which is placed a sending and receiving instrument of the most improved pattern. The west instrument represents the American shore and the eastern the European side. The resistance is placed at 2,300 miles, and all the business is as thoroughly transmitted as if it cost fifty cents a word.

The siphon recorder with which the accompanying cablegram was written, is the invention of Sir William Thomson, Lord Kelvin, and consists of a rectangular coil of silk covered wire and a powerful magnet. The coil is suspended between the poles of the magnet and when excited by the electric current from the cable

THE EDISON DIRECT COUPLED UNIT.

THE various specimens of direct connected power units on exhibition in the various mechanical displays at the World's Columbian Exposition are to a surpassing degree interesting to the electrical and power using fraternity.

In Machinery Hall on the south side and near the east wall stands one of the largest of those, which we are able to present to our readers this month. This unit consists

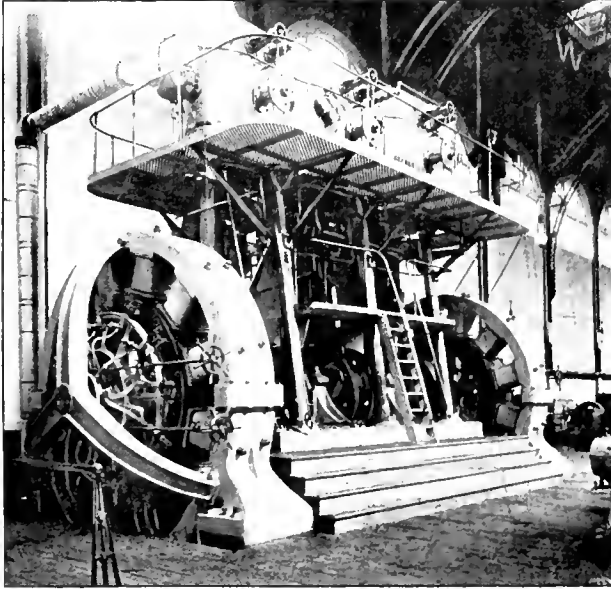

EDISON DIRECT COUPLED UNIT.

of an engine built by the Southwark Foundry & Machine Company, of Philadelphia, and is a noble specimen of their skill in constructing this large type of engines.

The floor space occupied by the engine is 15 feet 6 inches and 27 feet and the piece is 21 feet high. The condenser is built in the bed plate, thus saving so much of valuable space on the floor. As this is an unusual construction it will no doubt be a feature worthy of special study. The engine bed is a strong eight foot foundation of brick and concrete solidly built up. The machine, as the reporter saw it turning over, gave surprisingly little vibration.

The cylinders are $22\frac{1}{2}$ inch, $33\frac{1}{8}$ inch and $53\frac{3}{8}$ inch by 36 stroke. These diameters are closely calculated in order to get equal work on each cylinder. The Corliss valve gear, dash pots and the piping of the machine are perfectly adjusted and made in the most perfect pattern. The steam pipe is eight inches in diameter and the exhaust 18. The machine was designed by J. C. Henderson, chief engineer of the Edison General Electric Company, whence the name Edison type, and the builders are, as before mentioned, the Southwark Foundry & Machine Company, of Philadelphia. Two 400-kilowatt multipolar dynamos are direct coupled to the engine, furnishing power to the Electricity building. The armatures are 107 inches in diameter and weigh 12 tons, and the speed,

when in operation, is 100 revolutions per minute, running at 150 volts. The whole affair weighs about 500,000 pounds.

Near this giant unit are four regular Edison dynamos; of 150 kilowatts each, driven by Ball compounds and Armington & Sim's engines. The switch board governing the plant is of marble, 23 feet long by 11 high and contains the dynamo switches as well as the distributing current and controlling apparatus. The current is distributed on the Edison three wire system in underground tubing.

AN ELECTRIC CAR OF '47.

THE Farmer Electric Railroad of 1847, or as the hand bills called it the electro-magnetic engine was a very primitive affair, as may be seen from the engraving, which shows the reconstructed original now on exhibition among the displays made by the Western Electric Company in the Electricity Building.

The car and motor are on the west side of the aisle on the east side of the building, backed by the Bell Telephone building and surrounded by the most improved children of the evolution which has followed.

The rails of the railway were of cast iron, two feet in length and of the fish belly pattern, that is, the depth of

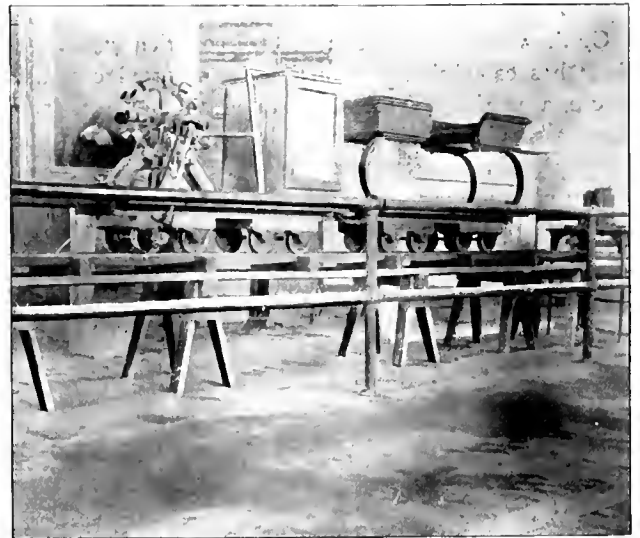

THE FARMER ELECTRIC CAR OF 1847.

the rail in the middle is about two inches, while that of the ends was about an inch. Rails were five-eighths of an inch thick and set on wooden sleepers gooved for the purpose. The head flange of the rail was a little more than $\frac{3}{8}$ of an inch and the depth rather more than $\frac{1}{8}$ of an inch. Enough of these rails were laid to extend across the hall when the lecture on electric traction was to be recited as per the hand bills given out.

On these rails ran two cars, a passenger car and a locomotive. Each car was about four feet long and one-and-a-half feet wide. The frame of the car was cherry about one-and-three-quarters inches wide and deep. The passenger car, as may be seen, held two seats

facing each other and set on C springs. The seats, the original of which are on the Exposition model, were nicely upholstered.

The wheels of the car are of cast iron and six inches in diameter, with flanges of about a quarter of an inch.

The locomotive, as remarked, is of the same general

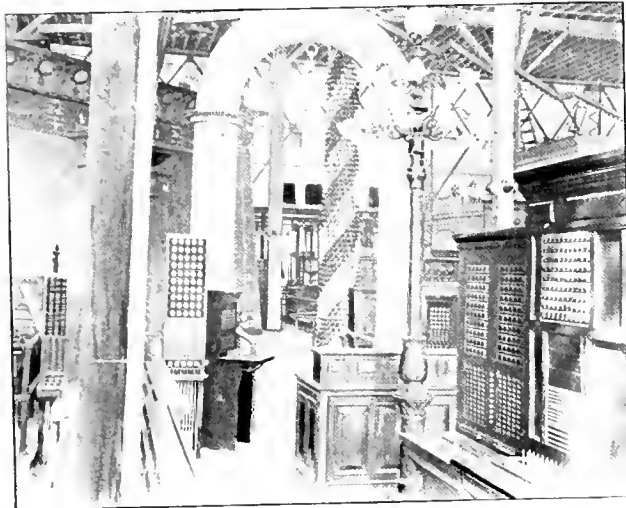

A CORNER IN THE ELECTRICITY BUILDING SHOWING PART OF THE WESTERN ELECTRIC EXHIBIT.

construction as the car. In those good old days 48 cells of the Grove battery did duty for motive power, for as the old song says, generators

"Were not invented."

The cells were pints and connected up in series. These were placed in a box and carried on the car. In front of the box was the motor, exactly counterpart of the one shown today. It consists of a cast iron skeleton wheel of perhaps a foot in diameter and a rim about $1\frac{1}{2}$ inches wide and one-fourth inch thick. Twelve electro-magnets are attached to the outside of the rim. The magnet cores of the original were wrought iron, making a U magnet. On each arm of the magnet is a coil of copper wire covered with cotton thread. The axis of this armature is supported on two vertical posts rising from either side of the carriage, as seen by our engraving. Beneath the wheel are three larger magnets supplying the fields, this middle one being shorter than the other two. The two larger magnets are inclined at an angle so that the armature magnets come into circuit, so that one armature magnet and one field magnet are always in circuit in series and tending to pull the wheel forward or backward as the position of the commutator requires. The arrangement of the commutator so as to shift the circuit gives the engine backward or forward motion. The principal claim of Professor Farmer's car is that it was the first to allow this arrangement.

The car is a curious affair and the original attracted great attention in those early days, as Professor Farmer and his brother carried it on exhibition from one town to another, explaining its action and prophesying great

things for electric traction, prophecies that have since been more than verified. It cannot but be a matter of general regret that Professor Farmer should not have been spared a few more months of life to be present at his exhibit as he had so earnestly hoped and expected.

THE BELKNAP MOTOR COMPANY.

ON the ground floor of electricity, at section E, space 2, the Belknap Motor Company, of Portland, Me., has a nice exhibit under charge of Manager Geo. Brown of that company.

The reorganization of the company has placed it on a firm financial basis, and its large factory is one of the most important electrical industries of Portland. The goods displayed are shown artistically and the tasty sign at the north end attracts the attention of every passer-by,

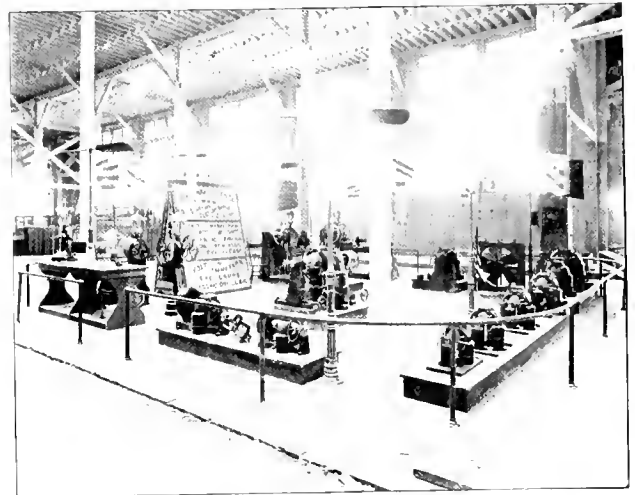

WHERE BELKNAP MOTORS DRIVE.

while the whirlwind from their fan causes the banner to flutter in the breeze and snap triumphantly. The power mills for grocers and other light manufacturing purposes are made for 500 volt railway circuits, and all street railway men are invited to call and investigate the rapidly growing industry. Selling power from railway circuits has been earnestly advocated by the STREET RAILWAY REVIEW, and the Belknap Motor Company will tell you more on the subject.

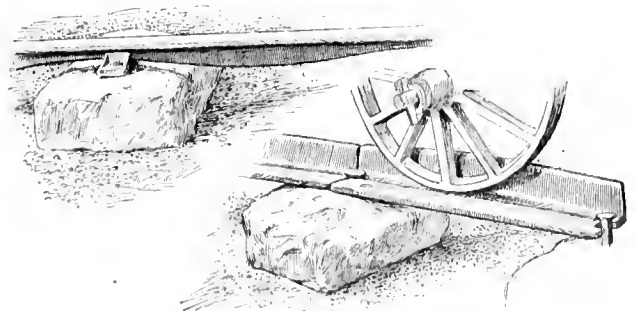

AN OLD TIMER—TRANSPORTATION BUILDING.

STIRLING BOILER WORKING EXHIBIT.

THE biggest boiler plant in the world, illustrated some time since by the STREET RAILWAY REVIEW, contains in its vast power creating capacity a full presentation of the possibilities of the Stirling boiler.

Our engraving is from a wood cut detail of this great plant, and shows in particular the part taken it it after a hard fight and consequent victory by the Stirling people.

Their exhibit is a most creditable one, and consists of three separate and distinct plants, aggregating 2,800 horse power, comprising two separate batteries, each containing two boilers of 400-horse-power, in the main boiler room; one battery of two boilers of 400-horse-power each, in the boiler room annex; and one battery of two boilers of 200-horse-power in operation at the Libbey Glass Company's exhibit in the Midway Plaisance.

The main plant is in the extreme west end of the big boiler room, and presents by reason of its white and silver paint a clean and handsome appearance.

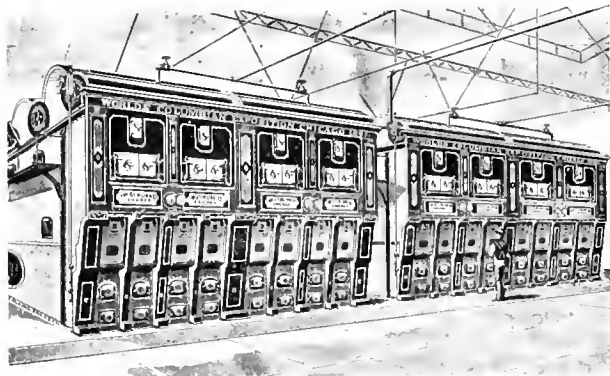

STIRLING EXHIBIT IN MACHINERY HALL ANNEX

The general construction is that followed by the Stirling Company, and consists, briefly, of three upper steam drums, and one lower mud drum, respectively 36 and 42 inches diameter, all connected by 3 1/4-inch tubes, which are expanded directly into the drums, and so bent as to allow for the varying degrees of expansion and contraction. In one end of each drum is a 16-inch manhole faced elliptically, against which a plate may be fitted and held in place by wrought steel bolts. The removal of these manhole plates gives access to every tube in the boiler, and the drums are large enough to enable a man to work inside conveniently. The water is fed into the rear upper drum, and flows through sixty tubes to the mud drum beneath, coming in contact in its descent with the ascending gases, and becoming heated to a sufficiently high temperature to cause the precipitation of magnesia, lime and other solid matter that the water may contain, into the mud drum beneath. As a result the two front rows of tubes are filled with chemically pure water, and all danger of scaling is thereby removed.

There is no cast metal used in the construction of the boiler, in consequence of which a higher pressure may be carried with absolute safety, and without danger of explosion. The boiler is subjected to a cold water test

of 200 pounds when erected, and is guaranteed by its manufacturers to stand a steady working pressure of 150 pounds.

The oil fuel used attains the end of cleanliness, and altogether the exhibit is one in which the Stirling people may take pride, and the visitor will inspect with profit and pleasure.

WASHBURN & MOEN.

THESE wire factors are placed in the extreme north-east corner of Manufacturers' Building. Their space is 40 by 40 feet, and one of the largest individual exhibits in the building. Handsome arch columns of white, upon the top of which are mounted large urns and flags, give a gala appearance to the entire display. A Corinthian column 45 feet high graces the center of the structure, at the top of which is an American eagle and a number of incandescent lights. At the foot of the column is a street railway wire exhibit, consisting of a reel of 1 1/4-inch cable for cable railway work. The reel is 10 1/2-feet high. Grouped about are eight show cases containing the finished material in all forms, such as clock springs of the most delicate texture, lock springs of heavier type, flexible lamp cord, annealed



WASHBURNE-MOEN EXHIBIT.

copper wire, and bare and insulated copper cable. Bicycle and sulky spokes and steel instruments made by the company are shown in every variety of style. Wire nail spikes and staples, and wire in all sizes and shapes, round, flat, octagonal, hexagonal, and every other 'agonal, from cable to bookbinders' wire, is displayed to the delight of the craft. Over the show cases containing the above designs rise six columns of wire each 10 feet high. These columns are handsomely decorated and show to the best of advantage the immensity of the wire trade and the part played by the Washburn-Moen people. A cap of wire surrounds the top of these columns and is tipped with tempered clock springs. Supported by these rises a column surmounted by an American eagle.

Facing the north are the exhibits of the electrical field showing feed wire, trolley wire, and all styles of conductor wire. Miscellaneous wires and rods close the exhibit and our description.

The exhibit was designed by Herbert Smith, of Worcester, and is a credit to him and to the company.

THE TOWER OF LIGHT.

ON June 1 the magnificent Edison Tower of Light was unveiled and illuminated, and all eyes were turned to the center of the Electricity Building, where glowed and sparkled and blended the running colors of the electric light, softened and changed by the multi-colored globes. The tower is the design of Luther Stieringer, and erected by the General Electric Company.

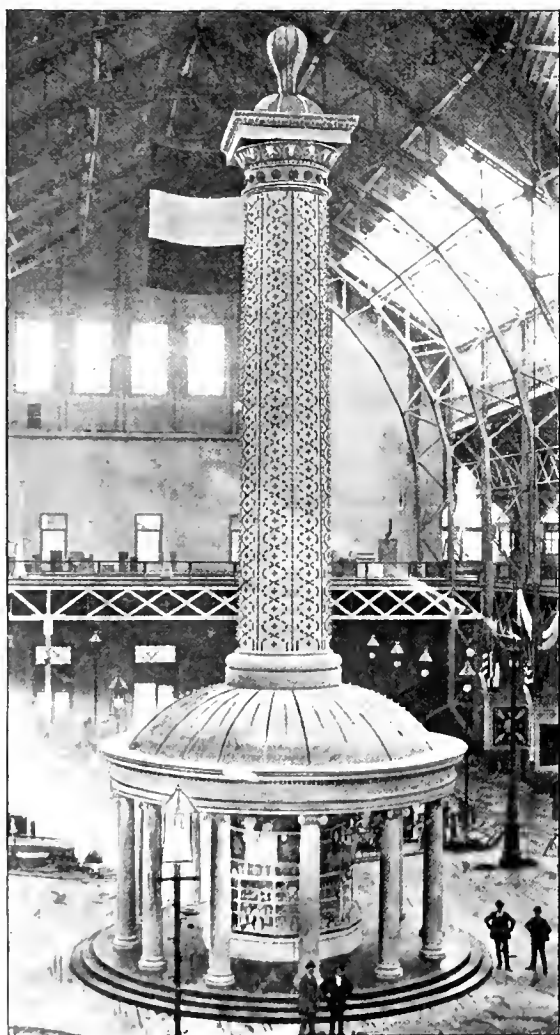

"THE TOWER RISES TO A HEIGHT OF 82 FEET."

The tower rises to the height of 82 feet, and is surrounded at the base by a circular pavilion 32 in diameter. The shaft is cylindrical, with the buff surface representing various conventional designs in lamps. The lamps, which pick out the pattern, are 4,000 in number, incan-

descent 5 c. p., red, white and blue as to color. At the top of the tower is a huge globe, weighing half a ton. It measures 8 feet high and 4 feet in width. The prisms in it are each about three-fourths of an inch in diameter, and 30,000 pieces of crystal are used. It is a beautiful object.

Under the pavilion, which is supported on Ionic columns, is a fine collection of the wares of the Phoenix Glass Company.

The circuits of the lamps are so arranged that the lights can be thrown on or off at will, and the subdivision of the circuits carried out with the utmost nicety. The work required three miles of wire. The lamps are placed four in series, on a 114-volt circuit.

GENETT AIR BRAKE EXHIBIT.

THE Genett Air Brake Company have a very attractive exhibit in their space, in the air brake section of the Transportation Building. They have a truck made by the Taylor Electric Truck Company, mounted with General Electric W. P. motors, and raised from the floor so as to operate the wheels. Attached to the axle is one of their new style encased air compressors, the "Broncho," which is piped to the reservoirs and brake work of the car, same as in regular service. Air gauges are attached to the cylinder heads of the compressor, and also a gauge has been placed on each of the reservoirs, which plainly shows the operation of compressor and storage of air in reservoirs. When the motors are started, the turning of the wheels operates the compressor, and it takes about forty revolutions of the wheel to fill the reservoirs from 0 to 32 pounds pressure, which is the maximum amount carried. When this pressure has been reached the governor cuts out the compressor in such a manner that the pointers of the gauges attached to the cylinder heads point to 0, showing that the piston is moving freely and not working against the pressure, while the gauges on the reservoirs show the full pressure of 32 pounds as stored within them. The controlling valve is then turned, and the air pressure applies the brake shoe to the wheels. This requires three pounds of the storage pressure in the reservoirs; the brakes are then released and the motor started again, but the gauges on the pump cylinder heads remain stationary, pointing at 0, and show that the compressor is not working against the pressure in starting, even after air has been used to stop the car, until the wheels are under full headway, when the compressor automatically cuts in and restores the few pounds that have been used in stopping. This requires just five turns of the wheels to furnish.

The company also have one of their pumps attached to an air hoist, showing a capacity to lift one thousand pounds, raising and lowering it with perfect ease a distance of five feet, with an air pressure of 32 pounds. The air pump furnishes this supply along with the brake power of the car. This is a new feature of handling heavy castings in railroad shops, or large manufacturing

plants, by merely placing one of their pumps on a revolving shaft in the factory and utilizing the air pressure for this purpose.

Street railway men will find it to their interest to visit their exhibit, for it certainly furnishes them with the fullest information regarding this air brake, and enables them to see at a glance the little power required to operate the compressor, and the great amount of brake force produced.

The company have a regular attendant, who is pleased to furnish full information and answer any questions. A similar exhibit is placed in connection with the General Electric Company's exhibit in the Electrical Building.

THE WESTINGHOUSE RAILWAY EXHIBIT.

NEXT to the Bell telephone temple with the priestesses of Bell, pardon this biblical pun, to the north thereof, stands another octagonal temple erected to the Westinghouse railway exhibit.

The direct driven method of generator connection is illustrated by the "kodak" unit, which consists of a 16 and 27 by 16 inch Westinghouse compound engine, connected by a flexible coupling to a standard four pole railway generator. The generator and engine rest upon the same bedplate, the frame of the generator being electrically isolated from the engine by means of a wooden sole plate and insulated shaft coupling. This kodak unit is a standard 270-horse-power.

Opposite the kodak is a four pole belt-driven generator of 400 horse-power. This shows the Westinghouse style of belt driven generators for railway work, differing from others only in size, and in having outboard bearings which are not placed on smaller machines.

Two generator armatures are shown, illustrating the method of winding the iron clad armature, and also showing the difference between windings on direct and belt-driven generators. These armatures also show two methods of commutator construction.

Upon a table in the area are displayed an assortment

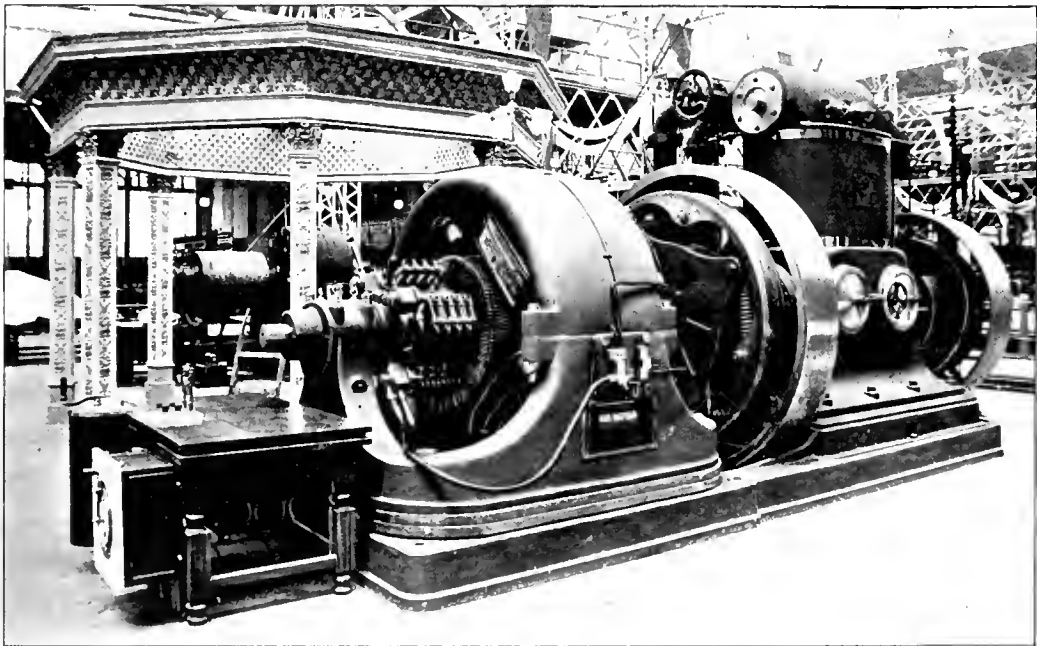

THE WESTINGHOUSE RAILWAY EXHIBIT, SHOWING DIRECT COUPLED UNIT.

The design is pleasing to the eye and the interior will be restful to the railway man as he wanders in and reclines on the comfortable chairs. Ranged about this center is the Westinghouse railway exhibit, consisting of a line of standard type apparatus. Here may be seen the types of single reduction motors, parallel and series, parallel systems of controllers, direct connected and belt driven generators, and in fact all the details of standard Westinghouse equipment for power station or car.

The general idea of the exhibit is to illustrate principles, types and workmanship of regular commercial street railway apparatus. To attain this end both generators and motors are shown with full complement of detail, but no attempt has been made to show machines of all standard types, although all types shown are standard.

of generator details, including shunt and series field coils a marble-top incombustible field rheostat and a complete brush holder, with the latest ribbon spring carbon holder.

The Brownell Car Company, of St. Louis, also joins the Westinghouse procession just here with an Accelerator car, 20 feet in length. This car is equipped with standard 30-horse-power motors, series parallel controllers, incombustible diverter, and latest designs in lightning arrester and minor car devices.

John Stephenson Company, limited, have placed a beautiful joint exhibit with the Westinghouse fold, in the shape of a well equipped closed car which takes its place next to Brownell.

The car stands convenient to observation on the north side of the display, and under it runs a pit, through which

visitors may walk to examine the method of wiring the car and mounting the motors. The car is furnished complete, even to the neat fare register, manufactured by the New Haven Car Register Company.

On another part of the space are two motors mounted upon a truck manufactured by the Sheffield Velocipede Car Company, of Three Rivers, Michigan. This truck is supported, with wheels clear of the floor, and is wired up to controlling apparatus mounted upon a table near by. This truck and equipment illustrate the method of mounting motors followed by the Westinghouse, and goes to demonstrate their claims of noiseless operation.



J. W. McCrosky.

Several motors mounted upon racks afford an opportunity to examine their mechanical construction and methods of operating motor fields. One

Mr. McCrosky is 25, a westerner, and graduate of Nebraska State University. His connection for the past two years has been with the railway department at Pittsburgh, to which he has shown great adaptability.

THE GENERAL ELECTRIC RAILWAY EXHIBIT.

JUST south of the magnificent tower of light illustrated in this issue, is space H, 2, which contains food for thought for every intelligent street railway man who comes within the arches of the temple of electricity. For here is a complete resume of the modern practice in street railway work as followed by the great General Electric Company.

Lieutenant E. J. Spencer, whose portrait appears herewith and who is special World's Columbian Exposition minister plenipotentiary of the General, from the Lynn factory, takes especial pride in this remarkable display

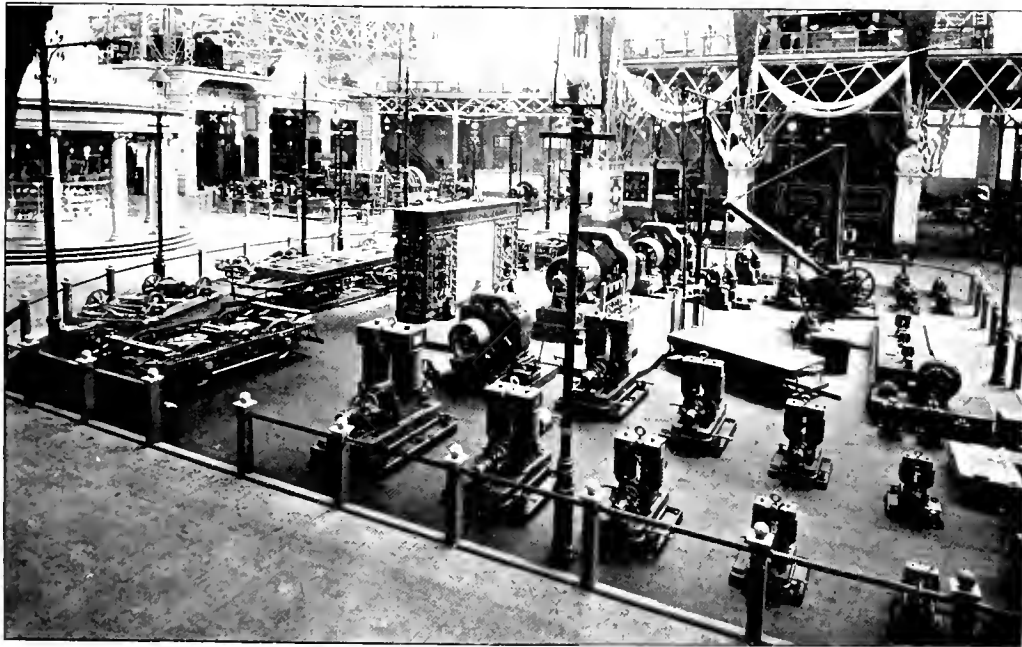

THE GENERAL ELECTRIC RAILWAY EXHIBIT.

of these motors runs with its top field piece thrown back, to facilitate the gratification of the curiosity of those who wish to see the wheels go 'round.

On another table is shown in detail the "works" of the motor and car equipment, while there is also displayed a complete line of switchboard details, embracing switches of various sizes, meters, circuit breakers, and other controlling and measuring apparatus, together with the Keystone air blast and tank lightning arresters. All switchboard apparatus, it may be well to state, is mounted on marble bases and designed for connections behind the board.

The display is a complete one, well arranged, and distinctive, without being pyrotechnic in its design.

The engineer in charge of the installation is J. W. McCrosky, one of the Westinghouse bright young E. E's.

which is surely a complete essay on electric traction, illustrated realistically from the generator to the trolley fixtures.

All standard General Electric types are shown in this space, which is divided by a row of five generators. The center generator is a large 300-kilowatt multipolar, flanked on either side by a 100-kilowatt multipolar and a 200-kilowatt multipolar. These show ordinary sizes, but he who would inspect the extraordinary has but to board an intramural train to the power house, where a 1,500-horse-power generator is driven from a 2,000-horse-power Allis-Corliss. Ranged on the outer edge of the space and beginning with the north end of the west entrance, the visitor will observe a Taylor truck, upon which is mounted two W. P. 30-horse-power motors. This truck is also equipped with a Genett air brake,

showing its method of attachment and illustrating the economy of space claimed for it. This is a joint exhibit with the truck and motors. Standing on a table near by is a 30-horse-power S. R. G. motor, intended to show the type. The next, continuing around the circle, is a W. P. 30, mounted on a joint exhibit with the Stephenson wood frame truck, showing, as each of these joint exhibits does, the applicability of the General Electric system to the various makes of trucks on the market.

The next in line is a S. R., F. 30-horse-power, mounted on a McGuire truck running on Griffin wheels. A Bemis truck is the next in the procession, and at this writing awaits two of the new G. E. 800 motors referred to on another page of this issue.

By this time the visitor is at the east side of the exhibit, where an Intramural truck may be seen, upon which are mounted two L. W. P. 20's. The horse-power represented is 130 each. These may be seen in operation upon any Intramural train, or Engineer Macloskie will explain them to a greater extent at the Intramural shed. The motors are meant for 200 amperes at 500 volts, as previously stated in the REVIEW. The truck is, of course, a Jackson & Sharp. Near the truck is a railway air compressor, shown in detail. This device is the New York straight air brake, in use also on the Intramural.

At the center of the truck exhibit there is on Wharton track work a Robinson radial truck, holding two W. P. 50's. This exhibit is to be operated. While the truck and motor exhibit is interesting to the practical electric railway man, the center piece of the exhibit will attract the attention as well of the man contemplating a change to electricity. For upon a stand here is represented, to the minutest detail, the wiring and frame of an electric motor car. The frame motor mounting is represented diagrammatically in veneer, while the main cables, trolley pole, wheel and stand, the lamp sockets, controller, main switches, lightning arrester, kicking coil, resistance and minor wiring is all down in the actual. Upon the other side, south, the standard type of railway overhead material is shown, to the last insulator. Surmounting all is the trolley pole, as a banner proclaiming the nature of the exhibit. An electric headlight, and signal lights, red and green, are shown here, as well as upon the Robinson radial truck.

The exhibit is such as the General Electric would be expected to make, and does great credit to every department represented.



LIEUT. E. J. SPENCER,
Special Exposition Agent for the
General Electric.



W. D. YOUNG,
General Electric.

The gentleman in charge of this installation is W. D. Young, B. S. (Cornell) who is from the Schenectady factory.

The other railway displays of the General Electric will be upon the yet-to-be-built exhibit track, which we hope to describe at some later date.

C. DENSMORE WYMAN, for so many years vice-president of the Central Park, North & East River Railway, of New York, but since the consolidation of that line with the syndicate lines, general manager of the Electric Launch & Navigation Company, of New York, is now established in his very pleasant offices in the southeast corner of the gallery of Electricity Building. The company of which Mr. Wyman is manager have the concession for the operation of electric launches on the lagoons in the Fair grounds, and have a fleet of fifty now running and he will be pleased to receive at his office the calls of his many friends in the street railway and rapid transit world. As president of the New York State Street Railway Association Mr. Wyman's fame is more familiar in the west than his face, and it may be said that his western residence has changed neither the former nor the latter. After next November Mr. Wyman expects to return to street railway circles, and from some opportunities offering it is not unlikely he will remain in the west.

"I am much pleased with your city and with its magnificent Exposition," said Mr. Wyman to a REVIEW man, "and as well pleased with the west and its people. My street railway experience has given me the needed experience to manage water transportation, and our present system of electrically propelled boats, as well as the electrical exhibits shown in the Fair, gives me an opportunity of studying the subject of electric traction in all its interesting details. I anticipate great pleasure in exhibiting to my railroad friends our unique and novel system, and one which is not only a present splendid success, but is undoubtedly destined to become deservedly popular upon the waterways of this country."



DETAIL FROM ELECTRICITY BUILDING.

PULLMAN's palace street cars are ranged along next to the palace steam cars. Several designs in side entrance and double deckers are displayed, and the Patton motor is being placed in a double decker. The cars are all in dark mahogany, and beautiful specimens of the car builder's art.

THE FIRST CABLE CAR.

MOST interesting to cable men of any exhibit in the Transportation Building, is the original Hallidie car in the California Wire Rope Company's display. The original grip, a Clay street trailer, and a section the first conduit, challenge the admiration of the cablemen and the wonder of the lay citizens.

The rail is light T set on cast iron yokes, spaced to four feet. While the spaces between the bottom and part of the sides are walled with sheet iron, the upper portion of the sides and the top are protected by timber. The tube thus formed is about 22 inches deep and 14 wide. The slot opening is seven-eighths of an inch wide, or more, and set close to the right side of the conduit.

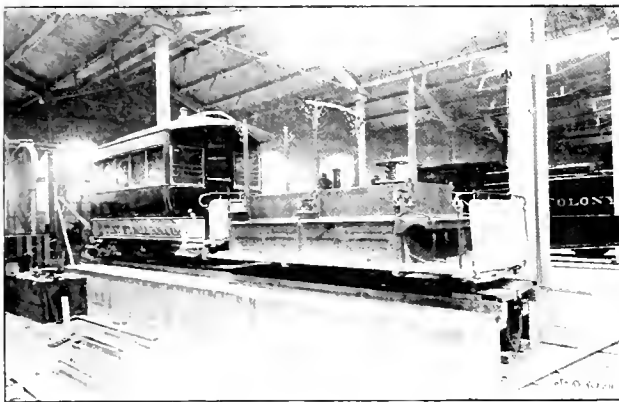

THE FIRST CABLE TRAIN.

The grip car is about 12 feet long and the trailer has perhaps, a 14-foot body.

The grip, which can be seen through the conduit, is made so that the center of the gripping jaws is in the center of the tube, and the slides holding the jaws work horizontally by means of a wedge attached to a vertical rod working up and down by means of a screw and nut in a hand wheel.

On the outside of the cars and conduits appear the later improvements in grips and levers substituted for the screw.

The whole affair is in marked contrast with Stephenson's new 33-foot Broadway cable exhibited in the same section.

BURTON'S ELEVATED ELECTRIC.

ON the west side of the Annex, rather obscured by large cattle cars, is a little elevated railroad 20 feet in length. On this structure is C. C. Burton's model of an elevated electric railway train 10 feet 6 inches long, intended for high speeds. The model is a beautiful piece of work in nickel plated steel and shows the method of driving to the best advantage. L. E. Holden, of Beloit, Wis., and G. M. Ludlow, of Elgin, Ill., are said to be interested financially in the patent. It is expected that a company will be formed to make the building of an experimental line assured.

NAVAL EXHIBITS IN TRANSPORTATION.

NAVAL exhibits in the Transportation Building will attract many of the curious visitors who enter the Golden Gate. A model of an English man-of-war looms up on the south end of the main building, and boats, canoes, caravals, junks, and catamarans go to show that the sailors' life is not departed from the thoughts of mankind. The minor accessories of ship-building are shown in every detail, while glass cases contain complete models of every noted war ship and passenger steamer that floats.

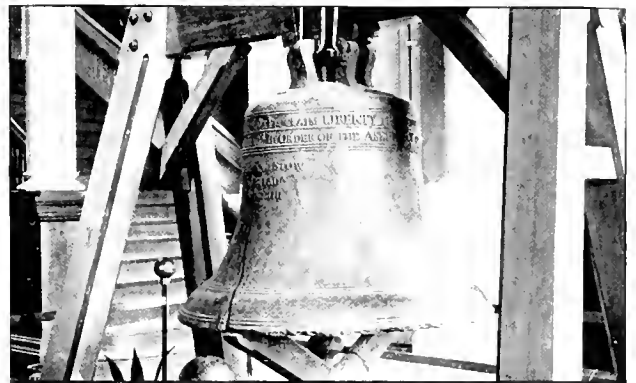

A MUCH VISITED EXHIBIT IN THE PENNSYLVANIA STATE BUILDING

PRIMITIVE TRANSPORTATION.

ELECTRICITY and steam will be offset and distinguished by a large number of displays of the primitive conveyances of Europe and America. One of the features of the gallery is a line of donkeys, "saddled and bridled and ready to start," if 'twere not



"SADDLED AND BRIDLED AND READY TO START."

for the previous removal of the motor and interior wiring of the animals. Although they are stuffed the careless visitor gives a start as he comes unexpectedly behind those swift and treacherous little heels.

THE FUEL ECONOMIZER AT THE WORLD'S FAIR.

THERE is now in established operation at the Intramural power house, Jackson Park, a device which is attracting the attention of every engineer and power user who visits this beautiful and suggestive modern steam plant and electric power house of the General Electric Company.

The device in question is the Green Fuel Economizer, designed and built by the Fuel Economizer Company, of Matteawan, New York. This method of fuel economy is not, as many suppose, a new and untried affair, since gold medals have been awarded it at fourteen industrial expositions, beginning with the London fair of 1851.

Fuel economy has of late years, however, been a more burning subject, if our readers will pardon the pun, since better boiler construction, a growing scarceness of fuel, and a wider appreciation of the advantages of all econ-

omizing of which is herewith presented, it will be clear enough to state that the economizing plant here consists of 704 pipes divided as to number on either side of the stack and directly back of the boilers. Each pipe is 9 feet high and $4\frac{1}{2}$ inches in diameter, thus holding eight gallons of water. The pipes are vertically cast in order to give the greatest strength and obviate blow holes, which would be fatal to the end desired of superheating the water. Many similar devices have been made using the ordinarily cast tubes, but in each case blow holes or more serious trouble has ended their usefulness. The fuel economizers' pipes, however, are as remarked, vertically cast, five-sixteenths of an inch thick and tested to 350 pounds pressure per square inch, and to 3,000 pounds per square inch bursting pressure. This actually precludes the possibility of accident, as the circumstances will not permit the bursting pressure.

The Babcock & Wilcox boilers in use at the Intramural power house are of 3,000-horse-power, and the gases passed

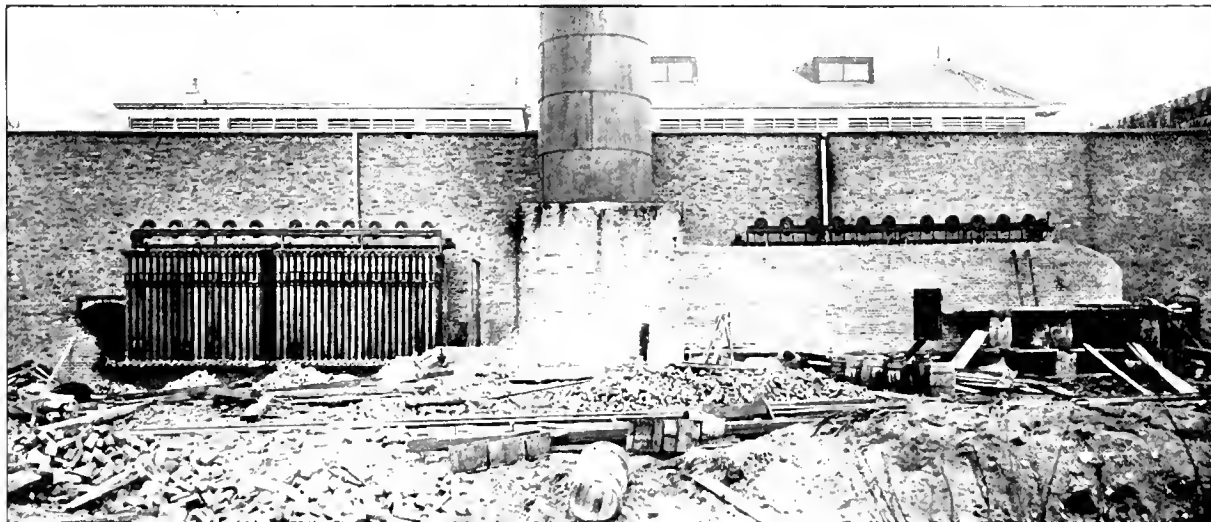

FUEL ECONOMIZER AT WORLD'S FAIR, FROM PHOTOGRAPH TAKEN DURING CONSTRUCTION, SHOWING ONE SET OF PIPES EXPOSED.

omy in larger plants has become a factor in power use. To these causes the power users of the west have to return thanks for the better dividends resultant from greater economy in the power room.

The fuel economizing apparatus, as has been hinted, is now for the first time being vigorously pushed in the west, because the western power user is becoming more numerous and the power used is becoming greater, thus demanding more modern machinery and better methods.

The very simplicity of the apparatus seems to argue for its more extended use, consisting as it does of a series of connected upright pipes holding the boiler feed water. These pipes are placed in some convenient place where the waste but heated gases from the furnace may pass among them, heating the water and then passing to the stack, having the last redeemable portion of heating energy wrested from it before dissipation in the atmosphere.

To describe the Intramural economizing plant, a good

to the bottom of the stack through a center vent. This vent has however, been closed, leading the gases through two widely separated ports to a chamber immediately back of the flue where the two stands of 352 pipes are located. Here the heated gases and air come in immediate and constant contact with each pipe, and after doing its uttermost duty here passes into the outer air utterly useless, as it should be.

The constant circulation of the heated gases among the pipes filled with feed water accomplishes two, and is capable of three, important functions. First, as heater and purifier, the temperature of the feed water is raised to a proved average of 259° Fahrenheit, the water entering at 90°. Cases are on record of a much higher average. Naturally any sedimentary matter settles to the bottom of the tubes and is easily blown, scraped or washed out as occasion or condition of the water may require. Secondly, there is a constant supply of water heated above boiling point for constant use. The third and possible

use of the economizer is one that will touch the street railway man in particular, and makes it peculiarly applicable to the wants of the class of power users included among cable and electric railway men, as it holds always in reserve a large supply of water at the evaporative point ready for immediate delivery to the boilers. For instance after the rush trip of the morning the engineer at the railway power house banks his fire and prepares for the usual business of the middle part of the day. At three o'clock a storm may rise and orders come from the office for more power and powerful quick. The result is that steam is crowded, to the waste of fuel, cost of machinery and delay in time. With the economizer the feed valve may be closed after the rush time which, when sudden demands come, may be opened giving sufficient steam for the heavy draft. It is with this idea that the Brooklyn City Railway has ordered, and is now having

world. Constant improvement has been made in the construction of the economizer, to keep pace with the advance in other lines, although the original simplicity and effectiveness of action has always been retained. The economizer is especially adapted to compound condensing engines and improving types. When the gases leave the boiler by the top flue, as in the Heine type, the economizers are placed directly over the boiler, thus saving the floor space.

The American street railways using the economizer are, so far, the Brooklyn City, the Montreal Street Railway Company and the Intramural at Jackson Park.

The economizer may be seen in operation at Section 25, Column K, 22, Machinery Hall, where its parts are displayed and its advantages related by the Exposition representatives of the firms, Stanley Green and B. Pearson.

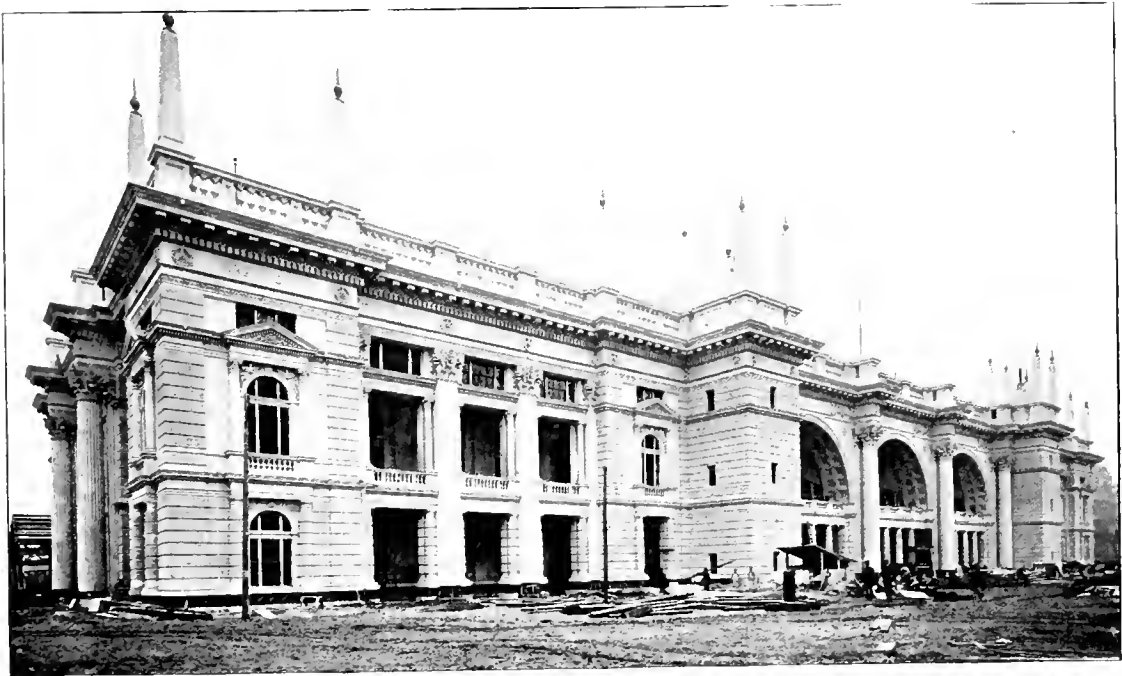

GRAND TERMINAL RAILWAY STATION AT WORLD'S FAIR.

installed, a plant of 6,000 pipes for use on 15,000-horse-power boilers.

The chief claims as to construction made by the company are broadly three. First, whatever the construction of the boiler the economizer may be applied, its saving capacity being from 13 to 25 per cent of fuel. Second, the vertical casting in dry sand molds, and the use of Green's conical lid joint, insure perfect safety. Third, cleanliness; as each economizer is provided with scrapers running the whole length of the pipe and kept continually working up and down geared to some convenient shaft, or to a small engine provided by the firm. An improved automatic clutch reverses the action of the scrapers. The economizer is universally recognized in Europe by the engineering authorities and government inspectors as much as the boiler is in this country. It is already applied to 150,000 boilers throughout the

THE GRAND TERMINAL STATION.

THIS magnificent building is one of the last completed, and lies directly south of the Transportation Building, with the Administration Building to the east, and the train sheds to the west, where the extensive terminal tracks are. Along the outside cornices appear the names of all the great railroad cities of the country.

The trunk and suburban lines entering Chicago are now running excursion trains direct to the grounds and using the Terminal station which is one of the finest and best appointed depots in the world, and cost \$250,000. There are thirty-five tracks in the train sheds and arrangements are all perfected for the rapid handling of business. The ladies' parlors and the restaurants are beautifully furnished,

THE CHAS. A. SCHIEREN & COMPANY EXHIBIT.

THE long horned bovine that has made the Schieren sign for so many years is not absent from the World's Fair exhibit of that enterprising company, which is constantly remarked by the throng which passes and repasses section D, space 3, Electricity Building.

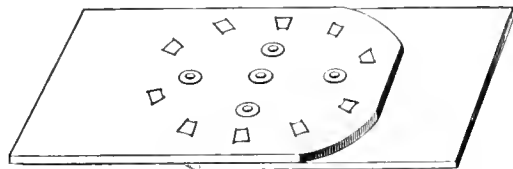

NO. 1.—ENGLISH BELT OF 1830.

The exterior of the booth is a pavilion form of the Greek temple, made of leather link, which gives an effect of artistic merit as well as of advertising value.

Inside the pavilion are rolls of belting for electric work

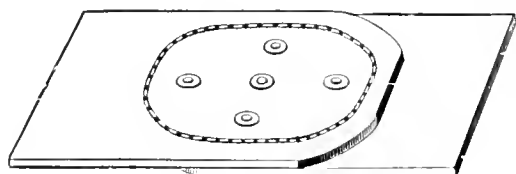

NO. 2.—ENGLISH BELT OF 1840.

set upon their ends, lying upon their sides and standing on each other in profusion. Among the most interesting sights is a case of curiosities in the belt line probably not elsewhere equaled. Herein contained are forty

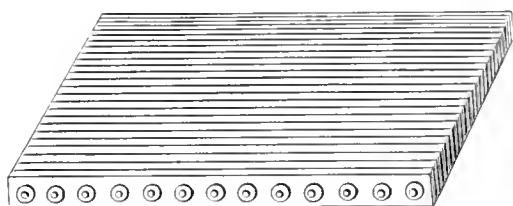

NO. 3.—ENGLISH EDGE CUT—OLD STYLE.

specimens, of the belts of all ages some of which, through the kindness of Mr. Schieren we are able to illustrate.

Number 1 shows the original old style belt of 1830, before high speed engines were called up to generate

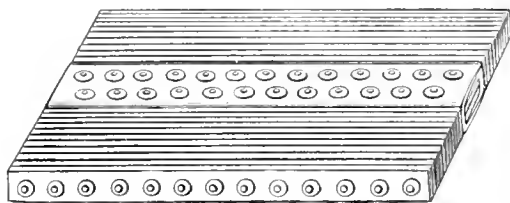

NO. 4.—ENGLISH STEEL BOLTED BELT.

electricity. Its joints are laced and riveted and no cement was used. This specimen is English.

Number 2 is the old style belt made in 1840, with riveted and sewed joints. It is also English, you know.

Number 3 is an improvement on the other styles and marks the era of heavier service. It is the old style of edge cut leather belt of English make put together with steel bolts. Number 4 is English made after the same

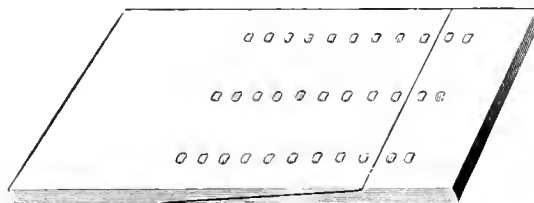

NO. 5.—ENGLISH LACED JOINT.

style. Here strips of leather are joined edgewise with steel bolts and flexible center joint. Number 5 is the English laced joint. It is also cemented while Number 6 is a modern cemented and riveted short lap joint. Num-

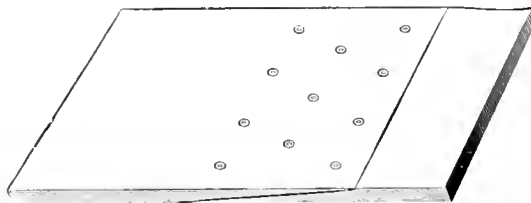

NO. 6.—MODERN SHORT LAP JOINT.

ber 7 is a wax thread and riveted joint of American manufacture, while 8 shows a dovetail joint of Yankee skill.

Number 9 is a section of electric belting from a double belt with endless copper wire screws. It contains a coat of

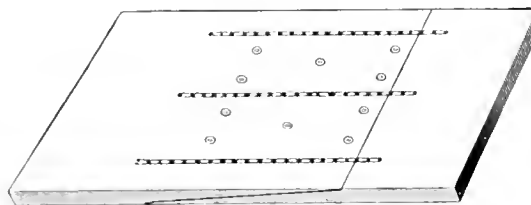

NO. 7.—AMERICAN RIVETED JOINT.

electric stuffing. Number 10 is the patented form of the electric perforated belt familiar to us.

Number 11 is a peculiar link belt with bolt heads placed inside of capsules to give transverse pliability. It is of English make.

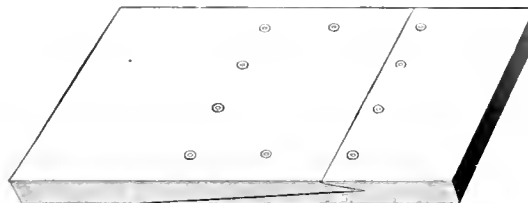

NO. 8.—AMERICAN DOVETAIL JOINT.

Another curious American specimen is number 12, which is a patent round link belt made in 1886. Number 13 is an American patent joint leather link belt, while number 14 is a piece of the patent compressed leather link belt so familiar to Schieren's friends.

The lack of space prevented of much more extended exhibit of belt curiosities, but it is safe to say that a more unique collection of belting curios does not exist any-

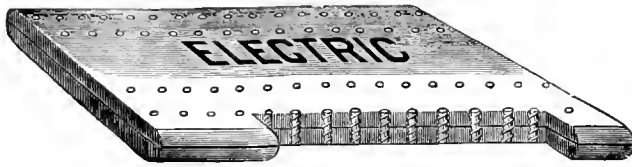

NO. 9.—ELECTRIC BELT.

where. To the thoughtful ones this collection is something more than a number of pieces of leather joined together. It represents an era in power transmission, a

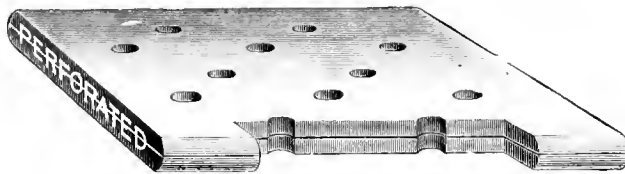

NO. 10.—ELECTRIC PERFORATED BELT.

change for the better compelled by the tremendous progress of the last thirty years in transmission of power and emphasises the anxiom before reported in this magazine

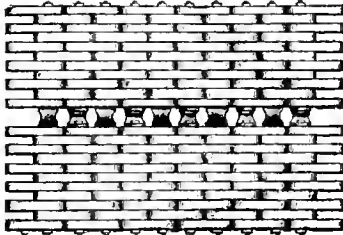

NO. 11.—PECULIAR ENGLISH LINK.

that improvement is the order of our progressive age. The entire display including as it does types of the very latest in belt manufacture, especially for electric uses, is ni

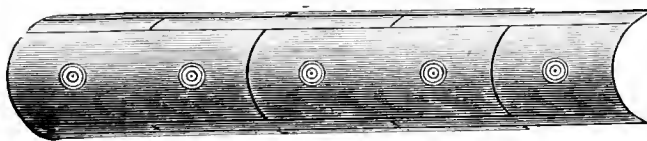

NO. 12.—PATENT ROUND LINK—AMERICAN.

every way worthy of the Schieren Company, whose products have earned an enviable record at home and abroad. Mention should not be omitted of the jumbo belt which,

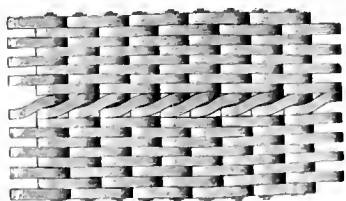

NO. 13.—AMERICAN PATENT JOINT LEATHER LINK.

like a mighty sentinel, towers above the heads of visitors. It is a three-ply, 200 feet long by 96 inches wide, and weighs 6,000 pounds. Four hundred and fifty cattle

gave up their lives and hides to be thus represented at the World's Fair, and the services of 12 men were required to make it. An account of its magnitude, shipment to

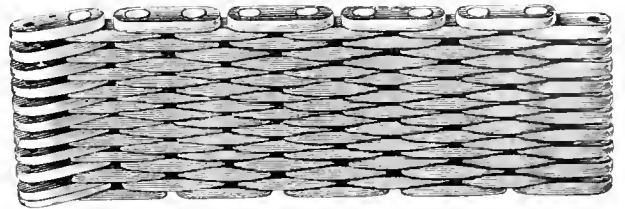

NO. 14.—PATENT COMPRESSED LEATHER LINK.

Chicago was on a flat car, as it could not be loaded into a box car.

HALE & KILBURN'S EXHIBIT.

ONE of the most artistic and beautiful exhibitions of industrial art shown anywhere in Jackson Park is the monument to the taste and workmanship of Hale & Kilburn, the car seat manufacturers of Philadelphia. The space occupied is catalogued as D, 6, Transportation Building, and here arranged on a carpeted floor are specimens of the handiwork of Hale & Kilburn. At the south end of the space is a triple pedestal, bearing each a car seat.

The pedestal itself bears description, as it undoubtedly attracts more attention than anything else in the immediate area. It is painted beautifully in ivory, and a panel in each of the three parts represents respectively Decoration, Woodwork, and Upholstery. The three figures are the creations of Designer Meyer, of the Hale & Kilburn factory. Mr. Meyer is an artist of no mean talent and education, as his work testifies. The figures are beautifully done in oil and typify the aesthetics of the car seat and car decorating business. In fact, to the cultivated taste it is a matter of pleasant surprise that so high a degree of art is lavished upon what have been in times past considered as beneath the attention of the true artist. Now both poetry and art find their fullest appreciation in the ranks of commerce, and commercial art as well as commercial journalism is rising to a point where it is recognized in the best circles of their respective professions. At the middle of each pedestal and above the designs appear the legends New York, Philadelphia and Chicago, showing the repositories and branch houses of the firm of Hale & Kilburn, and surmounting all is the name and superscription of the firm. The design is handsome and the work such as Hale & Kilburn are expected to show.

WALWORTH POLE EXHIBIT.

IN connection with the General Electric exhibit, the Walworth Manufacturing Company has several different types of its well known poles for various light and railway purposes. These are plainly labeled, and attract the glances of the various light and railway supply buyers who come into the building.

THE JONES CARS.

IN "street railway row"—which being interpreted is aisle L—on the north side thereof and about midway down the Transportation annex, the visiting brother may see two handsome and workmanlike exhibits of the skill of J. M. Jones' Sons, of Troy, New York.

This attractive and beautiful display of the car builder's and car decorator's skill consists of two cars either of

The advantages claimed for this car door are three. Easy opening and shutting of the door, easy and safe exit and ample ingress and egress for the crowd.

The interior of the car is beautifully finished in rich mahogany, hand carved; the panels on the doors and partitions being so arranged that a decided inlaid effect is obtained.

The ceilings are of quartered oak decorated in gold and colors. The deck glass is a white design on blue, with

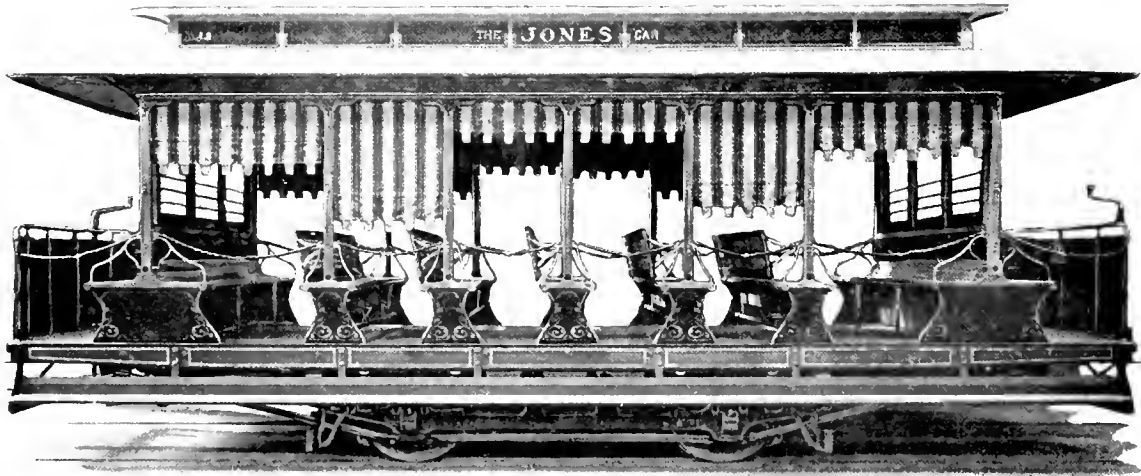

JONES' NINE SEAT OPEN CAR AT WORLD'S FAIR

which is sufficient to show that Jones' Sons are not only pioneer car builders but pioneers in every improvement in construction and decoration.

THE CLOSED CAR

is an 18-foot body, six-window type of the standard make, wired and framed for electric service. It is mounted on a

ample room for the display of decorative, fancy and sanitary comforts since there are five large and two small ventilators on each side. The Wilson ventilator adjuster is in use on this car, greatly simplifying the trouble of regulating the 'fresh air fund' by a single action. The three center vents on each side bear the words, "The Jones Car." The end vents are similarly lettered.

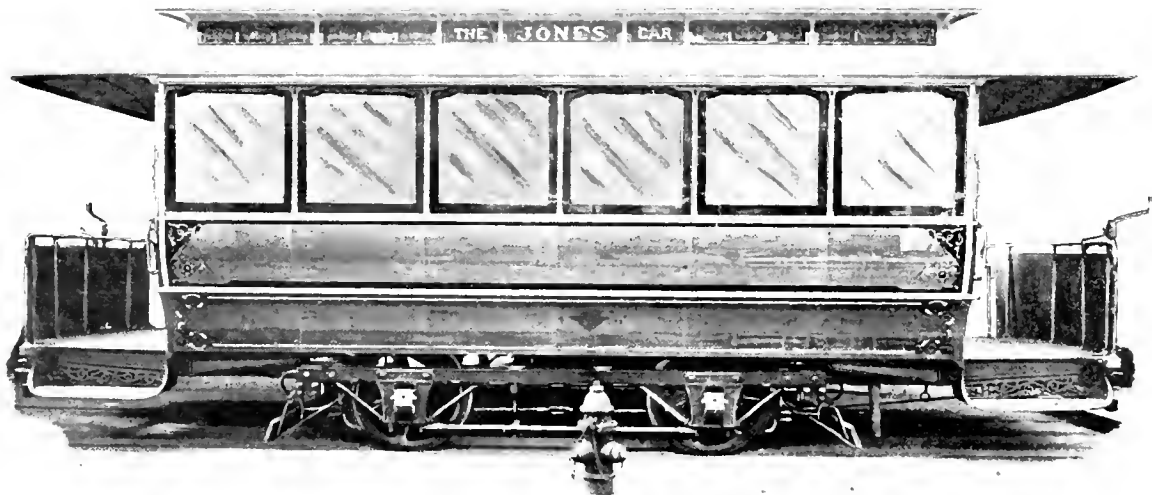

JONES' CLOSED CAR AT WORLD'S FAIR.

Taylor electric truck, which is an interesting joint exhibit.

One of the prominent features of this car is the new double door, designed by the Jones' Company. This door is opened or closed by the opening or closing of either half, the action being transmitted to the other half.

Instead of paneled foot boards the seats are supported by maple spindles with a view to electric heating. The seats and backs are upholstered in blue plush and the sashes are fitted with neat window casings and enclose French plate glass.

The main body panel of the car is finished in blue with gold striping and designs. The bottom panel harmonizes in orange.

The finish around the windows and the pillars on the outside is the natural ash varnished, with designs on the top and bottom. The whole effect outside and in is beautifully congruous and effective as well as durable.

The platforms are large and roomy, facilitating the handling of the crowds. The trimmings are of solid bronze polished, throughout. The car is fitted with radial draw bars, malleable iron buffers. Wilson's improved sand box. Jones' ratchet brake handle, Burrow's car shades, Jones' window strips, foot gongs and signal bells

THE OPEN CAR.

has five reversible seats and four back-to-back seats. The ends are closed and the type standard. This car is also electrically wired and is mounted upon a Bemis truck.

The design and finish of the open car is in no wise inferior to the one above described. The interior is finished in maple with cherry mouldings; the backs of the reversible seats are spindled in maple.

The panels of the back-to-back seats are in cherry. The pillars, arches and seats are finished in the natural wood, varnished, and present a neat appearance.

Three drop sashes in either end of the car are fitted with French plate glass. This is a noticeable feature of the car. Each side of the car has a covered link chain running from pillar to pillar to protect passengers by necessitating their getting on and off at the proper side of the car. A snap in the center disjoins the chain when necessary. Handsome brown roller curtains running in guides adjust themselves to any desired height, the guides preventing them from flapping in the wind. The various adjustments of the window shades give the car a most artistic and pleasing appearance to the passer by. The



J. M. JONES,
In charge of Exhibit.

seven ventilators on each side have a white design on an orange ground. The center vents as in the closed car bear the names of the makers. A very clean effect is produced in this car by the decorated white birch ceiling.

The panels are painted a medium tan with gold designs having black edging. The sill is painted olive, striped. All the trimmings are in solid bronze and the minor fittings as in the closed car are of the best.

Taking the two cars together the general effect is at once striking and each car separately is a complete encyclopedia of modern car building. No street railway man can afford to pass L, North 14, 15 without stopping to examine the vehicles and talk to J. M. Jones, who has them in charge.

TRANSIT A LA GONDOLA.

BY no means among the least attractive sights at the Fair are the fleet of fifty gondolas, imported with their swarthy gondoliers from Venice. Propelled by two oarsmen who work standing and pushing



"PROPELLED BY TWO OARSMEN."

the oar from them, the gayly decorated craft glide noiselessly along the lagoons and afford a pleasant rest for the weary traveler. The charge is 50 cents per passenger, and the boats carry from three up to a dozen persons.

ELEVATED RAILROAD BRIDGE.

ONE of the prettiest pieces of construction to be found on the Alley L in Chicago, is their steel truss bridge which spans the numerous tracks of the Illinois Central railroad at Sixty-third street, near the main entrance to the Exposition grounds. As the Central



"THE SPAN IS 229 FEET LONG."

tracks were recently raised to allow the electric line of the City Railway to pass below, the conditions required a high bridge. The span is 229 feet long and 30 feet in height at the middle. It carries two tracks and is 21 feet in the clear above the Illinois Central.

THE Ultra Law and Order Society of Pittsburg recently created a sensation by a threat to arrest a large number of car drivers for violation of the Sunday blue law of 1794. No action has, however, yet been taken.

A HANDSOME EXHIBIT.

DIRECTLY adjoining the open car of the Lamokin Car Company which was described last month is a closed car of the same make that has attracted no less attention than its open brother.

The car is of the closed vestibuled pattern, as may be seen by the accompanying engraving, and stands in pleasing distinction by the side of the open pattern and against the huge bulk of the Lake Shore freight carriers.

The body length of the vehicle is 18 feet, with 4-foot 3-inch vestibules. The roof is of the steam car pattern and runs the full length of the car. In the roof are fourteen ventilators, seven on either side in the deck. These ventilators are beautifully figured in frosted glass. The ceiling is done in antique oak, handsomely and gen-

erously embossed with silver settings. The interior is finished in antique quartered oak, while the solid oak doors are fitted with rich panels with deep sash. The seats are in keeping with the wood work and are upholstered in old gold plush with window drapings to match. Spring roller curtains and French plate glass windows, with beveled edge with ground stripe along the edge add to the inside appearance and the outside ensemble.



GEO. E. PRATT,

General Sales Agent in charge
Lamokin Exhibit at World's Fair.

The end doors are placed at one side so as to allow free access for the prospective passengers, from the thin young man who runs to catch the car to the fat old lady who always gets on after the platform is full. The wide and roomy vestibules afford unobstructed entrance for passengers. The vestibules at either end have one side only for entrance, as the car is intended for loop tracks. In the vestibule the large windows drop down out of sight. The trolley observation window in the roof of the vestibule affords the conductor a clear view of the trolley and easy access to adjust the trolley wheel should it "jump the trolley." By this means it is unnecessary to open the front window.

The trimmings of the car are all in solid bronze and assist in giving the idea of honesty and thoroughness so characteristic of Lamokin cars.

The car lighting is attained by means of two center electric electroliers, each bearing four lamps, handsomely shaded. Each vestibule has one lamp, which not only illuminates the vestibule, but at the same time reflects light through the signal wing. The cars will present a brilliant after-night appearance.

The car flooring is corrugated, sloping toward the doors and the traps, and all wiring is arranged for the Westinghouse.

The decoration of the car is very artistic. Silver bronze is the color on the main panels and either end, and at both ends of the side panels peacock feathers are

beautifully arranged. The center piece upon one side is the coat-of-arms of Pennsylvania, and upon the other that of Illinois, both entwined with the national arms. The lower panels are painted in ivory, and the whole car striped with gold and deep red. Upon the ends of the vestibules the keystone emblem is well displayed, without being obtrusive, together with the monogram of the builders.

Electric heaters of the Cochran patent are arranged directly below the seat rail. The car is equipped with radial bars, lever brake-handle, signal gong, bells and headlight.

Both open and closed cars are in the latest pattern and best work of the superintendent of the Lamokin Works, H. C. Cochran, and certainly reflect great credit upon their author. McGuire's truck, standard guage, of the "Columbian" pattern, and 30-inch McGuire wheels are under the car, giving a joint exhibit with Lamokin.

The well-known excellence of this truck eminently fits it to form an essential part of this attractive exhibit. The truck is one selected at random from among the hundreds being constantly manufactured, and is superior to its numerous brothers of this company's make only in the artistic work of the painter, for it is finished in a rich mahogany color, gracefully striped with gold, and present in ga decidedly light and graceful appearance. It is already sold, indeed it had been on exhibit but a few days, when the extensive car builders of Germany, Messrs. Van Der Zypfen & Charlier, saw it and at once made a flattering offer, which, when the Fair is closed, will send it to its future home on the Rhine. It will be used there for exhibit purposes as a high standard of the trucks adopted in America, and doubtless will be the occasion of many orders as electrics become better known and adopted on the continent.

FETE DAYS.

The following is a list of special fete days, as arranged up to date by the Committee on Ceremonies:

Germany, June 15.	Nicaragua, Sept. 1.
Nebraska, June 15.	New York, Sept. 4.
Massachusetts, June 17.	Brazil, Sept. 7.
New Hampshire, June 21.	California, Sept. 9.
France, July 14.	Maryland, Sept. 12.
Utah, July 24.	Michigan, Aug. 13-14.
Liberia, July 26.	Kansas, Aug. 15.
Commercial Travelers, July 26.	Colorado, Sept. 19.
I. O. Foresters, Aug. 12.	Montana, Sept. 20.
Haiti, Aug. 16.	Sons of America, Sept. 20.
Colored People, Aug. 25.	Iowa, Sept. 21.
North Carolina, Aug. 18.	Rhode Island, Oct. 5.
Austria, Aug. 18.	Spain, Oct. 12.
The Netherlands, Aug. 31.	Italian Societies, Oct. 12.
	Minnesota, Oct. 13.

W. J. RICHARDSON, secretary of the American Street Railway Association spent a day in the World's Fair city on his way to Denver to confer with President Longstreet on matters pertaining to the next convention. Mrs. Richardson and daughter accompanied him.

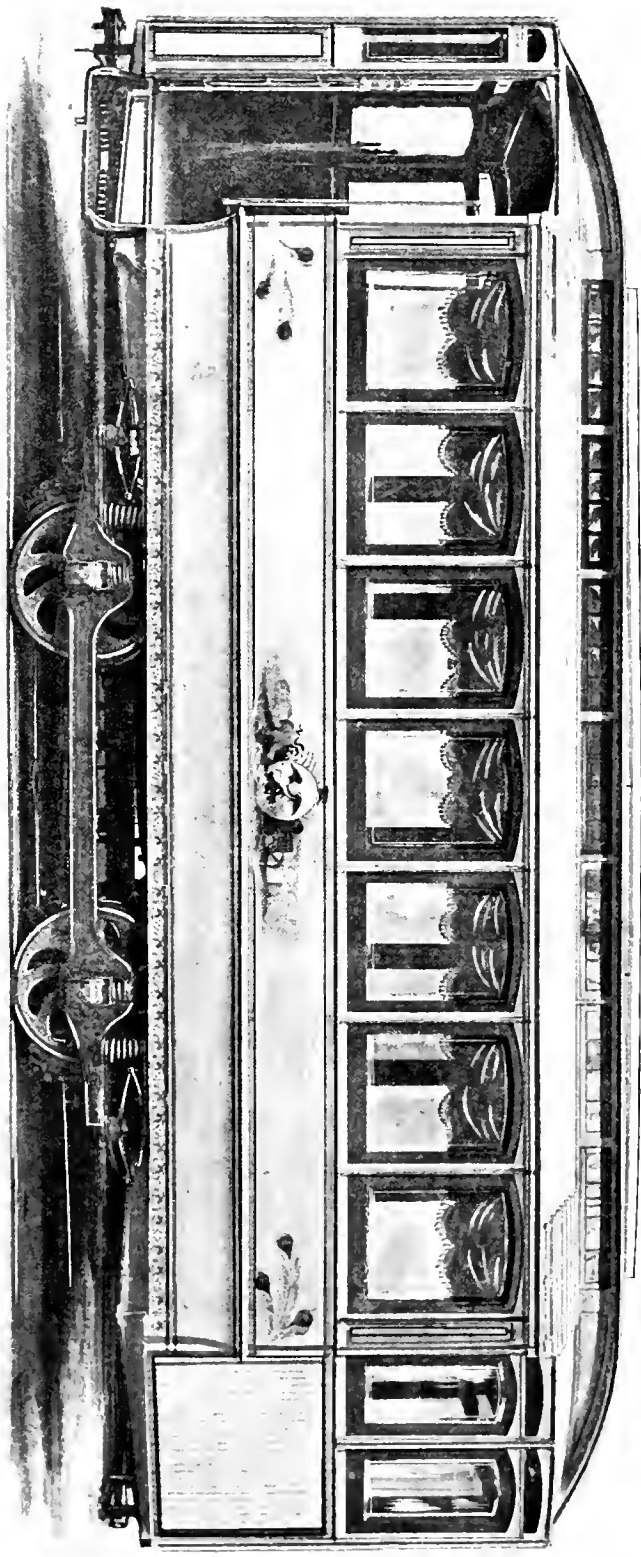

A HANDSOME EXHIBIT AT THE WORLD'S FAIR.

CAR BUILT BY THE
LAMOKIN CAR WORKS,
 E. H. WILSON & CO., PROPRIETORS
 PHILADELPHIA, PENN.

TRUCK BUILT BY THE
MCGUIRE MANUFACTURING COMPANY
 CHICAGO.
 STYLE: "THE COLUMBIAN TRUCK"



GROUNDING CIRCUITS AND FIRE INSURANCE.

OWING to the fact that insurance companies and others of the powers that be, have in some cases raised objections to the selling of power from railway circuits, it is fitting that we should present in these columns a few arguments in favor of such practice. The objections raised are of course, based on the fact that one side of railway circuits is grounded and this is not in accordance with the time honored theory that no grounded circuits should be allowed in buildings. While we do not doubt the advisability of this rule at the time it was adopted, we think that the time is past when it should, without modification, be insisted on. In the early days of electric lighting the best insulation obtainable was poor compared to that in use today, and what is still more important, the electrical fraternity had not been educated up to the necessity of care in running circuits. Today the case is different, and there is no doubt but that with the proper precautions inside wiring run from grounded circuits is perfectly safe. The danger lies not in the practice itself but in careless wiring, and it would therefore be much more reasonable for insurance companies to insist on proper installation and then take such risks, than it is for them to prohibit grounded circuits entirely.

To assert that it is impossible to make a 500 volt grounded circuit safe from danger of fire, is to assert that it is impossible to insulate against 500 volts, the absurdity of which latter assertion will be admitted by all electricians. That it is possible to use 500 volt non-grounded circuits inside of buildings and have them perfectly safe, even with the most ordinary precautions, was long ago admitted by all concerned. Why then is it impossible to make a grounded circuit safe even with extraordinary precautions?

To make the matter plainer let us examine the conditions prevailing with grounded and non-grounded circuits.

When two wires of a non-grounded circuit enter a building an attempt is made to keep them insulated from each other, and from the ground. A short circuit can then be brought on in two ways. By a direct leak from one wire to the other or by a leak from both wires to earth.

When the wire of a grounded circuit enters a building it is simply a question of insulating that wire from the ground. The very simplicity of this problem is a great argument in favor of such practice. The wireman has but one idea to be kept before his mind and that is that this single wire must be thoroughly insulated from everything surrounding it. With insulation heavy enough to make up for the fact that one side of the circuit is grounded there can be no logical reason why such circuits should not be allowed.

So far we have argued on the assumption that there is no precedent for the practice of grounding. However, on looking at the plants of the Edison Companies in the large eastern cities and in Europe we find that the neutral

wire is purposely grounded. If this is safe with 110 volts it is simply a question of increased insulation to make it safe with 500 volts.

There are in operation today thousands of electric cars having concealed wiring. The conditions are vastly more trying than any that are to be found in buildings where the wires can be kept dry and in sight. There are also in operation thousands of miles of overhead railway wires both trolley and feed. These are out of doors and have to stand not only inclement weather but great mechanical strain as well. In view of these facts there is no doubt as to the possibility and practicability of making such wiring safe. If any serious difficulty had been experienced in the past as to maintaining the insulation of wires on railway circuits it would certainly have been discovered long ago.

Another absurdity is the rule allowing grounded circuits to be used for light and power purposes in cars, car barns, and power houses and in no other buildings. This forbids a practice while virtually admitting the safety of it. Wiring that is safe inside a car or a car barn ought to be much safer in the majority of buildings. There is no doubt that such wiring is dangerous unless installed in accordance with strict rules. The insulation should be very heavy and contact of wires with anything but supports of good insulating material should be strictly forbidden.

Both the Omaha and the Sioux City Street Railway Companies, mentioned in this connection in a previous article, bear testimony that the practice has not resulted in a single fire and they cannot see how it can be dangerous when the wiring is properly done.

Mr. Garton, of the Garton-Daniels Electric Company, has had experience with the selling of light and power from trolley circuits in several cities and has never known any trouble to arise from such practice. He cites a case which came to his knowledge, where the superintendent of a road had his house lighted from a concealed circuit of bare wire, installed by a brilliant lineman, acting on the supposition, that as the trolley wire was bare, all others should be. The circuit remained some time before it was discovered. The example set by that lineman is not exactly one to be followed, but the incident shows, not only that a kind providence watches over the ignorant, but that 500 volt grounded circuits are not so terribly dangerous as some suppose.

Professor F. B. Badt, manager of the Mining Department of the General Electric Company, Chicago, gives it as his opinion that with the proper precautions and for supplying the larger sized motors the practice is all right. For supplying a large number of small motors and lamps the difficulties of insulation which arise in the multiplicity of wires, through safety devices and through an arrangement of five lamps in series, are too great to make it safe. This is a matter, however, that limits itself, as very small 500 volt motors and large numbers of incandescent lamps on the series plan are objectionable in themselves and where there is a demand for a large number of small motors and incandescent lamps the lighting

companies generally run independent circuits. Where it is desired to run lights and small motors from railway circuits, Prof. Badt thinks that a motor transformer should be used, the secondary circuit of which would give a low pressure current with no ground connections. This would not only give better satisfaction in every way but prevent all possible objections on the ground of danger.

C. K. MacFadden, electrical engineer for Taylor, Goodhue & Ames, who has had a large experience with inside wiring says:—

"I believe the use of motors should not be restricted on 500 volt street railway circuits. I think that insurance laws which were framed prohibiting the use of motors and other electrical apparatus on grounded circuits were all right at the time, but inasmuch as there are hundreds of plants ready to furnish current from these circuits and are perfectly willing to do the best construction and installation work where such motors go in, that it is an unreasonable stand to take when their use is prohibited. I believe that on or near all 500 volt motors a notice should be placed warning all persons from handling these motors in any way and that unusual precautions should be taken when such motors are installed to put them on thoroughly insulated bases and foundations. Unusual precautions should be taken by the company furnishing current, in regard to lightning protection, and the grounded wire from the motor should be carried to a point where it could not be tampered with and there grounded in the most approved manner. I see no reason why a motor thus installed should in any way increase the fire risk."

C. F. Cook, engineer of the Westinghouse Electric & Manufacturing Company at Chicago, says:—

"In reply to your request for opinion on feasibility and safety from fire risk of operating stationary motors from the same generator or generators that are employed in street railway work, I would say:—that I believe the same can be operated in the manner above described with perfect safety, providing proper precautions are observed in installation. I should favor an all copper, independent circuit, from the power house to the motors to be operated. The motors should be set up in the very best possible manner. Each motor should be provided with a first-class lightning arrester in addition to switches, fuses, circuit breakers, etc., as ordinarily employed.

The wiring for the motor should be done in the best possible manner on glass or vitrified porcelain insulators, or insulating material of proper quality and form to give as good insulation as those named. The wires should be kept at a respectable distance from one another, say, ten inches, and perfectly free from all conducting material. Only the best motors should be used on this class of circuits, and the insulation of the fields and armatures should be carefully watched and kept at a high point. I should not recommend running the motors from the trolley wire as the ordinary construction man is too liable to take a water or gas pipe for return circuit, an extremely dangerous practice. Moreover, motors so operated and connected are always exposed to unnecessary strains in

operation, owing to the fluctuation of the voltage of trolley circuit."

We might add by way of explanation, that Mr. Cook's reason for advocating a metallic return back to the power station is that the ground return on so many roads is liable to be uncertain.

Chas. Wirt, of the Ansonia Electric Company, says that grounding has proved to be an advantage in the case of large three wire systems, both on the score of decreasing the number of troubles and preventing the occurrence of troubles during the night time in the absence of occupants. Safety from fire must be secured not by insistence on the use of any particular system or method, but by proper attention to insulation, the use of good material and above all intelligent use of fuses.

These are all as good authorities on the subject in hand as could be wished. They are not short sighted enough to advocate a policy that will result in ultimate harm to the trade. The qualifications with which their statements are made moreover, show that they have no desire to express themselves as in favor of anything that is not perfectly safe. They all agree on the main point in question, which is that the practice of running stationary motors and are lights from railway generators is perfectly safe under proper rules and restrictions. If the insurance companies and city authorities see fit to adopt special rules to govern inside wiring from railway circuits, well and good, but in the name of progress do not prohibit it entirely.

PARALLEL COUPLING WITH WATER POWER.

THE coupling of railway generators in multiple is the universal practice, but it is safe to say that no system in America is operating its generators under exactly similar conditions to those on the Watertown (N. Y.) Street Railway. The company owns two water power stations some distance apart, one of which is on an island. Previous to this spring each station had been used to supply a section of the road independent of the other. Each station had one 100 kilowatt Edison generator and the number of cars that could be operated on one division of the line was of course very limited. At one end of the road was a pleasure resort and it was very desirable to move a large number of cars from that point at one time. Edward A. Barber, the electrical and mechanical engineer of the company, decided to try a little experiment. He ran the necessary wires between the two stations and coupled the two wires in parallel, making the combined power of the two available at any point in the system. Many thought that by so coupling the machines, which were driven by different water wheels, they would not equalize the load properly, but such fears proved unfounded, as the dynamos run perfectly; it not even being necessary to have the voltage the same before they are thrown together.

The point of general interest is that the machines coupled, are successfully operating from different powers and under different conditions.

METAL TIES.

METAL ties are as a rule not favorably looked upon in this country. This is principally owing to their cost. If they are made light they quickly rust out, and if made heavy the cost is so much greater than wood that they are entirely out of the question. Another difficulty to be met with the metal tie is that of keeping the track in line and fastening them to the rails so that they will not rattle loose. The metal tie has so little elasticity that the experience of the Pennsylvania Railroad, which has tried a number of designs, is not at all favorable and nearly all the track so laid has been taken up. In the old country metal ties seem to have met with more favor. At least there are many more miles of track so laid than here. The life of metal ties is estimated by some prominent European engineers as about thirty years and that of wood as fifteen years.

CAR FLOORS AND CLEANLINESS.

HOW to keep car floors clean, is a question that has puzzled many a manager. It is a difficult problem to maintain a floor that will not be offensive to the more refined patrons of the road and at the same time carry all classes of people. Here is what a few prominent street railway managers have to say about it.

E. R. Sherman, superintendent of the Eighth Avenue Railway Company, of New York, says:—"We use wooden slats, about $\frac{5}{8}$ -inch thick and $\frac{5}{8}$ -inch apart, in sections of 3 feet square. These are taken out every day and thoroughly washed with hot water."

C. K. Durbin, of the Denver Tramway Company, replies:—"We use in the motor cars cocoa mats, and in our cable cars the Hartman steel wire mat. Our grip-cars were first fitted with wooden strips on the floors"

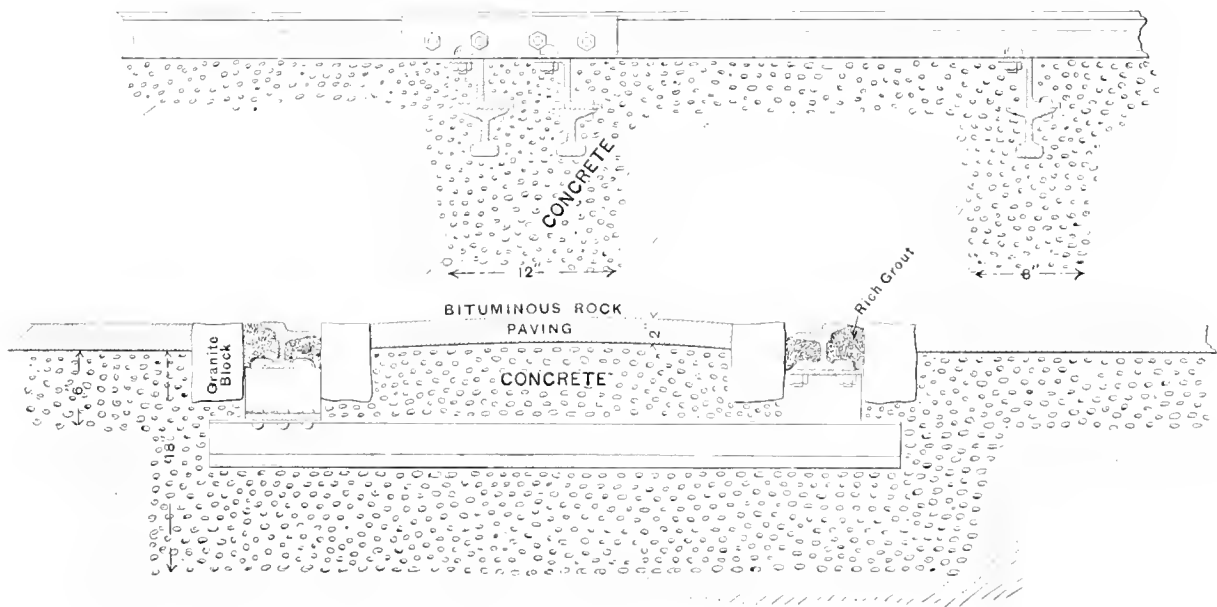

OLD T RAIL AS USED FOR TIES ON THE LOS ANGELES CONSOLIDATED ELECTRIC RAILWAY.

The metal tie would under these conditions be superior to wood if the first cost was not more than double. If this calculation is correct the metal tie is not to be thought of as a practical affair in this country.

The question of metal ties takes on a different aspect, however, when it is possible to use old rails. A method has been introduced on the Los Angeles Consolidated Electric Railway whereby the scrap T rails are made to do good service as sleepers. The accompanying illustrations show the plan of work. The chairs are Z bars riveted to the ties and bolted to the rails as indicated in the drawing. After the ties are in place and secured the trench underneath each one is filled with rich concrete, well tamped down, on top of which is put the concrete for pavement, which is made of bituminous lime rock or asphaltum. This makes an almost indestructible road-bed.

but on account of having to raise the trap-doors frequently to get at the grip, which is under the center of the car, the strips were very often broken off. We adopted the Hartman wire mat and found it very satisfactory, although somewhat cold in winter. We prefer the cocoa mats for the electric cars. They will soak up the moisture from snow and mud, keeping it from the motors. The mats are removed from the car every night, and the floor swept. Occasionally the floors are mopped—never washed out with a hose."

C. F. Holmes, general manager of the Grand Avenue Railway Company, of Kansas City, says:—"My experience with car floors has been to use as little water as possible on them. The cars are swept every trip, and in this way we have very few complaints from them. In using water, either hot or cold, it soaks into the wood and in warm weather there is a disagreeable odor from

them; it is also the same with the closed cars in winter when heated. In regard to matting, we are using rubber mats, but do not approve of them. I think that wooden strips running lengthwise of the car is about the simplest and best thing that can be used, as the car will dry out much quicker and can be swept easier than when using mats."

W. F. Kelly, of the Columbus Street Railway, has given the matter a good deal of attention, and sends the following as the result of his experience:—"Floors of all our motor cars are covered with slats running lengthwise of car, about $\frac{5}{8}$ of an inch wide, $\frac{1}{2}$ -inch thick, and spaced $\frac{5}{8}$ of an inch apart. In cleaning cars they are first swept out, and car floor wiped with coarse cloth or sacking, hot water and Pearline. This, of course, wears off paint, and we deem it advisable to paint floors frequently, in order to prevent rotting floor sills and plank. During the winter season it is a very difficult matter indeed, to keep car floors in a cleanly condition. The chief difficulty we experience during the summer is from the beasts who insist on spitting tobacco in every car they occupy. This can only be avoided by constant personal reminder to such persons, and this is a very unpleasant and difficult duty for a conductor. We believe, however, if street railway companies could secure conductors of sufficient courage to always insist on persons not spitting on car floors, that the practice could be entirely broken up, or at least limited to a very great extent."

E. G. Connette, general manager of the United Electric Railway, of Nashville, Tenn., says:—"The best method for cleaning the floor of an electric car is to sweep the floor, then take a mop and dip it in a bucket of cold water, wring all of the surplus water out of the mop, then mop the floor with it. Great care should be used in mopping car floors, and as little water used as possible, to avoid water dripping on the motors through the crack around the floor doors. The most convenient matting for car floors is made of wooden strips, joined together by either cotton or wire rope, which can be easily rolled and set aside out of the way while the floor is being cleaned. The utmost care should be observed when water is allowed to be used on the car floor, as an inexperienced or un instructed person might cause considerable damage to the machinery of the car by surplus water."

Chas. H. Smith, of the Scranton Traction Company, writes:—"We have never favored matting of any kind, except the square steel matting, in horse cars; in electric cars, no matting of any kind. We have a slat floor running lengthwise of car. This, when dirty, we have mopped out with hot water. The mop is an ordinary long handled house mop, and a large bucket of water is used for each car, the mop being used moderately wet, but not enough for water to run through on motors. We find but little trouble in keeping our cars looking fairly well."

THE Blue Line cable system of the Baltimore City Passenger railway was opened May 15. Speed will be nine and a half miles per hour.

A GRADE CLIMBER.

AN effective device for preventing the slipping of car wheels on steep grades has been invented by Dexter Hazard, of Marquette, Mich. It consists simply of a row of teeth bolted to the outside of the rail, which teeth are made to mesh with teeth on the car

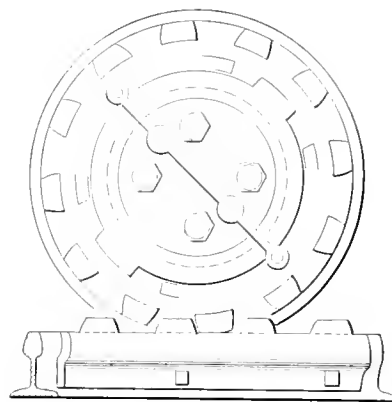

wheel, as shown in the illustrations. The line is thus made into a rack road at necessary points, without being troubled with the rack and pinion feature at points where it is not wanted. In order to make the cogs mesh at the

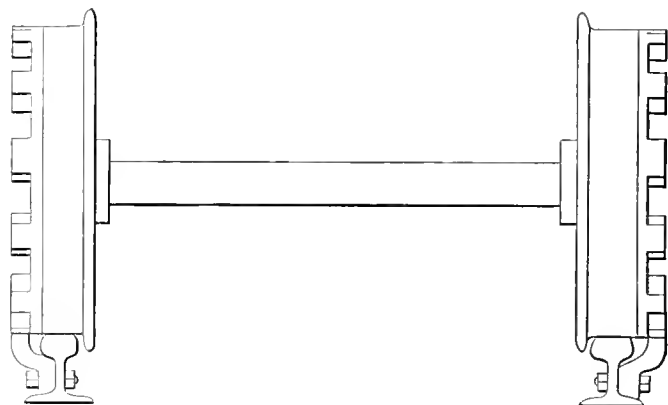

point where the cogs alongside of the rail begin, the plate carrying the cogs on the wheel is allowed a little movement, and the lost motion is taken up as soon as the wheels begin to slip on the grade. The invention was called out by the necessities of the road at Marquette.

THE statement that the Pennsylvania railroad is about to add electric motors to accelerate the speed of passenger trains over the mountains is denied by Superintendent Pitcairn.

THE electric line at Helena, Mon., has been extended out five miles to the University. Four years ago a single line of horse cars, on one branch of which a steam motor made occasional trips, constituted the entire system, which now reaches all parts of the city and several suburbs, with electric cars operated at short intervals and at high speed.

OVERHEAD COPPER FOR RETURN CIRCUITS.

BY JAS. RALEY.

I HAVE watched with interest the discussion going on in the REVIEW for some months past in regard to the efficiency of the different methods of obtaining a ground return, and I would like to call attention to one or two points that seem to be overlooked by many who are dealing with the problem. It seems to me that the running of overhead return feeders is not in the proper line of progress and should never be done except as a makeshift to provide a return until something better can be installed. The use of overhead feeders unless carried to an unheard of extreme is very much like trying to run a 40-horse-power dynamo with a 10-horse-power engine. I say this because we have in the rails (if properly bonded) conductors that will put to shame any economical or reasonable system of overhead feeders. A few cold figures will help make this plain. Suppose, as a very simple case, that we wish to deliver 500 amperes at a point a mile from the power station. To carry this current, with a loss of 12 per cent in the "overhead" part of the circuit at 500 volts pressure, will require the equivalent of four No. 00 feeders. Having disposed of the overhead lines the engineer next devotes his attention to the "return" portion of the circuit. Here quite a different problem is to be met, but after consideration, our engineer, who has imbibed freely all the current literature favoring the use of an overhead return, decides to install that system. He remembers the oft used phrase to the effect that as much copper should be used in the return as in the trolley feeders and gives a sigh of relief when he considers that he will not have to do any figuring on the return, but will simply have to run the same amount of wire as was used in the trolley feeders. Suddenly, however, the idea strikes him that 51 volts is an enormous loss to have in a return circuit, and that some change of plans must be made, or he will lose more power with his "modern" return than is lost by the majority of roads using what are now considered antiquated methods; and what is still more important, a large volume of current will in all probability (on account of the high pressure between the rails at the point in question and the power station) escape through the ground and return by means of feeders at other points in the system, thereby causing electrolysis, as it takes but a few volts to cause electrolytic action. This thought makes our friend a trifle uneasy and he begins to calculate to find how much copper must be hung up in order to get a return more in accordance with what is usually considered a reasonable drop in voltage, and also to discover the value of the rails as conductors. From the power station to the point in question there is a double track. This, if perfectly bonded, he finds would have a conductivity equal to four square inches of copper or an equivalent of thirty-eight No. 00 copper feeders! Is it strange that he quietly concludes to drop the overhead feeder idea and study

a method of bonding that will enable him to make use of the valuable conductors he has already installed in the shape of rails. He wonders why there is not a single road in the country having a track so bonded that the conductivity of the bonds and their connections is within 50 per cent of the conductivity of the rails. He also wonders why some men have such a liking for the use of copper that they would ignore the conductivity of the rails entirely and would run copper wires along side of and connected to the middle of each rail—an arrangement having 90 per cent less current carrying capacity than the rails if properly bonded. Present bonding methods are undoubtedly defective, but the line of improvement should certainly be towards perfecting bonds and not in investing money in overhead copper that furnishes but a comparatively poor conductivity, unless installed in quantities that would ruin the financial standing of any road.

Another point not appreciated by some is that electrolysis of pipes is due not to the flow of current along a pipe but to the flow of current between a pipe and the earth. It was recently reported that the experiment is being tried at Cambridge, Mass., of running copper wires from the water pipes at the power station to those at points along the track. I fail to see how such proceedings can act except to increase the electrolytic action on the pipes. The fact that a copper wire of low resistance is connected in parallel to the pipe will act as an additional "inducement" (if I may use the word) for the current to flow from the ground to the pipe in order that it may return by the low resistance copper conductor to a point near the power station. Other conditions being the same the current flowing to the water pipes will increase in direct proportion to the added conductivity caused by the connecting of the copper wire to the pipes.

HARRISON'S SYNDICATE.

ONE of the powerful new companies in traction lines is that organized and dominated by Russell B. Harrison, under the caption of the Electric Tramway Maintenance Company, No. 1 Broadway, New York.

Among the late acquisitions of the syndicate are Lake Cities Electric Railway Company, of which Mr. Harrison is president, successor of the Citizens' Street Railway, of Michigan City, and the Richmond, Ind., Street Railway Company, of which Russell B. Harrison is secretary.

A NEW STORAGE BATTERY.

St. Louis electricians of the storage battery order are much interested at present in the Logan battery, which, its inventor avers, is a revolutionizer. The Standard Electric Company, of Detroit, is the present owner. President W. T. Anderson, of the St. Louis Merchants' Exchange, and others of that city are interested in the branch factory about to be established in St. Louis. The battery is designed for stationary and traction work.

TRAMWAYS OF ST. PETERSBURG.

THERE are three street car companies in St. Petersburg at the present time, denominated the First and Second Tramway Companies, respectively, and the Steam Tramway Company, the latter operating on the Schlueselburg road.

FIRST TRAMWAY COMPANY.

The First Tramway is a private corporation and employs 350 horses, averaging about 20 roubles each. The length of the line is $7\frac{1}{2}$ kilometers. The horses work on an average of $5\frac{1}{2}$ years, traveling at the rate of 30 kilometers the day. The conductors receive a salary of 30 roubles a month and the drivers 20 roubles a month, a rouble being equivalent to about 50 cents. A controller or chief conductor with a corps of assistants has supervision over the fares taken by the conductors. These controllers enter the cars at different points on the line and by an examination of the conductor's books and of the tickets given by him to the passengers he is thought to act as a check against false returns. The register system so effective in the United States in this particular is not in use in St. Petersburg or Moscow.

The number of passengers carried by this line during the year is about thirteen millions. The car is modeled in the conventional style except that it is two-storied, the upper story being reached by an iron ladder at the end of the car. This upper story is protected by an iron railing on the outside and two seats of the length of the car pass down the center back to back, accomodating 24 persons. The upper story is only used by men. The seats on the inside of the car or on the lower story are arranged after the usual plan and will seat thirty people.

The cars do not stop in the streets to accommodate passengers, but at their request they merely slow up, giving the passengers an opportunity to get on or off. All the lines, however, have special stations where they stop for the accommodation of the public and at all crossings, where there is much travel, they are compelled to walk their horses. On all the lines of this company two horses only are used, occasionally adding a third to make the grades at bridges. As a rule all public and private conveyances must keep off the tramway track except at the regular crossings. This is easily done, as all conveyances in all the principal streets are required to keep to the right. The fare on this line of cars is five copecks below and three capecks above.

The upper classes never ride in a tramway as it is considered not to be au fait. A large number also of the middle classes do not patronize the street cars, preferring to have a droschky, of which there are from fifteen to twenty thousand in St. Petersburg, and may be found on hand at any street corner during the entire twenty-four hours of the day. These droschkie's carry two people to any point in the city not unreasonably distant for an average of about ten cents. This method of conveyance is more rapid, more independent and if time is an object, not much dearer than the tram. The droschky is emi-

nently respectable and is patronized even by the best people in the city.

SECOND TRAMWAY COMPANY.

The Second Tramway Company, as it is called, is stocked, the capital amounting to eight million roubles. The company pays an interest on its obligations of 6 per cent on bonds and usually about 5 per cent on the stock. On this line are employed about 1,100 horses, costing from 200 to 250 roubles each. They work about five hours a day, and cover a total distance of thirty-five kilometers. The conductors on this line receive from twenty-five to thirty-five roubles a month, and the driver from sixteen to twenty roubles. The control or check against dishonest returns is effected in the same way as described above. This company carries an average of 38,000,000 passengers a year, the entire length of the lines being about eighty-four kilometers, and ramify throughout the town and suburbs. The style of the car is in every respect like that employed by the First Tramway Company, as described above. Some of the branches of this line, passing through less traveled portions of the city, have only one-horse cars, in which case there is no upper story. The single fare charged by this company is six copecks on the inside and four copecks above.

This company also owns a steam tramway, which carries 340,000 passengers per month in summer and 60,000 in winter.

To keep the tracks free from snow in winter costs about 250 roubles a kilometer, the snow being removed by section men who sweep the track with birch brooms. The repairs and paving are made at the expense of the company and cost about 170 roubles a year per kilometer. This steam tramway line covers a distance of $6\frac{1}{2}$ kilometers. The engine driver receives a salary of eighty roubles a month, and the conductor from twenty-five to thirty-five. Each engine takes a train of three cars, each seating sixty passengers. An electric tramway line is now under survey.

THIRD, SCHLUSSELBURG COMPANY.

The Third Steam Company bears from its location the name of the Schusselberg Company. This line is a steam tramway, and covers a length of about thirteen kilometers and carries 260,000 passengers a month in summer and 100,000 in winter. The repairs on this line cost the company 300 roubles a kilometer. The fare ranges from ten to twenty-five copecks, according to distance.

Russia is sadly behind the times, and no less so in street railway than in other directions.

THE patrol wagon of the Pittsburg, Allegheny and Manchester Traction Company is described as a very complete and useful adjunct to the repair facilities of the road. P. M. Cook, the line foreman, writes us that it is fully equipped for replacing cars, repairing the line or attending fires to care for the wire. A stretcher is also provided for accident cases.

JOSEPH L. WILLCUTT.

PIONEERS nowadays need not be very old men, and pioneer street railway men in mechanical lines may yet be young and still deserve the name. It is not to be supposed, then, that the term "pioneer," as applied to Joseph L. Willcutt, secretary and general manager of more than half a dozen street railways in San Francisco, must bring to mind an aged man. On the contrary, Mr. Willcutt is at hale and hearty middle age, and active in every way for the advancement of the various lines controlled by his company and managed by him.

Mr. Willcutt is a Massachusetts man by birth, having the Hub as a natal city, and Puritan ancestry for stock from whence to spring. To this ancestry is due, perhaps, the forceful, faithful and upright character of the bearer of the name. Mr. Willcutt's father was a ship-wright, well known to all the hardy mariners that sailed out of Boston town in those hardy days.

Mr. Willcutt acquired his early education in the Boston common schools, supplemented with broad and liberal reading that makes him today a conversationalist of exceeding interest and power.

Soon after leaving the schools Mr. Willcutt began his business career by entering a wholesale shoe and leather establishment, at the age of 14. Here he remained some four years, mastering all details of the trade. He then accepted a better position with a manufacturing company, where he remained until 1852.

In this latter year he resolved to go to California, the execution of which resolve was attended with many hardships now unknown. The isthmus route was the one chosen, and his arrival in San Francisco is dated May 7, 1852.

His first employment was as bookkeeper by the agents of a line of clipper ships, with whom he remained eight years. In 1860 he became a co-partner with Cox & Co., in the shoe and leather trade. For two years he handled the eastern business for the house, but returned to California in 1865 to assume the secretaryship of the San Jose Railroad Company. With this company he remained five years, during which time the shoals and breakers to be avoided were escaped, and the road consolidated with the Southern Pacific in 1870.

In this year he was elected secretary of the new corporation, which position he now holds, with the added duties and responsibilities of the general management. Mr. Willcutt has thus been intimately connected with all the great rapid transit movements of the metropolis of the coast, and through all its vicissitudes and changes of power and practice has remained a trusted and able guide and guard to its destinies. From steam to cable is a great advance to see in one man's lifetime, but to be intimately connected with and abetting such progress is still more remarkable and honorable. For two years past the Southern Pacific lines, which include the Market Street Cable Railway Company, the Park & Ocean line, the Ocean Beach Railroad, the City Railroad, the Potrero

& Bay View, the Central, the Geary Street, and Park and Ocean railways, have been under Mr. Willcutt's management, assisted by Geo. B. Willcutt, his son.

Mr. Willcutt belongs to few societies and no clubs, but takes his pleasures in his home life. In politics he has never taken more than a good citizen's interest, although frequently urged to accept office.

As a distinctive American, a capable railway man, a loyal Californian and a gentleman, Mr. Willcutt can look upon his career with as much pleasure as do his friends with admiration.

HISTORY OF THE MARKET STREET
CABLE.

SAN FRANCISCO pilgrims ever since 1873 have been to a greater or less extent interested in the cable lines, there first tried and so extensively used. Apropos of our sketch of the life of Manager Willcutt, a short review of the career of the Market street cable line would not be out of order.

Market street was first operated as a steam dummy line under the name of the San Francisco Market Street Railroad, and opened July 4, 1860. Two years later branch lines were added to "Hayes Park," and "The Willows," then famous resorts of the day. West of Third street on Market a succession of sand hills was marked by the railway line, and the famous Mission Dolores was a suburb in name only, a few adobe ruins being the only dwellings. In 1867 the Valencia street line was extended to Twenty-fifth street, and horse cars substituted for the dummy line.

In 1879 the Market street cable people began to find the population growing beyond their carrying capacity, and the cable was resolved upon to secure adequate facilities. The reconstruction of the old lines, the construction of branches, and the building of a suitable power house consumed the intervening years until 1883, in the month of August. In connection with this line, a dummy railroad four miles in length was built from the Haight street terminus to the ocean beach and Cliff house.

In July, 1888, the Market street extension to Seventeenth street was converted to cable traction and extended over the Castro street hills to Twentieth-sixth street.

Some years ago the Market Street Company owners bought in the City & Central and the control of the Geary street line, thus controlling paralleling lines and giving an extensive transfer system to the public.

THE interurban electric line of the Oaklands, San Leandro & Haywards road is now running 30 motor cars, and the country division is 15 miles in length. The run is made in 50 minutes including all stops. On level track 28 miles an hour is attained.

Though a woman will demand that the men get up and stand
And let her sit in street cars when she rides, when she rides,
You will hear the crack of doom ere she herself makes room
For another in a street car when she rides.

—Troy Press.

Street Railway Review



J. L. WILLCUTT,

Secretary and General Manager Market Street Railway Company, San Francisco.

ELECTRICAL HEATING.

Abstract of a Paper read before the Chicago Electric Club. By C. K. MacFadden.

DURING the past thirty years the fact that an electric current will generate heat in the conductor it passes through, has been applied in heating devices in an almost unlimited number of ways. It remained for the electric railway to open up the field for heating. There are today about 150 patents on electric heaters. Among the earliest devices was one for melting the obstructing paraffine out of oil wells. Burton was one of the first in the field. Patents taken out by him in 1869 covered numerous applications, one of which was the heating of railway carriages by heated metallic plates on the floor.

There is one patent drawing showing a locomotive with electrically heated flues. From appearances one would suppose that the steam from the boiler was to drive an engine on the tender, which in turn drove the dynamo that furnished the heat. There are many other inventions however, that are extremely practical, and will no doubt, be brought out as this branch of work progresses. Early specifications nearly always speak of platinum as a conductor—probably because of its high melting point. As a wire when surrounded by a good heat conductor will safely carry several times more current than when in the open air, all well known heaters have some good heat conducting and radiating substance in intimate contact with their coils. As nearly all serviceable heaters depend on this principle, the superiority of one heater over another will be more in the mechanical details of construction than in the efficiency.

It has been often shown that the cost of electric car heating is on a par with coal, when consideration is taken of the valuable space taken by the coal stove, and the even distribution of the heat. There has been much discussion as to the amount of current necessary to heat a car. Reports from Northern Michigan and Canada show that from 1,200 to 1,500 watts is sufficient to keep the average 16-foot car warm in that cold climate. The total cost of one net horse-power at the engine in a plant giving an average output of 500-horse-power is about sixth-tenths of a cent per hour, and an electrical horse-power hour will cost about one cent. Inasmuch as the heaters require no attention whatever, the cost of maintaining and operating electric heaters will then be about 30 cents per day of 20 hours. Coal stoves cost from 20 to 40 cents per day to operate, if the least account is taken of the time necessary to keep them in heating condition. Coal stoves take up enough room for one or more passengers. On cold days it is often impossible to stand immediately in front of the stove without burning the clothing. There are many times in spring and fall when heat would be desirable at certain hours, but with the coal stove this is impossible, unless the car is taken out of service long enough to build fires. It is fair to both sides of the question to assume that the fireman and engi-

neer will not be called on for near as much additional work in shoveling coal for the electric heaters as will be required of the conductors and helpers in attending to coal stoves. In one road under the writers notice a man is paid \$1.50 a day to take care of fourteen car stoves. The man does no other work, except oiling a few switches near his work. We may assume that there is at least 10 to 15 cents a day spent on labor, the conductor's time not being included. The cost of coal for such a stove is 20 cents a day at \$8.00 a ton.

Assuming that the only cost of running electric heaters is that of the extra coal burned at the power house; there is no chance for argument as to the cheaper method even leaving out of consideration the convenience and gain in car space with electric heaters. If the engineer's time has to be figured in for additional attention to machinery supplying current for electric heaters, why not figure in a portion of the conductor's time, who oftentimes is called on to take care of his stove while on the run.

Account is seldom taken of the cost of lighting a car with the usual two series of incandescent lamps, but this takes at least one-third the energy necessary for heating. Items are often left out in figuring the cost of stoves. The average life of a street car stove is about three years, and the repairs amount to considerable in that time. It also takes time to place and remove them at the beginning and end of the season. Few cars heated by stoves do not have a layer of dust deposited on the seats every time the stove is filled or shaken, which will in time ruin the upholstery.

Much has been said about burn-outs in electric heaters, but they will probably be unheard of in the future, owing to the great improvements growing out of past failures. It is no common thing for a coal stove to set a barn on fire: an impossibility with a properly installed electric heater. Charring of wood-work, common with coal stoves, is also an expense. Where power is cheap and coal is dear, as near waterfalls in mountain countries, electric heating again comes to the front. Some places in the west, \$10.00 a horse-power the year round is not considered cheap. This branch of work has been taken up to some extent already.

Electric cooking utensils are also coming into favor rapidly. Even when the cost of electric heating devices around the house exceeds that of other methods the question of convenience will probably come in and settle the question in favor of electricity in many cases, in the same way that the convenience of the electric light won it friends in spite of the cheaper gas.

AND SHE FELT SORRY FOR IT.

He came home very late one night
And to explain the slip,
He told his wife he was feeling good
But the cable had the grip.

MORE ABOUT ELECTROLYSIS.

ELECTROLYSIS is not an entirely incurable "disease," as we think the facts brought out in the last few issues of the REVIEW go to prove. In nearly every case where electrolysis has caused much damage it has proved on investigation that the road causing it was using an exceedingly poor return, considering the volume of its traffic. This is not meant to reflect in any way on our friends who have been thus troubled, for this difficulty was such a new and unexpected one that it could hardly have been foreseen. It is never-

was single bonded with iron wire and the rails were 35-pound tram. All agree in ascribing the difficulty to the poor return, and since the construction has been improved by the use of 69-pound rails and No. 0 copper bonding, about one-third less energy is consumed, and no trouble is anticipated from electrolysis of pipes.

Our engraving shows some sections of iron pipes from near the West Side power house at Milwaukee. These are the first iron pipes to be eaten away in that city. The road causing the trouble was installed in the early



WATER PIPE AT LOS ANGELES.

theless a welcome pointer, that a very poor return circuit has in the majority of cases been the cause of the difficulty, for had trouble occurred on the smaller and moderate sized roads, which had return circuits designed according to the best and most improved methods, the remedy would prove to be a serious problem indeed. As it is, the cure is not far to seek. On the larger roads the question is much harder to deal with, but new ideas with regard to efficient ground returns are being advanced so rapidly that the outlook is exceedingly bright even for

days, and of course does not have a return quite up to modern standard. The traffic is heavy.

As stated in Manager Clark's letter in our March issue, there has been some trouble in Los Angeles. Our engraving shows some of the pipes acted on. As the Los Angeles Consolidated is a large system, the difficulties are more serious than is usually the case, and the soil is not at all favorable. However, when Manager Clark has an opportunity to thoroughly carry out his excellent ideas on bonding as expressed in the letter referred to,

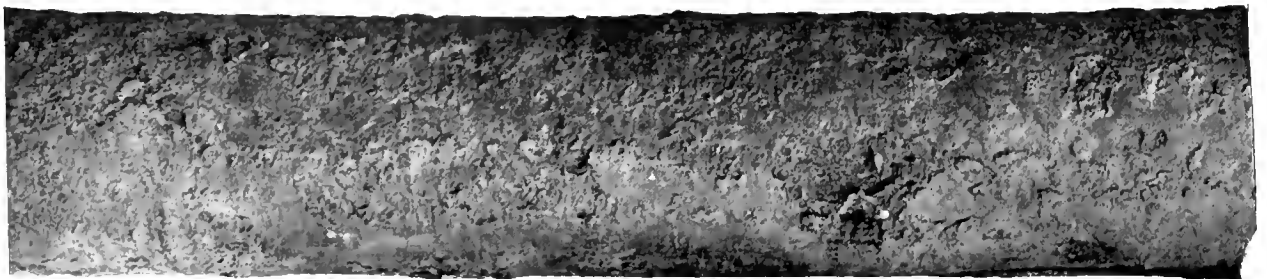

ELECTROLYTIC ACTION ON WATER MAIN, LOS ANGELES.

them. The much hoped for continuous rail would probably solve the problem, and in its absence one of the things most needed is a cheap, easily applied non-corrosive rail bond connection. The question is by no means settled, but the case is not nearly as serious as at first appeared.

In addition to the roads mentioned in the article on "Rail Bonding and the Ground Return" in our February and March issues, we have received reports from several places where trouble from electrolysis has occurred.

Hamilton, Ontario, has suffered a little, but the road

the trouble will no doubt be greatly helped. The majority of roads are in a transition stage from the old method of bonding, etc., to the new, and it is not fair to criticise any method until it has been thoroughly tried. In many places electrolysis has been going on ever since the road was put in, and long before new methods were tried, but has only recently been discovered.

At Saginaw, Mich., quite a different case presents itself. The system comprises twenty-five miles of track, only three blocks of which show any signs whatever of electrolysis of water pipes. The ground in the troubled

neighborhood is saturated with brine from salt works. There is also in the vicinity a galvanizing works, which discharges large quantities of refuse containing sulphuric acid into the ground. The rails are bonded with No. 6 wire, with two supplementary wires. A more difficult case to deal with could hardly be found, as both salt and sulphuric acid are exceedingly favorable to electrolytic action.

It is a growing conviction among many that the way to prevent electrolysis of pipes is to connect the rails to the



ELECTROLYTIC ACTION AT MILWAUKEE—IRON WATER MAINS.

water pipes in as many places as possible. This is certainly not without reason, for if it is the flow of current between the earth and pipes that does the mischief, the most natural way to prevent it would be to provide an easier path than the ground for the flow of current between rails and pipes. This idea should not be carried so far, however, that the improvement of the return circuit in other ways is neglected.

AN OVERLAPPING RAIL JOINT.

THE accompanying illustration shows a form of joint that is being experimented with on the Chicago City Railway. It is made by sawing out a piece three inches long from the lower half of one rail, and a corresponding piece from the upper half of the abutting end. The ends then fit together as shown in the illustration, which represents the joint with the fish plates removed. It is manifestly suited only to double track, where the traffic is all one way. In the joint here shown

it should be from right to left. With the traffic in this direction it is impossible for the end of one rail to be depressed lower than the other, so that the only pounding possible is that caused by the depression of the joint as a whole. Mr. Bowen had a few of these joints put in on

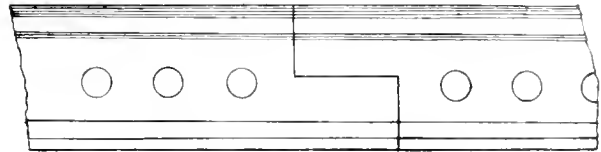

BOWEN'S OVER LAPPING RAIL JOINT.

the Kansas City Cable Railway four years ago, and they are still in good condition, having received almost no attention. They are now being tried for a block on the Sixty-first street line in this city, where they will be subjected to the heavy pounding of the electric motors. They give promise of being an improvement, if not a "cure all," and are at least worth a thorough trial. Mr. Bowen states that if sufficient time is given, the next track laid by the City Railway will have this kind of joints. The joints as laid have an overlap of three inches, but two inches is considered sufficient. The cost of sawing these rails cold has been found to be about sixty cents a joint.

FIRE-PROOF CONSTRUCTION.

THAT fireproof construction is now perfectly possible there is no question, and it is strange that it is not more often met with in the construction of power stations and car barns. By fireproof construction is not meant a brick and iron building finished with wood, nor a building that has its combustible material covered over with non-combustible. Experience has proven many times that a building is not fireproof unless it is composed entirely of material that will not burn under any conditions. This would have been a difficult problem a few years ago, but if a power station is not fireproof today it is because its builders do not choose to make it so. Brick, iron and concrete go together to make up a fireproof combination in the main essentials of the building, and porcelain, marble and slate furnish the insulating and fireproof qualities necessary for the electrical part of the work. The typical fireproof station will have its floors all of concrete from boiler to dynamo room, and if it is necessary to have any platforms they will not be of wood. Concrete floor around engine foundations will, if properly laid, tend to greatly lessen the vibration. When it necessary to run pipes below the floor level the trenches are covered with iron. The walls of the station are of brick or stone and the roof is iron frame. Whether this iron frame supports an iron roof or one of gravel, slate, tile or any combination of these materials, is the choice of the builder. The switchboard is of slate or marble and no wood is used around any of the electrical equipment except that forming the supporting frame for the switchboard and the dynamo bases, which is too small in amount to be worthy of consideration. It would take a very intense fire from the outside to injure such a building.

It is nothing uncommon to see a station with some of these elements of construction, but having one or two important ones omitted. Sometimes the structure will be built entirely fireproof from the roof to the sills, and then a wooden floor laid. As fireproof construction is expensive, it would seem that the best policy would be to do the job thoroughly. A building made half fireproof costs more and is not much safer than one that is built with no attempt in that direction. What is worth doing at all is worth doing well. Our engravings show two good

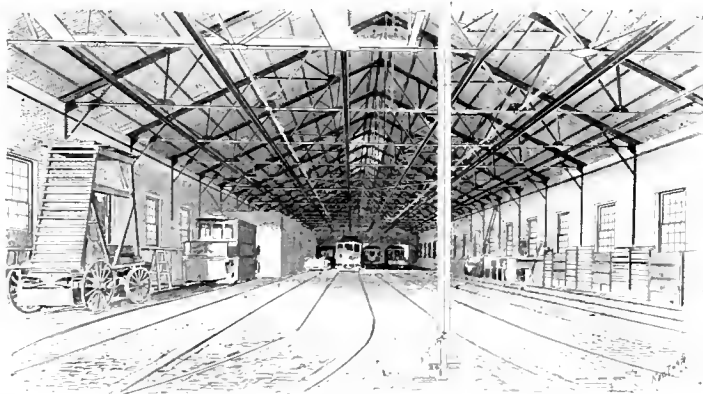

CAR BARN WILMINGTON CITY RAILWAY.

examples of perfectly fireproof structures. The car barn of the Wilmington City Railway, built by the Berlin Iron Bridge Company, is an iron frame brick building. The roof is entirely of iron. The power house of the Worcester, Leicester & Spencer Street Railway, at Worcester, Mass., somewhat similar in construction, was built by the same company, who claim that they can build a power station without a particle of wood in it. In constructing car barns, the facility with which cars can be removed in case of fire should be considered. Where dependence is

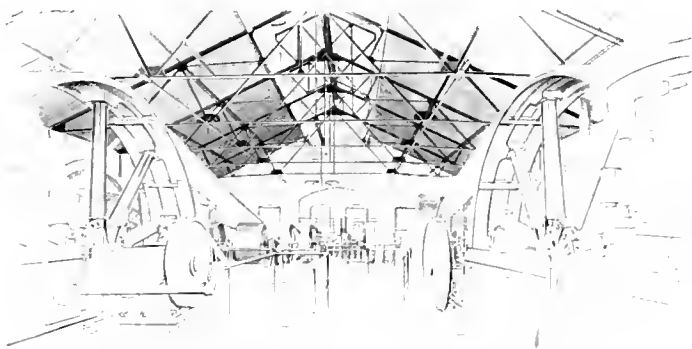

FIREPROOF POWER STATION, WORCESTER.

placed on a transfer table there is very little chance to save a barn full of cars. Where, as is frequently the case, every track leads to the main line, the number of cars that can be saved in case of fire depends principally on the number of men there are to handle them.

In addition to the protection offered in the buildings illustrated, the imposing appearance and strong and lasting qualities of the Berlin Bridge Company's work reflect great credit on their skill.

THE ACME SASH WHEEL.

THE accompanying cut represents the "Acme Sash Wheel." It is a brass wheel about $\frac{5}{8}$ of an inch in diameter, mounted on a steel spring on a brass plate, as shown at the right. This plate is sunk in a bevel of the window sash, so that it presses firmly against the window stop, forming an anti-friction bearing between the

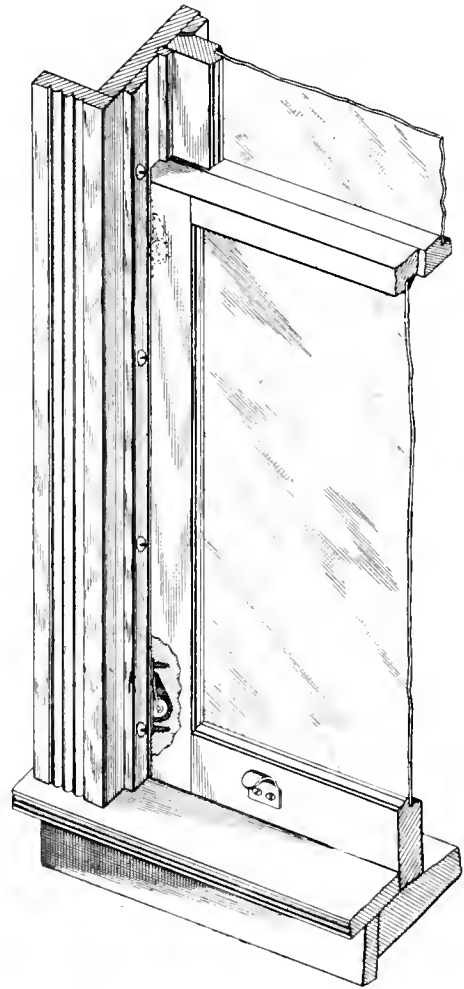

ACME SASH WHEEL AND SASH.

sash and stop and preventing rattling from play of the sash in either direction. The sash is held firmly against the outside stop, making a tight joint and at the same time the sash does not expand and stick in wet weather. The fixtures are being manufactured by the Acme Sash Wheel Company, 1024 Opera House Block, Chicago.

"BENZINE CABS," says one of our intelligent secular contemporaries, "are novel features of German transportation. They require no track and a touch of a lever starts, stops and guides the vehicle. It is convenient for families as the same heat may be used to cook the meals during travel and warm the occupants in winter. The cost of the cab is \$1,000 but this can be reduced to one-half. The machinery is simple and strong and the speed of 16 miles an hour costs one-half cent's worth of benzine a mile."

ON THE GRIP.

III.

THE gripman sat down in the trailer and said, "I was telling you fellows a cold weather story. Well that woman was interrupted by the conductor of the cold, cold car and he looked so miserable that she didn't say a word and she didn't report him either."

"Another woman," Gripman Perry continued, "touched my shoulder at Twenty-fourth street once while on what I call my dinner trip. She told me confidentially that she wanted to get off at Sixteenth street. When I arrived there the railroad gates were closed and as my leader was standing on the north side of the street, I stopped on the south side of the crossing. I turned around then and said, "This is Sixteenth, lady." "I know that," she replied, "but I want to get off on the north side of the crossing." "O, I beg your pardon," I returned, "I thought you might be a stranger in the city. However, you have only fifty feet to walk and I may have to stay here five minutes." She was mad as a wet hen in an instant. "I am not a stranger," she replied, "I was born here, and I know the streets better than you do. So there. If I were you I wouldn't be quite so familiar on so short acquaintance." As I here concluded that the remarks were becoming personal I retired from the conversation and didn't look around until I had crossed the street within the regulation 25 feet of the railroad, before I stopped. This was about 100 feet further than the crossing, and I then gained courage enough to look around me. She got off and then—! well, she told me first that she wanted to know why I didn't stop when I got across the street. I told her that the wheels had slipped. She didn't believe that beautiful story—just then a freight train came along, down went the gates and I was cornered, and had to face the music. She said she was an intimate friend of the superintendent. In fact, she used to go to school with him. She said it was a daily pleasure of hers to have men discharged. This didn't scare me, but when she told me that she used to go to school with the superintendent, it weighed heavily on my mind. You can't always tell what influence these old girls may have with a man. So I took water and said, "O, madam, I am very sorry for offending you, so please don't report me. I have been sick all fall and have only been at work three weeks. Besides I have a wife and six children, I am three hundred dollars in debt and coal is high." That brought her. Of course I stretched the truth considerably, but I knew that if I didn't she would. Let me advise all you young and inexperienced fellows to work the sorrowful graft. It isn't nice but it pays.

One day last summer a little lady about six years old said, "Driver, let me off at Randolph street." "At Randolph and Michigan or Randolph and State?" I asked. She thought a moment and replied, "I want to get off so that I can go over and see Lizzie Brown." Of course I found out where Lizzie Brown lived and let her off at the right place.

Children and dogs, by the way, are the best friends we have. They show by their actions whether they like you or not.

There are a great many things that happen along the slot rail that makes drivers careful and causes their hair to turn gray. But if it's one thing beyond another it is to have a woman driving a horse heave up along the track some where. It makes a man rise to his feet, open the grip and reach for the brake to see a woman driver within a half mile of him. Nobody can tell what a woman driver may do next. In fact, she does not know herself. Often in her anxiety to avoid some slight or imaginary danger she'll run plumb into a cable car or an ice wagon.

We have lady friends though, along the line, and many a man has stopped his car in the middle of the block just because of a pleasant smile. The gripman, be it said to his credit, hasn't any time to flirt. He leaves that for the rear platform but, nevertheless, good friends of the gentler sex are made by courtesies that cost nothing and that are neither impudent nor imprudent.

School girls giggling, prim and otherwise, soon learn to know the gripman, and as for dogs, horses and signs along the streets we know them very shortly. Especially the dogs, which have an insane idea that they can run under a moving car and not loose some joints of their graceful tail or their wildly-flapping ears. But if you fellows want to hear a dog story just wait for my next trip.

A NEAT FREIGHT CAR.

WE here illustrate a freight car used by the Lynn & Boston Railroad for carrying supplies from one part of the system to another. It is very much like a steam road freight car except that it has an 18 inch platform for the motorman to stand on.



ELECTRIC FREIGHT CAR.

The dimensions are, height 6 feet, width 6 feet and length 20 feet. It will carry from 8 to 10 tons with ease and dispatch. It is used during the daytime and is of course, available on any of the 125 miles of electrically equipped road operated by this company. All general track and station supplies, excepting rails, are carried.

STREET RAILWAY LAW.

EDITED BY MR. FRANK HUMBOLDT CLARK, ATTORNEY AT LAW, CHICAGO.

City Granting Exclusive Franchise to Street Railway.
Legislative authority conferred upon a municipality to "permit, allow and regulate" the laying of tracks for street cars, does not give power to grant for a term of years the exclusive right to occupy the street with street railroads.

The legislature has, as the general representative of the public, plenary power over the streets and highways within the limits of the municipality, and has, unless specially restricted by the constitution, the power to authorize the building of a railroad on a street or highway, without the consent of the municipal authority, and may directly exercise this power, or devolve it upon the local or municipal authorities. But the general grant of power to a municipal corporation, which is but a mere local agency, to authorize the use of its streets for such purposes, while it carries with it by implication all such powers as are clearly necessary for the convenient and proper exercise of the authority expressly granted, does not authorize the city to grant an exclusive franchise for that purpose. When an exclusive privilege or franchise to use the streets of the city for the purpose of the street railway is drawn in question and is claimed to be derived through a municipal ordinance or contract, the power of the municipal authorities to pass the ordinance or enter into the contract must be free from doubt. Nothing short of express legislative authority will authorize a municipality to grant such a privilege or enter into such a contract. We take it to be settled by the weight of authority that a municipal corporation cannot create a monopoly by granting the exclusive privilege to any person or corporation to use its streets for laying street railway tracks, without express legislative authority so to do; and this power must be plainly conferred in express words, or arise from the language used by implication so direct as to amount to the same thing. The mere general power to permit or allow the use of the street for such purposes, is not sufficient to authorize the granting of exclusive privileges. As the charter of the City of Salem does not in express words or by necessary implication equivalent thereto, confer upon the city the power to grant the exclusive privilege to one person or corporation to occupy its streets with a street railway, but only contains a general grant of a continuing power to "permit, allow and regulate the laying down of tracks thereon," it seems clear that it did not authorize the city to grant an exclusive franchise to plaintiff's assignor, and thereby disable itself from granting a similar privilege to defendant over the same streets.

It is earnestly urged that the construction of street railways necessarily requires the expenditure of a large sum of money, usually without the prospect of immediate return, and hence private persons would not be likely to engage in such enterprises without an assurance that they would be protected from competition for a sufficient length of time to remunerate them for the outlay. This argument, which is not without force, suggests considerations of policy which might influence the Legislature to grant or authorize the granting of exclusive franchises,

or induce a municipality to make a franchise practically exclusive by withholding a like privilege from a competing enterprise, but a reference to the cases cited will show that it has often been urged, but without effect, when a Court is called upon to construe particular legislation.

(Sup. Ct. Ore. *Parkhurst v. City of Salem*. 8 Notes of Cases. 27.)

Injury to Person Crossing Street—Car Rounding Curve—Excessive Speed—Contributory Negligence.

The plaintiff testifies that she was proceeding to cross Druid Hill avenue to go to a store on the other side of the street; that while still on the pavement close to the curbstone she looked up and down the street to see if a car was coming, and that she also listened; but neither hearing nor seeing one, she proceeded on her way across the street. She further testified that the accident occurred in the month of February, at seven o'clock in the evening, when it was rather dark, and that there was a curve in the street about half a block below the place, and this curve prevented anyone from seeing a car coming until he or she got well on towards the curb or until the car got around the curve; that she was crippled, and could not walk very fast. In coming up Druid Hill avenue the car turned a corner; the distance of this corner from the place where the accident occurred is not stated. One of the witnesses testified that it took the car about a minute for the car to run from this corner to the place of the accident. The gripman in charge of the car testified that the full speed of the car was ten or twelve miles an hour, and that it was going at about half speed, perhaps a little faster. In a large, populous city, it is the duty of the driver of the car to see that the track is clear, and also to exercise a constant watchfulness for persons who may be approaching the track; unless he does so, he does not exercise that care and prudence which the law imposes on him. It is of the greatest importance to enforce this rule in cases where cars are propelled, as in this instance, by agencies capable of attaining a speed of ten or twelve miles an hour. If the jury inferred from the evidence before them that by ordinary care the gripman could have seen the plaintiff in time to avoid running over her, it was perfectly competent for them to make that deduction from the evidence. If the car was not in sight, it could not be negligence on her part to attempt to cross, and if a car came upon her and caught her in a space of one minute, while she, a cripple, was crossing the track, we could not withdraw the question of contributory negligence from the jury and make it a question of law without a calculation of chances too nice for the Court to make. In our opinion the case was properly left to the jury.

(Ct. App. Md. *Baltimore Traction Co. v. Wallace*. 21 Wash. L. Rep. 313.)

Injury to a Person Alighting from Car—Sudden Starting—Contributory Negligence.

The fact that a street railway passenger attempted to

step off a car while it was in motion, will not prevent her recovery for injuries occasioned by a sudden start of the car so nearly simultaneous with her stepping off that she had no chance after the car started, but was obliged to step off to avoid falling. A street railway company is liable to a passenger who, without her fault, was injured by the sudden and negligent starting of the car while she was getting off.

(Sup. Ct. Minn. *Piper v. Minneapolis St. R. Co.* 53 N. W. Rep. 1060.)

Expulsion of Passenger from Car—Depositing Fare in Box—Refusal to Pay Driver.

A street railway company is liable in damages to a passenger ejected from its car for refusal to pay a second fare to its driver, after he has deposited his fare in the fare-box in accordance with a rule posted in the car which forbids payment to the driver, although it has given private directions to the driver to go through the cars when crowded and collect the fares.

(Sup. Ct. Pa. *Perry v. Pittsburg Union Pass. R. Co.* 25 Atl. Rep. 772.)

Electric Railway—Excessive Speed—Cut in Street.

It is gross negligence for an electric railway company to run its cars at an unusual speed through a cut which in anticipation of a change of grade, it has made in the street in such a manner that persons driving along the street must drive along the track.

(Sup. Ct. Pa. *Greeley v. Federal St. & P. V. Pass. R.* 25. Atl. Rep. 796.)

Person Boarding Moving Car—Negligence per se.

It is not negligence *per se* for a person with something in each hand to board or attempt to board an electric car while it is in the act of stopping to receive passengers and before it has come to a full stop. Such boarding or attempt may or may not be negligence, according to circumstances. In this case the circumstances were not so decisive as to dispense with a jury. The plaintiff had an umbrella in one hand and a handkerchief in the other.

(Sup. Ct. Ga. *White v. Atlanta Consolidated Ry. Co.* Not yet reported.)

Regulating Rates of Fare—Ordinance Requiring Conductors to Keep Tickets for Sale.

Where a city is given the power by the legislature to fix and determine the fare which may be charged by street railways, a city ordinance may validly require that the conductors of street cars shall keep for sale six passage tickets for twenty-five cents. The power to fix the rates of fare necessarily carries with it all incidents necessary to carry the power into effect. Thus, for a single passage the fare is five cents; if six trips are to be made, the price is fixed at six for twenty-five cents. A street railway has no depots; its stations are the street corners, and its business with the public is conducted on its cars. Is it unreasonable to require the company to sell its tickets at its place of doing business? We think not. The plea that it is liable to be defrauded by its employes if it sells ticket on the cars does injustice to

many faithful, reliable and diligent persons whose integrity is above question, and is a mere pretext to evade the ordinance requiring tickets to be sold on the cars, as will readily be seen from the stipulation of the fact that it is for the interest of the company not to sell tickets, but to collect fares in cash. But even if the claim on behalf of the company is true, which we do not believe, it must comply with the ordinance. The question is one of power, and the power of the city over the street railway is full and ample, and the requirement is reasonable, and the company must perform on its part.

(Sup. Ct. Neb. *Sternberg v. State.* 8 Notes of Cases, 30.)

Street Railway—Failure to Complete Road Within Time Specified—Liquidated Damages.

The sum required to be forfeited in case of a street railway company's failure to complete the first line of its road within a year, is to be treated as liquidated damages and not as a penalty, where its contract with the town provides for the forfeiture by it of its right of way and privileges, and that it shall also "forfeit and pay" \$500 in case of its failure to complete such line within that period, although it requires the company to give bond in the sum of \$500, and after a breach the damages are found to be capable of assessment.

(Sup. Ct. Ark. *Nilson v. Town of Jonesboro.* 20 S. W. Rep. 1093.)

Obstruction of Street Car Track—Violation of Ordinance.

Defendant stands convicted on the violation of an ordinance prohibiting the obstruction of street cars by placing obstacles upon or along the tracks. Defendant had obtained a permit from the city authorities to move a house, in which he was forbidden to obstruct the passage of the street cars at any time between five o'clock in the morning and eleven o'clock at night. The only excuse or justification offered by defendant for his acts, is that the company had agreed to let him go over the tracks and had no right to exact the sum of ten dollars as compensation for taking down and replacing the wires. The defendant seems to have overlooked the fact that the street railway company could not authorize him to violate the ordinance, nor would any act of said company excuse or justify his disregard of its provisions. This prosecution was not a controversy between defendant and the company. It was on behalf of the people; for though the ordinance is of great value to the street railway company, it was enacted primarily in the interest of the traveling public—the people who have frequent occasion to use the street cars, and cannot be detained and inconvenienced either by the acquiescence of the company in the creation or maintenance of any obstruction, or by the act of some person who, having difficulty with the company, obstructs the passage of the cars. The testimony of the defendant shows beyond controversy that he wilfully blockaded the track, thus violating the ordinance, and from his testimony alone the court would have been justified in its action.

(Sup. Ct. Minn. *State v. Pratt.* 53 N. W. Rep. 1069.)

THE INNOCENT CANDLE AND THE ELECTRIC LIGHT.

Common people are always interested in prying into the mysteries of science, and for the benefit of those whose early electrical education may have been neglected we will take a few extracts from a description of the electrical features at the World's Fair, by John Gilmer Speed in Harper's Weekly. In speaking of the subways and the wires carried therein he says:

"Visitors who ask questions will be told that some of the wires are charged with 200-horse-power."

This is probably intended as a warning to visitors not to ask questions, and if it were true that they would receive such answers we should certainly advise them not to. The condenser capacity of those wires that are capable of being charged with 200-horse-power must be something enormous and we advise those at work trying to perfect a commercial condenser, to study the conditions prevailing in the subway.

In connection with the chandeliers in the Manufactures Building the following dissertation on "candle-power" occurs:

"Each light will be of 2,000-candle-power. Thus, in these five large lights, there will be illuminating value equivalent to 828,000 candles, the candle being the unit of measurement arbitrarily adopted by electricians who speak of one electrical candle-power as being equal to the power of four ordinary candles, because the rays of an electric light go equally north, south, east and west. But as the little candle throws its humble beams in the same way, we should divide the candle-power of an electric light by four to get its actual illumination value when compared with candle light."

Thus the little candle, humble tho' it be,
Lighteth up the pages of Harper's Weekly.

JUST THE POINT.

IT seems that even the rapid transit philanthropists are not with a single eye to the public good. In fact, they wish to make a little something for themselves on the side. Is New York thus afflicted? Recently an ambitious civil engineer was caught in his office figuring away for dear life. "What are you up to now?" a friend asked. "Oh, just a scheme for the Rapid Transit Commission to worry over. I submitted one, but it wasn't a go. Now I'm working on another tack. I am going to present the following proposition: If the city will lend me \$30,000,000, I will put up a guarantee to furnish \$20,000,000—if needed—and build a viaduct through the Island from the Battery to Harlem, that will give all the rapid transit needed for the next half century. I want to borrow the \$30,000,000 at 3 per cent. I estimate that the road will cost me about \$28,000,000, so I will make a cool \$2,000,000 to begin with. Then, you see, I can put out most of the \$30,000,000 at 4 per cent, and can use the interest to go on with the construction. That would put about \$750,000 more in my pocket. It

looks like a good thing, and I'm working it for all it's worth." With these three-per-cent rapid transit prophets and profits, it is easy to see the interest taken by certain engineers in such schemes.

TROLLEY WIRE JOINT.

THE "Teck" joint is made by splitting the ends of the wires to be jointed with a hack saw, slipping into the case or sleeve, as shown, and then filling the case with solder. For uniting trolley wires and heavy

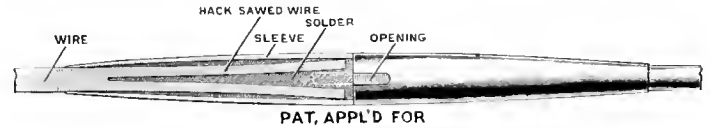

cables the strength and small size of this joint commend it to all. The sleeves are made by the Technic Electrical Works, 604 Provident Building, Philadelphia, Pa.

THE BROOKLYN "L."

THE quarter ending March 31, has just been reported to the railroad commissioners of New York by the Brooklyn L. The tabulated form comparing the past two years shows a remarkable decrease for 1893:

	1893.	1892.
Gross earnings.....	\$486,894	\$460,342
Operating expenses.....	280,913	259,698
Net earnings.....	\$205,981	\$200,644
Other income.....	2,099	3,349
Gross income.....	\$208,080	\$203,993
Fixed charges.....	189,046	161,020
Net income.....	\$19,034	\$42,973

The total assets are placed at \$26,744,080 and the capital stock at \$13,283,600.

ANOTHER ELECTRIC FOR CHICAGO.

LICENSE for incorporation has been issued to the North Chicago Electric Railway Company. The capital stock is set at \$2,000,000 and the incorporators are empowered to construct, lease, and purchase horse, dummy and street railways in the city of Chicago and the county of Cook, and to maintain and operate the same. Chas. H. Gurney, John E. Burke and Alexander M. Savage are the incorporators.

CABLE traction for street lines has been rather slowly adopted in England. What lines there are have labored under difficulties brought about by poor construction, and still poorer maintenance, coupled with the Britisher's prejudice against anything new. A new line recently opened up between Kensington and Streatham is said to be of first class construction, and one that will probably bring the system into greater favor in England. The cost of construction is much less than here.

CRIMMIN'S FIRST CAR.

THE initial trip of the Broadway Cable over the entire route was made early on the morning of May 13. Car No. 6 left the car barn with F. S. Kane, superintendent of gripmen, at the helm and the following officers of the company: President John D. Crimmins and Treasurer Thomas F. Ryan, of the Metropolitan Traction Company, Chief Engineer George W. McNulty, Assistant Engineers F. Tranaltes and E. C. Earll, President Henry Thompson of the Broadway Line, Superintendent H. A. Newell, Division Engineer Albert Carr, who has charge of that part of the line north of Twenty-third street; Operating Engineer F. L. Hart, William St. John and John D. Crimmins, Jr.; John Stephenson and Vice President Tackaberry, of the Stephenson Car Company, were among the invited guests.

The trip was a successful one and despite the early hour of 10 o'clock a merry one. The section of the road above Fifty-first street has been operated previously, but only one set of engines in the Houston street power house were set in motion.

NEW JERSEY'S ROADS.

STREET railways in New Jersey report annually, and the following is a sketch of the returns brought in. During the past year the mileage has grown from 242 to 281 miles; the capital stock of all the corporations from \$10,410,947 to the snug sum of \$13,189,755; the capital stock paid up from \$10,303,947 to \$12,668,005; the funded debt from \$10,063,000 to \$13,024,100; other debts from \$1,157,992 to \$1,707,439. Three new railways were built in the year, raising the cost of railways and equipments from \$21,806,183 to \$23,872,444; the expenditure for repairs and management from \$1,968,758 to \$2,488,304; the gross receipts from \$2,623,068 to \$3,083,991. The dividends paid by six companies amount to \$74,086. Last year only four companies paid dividends, and they but \$33,078. The Consolidated, of Trenton, now operates 32 miles of track, with a capital of \$1,500,000; funded debt, \$521,000; other debts, \$380,401; cost of road, \$2,343,261; repairs to the road, \$185,282; gross receipts, \$179,355; passenger traffic, \$175,792.

MAINE'S NEW ROAD.

MAINE and New Hampshire have been the most backward of the states to accept the new order of things and electrify railway systems. The next electric railway in Maine will be the Calais-St. Stephen line, which will extend 5½ miles from the lower wharf at Calais to the depot at St. Stephen. The men most interested in the enterprise are: A. F. Gerald, of Fairfield; Geo. A. Curran, C. D. Hill, and W. A. Pike, of Calais.

THE ORANGE MOUNTAIN CABLE.

IT was in 1887 that E. A. Pearson and Francis M. Eppley, well known in street railway circles, organized the Orange Mountain Land Company, and purchased 500 acres at the top of Orange Mountain for \$235,000. In 1891 the property came into the possession of the Globe Investment Company, of Boston. As the land was 500 feet above the country 'round about, for all

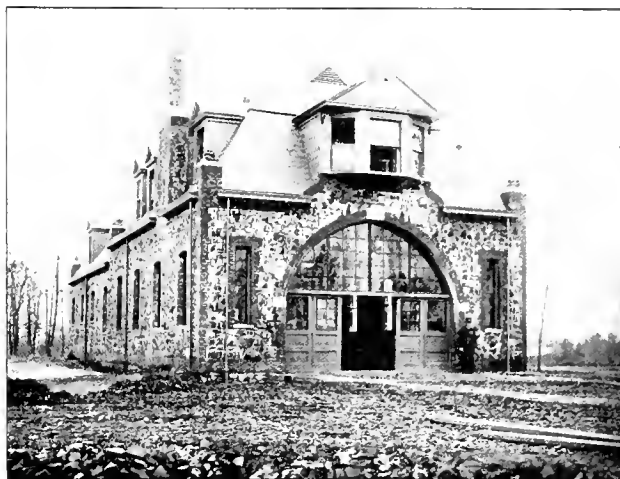

THE POWER HOUSE.

practical purposes of residence and resort it might as well have been at the top of the Washington Monument, and so the new owners organized the Orange Mountain Cable Company, and contracted with the New York office of John A. Roebling's Sons Company to build and fully equip the line.

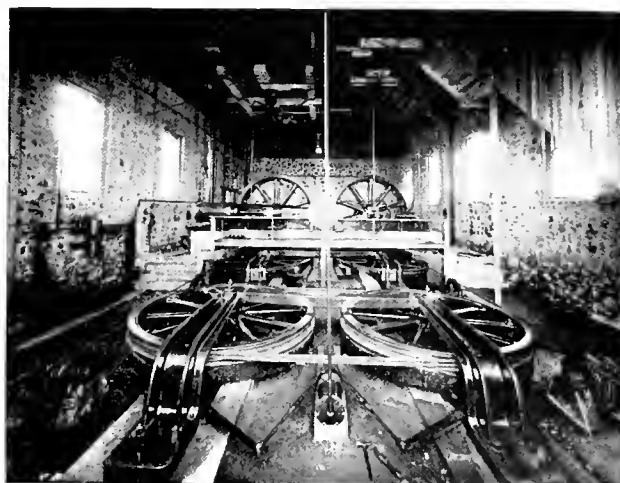

DRIVING MACHINERY, SHOWING SAFETY CABLE DRUMS, WITH AIR BRAKE.

The entire construction has been in charge of S. A. Cooney, of the New York office of the Roebling's, and the work, which commenced with the drawing of plans last October, was pushed with energy, and now stands forth completed, a lasting honor to both engineer

and contracting company. In many respects, it is the most interesting of the many types of inclined plane cable roads.

From one bulkhead to the other the line is straight, except as to elevations, and is 3,825 feet long, with an elevation of 500 feet. Tracks are double, of 8 feet gauge, spaced 18 feet between centers, and laid with 56-

section are $5\frac{5}{8}$ inches between centers and rest on the pulleys just below the top of the channel irons, except at the moment when the car is passing over, when the ropes are lifted out of the conduit to a height of two feet, falling again into place below the street level when the car has crossed. Safety gates are let down when the car approaches to prevent vehicles from becoming

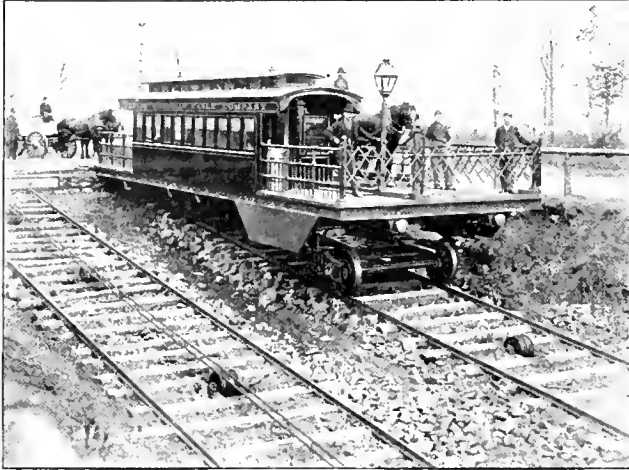

CAR AT TOP OF THE INCLINE.

pound T rail. A maximum grade of 14.5 per cent continues for 1550 feet, and about half way up the incline Gregory avenue is crossed on a level.

This crossing is very unusual in the construction of incline planes, and called for special construction, as it was not permissible to use an open conduit, as vehicles constantly cross the line. A narrow conduit was there-

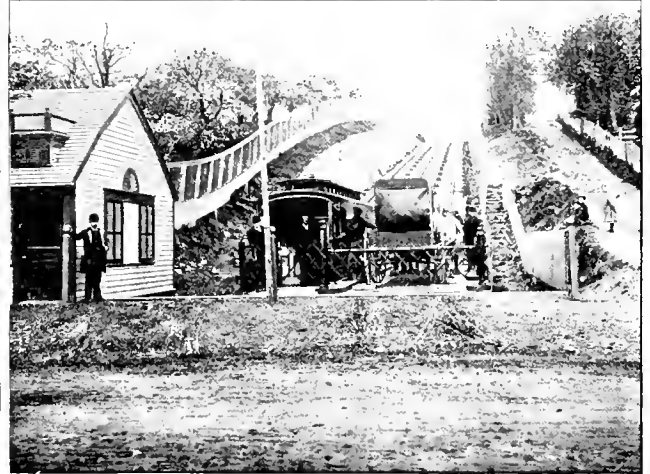

THE LOWER TERMINUS.

entangled in the moving cable as long as the ropes are exposed. The arrangement is clearly shown in the illustrations.

Another novel device is the provision by which the conductor of each car is in constant communication with the engineer by means of an electric signal wire which will be noticed in the illustration as extending along the

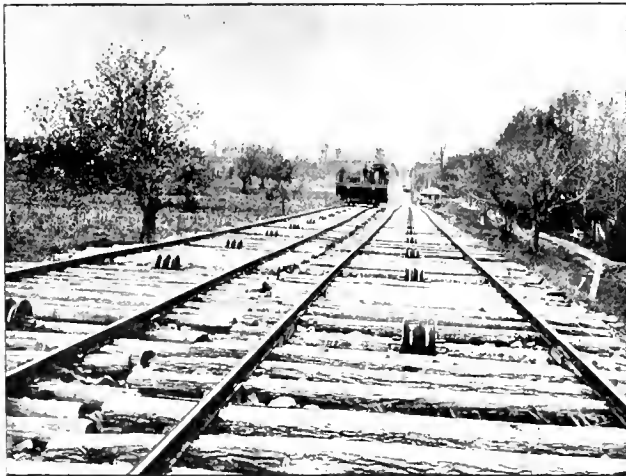

LOOKING UP THE GRADE.

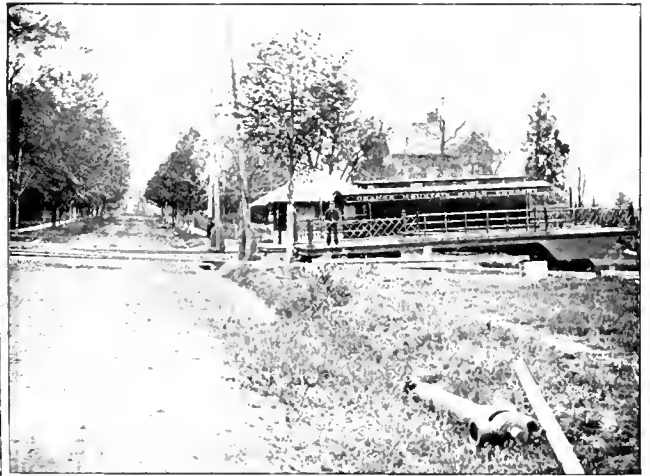

AT THE GREGORY STREET CROSSING.

fore built in each track, formed of two Z iron beams 8 inches deep, set $12\frac{1}{2}$ inches apart, with an I beam extending parallel between and thus forming a double conduit in which two groove pulley wheels of 15 inches diameter are placed at intervals of 15 feet; the I beam being cut away on the under side where necessary to make room for the pulleys. The two cables on this

outside of each track. A push button in the car strikes a gong in the engineer's room, and a set of signals to stop, start, etc., enables the cars to run by Gregory avenue when no passengers are to be taken or discharged. This wire is carried on a Y shaped insulated support, in which the composition forked tips are set in glass insulators mounted on locust pins, the whole rising 10 inches

above the ties. This signal wire is carried between two trolley wheels, fastened to an arm projecting from the car. The larger wheel is 7 inches in diameter, $1\frac{1}{4}$

inches wide with a $\frac{3}{4}$ inch groove. The small wheel is $1\frac{7}{8}$ inches diameter. At the Gregory street crossing the signal wire is carried in a conduit having a $1\frac{1}{2}$ inch slot through which the wire is raised the same as the cables.

The power house, as will be noticed in the illustration, is a handsome structure of stone, with boiler room in the rear 33 by 33

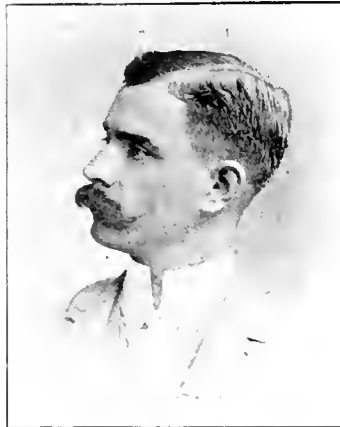

S. A. COONEY,
Constructing Engineer.

feet, and engine room 60 by 33 feet; space is left for additional engines if required. The bay window in front is the operating room and occupies a commanding view of the line. In this room are the levers for controlling all the machinery, including the air brakes, electric signal from the cars and the indicator which shows the location of the cars on the incline. The indicator is also provided with an automatic electric alarm which rings a bell to announce the approach of the car when within 400 feet of the landing, and as a signal to lessen speed.

The upper portion of the station is fitted up as a waiting room and superintendent's office.

Power is derived from two 150-horse-power engines running at 120 revolutions per minute, and made by the Becket Foundry & Machine Company, of Arlington, N. J. Two Hallet boilers have

having three grooves. The cable takes three half wraps on each drum, and drums are equipped with Westing-

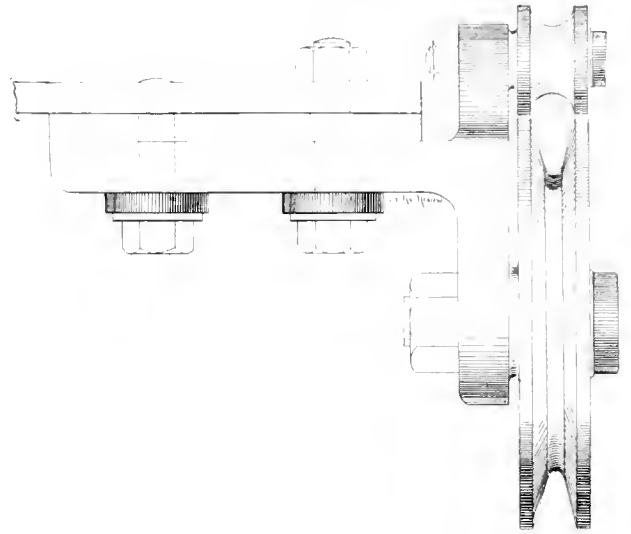

TROLLEY FOR ELECTRIC SIGNAL WIRE.

house air brakes. In addition to the driven cable, another of equal strength is carried around two horizontal drums also fitted with air brakes, so that in case anything should happen to the main cable the engineer has still full control of the car by means of the safety

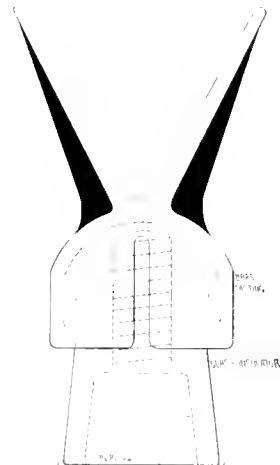

SUPPORT FOR SIGNAL WIRE.

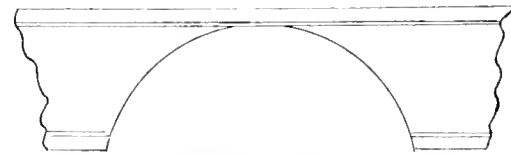

SIDE VIEW OF I BEAM.
As cut away for carrying pulley at Gregory Avenue Crossing.

rope. Each cable is $1\frac{1}{2}$ inch diameter, has a breaking strain of 90 tons and was made by Roebling. The cables are not endless, being permanently connected at the ends to

the cars, of which there are two, working as a counter-balance. These cars are also somewhat of a departure

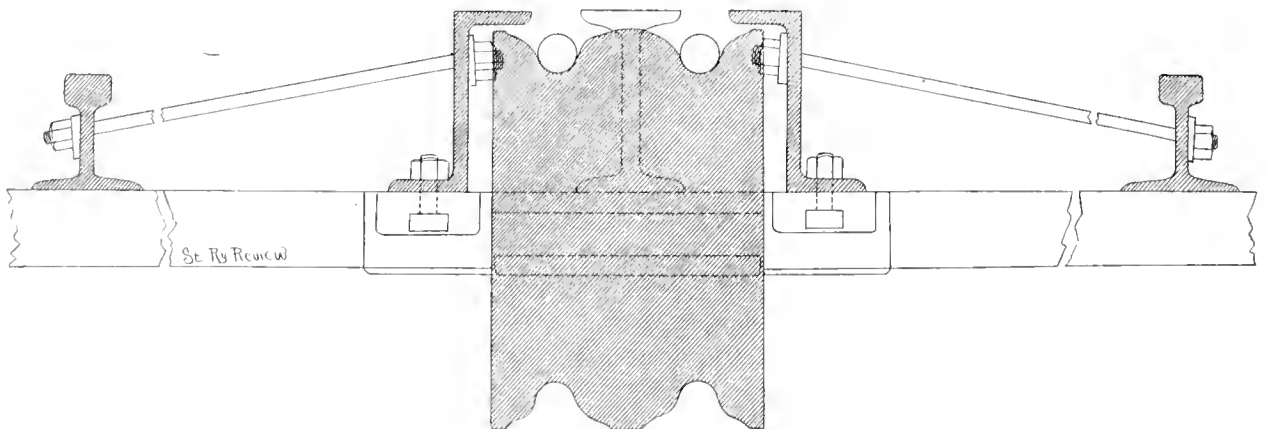

CROSS SECTION OF TRACK AT GREGORY AVENUE CROSSING, SHOWING CONDUITS FOR HAULING AND SAFETY CABLES.

a capacity of 400-horse-power. There are two winding drums, each 8 feet diameter, weighing 10,300 pounds and

from the regulation inclined plane cars, being mounted on two 4-wheel trucks in which the lower wheels of each

truck are 42 inches diameter and the upper wheels 28 inches. The distance from rails to car floor is 18 inches at upper end and 61½ feet at lower. The cars are 44 feet long over all by 16 feet wide, and weigh 16 tons each. The passenger room seats 15 persons with standing room for an additional 25, while the space for transporting vehicles is 10 by 44 feet.

A neat, strong railing incloses the platform, and the car travels at a speed of 750 feet per minute. Trips begin at 7 o'clock in the morning and continue until 7 p. m., but the hours will be lengthened soon. On Sunday, May 21st, 5000 passengers were carried up the mountain, from the summit of which a magnificent view is presented of the surrounding country.

MOSES G. FARMER.

IT is not probable that many street railway men, as indeed many electricians, have ever heard of Moses G. Farmer. This does not tend to prove the less of importance of Professor Farmer's deeds and personality, but rather shows that the intensely active growth of electrical science has made

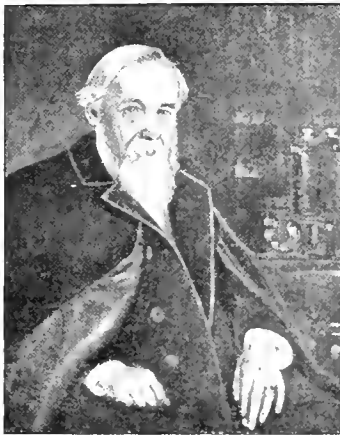

MOSES G. FARMER.

the earlier efforts of men of mature age read like the narratives of a century ago. Professor Farmer, whose very active and efficient life closed May 25, 1893, at his temporary Chicago residence, was born at Boscawen, N. H., Feb. 9, 1820, of Puritan parentage.

His father was a well-to-do farmer and lumber dealer, so that

the young man's scholastic tastes were gratified by a thorough training at Andover academy and Dartmouth college, from which institution he was graduated with a thorough scientific knowledge of all that was then known of electricity. After teaching school and entering into various manufacturing enterprises which yielded good profits, Professor Farmer began his best known work in electrical lines. His first commercial work was the building of a telegraph line from New York to Boston, in 1847. About this time also he invented an electric fire alarm service, which was subsequently adopted by the city of Boston and which for forty years did good service.

It was in 1847, though, that the electric railway patents were granted, and a small experimental line built which used primary batteries. The motor was successful to all intents and purposes, and was undoubtedly one of the earliest attempts at an "electro-magnetic engine." The engine pulled a passenger car and each was four feet long, well made and mounted on 6-inch wheels.

This engine and car was exhibited throughout New England, and form in reproduction part of a World's Fair exhibit of Professor Farmer. His other inventions of multiple telegraphic transmission and fire alarm, together with minor devices, brought a comfortable income, which he applied to the good uses of philanthropy. For many years Professor Farmer was stationed at the torpedo station off the Rhode Island coast, near Newport. His residence in Chicago was occasioned by the intense interest he took in the electrical exhibit at the World's Fair.

The beautiful open hearted character of this man gained a large circle of friends in Chicago, who mourn his loss in common with numbers in the East.

A FREE LIST FIEND.

ONE Hunter, a city father of Kansas City, has an eye to the dignity of office that would turn Malvolio green with envy. This alderman prepared an amendment to the ordinance to extend the Vine street line franchise. The amendment reads that all Judges of the United States and State Courts in Jackson county, Mo., and all clerks of said courts and their deputies, and all the marshals of said court and their deputies, and the sheriff of said county and his deputies, and all justices of the peace of said county, and all the constables of Kaw township and all their deputies, and all the elective and appointive officers of said county and city connected with the administration of justice in said county, including all policemen, the city engineer and all his assistants, the members of the board of public works, and the members of the board of park commissioners, and all members of the city council, shall ride free. We pause for breath to inquire who will pay fare in Kansas City, Missouri.

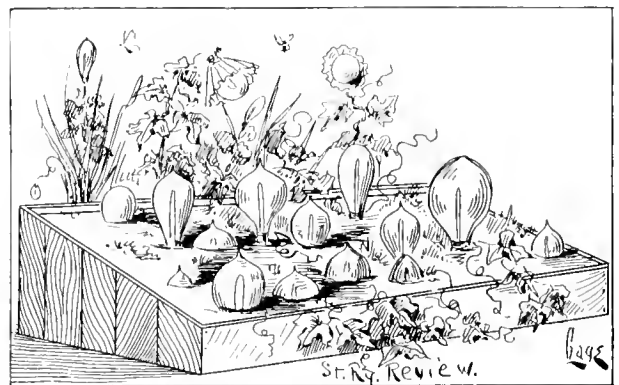

A LATE SPRING, BUT THE CROP IS COMING ALONG NICELY.

THE Stoven Rail Joint Company, of Fairfield, Iowa, is incorporated with Geo. A. Willis of Fairfield as president.

DR. F. BRAGG, of Dayton, Mass., is the inventor of a patent safety fender, which on trial, picked up sawdust men with safety and dispatch.



By a decree of the French minister of public works it has been decided to found a chair of industrial electricity at the school of mines.

LEAD covered cables insulated with paper are being made by Siemens & Halske, of Berlin. Their insulation resistance is said to be very high.

THE Havre, France, Tramways have received a 50-year concession, and will in consequence provide new rolling stock and better accommodations.

THE General Electric, of Berlin, have made a 50-horse-power multiphase current motor for the World's Fair. It is entirely without commutators or collecting rings.

THE Tudor Accumulator Company makes a secondary battery cell weighing nine tons, and having a capacity of 27,000 ampere hours, and a maximum charging current of 4,800 amperes.

THE Madras Electric Tramways Company have asked for an extension of time, six months, which will probably be granted if the authorities are satisfied that the scheme has sufficient capital behind it.

HERR BORK a German engineer publishes his opinion that to run trains at the rate of 40 or 50 miles an hour by electricity would require only 60 per cent of the power used with steam locomotive traction.

THE Munich Horse Tramway Company has decided to introduce electric traction on their lines, and the Allgemeine Berberner Electricitats-Gesellschaft are to be entrusted with the necessary operations.

A SINGLE track cable line has been built at Matlock Bridge, England. The grades were very steep and the road too narrow for a double track, so that a single track with turnouts was resorted to. G. Groydon Marks is the engineer of the line.

THE Compagnie des Tramways of Paris have decided to adopt a storage battery system, and the cars will be fixed to run in trains. Each car has a 15-horse-power motor on each axle, the speed to be eight miles an hour inside, and ten miles an hour outside the city.

THE Russian Minister of Transportation, with wonderful promptness, has just issued the Russian railway statis-

tics for 1890. There were at that time 18,158 miles of track with 6,933 locomotives. The fuel used was 36 per cent wood, while the petroleum used amounted to one-sixth of the total fuel.

THE Omnibus & Tramway Company of Lyons, France, says Science et Commerce, is about to introduce the trolley, and to that end have decided to contract with the Thomson-Houston Company. The power will comprise two tubular boilers, two 150-horse-power McIntosh-Seymour engines, and two Thomson-Houston railway dynamos.

THE Calcutta Tramways which have been in operation for over twenty years, recently threatened to shut down on account of the exorbitant sums it has to pay the city government. The amount paid for track rental and right of way is over five times that paid ten years ago, and with prospects for an increase. The dividends were increasing in an inverse ratio, with prospects of their sinking out of sight.

A CORRESPONDENT of the London City Press says he can recall the day when an omnibus passenger was required to pay his fare on leaving the vehicle, and how often a line was kept waiting on some old lady who, even in that primitive time, could not find her pocket. On suggesting the ordinary method of collecting, the conductor replied it could not be done without offense to the passengers. The same correspondent suggests another innovation which he calls "stamps," and means in United States dialect—ticket.

IN a paper read before the English Society of Engineers, H. Conradi stated that local authorities usually prohibited the tramways from cleaning their rails, unless means were taken for also collecting the mud after it was cleaned off the rails. He then described a form of scraper he had designed for this work. The quantity of mud collected from a mile of single track varied from 70 to 770 pounds per mile of single rail. He claimed that horses would last eighteen months longer on roads where the rails were cleaned than where they were not.

THE Berne, Switzerland, compressed air tramway is at present exciting a good deal of interest. The peculiar feature of this system, which is known as Mekarski's, is that steam is mixed with the compressed air—in order to keep its temperature from falling too much when the pressure is lowered—and so reducing the air pressure to a point too low for use on the engines. The air is compressed in a central compressing station, and after passing through dryers is sent out in pipes to the so called accumulator stations, where it is stored in tanks preparatory to delivery to the car. At these accumulator stations are also the boilers furnishing the steam to be mixed with the air. The motors are like a common steam motor, and the storage tanks are under the car floor.

THE FIRST ELECTRIC RAILWAY IN SOUTH CAROLINA.

THE opening of the Columbia Electric Street Railway, has given the capital city of South Carolina, a stirring and business air. Rapid transit was one thing Columbia needed, for it is a city of magnificent proportions, with broad streets lined with beautiful shade trees; with every natural advantage to make it large and prosperous. Situated half way between the mountains and the sea, its climate is most equable, and peculiarly free from either extreme heat or cold; making it a most delightful residence in summer or winter.

Its climate is probably one of its least advantages, as they are estimated in this busy age of progress. Columbia possesses manifold advantages, as a manufacturing and commercial center; which it is destined soon to become. Located directly in the center of the state; with the Broad and the Saluda rivers forming themselves



COL. J. Q. MARSHALL,
President.

Public attention has been directed for several years to Columbia's large cotton oil mills, and phosphate industries, which bring in a large revenue.

COLUMBIA'S ELECTRIC STREET RAILWAY

is her latest enterprise, which every citizen feels doubly proud of, because it is the first electric street railway in South Carolina, and is strictly a Columbia enterprise. The Columbia Electric Street Railway, Light & Power Company was organized on the sixth day of January, 1893, by a special act of the General Assembly, of the State of South Carolina, and has an exclusive franchise for the electric railway and the electric lighting of the city, together with the furnishing of power for industrial purposes. The company purchased the Congaree Gas & Electric Light Company, the only electric light company in the City of Columbia, and also purchased the Columbia Street Railway Company, a road operating its cars by horse power. It was evident that a change from horses to electricity was necessary to give a satisfactory railway service, and more power being necessary also to extend the lighting system of the city, the company purchased from the State of South Carolina, five hundred horse-power of water power, on the Columbia canal, at



CORNER MAIN AND WASHINGTON STREET.

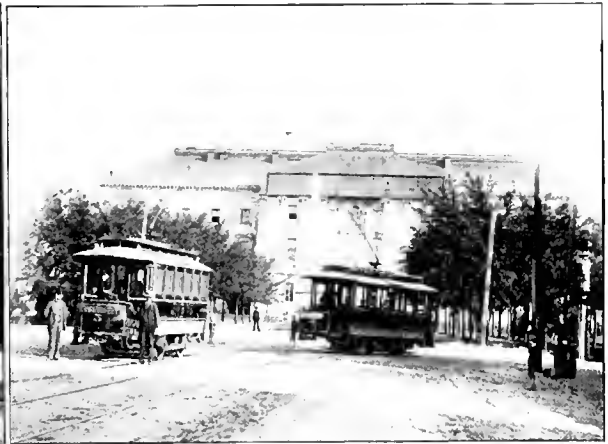

CONFEDERATE MONUMENT AND STATE HOUSE.

into the Congaree, just at its doors, these rivers afford water power unsurpassed in the whole South.

Its railroad facilities are exceptionally favorable to its business prosperity. Ten railroads radiate from Columbia, giving it competing lines to the north, west and south; also to the seaboard of Charleston, Savannah, Wilmington and Norfolk. A great canal has just been completed which will develop 13,000 horse-power of water power. Therein lies future wealth and manufacturing glory for Columbia. This canal is recognized to be the finest in the South, and was recently purchased by a Boston syndicate, which is also erecting a large cotton ducking mill which, when completed, will be the largest mill on the south Atlantic coast. Another \$500,000 mill is also in progress.

an annual rental of \$5 per horse-power, where they have erected their power plant.

The plant contains two Victor turbine register gate wheels, capable of developing 830 horse-power under a 26 foot head; and a 600-horse-power engine, made by James H. Corliss, to be used as an auxiliary when necessary. Power house is 50 by 40 feet with generators on the second story. The horse car system was changed to electric the early part of the present year, using a 50-pound T rail, laid on pine heart ties, in gravel ballast.

The road is five miles long, passing through the principal business and residence streets of the city, upon which the company operates six elegant cars, made by the Lamokin Car Works; the McGuire trucks are used, with six foot wheel base.

The Short system was selected and that company given the contract for the overhead work and rail bonding. The equipment consists of two 20-horse-power single reduction motors on each car. Generators are two 133-horse-power. The electrical work has been done under the supervision of R. L. Caldwell, of the Short Company. Mr. Caldwell's skill as an electrical engineer enabled him to overcome many difficulties which arose in the construction and equipment and since the opening of the road, on May 6th last, everything has been a perfect success.

The company is so well pleased they will commence an extension at once into the suburbs, giving a belt road when finished, of ten miles of track.

The constructing engineer, R. L. Caldwell, commenced electric railway work in the laboratory of Denver University, under Professor S. H. Short, during the winter of 1883-4. Professor Short was at that time commencing his experiments with the series system of electric traction. After two years engagement with the Denver Tramway Company he went into electric lighting work and installed the arc and incandescent lighting plant of the Iron Silver Mining Company, at Leadville, Colorado. At the earnest request of Professor Short, who was then at Columbus, Ohio, he again in 1888 took up electric railway work. While in the construction department of the Short Electric Railway Company he superintended the construction of nine roads, the total mileage being one hundred miles and the number of cars operating 180. This is a showing of which few constructing engineers can boast.

The personnel of the Columbia Electric Street Railway Light & Power Company is made up from the best business men of the city. Colonel J. Q. Marshall, a member of the Columbia bar, is president, and was for years Secretary of State, but on retiring from that office turned his attention to business pursuits. Being public spirited as well as enterprising, he saw at once the importance of an electric railway for this growing city and set to work to obtain control of the two properties above mentioned. In doing so, he associated with him the following strong board of directors: Dr. T. T. Moore, vice-president of the Workingmen's Building & Loan Association; W. A. Clark, president of the Carolina National Bank; Dr. James Woodrow, late president of the Central National Bank; W. G. Childs, president of the Bank of Columbia; Geo. B. Edwards, president of the Exchange Bank & Trust Company, of Charleston, and also president of the Charleston Electric Light Company, and W. H. Lyles and John T. Sloan, Jr., attorneys. Alfred Wallace, superintendent of the company, is a young man, self



R. L. CALDWELL.

made, painstaking in his attention to business and keenly alive to the interests of the company.

FUN IN 'FRISCO.

AS the clocks were striking the hour of midnight on the night of May 28, a small army of 400 men armed with picks, shovels and other tools, marched forth from the power house of the Omnibus Cable Company and proceeded to the corner of Third and Market streets.

The order to "charge" was at once given and in less than an hour ten sets of side poles for electric railway wires were firmly planted in cement, and material was on hand to occupy an hundred more holes which by this time appeared along the curbs. The superintendent of streets, however, chanced along, and hieing himself to the Mayor secured sufficient police force to stop work.

The company were relying on securing an injunction restraining the city from removing the poles, but the mayor anticipated this and with another large force pulled the offending monuments all up before breakfast. The company were constructing under a franchise granted in February, 1892, while the mayor falls back on a subsequent order of September, same year, which forbids the erection of poles in a certain district which includes the mooted territory. Altogether both parties made a lively night of it, and the dawn of a final settlement has not yet appeared.

A. W. MESTON, Superintendent of the Emerson Electrical Manufacturing Company of St. Louis, died of consumption at his home May 12. He was known as a hard worker on electrical problems. The Emerson Company was formed around his laboratory and attained its present proportions under his care.

THE Indianapolis Board of Public Works refused the Citizens Company permission to make some greatly needed improvements, giving as a reason that they could not allow anyone to cut the asphalt paving. If the chapping process is the only feature which cuts the aforesaid Board, President Mason might possibly obviate that difficulty by running a red hot iron from his trolley circuit and meeting a hole in the precious asphalt.

A Restaraunt on Wheels.

May 15th the first cafe car was put in service on the Wabash Railway fast day train between Chicago and St. Louis. The car is nothing more or less than a first class restaraunt on wheels. A passenger can spend 25 cents or \$5.00 in it for a meal. Steaks and meats of all kinds will be supplied and in that and many other respects it will differ from a buffet car. The car is entirely devoted to the cafe, but the seats are as comfortable as the Pullman seats, so a passenger can take his time at lunch. The car is attached to the train at all times and the cook is at all times ready to serve short orders. This restaraunt car is an original idea of the Wabash management and will probably be a success. The Chicago & St. Louis Limited leaves Chicago at 10:32 a. m. daily, except Sunday, arriving in St. Louis at 6:45 p. m., making the fastest time between Chicago and St. Louis. Time, eight and a quarter hours.

PERSONALS.

E. R. STETTIRIUS has assumed the duties of treasurer of the Stirling Company.

J. W. CLARK, of the Helena, Montana, Street Railway, was a June World's Fair visitor.

ALFRED G. HATHAWAY, of Cleveland, will be a World's Fair visitor during the latter part of June.

RUDOLPH EICHEMEYER and his partner, Mr. Osterheld, of Yonkers, New York, spent a few days at the Fair.

WM. ROBINSON, of the Robinson Radial Car Truck Company, spent a few May days in the Exposition city.

W. W. PRIMM, draughtsman in the department of electricity, has been appointed engineer of that department.

LIEUTENANT E. B. IVES, late U. S. A., is to take charge of the plans for the Frankforth & Southwork consolidation.

HENRY A. EVERETT, president of the Cleveland Electric Railway, spent two days in the city and at the Fair last week.

A. L. ROHRER, executive electrician, not electrocutive, of the General Electric Company, spent a May day or two in the Exposition city.

TREASURER PARKER, of the Scarritt Car Seat Company, of St. Louis, was the organizer of the World's Fair force of that company.

PETER MYNDERSE succeeds M. T. Leyden as superintendent of the Schenectady Street Railway. Mr. Leyden will devote his time to the works.

WILLIAM REEDY, assistant superintendent of the Reading, Pa., Traction Company, and Miss Katherine Salmon were married at Reading May 10.

B. PEARSON, of the Fuel Economizer Company, is here accompanied by his wife and will remain until October, looking after his company's exhibit.

JAS. R. GOODRICH, general manager of the Hartford & Wethersfield Railway, accompanied by his mother and sister, is among recent Columbian visitors.

F. COLEMAN BOYD, vice-president and general manager of the New Haven Register, of New Haven, is the World's Fair representative of that device.

A. E. LANG, of the Toledo Consolidated, has been awarded the Maumee electric franchise to carry passengers for three cents and children for one cent.

H. M. PERRY, Phoenix building, Chicago, representative of the C. C. H. Company, Albany, called at the STREET RAILWAY REVIEW World's Fair office.

JOHN M. JONES, West Troy, N. Y., representing J. M. Jones' Sons of the World's Fair, was a caller at the STREET RAILWAY REVIEW's World's Fair office.

M. H. GERRY, JR., Minneapolis, and connected with the Northwest General Electric, is a new associate member of the American Institute of Electrical Engineers.

J. C. SCHAFFER, of Indianapolis, and also of the Sea Shore Electric Railway, Asbury Park, N. J., has just finished his beautiful summer residence at the latter place.

CHAS. SMITH, of Philadelphia, took charge of the Lebanon & Annville, Pa., road as superintendent, June 1. He is the son of Cornelius Smith, of Annville, an old rail-roader.

WILLIAM LOXLEY, manager of the works of the Fuel Economizer Company, Matteawan, New York, is a Fair visitor. Mr. Loxley sails on a trip to England in a few weeks.

JAS. K. NEWCOMBER, president of the Delaware (Ohio) Electric Street Railway, made us a very pleasant call. This road is in very successful operation mainly owing to his efforts.

WILLIAM STEWART, northwestern agent for Siemens & Halske, was a recent visitor at Minneapolis, whither he conducted the Junior Siemens, now on a visit to the United States.

J. F. ESTERBROOK, electrical engineer who installed the South Chicago Electric, has returned from the East and is engaged on plans for further improvements to be made on the line.

W. S. NORMAN, of Spokane, Wash., who has been in New York for some time, returns to Spokane and it is believed his advent means the immediate completion of the Cour d'Alene Electric.

J. HOLT GATES, formerly selling agent of Siemens & Halske, of America, has recently become manager of the Wadell-Entz Company at Chicago. His successor with Siemens & Halske is C. A. Daigh.

L. T. GIBBS, for many months mechanical engineer of the Milwaukee Street Railway Company, resigns his position to devote his entire time to contract work and consulting. His office is at 1103 Pabst building.

CAPTAIN T. M. SMEDES AND JOSEPH HIRSH, of Vicksburg, Miss., spent a few May days in Chicago seeing the Fair and buying supplies. The gentlemen have spared no money in trying to give Vicksburg first class service.

CAUGHT ON THE RUSH TRIP.

American Street Railway Association.

D. F. LONGSTREET, PRESIDENT, Denver, Col.
 DR. A. EVERETT, FIRST VICE-PRESIDENT, Cleveland, O.
 JOEL HURT, SECOND VICE-PRESIDENT, Atlanta, Ga.
 W. WORTH BEAN, THIRD VICE-PRESIDENT, St. Joseph, Mich.
 WM. J. RICHARDSON, SECRETARY AND TREASURER, Brooklyn, N. Y.
 EXECUTIVE COMMITTEE—THE PRESIDENT, VICE PRESIDENTS, and JOHN G. HOLMES, Pittsburg, Pa.; J. D. CRIMMINS, New York City; THOS. MINARY, Louisville, Ky.; JAS. R. CHAPMAN, Grand Rapids, Mich., and BENJ. E. CHARLTON-Hamilton, Ont.
 Next meeting, Exposition Building, Milwaukee, third Wednesday in October.

Massachusetts Street Railway Association.

President, CHARLES B. PRATT, Salem; Vice-presidents, H. M. WHITNEY, Boston, AMOS F. BREED, Lynn, FRANK S. STEVENS; Secretary and Treasurer, J. H. EATON, Lawrence.
 Meets first Wednesday of each month.

Ohio State Tramway Association.

President A. E. LANG, Toledo; Vice-president, W. J. KELLY, Columbus; Secretary and Treasurer, J. E. HANNA, Cleveland; Chairman Executive Committee, W. A. LYNCH, Canton, O.
 Meets at Cincinnati on the fourth Wednesday in September, 1893.

The Street Railway Association of the State of New Jersey.

President, JOHN H. BONN, Hoboken; Vice-president, THOS. C. BARR, Newark, Secretary and Treasurer, CHARLES Y. BAYFORD, Trenton; Executive Committee, OFFICERS and C. B. THURSTON, Jersey City; H. ROMAINE, Paterson; LEWIS PERRINE, JR., Trenton.

The Street Railway Association of the State of New York.

C. DENSMORE WYMAN, PRESIDENT, New York.
 D. B. HASBROUCK, FIRST VICE-PRESIDENT, New York.
 JAS. A. POWERS, SECOND VICE-PRESIDENT, Glad Falls.
 W. J. RICHARDSON, SECRETARY AND TREASURER, Brooklyn.
 EXECUTIVE COMMITTEE.—D. F. LEWIS, Brooklyn; JOHN N. BECKLEY, Rochester, J. W. McNAMARA, Albany.
 The next meeting will be held at Rochester, September 19, 1893.

Pennsylvania Street Railway Association.

JOHN A. COYLE, PRESIDENT, Lancaster.
 JOHN G. HOLMES, VICE PRESIDENT, Pittsburg.
 H. R. RHODES, SECOND VICE-PRESIDENT, Williamsport.
 L. B. REIFSNEIDER, SECRETARY, Altoona.
 WM. H. LANIONS, TREASURER, York.
 Next meeting, Harrisburg, September 6, 1893.

Alabama.

MOBILE, ALA.—Mobile Street Railway Company authorizes issuance of \$350,000 in bonds to be used in electrifying road. Officers of company: Jas. Stillman, New York, president; Francis J. Ga-que, vice-president; W. S. Bogart, secretary, and R. Semmes, treasurer and general manager.

MONTGOMERY, ALA.—The property of the Cloverdale Electric Railway will be sold under order of the court on account of debt owed to Townsend & Brown to the amount of \$138,050. This means the consolidation of the Cloverdale and the Montgomery Terminal Street Railway. The merger will be completed soon and the combination capitalized at \$350,000. Improvements will be made then.

Arizona.

FT. SMITH, ARK.—Ft. Smith & Van Buren Electric Railway, to connect these towns, says it means business. Incorporated at \$100,000, of which \$20,000 is subscribed, by W. C. Lemert, Jas. B. Gounly, Miles N. Beaty, A. F. Howard, Wm. Blair, F. T. McClure, and R. C. McClure. The road will consolidate lines, do a general freight and passenger business, and heat, light and power, pleasure resort, etc.

PHOENIX, ARIZ.—Henry L. Wharton has had his franchise extended sixty days from May 6. Joseph Campbell, mayor.

PHOENIX, ARIZ.—The name of the Valley Street Railway Company has been changed to the Phoenix Street Railway Company and stock increased to \$1,000,000. William Christy, B. N. Pratt, H. B. Mitchell, C. H. Cinsworth and George W. Craighead are the directors. B. N. Pratt continues as secretary and manager. Contract for power house let.

Arkansas.

HOT SPRINGS, ARK.—Central Avenue Citizens' line will extend street railway to the river, and raise \$5,000 bonus. Col. S. W. Fordyce, receiver, is interested in the enterprise.

California.

LOS ANGELES, CAL.—It is now assured that the Los Angeles Consolidated Electric Company has bought the City Street Railway Company plant at Pasadena with 3½ miles track and franchises. New track will be laid and betterments made.

OAKLAND, CAL.—Henry C. Roberts, of Azusa, petitions for franchise for steam or electric street railway 4½ miles long, to connect city and suburbs. Hearing, May 17.

SANTA ROSA, CAL.—Central Street Railway elects J. D. Barnett, president; J. W. Warboys, secretary. The Union (South Side) road elects B. M. Spencer, president; G. E. Grosse, vice-president; J. W. Farnham, secretary.

SANTA ROSA, CAL.—Morris Electric Railway Company incorporated by J. W. Morris, of Oakland; M. L. McDonald, Santa Rosa; H. A. Morris, Oakland; W. A. Scott, San Rafael, and L. L. Lewis, of Sacramento. The amount of capital stock is \$100,000 of which 10 per cent has been paid to Treasurer McDonald.

Canada

ST. STEPHEN, N. B., CANADA.—City Government gives Calais Company right to build in St. Stephen. Frank Todd, of St. Stephen, controls charter. Fred Coleman, of Fredrickton, N. B., talks of building to that place and Marysville. Considerable building will be done in this section.

HAMILTON, ONT.—Hamilton Radial Electric Railway seeks franchise. Adam Zimmerman, C. M. Counsell, John Patterson, W. A. Wood, et al., are interested.

WATERDOWN, ONT.—John I. Flatt, C. E., Toronto, has been sent by Sir W. P. Howland to survey the Hamilton-Guelph line.

Chicago.

CHICAGO.—G. E. Pratt sells first World's Fair order of Lamokin cars to E. D. Nelson, Ironwood, Mich.

CHICAGO.—John Mohr & Sons, Chicago, incorporate at \$100,000, to make boilers, machinery, engines and tools; John, Joseph and Louis Mohr.

CHICAGO, ILL.—C. H. Gurney of 247-49 Lake street, says that the North Side Electric is bona fide and has capital behind it. Some suspect Mr. Yerkes of being the "capital."

CHICAGO.—Organized: Elston Construction Company, at Chicago; capital stock, \$100,000; to construct and equip street and other railways; to purchase, lease, operate and equip street railways; to manufacture and deal in railway supplies; and to do a general construction and manufacturing business. Incorporators: Franklin H. Watriss, Jacob B. Breese and William R. Odell, all brokers and bond dealers at 111 Monroe street.

Colorado.

DENVER, COL.—Denver Consolidated re-elects old board; E. W. Rolins, president; vice-president, W. G. Fisher; manager, Flintham.

DENVER, COL.—L. G. Kimball, E. E. Summers, William Thorne, E. C. Skiles and Charles E. Skiles file incorporation of the Pleasure Resort Electric Railway Company from North Denver to Rocky Mountain Lake.

PUEBLO, COL.—The Union Street Railway is incorporated at \$100,000 to build to Bessemer, see previous daily, by J. P. Higgins, O. W. Malaby, C. F. Ray, and E. J. Wilcox.

District of Columbia.

ALEXANDRIA, D. C.—Dan W. Holden is superintendent of the Alexandria Road, vice H. S. Cooper, resigned.

Florida.

PENSACOLA, FLA.—Pensacola Terminal Company owning street railway and dummy line goes into W. H. Northup's hands as receiver. Northup is a Pensacola man.

Georgia.

ATLANTA, GA.—M. R. McAdoo resigns as superintendent of the Atlanta Consolidated.

ATHENS, GA.—J. T. Voss is in the North in the interests of the Street Railway Company. He will do some buying in New York and Boston.

ATLANTA, GA.—The new electric line is known as the Atlanta City Street Railway Company, and the company is officered by Aaron Hass, president; W. I. Zachry, vice; J. B. Zachry, secretary, and F. H. Talbot, superintendent. Long extensions will be made to surrounding villages in time.

Idaho.

POCATELLO, IDAHO.—The street railway people meet at Lawyer C. A. Warner's office and resolve to build line. Write all communication to Mr. Warner.

Illinois.

PEORIA, ILL.—General Electric, of Chicago, gains control of Fort Clark Electric Railway. Local officers resign.

HOOPESTON, ILL.—The Hoopeston Railway Company at Hoopeston; capital \$40,000, to construct and operate a street railway; incorporators, J. P. Dyer, Dale Wallace, J. S. McFerrer, R. T. Mishimen, N. R. Clark and A. H. Trego.

PEORIA, ILL.—F. O. Cunningham, W. T. Whiting, Peoria; G. H. Atkins, J. S. Cummins, F. W. Horne and T. P. Bailey, of Chicago, incorporate new company for Ft. Clark line. B. K. Otis, secretary and treasurer; vice, Willis Hall. The Elizabeth street line will now be built.

FREEMONT, ILL.—Incorporated: The Freeport City Electric Railway Company, Freeport; capital stock, \$100,000; incorporators, Chas. D. Haines, Kinderhook, N. Y.; J. B. Taylor and Cyrenus H. Seeley.

EAST ST. LOUIS.—Belleville Steel Company confess judgment for \$3,371. Assets, \$940,000; liabilities, \$500,000. Chas. Becker and Bernard Yock, receivers, will continue the business without intermission.

Indiana.

MUNCIE, IND.—Aretus W. H. Hatch, Williard C. Nichols, Edward McDevitt, Jas. C. Devor are organized as the Muncie Electric Street Railway Company at \$200,000 capital stock. The company will have a branch office at Indianapolis and operate in Muncie and Delaware county.

MUNCIE, IND.—Lew Wallace Jr., representing the Russell Harrison syndicate, says that Muncie will have another electric line. Line will be built immediately.

LA PORTE, IND.—Chicago contractors are inquiring about street railway prospects here. There is no line here and earnest men could get franchise and local help.

INDIANAPOLIS, IND.—It is said that Secretary A. A. Anderson and Purchasing Agent Hazelrigg, of the Citizens' road, have lost their heads under the new management. President Mason will be purchasing agent.

CONNERSVILLE, IND.—John B. McFarlan, Sr., C. E.; J. M. McFarlan, J. E. McFarlan, et al., gain franchise for street railway and capitalize at \$25,000. Franchise for fifty years at good terms. Electric line will be built and in operation by September, 1905.

LA FAYETTE, IND.—Adam Herzog will build power house for Street Railway Company.

NOBLESVILLE, IND.—It transpires that Paul Pontus, Philadelphia; Illinois Electric Railway Company, Chicago; N. D. Potious, W. B. Keep, J. E. Cranc, C. W. H. Johnson, Chicago, are in the scheme for the big interurban electric.

CRAWFORDSVILLE, IND.—Franchise granted to Alexander F. Ramsey and Jos T. McNary for street railway. Thirty days to accept. C. M. Scott, city clerk.

INDIANAPOLIS, IND.—R. T. McDonald's representative takes his place in the Citizens' directory. R. W. Clay, of New York, succeeds W. J. Holliday as director. All other officers retained "Broad Ripple line will be built," says McDonald's man.

INDIANAPOLIS, IND.—Citizens' Street Railway Company files blanket mortgage on all property to the Solicitors Loan & Trust Company, Philadelphia, to secure \$1,000,000 in bonds. It increases capital stock from \$1,000,000 to \$5,000,000.

Iowa.

DUBUQUE, IA.—The Dubuque Light & Traction Company organizes to succeed the Dubuque Electric Railway Light & Power Company. Officers of new company are: President, Geo. K. Wheeler, Chicago; vice-president, W. J. Ballard, Chicago; secretary and treasurer, E. W. Duncan, Dubuque. The \$500,000 capital stock to be issued will represent the claims of first mortgage bondholders and the General Electric Company and American Car Company. Mr. Griffiths will remain superintendent. Improvements to the amount of \$115,000 will be made.

SIoux CITY, IA.—Receiver J. A. Jackson, of the Elevated, favors electrical equipment and will use his influence to that end. Work of changing has already begun and will probably be completed.

SIoux CITY, IA.—Jas. F. Peavey, president of the Sioux City Street Railway, made receiver for same under \$50,000 bonds. A. F. Nash applies for appointment. Metropolitan Trust Company, of New York, is trustee for the company.

SIoux CITY, IA.—Columbian Bank failure, Chicago, carries with it the Sioux City engine works. W. M. Thompson appointed receiver; assets, \$266,000; liabilities, \$200,000, to local concerns and St. Louis iron dealers.

DES MOINES, IA.—G. M. Hippee elected vice-president Des Moines Street Railway, and E. H. Hunter treasurer.

Kansas.

KANSAS CITY, KAN.—The L. road elects Robert Gilham vice-president and general manager. Waterman Stone, superintendent for last three years, has resigned.

STRONG CITY, KAN.—The Street Railway Company is talking of changing from mule to electricity.

Louisiana.

NEW ORLEANS, LA.—It is said that H. M. Littell, of the New Orleans Traction Company, and Alden McClelland, of the Charles Street Railway, are in line to unite the two roads. In such case Charles street will be electrically equipped.

NEW ORLEANS, LA.—On June 23 the St. Charles Street Railway Company will vote on increase of capital stock. President Alden McLellan says that the object is to establish more rapid transit, which means electric.

Maine.

PORTLAND, ME.—The Portland & Rochester Electric through the Saco Valley is under the consideration of men like H. K. Bradbury, of Salmon Falls; Chas. Butler, of West Buxton; C. B. Dalton, of Portland; J. A. Berry, of Bar Mills; Capt. William Sturgis, of Bonny Eagle; Melvin Small, of Limington, and many others. R. S. Brown, of the Westinghouse Company, from Boston, is assisting in the deliberations. Water power will be used.

BANGOR, ME.—In spite of failure of previous enterprise, Gen. H. L. Mitchell and E. C. Nichols, of Bangor; J. Manchester Haines and Geo. E. Macomber, Augusta, will attempt to build an electric road to Stockton Springs, a distance of twenty miles. All are good men and the scheme ought to carry.

BATH, ME.—F. H. Twitchell is treasurer of the new street railway; O. F. Williams, commissioner of streets; A. F. Gerald, of Boston; G. A. Murch, representing the Worcester Construction Company, and H. L. Pierce are in the company and the road is a "sure go."

Massachusetts.

NANTUCKET, MASS.—The Siasconset Street Railway Company failed to negotiate bonds and the steam line will run as usual for the year.

QUINCY, MASS.—The Manet Street Railway bought by the Quiney & Boston. Will be improved by the Q. & B. Company.

PITTSFIELD, MASS.—Street Railway Company awards rail contracts to Harrington, Robinson & Company, of Boston, and decide to award cars to Jones, of Troy.

BOSTON, MASS.—Reynolds T. White, J. Henry Norcross, Otis Eddy, L. P. Soule, Clarence Dorr, David McIntosh, H. B. Church incorporate as the White Electric Railway Company, at capital of \$250,000 a mile, single track.

CLINTON, MASS.—Clinton Street Railway obtains rights here and elects president, Harold Parker; vice president, Henry A. Wallis, of Fitchburg, board of directors, the above with Hon. H. C. Greely and Dr. Walter P. Bowers, of Clinton; Charles F. Baker, Wesley W. Sargent and George R. Wallace, of Fitchburg; treasurer, A. J. Witherell; clerk, W. R. Dame; auditor, B. F. Wallace.

PITTSFIELD, MASS.—P. A. Chase and R. L. Day & Company have sold their stock in the Pittsfield Electric Railway to eastern parties.

WORCESTER, MASS.—The State Central Traction Company accepts the Westboro, Northboro & Grafton franchise. Hon. Samuel Winslow, T. T. Robinson, Samuel Wood, et al, committee. The company wants to put in a line in the Seventh Ward, single track

FITCHBURG, MASS.—Fitchburg & Leominster will build line to Whalon Lake this summer. Directors of this line own Clinton, Mass., stock and will build new line here this year.

PLYMOUTH, MASS.—Plymouth & Kingston Street Railway votes increase of stock from \$70,000 to \$100,000.

ONSET, MASS.—I. B. Eldridge succeeds F. R. F. Harrison as superintendent.

CLINTON, MASS.—President Harold Parker, of the Clinton Street Railway will place order for an open car. W. W. Sargent, of Fitchburg, is consulting purchasing agent with Mr. Parker. Supplies will be bought soon.

Michigan.

DETROIT, MICH.—Ft. Wayne & Belle Isle Railway has completed purchase of Peppers and Irvine's Electric for \$15,000 from the Detroit Suburban Company. Will extend

BATTLE CREEK, MICH.—A. K. McRae, of Chicago, buys controlling interest in the Battle Creek Railway. New officers elected as follows: President, E. C. Hinman; treasurer, C. H. Harbert; secretary and superintendent, A. K. McRae. A new board of directors was elected as follows: E. C. Hinman, William H. Mason, John L. Beveridge, C. H. Harbert, and A. K. McRae.

ST. JOSEPH, MICH.—Stephen A. Douglas, Jr., Colonel L. L. Stephenson and J. F. Keyset, all of Chicago, think there is business for an electric railway along the St. Joseph river from St. Joseph to South Bend. They have had men over the route who see no engineering difficulties, and an electric railway between the cities mentioned is among the probabilities of the near future.

Mississippi.

JACKSON, MISS.—W. E. Hayne, of Jackson, and W. R. Gravelly, of New Orleans, gain franchise for electric railway for twenty-five years. Work to begin in six months and finish in twelve.

Missouri.

ST. LOUIS, MO.—A man representing himself as J. D. Ferris, superintendent of the Dallas Electric Railway Company, has victimized several supply dealers here. Beware of him.

ST. JOSEPH, MO.—The St. Joseph buyers elect Jas. T. Gardner, president, New York; J. R. Owens, St. Joseph, vice-president; Seth S. Terry, New York, secretary. Majority of stock owned by Harriman & Company, New York.

SPRINGFIELD, MO.—Metropolitan road elects H. F. Hobart, L. M. Rumsey, R. C. Kerns, C. M. Parker, C. B. McAfee, et al, directors.

ST. LOUIS, MO.—John Scullin resigns presidency of St. Louis Electric Street Railway Company. H. D. Sexton elected. Capital stock to be increased to \$500,000 from \$150,000.

CLAYTON, MO.—The Forest Park & Clayton Electric Railway will vote on proposition to increase capital from \$75,000 to \$150,000 on June 29.

KANSAS CITY, MO.—The Leavenworth Terminal Railway & Bridge Company advertises for bids on terminal building.

St. Joseph, Mo.—St. Joseph Street Railway Company is sold to James Gardner and syndicate of New York, at receiver's sale for \$365,000.

Montana.

HELENA, MONT.—L. T. Rock, of this city, is building the power house for the Bozeman Light & Power Company.

HELENA, MONT.—W. H. Clark, Richard Lockey, A. K. Barbour, and C. A. Cahill file the articles of incorporation for the Helena Rapid Transit Company. Capital stock \$500,000 and the company will build street railways of all kinds, electric light, heat and power plants.

CARTHAGE, MO.—A. W. St. John and Dr. A. H. Caffee are committee on street railways and will look up the Roger's franchise.

Nebraska.

OMAHA, NEB.—East Omaha Street Railway Company organized at \$1,000,000 by John Lawler, Welch and E. T. Stoberry, of Philadelphia, Geo. W. Holdrege, Henry W. Yates and A. S. Potter, Omaha. The company is building a line to Courtland Beach. It has a lease with the new bridge of the Omaha Bridge & Terminal Company for twenty-five years and proposes to build a road to Council Bluffs. It is thought that this company is the Philadelphia syndicate which has been trying to buy the streets railways of Omaha and St. Louis. The movement here means another aggressive competition or ultimate absorption.

OMAHA, NEB.—East Omaha Street Railway has elected president, Arthur S. Potter; vice president, Dudley Smith; treasurer, Henry W. Yates; secretary and general manager, Alfred B. DeLong; directors, Arthur S. Potter, H. W. Yates, A. B. DeLong, George W. Holdrege, Dudley Smith, John R. Webster and Charles C. George.

New Hampshire.

MANCHESTER, N. H.—Milton Mills Electric elects Edward P. Parsons, president; John E. Townsend, vice-president; C. W. Gross, M. D., treasurer; Freeman Loud, secretary.

New Jersey.

FREEHOLD, N. J.—J. C. Shafer, of Indianapolis, Ind, owner of the Asbury Park, N. J., Street Railway, has associated six railway men in the Monmouth County Sea Shore Electric Railway Company, with \$1,500,000 paid up capital, and will at once begin work upon a road extending from Pleasure Bay, near Long Branch, to Point Pleasant, passing through Long Branch, West End, Elberon, Deal Beach, Loch Arbor, North Asbury Park, Asbury Park, Ocean Grove, Key East, Belmar, Spring Lake, Como and Point Pleasant.

JERSEY CITY, N. J.—Austin Corbin's tunnel scheme has broken out again, headed this time by C. B. Thurston, Jersey City, president; B. M. Shanley, Newark, N. J., vice president; W. A. Patton, of Randor, Pa., secretary and treasurer; William J. Hehre, Everett R. Reynolds, of New York City; E. B. Gaddis, Arthur E. Sandford, and Thomas F. Brice, of Newark, N. J.; O. J. Derousse, of Philadelphia. William J. Kelly is secretary and treasurer of the two roads which are consolidated.

CAMDEN, N. J.—West Jersey Traction Company organized at \$5,000,000 by Huelings Lippincott, of the National State Bank, Camden; Howard Parry, of Cinnaminson; Mitchell B. Perkins and Henry Van Brunt, of Beverly; Samuel E. Stokes, Charles Tomlinson, George A. Aldrich, Dillwyn Wistar and John P. Logan, of Philadelphia.

There are five distinct routes to be operated by the company, as follows: Route No. 1 starts from Camden, and runs through Pavonia, Palmyra, Riverton, Riverside, Delanco, Beverly, Edgewater Park and Burlington, terminating at Florence. No. 2 goes from Camden via the Westfield turnpike to Burlington; No. 3 from Camden to Merchantville, Moorestown and Stanwick; No. 4 from Camden to Collingswood, Haddonfield and Berlin; No. 5 from Camden to Mount Ephraim.

WOODBURY, N. J.—The Camden, Gloucester & Woodbury Electric Railroad has elected the following officers: President, J. Willard Morgan; secretary, Thomas P. Curley; treasurer, Wm. J. Thompson.

NEWARK, N. J.—It is said that the Consolidated will make David Young general manager of the long extensions about to be made.

New York.

DANSVILLE, N. Y.—Incorporated, The Dansville Electric Railway Company, \$50,000. S. N. Blake, of Elmira, and D. O. Balterson, C. H. Rowe, William Kramer, of Dansville, are among the incorporators.

ROCHESTER, N. Y.—J. N. Beckley, Rochester; M. A. Verner, Pittsburgh; T. De Witt Cuyler, Philadelphia; R. W. Clay, Philadelphia; Cuyler, Morgan & Co., New York, and Fredrick Cook, G. W. Archer; W. S. Kimball, Max Brickner, Henry C. Brewster, Chas. H. Palmer, George Ellwanger, W. C. Barry, J. C. Hart, Bernard Dunn, Frank S. Upton, Fred W. Smith and William Purcell, Rochester, buy the J. C. Tone franchises for \$100,000 and will build to Windsor beach by August.

BUFFALO, N. Y.—Buffalo, Main Street and North Tonawanda is to be extended to Sanborn. L. F. W. Arend, builder. Incorporators are W. Arend, Ex-judge Davin Brundage and John H. Pardee, of Buffalo; Lee R. Sanborn, of Sanborn; Wilmer Brown, of Lockport; Fredrick W. Strassburg, of St. Johnsbury; Martin Meyer and Christian Goerrs, of North Tonawanda; Louis F. Paine and Edward S. Reisterer, of Tonawanda, and William F. Huggins, of Tonawanda.

HOOSICK FALLS, N. Y.—The Hoosick Railway Company, C. B. Story, manager, organizes at \$60,000. Directors are Joseph Buckley, Frank L. Stevens, Hon. L. E. Worden, C. B. Story, Watson M. Holmes and Timothy Hctor, of the village, and G. C. Moses and F. H. Twitchell, of Bath, Me.

NEW YORK CITY.—Judge Lacombe, U. S. Circuit Court, orders Central Trust Company to sell City Railway Improvement Company bonds at public auction. This winds up company and sells million and a half of bonds.

ROCHESTER, N. Y.—Rochester & Lake Ontario Railway reorganizes with new officers, preparatory to extensions and betterments: President, John M. Beckley; treasurer Fredrick Cook; secretary, Robert Post; directors, John N. Beckley, W. C. Barry, Fredrick Cook, W. S. Kimball; Max Brickner, George W. Archer and Frank S. Upton.

AUBURN, N. Y.—Electric Railway of Auburn incorporated at \$50,000, by Alexander Beal, E. B. Martin, A. L. Sweetser, A. L. Estabrook, of Boston; Frank A. Bemis, of Longwood, Mass.; E. F. Allen, of Medford, Mass.; Charles E. Eddy, of Newton, Mass.; Fredrick E. Stork and Geo. Underwood, of Auburn.

COHOES, N. Y.—C. P. Craig, E. H. Foster, Herman Kahn, H. C. Fruchting, Paul H. Andrea and Henry L. Shaver are interested in a local stock company to build a street railway line in Cohoes. About \$100,000 is in sight for the project.

NEW YORK CITY.—It is said that the Union Electric Railway now owns all the lines of the Westchester Company and the White Plains and Porechester lines. Thos. Ryan, of New Rochelle, has been made superintendent of the consolidation by President Thos. E. Crimmins. It is understood that John D. Crimmins is the real head of the company.

SYRACUSE, N. Y.—Jenny, Marshall & Jenny, of this place, and E. W. Emmons, of New York, are getting capital together to build street railway to Fayetteville.

JOHNSTOWN, N. Y.—The Cayadutta Electric has been granted its additional franchise for Water street.

WATERTOWN, N. Y.—Watertown Street Railway Company meets; present, President John C. Thompson, Vice-President C. A. Starbuck, Director J. A. Lebkuecher and Stockholder Geo. Krementz, of New York, and Manager E. S. Goodale and Senator Joseph Mullin, S. F. Bagg and Geo. W. Knowlton, of this city. Washington and State street extensions discussed but not decided. Earnings for last year paid expenses and fixed charges leaving small surplus.

SYRACUSE, N. Y.—East Woods Heights Electric Railway power house burns. Corliss engine, dynamo and cars destroyed. Loss is \$20,000; insurance, \$10,000.

BUFFALO, N. Y.—The mayor gives assurance that the Kensington franchise will be passed. Mr. Littell is the leading spirit, but H. C. Wadsworth, Clark L. Ingham, the Park Ridge Land Company, the Equitable Investment Company, Freeman M. Vilas, George A. Lee, Thorne & Angell and A. T. Fancher are heavy subscribers to the stock.

GLOVERSVILLE, N. Y.—The Fonda, Johnstown & Gloversville Railway passes into the hands of the Cayadutta Electric Railway Company. H. Walter Webb is said to have cleared \$200,000 on the change.

Ohio.

COLUMBUS, O.—D. McLean, of New York, is looking up prospects for a belt line and talking electricity for it.

DAYTON, O.—W. H. Simms, E. J. Barney, D. B. Corbin, Chas. B. Clegg and A. A. Thomas, of Chicago; C. J. Ferneding and J. C. Pierce incorporate at \$1,500,000 to buy and operate the Fifth street line, the Red line, the Green, the Richards and the Third street lines.

CINCINNATI, O.—Cincinnati, Erlanger & Covington Street Railway organized at \$25,000, by B. E. Talbot, of Knoxville, Tenn.; Frank P. Helm, O. J. Carpenter, Wes. B. Wilson, J. J. Dulaney, J. H. Mersman and John Dorsel, of Covington. The road has a good route and will have fair prospects.

CANTON, O.—The Canton-Salem Line Electrical Company has the contract for lighting Salem and increases capital \$150,000. A road will be built between the towns. The officers of the board are as follows: President, Hon. Jos. A. Linville; vice president, Robert A. Carran, Cleveland; secretary, Joseph B. K. Turner; treasurer, Anthony Housel; general superintendent, John Hadley.

FINDLAY, O.—T. P. Brown, Toledo, A. E. Lang, Toledo, and B. P. Foster, Findlay, are all after franchise in Lucas county.

CINCINNATI, O.—Brokers are looking forward to the issue of three and a quarter millions of stock of the Consolidated. It is now assured, and the proposition will be voted July 8. Transaction in Cincinnati stock therefore limited.

TOLEDO, O.—A. E. Lang wants more streets in the town.

TOLEDO, O.—A. E. Lang gets the Maumee franchise for ten years. Work of construction will begin at once, and supplies will be bought immediately.

CLEVELAND, O.—The Dorner & Dutton Manufacturing Company, capital \$100,000, incorporated; to manufacture street railway supplies. Henry A. Dorner, Wm. A. Dutton, A. C. Schwan, Geo. H. Schwan, and Benj. C. Starr.

COLUMBUS, O.—Judge Duncan dissolves injunction against the Columbus & Westerville, and says building may be proceeded with.

TIFFIN, O.—Fostria line organized, by President Rollo W. Brown; Vice-President Alonzo Emerine; Secretary Milton Saylor; Treasurer Rollo W. Brown.

TOLEDO, O.—The Toledo & Detroit Electric road is said to be projected by James McMillan of Detroit, and Millionaire Joy.

COLUMBUS, O.—Crosstown Street Railway agrees to buy rights and property of Leonard Avenue Company; 2,000 shares represented.

Oregon.

PORTLAND, ORE.—Portland cable in better shape. Mr. Seligman of the bondholders association, says that matters are in shape so that electric and cable extensions can be made. F. I. Fuller is at present receiver.

OREGON CITY, ORE.—Bridge and trestle work is being pushed on West Side. Line will be ready by July.

Pennsylvania.

PHILADELPHIA, PA.—The Lancaster & Philadelphia Electric Railway Company, of which Wm. A. Armstrong, Lancaster, is superintendent, will build the longest electric interurban in Pennsylvania, 69 miles, besides a line from Lancaster to Middletown, 27 miles.

MIDDLETOWN, PA.—The passenger and freight line from Middletown to Fredrick has filed its papers as the Middletown Valley Passenger Railway. Incorporators: C. V. S. Levy, Geo. Wm. Smyth, Dr. M. A. Sharretts, E. L. Miller, of Fredrick, and L. N. Downs, Theodore Browne, A. L. Nurman, of New York; capital stock, \$125,000.

WILKES BARRE, PA.—John B. Reynolds, Solomon Henlien, Dr. C. A. Spencer, et al., last April were granted charter for railway to Harvey's Lake. Right of way has now been secured for the new road, and it will now be pushed.

GREENBURG, PA.—J. L. Mitchell, A. O. Stevens, and Jas. Thompson, of Tyrone, Leonard Keck, of this city, et al., organize road at Latrobe, at \$1,000,000. The line will be pushed at once.

SHARON, PA.—Mr. Mattox, of Warren, O., et al., talk of a line from Warren to Sharon. Are acquiring right of way now.

PHILADELPHIA, PA.—R. N. Carson resigns presidency of People's Passenger Railway, and will be succeeded by Henry C. Moore.

MECHANICSBURG, PA.—The Harrisburg - Mechanicsburg Railway elects directors, N. Hamilton, A. G. Knisley, et al., Harrisburg, and J. A. Moore and S. M. Hertzler, of Camp Hill.

LANCASTER, PA.—It is understood that the Lancaster Traction Company has sold its entire plant to the Lancaster & Philadelphia Electric Railway Company. The president of the Lancaster & Philadelphia Company is the Hon. J. J. Patterson, of Millintown, Pa.

Rhode Island.

PROVIDENCE, R. I.—The Pawtuxet Valley Electric buys River Point Electric Light Company plant.

South Carolina.

CHARLESTON, S. C.—L. R. Casey, North Dakota, and E. R. Gilman, Chicago, are looking up their new purchase here of the Enterprise Street Railway.

Tennessee.

KNOXVILLE, TENN.—J. C. Duncan, receiver for the Knoxville Electric Railway Company, will build 6 miles electric line and furnish and install equipment.

KNOXVILLE, TENN.—Robinson Southern Electric Railway Company applies for a charter with headquarters at Knoxville. The scheme is to make an Electric Belt Line through Knoxville, Kingston, Oliver Springs, and other towns in Monroe county, with branches and spurs to carry freight and passengers. The incorporators are: W. Baright, L. D. Dillon, B. H. Sprankle, J. S. McDonough, J. S. Stewart, J. Luttrell, Murphy, A. J. Robertson, Henry Curry and J. A. R. Murphy.

WINCHESTER, TENN.—Paint Rock & Tennessee River Railroad Company applies by J. W. Hudson, B. J. Miller, B. G. Slaughter, G. G. Phillips, Henry Estill and J. Luttrell Murphy for charter to build a electric railway line from Winchester to Waynesboro.

NASHVILLE, TENN.—Incorporated; The Nashville Electric Railway directors are Otto F. Barnard, New York, president; Gordon McDonald, New York; E. B. Stahlman, Thomas Taylor, T. M. Steger, Nashville. These are the purchasers of the property.

Texas.

WACO, TEX.—Waco Electric Railway, Light & Power Company increases stock to \$300,000.

CORSICANA, NAVARRO COUNTY, TEX.—The street railway here has been leased by J. C. Savage, and cars are running regularly.

GALVESTON, TEX.—Galveston City Railway Company files mortgage to the New York Guaranty & Indemnity Company upon property and rights to secure issue of \$1,000,000 bonds previously negotiated. Bonds are 5 per cent, 21 year, and will be applied on debt and to better the property.

FT. WORTH, TEX.—The Ft. Worth Dallas Rapid Transit Company is about to take immediate steps towards building the line. S. M. Janey, Sam Hilner and John Hopkins, of Philadelphia; W. M. Phenix, of New York; E. L. Snodgrass, of Dallas, secretary, and E. E. Perkins, of Ft. Worth, are in the city consulting about the plans.

AUSTIN, TEX.—The breaking of the big dam is more serious than was apprehended. The electric works dependent thereon are consequently dubious.

Utah.

SALT LAKE CITY, UTAH.—H. M. McCartney, of the Utah & Nevada Construction Company, is at the head of a scheme to build a street railway to North Salt Lake.

OGDEN, UTAH.—E. R. Ridgely and C. E. Mayne elected directors of Ogden Street Railway, vice H. H. Henderson and Joseph Brinker, resigned.

PROVO, UTAH.—J. W. Young, who floated for \$40,000, \$100,000 of bonds for the Provo Street Railway, has gone suddenly to England and citizens threaten to bring him back with extradition papers. Citizens subscribed money to the road which was never completed satisfactorily.

Virginia.

RICHMOND, VA.—Street railway will put on six new cars this summer.

Wisconsin.

EAU CLAIRE, WIS.—Ralph E. Rust, of this city, appointed receiver for the National Electric. No stoppage in operation, and a reorganization is promised very soon.

WAUSAU, WIS.—Ross, Alexander Jones and Deenfield ask extension of one year on franchise. Good time for another company to bid for place.

GREEN BAY, WIS.—Chartered: Fox River Street Railway Company, at \$100,000, by Jackson I. Case, C. H. Holmes and Thomas S. McCullough.

MILWAUKEE, WIS.—The resignation of Mr. Villard from the syndicate and the election of Mr. Wetmore attracts some favorable comment here.

GREEN BAY, WIS.—"The Green Bay road," says Superintendent W. B. Harvey, "is a sure thing."

FON DU LAC, WIS.—Large force on work at power house; Ball engines arrived. Active operations will begin very soon. Small supplies not all bought yet.

MILWAUKEE, WIS.—Franchises and all property of the Milwaukee Electric Railway Company will be sold at auction at the court house on June 30, by E. J. Melms.

Wyoming.

SHERIDAN, WYO.—Incorporated: The Sheridan Electric Railway & Power Company, to operate at Sheridan; paid up capital \$30,000.

PATENT OFFICE GOSSIP.

A. J. MONHAM, of the Johnson Company, has this month patented two processes for electrically welding rail ends or other metals. The first of these, No. 496,890, consists in having, on the web of the rails to be welded, advance contact portions. One or both of these contacts is separated from the surrounding portion of the rail by grooves or recesses. Current is passed through these contacts and pressure applied, as in the ordinary electric weld. (See illustration) The other process, No. 497,808, is similar in that there is an advance contact piece on one or both of the rail ends. (See illustration). In this case, however, the contact

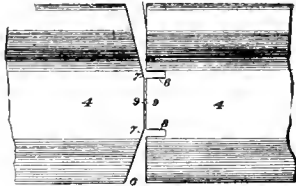

No. 496,890.



No. 497,808.

need not be a part of the rail end itself, and what is more important, the webs are first welded by passing current through the 'heads and feet' of the rails on opposite sides of the joint and then welding the heads and feet of the rails by passing current through the joint. These patents may have an important bearing on the rail welding of the future if the welding of rail joints is to become common.

ANOTHER attempt to solve the joint problem is found in the combination girder joint and chair of M. M. Suppes, Johnstown, Pa., here illustrated as No. 496,916.

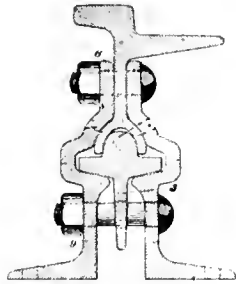

No. 496,916.

ALEXANDER WURTS, of the Westinghouse Company, secured a patent (497,397) on his already well known tank lightning arrester; the general plan being here shown. The principle consists in connecting the trolley lines to the ground through a high but non-inductive resistance of running water; a variable number of inductive coils

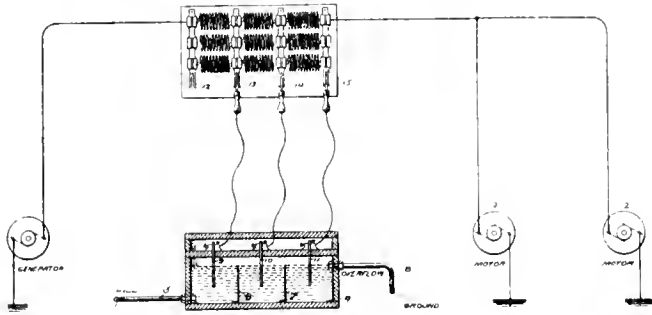

No. 497,397.

can be interposed between the arrester connections and the generator. The idea is to provide a permanent path to earth for discharges; obviating the necessity of their jumping an air space as in most arresters.

CONDUI electric railways are still on the increase and Geo. Westinghouse, Jr. takes out two patents among the numerous others. This line

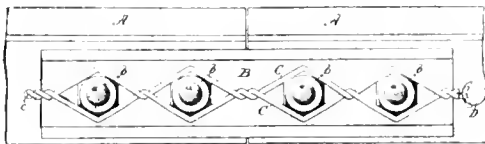

No. 497,963.

of patents is beginning to rival that of car couplers and promises to be about as barren of useful commercial results. The complexity of most of them is something fearful to contemplate.

AN attempt to make rail bonds do service as nut locks at the rail joints is shown in the illustration of 497,963, this patent being the property of Albert L. Johnson, of Cleveland, the well known street railway man and inventor.

A. J. MONHAM adds No. 498,074 to his long list of patents on railroad rails and chairs and processes of uniting the same. The drawing explains itself when it is understood that it is intended to weld the chair to the rail.

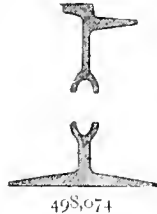

498,074

Two electric railway patents, Nos. 497,024 and 497,025, were issued to Rudolph M. Hunter, of Philadelphia assignor to the Thomson-Houston Company. The first named is a system of sectional conductors for supplying current to the cars, these sections being connected to the main feeder through electro magnetic switches. Provision is also made for a current controller at the dynamo. The other patent of Mr. Hunter's, No. 497,025, seems very much like a description of a modern electric railway. It claims the combination of a dynamo, an overhead conductor, a car with an electric motor connected with the car axle, a hand regulator on the car, an upward pressing grooved contact connecting the traveling vehicle with said conductor, and a return circuit through the rails. Both these patents were filed in 1886. Electric railway patents and trolley patents seem to be getting into a hopeless tangle that will probably never be straightened out.

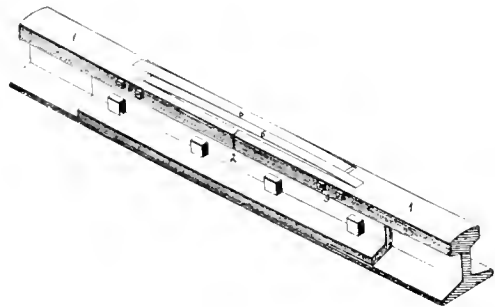

No. 497,834.

No. 497,834 is a device to alleviate the hammering of rail joints by bridging the crack between the rail ends with two flat steel springs, as here shown.

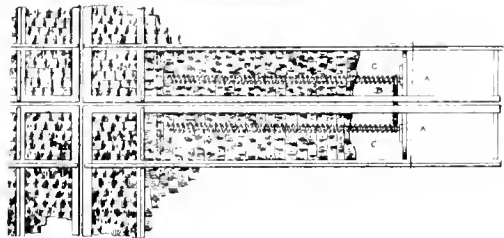

No. 498,215.

A "DEAD MAN" for cable road crossings, (498,215), invented by Henry E. Pochman, is designed to lessen the speed and sound a warning gong before the grip strikes the immovable obstruction. The drawing makes plain the method of accomplishing this.

498,577 is of interest as being one of those covering the ironclad motor. It is for a motor having a cylindrical field magnet frame with inwardly projecting pole pieces. One half of the cylinder is hinged to one end of the frame and the other half to the other end of the frame.

CHARLES ZIPERNOWSKY, the well known European inventor, takes out what appears to be quite an important patent on alternating current distribution for railway purposes. It is intended of course for use in the long distance transmission of power for railways. It designates a system of primary alternating current mains from which current is supplied to alternate current motors at points along the line; these alternate current motors driving continuous current dynamos which latter supply the railway motors. To start the alternating motors and bring them to a synchronous speed current is at first supplied to the secondary continuous current circuit thereby driving the dynamos as motors.

WILLIAM D. PATERSON, of Keokuk, Ia., has a patent (No. 497,337) on an overhead trolley system which comprises numerous features, the principal one being that the trolley is supported on brackets at frequent intervals above two heavy supporting wires. The trolley wheel is of course downward pressing. It is impossible for the trolley wire to fall in the street unless it and the two supporting wires all break at once.

No. 498,408 differs from the ordinary trolley in that it has a telescopic end section and a spring for pushing out the telescope.

THE claims of 408,435 can be seen by a glance at the drawing. It is apparently another "fundamental" patent on the upward pressing trolley.

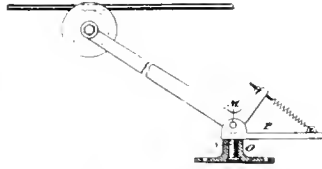

No. 408,435.

No. 497,569 is a street railway switch invented by Jno. B. Gough, of Providence, R. I. It is designed to be operated from the car. This is accomplished by having a small projection on top of the switch point which is struck by a bar on the car so that the point is thrown in the desired direction.

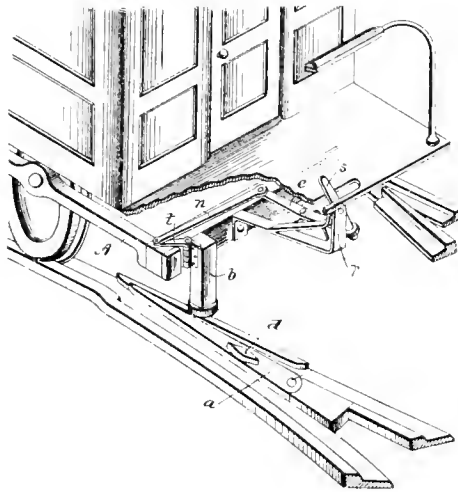

No. 497,569.

STREET RAILWAY PATENTS.

Selected list of patents relating to Street Railway Inventions, granted during the past thirty days, reported especially for the STREET RAILWAY REVIEW, by Munn & Co., Patent Attorneys, 361 Broadway, New York, N. Y.

ISSUED MAY 9, 1893.

Method of welding metal, Arthur J. Moxham, Johnstown, Pa.,	496,890
Contact for underground electric railways, William Q. Prewitt, Lexington, Ky.,	496,896
Girder joint for railroad rails, Maximilian M. Suppes, Johnstown, Pa.,	496,916
Car truck, Geo. H. Graham, Oak Park, Ill.,	496,933
Railway switch, Harry B. Buttell and William H. Colson, Newark, N. J.,	496,996
Electric railway, Rudolph M. Hunter, Philadelphia, Pa., assignor to the Thomson-Houston Electric Company, of Connecticut,	497,024
Overhead electric railway, Rudolph M. Hunter, Philadelphia, Pa., assignor to the Thomson-Houston Electric Company, of Connecticut,	497,025
Electric railway switch, Edward F. Stone, Hyde Park, Mass.,	497,061
Automatic grip opener, William P. Courtney, Oakland, Cal., assignor one-half to Albert Brown, same place,	497,166
Trolley wire support, Henry A. Hamblin, Minneapolis, Minn.,	497,293

ISSUED MAY 16, 1893.

Overhead electric railway, William D. Patterson, Keokuk, Ia.,	497,337
Electric car truck, Geo. S. Strong, New York, N. Y., assignor to Jas. N. Gamble, Cincinnati, O.,	497,356

Trolley for conduit railways, Paul C. Just, Chicago, Ill.,	497,377
Apparatus for heating street cars, Jas. F. McElroy, Albany, N. Y., assignor to the Consolidated Car Heating Company, Wheeling, W. Va.,	497,385
Conduit electric railway, Geo. Westinghouse, Jr., Pittsburgh, Pa.,	497,394
Lightning arrestor, Alexander Wurts and Chas. F. Scott, Pittsburgh, assignors to the Westinghouse Electric & Manufacturing Company, same place,	497,397
Electric railway signal, William H. Jordan, Brooklyn, N. Y.,	497,408
Sectional contact conductor for electric railways, George Westinghouse, Jr., Pittsburgh, Pa.,	497,436
Car brake, John C. Henry, Westfield, N. J.,	497,544
Railway track structure, Edward Samuel and Victor Angerer, Philadelphia, Pa., assignors to Wm. Wharton, Jr., & Company, same place,	497,554
Cable grip, Frank J. Scanlan, Philadelphia, Pa.,	497,555
Street railway switch, John B. Gough, Providence, R. I.,	497,569
Closed conduit for electric railways, Archibald J. Martin, Philadelphia, Pa.,	497,585

ISSUED MAY 23, 1893.

Railroad rail and process of uniting same, Arthur J. Moxham, Johnstown, Pa.,	497,808
Railroad rail joint, Herbert P. Stearns, Byron, Ill.,	497,834
Sanding device for street cars, Chas. W. Werst and William P. Womach, St. Joseph, Mo.,	497,902
Combined nut lock and electrical connection for railroad rails, Albert L. Johnson, Cleveland, O.,	497,963
Electric railway trolley, Edward H. Allen, Cramer Hill, N. J., assignor two-thirds to William A. Barrett, Jr., Philadelphia, Pa.,	498,016
Street car, George Moor, Boston, Mass.,	498,071
Rail support, William N. Morrison and Thomas P. Swin, Brooklyn, N. Y.,	498,072
Rail support, William N. Morrison and Thomas P. Swin, Brooklyn, N. Y.,	498,083
Railroad rail and chair and process of uniting same, Arthur J. Moxham, Johnstown, Pa.,	498,074
Conduit electric railway, George F. Moffet, Portland, Ore.,	498,135
Electric railway conduit, Arthur H. Heitzman, Baltimore, Md.,	498,169
Electric railway conduit, Joseph L. Reynolds, Winterset, Ia.,	498,189
Bumper or stop for cars of underground cable railway crossings, Henry E. Poehlman, San Francisco, Cal.,	498,215

ISSUED MAY 30, 1893.

Track-scraper, Edwin J. Emerson, Jersey City, N. J.,	498,249
Cable railway gripper, Phillips T. Taylor, San Francisco, Cal.,	498,325
Drawbar for street cars, Jas. A. Trimble, New York, N. Y.,	498,334
Trolley catcher, Chas. A. Lord, San Francisco, Cal., assignor one-half to T. A. Kirkpatrick, same place,	498,355
Electric railway trolley, Patrick F. O'Shaughnessy, New York, N. Y., assignor to the Sprague Electric Railway & Motor Company, same place,	498,403
Electric railway trolley, Rudolph M. Hunter, Philadelphia, Pa., assignor to the Thomson-Houston Electric Company of Connecticut,	498,435
Cable grip, John Kratz, Baltimore, Md.,	498,517
Safety fender for cars, George Latz, Baltimore, Md.,	498,556
Electric locomotive, Albert Schmidt, Allegheny, Pa., assignor to the Westinghouse Electric & Manufacturing Company, Pittsburg, Pa.,	498,577
System of supplying current to electric railways, Charles Zipernowsky, Buda Pesth, Austria-Hungary,	498,604
Track cleaner for street railways, Edward Clark and Andros F. Ogren, Lockport, Ill.,	498,622
Sanding device for street cars, Emil F. De Witt, Lansingburg, N. Y.,	498,632
Sanding attachment for street cars, Thomas B. Clark, Zanesville, Ohio,	498,706
Trolley for electric cars, Robert D. Nuttall, Allegheny, Pa.,	498,722
Electric railway trolley, Robert D. Nuttall, Allegheny, Pa.,	498,723

THE AMERICAN INSTITUTE OF ELECTRICAL ENGINEERS at its annual meeting of May 16, elected president, Edward J. Houston, vice-presidents, H. Ward Leonard, P. B. Delaney, William Wallace; treasurer, Geo. M. Phelps, and secretary, Ralph W. Pope. May 17 was devoted to learned papers by C. P. Matthews, Lieut. Parkhurst, Geo. S. Moler and others, while on May 18 the Association visited Ampere, N. J., to inspect the Crocker-Wheeler works.

PICTORIAL EVENTS OF THE MONTH.



THE CABLE line on the eastern portion of Seventh street, St. Paul, will be changed to electric, an ordinance for the same having passed the council. The cable line has been down several years, but as there is no severe grade on this portion of the line and it has numerous electric branches, the change has become desirable.

THE PASSENGERS of a Chicago cable train were treated to a performance not on the bills, a few days ago. The train was crossing Michigan street just as a runaway horse dashed up. He had left the carriage several blocks back neatly suspended on a lamp post, but still wore a full dress suit of harness. He was billed through to a point half a mile distant but after boarding the car which was an open one, concluded to get tangled up in the seats and posts and give up the chase. As the company's rules forbid horses on the car, the conductor with a large crowd to advise, ejected the intruder and punched him a transfer to Rush street. Fortunately, no passengers were hurt.

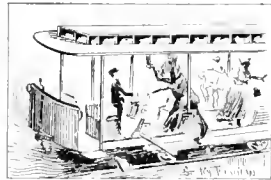

THE RESTRICTION against smoking on the World's Fair grounds has been withdrawn except in the buildings and visitors can now enjoy an after dinner cigar. During the construction period when great quantities of building material were scattered everywhere the order was an absolute necessity.

WHEN THE first cable car made its triumphal trip down Broadway the other day, it enjoyed the distinction of literally rolling in wealth. New Yorkers came out and lined the track on either side, placing small coins on the rails to be flattened by the first car and preserved as souvenirs of the occasion.



THE SKIRMISHING of the forces of the General Electric and Westinghouse has continued during the month but without loss of life on either side. A shell was fired by some Thomson-Houston regulars, containing an action for infringement of trolley rights under Van Depele patents. A permanent injunction and \$50,000 damages is asked.

A FAIR Amazon in Rochester, N. Y., took exception to the electric cars which, pending some litigation, continued to run across some of her real estate. At night she put up three strong posts, one in the middle and one on each side the track, and to these spiked a heavy timber. When the first tripper came out he put his hand on the fence just to see if it was a real fence. In an instant he was looking down the business end of a big gun, at the extremity of which, also with a business look, was the madam. She poked the muzzle in the conductor's face; she dared him to move and threatened him if he did. She made him dance, put up his arms and otherwise perform in a manner not specified in the rule book. All day long she held the fort and applications for employment on that line have been withdrawn.



HANDSOME HARRY, a picturesque Chicago character and for twenty years a driver on the West Division Street Railway, died recently. Men who associated with him for years had no other name for him than Handsome Harry and the undertaker's book shows that Handsome

Harry was buried at Forest Home. Handsome Harry often appeared dressed in a spotless white vest, kid gloves and patent leather shoes and in fine weather, a silk carnation or rose adorned his button hole. In his twenty years of service he made 300,000 miles and some He made his appearance twice in twenty years.

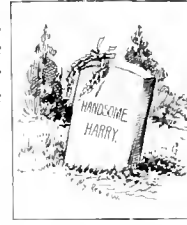

hat. All summer long a Harry travelled perhaps years worked 350 days in the sweat box only

NEW PUBLICATIONS.

JAS. F. MANN, Utica, N. Y., has published a neat descriptive catalogue of the Leary automatic switches and frogs.

THE RAILWAY EQUIPMENT COMPANY have just issued a catalogue of over 200 pages, describing their electric railway supplies. It is one of most complete lists of material for this purpose ever printed, and the volume is of really formidable size. Nothing necessary to the electrical equipment of a road has been omitted, and the stock carried is of the highest grade in every line. In addition to the catalogue there is the usual complement of formulas, tables, etc., of general interest and value.

THE GISHOLT MACHINE COMPANY, of Madison, Wis., has issued a handsome catalogue showing some fine samples of turret lathe work.

THE NEW ENGLAND MAGAZINE for June opens with an interesting paper on the "Boston Tea Party;" Price Collier gives the history of the first church organized in America, under the title, "The Old Meeting House at Hingham, Mass.;" "Personal Recollections of the Poet Whittier," are written by Charlotte Grimke.

LIPPINCOTT'S MAGAZINE for June has a complete novel by Gilbert Parker, entitled "The Translation of a Savage." The Athletic Series is continued by Jno. F. Hunecker, with an article on "Amateur Rowing." M. Crofton in "Men of the Day" offers pen pictures of Bayard, Mackay, Verdi, and Burnand.

THE GENERAL ELECTRIC COMPANY has issued a very artistic folder especially for the World's Fair, showing the growth, achievements and resources of the company.

CASSELL'S FAMILY MAGAZINE for June has an article that will doubtless be of universal interest, on the "Art of Keeping Well," by "Family Doctor." "Corresponding With the Planets" during the Chicago Exposition is a suggestion, the novelty of which will attract many.

St. Louis Limited via Wabash Line.

The Chicago-St. Louis Limited, leaving Chicago daily except Sunday at 10:32 a. m., is now a solid vestibuled train, built especially for the traffic between Chicago and St. Louis, arriving in St. Louis at 6:45 p. m.

It is made up of cafe car, library car, parlor car, palace day coaches and smoking car, arranged in the order named. It makes quicker time from Chicago to St. Louis than any of our competitors. Cafe serves meals a la carte, of a quality equal to any restaurant. The library is equipped with all the standard works. The Chicago and St. Louis dailies and the leading illustrated weeklies and periodicals are kept on file. Every convenience known to the traveler is to be found on this train. Time, eight and a quarter hours, Chicago to St. Louis. Ticket office 201 Clark street.

"You seem a man of standing"—
For the car was very full—
"Oh yes," he said, as he clutched the strap,
"Tis because I have a pull."

MUSKEGON, MICH., is reported as asking for an electric line, to be in operation by August 1.

ECHOES FROM THE TRADE.

GEO. CUTTER supplies the Morris pole tops for the Syracuse railway.

THE GENETT AIR BRAKE COMPANY has removed its eastern offices, to 33 Wall street, New York.

THE PENNSYLVANIA STEEL COMPANY are supplying a large order of 90-pound rail for the Philadelphia Traction Company.

WILLIAMS & Co., Plymouth street, Jersey City, report a large business in gongs tempered copper fuse wire and other material.

SIEMENS & HALSKE are doubling the capacity of their Chicago factory in response to the urgent demand for their work in America.

THE MARK RAILWAY EQUIPMENT COMPANY, of Cleveland, O., reports a large call for its joint rail chair and other track specialties.

GEORGE CUTTER has received some large shipments of the P. & S. china insulators and cleats, and now has a full stock of these at Chicago.

THE J. W. FOWLER COMPANY, of Elizabeth, N. J., is rapidly completing its factory. The offices are in the Havemeyer Building, New York.

J. L. LUDWIG, New York, is located in the Havemeyer building, with a full line of overhead railway specialties together with the Green Engine agency.

EDMUND D. SMITH & COMPANY are the new Eastern agents of the St. Louis Car Company, with headquarters at 108 South Fourth street, Philadelphia.

THE WARREN-SCHARF Asphalt Paving Company of Utica, N. Y., has made an extensive report of the asphalt laid with 45-pound T rail, Johnson pattern.

J. H. BUNNELL & Co., 76 Cortlandt street, New York, the well-known electrical supply men, have recently added a stock of overhead street railway specialties.

A HAMILTON CORLISS engine of 250 horse power is a recent acquisition of the Youngstown, O., Street Railway Company. The machine will soon be installed.

ALBERT & J. M. ANDERSON, of Boston, report that they are very busy with their specialties and keeping pace with the rapidly increasing demand for Aetna insulators.

THE WHARTON SWITCH COMPANY has a contract for thirty miles of 90-pound girder rail to be used on the Philadelphia Traction company's new electric lines.

THE GENERAL ELECTRIC have just delivered ten W. P. 50 motors to the Overland road at Nashville, Tenn., and ten more to the North Nashville railway.

THE GENETT AIR BRAKE COMPANY report a recent shipment of 100 air brake equipments for the motor cars of the Atlantic Avenue Railway Company of Brooklyn.

THE STANDARD PAINT COMPANY captured the big Hygeia Spring Company order for P. & B. compound, to line 140 miles of water pipe from Waukesha, Wis., to Chicago.

THE AMES IRON WORKS, Toledo, are making additions to their manufacturing facilities, and will make a specialty of high-grade automatic engines for electric railway and light work.

MCLEAN & SCHMITT, electrical contractors, have bought up the business of the Pioneer Armature Works of Chicago and united it to their own plant. They will now re-wind armatures.

WILLIAM R. PITT COMPOSITE IRON WORKS has removed to the corner of Fifth avenue and Twenty-fifth street, New York City. Its patent folding gate is there kept in ample stock.

A. O. SCHOONMACKER, 158 Williams street, New York, offers large quantities of East Indian Mica for insulation purposes, in the solid sheet form. He sends catalogues and prices on application.

J. D. SMITH, 350 Pearl street, New York, is very busy in all departments and has just received an order from the Third Avenue Cable Railway for 220 head-lights and 400 signal lights.

JOHN A. ROEBLING'S SONS COMPANY are inviting particular attention to the Roebbling wire lathing, a new departure. They claim for it the advantages of rigidity, solidity and non-combustibility.

CAPTAIN W. H. TAYLOR, president of the Risdon Iron and Locomotive Works, San Francisco, and also Western representative of the Genett Air Brake Company, was a recent Chicago visitor.

THE McDONALD & HOOD ELECTRIC COMPANY, 239 La Salle street, Chicago, has been organized to handle electrical supplies, among which the American battery is most prominent. The firm is certain to meet with success.

THE J. H. McEWEN MANUFACTURING COMPANY, Ridgway, Pa., is meeting with great success in its late sales of engines. A recent circular issued by the company gives tests and figures complimentary to these engines.

THE RAILWAY EQUIPMENT AND MACHINERY EXCHANGE, 408 Neave building, Cincinnati, Ohio, have just secured a contract for 1,500 freight cars. They are southern agents for the Tramway Rail Company of Pittsburg.

WELLS & COUTAN COMPANY is situated at 29 Gold street, New York. It is a new concern, manufacturing standard steam pressure and vacuum gauges. J. S. Cameron is president; O. C. Wells, secretary; Chas. A. Coutan, treasurer.

TWENTY CARS are being turned out by the Ahearn & Soper Car Works, Ottawa, Canada, for the Montreal Street Railway Company. They will be equipped with Westinghouse motors and delivered ready for operation on the tracks.

LUCIUS E. MARPLE, is a late acquisition to consulting electrical engineering circles. Mr. Marple has many friends in the electrical lines and is fully competent to entangle the expedient from the inexpedient. His office is at 916, The Temple, this city.

THE LEWIS BOILER COMPANY, of Augusta, Me., has been organized for the purpose of marketing the Lewis patent sectional boiler. The capital stock is \$100,000. W. A. Lewis, Waltham, Mass., is president, and G. T. Lewis, Charleston, Mass., treasurer.

THE CURTIS MANUFACTURING COMPANY, Jersey City, N. J., made a trial trip with one of their new type motors over the Morris Cove Electric railway, recently. The trip was satisfactory. It is reported that the new motor will be placed on ten of the company's cars.

THE STEEL MOTOR COMPANY, of Cleveland, Ohio, have received the contract for the entire motor equipment of the Lehigh Valley Traction Company. The Harris trolley is also selling well and giving satisfaction wherever used. Business in the supply department is flourishing.

THE WASHBURN & MOEN MANUFACTURING COMPANY, Worcester, Mass., report an enormous business in their insulated wire department and announce that a large and commodious factory will be built at the South works. The railway orders have been unparalleled large during the past few months.

THE BROWN ELECTRIC COMPANY, Boston, through Maybin W. Brown, has closed contract with the Lancaster and Columbian Railway Company of Lancaster, Pa., for twelve miles of equipment, double wire and Brown special double insulators. The Hartford & Wethersfield road will also use the Brown material.

THE ST. LOUIS REGISTER COMPANY have brought out a novel stationary register which has two complete sets of records—each showing trip and totals—one set for

registering full fares and the other for half fares or transfers. The machine is of handsome appearance, and of course is worked by two pull cords, one for each record.

OUR DICTIONARY OF TECHNICAL TERMS.



EFFECT OF HAY MOTOR RUNNING ON A WEAK FIELD.



A METAL TIE.



EFFECT OF PURE COPPER ON A CASE OF OVER-COMPOUNDING.



HIGH RESISTANCE.



CHILLED WHEELS.



SUPER-SATURATION.

THE "STERLING SUPPLY COMPANY" is the new and more abbreviated title of what until June 1st was known as the Sterling Car Heating and Lighting Company. The place of business remains the same—47 Cedar street, New York—and officers and management are unchanged. Their business is to be expanded to include other railway specialties.

THE ANSONIA ELECTRIC COMPANY have fitted up the entire third floor of their large building at Randolph street and Michigan avenue, Chicago, for the free accommodation of visiting electricians. Here may be found all the comforts imaginable (outside of meals and lodging) for the entertainment of guests, and the fraternity is cordially invited to take advantage of them.

THE BEMIS CAR BOX COMPANY, Springfield, Mass., lately received an order from the Laclede Car Company for 250 of their standard trucks for cars now being built for the Philadelphia Traction Company. Other late orders are from Baltimore, Brockton, Galveston, San Antonio, Lowell, Haverhill and Buffalo. A good business is being done in all lines of their work.

THE STIRLING COMPANY is doing its share in the change from mules to motors, and during the past week have sold at the Chicago office and through their eastern agent, J. Bradford Sargent, 620 Atlantic avenue, Boston, a total of 2,400 horse power, as follows: 750 went to the Cleveland City Cable Company, 900 to the Allentown, Pa., Electric Street Railway Company, and 250 to the La Fayette Street Railway Company, besides several hundred to small electric plants. The Stirling exhibit at the Fair attracts special attention on account of the fierce law suit incident to its installation.

THE WALKER MANUFACTURING COMPANY of Cleveland, have nearly completed shipments of cable machinery for the Baltimore City Passenger Railway. This plant comprising two power houses will be one of the finest in the country, as it embodies all the latest improvements in cable machinery. Shipments already made include two five-groove, ten feet in diameter, Walker's patent differential cable drums; two five-groove, twelve foot, and six five-groove, fourteen foot, drums of the same pattern; four rope wheels, 24 foot diameter, 25 inch face; four rope wheels, 24 foot diameter, 16 inch face; two rope wheels, 24 foot diameter, 31 inch face.

THE CUSHION CAR WHEEL COMPANY, Chicago, are naturally much pleased with a letter from President H. R. Rhoades, of the Williamsport, Pa., Passenger Railway, who writes them as follows:

"A full set of your wheels was put under one of our cars January 1st, 1893, and has given us constant service of 120 miles per day since that date, and we have been so well pleased with their performance, as to order six (6) additional sets. Of course, with your guaranty they are the most economical made. They ride easily and are less noisy than a cast wheel; and a merit that is of great consideration is the traction qualities of the steel tire. They adhere to the rail in time of snow and reduce the slipping of wheels to a minimum. In fact, a car equipped with cushioned wheels will go through a greater depth of snow than is possible for a cast wheel to do. We are displacing all cast wheels with your make as fast as they are worn out, as a matter of economy."

LANE & BODLEY of Cincinnati have, in accordance with the increasing demand for high grade engines for electrical work, re-designed their old factory, and having made some additions are prepared to undertake the building of any size engine required. They are making a

specialty of heavy main receivers and tighteners designed to meet the heavy strains of electrical short circuits. Their shafting stands for central stations are giving excellent satisfaction. This concern is also well equipped with pulley molding machinery, shafting lathes, and a first-class new line of hangers, which is the fourth set of hanger patterns this firm has developed in its existence, and the third set of pulley designs.

WILLIAM S. LOVE, for many years connected with the Pond Engineering Co., has severed his connections with that firm and is out in business for himself. The Pond Engineering Company has no longer any office or repre-

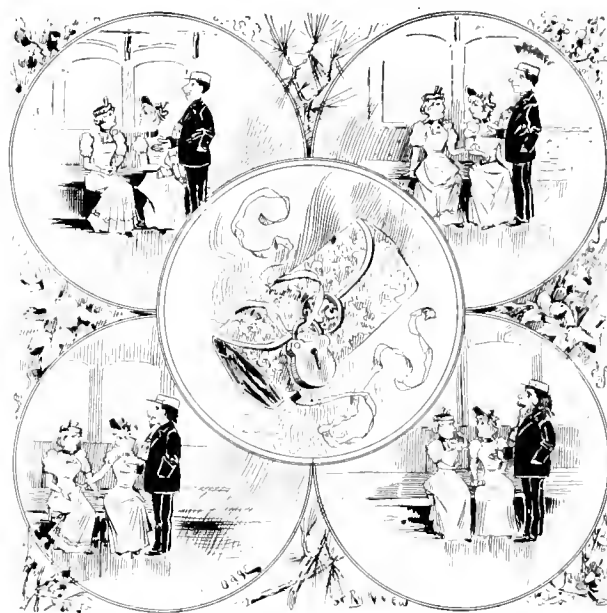

THE CONDUCTOR'S DREAM.

sentative in Chicago. Mr. Love represents the Armington & Sims Engine Company and the Hoppes Manufacturing Company, makers of live steam purifiers and exhaust steam heaters. He reports contracts for these articles with the Galt House, Louisville, Ky.; Oconomowoc Electric Lighting Company, Oconomowoc, Wis.; Grand Ridge Electric Lighting Company, Grand Ridge, Ill.; Shea, Smith & Company, Chicago; Freeport Gas Light & Coke Company, Freeport, Ill.; besides a number of smaller orders.

ALFRED G. HATHAWAY, Cleveland, is at present working night and day shifts to keep up with orders. He has just shipped a 100-ton wheel press to the Mt. Adams & Eden Park Railroad of Cincinnati. Mr. Hathaway writes in relation to his wheel presses: "I am having quite a run on these special presses, and have several that have been out two years, that have never broken a casting nor gotten out of order in any way. The transfer table department of our works is thirty days behind in orders. I just shipped a 26-foot table to The South Western Missouri Electric Railway Company of Springfield, Mo., and I am making a 26-foot table for the Pittsburg & Birmingham Traction Company of Pittsburg. These tables are extra

strong make and carry a twenty-ton car without deflection. My 9-foot standard table, which has several improvements from the old style, is in great demand. I have just shipped six 11-foot transfer tables to accommodate cable grip-cars, to the West Side Street Railroad of Chicago.

THE HOPPES MANUFACTURING COMPANY, Springfield, Ohio, report business booming. Negotiations are on foot with three of the largest street railway systems of the country with a view of adopting this system of feed water purifying. Among recent purchases have been: The Columbus, O., Street Railway Company, 1,000-horse-power live steam purifier; Muscatine, Iowa, Electric Railway Company, 400-horse-power exhaust steam heater; Citizens' Street Railway Company, Muncie, Ind., 350-horse-power exhaust steam heater; Clark Thread Company, Newark, N. J., two exhaust steam heaters of 600-horse-power each; The Freeport, Ill., Gas Light & Coke Company, 300-horse-power heater; Heat, Light & Power Company, Muncie, Ind., 300-horse-power heater; Citi-



How the man who sits cross legged in a car appears to the excited imagination of the other passengers—Judge.

zens' Gas & Electric Company, Jacksonville, Fla., 80-horse-power live steam purifier; Omaha, Neb., Gas Manufacturing Company, 200-horse-power live steam purifier; Giant Powder Company, San Francisco, Cal., 200-horse-power purifier; Calumet Electric Street Railway Company, Burnside Crossing, Chicago, 1,100-horse-power exhaust steam heater.

THE RAILWAY EQUIPMENT COMPANY, Chicago, reports contracts made for Type "G" overhead material during the last few weeks with Tiffin, O., Electric Railway; Belle City Street Railway, Racine, Wis.; Norristown, Pa., Electric Railway; South Chicago City Railway; Mobile, Ala., Electric Light & Power Company; Camden & Atlantic Railroad, Atlantic City and Camden; Calumet Electric Street Railway, Chicago; Trenton, N. J., Iron Company; Columbia, Pa., & Ironville Street Railway; Lehigh Traction Company, Hazleton, Pa.; Wheeling, W. Va., Railway; Wichita, Kas., Electric Railway; Fox River Street Railway, Green Bay, Wis.; Pottstown, Pa., Passenger Railway; Wyandotte & Detroit River Railway, Ecorces, Mich.; Cumberland, Md., Electric Railway; Montreal, Can., Street Railway; Independence, Iowa, & Rush Park Railway; Westminster & Vancouver Tramway; Gettysburgh, Pa., Electric Rail-

way; Second Avenue Passenger Railway, Pittsburgh; Pittsburgh & West End Passenger Railway; Escanaba, Mich., Electric Street Railway; Atlantic Avenue Railroad, Brooklyn; and Hammond, Ind., Electric Railway.

THE PHOENIX IRON WORKS COMPANY, Meadville, Pa., have recently booked the following orders for compound engines: Wyandotte & Detroit River Railroad Company, (second order) for one 150-horse-power compound condensing engine and two 150-horse-power Manning boilers; Carnegie Steel Company, Pittsburg, two 150-horse-power compound condensing; Trumbull Electric Railway Company, Warren, Ohio, one 175-horse-power non-condensing compound and two Manning vertical boilers; Salt Lake City, Utah, Electric Light Company, one 125-horse-power compound condensing; N. W. Gokey & Son, Jamestown, N. J., two 175-horse-power non-condensing compounds. This will make six in Jamestown running light and street railway plants. Saginaw, Mich., Power Company, 300-horse-power condensing compounds for running street car generators; Allentown, Pa., Street Railway Company, eight Manning boilers, 1,200-horse-power. This does not include sales of single cylinder engines and numerous boiler orders. Both engine and boiler departments are crowded and working overtime, and additions are contemplated to take care of increasing business.

Abraham Lincoln

When leaving his home at Springfield, Ill., to be inaugurated President of the United States, made a farewell address to his old friends and neighbors, in which he said, "NEIGHBORS GIVE YOUR BOYS A CHANCE."

These words come with as much force to day as they did thirty years ago.

How give them this chance?

Up in the Northwest is a great empire waiting for young, and sturdy fellows to come and develop it and "grow up with the country." All over this land are the young fellows, the boys that Lincoln referred to seeking to better their condition and get on in life.

Here is their chance!

The country referred to lies along the Northern Pacific R. R. Here you can find almost anything you want. In Minnesota and in the Red River Valley of North Dakota, the finest of prairie lands fitted for wheat and grain, or as well as for diversified farming. In Western North Dakota, and Montana, are stock ranges limitless in extent, clothed with the most nutritious of grasses.

If a fruit farming region is wanted there is the whole State of Washington to select from.

As for scenic delights the Northern Pacific Railroad passes through a country unparalleled. In crossing the Rocky, Bitter Root, and Cascade Mountains, the greatest mountain scenery to be seen in the United States from car windows is to be found. The wonderful bad lands, wonderful in graceful form and glowing color, are a poem. Lakes Pend d'Oreille and Cœur d'Alene, are alone worth a trans-continental trip, while they are the fisherman's Ultima Thule. The ride along Clark's Fork of the Columbia River is a daylight dream. To cap the climax this is the only way to reach the far-famed Yellowstone Park.

To reach and see all this the Northern Pacific Railroad furnish trains and service of unsurpassed excellence. The most approved and comfortable Palace Sleeping cars; the best Dining cars that can be made; Pullman Tourist cars good for both first and second class passengers; easy riding Day Coaches, with Baggage, Express, and Postal cars, all drawn by powerful Baldwin locomotives, make a train fit for royalty itself.

Those seeking for new homes should take this train and go and spy out the land. To be prepared, write to

CHAS. S. FEE,
G. P. & T. A.
St. Paul, Minn.

PECKHAM'S IMPROVED 6A TRUCK.

THE latest product of the Peckham Motor Truck & Wheel Company is the 6A truck. With the exception of the wheel pieces, which have split pins, no bolts are used in the construction of this truck,

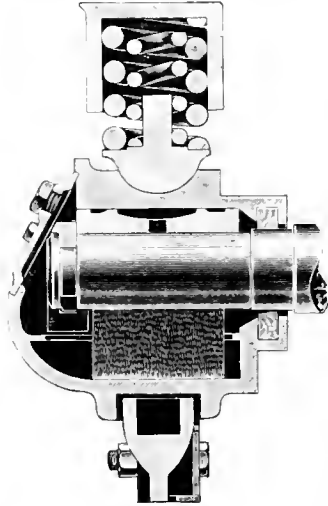

SECTION OF PECKHAM GEAR FOR 6A TRUCK.

so that there is practically nothing to work loose. All the rivets are driven hot by skilled boiler makers.

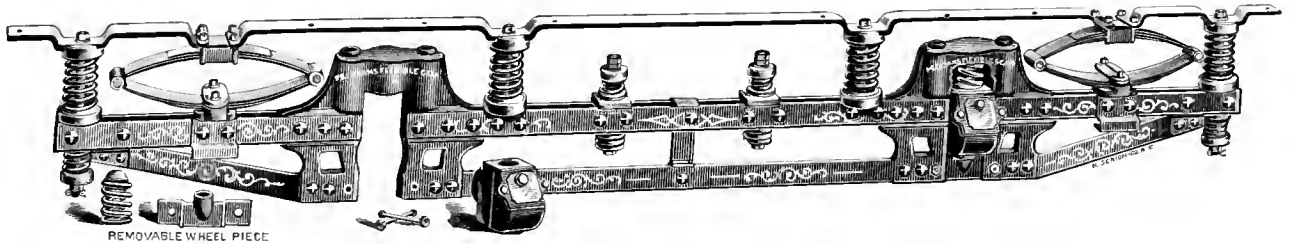

CANTILEVER EXTENSION SIDE FRAME, PECKHAM'S 6A TRUCK.

Another prominent feature of the new truck is the adoption of the ball bearing spiral spring cushion gear.

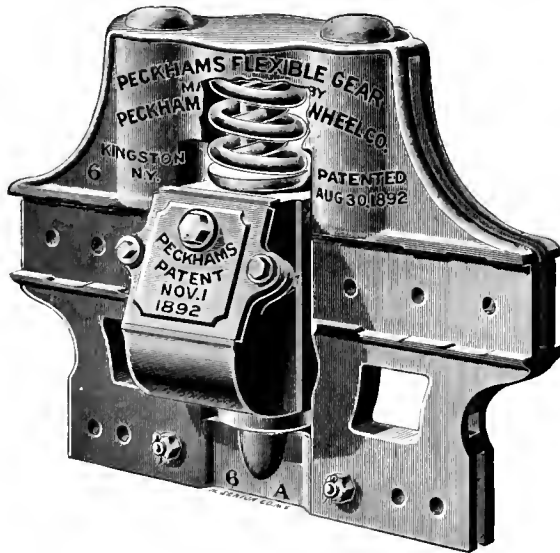

GEAR OF 6A TRUCK.

The spiral spring of this gear fits in a pocket and finds its seat in a ball and socket joint on top of the journal

box. This joint gives a free movement to the gear and saves strains on the side frames of the truck. The spiral springs of the gear cushion the side frames and relieve them, and the motors suspended from them, of shocks and concussions. By the removal of eight split pin bolts the removable wheel pieces can be taken out for the renewal of worn out wheels and axles. The Peckham Company has equipped its factory with special appliances for making this truck, and all parts will be made interchangeable. Over 300 have been furnished to the Atlantic Avenue and Brooklyn City roads, of Brooklyn, and wherever used they are giving good satisfaction.

OBITUARY.

HARRY C. FISHER,

son of Albert Fisher, of the Western department of the Watertown Engine Company, died May 21. He was well known to the trade, his death is mourned by a large number of friends. Young Mr. Fisher leaves a wife to whom he had been married but a few months.

GEORGE D. CAPEN,

the St. Louis street railway capitalist, died of lung trouble May 1. He left an estate valued at \$1,000,000 and many street railway and insurance interests.

THE McGuire Manufacturing Company captured the Indianapolis order for 50 trucks.

MR. AND MRS. WALLACE D. DICKINSON, of Great Falls, Montana, were in attendance at the World's Fair during the month. Mr. Dickinson is superintendent of the Great Falls Street Railway and undoubtedly one of the most aggressively modern of street railway men in the west.

Through Train Chicago to Texas.

On June 19th there will be inaugurated a through train service between Chicago and Texas. The "Burlington Route," which is usually foremost in western railroad enterprise will put on a fast vestibule express train leaving Chicago at 1:45 p. m. daily for Dallas, Taylor, Galveston and other prominent Texas points. The train will be equipped with Pullman sleeping cars, reclining chair car and standard day coaches of the most modern pattern. A through train service of this kind is sure to stimulate trade relations between Texas and Chicago and will be welcomed by the many who have occasion to travel between these points.

CAR BUILDERS OF AMERICA.

OUR readers will recall with pleasure the interesting biographical and historical article which appeared in the STREET RAILWAY REVIEW last year, in which was outlined the work and life of the staunch pioneer car builder, John Stephenson, of New York.

It is made possible this month to follow up the series with a sketch of one of the later street car manufacturers, by giving a few facts in relation to the life of Henry Cochran, the designer and master mechanic of the Lamokin Car Company, of Chester, Pa.

Mr. Cochran is a veteran of the late war, and to this fact is due several incidents in his career. In common with many other young men he gave three of the most valuable years of his life to the service of his country as a member of the Ninety-fifth Ohio Volunteers. He was 15 years old when he entered the army. After honorable discharge from the service Mr. Cochran found himself in possession of three wounds and no business except that of soldiery. Nothing daunted he learned the carpenter's trade in Lyons, Ia., after which he returned east, entering the shops of the Jackson & Sharp Company, where he remained three years. Dowers & Dure were then his employers until the panic of 1873, when he entered the service of the Harlan & Hollingsworth Company. After the Centennial Mr. Cochran went to the J. G. Brill Company, Philadelphia, where he was foreman for eleven years, leaving them to take charge of the works of E. H. Wilson & Company, at Chester, Pa., at that time handling only rough work and second hand steamcars. This business soon grew into the making of the elegant street cars so well known to readers of the REVIEW.

Mr. Cochran's energy and ability has done much toward bringing forward the Lamokin cars to their present excellence. He owns eight valuable patents on cars and has three or four more now pending.

Mr. Cochran is a member of Post Wilde, No. 25, G. A. R., of Chester, Pa., with a G. A. R. enthusiasm second only to an enthusiasm for Lamokin cars, which in their turn repay him by their popularity.



HENRY COCHRAN.

McKEESPORT'S RAILWAYS.

SINCE 1891, readers of the STREET RAILWAY REVIEW have heard of the McKeesport roads. The town is a growing one, a suburb of Pittsburg, a manufacturing center, and as to electric railways bids fair to become the center of a largely extensive system.

The McKeesport & Reynoldton Company was the original one and still continues to be a profitable enterprise and to improve its service and extend its borders. The White Traction Company is also doing a good business.

Meanwhile the McKeesport & Wilmerding road, another new enterprise, is nearing completion and will bring business to McKeesport. The Dravosburg line has its charter and will begin work soon. The directors of this road are J. M. Risher, Dr. F. H. Sumney, et al, of Dravosburg. The object of this company is to get an outlet for about two lines of country, forming a sort of belt line through a populous district.

The Dravosburg, Mendelssohn & Elizabeth Company will complete a short line to operate eight cars, single track. This road will be extended in time to as far up the valley as possible.

This is a strong object lesson in electric traction, showing what may come from beginnings so humbly made. One town becomes an electric railway center, a city becomes the metropolis of these, and we have an interdependent town and country with the advantages of both.

RAILWAY EQUIPMENT COMPANY SECTION INSULATOR.

THIS section insulator, originally designed for one of the leading roads in the country, has proved so satisfactory in actual service that the Railway Equipment Company, Chicago, has made arrangements for putting it on the market for general use. While simple in construction it is made extra strong by the use of their standard No. 1 strain insulator. The insulation is nearly perfect, and the device presents a neat appearance on the line.



SECTION INSULATION.

THE Marion Street Railway, of Marion, Ind., have commenced work on a line of road to Gas City, via the Soldiers' Home. The Ansonia Electric Company's new line of overhead railway fixtures will be used on the entire road.

PROSPECTS are said to be very bright for an electric railway for both passenger and freight business between Middletown and Frederick, Md. It is expected to build the road on its own right of way. Another step toward the steam road.

G. E. 800.

OMNIBUS COACH.

THE General Electric Company have made several important changes in their single reduction motor. The new machine is designated as G. E. 800, and is about what is generally rated as a 25-horse-power motor. The designation 800 represents the number of pounds horizontal effort it is capable of exerting continuously through a 33-inch wheel. The motor is completely closed in a water-tight case, so that it could be run under

MANY street railways find the necessity for using such conveyances as the omnibus coach, either on special occasions from terminus or points along the line to picnic grounds and similar places, or regularly as feeders to lines where the service will not warrant the laying of a track. Such coaches are for sale by F. N. Sweeney, of Detroit, and have side seats 10 feet long, with an aisle 31 inches wide between. The body of the coach is very much like that of a street car, having ventilating windows, bell-pull, etc. The body is hung on four elliptic springs and has five windows on each side. It rides smoothly, will accommodate a good sized load, and is easily drawn by one team of horses.

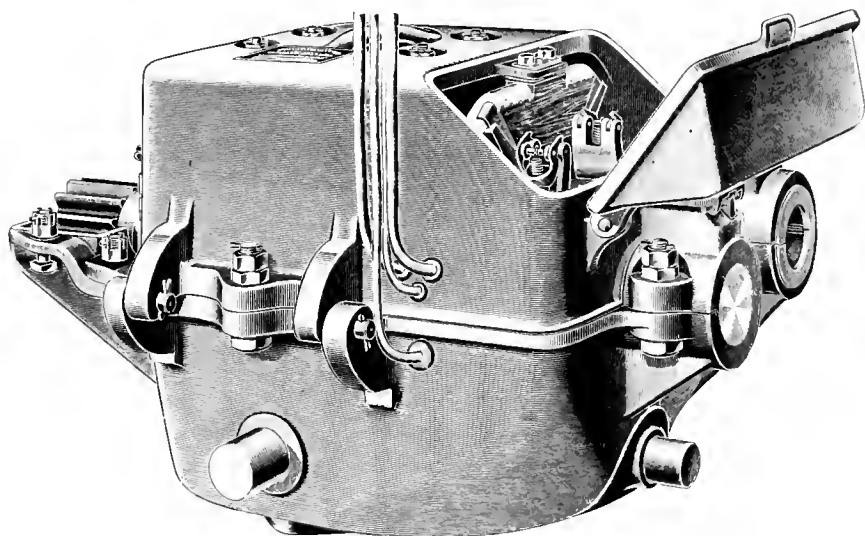

NEW RAILWAY MOTOR G. E. 800.

water without injury, making the motor "water-proof" in something more than name. It is 300 pounds lighter than the "W. P." 15-horse-power. The armature, which is similar to that on the old "W. P.," is either ring or drum. It is designed to be easily taken apart for inspection and repairs. Only 500 pounds of its weight bears directly on the car axle so that the rail joints will receive less pounding in the future. The changes summed up are: complete enclosure of the motor, reduction in weight, and shifting of center of gravity away from the car axle.

THE advertising privilege of cars and stations of the "Alley L" in this city has been given to the Street Car Advertising Company, of Chicago, which also has the contract for the cars of the Chicago City Railway.

THE Brooklyn bridge has been open for travel ten years. During its first year the bridge cable cars carried five million passengers. For the past year the record is forty millions.

THE O'HARA EXHIBIT.

THE O'Hara Air Company is comfortably ensconced at Z s, between posts 3 and 4. Here may be seen the latest airbrake on the market, in operation. Both steam and street car types are shown, and the representative in charge will take the utmost pleasure in telling the merits of the new brake. Mr.

O'Hara has been at work on this piece of mechanism for some time and at last finds his ideas embodied in a brake that satisfies his ideal of what a brake should be.

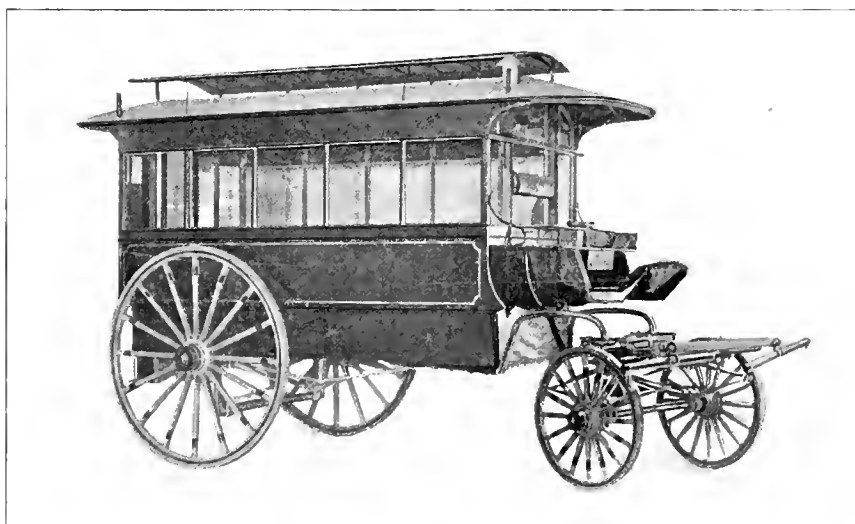

OMNIBUS COACH.

THE Point Defiance road at Tocomo is building a boat 56 feet long, to run from Point Defiance to Quarter Master's Harbor, and other points in connection with its electric lines.

GOWAN'S RAIL CLEANER.

A RAIL cleaning device, which is at once simple and effective, has been patented by J. A. Gowan, of 23 Gladstone avenue, Toronto, Canada. Appreciating the necessity of a clean rail, especially in electric service, Mr. Gowan has invented a revolving broom which in both wet and dry weather gives a better contact between wheel and iron. He does not endeavor to sweep the whole track, leaving that in heavy storms for the snow plows, but offers a device which in ordinary

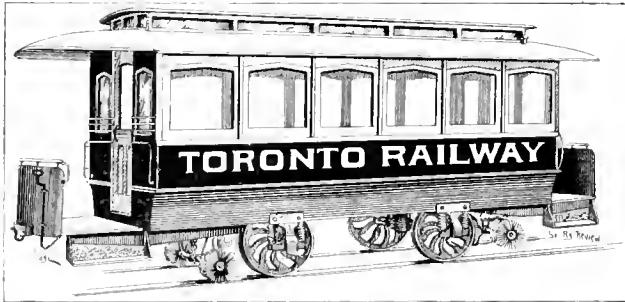

GOWAN'S RAIL CLEANER.

snow fall, or when mud or sand and dirt are on the rails disposes of the obstructions in a positive manner.

The cleaner consists of rotary brooms placed in front of the forward wheels, but revolving in an opposite direction, being driven from the axle by a crossed link chain. The brooms can be raised from the rail at will by a small lever attached to the outside of the dash, and when so raised cease to revolve. The brooms can be taken off in a few minutes if desired. The cleaner has been used by Manager Fraser, of the city and suburban of Toronto, who says: "I had one of my cars fitted with the rotary broom last winter and found it of good service in removing four or five inches of snow, and find it works well also on mud or sand covered rails." This road experiences much trouble on one line skirting the base of a sand hill, where sand constantly blows and slides down on the track. H. A. Everett, managing director of the Toronto Street Railway, also has used the cleaner and reports it as working in a satisfactory manner.

THE NOISELESS RAIL JOINT EXHIBIT.

THE California Noiseless Rail Joint is a very pretty model of a new rail joint, the invention of George Weeks, of Oakland, California. Although meant primarily for steam roads, Mr. Weeks has assurance that its adoption on some street railways is but a matter of time. The idea is this: One end of each rail is beveled upon the outer side and the opposite end is bent to a corresponding angle, so that when in position in track the ends of adjacent rails overlap for some distance, and still leave the inside face of the rail heads in a straight line continuous. The bent end overlaps the beveled end of the adjacent rail for a little distance beyond the beveled part, and the two ends are bolted together by three bolts at each joint, the bolt

being held in slots to allow for expansion. This method dispenses with fish plates. Each rail is in addition fastened to the ties by means of bolts or spikes through slots in the flange.

THE SCARRITT CAR SEAT EXHIBIT.

D8 IS not a rebus. It means that the Scarritt Car Seat Company, of St. Louis, has a beautiful display of their specialties in the line of car seats at section D, space 8, of the Transportation Building. The exhibit is the unique idea of Treasurer Foster, of the company, and it attracts its full share of attention, both from the railway men and car builders visitant, as well as the old lady and the gentleman from Podunk. The canopy over the raised platform upon which the various seats are arranged is a car top with all the features of ceiling decoration, ventilators, and deck done in the best and most approved manner. This part alone cost \$600. Underneath are seats of every description for street cars, steam cars and suburban trains. The seats shown are of all patterns in rattan, wood, veneer and upholstered. The company does a large export trade and shows one design of seats made for the Imperial Chinese railway.



DOME OF ENTRANCE TO ELECTRICITY BUILDING.

THE is exhibited life size by Joseph Murray, of Cleveland, O. Mr. Murray's Chicago headquarters are in the Manhattan building.

EDMUND CARRINGTON, agent of the Morton Safety Heating Company, was a visitor at the STREET RAILWAY REVIEW branch recently. Mr. Carrington is a pleasant gentleman and may be seen explaining caloric almost any time at L north 13 street car row.



WINDSOR & KENFIELD,
PUBLISHERS AND PROPRIETORS.

269 DEARBORN ST., - - - CHICAGO.
Published on the 15th of each month.

SUBSCRIPTION, - - - TWO DOLLARS.
FOREIGN SUBSCRIPTION, - - - 20 SHILLINGS.

Address all Communications and Remittances to THE STREET RAILWAY REVIEW,
269 Dearborn Street, Chicago.

H. H. WINDSOR, Editor. F. S. KENFIELD, Business Manager.

CORRESPONDENCE.

We cordially invite correspondence on all subjects of interest to those engaged in any branch of Street Railway work, and will gratefully appreciate any marked copies of papers or news items our street railway friends may send us, pertaining either to companies or officers. Address:

THE STREET RAILWAY REVIEW,
269 Dearborn Street, Chicago.

Entered at the Post Office at Chicago as Second Class Matter.

This paper member Chicago Publishers' Association.

VOL. 3. JULY 15, 1893. NO. 7

“USE for Old Motors” is the title of an interesting article this month in which the experience at Great Falls, Montana, is full of suggestions. There are some roads still struggling with apparatus now almost historic, which may see in the methods described an outlet of relief as yet untried by them.

THE enterprising State of Washington stands alone as the only one of all the states in the Union without a horse car. It is not lacking in facilities however, for of electric, cable and steam dummy lines there is a total of 280 miles of track. Indeed, some cities are over provided with car tracks which have been laid several years in advance of a demand which should warrant their construction. The horse cars of the “States” constitutes one of the sights to Washington people visiting the Fair.

NOT long ago the citizens of Toronto were called to decide on the question of Sunday cars, which have never been operated there. The Sunday cars were then snowed under, but of late has arisen a strong desire to again submit the question to the people, and a monster petition is already secured to this end. It is wholly a public movement, although the new company have always been willing to operate on Sunday if allowed. It seems strange that intelligent people should for so long, and in these days, hold such radical opinions on what is so obviously a matter of necessity.

ATTENDANCE on the World’s Fair shows a daily increasing patronage. Everything is now complete, and the visitors who were so fortunate as to come during June were favored with clear skies, and cool days and nights, which made sightseeing a positive enjoyment. The exaggerated stories of extortionate charges have been scattered to the winds, and the contemptible attitude of the New York press is beginning to react, as eastern people come to Chicago and realize how stupendously they have been humbugged by their home papers. Street railway men, while quite numerous visitors, are in the main deferring their visit until the October convention. Foreign tramway representatives are already here in considerable numbers, and express the most profound interest and admiration at the perfection of the American street railway system.

WHILE on all sides collections are reported slow, and money is in that peculiar condition which is expressed in the phrase “tied up,” there has not been nor is there likely to be general distress and “hard times.” There is no surer nor quicker indication of lack of money among the masses that the receipts from the operation of street cars. Although the individual amount collected from each patron is small, it is often the pleasure or unnecessary riding which determine for many roads whether or not they can declare a dividend. The adoption of rapid transit and in not a few cases the establishing of pleasure resorts to draw out the crowd, have exerted an influence not possessed by the old horse-car system; but at the same time the masses have preferred to ride this summer, where they could have walked, and would have done so had there been any urgent necessity for the practice of that economy which asserts itself when the country falls below the level of accustomed prosperity.

THE Nebraska Populists have been holding a railroad convention at Lincoln. The meeting was prolific of resolutions, and they resolved with an abandon and rapidity that would grace a Fourth of July celebration. Among the incidental measures announced is one to build an electric road from Duluth to the Gulf of Mexico, and to cost \$30,600,000. The odd six hundred thousand is evidence of the ability and honesty of the Populists. Ordinary engineers and promoters would have made it an even half million, or more likely tacked on another four hundred thousand to provide for a proper celebration on the opening day. The road is to be built from sale of bonds, none of which, however, were subscribed for on the spot. The artesian wells of Dakota, the strong breezes of the Nebraska prairies, the rivers, streams, and even the brooks en route are all to be harnessed and furnish their quota of power to run the road; while the tides which lap the rushes in the gulf are to generate powers of locomotion the like of which the world has never seen. To get down to something practical, the Populists might fix up the dirt road from Lincoln to Asylum, a distance of eight miles, and thus establish the first precedent of having actually accomplished one improvement.

NOTWITHSTANDING the stringency in the money market, and which has now completed its course across the continent, business in street railway supplies has been better than could reasonably have been expected. There has been a sudden check put on the construction of entirely new lines, and reconstruction is now less than last year. At the same time much solid work is under way, and the record for 1893 promises to aggregate a handsome showing. Those enterprises which were endeavoring to make a voyage on wind only are, for the time, at least, hopelessly becalmed; some deserving companies share also in the difficulty to float securities at acceptable figures, and are likewise compelled to temporarily postpone much needed and legitimate improvements. The latter, however, will not be compelled to wait long, and the repeal of the silver bill is expected to restore confidence and release capital which is now in hiding. Good street railway securities will be among the first to feel relief, as they have become one of the most sought and desirable in the market, and it is not a matter of entire regret that a few undeserving enterprises should have been unable to struggle into an existence which must have been short and precarious at best.

THE separate car question, one for whites and another for colored people, of which echoes are occasionally heard in the form of "letters to the editor" of leading southern dailies, will probably never again arise as an issue demanding action on the part of street railways. It seems some years ago one of the leading New Orleans lines running through the American part of the city did put on in response to an urgent demand from the whites, an equipment of cars to be used exclusively by the colored people. These cars were precisely similar in every respect to those reserved for the whites with the exception of the exterior painting, which was red. So far as the colored people were concerned they observed the regulation to the letter and patronized only those cars assigned them. But not so with the whites. Many of them wanted to take the first car which came along regardless of color and insisted on riding in the red cars. Hence, by the very action of the whites themselves, it was impossible to maintain the color line. But the chief difficulty lay in the fact that there were not enough riders, black and white, to maintain the expense of the separate equipment, and finally after giving the scheme a fair trial, during the last year of which the road lost \$25,000 in this branch of the service, it was abandoned. Verily the street car is a cosmopolitan institution; where all nations of the earth move on a level at five cents a head.

BALTIMORE traction is now threatened with a restrictive ordinance limiting the speed of cable and electric cars to six miles an hour when crossing other streets. We have so often expressed our views on these restrictive speed ordinances it is unnecessary to enlarge upon the subject now, but as a matter of fact such regula-

tions can never be framed to fully meet the wants of the public unless a special ordinance is made to cover almost every individual cross street of every line. The specifying of six miles as a maximum is a virtual permission to run at the full limit of that speed, which at some cross streets might involve a far greater degree of danger than thirty miles in outlying districts. The people demand rapid transit; judging from the proposed ordinance some people demand municipal protection. The railway is working to earn a dividend; every accident lessens the possibility of that dividend; therefore on purely selfish motives the company is bound to use all reasonable caution at places where caution is required, and should be left free to run at high speed where they see an opportunity to do so with safety. These conditions of safety constantly change. What is today a proper speed on a given street may be a highly improper one tomorrow as local influences change. An inflexible ordinance can never follow and adapt itself to these changes. Why has not some bright alderman introduced a bill requiring cars to go around each cross street, instead of crossing them at all? Here evidently is a glowing opportunity for somebody to immortalize himself in the hearts of his "constits."

A PRACTICE that never seems to have been inaugurated by street railway companies, but nevertheless one that would seem to be worth developing, is suggested by Professor Badt in connection with his opinion on the safety of selling light and power from trolley circuits, given in our June issue. We refer to the use of motor transformers for reducing the voltage of the railway circuit and making its power available for a much wider range of work than at present. By having a motor transformer with secondaries of low voltage, power could be supplied to a large number of small motors and incandescent lamps in parallel. This secondary circuit would not be grounded, and on account of its low pressure the wiring would have to be no better than that of ordinary incandescent circuits. In fact it is not unlikely that in some places the lighting companies would find it of advantage to rent power from the railway for supplying its few day customers rather than keep running on so light a load. If a building has been wired for a 110-volt or 50-volt system it is a simple matter to connect the railway circuit to it through one of these direct current transformers located where the wires enter the building. This opens up practically a new field for street railway stations. Motor transformers have been on the market for some time but never seem to have come into use. The loss from the transformation is from 10 to 25 per cent, and the attention necessary to keep the machine in repair is very small. For running large motors and arc lamps the direct supply method is undoubtedly the best, but for supplying small devices where the convenience, if not the necessity of low pressure, has prohibited the use of the railway current there is a new and undeveloped field for those who care to take up the matter.

THE annually nervous man in Brooklyn who regularly and religiously celebrates the advent of open cars and whistles in that city by bombarding the various companies through the columns of the daily press, now has a brother in folly. As a pair of precious, idiotic fools they should be shipped to Chicago and put on exhibition with the other mummies in the Egyptian temple. The latest is the man who tendered a conductor a five dollar bill which he could not change, there having been a run on his bank all that trip. Finally he stopped the car and went into a store for change. Remaining longer than pleased the passenger, the latter went in search of a justice of the peace, and when the conductor returned was not in sight. The conductor then resumed the trip, and turned in a special report with the \$4.95 to the superintendent. But where was the man who was hunting a peace officer to make war? He, too, returned to the place where the car was last seen, but it, strangely, was no longer blocking the street. Then this officious individual, who travels with neither sense nor cents, swore in big round oaths to himself, and swore out a charge to the grand jury, which latter with an exhibition of great and unsuspected wisdom, held the conductor to trial on charge of misappropriating the passenger's money. There are those people in this world who doggedly stand upon the letter of what they consider their rights, to the disgust of all sensible beholders. The unwritten law of the land is that two dollars is the reasonable limit for which change may be expected on a street car. Were all the conductors of any good sized road to carry enough money to meet any possible demands, the aggregate would reach away up into the thousands. Exact change may be insisted on in the purchase of stamps, at any postoffice in the land, and on many accounts such a law would not be without its advantages to all concerned, could it be applied to the payment of street car fares.

ON the occasion of the opening of the first electric railway line in Oregon City, the Portland Oregonian says, in reviewing the patience and hardships of forty years ago: These men, the territorial fathers, and the sponsors of the state, never lost faith in Oregon City. To them it was the "Lowell of the Pacific" through all of the slow years wherein growth was as foreign to it as to the grim walls of basalt that sentinel its mighty water power. Over and above the monotonous roar of the falls of the Willamette they could hear, in imagination, the rumble of machinery, and thickly crowning its picturesque hills the peaceful homes of industry met their prophetic eyes. Yet, in all of their faith in the future of Oregon City; with all of their dreams of her prosperity and industrial greatness; with all of their visions of wealth for those who could patiently bide progress of events and wait for the country to grow up around this wonderful manufacturing center, their anticipations fell far short of the realities that electrical science has brought to the slow old pioneer city of the falls. The term of human life, though proverbially and indeed relatively short, seems of

prodigious length when judged by events in locomotion, so dissimilar, as those represented by the slow, dragging pace of jaded oxen, drawing clumsy wagons, that had made the transit of half the continent, their travel-stained canvas covers sagging dejectedly between the careening bows, and the electric car, with its luxurious appointments, gliding swiftly, as if by magic, over steel rails. And yet this miracle of growth has been presented upon the narrow thoroughfare known as Main street in Oregon City within the memory of a generation. The sturdy, sanguine, brave old territorial fathers lie with mute faces to the East, on the hill above the old pioneer town. The new city—the city of their hopes and dreams—has crept up to and out, and beyond the place which, upon the testimony of many a marble tablet, is "sacred to their memory," and and no rejoicing over the miracle of growth that has so far surpassed in wonder their long-cherished dreams, can be complete without reference to the simple part which they played in the transformation. Their faith in the future of Oregon City was literally "an evidence of things not seen," as through their long, monotonous days, nature held inviolate the secret that science has since coaxed from her, and made the mighty working element of material progress.

COMPETITION is a good thing so long as it is kept within the lines of sound business principles. When it goes beyond that limit it becomes dangerous and a misfortune. Probably in no business is competition stronger than in the sale of street railway supplies, especially apparatus. While prices have not been cut so much, although having had a downward tendency during the last year, there has been an altogether too general disposition to accept orders on deferred payments, and in this the seller who could take the least cash and the most paper has not infrequently secured the order. In many cases the paper has extended to twelve and even eighteen months. This latter tendency we believe to be productive of bad results all around. Equipment, if good, is expensive, and the maker should not be expected to carry this load for the buyer. The production of all kinds of street railway machinery involves a larger first cost for labor than for material. Labor is strictly cash, being usually paid for at the end of every week. It has thus been possible for many roads—chiefly speculative roads—to be built, which it would have been better for all concerned had they not been built for a long time. Promoters who are discounting the future to the extent, of incurring heavy obligations, which they expect to meet by the sale of securities eighteen months later, are taking unreasonable chances, and, in most cases, find it just as hard to meet payments when the day of judgment comes as when they made the paper, which was so easy to do. While we concede that a solid, responsible road, which has already an established business, may often require time in which to pay for additions, we believe that when the amount involved is large they should be the ones to make the loan, instead of throwing the responsibility upon the manufacturer. We believe it is

unreasonable to expect it of him, and we know of not a few who are drawing the lines close on this class of work, preferring to put in no bid where it is understood that there is nothing but long time notes in sight. If all would agree to this, the effect would be most salutary. Buyers, also, are indirectly made to suffer from this too liberal policy. Losses are increased which other buyers are made to share in buying at advanced prices, or in failure to receive reductions, which would otherwise be possible; while the ability to promote competitive sand-bag lines is largely augmented and made easy. If a legitimate enterprise cannot raise money to purchase its plant, how can the manufacturer hope to carry its load in safety and success?

MAKE THE MOST OF YOUR ADVANTAGES.

PROBABLY the manager who reads the following suggestion will not consider it as anything specially new to him. Doubtless he has thought of it more than once. Doubtless, also, the most of him has been interrupted just at that particular moment, and so the idea has never been worked out to a practical finish. It is not necessary, however, to do the work one's self; turn it over to one of the boys in the office and let him bring you an outline which you can correct, revise and improve.

There is scarcely a city, large or small, which possesses the luxury of a street car, the attractions of which cannot be as well or better seen from a few trips on its car lines than in any other way.

Have a neat little pocket folder printed, with a map of the city on one or two pages. Show the streets on which cars run; indicate all parks and prominent buildings; any factories or manufacturing establishments which allow visitors to inspect their works, and the location of theatres, hotels, depots, post office and other similar public places.

On another page give a route which the visitor may best take to see the residence portion of the city. Tell where to start, what car to take, where it goes, what can be seen on the trip, and how long time is required to go out and return, and the rate of fare. Make an itinerary for each prominent line of cars. Tell where the public library is, and art gallery if there is one; when they are open and name any special feature of note to be found there.

If any line runs to a river or lake where there is interesting scenery, fishing, boating, bathing or skating, tell all about it, and set forth the great pleasure to be had and the little time and expense involved in attaining it—always, of course, via your line of street cars.

Don't forget the churches, with hour of service and name of pastor, and the car line which the stranger should take to reach each one. All this and a great deal more affords information which is of real service to the stranger in town, and even to the frequent visitor will often suggest rides of which otherwise he would never have thought.

Save a page or two for advertising cards, for home advertisers. It is an excellent medium for many lines of

business. Make the charges just enough to cover the expense of engraving and printing, and when the little guides are out, procure some neat tin boxes and nail them up in the depots, hotels and barber shops. The attendants at each place will be glad to replenish them when empty, from the large package which your office boy should deliver once each month or week as required.

A good plan where the city is large enough is to get out an edition once each month, and publish the railroad time tables also. In short, make it just as valuable to the stranger in town as possible; print neatly and illustrate if possible; give them away freely; where there is a union depot, and the city is not too large, it will often pay to keep a boy or young man there to direct strangers to the street cars, and distribute the guides among arrivals.

THE WADDELL-ENTZ SYSTEM.

FOR some time the Waddell-Entz Company, of New York, has been pushing its business publicly, saying nothing of the results achieved. Now, however, they are putting their specialties into larger fields and the STREET RAILWAY REVIEW is glad to illustrate one of their prominent specialties, namely, the multipolar generator illustrated herewith. This

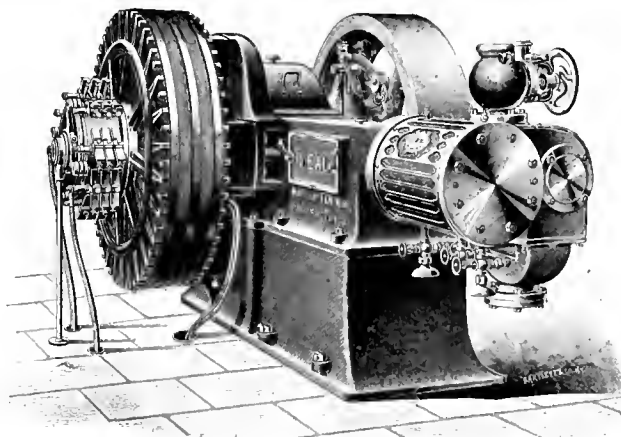

THE WADDELL-ENTZ GENERATOR DIRECT COUPLED TO HIGH SPEED ENGINE

generator is attracting considerable attention. One point in particular being the peculiar arrangement of its pole pieces, only one coil of wire being used to energize the magnets. The pole pieces are of homogeneous cast steel, the softness of which makes it peculiarly sensitive to the influence of the series coil, and the automatic regulation of the machines peculiarly fine. The armature is of the German ring type revolving outside of the magnets. The heat limit is very low, the armature ventilating itself very thoroughly by revolving. The factory of the company is at Bridgeport, Conn., and is equipped with the best and most modern tools for the building, in all sizes, of direct-connected dynamos as well as low speed motors, storage batteries and like appliances.

The mechanical designing is directly under the supervision of Montgomery Waddell, while the electrical designing is in charge of Justus B. Entz. Among their work

in street railway lines it may be mentioned that the company is operating the Harlem Division of the Second Avenue Street Railway, New York, and has erected in the old stables at One Hundred and Twenty-seventh and Second avenue, a complete storage plant, using their own generators for charging, their own motors for driving cars and their batteries for operating everything about the station, including lights, electric cranes, etc.

The company numbers among its stockholders some of the heaviest capitalists in the East and West, and is entirely competent to undertake electrical work of any magnitude. They are now about to push their business in the west, having lately acquired the services of J. Holt Gates, formerly general sales agent of the Siemens & Halske Electric Company.

The officers of the Waddell-Entz Company are: Percival Knauth, president; Montgomery Waddell, vice-president and general manager; J. A. Machado, secretary; A. A. Whitman, treasurer; J. B. Entz, technical superintendent. Their general offices are at 203 Broadway, New York, their western offices 1122 Monadnock block, Chicago.

THE STEVER RAIL JOINT.

A PERFECT rail joint has been the subject on which hundreds of pages have been written, and has never failed to furnish a topic for lively discussion when interest flagged at any gathering of practical railway and railroad men. The rail joints offered from time to time are legion. A few have possessed real merit; the most have proved worthless. The tendency of late has not only been toward a decided increase in size and weight, but number of parts, also until several types came to resemble

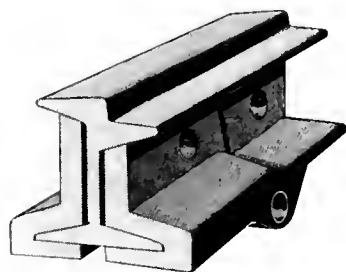

CROSS SECTION STEVER JOINT, WITH GIRDER RAIL.

some ugly excrescence which one sees on trees in the forest.

It is positively encouraging therefore to note the simplicity and strength that has been combined to form the latest in rail joints—the Stever railway rail joint. It cer-



STEVER JOINT COMPLETE, AS APPLIED TO TEE RAIL.

tainly cannot lessen its parts for it has but two, and yet when in position the joint is stronger than the rail. It will

also be seen that the bolts have been so distributed as to secure the greatest possible strength and distribution of strain, and that where the shock comes heaviest the bolts are massed.

It yields greater vertical strength than the angle bar, and the jaw clamp being of less length than the angle bar, the general deflection of the rail under traffic will pass unbroken through the joint. In this device the wheel strain in passing over the rail ends is conveyed directly to the jointies. Its adaptability is general, as it can be applied to any design of girder or tee rail.

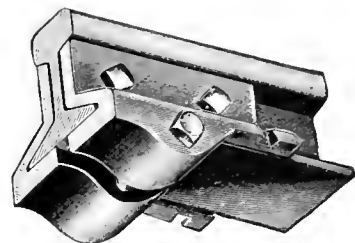

CROSS SECTION STEVER JOINT, WITH TEE RAIL.

The rail ends at joints are subject under traffic, not only to downward and side strains, but also to one of equal intensity in an upward direction. This latter strain is fully provided for in the Stever rail joint by properly supporting the rail ends from beneath by a rigid jaw clamp, making a practically continuous rail, avoiding all pounding at rail ends and trouble from loose joints.

The company's offices are at 407 Chamber of Commerce building, Chicago, in care of C. H. Brampton, vice-president and manager. The joints are manufactured at Alliance, Ohio, and the officers of the company are: G. A. Wells, president; C. H. Brampton, vice-president and manager; Geo. Stever, secretary, and C. W. Major, treasurer.

HOW IT HAPPENED.

ACCIDENT reports are perhaps among the most brilliant beams of sunshine that illumine the interior of the superintendent's office. The following hails from Cleveland and seems to have disregarded the blanks, the report being mainly in the "remarks." It runs thus:—

"In the tie up Between 9 and 19 o'cl while Laing Between Erie and Woodlan on Central av a Colored Gentleman deliberately Got up and rung up several fairs I went Back and asked him mainly if he did it he called me a Liar and also Called a Lady a Liar that said he did Several words Passed Between us he Struck me and knocked me a Gainst a window and Broke it out after wich was the falt of the Colored Gentleman Getting Several Black eyes and I hadent any."

ATTEMPTS to wreck electric railway trains have become uncomfortably numerous of late. The last attempt was made on the Neversink Mountain Railway, at Reading, Pa. Wholesale murder was evidently the object as robbery would not have netted enough to justify the attempt. A considerable part of the Neversink line extends along steep embankments, high precipices and over ravines. The obstructions were placed where had the attempt been successful, fifty lives would have been lost. That no accident occurred is little short of a miracle.

A SAFETY BRAKE FOR MOUNTAIN ROADS.

OUR readers will no doubt recall with pleasure a short description and fine engraving of the Hong Kong cable road, that appeared in the STREET RAILWAY REVIEW for February, 1893. Two important items of interest were not furnished at that time by our correspondent. One of these items is of interest to the European residents of Hong Kong, and bears witness to the fact that the projector and promoter and builder of this line was the well known A. Findlay Smith, J. P., F. I. Ins., one of the most progressive and far seeing traders in the Orient. The other fact is of interest to every mountain road builder in the world, and pertains to the one of the most perfect and efficient brakes for dangerous grades and mountain roads that it has ever been our pleasure to see.

It will be remembered that the Hong Kong road has as varied a collection of gradients and curves as may be found anywhere in the world. The grades vary from 1 in

The Hong Kong cars are brought to stand without perceptible jar, on a grade of 1 in 2, in about a car length.

By reference to the engraving two strong pinions may be seen. These are of phosphor bronze, and secured to the leading and trailing axle of each truck, and similar pinions fitted to a long arm hinged at one end to the frame of the truck and held out of gear when not in use, by means of a light chain running to the roof of the car, and attached to a lever at the conductor's hand, and also attached to the automatic speed governor, either of which can independently put the safety appliances to gear instantly. The cavity of the upper pinion contains pawl and ratchet gear, so that the wheel may run idle when geared to the one on the axle during ascent.

The energy of both axles is transmitted to the brake by means of a strong chain or otherwise. The screw shaft connects to the long arm by means of an endless stud link chain of sufficient strength.

A light pitch chain wheel on one axle drives the governor by which the speed is regulated. The grip jaws,

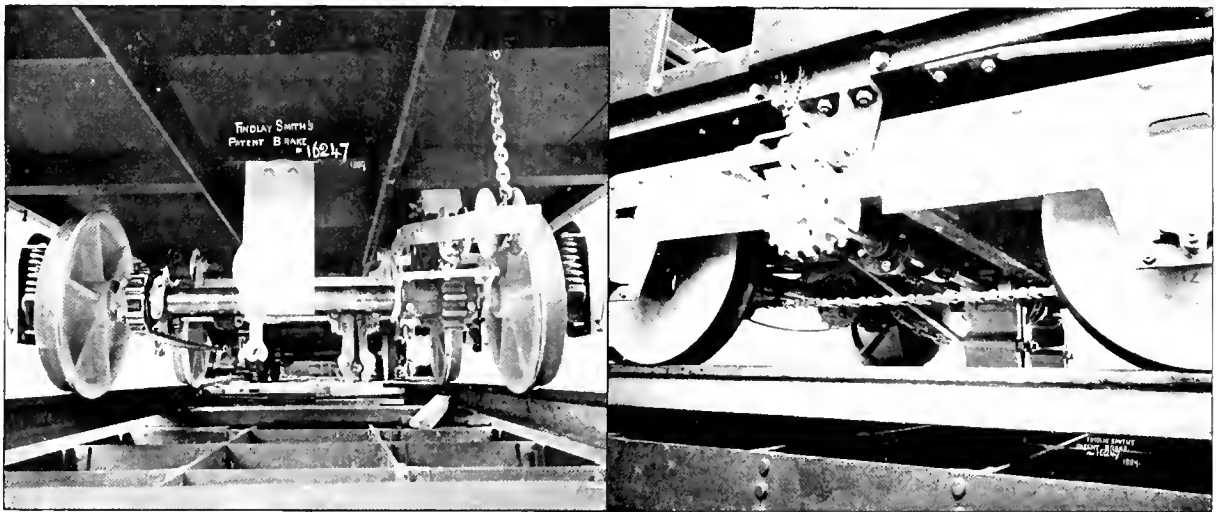

SAFETY BRAKE FOR MOUNTAIN ROADS.

25 to 1 in 2, and the curves turn at various points on the grades from 500-foot radii to 300 feet, making a difficult passage. The government is most tender of the lives of its citizens, and the most rigorous tests are made every six months by a government commission.

In view of the awful accidents that have occurred of late on mountain railways in this country, it would be worth the while of managers to investigate the brake that has been so successfully used by the Hong Kong railway.

This brake, which is herewith illustrated, is now introduced to the American public for the first time.

The brake consists of two wrought iron grip jaws under each car, arranged to attach to a center brake rail and operated by a right and left hand screw shaft, which is moved by the car axle wheels, the power coming from the descent of the car.

The brake is applied automatically when the speed exceeds eight miles an hour, or by the conductor at will.

which are plainly seen in the front view engraving, are strongly anchored to stay rods secured to the frame of the truck and are subjected to no wear, except as tested by accident or design.

The Hong Kong line was opened June 1, 1888, and no accident has yet occurred which has not been obviated by the automatic action of the brake.

In 1889 a sudden land slide at the top of the mountain pushed the rope down the hill to one side, drawing the car which was at the lower terminus several hundred yards up the line. The rope then gave way, dropping the car full force, but the brakes acting stopped the car instantly. Such a test is more severe than any under usual circumstances.

The New York agent of Mr. Smith is George Davidson, C. E., 32 Pine street, and from here diagrams will readily be furnished and price quoted.

More attention should be given to the factor of safety in our mountain roads, which this brake makes possible.

EXPERIMENTS AND EXPERIENCES WITH LIGHTNING.

BY W. R. GARTON.

LIGHTNING, or the statical discharge, is an unsolved mystery, but its freaks are familiar to the world, and have demonstrated the existence of a natural electricity, which seems to have been born with the sun.

As far back as we can trace, lightning played its part in Nature's program, but not until the development of electrical science and electrical apparatus was the destructive work of lightning so apparent.

The era of electrical street railway development brought to light new and more serious difficulties. The statical influence found in such machinery a favorite place to play its pranks.

In the use of the parallel system, the lightning was not so much to be dreaded as it was in the use of the ground return.

The danger point is the existence of a great difference of potential between the poles of the machine. The reason why ground return street railway circuits are harder to protect than metallic is this, one side is in direct connection with the earth, while the other is insulated from it.

After one side of the circuit has become highly charged there exists a great difference of potential, which will either pass through the generator or motor, thus destroying it, or to earth through some other path. On its passage through the generator armature it does not choose to follow the course traversed by the current, but makes a short cut, rightly termed a "side flash," and leaps through the armature from one coil to another, or from the armature to the pole piece or core, piercing the insulation as it goes, and opening a path for the flow of the dynamic current. Scarcely ever does it make more than one turn around the armature before it leaves it, and here is where the trouble results. In opening up a pathway for the flow of the dynamic current, it short-circuits the armature, or cuts out a portion of the resistance of the armature, establishing an arc between the different coils or layers, which soon destroys the winding.

Usually lightning shows its destructive work in an armature by leaving a hole or two in the head or butt, which extends from the outer to the innermost layer.

It is well understood that the inductive resistance retards the passage of the lightning through the armature causing it to pierce the insulation.

I have found many grounded generators, and motors which have been burned out frequently, notwithstanding the lightning arresters which were there to protect them. Some of these grounded machines I have found by tests would give a reading to the earth through the base, of

from 200 to 300 volts. Upon examining these machines I found their foundations surrounded by surface water, and oftimes the exhaust steam constantly released beneath the floor. The foundations absorbed the moisture until they had saturated the wooden base upon which the generators or motors were standing, so that the screws or bolts which held the base of the machine to the foundations were so rusty and damp that they could hardly be removed. The center of some of these foundations were filled in with brimstone, and this, of course, came directly in contact with the greater surface of the foundation, and had from it became quite moist, and although it was a splendid insulator, and was put there for that purpose, its insulating properties had been weakened by the moisture. In some of these cases, this proved to be the path of the discharge from the generator or motor to the earth. As proof of this fact it left a large hole in the brimstone, and also left it ignited.

Before discovering this trouble, I determined to test the power of the inductive effect of a coil to retard the flow of the lightning to the generator. I placed upon the feeders, or supply wires between the generator and the line a coil with thirty turns in which was a core. In order to reach the machine the discharge must necessarily pass through the coil. At the same time there were placed upon the line at various places air-gap arresters through which the discharge might pass to earth. I then placed two discharge points ahead of this coil, and connected them to a most excellent ground, and awaited results. I had not long to wait, for the next day a storm came, and, notwithstanding all these precautions, the lightning passed all the discharge points and through the coil into the generator the same as before.

This somewhat puzzled me, and I began a search, the result of which was the development of the grounded base as before stated. By thoroughly insulating this base from the earth, the trouble was entirely obviated.

I have also been in stations where a system of oiling was in vogue, whereby pipes were run from one main supply to the various parts of the plant, and in nearly every instance I have found that these pipes came very near, or in contact with the machines as well as with many bearings which were grounded in themselves, or connected with water-mains through the steam supply. As trouble from lightning was of usual occurrence, the lightning arresters were blamed for it, but this was not fair. It was found that by insulating the machine from these pipes, less trouble was experienced, and in all these cases where good lightning arresters were used in sufficient numbers, no trouble whatever ensued.

I have known of the breaking down of the insulation of machines from static discharges when not a cloud was to be seen, and sparks could be obtained from exposed wires when the air-gap was made sufficiently small, but this is a very unusual occurrence. On a misty drizzly



W. R. GARTON,

Inventor of the Garton Lightning Arrester and General Manager of the Garton-Daniels Electric Company, Keokuk, Iowa.

day, when there is little or no lightning apparent, it frequently occurs that a machine burns out.

The claim that a static discharge will not pass through a coil has been time and again proven to be untrue, although every one will admit that it will cross quite an air-space in preference to traversing a coil. Now to determine whether a discharge will go into a machine and break down the insulation, regardless of the inductive effect of the armature, before it will pass around so many turns of wire, we must know whether the inductive effect of the coil which is only separated from the earth by a small air-gap and has no current flowing through it, offers more opposition than the armature where there is a constant flow of current, and of course a living induction.

In 1890, after having some very unfortunate experiences from lightning discharges, I was one afternoon pushed into an experiment which proved most satisfactory. Upon a certain line, which was then under the process of construction, I connected at the junction of the two feeders a coil of seventy-five turns No. 14 B. W. G. magnet wire in the discharge circuit, separated from earth by an air-gap of 1-16 of an inch. Through this coil all the discharges passed that afternoon and evening.

A writer not long since made the assertion that placing a core inside a coil did not increase the inductive effect. He claimed that the passage of the discharge was so quick that the core could have no effect upon it, now if this were the case there would be no inductive effect either. The core tends to increase the inductive effect, were it not so the core of any magnetic field would be of little or no value. I have found by placing two coils in multiple, both being of the same size wire, one having a core and the other having none, that invariably the discharge takes the coreless coil. Another experiment which I tried, that of putting a core in one of these coils, and the other having none, and putting an air-gap in the multiple with each coil, the discharge would cross a larger air-gap when in multiple with the coil containing the core than it would with the coreless coil. I have also proven that a small coil in the discharge circuit is not the cause as is so generally supposed of its failure to catch the discharge, but trouble quite as frequently results from too few arresters being placed upon a line to protect it.

Many railway men think that a small number of arresters upon their line and board ought to do the work perfectly, but do not stop to reason that there are miles of exposed wire outside the station where during a thunder storm discharges are received at various points almost constantly. There also exists upon the line at such times nodal points. These nodal points are constantly changing with the movements of the clouds, and at these points a discharge scarcely ever takes place. If the few arresters should happen, as they very often do, to be at these nodal points, no discharge is likely to occur, but the discharge will pass on and if it does not find an outlet between these points and the generator then it will go through the generator.

The only way to avoid this trouble is to scatter a large

number of arresters along the line so that some of these are always at the discharge point. It is often the case that arresters are blamed for not doing their work, when really it is the fault of installation. The engineer in charge may be fully competent to install his arresters in the proper manner, but too often he is not the man who does the work, but orders it done. The lineman being allowed to use his judgment in the matter, and although the engineer would argue with you on the point of induction, still his linemen are allowed to put the arresters in position without ever looking over the instructions, and generally the instructions are altogether discarded.

In hundreds of instances you will find that the leading in and going out wires of the arresters have been favored with a dozen or two curls or convolutions, and have been allowed to remain without ever having been criticised by those who should know better. You will find also that good joints have been made, but never have been soldered. They are taped over and have corroded. If after a time you were to try to ring through them it would be found quite if not altogether impossible to do so. Had the work been properly done, and all these precautions taken the arrester need never have been blamed.

Many companies think that with a few arresters upon the line they are sufficiently protected, and that it is not at all necessary to have arresters upon their cars. This is not so. I have noticed that where arresters were used both upon the line and cars, the car arresters were called into service more frequently than were those upon the line. I attribute this to the fact that the car is almost constantly changing its locality, and thus is more likely to be at the discharge points, besides being directly connected to the trolley wire where most of the discharges take place, whereas the pole arresters are farther from the trolley wire, and often happen to be at the nodal point.

When arresters are installed many things are to be taken into consideration. One of the most important is locality. I have found that by placing arresters at the ends of the different trolley wires and near the high points discharges almost invariably take place.

THE WILLIAMS ENGINE AND CLUTCH WORKS.

A RECENT removal to a more desirable location is chronicled in the change of office of the Williams Engine & Clutch Works from 63 South Canal street to 162 Lake street, Chicago.

E. P. Rogers still continues in charge of the Williams interests and his territory knows no particular boundaries. Mr. Rogers is well known to the most of our readers, both personally and from the excellent portrait contained in the April issue of the REVIEW. From his four and a half years connection with the sales agency of the Williams Company he has had peculiarly good opportunities to study the needs of western power users, and as a practical engineer is able to judge of conditions and power and transmission contracts.

THE BATES MACHINE COMPANY EXHIBIT.

THE great power plant in Machinery Hall annex includes among other "powers" a Corliss engine made by the Bates Machine Company, of Joliet, Ill. This engine is located on the north side of the annex and drives about 1,100 feet of shafting, giving power to all the exhibits on the north side of the main aisle. The engine is a 20-inch bore and 48-inch stroke and has a 16-foot fly wheel of 27-inch face which weighs 18,700 pounds. The cylinders are jacketed with mahogany and the whole is painted a light yellow which, with the banners

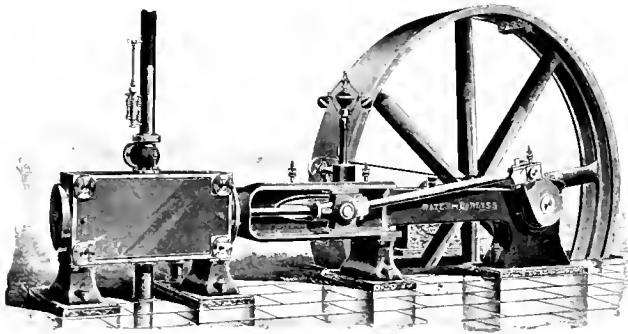

FRONT VIEW BATES ENGINE AT WORLD'S FAIR.

at the corners of the space, proclaim the Bates Machine Company's exhibit.

This engine has several features to which the company calls particular attention. The valve motion is stated to have 60 less parts than other Corliss engines and yet accomplishes all the results. All wearing parts are plain wrist pins. It works very smoothly and is practically noiseless. The valves are released at the wrist plate

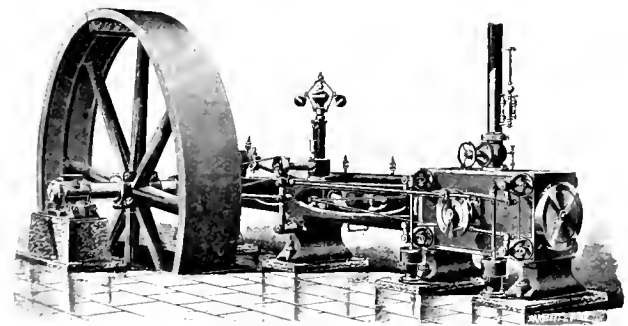

BACK VIEW BATES ENGINE AT WORLD'S FAIR.

instead of at the valve stems, using one journal instead of three.

The girder, guides and main bearings are all cast in one piece and the guides are V-shaped. The cross-head is of box form, provided with adjustable shoes babbitted and scraped to fit the guides. The main bearing is provided with quarter boxes which are adjusted with wedges and can be removed without raising the shaft from bearing. There is great ease of access to all keys, pins, bolts and nuts over the entire engine and they can be removed or adjusted without inconvenience.

The cylinder is provided with four valves. The two inlet valves are flat and receive their motion from oscil-

lating valve stem, connection being made at each end of each valve so that the valve is always open square and the power applied equally at each end. The claims of this type of valve are that they are seated from gravity and steam pressure only, that in case of water in the cylinder it raises the valve from the seat for relief, thus precluding accident, and that they will always be perfectly tight and either valve or seat can be scraped easily to a true surface without extra parts.

The engine is provided with an automatic stop to which the attention of the visitor is particularly directed, as it is designed to set automatically so that in case of accident to the governor while running, the engine will be brought immediately to a stand still. At closing down time the visitor may see the engine stopped by pulling off the governor belt and allowing the automatic stop to do its work of stopping the engine.

These features and others will be cheerfully explained in detail to the visitor by the accommodating attendant at the space which is convenient of access and should not be omitted from the list of exhibits to be studied.

A TROPICAL CAR.

AMONG other things brought from Brazil to illustrate the various methods of travel in use under the equator a very summery street car is perhaps most noticeable. This vehicle, as may be judged from our engraving, is built as much open as possible and the materials used are of the lightest type. It is intended for one-horse traction, and a handle in the rear provides the evident means of derailing the affair and turning it into a road car. The car comes from Rio Janiero and

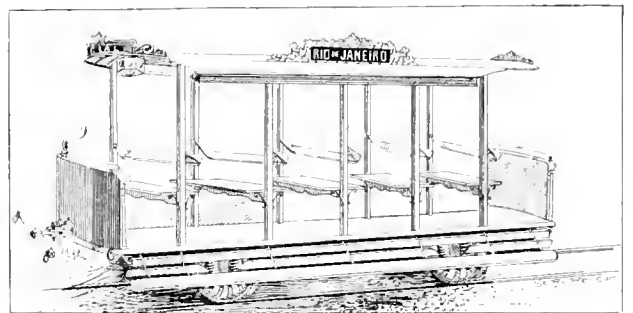

measures eighteen feet over all, with a width of 5 feet 9 inches. The five seats are each 11½ inches wide with straight reversible back attachment. This back, together with the narrow seats, must be a great source of kicking on the part of the equatorial kicker. The top of the car is made of cloth, and painted.

The wheels are 33 inches in diameter with 2-inch tread and a flange perhaps less than a quarter of an inch deep. They were cast in Rio Janiero.

G. H. KIMBALL, who as engineer and manager of the Cincinnati, Newport & Covington electric line having completed the installation of the line, returns to Cleveland, his home, to accept a desirable position.

TRACK CURIOS.

THE southwestern part of the Transportation Annex is devoted to the display of track and roadbed work of all styles and designs. Some light rail is shown which would not in these days be thought fit for a mine tramway, and some German and English steam road

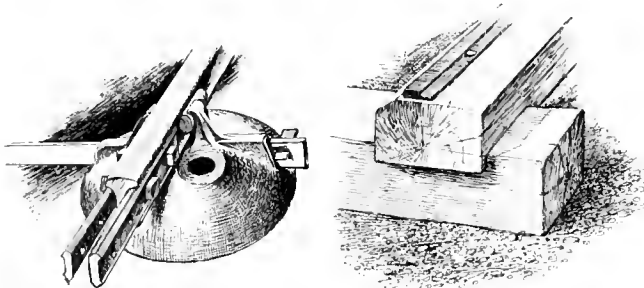

USED IN EGYPTIAN DESERT.

A SOUTHERN TYPE.

construction seems heavy enough for Gabriel's chariot. A choice collection of iron ties is shown. One in particular has cast iron pillows which can be weighted by filling with any convenient ballast. This style was used

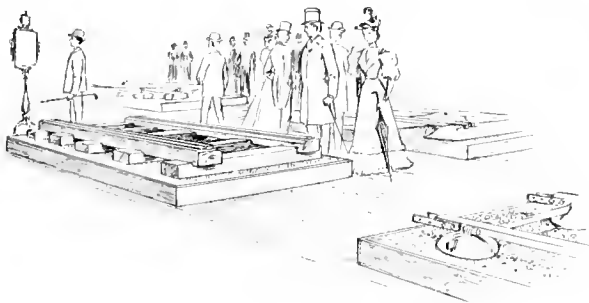

TRACK CURIOSITIES.

in the Cairo line in Egypt on the shifting sands of the desert. Another curious type is nearer home in the shape of the wooden stringer and strap rail type still seen in the southern states and sometimes used on street railways.

MCGUIRE'S TRUCKS IN THE ANNEX.

ALTHOUGH McGuire's Manufacturing Company has fine exhibits on so many of the important roads of the country it was deemed proper to place in "street car row," L. S., 15-16, Annex, a complete collection of their various types of trucks, as well as their railroad specialties. The Exposition office of the McGuire Company is a neatly made and painted box freight car for electric railways, furnished with McGuire grain doors and mounted on a McGuire Columbian truck. This car is inhabited by M. G. Hubbard, Jr., whose well known features are shown herewith. Mr. Hubbard, with an eye to luxury and comfort, has furnished the car with rugs and easy chairs for the benefit of his friends and customers. He says the only difficulty found with the comfort of the apartment is a general desire of the population to take possession of the easy chairs for lunch parties.

The collection of trucks here shown consists of a 20 S type for long suburban and elevated cars. The wheel base is 4 feet 6 inches. Two Columbian trucks are next represented, showing their latest type. These are 6 feet 6 inches wheel base, 33-inch wheels, 2 1/4-inch head and 3/4 flange; fitted for electric equipment. The Columbian is also seen under the box car. A pair of the latest thing in McGuire's swivel truck is also shown. These are for long cars for city service. The piece de resistance of this collection is, however, the bicycle truck, of which the company is of good right particularly proud. The

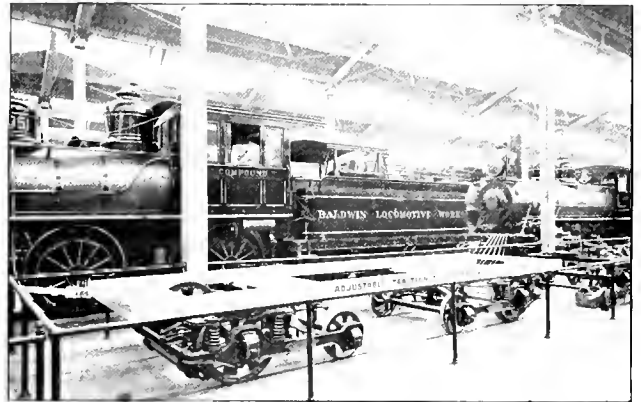

PART OF THE MCGUIRE EXHIBIT.

bicycle is arranged to carry a car 28 inches from the rail. Two 33-inch driver wheels at the ends of the car carry all the load on a straight track, while the other two pairs, which are smaller and run in front or behind the drivers, according as the car may be turned, divide the load at the curves. These smaller guide wheels thus effect a prevention of derailment on curves while leaving the full weight of the load for traction on a straight track. The bicycle pattern may also be seen on the Cicero & Proviso electric line in this city.

A joint exhibit with the Lamokin Car Company is also shown in the "row" and alluded to last month as bought by a German car builder for future reference in European street railway practice.

A McGuire truck also appears in the exhibit of the General Electric in Electricity Building, as described last month.

MAX E. SCHMIDT, secretary of the general committee, announces that informal gatherings will be held in the rooms of the Associated Engineering Societies, No. 10 Van Buren street, every Monday evening from 8 to 10 p. m. Members and their friends are cordially invited to be present to meet foreign and visiting engineers. The Chicago engineers are specially requested to call at the rooms when in the vicinity, if only for a minute, in order to inspect the register on file, so as to ascertain which of their friends are in the city, and to assist in entertaining them and foreign engineers.

ST. PAUL is now connected by a new electric line with Lake Como which is surrounded by a beautiful park.

DEDICATING THE FERRIS WHEEL.

THE great and beautiful Ferris Wheel, the construction of which has already been fully described in these columns, was formally dedicated in the presence of 2,000 invited guests, on June 21.

The opening ceremonies were interesting, including a

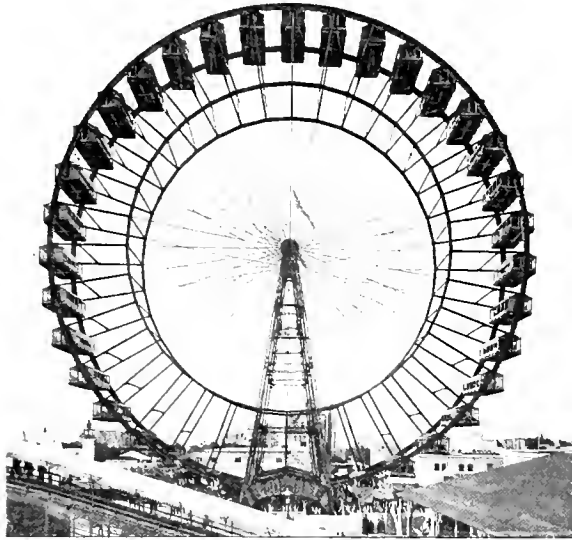

THE FERRIS WHEEL.

presentation of Mr. Ferris to the audience, followed by the inaugural trip, in which every car was filled, and the entire party were swung out into space. Those who

nearly 300 feet above the ground, is one of surpassing beauty and loveliness with the White City below, the blue waters of Lake Michigan beyond, and the great city stretching away on the west, until lost in the green praries of the distance.

THE ANSONIA EXHIBIT.

WHEN the visitor arrives at the north end of the Electricity Building he begins to appreciate the various little arrangements made for his comfort by the various supply houses, and is more than thankful to give his tired legs a rest from stair-climbing by ascending into the entresol via, the free elevator supplied by the Ansonia Electric Company.

Arriving thus in the north gallery, he finds a pavilion extending the breadth of the entresol, devoted to Ansonia and its products. As the pavilion is nearly always surrounded by a crowd of visitors, it is needless to say that popular interest is with Ansonia.

The style of the pavilion is Moorish, ornate without vulgarity, and attractive yet dignified.

Here at the east end is shown an electrical kitchen, with ovens, stew pans, flapjack griddles, electric curling tongs, and everything imaginable to make the weary housewife wish for a similar equipment in her home. The Ansonia will probably be to blame for several divorce suits, because if hubby doesn't buy an electric kitchen somebody will surely "go back to mamma."

Besides this there is an eminently practical and com-



ELECTRIC COOKING EXHIBIT OF ANSONIA COMPANY.

have tried both, say there is all the excitement of a balloon ascension without any feeling of uneasiness as to the absolute safety of the ride. The view from the top,

plete display of electrical railway goods, trolley bridge hangers, brackets, pull overs, switches, anchor plates and measuring apparatus; Wirt indicators, voltmeters,

ammeters, dynamo brushes, and everything in this line sold by Ansonia. Habirshaw wires and cables, insulators and insulating materials are exhibited galore.

The central part of the pavilion is devoted to show



FIRST DYNAMO BUILT IN AMERICA—ANSONIA EXHIBIT.

boards, upon which are displayed the hotel annunciators Ajax and Diamond carbon batteries, Ruhmkorff coils, small batteries and Geissler tubes. The Shield brand,



VIEW OF ANSONIA BOOTH FROM AISLE.

wire is also here shown. Near the center entrance at the west side are placed the pioneer light machines made by William Wallace.

At the west end also are a number of Stanley transformers, of from 500 to 5000 watts, and the Lang single, double and triple pole switch.

The exhibit is a fine one, and worthy the Ansonia. Down town, at the corner of Michigan avenue and Randolph streets, the Ansonia Club takes excellent care of visitors, with every convenience and amusement. Hon. George B. Shaw has charge of the Ansonia World's Fair bureau, and George G. Carter is in immediate attendance at the exhibit.

FALLS RIVET AND MACHINE EXHIBIT.

At Section 15, 28 to 29 F. in the beautiful edifice of Machinery Hall, stands the display exhibit of the Falls Rivet & Machine Company, of Cuyahoga Falls, Ohio. Here, in a compact space, surrounded by a fine brass railing and presided over by Charles Babcock, of the company, is a representative exhibit of the power

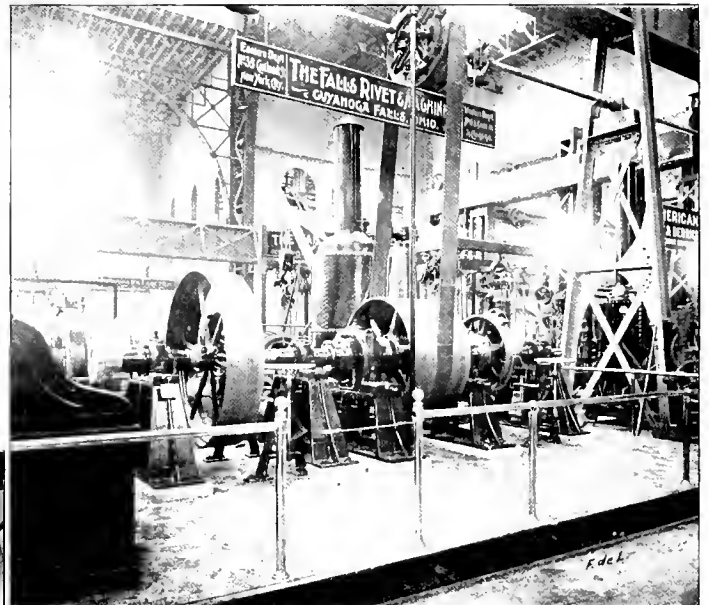

FALLS RIVET EXHIBIT IN MACHINERY HALL.

transmission machinery of this concern. The Falls Rivet & Machine Company has paid such close attention to the wants of central station power users that their product has acquired a land-wide reputation and a more detailed description is eminently fitting.

The Machinery Hall display consists primarily of a line of shafting supported by bearings of the ring-oiling type, so constructed that one application of the lubricant is sufficient for several month's work without further attention. These are mounted on cast iron floor stands, also made by the company, which are provided with the necessary facilities for adjustment vertically and laterally. The shafting supports pulleys, friction clutch couplings and friction clutch pulleys. These latter are covered with a steel rim, making a pulley 40 per cent lighter than cast iron, with claims of equal strength.

This type is the particular pride of the Falls Rivet & Machine Company. There are on the shaft two friction

clutches, easily and very quickly engaged and disengaged by means of a shifting device provided for that purpose. The entire display is so arranged that it can be put in motion or not at the option of the operator. The receiving pulley is keyed to a hollow shaft which is supported by ring oiling bearings of a similar type as those above noted. Any part of the exhibit may be driven in one time by means of the arrangement of the quill in connection

with a friction clutch coupling, one part of which is keyed to the quill and the other part to the shaft. The noiseless operation and ease of adjustment of the exhibit is particularly noticeable.

Over the center of the Ft. Wayne exhibit in Electricity Building extends a line of Falls Rivet & Machine shafting 35 feet long, supported on floor stands substantially in the same manner as



CHARLES BABCOCK.

that in Machinery Hall, with facilities for vertical and lateral adjustment.

The shafting is of forged iron turned, ground and lead lapped for bearings. The bearings are well babbitted with genuine babbit, as are those in Machinery Hall, hammered solid to the shell, bored and scraped by hand so as to fit accurately, and furnished with the ring oiling bearings. On this shaft is a 30-inch cut-off coupling of 4-inch face and seven friction clutch pulleys, two of 64 inches diameter and 13-inch face, one 60 inches diameter and

is beautifully smooth and efficient, and the Falls Rivet people may well be proud of the superscription which declares "All power and transmission machinery driving the exhibit was manufactured by the Falls Rivet & Machine Company, Cuyahoga Falls, Ohio."

So largely has business increased in this department of their manufacture that a New York office has been established at 39 Courtlandt street, and a Chicago office at 8 and 10 South Canal street.

Charles Babcock has charge of the World's Fair exhibit and will be pleased to see all his power and transmission friends at his office in the Machinery Hall exhibit. He is a pleasant gentleman, and is a walking encyclopedia on all that pertains to power transmission machinery.

SCHICHAU'S ENGINES.

A TRIPLE expansion condensing vertical engine, measuring 22¾ by 37½ by 57½ by 27½, with three cranks, built by F. Schichau, of Ebling, Prussia, is a feature of the German exhibit in Machinery Hall. The engine is rated at 1,000-horse-power and runs at 100 revolutions. Steam is to be used at a pressure of 180 pounds per square inch. The engine can be speeded up to 180 revolutions, and at which the power runs to 2,500-horse-power. The engine is intended for marine service, but is connected direct to a Siemens-Halske dynamo. Mechanically and esthetically the engine is a beautiful piece of work, and in spite of its great power weighs only 143,000 pounds.

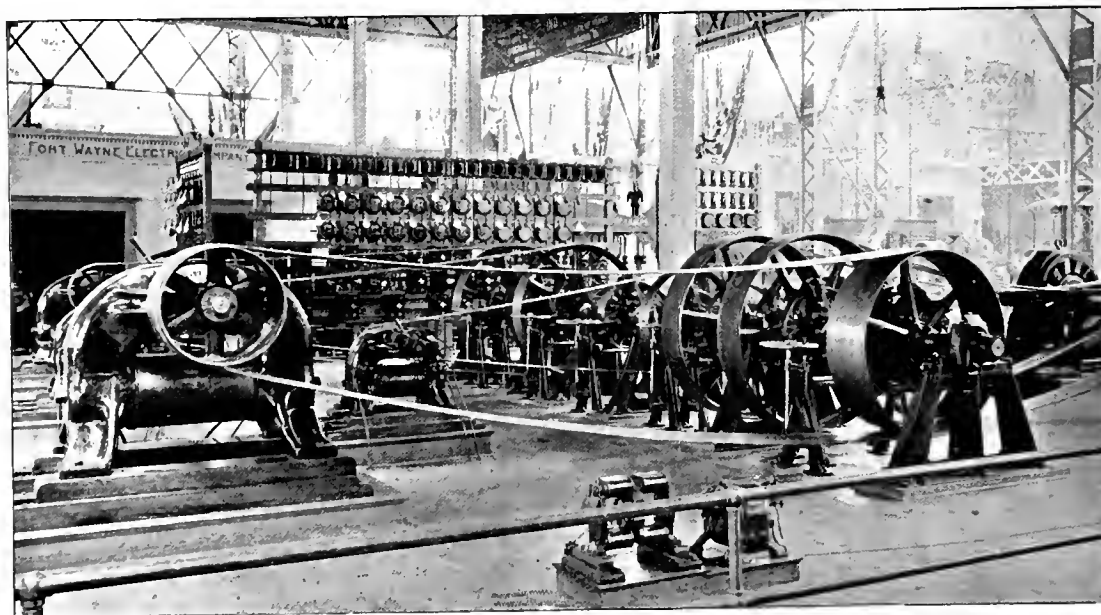

FALLS RIVET AND MACHINE COMPANY EXHIBIT IN ELECTRICITY BUILDING.

12-inch face, one 60 inches in diameter and 10-inch face, one 53 by 10, one 40 by 10 and one 40 by 8. The pulleys are of the steel rim and riveted type and the line of shafting makes 365 revolutions per minute. Under the speed, and on the bare floor, the action of the transmission

ONE of the oldest street railway employes in the United States has just died. His name was W. H. Lehman and for thirty-five years he collected fares on the Germantown branch of the People's Passenger Railway of Philadelphia. His age was 73.

COSMOPOLITES ON THE INTRAMURAL.

ON the invitation of General Manager Baker, the nations of the earth took a ride by representation, on the Intramural railway at Jackson Park. The invitation was in courtesy of the friendliness shown

To the left of the train, in the motor car, was seated the members of the band from the Albuquerque Indian School. They brought with them eight Samoans and five Laplanders. Then Manager Levy, of the Plaisance, came accompanied by 120 inhabitants of the Turkish village, of which number twelve were women. In

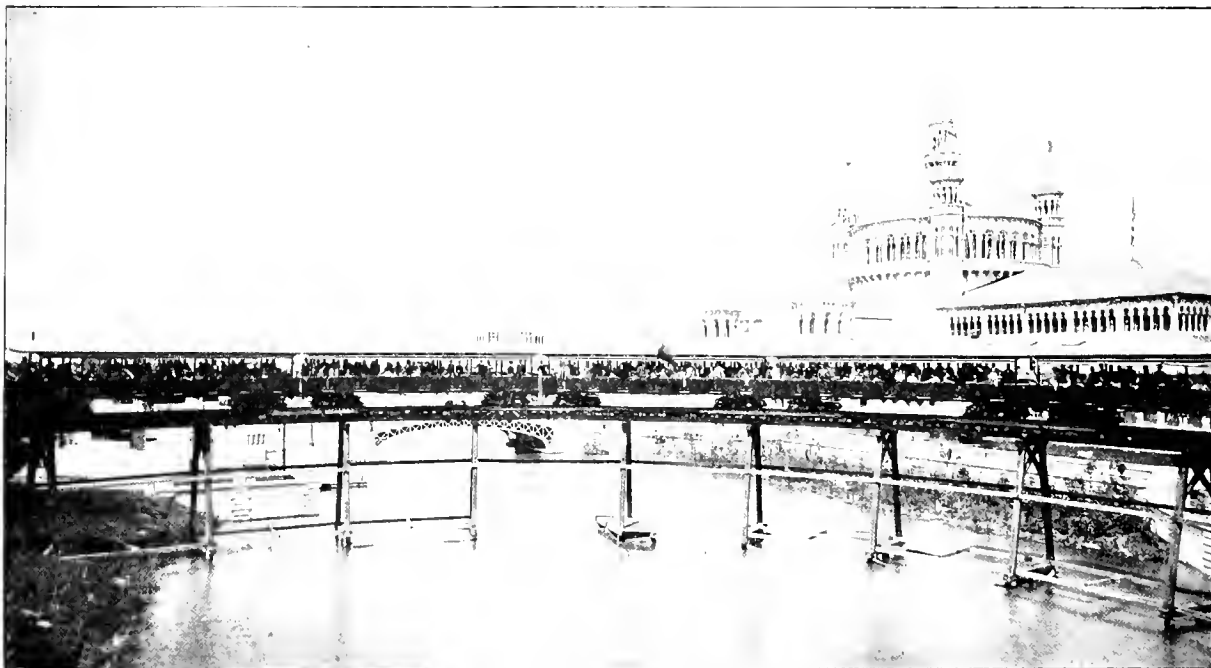

"THE WHOLE OF THE MIDWAY PLAISANCE WAS THERE."

the road, by the managers of the various attractions, to the Intramural authorities, and to say that a hearty response was given we refer the reader to the engraving.

this party were also gorgeously arrayed Assyrians, Bedouins and Ziebecks. The tiger lily over on the wooded island felt really ashamed of its tame red and

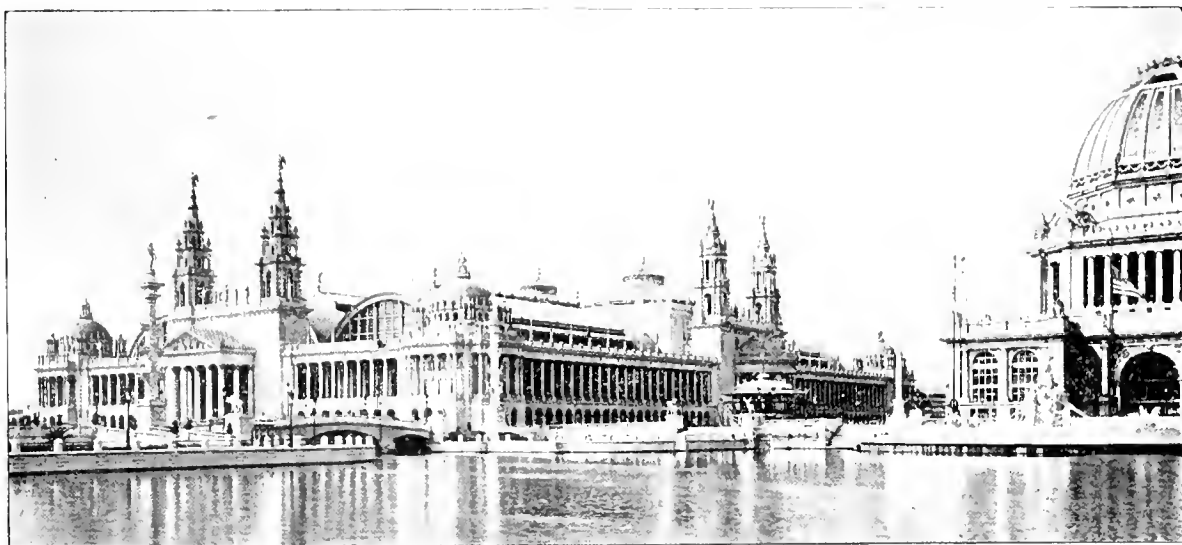

"THE PALACE OF MECHANIC ART."

The whole of the Midway Plaisance was there in force, Jew and Greek, Armenian, Turk, Sythian, Roman, bond and free. Such a collection, anthropologically considered, has never before been seen in one train.

yellow beside the rainbow garments of this host. The musical instruments of the various nationalities erupted patriotic airs, and when no other noise was forthcoming the Esquimaux contingent rent the air with cheers. There

were thirty-five cheers all in a different key, and an old German down below sighed, "Oh, vasen't dot Wagner music beautiful, alretty."

The Irish village, the Algerians and twenty-five tiny Javanese, chaperoned by their various managers, finished the list.

Going south the train was loudly cheered at each station, and when the north loop was reached and the five cars stood on the curve near the Fisheries Building, a snap shot from a photographic camera finished the day and the trip.

The Intramural is now doing a big business both day and evening, and Mr. Baker's good management has raised the average traffic to 40,000 per diem. The road affords a beautiful view of the grounds, and after night, the effect is positively entrancing as the fire fly gleams of the electric lights outline the grand dome and pediment of the Administration and the beautiful proportions of the court of honor. The big generator at the power house has now been put in commission giving ample power, and twelve trains are in service on four minute headway

MACHINERY HALL.

THE palace of mechanic art stands to the southwest of the Electricity Building and directly south of the beautiful Administration Building. Our engraving on the opposite page shows a view looking at the building from the northeast.



THE NORTH ENTRANCE TO MACHINERY HALL.

The building is 850 feet long east and west, by 500 deep north and south, and, with the big boiler room described in a late issue of the REVIEW, cost \$1,200,000.

The building is spanned by three arched trusses, and

the interior reminds the visitor of three immense railroad train sheds side by side, surrounded on all sides by 50-foot gallery.

These large naves are the avenues of the big electric cranes previously described, and which were the Titans who helped place the huge masses of machinery in position.

The building is admirably suited to the displays made, and no visitor to the Exposition can afford to miss this power congress. The street railway power user beyond all others should have the time to spend at least two days in this magnificent building, and among these tremendous displays.

PECKHAM MOTOR TRUCK & WHEEL COMPANY.

ON the south side of street car row and the last but one towards the west end thereof stands the fine exhibit of the Peckham Motor Truck & Wheel Company, under the joint charge of Sales Agent

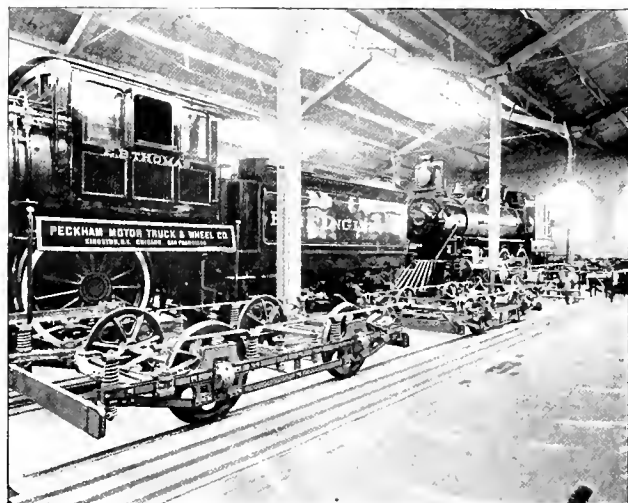

THE PECKHAM EXHIBIT.

Bemis and Geo. Dalton, of the factory. Both of these gentlemen have been in constant attendance at their exhibit and have creditably shown the advantages of Peckham's trucks to the multitudes.

The Peckham office at the exhibit is comfortably furnished with chairs and desk and a table upon which is found a file of the principal daily papers of the great centers, so that visitors from St. Louis, San Francisco, New York or New Orleans will feel immediately at home.

The exhibit proper consists of two trucks, one known as the No. 6, C, being designed expressly for long open or closed cars. This truck can carry 32 or 34-foot cars on a 6-foot 6-inch wheel base without oscillation. This style of truck is provided with an extra extension brace and frame to support the car body which, being part of the truck, makes no extra work mounting or removing car bodies. The truck shown plainly in the left foreground of the engraving is the Peckham Standard No. 6 A truck, and is designed more particularly for closed cars

up to 20 feet in length. The spring-base length of this style is 14 feet. It has spiral springs on the underside of the frame and belongs also to the Peckham non-oscillating type.

"The Peckham truck," said Mr. Bemis, to a REVIEW man, "has nothing but the best A. I. W. iron in its composition. The yokes and boxes are malleable castings and machine fitters, and tests and hot rivet construction leave nothing to break or get loose."

In the office enclosure also are seen the flexible gear and boxes used by the Peckham Company, showing also the ball bearing spiral spring cushion gear. This spiral spring, as the visitor will notice, fits in a pocket and finds its seat in a ball and socket joint on top of the journal box. This joint is intended to give a free movement to the gear and to save the side from strain, while the spiral spring

whose space in Machinery Hall may be seen a complete quill equipment. As the quill arrangement is becoming an important point in electrical countershafting, and as manufacturers of this class of equipment are making special efforts to produce something to meet all requirements, the visiting electric street railway and light man should not fail to investigate the various claims.

In the Dodge space, a detail of which is shown in our engraving, the quill arrangement involves the chain oiling journal bearings, Dodge split friction clutches with geared shafting mechanism, iron center, wood rim pulley, and adjustable floor stands, together with the minor details of a complete outfit. The simplicity and compactness of the plant appeal to every artistic and mechanical taste. The claims of the wood rim pulley for giving the best possible traction surface for belting, make it particu-

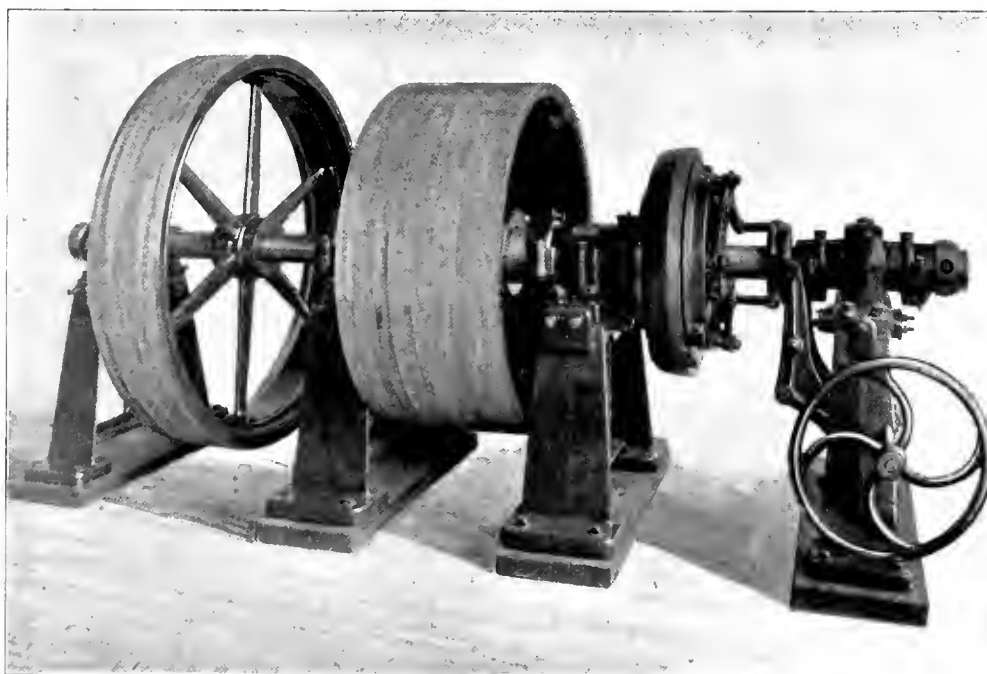

DODGE QUILL ARRANGEMENT--EXHIBIT AT WORLD'S FAIR.

of the gear cushion, the side frame, and tends to relieve it and the motor from jars and shocks.

Street railway men and their friends will be heartily welcomed by the World's Fair contingent of the Peckham Company and we can assure them that they cannot fall into better hands.

THE DODGE MANUFACTURING COMPANY AT THE WORLD'S FAIR.

IN the matter of power transmission, Machinery Hall furnishes some fine examples of the latest designs in clutch work, which the visiting power user, and especially the electrical power user, cannot afford to overlook.

Prominent among the practical displays is that of the Dodge Manufacturing Company, of Mishawaka, Ind., in

larly adaptable for high speed, and the construction aims to obviate the danger of disintegration from centrifugal strain.

The Rice Machinery Company, 166-174 South Clinton street, Chicago, are agents for the Dodge Manufacturing Company's line of equipment, and are contractors for complete power transmission plants for all kinds of service, having furnished and erected the entire line shafting outfit for Machinery Hall and Annex and Mines and Mining Building, besides many smaller lines in different parts of the Exposition. The line shafting driven by the Bass engine in Machinery Hall Annex was manufactured by the Dodge Manufacturing Company, and drives the Thomson-Houston Excelsior dynamo plant.

THE Pleasant Valley Traction has made a proposition to run a mail car between Allegheny and Bellevue.

STREET RAILWAY EXHIBITORS IN ELECTRICITY BUILDING.

FOR the purpose of installation exhibits in Department J, for so Electricity is catalogued, the building is marked into sections and lettered "A" to "Z." On the main floor the sections run from "A" to "Q" and in the gallery from "R" to "Z." These sections are again subdivided by number, which is plainly shown on our diagram.

The STREET RAILWAY REVIEW, by the courtesy of the department, is able to give the last and correct table of street railway exhibitors in the building as far as qualified up to date.

- Acme Filter Company, St. Louis, filters, A, 7.
- American Engine Company, engines, Bound Brook, N. J., H, 2.
- Ansonia Electric Company, Chicago, Z, 1.
- Bates Manufacturing Company, Chicago, Y, 43.

- Eureka Tempered Wire Company, North East, Pa, U, 14.
- Falls Rivet & Machine Company, New York, M, 2.
- General Electric Company, B, 4; C, 1; H, 2; J, 1; M, 4; N, 1, O, 3.
- Genett Air Brake Company, H, 2.
- Grant & Knight Manufacturing Company, Worcester, Mass., belt, A, 4-5.
- The E. S. Greely & Company, New York, F, 8.
- Griffin Wheel & Foundry Company, H, 2.
- Hope Electric Appliance Company, Providence, R. I., transformer cut out, S, 15-16-17.
- Illinois Alloy Company, Chicago, S, 21.
- Jackson & Sharp Company, H, 2.
- Jenney Electric Motor Company, L, 2.
- Jewell Belting, Hartford, Conn., F, 6.
- H. W. Johns Manufacturing Company, New York, U, 21.
- McGuire Manufacturing Company, H, 2, L, 7.
- McIntosh, Seymour & Company, Auburn, N. Y., C, 1.
- Munson Belting Company, D, 4.
- National Carbon Company, Cleveland, O., T, 13.
- New Haven Fare Register Company, H, 1.
- New York Air Brake Company, New York, H, 2.
- Okonite Company, New York, U, 8.
- Page Belting Company, Chicago, D, 5.

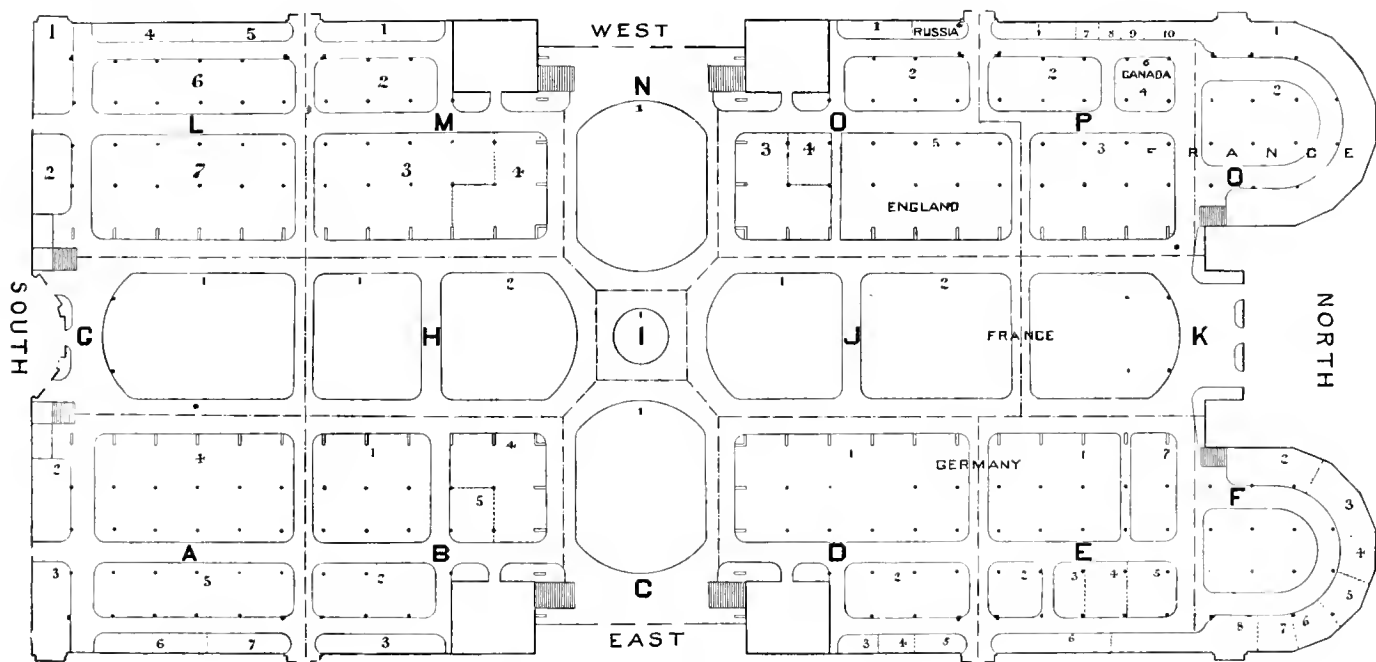

PLAN OF ELECTRICITY BUILDING—MAIN FLOOR.

- Baxter Motor, Department G.
- Belknap Motor Company, Portland, Me., E, 2.
- Bemis Car Box Company, H, 2.
- Billings & Spencer Company, Hartford, Conn., commutator bars, R, 2 a.
- Bi-metallic Wire Company, exhibit track.
- W. R. Brixey, New York, T, 2.
- Brownell Car Company, H, 1.
- C. & C. Motor Company, New York, A, 7.
- Campbell Electric Supply Company, Boston, A, 7.
- Carpenter Enamel Rheostat, R, 6.
- Central Electric Company Railway Motor, U, 8.
- Chicago Belting Company, F, 5.
- Chicago Electric Wire Company, Wilmington, Del., T, 15.
- Cleveland Electric Manufacturing Company, Cleveland, A, 6 d.
- Crocker-Wheeler Electric Company, New York, L, 1.
- Curtis Electric Manufacturing Company, Jersey City, N. J., motors, F, 7.
- George Cutter, Chicago, T, 3.
- Dorner & Dutton, L, 7.
- Eddy Electric Manufacturing Company, Windsor, Conn., B, 3.
- Elwell-Parker Electric Construction Company, Chicago, E, 3.

- Pelton Water Wheel Company, San Francisco, B, 1-2.
- Wm. Powell Company, Cincinnati, U, 18.
- John Ranscher, St. Paul, will have an electric locomotive in the Am Inst. Elec. Eng. room.
- Robinson Electric Truck & Supply Company, H, 2.
- Schieren & Co., Chicago, D, 3.
- Sheffield Velocipede Company, H, 1.
- Short, L, 6.
- Sperry, L, 7.
- Standard Electric Company, P, 2.
- Standard Paint Company, T, 13.
- Stephenson, John, Company, Ltd., H, 1-2.
- Standard Underground Cable Company, L, 5.
- Siemens & Halske, Berlin, Germany.
- Street Railway Journal, Y, 28.
- Taylor Electric Truck Company, H, 2.
- Taylor, Goodhue & Ames, A, 7.
- Walworth Manufacturing Company, Boston, H, 2.
- Wharton, Wm. Jr., & Company, H, 2.
- Western Electric Company, Chicago, A, 3-4.
- Westinghouse Electric & Manufacturing Company, Pittsburg, has B, 1; H, 1; J, 2.

A GRIP LOAN COLLECTION.

THE artistic gate and fence of the California Wire Works Company attracts the attention of the Exposition public as much as the Hallidie historical display catches the eye of the cable man who wanders up and down street car row. Wire cable of all kinds and for all purposes is piled up on the California space beside the gates which faces south and which is a remarkably clever piece of manufacturing skill as well as

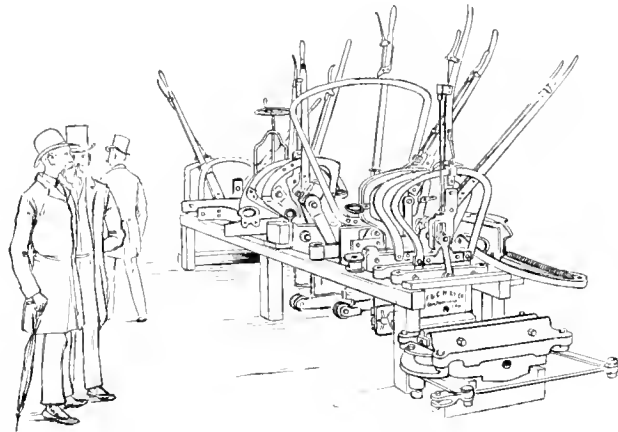

A GROUP OF GRIPS.

of decorative design. Just east of the cable display is the original cable train which is described elsewhere. The grip car and motor are accompanied by photographs of historical interest relative to the progress of cable roads, including a diagram of the original grip mechanism here illustrated. This grip had two screws, one to close the lateral disc-like jaws and one to accommodate the grip

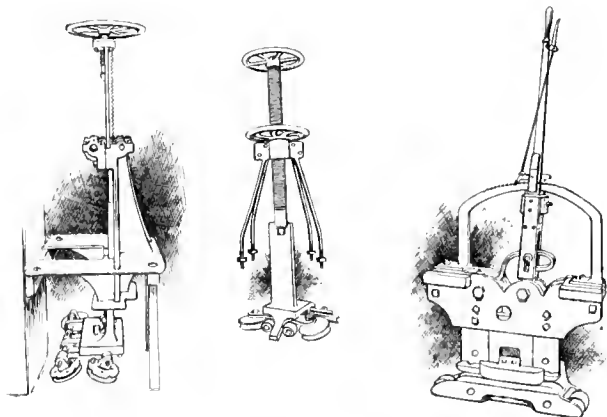

SCREW GRIP. VERY OLD STYLE.

ORIGINAL HALLIDIE GRIP.

MT. ADAMS & EDEN PARK GRIP.

to the height of the rope. The other old form shown is a ratchet device operated to accommodate the uncertain height or rather depth of the first cable.

The wire display is complete in regard to cable railway rope, showing photographs of the original rope and of the improved form and especially the Hallidie rope with triangular outer ply of wire.

Along the north side of the grip car and trailer is a rack containing a full showing of the various grips, loaned by cable railways in the United States.

Beginning at the west end of the rack the interested observer will see a big side action gripper from the road at Hoboken, N. J. It weighs 945 pounds and is the heaviest type ever made. The grip is operated from the end by combined toggle joint and cam. It is not self-acting as regards the rope.

To the side of this heavy weight and on the south of the rack is a specimen of the type used on the Sutter street line in San Francisco. This grip is unlike the one previously described and is automatic in action. To the front, on the north side of the rack, is a Lane grip from Denver. The Lane grip is a graceful looking affair.

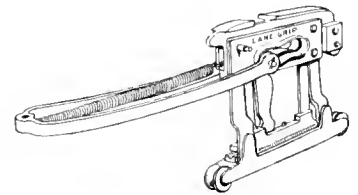

LANE GRIP.

Next to the east of the Hoboken grip is one from the Ferries & Cliff House Road, San Francisco. This has a center opening. Following up the line a Pacific Railway Company grip from Los Angeles is seen. This one also has a center opening. Next we see a Kansas City Cable grip, opening at the side.

California Street, San Francisco, next contributes a single side opening grip of a very neat design. The one following is nearer home, coming from the North Chicago Company, and having lateral jaws. The Olive street line at St. Louis is the next represented with double sides. A Denver City grip with perpendicular jaws comes next, followed in succession by a West Chicago, a Wood & Fowler from Cincinnati and a Missouri Railway Company grip from St. Louis, which opens at the center. Another North Chicago double side grip, one from the Citizens Railway, St. Louis, and a Mount Adams & Eden Park grip from Cincinnati show no marked difference in construction or operation. Another Wood & Fowler grip is next and attracts additional attention from the fact that it is of the screw pattern, which was the earliest design in grips. Its weight is about 150 pounds. At the end of this row standing apart against a convenient post is an early grip of the Hallidie type. It is the second variety made by Mr. Hallidie and is furnished with a ratchet and wheel for lowering or raising the jaws to accommodate the height of the rope. As it was impossible to cross another line with this contrivance it was abandoned as soon as cables became numerous enough and crossings were made necessary.

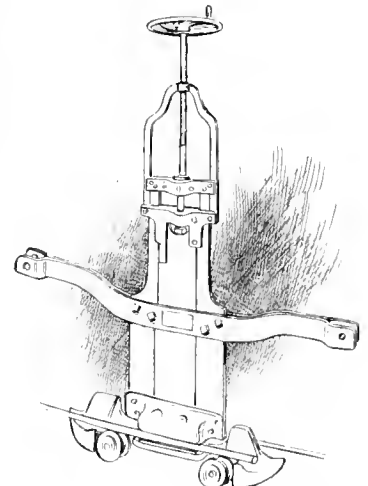

WOOD & FOWLER, LOS ANGELES

A picture, done in water color, of the original Clay street grip, is fastened to the trailer of the original cable train described last month in the REVIEW and also shown in the actual on the grip car of the train.

The patrons of cable railways who have often wondered what "makes it go" are also interested in this fine loan collection, which completes this very complete exhibit—which is an illustrated history of cable railway practice.

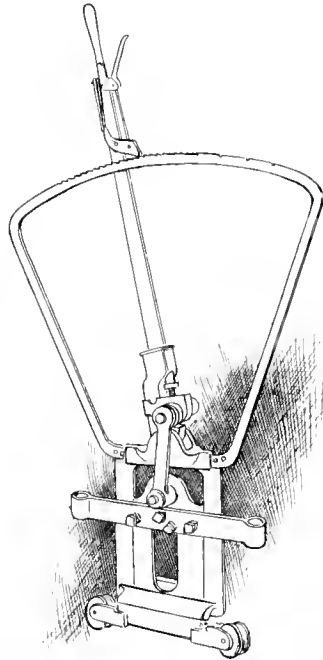

CALIFORNIA CABLE RAILWAY COMPANY GRIIP, SAN FRANCISCO.

It is said that those in charge of the various electrical exhibits at the World's Fair are in danger of going into a decline, or finishing a life of usefulness with a fatal attack of paresis. This terrible state of affairs is due to the gentlemanly instinct of these guardians of progress in answering all the feeble minded questions addressed them by the wandering and wondering public, whose interrogatory remarks, show not only vigorous desire to learn, but an aching void in the region of the cranium where technical knowledge ought to be stored.

EXHIBIT OF THE WESTERN BANK NOTE COMPANY.

ONE of the most interesting sections on the World's Fair grounds is that known as the gallery of the Manufacturers, where education and commercial art are rampant. Here Scribner's publishing house, and the French and German book binders, and photographers whose works are as beautiful as they are true to nature, are shown, together with the various triumphs of engraving for commercial purposes. Space 107-108 E, M, is a wall display devoted to the Western Bank Note Company. The display consists of six frames, holding everyday specimens of the lithography and engraving made by the Western Bank Note artists. Every department is represented, showing not only commercial work but portraiture and landscape as well. The frames are tastefully draped. The main frames show stock and bond details from several prominent concerns, and street railway men will note with pleasure the elegantly artistic and yet thoroughly useful bond and stock forms of the Helena Electric Railway Company, the Austin, Texas, Rapid Transit Company, the Cass Avenue & Fair

Grounds Street Railway Company, of St. Louis, and the Citizens' road, of Indianapolis. Besides these, railroad tickets, and coupons, checks, drafts, notes, and all forms of commercial paper are shown.

INTERNATIONAL FARE REGISTER EXHIBIT.

THE International Register Company occupies a space 11½x6 feet, at L, N, 11, Transportation Building. The exhibit consists of twenty-four portable and four stationary registers, arranged on a specially fine revolving stand of solid mahogany. Outside of the stand is placed a show case 8 by 4 feet. The International Register Company exhibit for the first time their new stationary register, which has been perfected and will be put on the market in a few days. Among the features of this machine are the pure aluminium satin



finished dials. These present a fine appearance, and have the advantage that they retain their color and finish, and will not tarnish or grow dull. Portable registers are shown in three different styles, one of which is a special form made for the West Chicago Street Railroad. The exhibit is attracting no little attention, inquiries having been received from several foreign tramway representatives.

The exhibit stands in a convenient place, and all eyes, even of the lay brethren, are attracted to it. The inviting seat and commodious desk are frequently put to their respective good uses by the visiting street railway men.

SAMUEL RUSSELL, JR., engineer of the Duplex Street Railway Track Company, New York, is in charge of their exhibit, both in Transportation Building and an outside exhibit track, where a splendid piece of track work may be seen, examined and ridden upon.

THE SCHUTTLE MANUFACTURING COMPANY.

TWO drills in more or less constant operation attract the numerous railway visitors in the Transportation Building to Section O, s 3 and 4, where J. Watson has charge of the nice exhibit of the Schuttler Manufacturing Company, of 1007 Monadnock block.

There are two drills shown, one for shop work and the other for track work, both at present working on a heavy rail to show their applicability to various positions and uses.

Besides the two drills a fine line of various sizes of Perfection valve oilers is shown, together with oiler torches for various industrial purposes.

The display is necessarily not a large one, but it makes up in interest what it lacks in size.

THE NEW HAVEN FARE REGISTER.

IN an elegant little space in Section P, block 4, No. 37, Manufactures Building, the New Haven Fare Register has a comprehensive and attractive showing of its latest form of registers. The space is next to the outside aisle on the east side of the big building, and in the north half of the building. The surroundings of

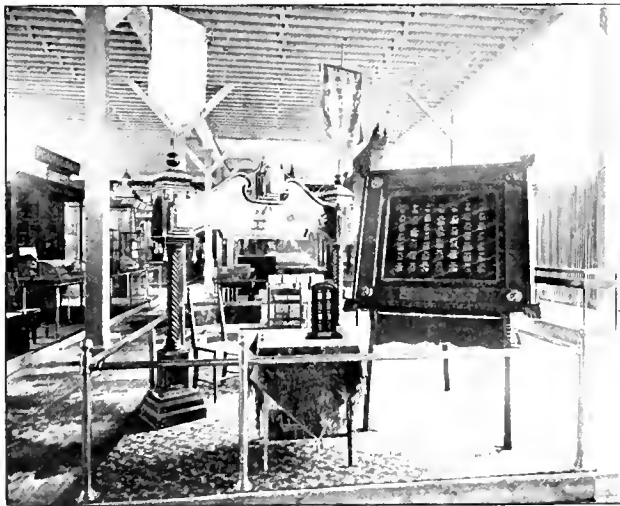

NEW HAVEN FARE REGISTER EXHIBIT.

the exhibit are elegant, and the brass railing seems to sparkle with the proud consciousness of enclosing so pretty a space.

Next to an elegant reclining chair, and set diagonally across the space, is an arched stand or gateway, upon which are set the fare registers for display. On the east side or front three registers are shown, two in bronze and one in nickel. Cords are attached to show the action, and several street railway men who passed while the STREET RAILWAY REVIEW man stood there complimented in terms of highest praise the appearance of the registers and their prompt and reliable action. On the

opposite side a space with more registers is shown, to illustrate the method of attaching the register to the car.

Their exhibit in the Brownell car of the Westinghouse exhibit is also attracting much attention from street railway men who see it there.

KODAKED WITH A PENCIL.

MR. MALONEY was visiting what he was pleased to call the Midway Playsince, with a strong accent on the since. Miss Maloney was with him, and the bright badge which proclaimed their Texan home flaunted in the breeze.

They had seen the wonders of Hagenbeck's trained animals and had indulged in a recklessly Dutch cup of Arabic coffee and a sweitzer-kase sandwich at the Turkish cafe.

Still Mr. Maloney and Miss Maloney were not happy. The wonders of the "Haythen Chinese bazar," as Mr. Maloney styled the booth of the harmless Japanese, only gave Miss Maloney the heart ache and Mr. Maloney poverty.

In fact they were tired.

They had walked miles and miles, as Miss Maloney informed the REVIEWER, and the young lady flatly told her paternal ancestor in the following words that pedestrianism had ceased to be either expeditious or agreeable:—

"Say, paw, do you take me for a burro? I tell you right now I'm just goin' to flop down here and stop, or else you can call one of them things (pointing to a sedan) and get me carried."

Miss Maloney generally has her way.

She did this time.

"One of them things" was duly beckoned to and Miss Maloney installed herself among the interior decorations of the sedan. The forward Turk gave a mighty groan, the rear beast of burden looked mild surprise and the sedan creaked slightly. Miss Maloney was not a light weight.

Away went the caravan with that peculiar single foot pace acquired by the sedan men. "Paw" Maloney brought up the rear. He had a pained expression that was ludicrous beside the triumphant and self-satisfied smile that Miss Maloney dispensed to the admiring crowd of small boys on both side of her chariot of state.

All good things have an end and so did Miss Maloney's ride, and so must this story.

"Paw" Maloney arrived in time to settle with the head follower of Mohamet; but more trouble awaited him. The rear worshipper of the prophet was slighted but still in the ring. With a graceful bow he addressed "Paw" Maloney, "Bacsheesh, bacsheesh."

"Phat the divil does the blaggard want," quoth "paw."

"Bacsheesh, bacsheesh," reiterated the Turk.

"Is it callin' me names, he is?" said Mr. Maloney ruffling like a turkey cock, and turning on the son of Asia he howled:—

"To the divil wid yer back sheesh. If yez thinks yez

can call me names in yer dom'd Frinch lingo yer off—" and Mr. and Miss Maloney found themselves standing victors of the field. The sedan bearers had fled.

* * * *

THE good old lady from Michigan stopped short in her mad career around the windy corner of the Electricity Building. The Columbian guard from Iowa and the gospel chariot evangel from Cross Roads University stood still, with a puzzled expression upon their honest and unsophisticated faces.

The crowd gathered.

"Terribul, ain't it," said the old lady.

"Wonder they wouldn't call a pat roll wagging," said the guard, anxious to display his knowledge of affairs.

"Evidently a case of acute alcoholism," said the chariot pusher adjusting his blue spectacles.

A chance opening in the crowd showed the REVIEWER a short, heavy set man lying flat on the ground. Beside him knelt a comrade; upon the face of the stricken man was a look of agony as the white dust curled over him and got into his nose and mouth. A tremor of the body, a spasmodic twist of the pedal extremities and the mystery was solved. The man arose. His right hand grasped a wire, and the awe-stricken spectators beheld a small manhole out of which a bundle of wires stretched their snaky ends.

Not a word was said. The crowd "sneaked."

* * * *

THE inquisitive little boy is in interest next to the inquisitive little girl. One of the latter, while strolling down the Plaisance the other day, remarked on seeing a Turk in all his glory:

"Say, ma!"

"Yes, my child."

"Say, is that the father of little Red Riding Hood?"

GRIFFIN WHEELS AT THE EXPOSITION.

THE car wheel exhibit in the annex of the Transportation Building, at the Exposition, is one of the most interesting lines of study that can be pursued by the practical railway man.

Prominent among these carriers of progress are those shown by the Griffin Wheel & Foundry Company, at section I, between posts 3 and 4, in the building mentioned.

It is not the design of the Griffin Company to show a general line of car wheels, but the exhibit is confined to those wheels which are in actual use on the Exposition grounds, and on all local transportation lines leading thereto.

Particularly noticeable among the wheels shown is a special pattern of 36-inch heavy spoke wheel, designed for and used exclusively on both the motor and trail cars of the Intramural Railway in the Fair grounds. An 18-inch spoke wheel, used exclusively by the movable sidewalk on the Casino Pier, is also shown, together with a

30-inch spoke wheel, used on the cable and electric lines of the Chicago City Railway. A 33-inch spoke wheel, used exclusively on the South Chicago (Electric) Street Railway, is also exhibited.

The steam car wheel exhibit is extensive and typical, representing the 33-inch plate wheel of the B. & O. and Northern Pacific suburban lines, and a 36-inch plate wheel used by the Illinois Central suburban.

Under the Harvey Steel Car Company car exhibit in the Transportation Building are shown the Griffin plate wheels, and also under the refrigerator car built by the United States Car Company and the Anglo-American Packing Company; stock car of Street's Stable Car Line; locomotive built by Cooke Locomotive Works, Paterson, N. J.; and the spoke wheels under a street car built by Lamokin Car Company, Lamokin, Pa.; Sheffield electric motor truck built at Three Rivers, Mich., and various other cars, trunks, transfer tables and cranes.

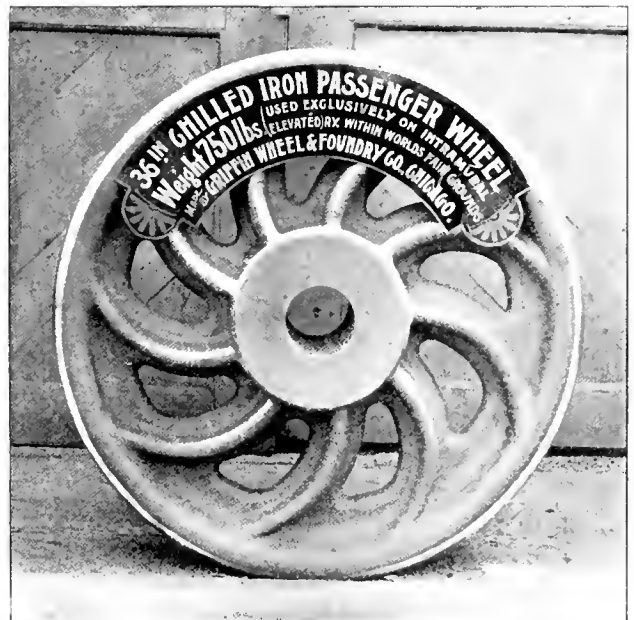

A GRIFFIN EXHIBIT WHEEL.

In the Electricity Building, they have a joint exhibit with the General Electric Company of wheels used on the Intramural Railway, under a truck built by Jackson & Sharp Car Company, Wilmington, Del., and a set of standard 30-inch electric motor wheels, under a McGuire Manufacturing Company truck, and, with the Westinghouse exhibit, their 33-inch standard motor wheels are shown in a Sheffield truck.

The illustration shows the chilled iron passenger wheel used on the Intramural, and which weighs 750 pounds. The wheel is of dense metal and thus capable of a high polish, and the curved spokes are given as original with the Griffin Company.

CAMELS, Egyptian donkeys and a mommoth balloon, capable of carrying 26 persons, are among the recent additions to the transportation novelties in the Midway.

A TESLA EXHIBIT.

ONE of the most interesting exhibits in the Electrical Building, and certainly one which will attract the undivided attention of many of the visiting electricians is the display catalogued as M, F, 2, Department J.

Here the Westinghouse Company has an extensive showing of the work of the brilliant electrician, Nikola Tesla, in the realms of multiphase power transmission. The exhibit is not only illustrative of the experiments of Mr. Tesla, but are of commercial size and operative, as hinted in last month's STREET RAILWAY REVIEW.

Under the engineering skill of W. S. Rugg there is shown, in the above mentioned space, a complete transmission plant, from the water wheel to the motor or lights. This is shown mainly to mark what can be done, but the company after much thought and experiment has decided that the two-phase current is in many respects superior to the three-phase for power transmission. Hence the former is used throughout the exhibit plants.

Ingersoll air compressor. This has a specially designed single reduction motor mounted directly upon its bed, whence comes the power to give a working efficiency to the atmosphere. Here too is a Dorner & Dutton truck, which may be honorably mentioned in connection with a Westinghouse number 3 motor moved from this circuit.

Besides these machines electrically connected to the 500-horse-power transformer there are two others belted to it. These are a 30-light alternating current arc machine and a Worthington power pump. The pump takes water from a tank and propels therewith a Pelton water wheel, which in its turn is directly connected to the 500-horse-power alternating current generator in the generating station, thus giving back power to the generator. The whole adjustment of the system is a high credit to the efficiency of the methods and the skill of the engineers in charge of the various departments whence emanated the machines. Besides this there are in the receiving station a 60-horse-power two-phase motor directly connected to a 900-light alternating current incandescent machine of the Westinghouse standard type. A 60-

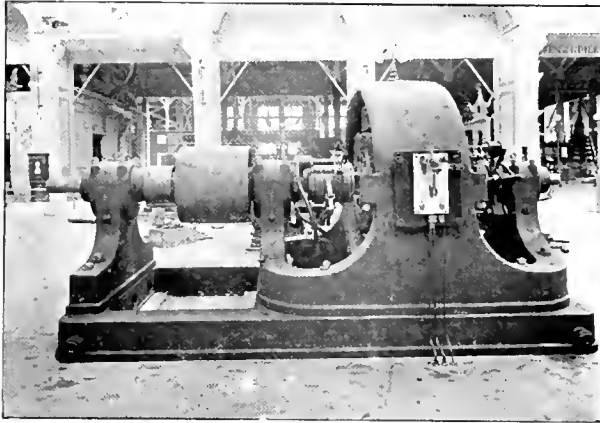

REVOLVING TRANSFORMER OR SYNCHRONOUS TYPE MOTOR.

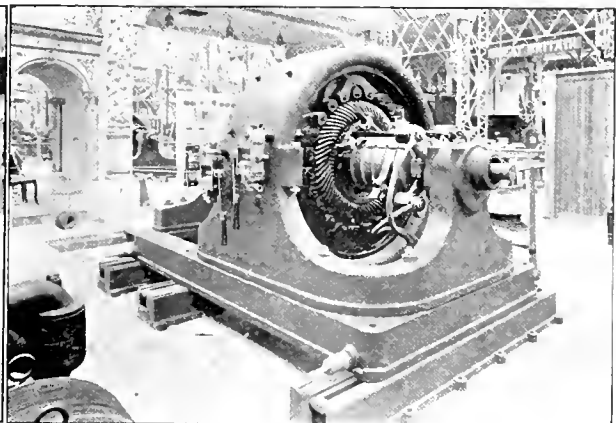

NON-SYNCHRONOUS MOTOR.

To begin at the beginning; a 300-kilowatt Tesla motor was built to furnish power for the plant. This machine is of the rotating field type and is claimed to be largest motor of the kind ever built in this country, and as such will attract much attention as showing the stage of American possibilities in this line, to say nothing of probabilities.

This motor is belted to a 500-horse-power two-phase generator. This machine is of the same general design as the Westinghouse railway generator. An alternating current is taken from this machine, which is passed through a bank of step-up converters and sent out at a high tension across to the receiving station. Here it is used in a variety of ways.

The principal machine in the receiving station is a 500-horse-power revolving transformer, similar in form to the alternating current generator. This converter transforms the alternating current from a bank of step down converters and gives it out as a 500-volt direct current. From this circuit is run a 100-horse-power

horse-power revolving transformer adapted for use in connection with storage batteries in central station work is also shown here and will call for its share of attention. Both stations are fully equipped with a complete switch board each.

These boards, although not of the gigantic proportion of the one in Machinery Hall are of as perfect construction, in the Westinghouse standard, marble paneled type. The instruments are glass-enclosed and present a beautiful appearance.

The operation of all the machines in the plant is controlled through these boards. The boards are monuments to the wiring skill of Mr. Dunlap, of the Pittsburg factory, and certainly show a high degree of aesthetics as well as of (pardon the word) electric.

The whole plant in fact will be viewed with the utmost of attention.

The best skill of the Westinghouse Electric & Manufacturing Company has not been spared to show to the visiting electrician what has been, is and is to be.

THE STANDARD PAINT COMPANY
EXHIBIT.

IN the southwest gallery of the Electricity Building the Standard Paint Company, of 542 Rookery, Chicago, and 116 Battery street, New York, has a comprehensive display of its well known and extensively used insulating material. The exhibit is arranged in the form of a stand, the front of which bears the B. & P. coat-of-arms and colors of France and Spain. The arrangement is beautifully appropriate, and the base shelves of the stand add to the effect. Upon the base shelves is arranged a complete exhibit of the various paints and varnishes made by the Standard Company. Barrels and boxes, cases and cans, quarts, pints and hogs-

AN HISTORICAL INSTRUMENT.

AN interesting incident is recalled in the life of Col. W. H. Paine, known personally and by reputation to many of our readers, and who contracted his fatal illness while constructing the cable road in Cleveland. In Machinery Hall is an instrument which saved Niagara suspension bridge. While the Brooklyn bridge was building experts examined the Niagara bridge and condemned it. Col. Paine was sent for, bringing with him the instrument which is now on exhibition. It is an extensometer, which he had improvised, and which reposes in a wooden case whittled out with a jack-knife by the great engineer. Its readings are to the one-three millionths of an inch. When the instrument was in readi-



M'ONNIES FOUNTAIN—WITH COURT OF HONOR AT LEFT.—ELECTRIC FOUNTAIN IN FOREGROUND.

heads are ranged here in various pleasing shapes, to show the visitor the types of package and the kind of material used. The armature and field coil varnish cans are particularly prominent in all sizes, and cases standing near show the varnish applied, and the finished product both before and after use.

A large and specially ruled register is on a convenient table, and every visitor who is electrically or insulatorily inclined is requested to write his name in the book and designate the particular form of insulation in which he may be most interested.

The Standard Paint Company may be well pleased with its display, both from an artistic and commercial standpoint.

ness loaded cars were rolled upon the bridge, one at a time, until the track was filled. So exact were the readings Col. Paine was able to give the weight of each additional car as it was set in place. The cars were then removed and heavy locomotives substituted, again completely filling the track and affording a rare and stirring sight. The test was so much more severe than could ever again occur, without exceeding the elastic limit of safety, that the colonel had no hesitancy in pronouncing the structure safe, and to-day passenger and freight trains continue to cross it every hour in the twenty-four.

And so the modest extensometer saved the bridge quite as effectually, though less heroically, as did Horatius of old.

KILLED THE GOOSE WHICH LAYS THE GOLDEN EGG.



TIMES during the past few months we have had occasion to chronicle the worse than stupid action of narrow minded town and county boards, in which, unfortunately, authority is vested to strangle enterprise and keep the people who elected them out of many otherwise obtainable advantages. The latest comes from Youngstown, O., and is on a par with the other cases mentioned. General Manager Brown, of the Youngstown Street Railway, with several other enterprising citizens, were desirous of building a line from Youngstown to Girard, a distance of about five miles. The residents on the street in Girard were extremely anxious to secure the road, as indeed was the public generally. Those even who would have been most benefited by the restrictions imposed did not ask any such conditions. They wanted cars and wanted them badly.

The efforts of the promoters to explain the utter impossibility of accepting the terms imposed; and the urgent demands of property owners for a liberal ordinance, seem to have had no influence on the stubborn council, which insisted on the following conditions with the company:

First.—Widen the roadway to 40 feet for its entire distance.

Second.—All stone culverts and bridges not 40 feet wide to be widened.

Third.—That the grade established nearly 40 years ago and never carried into execution be complied with.

Fourth.—That tracks be laid on cinder or macadam foundation.

Fifth.—That the tracks and 18 inches outside be macadamized and kept in repair.

Sixth.—That not less than an 82 pound girder rail be used.

Seventh.—That the speed and frequency of cars be regulated by the Girard council.

Under the existing circumstances the conditions were unreasonable. Girard has a population of only 2,400, and it was clearly shown by an itemized account that to build the line under the conditions imposed would cost \$60,000; that the operating expenses would be fully \$40.00 per day and even the council itself admitted the road under favorable circumstances would earn the magnificent sum of \$15.00 per day in summer and less in winter. They also wanted one five cent fare from any part of Girard to any point in Youngstown, although the Youngstown road was not interested in the Girard scheme.

While Mr. Brown and associates were willing to operate at a loss for a reasonable length of time, and would have done so under a liberal franchise, they naturally had no desire to bequeath any such affliction to their great grandchildren and left Girard where they found it, sticking in the earth.

It is the same old story over again; with the same stupid, narrow minded and possibly well meaning but short-sighted council; and the same suffering community deprived of benefits it might have had; and lastly, the same old moral which we have emphasized so often:

“A liberal policy pays in dealing with street railways; any other brings loss and is folly.”

The public generally are less appreciative of what their local company does for their town than of any other public or private enterprise.

AN ENGLISH RAIL CLEANER.

THE grooved rail in use in England requires constant cleaning, which work has been largely performed by hand. H. Conradi, of Westminster, has invented a device which is sufficiently described by the illustration. The broom is of bass wood, and may at will be thrown in and out of action by a lever on the platform. Steel brushes are reported as not as satisfactory in England as the wood, an experience not in line with that of many American managers.

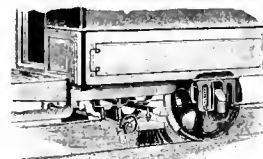

ADJUSTABLE OVERHEAD SWITCH.

THE adjustable switch illustrated herewith is manufactured by the Ansonia Electric Company, of Chicago. It is provided with adjustable tongues, and can be used either as a right, left or diamond turnout. This switch is simple in construction, is provided with

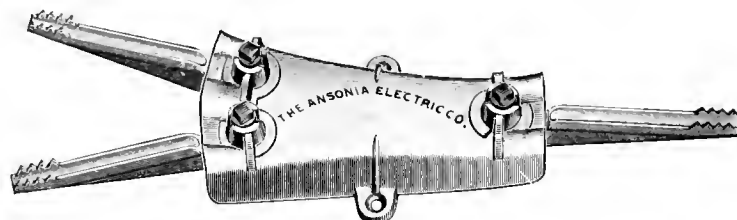

special clamping devices to grip the trolley wire, and is adapted both for light and heavy construction. The Ansonia Company report that about three hundred of these new switches are now in use, and giving universal satisfaction. Electric railway superintendents and electricians say this adjustable switch fills a long felt want, and it can be adapted to any curve or turnout.

DESERVE TO PROSPER.

THE J. H. & D. Lake Company, manufacturers of all kinds of friction clutch pulleys, having outgrown their old quarters at Hornellsville, N. Y., have recently completed and removed to their handsome new offices and foundry at Massillon, O., where with enlarged facilities they are prepared to meet the growing demand of their business.

An interesting feature regarding the rapid growth of the Lake Company is the fact that it came almost exclusively from advertising, for with the exception of a limited amount of traveling, they have had no representative out on the road, except their card in the various class journals.

STREET RAILWAY LAW.

EDITED BY MR. FRANK HUMBOLDT CLARK, ATTORNEY AT LAW, CHICAGO.

Temporary Track Laid Near Obstruction.

Where a street railway company places its track so near an obstruction which it is necessary for its cars to pass, that its passengers are in danger of being injured by contact with such obstruction, it is a question for the jury whether the company is guilty of negligence. Whether the person injured was guilty of negligence in getting upon the car while it was in motion, is a matter for the determination of the jury under all the circumstances of the case.

This was an action for damages for personal injury begun by Williams against the appellant company. Plaintiff below recovered a judgment, which was affirmed by the appellate court. In May, 1888, appellant was reconstructing its tracks, so as to substitute the cable system for horse power. As it was necessary to tear up the streets in order to insert the cable machinery, it removed the track in Lincoln avenue to the east side of the street. Upon the track thus laid for temporary use it was propelling its cars by horse power, when the accident occurred by which the plaintiff was injured. On the east side of Lincoln avenue, near its intersection with Cleveland avenue, stood a telegraph pole, outside of the curb line of the street, and leaning somewhat to the west. The east rail of the track was a little lower than the west one, and was just two feet from the bottom of the telegraph pole. In the evening, while it was yet light enough to see clearly, plaintiff boarded one of appellant's open cars on said temporary track. Plaintiff was standing a short distance from the corner where the pole stood, and a short distance from the track. When the car came along, and while it was in motion, he stepped upon the foot-board on the east side of the car; he was soon after brought in contact with the telegraph pole and injured.

The jury were fully instructed that the plaintiff could not recover unless he showed that he was in the exercise of ordinary care for his own safety when the injury occurred. Whether the plaintiff, in getting upon the horse-car while it was in motion, was or was not in the exercise of due care, was a matter for the jury.

It may be true that the appellant was obliged to move its track to the east in order to make the contemplated improvement; but it was a question for the jury to determine whether too much space was left in the middle of the street for those putting in the cable, and too little space for the passage of the cars on which the public traveled, or whether the contrary was the fact. It cannot be assumed that danger of collision with the pole could be always avoided because the company would stop at the further crossing when requested. The proximity of the track to the pole may have been a menace to persons on the car, or to persons forced by the crowded condition of the seats or otherwise to stand upon the platform or running-board.

The evidence tended to show that there was posted in the cars of the company the following rule: "Passengers will not be allowed to get on or off this car while in

motion." The conductor was standing on the platform, and was looking at plaintiff before and after he got upon the car, and shouted to him to "look out" just before he was struck by the pole. He did not warn the plaintiff not to get upon the car while it was in motion, but suffered him to step upon the running-board without objection. It was a fair question for the jury whether the plaintiff was not invited to board the car. But we are not prepared to hold that a party is a trespasser after he gets on a horse-car, even though no fare has been collected of him before he meets with an injury, simply because he has violated a rule of the company as to his mode of getting aboard. The jury were instructed that the burden of proof was upon the plaintiff, and that he must prove his case, as alleged in the declaration, by a preponderance of evidence. The judgment of the appellate court is affirmed.

(Supreme Court of Illinois. North Chicago Street R. Co. v. Williams. 140 Illinois Reports 275.)

Street Railway Passenger—Injury by Collision with Truck on Crossing Street—Right-of-Way of Street-Car.

While plaintiff was a passenger in one of the cars of the defendant corporation, she was injured in a collision between the car and a truck of the other defendant, and she brought this action to recover damages for her injuries, alleging that they were caused by the concurring negligence of both defendants. A careful scrutiny of the evidence leaves no doubt that it fairly tended to show concurring negligence of both defendants, and the verdict of the jury therefore concludes us upon this point.

The council for the railroad company, in a variety of forms, requested the Court to charge that the railroad company, with its car crossing the street, had the right of way, and the paramount and superior right in the street, which the driver of the truck was bound to respect; and the Court refused so to charge. The rule invoked by these requests has its application where the tracks of street railways are laid in the streets; as the cars must run upon the tracks and cannot turn out for other vehicles, they must have the preference. But a railway crossing a street stands upon a different footing. The car has the right to cross, and must cross, the street, and the vehicle has the right to cross, and must cross, the railroad track. Neither has a superior right to the other. The right of each must be exercised with due regard to the right of the other, and in a reasonable and careful manner.

(New York Court of Appeals. O'Neill vs. Dry Dock, East Broadway & Battery R. Co. 52 American & English Railroad Cases 573.)

Street Railway—Charter Rights—Indefinite Grant.

A special charter of a street railway company, empowering it to commence at a certain street corner and

construct its tracks eastwardly and westwardly through such street, or any other streets in the borough, with the right to construct branches to its main track through any streets of the borough, does not give it the right to occupy a thoroughfare running north and south, in so far as the right to construct its main track is concerned; and the provision as to branches is so indefinite that new tracks cannot be constructed thereunder after the expiration of twenty-eight years, and after the village has become a city and the street has been granted to another company.

(Supreme Court of Pennsylvania. Junction Passenger Railroad Company vs. Williamsport Passenger Railroad Company. 32 W. N. C. 152.)

Child Trespassing upon Street Car—Injury by Being Pushed Off by Driver—Liability of the Company.

A street railway company is liable for injuries to a child between eleven and twelve years of age, who jumps upon the front platform of a slowly moving car, the injuries resulting from the driver striking her upon the hands and violently thrusting her off the step, so that she falls under the car and is run over, although she is a trespasser in getting upon the car.

(Supreme Court of Pennsylvania. Barre vs. Reading City Passenger Railroad Company. 26 Atlantic Reporter 99.)

(NOTE—See the case of Bess vs. Chesapeake & Ohio R. Co., West Virginia, 53 American & English Railroad Cases 64, where it is decided that to charge a railroad company for the wilful wrong of an employe in forcing a boy from a freight train while in motion, whereby he is injured, it must appear that the act was in the course of the employe's business, and within the scope of his authority; the boy being a trespasser and not a passenger.—ED.)

Eminent Domain—Condemnation of Leased Property.

A tenant's liability for rent is not affected by condemnation of part of the leased premises. But where the estate of both landlord and tenant in the entire premises is extinguished by condemnation, the obligation to pay rent ceases.

In a proceeding to condemn leased land, on which the tenant has made improvements under a lease providing that on its expiration the improvements shall belong to the landlord, the measure of tenant's compensation is the present value of the leasehold estate, subject to the rent, without including the value of such improvements.

(Supreme Court of Illinois. Corrigan vs. City of Chicago. 4 Chicago Law Journal 328.)

Person Riding on Crowded Car—Standing on Platform—Contributory Negligence.

There is evidence that when plaintiff boarded the car, every seat and the aisle were occupied; that the rear platform was also fully occupied, and that there were several people on the front platform. Plaintiff, finding he could not get on the rear, went to the front platform. From this position, it appeared to him that there was no available space on the inside. If the jury found the facts in line with these tendencies of the testimony, they would have been justified in finding further that the plaintiff exercised due diligence and caution in ascertaining the situation, and hence had a right to act upon the matters

which such diligence and caution disclosed, whether they were the real facts or not. It follows that, assuming proper circumspection to have been observed by plaintiff, evidence as to whether the car presented the appearance of being entirely full, was pertinent and properly received, and the charge requested for plaintiff, which authorized the jury to find plaintiff free from negligence in taking a position on the platform, if there was a reasonable necessity, real or apparent, for his doing so, correctly stated the law.

(Supreme Court of Alabama. Highland Avenue & Belt Railroad Company vs. Donovan. 52 American & English Railroad Cases 568.)

Attempting to Board Moving Car—Injury by Running Against Passenger Standing on Car Step.

The defendant's theory was that while the car was in motion, at a place where, by the rules of the defendant company, the driver had no right to stop it, the plaintiff rushed from the sidewalk towards the car; that the driver called out to her not to come near the car; that she paid no attention to the warning, but attempted to seize the forward part of the car with her hand; that a passenger who was standing on the front platform, stepped onto the step of the car and put out his arm to prevent the plaintiff from seizing the car; that she ran against his arm, and was thrown down, and did not touch the car at all. Under the court's instructions, which were properly given, the jury must have found that the defendant's theory of the accident was correct; and, if so, the plaintiff was not entitled to recover.

(Supreme Court of Massachusetts. Gallagher vs. West End Street Railroad Company. 156 Massachusetts Reports 157.)

A CROWBAR ON THE INTRAMURAL.

IT is a constant question as to how the average laborer will act when on the elevated structure of the Intramural Railway, and it has been sarcastically remarked that for each workman there should be two guards, to keep him from carelessly placing iron tools across the feeder and track rails. The other day, however, one of the sons of toil managed to evade the attention of his keepers long enough to lay a crowbar across the rails. Fireworks, of course, followed, and the station circuit breakers went out with a bang. It was with difficulty that the one who was responsible for the display was kept from jumping off the structure when he saw the big green flames leap up before him. All was quiet in so small a fraction of a second, however, that it was not long before peace was restored and trains were running as usual.

COMMISSIONER SPENCER, of the New York rapid transit commission, resigns his office at last. Mayor Gilroy promptly accepted Mr. Spencer's reasons and appointed David F. Porter, of Harlem, to fill the place left vacant. We congratulate Mr. Spencer and commiserate Mr. Porter.

A USE FOR OLD MOTORS.

WHAT to do with the old double reduction motors of days gone by is a question that has been the cause of much worry both on the part of the street railway superintendent and the manufacturer of electrical machinery. Nearly all the roads equipped previous to 1891 have found themselves with a lot of antiquated motors costing thousands of dollars at the time the road was built, but worth little more than scrap metal now, as far as marketable qualities go. The railway departments of our large companies are constantly receiving letters from roads that want to trade their old double reduction motor equipments for the latest waterproof single reductions.

In some cases the manufacturers have done it in order to keep the trade of the road. In others the dose has been a little too big to swallow, as manufacturing companies can make very little use of second hand machinery. In a few cases, as at Minneapolis, the armatures of these old motors have been re-designed and wound in a manner to make them more substantial, so that they are still doing good work.

The best way to utilize them, however, is the method adopted by Superintendent Wallace D. Dickinson, of the Great Falls, Montana, Street Railway Company. The plan is to use them for supplying stationary power. Mr. Dickinson has several of these in operation for different purposes. At one place it was desired to run a pump for keeping clear an excavation. Instead of going to the trouble and expense of putting up a steam plant the parties doing the work decided to rent power from the railway. One of the old Thomson-Houston F-30, double reduction motors was set up, the gearing taken out and a pulley put on in place of the pinion on the armature shaft. It was then belted direct to the pump. As the pumping load is constant the series winding of the motor was no disadvantage. About 12-horse-power is required by the pump. This motor has been running constantly with but a few minutes rest during the twenty-four hours. Having been built for the heavy trials of street railway service these motors should have every prospect for long lives in the less exacting stationary service. At another place one of these veterans is at work driving a rock crusher. As the load varies so greatly the fields of this machine were re-wound to make it a shunt motor in order to keep the speed constant. Another shunt machine is furnishing power to a small foundry. The speed of these motors is about 1200 revolutions per minute. Sheds are built for the protection of those doing out-of-door service. The extreme simplicity of the work of installing them and the small amount of attention they require commend them to all for use in such classes of work. The one running the 10-horse-power rock crusher is in operation ten hours a day and the company receives for its service \$100 a month, or about ten dollars a horse-power. While this may seem high to eastern minds it is perhaps sufficient to say that the contractor using the rock crusher says that

he will never go back to steam again. At several other places throughout the country these motors are doing stationary work.

In connection with the Great Falls plant it may be of interest to note that negotiations are pending for supplying power from the railway circuit to several large concerns, one of which will require a 70-horse-power motor. The plant is run from a water power and the company has already been able to underbid steam in several instances. There is even some prospect that this water power plant will in the near future furnish electric power for coal mining in the vicinity, thereby beating coal at its own game.

The cleanliness of water power is one of the best arguments in its favor. The labor necessary to keep the machinery clean is said to be not one-fourth what it was with steam, and cleanliness is one of the most important features in a successful dynamo plant. The country in the vicinity of Great Falls promises to become before many years one of the electrician's ideal communities, where heat, light and power are furnished by electricity generated at one central station.

AN L OF A SITUATION.

The New York rapid transit commission,
Gave streets to Manhattan to hold,
But their countenance fell
When Manhat' said, "Oh, L,
These streets here are just good as Gould"

A RAILWAY IN A DAY.

VARIOUS constructing engineers at sundry times and in divers places have achieved wonderful feats in track laying. But it has been accomplished with an army of trained men, which every steam road has constantly in its employ. The more humble but no less important street railway, with its small standing force of experienced trackmen often scores a record not to be despised.

The most recent occurred a few days since at Muncie, Indiana.

The Citizens Street Railway had given its promise that cars should be running to its ball grounds on the opening day. The material, however, was lost in transit and twelve days late in arrival, being received late Sunday night, and the road must be in operation at 1 o'clock Tuesday afternoon. At 4 a. m., Monday, the work of unloading the rails began; one hour later the first bridge, 248 feet in length, had been crossed, and 1,000 feet of track laid. The work was continued without a moments intermission until Tuesday noon. In this time, 32 hours, all the iron for 4,800 feet of track had been unloaded from the cars, hauled over a mile from the depot to the street, spiked down, lined, surfaced and put in service; and has been constantly in use ever since. The men worked almost continuously, some without any rest, and so strong

was the enthusiasm a number actually fell senseless from exhaustion and had to be carried to their homes. H. C. Gotshall, general manager of the Citizens, personally superintended the work during the entire construction and undoubtedly was possessed of more of that tired feeling that day than any other street railway manager in the country, although proud of the splendid record. The only better one of which we know was that made by C. E. Loss, the railway contractor of Chicago, who successfully executed a contract to grade and lay an even mile in 24 hours, at Robey, Indiana.

SIMPLE SYSTEM OF ACCOUNTS SUITED TO SMALL ROADS.

IN May we published what is undoubtedly the most complete distribution of accounts yet compiled for a large road operating the three systems of cable, electricity and horse. Much contained therein is useful as a guide to small roads which are revising their account system; and the following concise yet complete forms as used on the rapid transit lines of San Antonio, Texas, will be specially welcome to accountants of the average sized road.

For a conductor's trip sheet, the following has been found to meet every requirement:

CONDUCTOR'S TRIP REPORT.

The San Antonio Rapid Transit Street R. R. Co.

Date.....July 15,.....1893.

Car No.1..... Run.....(Day or Night)

Conductor.....Jones..... Badge No.....12.....

On.....6 A. M..... Off.....12 M.....

Motorman.....Brown..... Badge No.....5.....

On.....6 A. M..... Off.....12 M.....

.....Smith..... Badge No.....2.....

On.....12 M..... Off..... 6 P. M.....

TRIP.	Starting Time.	Regis- tr Fig'rs.	Total Pas'sgrs	CERTIFIED BY	Sch'l Tkts.	Pasn Tkts.	Cash Fares.
		1,000					
1	Dn 6 A. M.	1,050	50	10	2	38
	Up 6:30	1,075	25	3	2	20
2	Dn 7:00	1,100	25	3	2	20
	Up 7:30	1,140	40	5		35
3	Dn 8:00	1,200	60	15	1	44
	Up 8:30	1,230	30		2	28
4	Dn 9:00	1,250	20	2		18
	Up 9:30	1,280	30			30
5	Dn 10:00	1,300	20	2		18
	Up 10:30	1,340	40		1	9
6	Dn 11:00	1,325	15			15
	Up 11:30	1,340	15	1		14
7	Dn 12:00	1,350	10	To Hall Cond'r			10
	Up 1:30	1,370	20	Frm Hall Cond'r			
8	Dn 1:00	1,400	30	6	1	23
	Up 1:30	1,418	18	3		15
9	Dn 2:00	1,440	22			22
	Up 2:30	1,450	10			10
10	Dn 3:00	1,470	20	2		18
	Up 3:30	1,475	5			5
11	Dn 4:00	1,483	8			8
	Up 4:30	1,490	7			7
12	Dn 5:00	1,495	5	3		2
	Up 5:30	1,500	5			5
			480	TOTALS.....	55	11	414

As will be noticed, the register reads 1,000 when car was taken out at 6 a. m., there being a change in conductors at 1 p. m. The column entitled "Total Passengers" must always agree with the three columns at right entitled "School Tickets," "Passenger Tickets," and "Cash Fares." The column "certified by" is for the use of the relieving conductor as to the register reading.

DISTRIBUTION TO LEDGER ACCOUNTS

is accomplished under eight heads for operating expenses, and one for income, as follows:—

- 1—General ex- } Manager, superintendent, secretary, etc., taxes, insurance, interest, exchange and discount, advertising, legal expenses, etc., etc.
- 2.—Office ex- } Office clerks' salaries, office supplies, office rent, office sundries.
- 3—M a i n t e- } Power plant supplies, power plant re- nance of pow- } pairs, superintendent's office. er plant.
- 1—Cost of } Coal, oil and waste, engineers and fire- power. } mens' wages, sundry materials and help necessary to the running of engine only.
- 5—M a i n t e- } Road-bed and track supplies, road-bed nance of road- } and track repairs, road-bed and bed and track. } track employes.
- 6—M a i n t e- } Line supplies, line repairs, line em- nance of line. } ployes. (Over head.)
- 7—M a i n t e- } Car and motor supplies, car and motor nance of cars } repairs, car and motor employes. and motors.
- 8—Transporta- } Motormens' wages, conductors' wages, tion expense. } supplies (conductor's trip reports, etc.)

As frequently stated in these columns, the loose system, or rather absence of system, which once characterized the operation of many horse roads, is not permissible under the new order of affairs, and as will be seen from the excellent system devised by Mr. Johnston, a systematic and complete record involves no difficulties, while it is essential to even the smallest road.

This system of distribution, which is proving entirely satisfactory, is the compilation of C. A. Johnston, the cashier of the company, and to whom we are indebted for permission to give the same to the REVIEW readers.

As will be noted, the table on opposite page is a monthly statement of earnings and expenses, with comparative statement of the same month of the preceding year. It is sufficiently in detail to afford all information usually desired by directors and stockholders. The first division is capable of taking into account every item of expense on an electric road, and by a proper system of book-keeping this classification can readily be made. The middle section explains itself, and can be extended as desired, as can also the third section.

Report of The San Antonio Rapid Transit Street R. R. Co.
For Month of.....189..

A HIGH KICKER.

JUST how the electric current affects the propulsion of a car is a constant source of wonder and amaze to the average citizen. Jay Wiley, now of the Intramural, tells a good story apropos of this lay ignorance and taking another man's word for it we will tell it as it was told us by the veracious interlocutor.

It was when Wiley was on the coast, in fact, at San Francisco, setting up motors on the Metropolitan line, and much curiosity was aroused as to how the current was transferred into motion.

Wiley was out with a car one day and by some mischance forgot to throw the switch before running his car over it. The car consequently ran off on the wrong track but the trolley wheel kept the wire. Slowing down properly, Wiley quietly reversed and ran the car back to the main track to get another trial at the switch. Before turning on the juice, however his attention was attracted by the advent of a fat old gentleman who came running up very much excited and considerably out of breath.

"Say, young man," puffed the old gentleman, mopping a shining bald head with his handkerchief, "Say, hold on a minute, I want to talk to you. You see I've got a theory in regard to electric cars and I want to know if it's right. Now, just be real honest and tell me if it aint right, but I allow it is. 'Mandy and the girls say its the only one that they can understand the thing by."

"Now my theory is just this: That there pole is slanted some and when the current comes sizzing down the wire it strikes the pole kind of slantwise and pushes the car along, but what knocks me out is just this, that you pulled the durned thing back just now without doing anything that I could see to the pole."

Wiley assured his interrogator that by "twisting the handle" he could reverse the machinery at the power house and make the current "kick" the other way and that the theory advanced was the one understood by all first class scientists including 'Mandy and the girls.

ON Derby day the facilities of the south side rapid transit lines proved equal to the double emergency of the races and the World's Fair. Ten extra trains were placed on the L and the cable ran at reduced headway.

THE Mt. Auburn Cable Railway, Cincinnati, will construct a new down town loop on Fourth, Walnut and Fifth streets.

DIVISIONS.	YEAR 1893.		YEAR 1892.	
	Expen- ditures.	Receipts	Expen- ditures.	Receipts.
General expense.....				
Office expense.....				
Maintenance of power plant.....				
Cost of power.....				
Maintenance of road, bed and track.....				
Maintenance of line.....				
Maintenance of cars and motors.....				
Transportation expense.....				
Total operating expense.....				
Traffic receipts {				
Conductor's returns.....				
Sale of tickets.....				
Miscellaneous sources.....				
Surplus.....				
Deficit.....				
Totals.....				

	YEAR 1893.	YEAR 1892.
Total car mileage.....		
Cost per car mile run.....		
Receipts per car mile run.....		
Total number of passengers carried.....		
Cost per passenger carried.....		
Receipts per passenger carried.....		
Cost of coal per car mile run.....		
Cost of coal per ton delivered at power house.....		
Kind of coal used.....		
Average coal consumption per day.....		
Engines used and capacity of same.....		
Boilers used and capacity of same.....		
Dynamos used and capacity of same.....		
System in use.....		
Equipment.....		
Miles of track.....		
Maximum grade.....		
Bonded indebtedness.....		
Annual interest on bonds.....		

No. of Employees.	SCHEDULE OF WAGES.	Per Month.
.....	General Manager.....	
.....	Secretary.....	
.....	Cashier.....	
.....	Book-keeper.....	
.....	Clerks.....	
.....	Superintendent.....	
.....	Engineers.....	
.....	Firemen.....	
.....	Motormen..... rate per hour.....	
.....	Conductors..... rate per hour.....	
.....	Shedmen.....	
.....	Linemen.....	
.....	Trackmen.....	
.....	Car Starters.....	
.....	Totals.....	

Date.....189..

Signature.....

A PROMINENT knight of labor agitator has been in Minneapolis recently which, coupled with the fact of a number of street railway employes' meetings, leads the Minneapolis press to believe that the employes are about to form a union.

SOME DES MOINES APPLIANCES.

THE flat car shown in our engraving is one that has been in use on the Des Moines Street Railroad for some time past. It is 34 feet long; 7 feet wide. All kinds of construction material are hauled on it; its length making it specially convenient for poles and rails. Each truck is supplied with a 15-horse-power Westinghouse single reduction motor. Very frequently this car is employed in hauling one or two construction trailers in addition to its own load. As will be seen, the trolley

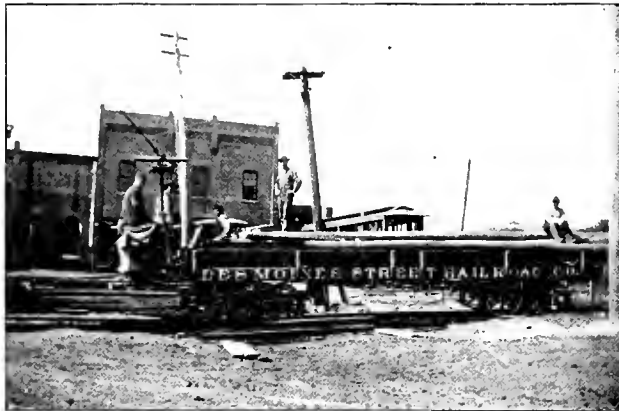

ELECTRIC CONSTRUCTION CAR.

stand, controller and motorman's platform are at one end, it not being necessary to have the motorman always at the front end on a flat car.

TROLLEYS.

The trolleys universally adopted by this road are somewhat out of the ordinary run of this kind of apparatus in several respects. The most important feature is that the wheel is allowed to turn with a slight swivel motion on the end of the trolley pole. It may be likened in form and principle to a chair caster. This swivel motion allows the wheel to run straight on the wire in spite of crooked poles and discrepancies between the direction of the trolley wire and railway track. That flange friction is almost completely eliminated is demonstrated by the way in which the wheel wears down, which is in striking contrast to the ordinary trolley. Instead of wearing through the flange of the wheel a deep groove is worn in the middle, of but

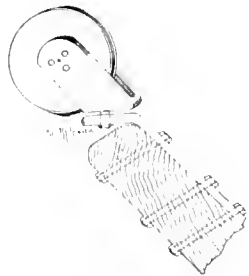

DES MOINES TROLLEY WHEEL.

slightly greater diameter than the trolley wire. Although of very rough and simple construction, being made of plain wrought iron, this swivel trolley has been doing excellent work. The swivel motion allowed is not sufficient to let the wheel swing around far enough so that there is difficulty in putting it on the wire. The wheel journals are made of hollow steel tubing held in place by three bolts passing through the inside. This

tube is filled with felt and the felt is filled with oil which latter oozes out through the holes in the tube and oils the wheel.

LIGHTNING ARRESTERS.

Like every other road of any age the Des Moines Street Railroad has had considerable sorrowful experience with lightning. For two years past, however, they have had no generator burn out from this cause. The arresters used are of the simplest form imaginable. Two carbon points, one connected with the line and the other with the ground, are placed about one-eighth inch apart. If an arc forms after a lightning discharge it throws the circuit breaker at the station, and as soon as they are closed by the attendant who is on the look out for such things during thunder storms, the traffic goes on as usual. Very often, however, it has been found that the arc breaks itself without disturbing the circuit breakers. Although a rather crude arrangement and requiring some trouble to operate, it has the advantage of being simple. These arresters are placed about every mile along the lines.

W. R. McLean, the master mechanic, who is an adept at designing devices and making over machinery to meet the special wants of the plant, is responsible for the features here described, as well as for many other minor details in equipment which help greatly in the successful operation of the railway.

CLEVELAND'S CABLE CONSOLIDATES.

THE recent merger of the Cleveland City Cable Company and the Woodland Avenue & West Side interests, as the Cleveland City Railway Company, has excited no little attention in the street railway financial centers. The Woodland has nine directors, namely: M. A. Hanna, C. F. Emery, D. P. Eells, H. P. Eells, J. F. Card, R. R. Rhodes, J. H. Wade, Geo. H. Warrington, and C. A. Otis. The Cable Company's five directors are: F. De H. Robison, Stanley Robison, John J. Shipherd, Chas. Hathaway, and George Holt. The new company chooses nine of the above fourteen as their board.

The Woodland road went into the consolidation on a basis of \$2,000,000, while the Cable was rated at \$5,000,000. The Woodland share is all stock, common and preferred, and it is claimed \$1,800,000 has been paid in. The merger is based on a combined capital of \$7,000,000. The Cable Company is credited on good authority with \$4,000,000 stocks and \$1,884,000 in bonds. The 57½ per cent given the Woodland in the deed is upon this basis.

The St. Clair street electric equipment is now on the grounds, and supplies bought to bring it to completion.

STERLING SUPPLY COMPANY, formerly the Sterling Car Heating & Lighting Company, 47 Cedar street, New York, have great success with their new register which has been adopted by the Broadway road for their new cars. The register is a beauty.

THE STREET RAILWAY IN SAN DIEGO.

A ROAD with no stockholders to answer to is a rare avis, but the electric railway of San Diego, California, is one such, being the absolute property of A. B. Spreckles, a son of Claus Spreckles, the sugar king. The Spreckles interests in and around the city include a resort hotel and the island on which it is built, big wharves and warehouses, and other properties, hence it was natural a street railway should be built to foster all these.

The purchase for \$115,000 of the old horse lines, on January 30, 1892, furnished the basis of operations, and the change to electricity immediately commenced, and the road has already been running satisfactorily for several months. The power house reveals several features of interest, and is a neat brick structure 62 by 105 feet, with a boiler house adjoining 58 by 61 feet, from which rises a stack 125 feet high and 19 by 19 feet at base. The car house is 106 by 134 feet. These buildings, while connected, are separated by fire walls and have individual roofs of corrugated iron. The car house con-

and 7 feet long, covered on top in such a way as to exclude weeds and other float. The fire pump in the station also draws from this supply. The pipe itself is supported on steel straps, which suspend from rails driven solidly into the bottom.

The ten cars, two of which are double deckers, are each equipped with two 15-horse-power single reduction T-H. motors.

The tracks aggregate twelve miles, and were furnished and laid by F. M. French for \$50,000. This included the erection of the poles. Cars from any line can be switched to run through on every other line. The electrical supplies, machinery and installation cost \$45,000, and the entire road is said to have cost \$400,000. Its officers are A. B. Spreckles, president; E. S. Babcock, vice-president; and Jas. A. Flint, secretary, treasurer and general manager. Upon the two last named rested the responsibility of superintending the change.

In this they were assisted by H. E. Brett, engineer, who drew the plans; C. W. Horts, who constructed the buildings, and A. C. Jewett and F. V. Pinkham, electricians. Mr. Pinkham remains as electrical superintend-

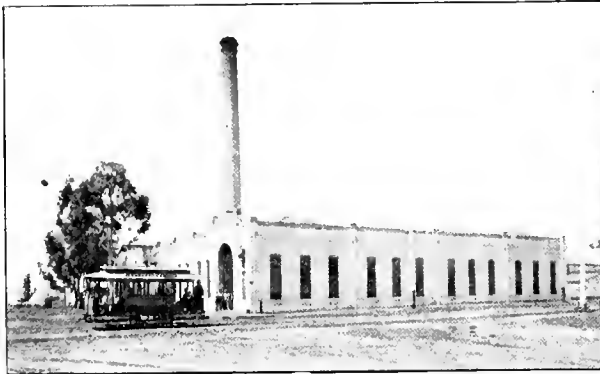

POWER HOUSE, SAN DIEGO.

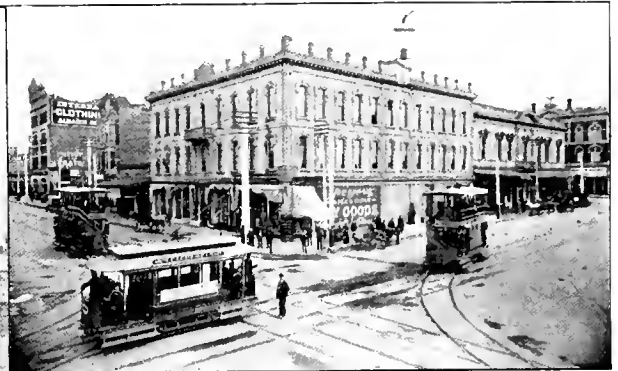

FIFTH AND H STREETS, SAN DIEGO.

tains eight tracks, capable of storing twenty-two cars; an inspection pit 35 by 60 feet; and convenient repair and paint shops. The buildings and stack cost \$20,000.

The station equipment includes two T-H. generators of 120-horse-power each; one 300-horse-power compound condensing Corliss, 16 and 30 by 42 inches; and three Babcock & Wilcox boilers, of latest type, of 105-horse-power each and connected to economizer in smoke conduit. Two of these boilers are, however, sufficient to do all the work. Stillwell & Bierce heaters and purifiers are also found in excellent service and giving good satisfaction. The fly wheel is 18 feet diameter, with 32-inch face, weighs 19 tons and drives a 30-inch belt to the line shafting. As the station is placed within 400 feet of the bay, condensing water is inexhaustible, and is drawn through iron piping 8 inches in diameter and 945 feet long.

At high tide the intake is in 13 feet of water. This intake is built of T rails, driven well into the bottom and spaced at intervals of 18 inches to form a circle. Within this railing is a network of copper panels 3½ feet wide

ent. The road has quickened business, extended the limit of desirable residence property, and is a credit to the men who have made it possible.

LAMONT AND THE RAILWAY.

SECRETARY DANIEL LAMONT really ought to have more consideration for his brethren than to do the very ungracious deed reported of him in vetoing the electric railway across the field at Gettysburg.

The plan was undertaken by men who wished to make money out of it, of course. That is the reason men put money into such things. Because people wanted it. That's the reason men can make money out of such things. It's much more romantic to cross the ocean in a Norseman's vessel but no sensible man does it. So it may not be as truly historical to cross the field of Gettysburg in an electric car but it would be much easier and quicker to do so.

CHARLES CLEMINSHAW.

THE high state of efficiency which has been attained in the electrical operation of street railways, and the rapid extension in that method of operation, is due in a very large measure to the intelligence, good judgment and energy of practical railroad managers. With persistent determination to find what they want, and to accept nothing else, they have carefully investigated and tested the discoveries and inventions of electrical and mechanical engineers by the only practical test, that of successful use.

The march of scientific discovery and the inventive genius of engineers have thus been stimulated and energized by these practical men, and new inventions have been produced in great numbers. Many of them have been weighed in the balance and found wanting, but some have proved to be of great practical value, and many supposed impossible barriers have been surmounted, difficult problems have been solved, and greatly improved methods and machinery are now at the service of the public.

The matter of power and appliances for the operation of a railroad, while an important factor in railroad management, is not the principal factor. Many other things are necessary to a successful administration of its affairs. The selection of competent and faithful assistants, the maintenance of thorough discipline in the employes, together with such treatment as will attach them to the service of the company; a proper adjustment of facilities to the needs of the business; regularity and certainty of operation in all kinds of weather; a due regard to the safety, comfort and convenience of passengers; the protection of the company from the claims of blackmail sharks (the bane of all railroad corporations), as well as from unjust and illegal exactions on the part of the public authorities; all these matters require constant care and watchfulness on the part of the street railroad manager if prosperity is looked for or expected.

Under the management of its president, Charles Cleminshaw, the Troy & Lansingburgh Railroad Company was one of the earliest to adopt electrical operation for its cars. During its operation by horses the road had been very successful and its business was constantly increasing; but Mr. Cleminshaw foresaw that it would be impossible to long meet the increasing demands of business, and the necessity for decreasing the cost of operation by this method, to say nothing of great advantages of more rapid transit.

For several years he kept a close watch on all proposed improvements in the line of street railway operation, and perceiving the merits of the electric system, he gave it a careful and thorough investigation. In this he was assisted by Otis G. Clark, a director and one of the executive committee of the company, a man of sound judgment and ripe experience in business and manufacture. Together they traveled over the length and breadth of the land, where anything of probable or possible value might be seen. As a result the Troy &

Lansingburgh road was equipped for the trolley system and put in operation in 1889. The system was rapidly extended to the lines leased by that company, new franchises were secured and extensions built. The Troy & Albia Railroad was also purchased and electrically equipped and operated. In 1892 a new company was formed, consisting of the Troy & Lansingburgh Street Railway Company and its leased roads and the Troy & Albia Company, with important extensions, under the title of the Troy City Railway Company. This company now operates 24 miles by electricity and 4 miles by horses (soon to be changed to electric system), and has several miles under construction.

Taking an interest in the operation of railroads generally, Mr. Cleminshaw was one of the original organizers of the American Street Railway Association, and is now one of its executive committee. He was also one of the earliest presidents of the New York State Association. His large experience as a banker, merchant and manufacturer, and his untiring energy, has been devoted to the interests of his company and the development of its business.

During his more than twenty years connection with the management of its roads and affairs, he has exercised the most constant and faithful supervision of all its business, not omitting the smallest details required to make it what it is—one of the best railways in the country.

METAL TIES IN MEXICO.

THERE are now 150 miles of track in Mexico laid on steel sleepers. They cost one dollar each, are six feet long, and weigh 90 pounds. Oak ties there cost 61 cents, and pine ties 42 cents. Another form of steel tie being used weighs 124 pounds, and is 8 feet 3 inches long.

CONCORD'S ROAD OPENED.

THE invitation of Superintendent Chamberlain, of the Concord Street Railway, to the opening of the road, was accepted June 16, by about fifty of the most prominent citizens. A spacious summer pavilion and a beautiful pleasure route will make the road very popular this summer.

WHY PAINT BLISTERS.

IN the Painter's Magazine C. E. Copp claims that unless caused by excessive heat the blistering of paint is occasioned either by sap or moisture in the wood. The difficulty from sap is the result of not using well seasoned wood. Painting in early morning before the dew has time to dry is another cause of difficulty. If a paint is properly dried on hard wood and then blisters, there is sure to be moisture coming in from beneath the paint. In other words a water logged wood is sure to blister.

Street Railway Review



CHARLES CLEMINSHAW,
President Troy City Railway, Troy, N. Y.

McGUIRE BICYCLE TRUCK.

THE adjustable traction bicycle truck is a novelty recently placed on the market by the McGuire Manufacturing Company. The principle of this truck is designed to secure, as its name implies, the automatic adjustment of the truck so as to secure the maximum results for the minimum of energy. To do this the truck is constructed with large driving wheels and small

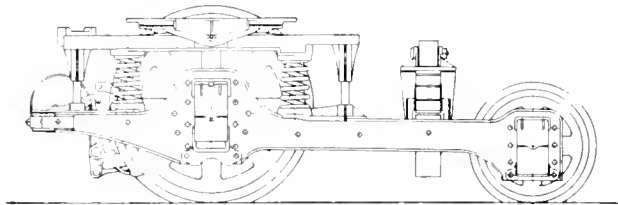

SIDE VIEW BICYCLE TRUCK.

auxilliary wheels, which give it the appearance of the old fashioned bicycle when viewed from the side. The car body is pivoted immediately over the center of the axle of the large wheel on which the motor is carried and the power is applied, and by means of a shifting cam and half elliptic spring, can be adjusted to carry any part of

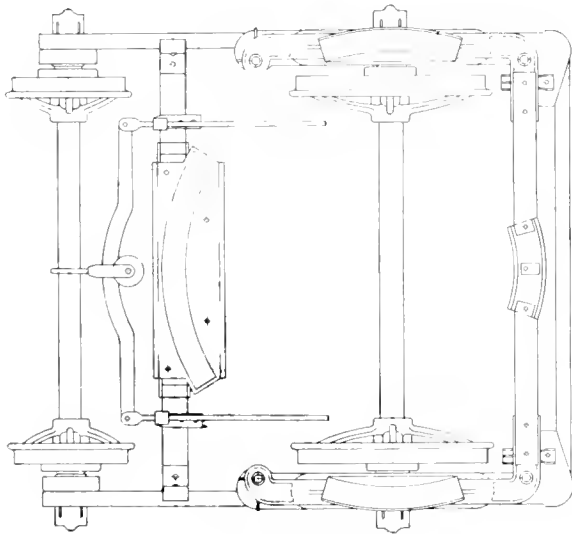

PLAN VIEW BICYCLE TRUCK.

the load on the driving axle up to 100 per cent. The anti-friction roller on the top of the half elliptic spring fitting into a recess in the center of this cam is intended to secure a perfect alignment of the trucks on a straight track. When entering a curve, any amount of the load up to 50 per cent is transferred to the idle axle by the same device, and kept in that position until clear of the curve. This is done to insure perfection in curving. As the small wheels make all the sweep and are low enough to pass under the step at the side, the car body is carried as low as on a single truck, a feature very desirable and one which will very materially lessen the number of objections to double trucks. The frame is made throughout of pressed steel, the brakes are of the rocker-shaft pattern, with double top and bottom rods and all holes are bushed. The journals are $3\frac{1}{4}$ inches in diameter by $6\frac{1}{2}$

inches long, making 26 square inches of bearing surface. The McGuire people have taken orders for quite a number of these trucks, among which were forty-four for the Denver Tramway Company. They also have a pair mounted under a skeleton frame in their exhibit at the World's Fair, where the entire mechanism can be seen and understood.

The McGuire Company have a letter from the Cicero

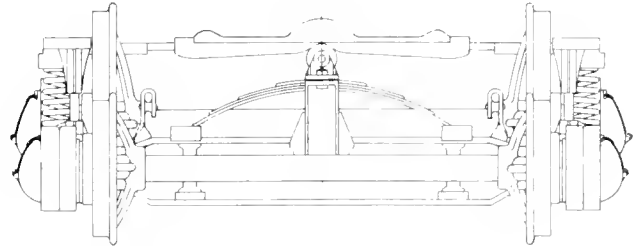

END VIEW BICYCLE TRUCK.

& Proviso Street Railway Company in which it is stated that the trucks have been in use during six months, including the past winter, and when snow and ice was on the ground was the only form of double truck in use by them that could be depended on.

CUTTER'S "BOULEVARD" STREETHOOD.

A GOOD share of the railway plants which undertake incandescent lighting, are interested in the use of outdoor reflectors for these, and will welcome the handsome form now put out under the title "Cutter's Boulevard Streethood." This was designed to meet the demand for a strictly first-class street fixture, which would be more ornamental than the common or

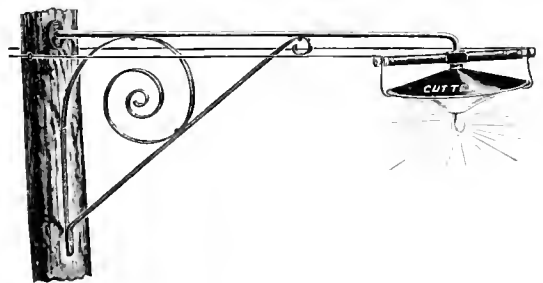

CUTTER'S BOULEVARD STREETHOOD.

goose-neck form. The hood proper has all the good features which have made Cutter's streethoods so popular throughout the land, and adds to these the beauty and strength of the special bracket arm. With this fixture the lamps can easily be supported five or six feet from the pole, so as to give good effects on thickly shaded streets. The maker, George Cutter, of Chicago, has already supplied large orders of them to western cities, and reports very satisfactory comments from users.

A WEALTHY widow of Aurora will marry a Chicago street car conductor named Henderson. The lady is said to be strong minded as well as wealthy and doesn't care what the neighbors say.

"THE TOWER," DAVENPORT AND ROCK
ISLAND RAILWAY.

PLEASURE resorts owned by street railway companies are becoming more numerous each year, but in carrying out the policy advocated by the REVIEW, few roads have had a more favorable natural location to convert into a resort than the Davenport & Rock Island Railway. Long before a street railroad had ever been thought of, the people from the three cities of Davenport, Moline and Rock Island were in the habit of

recently built at the highest point on the bluff. The first floor is fitted up for purposes of rest and refreshment. The second floor is a dancing hall. The lower left hand view is taken from the Rock River, showing the Inn at the top of the bluff and the toboggan slide at the left. This toboggan slide is a double track railroad, running from the top of the bluff to the water. The boats or toboggans are amphibious, running equally well on land or water. They roll down the track at a hair lifting gait and are shot about half way across the river. The captain, who was but a second before conductor, then steers

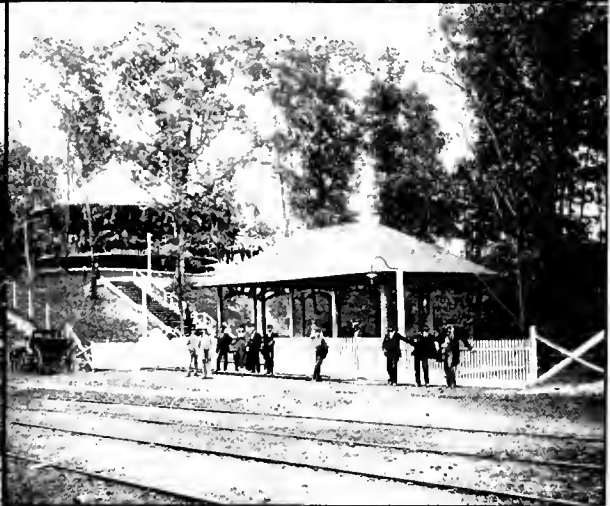
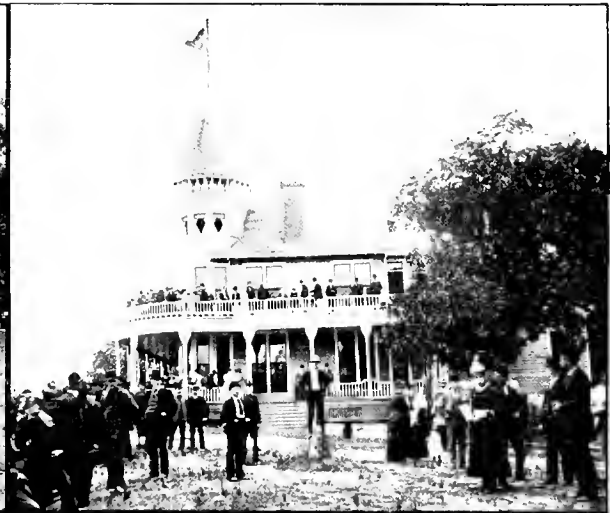

WAITING ROOM.
TOBOGGAN SLIDE.

THE INN,
THE PAVILION.

visiting the high bluff on the Rock River, south of Rock Island, known as Black Hawk's Watch Tower. That it was the favorite camping ground of this famous Sac chief is not to be wondered at. The view which is afforded of the country for miles around, and especially that of the beautiful Rock River, is well worth a trip of many miles. The visiting public is not wholly dependent on scenery for its enjoyment, however, for a considerate street railway company has fitted up a park of twenty acres with numerous attractions. The upper right hand corner of our engraving is a view of Black Hawk Inn.

his craft back to shore, and it is hauled up the grade by an old Sprague street car motor, attached through a friction clutch to a cable drum in a cabin at the top of the slide. This is said to be the only slide of the kind in the country, and has proved to be quite an attraction. Smaller pavilions, band stands, side shows, etc., are scattered around the park. Balloon ascensions and fireworks are frequent attractions. At one point a natural amphitheater is sometimes made use of for open air performances. The two remaining views are of the railway depot at the park, the upper one showing one of the cuts

that was made through the bluff. The park is about four miles from the down town loop in Rock Island, and the greater portion of the distance the road is run on a private right of way and maintained the same as a steam road.

Superintendent Henry Schnitger has general supervision of the grounds, along with his other duties. They are under the more immediate care of Assistant Superintendent J. G. Huntoon, who has charge of the Rock Island portion of the lines. Arrangements are made to encourage and facilitate excursions from outside points by railroad and steamer, and there is a special excursion agent for that purpose. The street railway is the only means of reaching the grounds, except carriage or on foot. Cars are run on ten minutes headway on ordinary days, and as many as the traffic and single track will bear on special occasions. Admission to the grounds is entirely free.

President Louderback has done much to bring the resort to its present state of loveliness and usefulness, and is a firm believer in created travel, as, indeed, results have shown he has good reason to be.

RAIL BONDING AT LACROSSE.

THE LaCrosse City Railway, in changing over to electricity, has been using a new type of bond, the design of Clement C. Smith, the constructing engineer. It is of No. 0 tinned soft drawn copper, turned at the ends at right angles through a small cast brass

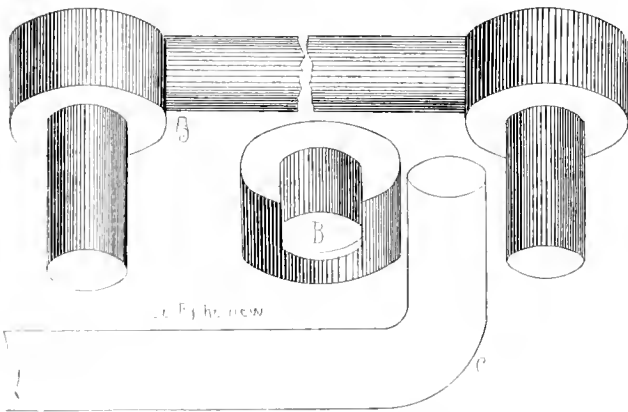

RAIL BONDING AT LA CROSSE.

A—Bond complete. B—Brass casting. C—Bond wire with casting removed.

ring having the same bore as the diameter of the wire. The wire and brass casting are then soldered with a sweat joint. When finished it looks very much like a rivet bond. It is put on the rail and riveted in the usual way, the cast brass ring serving as a shoulder. It makes, of course, a continuous bond, with no joints at the rivets. The rail is drilled with a $\frac{3}{16}$ drill, which makes a driving fit for the No. 0 bond, and in riveting, the soft copper packs solidly around the rail. The hole in the rail is slightly countersunk at the rivet end to help make a better contact and more solid joint. The bonds are made by the railway's own men. Our drawings show the bond

as it appears when finished, and also the brass casting, which has one side cut out to accommodate the wire as it turns at right angles. It may be called a compromise between the rivet bond, which is composed of three parts through which the current must pass (the bond wire and two rivets), and the bond now being introduced, which consists of one piece of copper wire having the shoulders for riveting formed on it by a machine process.

THE PIVOTAL BOSTON TROLLEY.

THIS is a recent trolley brought out by Albert & J. M. Anderson, of Boston. It possesses all the well known good qualities of the first Boston trolley but differs from the old type in making a side motion on a vertical pivot. The entire base pole and fork are of

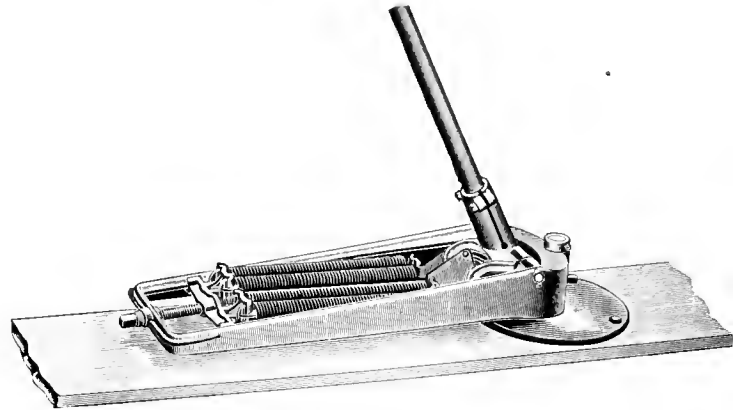

PIVOTAL BOSTON TROLLEY

steel, and the whole is light, strong and neat. The highest point on the base when the pole is laid down horizontally is but six inches above the car. An abundance of spring insures efficient action without danger of setting or breaking.

MR. YERKES' NEW RESIDENCE.

WORK has been commenced on the new residence of President Charles T. Yerkes, in New York City, and before many months the magnificent domicile will be ready for occupation. The house is situated at Fifth avenue and Sixty-first street and will probably cost \$1,500,000 before it is completed. It is to be four stories high, of light brown stone, with an elaborately carved main entrance approached by twelve steps hewn from solid blocks of brown stone.

The picture gallery, which will house the famous Yerkes' collection will be 150 feet long, with a glass roof.

The entire first floor of the mansion may be thrown into one room, for in place of the dividing wall there will be a row of pillars of Italian marble. Curtains will take the place of walls.

Electricity will play an important part in the furnishing of the mansion's decorations, one peculiarity of the electric lighting being that no-lamps or globes will be visible, except in the main parlor where a chandelier will be suspended.

TRACK DRAINAGE.

STREET railways in some localities have had trouble from the settling of their tracks below the level of the pavement. This excessive settling is generally due to poor drainage. When the road is made on a sand or gravel foundation no further drainage is needed than that provided by nature. On compact clay or other soils which are not self draining, it becomes necessary to drain the roadbed. When track is laid on a pretty steep grade, gravel ballast will answer fairly well, and allow the water to run away to the dip of the grade, where some provision can be made for it to escape. But where the grade is very light, Harry M. Gates, a civil engineer of Columbus, Ohio, suggests that a method be

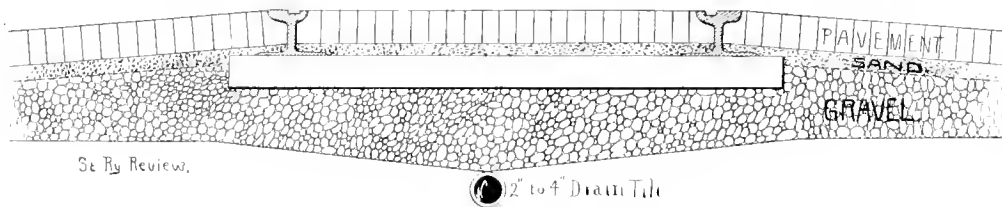

SINGLE TRACK DRAIN CONSTRUCTION.

used somewhat similar to that in use on some steam roads. The plan is to excavate a trench in which to place the ballast, the bottom of which trench is V shaped. At the lowest point in the trench a 2 to 4-inch tile drain is placed. The water then runs through the roadbed till it comes to the clay, which prevents its downward flow enough to direct it to the tile drain. It is easy to understand how water, if allowed to remain under the tracks, will soften the sub-soil, and allow the ballast to be beat into it, thus finally lowering the track. Some tracks laid

A UNIQUE AUXILLIARY ON GRADES.

ELECTRIC cars have for a long time successfully climbed grades which a few years ago were deemed unsurmountable barriers, but the ambitious trolley is constantly reaching out for still greater achievements, and has enlisted its brother, the cable, to help it over the hard places.

At first it was promised that the magnetic traction between rail and wheel would solve the problem, but that has not been put in practical use. At San Francisco, Portland and Seattle, counterbalancing weights to run in a conduit between the rails have proved of service, but it has remained for John B. Smithman, of Oil City, Penn., to suggest, and as indications promise, to put in execu-

tion an extremely novel method. Two months ago Mr Smithman took out patents on his idea and now proposes to put it into actual operation on a road he is about to construct in Oil City. On one of his proposed lines he is obliged to take cars up three heavy grades, of which one is a 12 per cent for 900 feet; another 15 per cent for 700 feet, and the third 14 per cent for 1,500 feet. On these grade portions of the line the double track will converge at top and bottom of the hill into a single track.

For each grade he will sink a well at the top, of five or

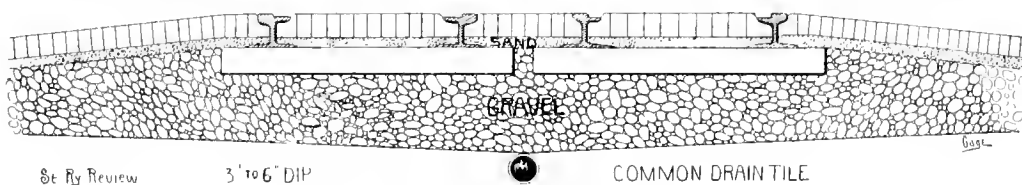

DOUBLE TRACK DRAIN CONSTRUCTION.

on perfectly clean broken stone ballast are, after a few months, found to be laid on nothing but a sticky mass of stone and mud. Mr. Gates gives it as his opinion that when the tracks are laid on concrete there is no chance for settlement, but does not believe that it is a good plan to lay the ties directly on concrete. He would put a layer of screened gravel between the cement and the ties for a cushion. In the method just described, the middle of the trench for a double track road is from three to six inches lower than the sides, and for a single track road about three inches lower.

THE Ottawa (Ontario) Electric Street Railway Company has declared an 8 per cent dividend. This is its second year. Two million fares have been taken in, and with a population of 45,000, and horse line in the town.

six inches diameter, and about twenty-five feet deeper than the length of the incline. This well, or hole, will be drilled in the same manner that oil wells are sunk, and will be very much like one. It is expected the well will be "cased" part or all the way, that to be determined later, according to the character of the strata passed through. If the uncased well is decided on and fills with water, the iron weight must be one-seventh heavier than otherwise. If the well is cased, it will be nearly filled with oil to preserve the cable and facilitate movement of the weight. The cost of drilling varies, of course, with the nature of the rock, but at the points selected in this instance will be 75 cents per foot of depth. The cable is to be of wire rope, strong enough to carry one ton where the grade is 12 per cent and the car weight eight tons. The other grades in the same relative proportion. The

weight is also contemplated to carry an automatic brake, which will exert a lateral pressure on the sides of the well, in proportion to the speed attained by the car under conditions of varying load from trip to trip, and act as a sort of governor to regulate its ascent and descent.

At the top of the well the cable passes over a pulley and is conducted between the rails either above ground or in a conduit as determined by the nature of the street.

The attachment of car to the car-end of cable is intended to be automatic, by means of a device which engages with jaws which depend from the car to which they are firmly fastened.

For grades exceeding, say 2,000 feet in length, Mr. Smithman would have a series of wells, requiring only

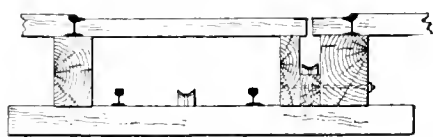

SECTION OF CONDUITS FOR COUNTERWEIGHTS—SEATTLE.

fifteen feet of practically level track in which to release one cable and take the next. As he says, we will all know more about it, and how it works, within three or four months, and naturally expects to make some possible modifications of his plan which can only be suggested after actual construction has begun. The plan certainly is a novel though in the main a simple one, and possesses

vent shock when the counter weights arrive at the bottom or top. The grips, if they can be called such, are permanently fastened to the cable, and the arm or shank projects up through the slot. To this the cars are connected. At Seattle the shank is coupled to the car by hand with a pin. In Portland automatic couplers are used. Going up, the car runs past the grip and backing down the grade is automatically coupled to it. When it reaches the top it is automatically uncoupled without stopping. On the down trip the car slows and is automatically coupled without stopping so that it is impossible for the car to descend without the counterweight. At the bottom the car must stop for the conductor to disconnect. The counterweights are made about equal to the weight of the empty cars. For the illustrations accompanying this description we are indebted to the Engineering News.

STREETERS IN GERMANY.

STREET car horses in Germany command a price equivalent to \$250 in our money. They are largely imported from the surrounding countries, and the question has been raised as to whether they could not be profitably shipped from the States. The margin, however, will not be found to be large, as the ocean freight New York to Hamburg is \$50 per head in lots of not less than seventy-five; and to this must be added expense of erecting deck stalls; feed in transit; \$20 passage

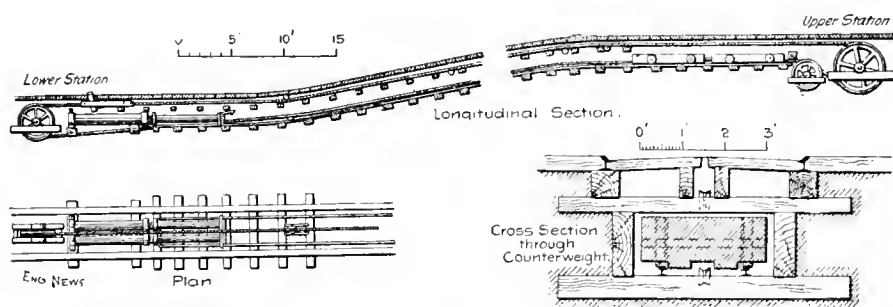

SECTION OF CONDUIT FOR COUNTERWEIGHTS—PORTLAND, OREGON.

many features which commend it. Our readers will await with interest the result of the experiment, and meanwhile join the REVIEW in the honest wish and expectation that Mr. Smithman may have no occasion to be sick of his well.

Another system of counterbalancing weights for helping up grades is in use on the Ranier avenue line at Seattle, Washington, and also on the Front street line in Portland. It is the invention of J. P. F. Kuhlmann, of Seattle. The plan adopted by the two roads is slightly different. At Seattle the conduit and track on which the counter weights run is put directly under the surface of the roadbed and the slot is at one side. In Portland the slot is in the middle and the counterweight conduit is beneath the railway ties on a second set of ties. The rope of course passes through the small conduit, passing over pulleys at the ends, as shown in the longitudinal section. At Seattle pneumatic buffers are provided to pre-

money per man in charge; and the German import duty of \$5 per head. A much wiser plan is for our German friends to import American electric and cable ideas and apparatus and thus secure a genuinely good and serviceable article.

CEMENT FOR STEAM PIPES.

CEMENT which it is claimed is valuable for filling up small leaks in steam pipes is composed of 5 parts Paris white, 5 parts yellow ochre, 10 parts litherage, 5 parts red lead, 4 parts black oxide of manganese. These metals are mixed thoroughly and a small amount of asbestos and boiled oil added. It will set in from two to five hours.

THE Ft. Wayne Electric is building a sprinkler to use on its tracks, to be drawn by a motor car.

CHICAGO AGENCY OF THE IDE ENGINE.

THE Chicago office of A. L. Ide & Son, the engine builders of Springfield, is located at 208 Home Insurance Building, where will be found C. E. Sargent, the genial and experienced manager. Mr. Sargent is a graduate of Blackburn University in 1882 and of the University of Illinois in mechanical engineering in 1886. He has been connected with A. L. Ide & Son since '89, and took charge of the Chicago office in 1890. At that time there were thirty-nine Ide and Ideal engines in use in the city. There are now running one hundred and eighty-four, many of them being in the fine new office buildings. Of two hundred and twenty-six Ideal engines sold in the past three years about forty



C. E. SARGENT.

are in street railway work. The business has necessitated moving into larger quarters three times in as many years. The record for the past month is seven engines and four 100-horse-power boilers. The three power plants for the city lighting of Chicago are the work of Mr. Sargent and the Ide engine people.

The Ideal engine and Mr. Sargent's ability as an engineer and salesman make a strong combination, and all who have seen the former and have the pleasure of an acquaintance with the latter will readily understand the secret of the success of both.

CEDAR RAPIDS AND MARION EXPRESS.

THE interurban line from Cedar Rapids, Iowa, to Marion, has developed quite a business in the way of baggage and express. The Cedar Rapids & Marion City Railway Company operates the lines in

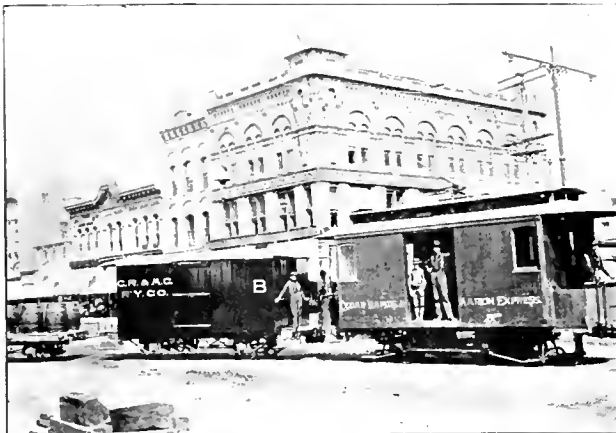

ELECTRIC EXPRESS TRAIN.

Cedar Rapids in addition to the interurban. Of this company P. E. Hall is president; W. D. Douglas, vice-president; J. S. Ely, secretary; C. H. Clark, treasurer, and F. L. Diserens, superintendent. The distance from

Cedar Rapids to Marion is six miles as the road runs. The track and roadbed is the same as that of a steam road, except that it runs alongside the highway for the greater part of the distance, and the grades are heavier than on a steam road. The quantity of travel between the two places is accounted for by the fact that Marion is the county seat of a county in which Cedar Rapids is by far the largest town. The passenger business is sufficient to warrant the starting of a 36 foot (over all) car from each terminus every 40 minutes. The running time is 28 minutes, and as the speed up grade is rather slow, this necessitates some pretty fast work on the down grades. A speed of 32 miles an hour has been recorded.

The baggage equipment is shown in our engraving, the two cars in the rear being trailers. The flat car loaded with barrels is used for the oil tank line, which the company has the contract for running from Cedar Rapids to Marion. They also have the contract for carrying the local business of the American Express Company. This contract does not, however, prevent them from carrying other business on their own account as they see fit. At the Marion end of the line an arrangement is made with a dray line to collect and deliver parcels for a percentage. At Cedar Rapids goods are called for at the car by those to whom they are shipped, or when small are delivered via the American District Telegraph Company. The motor baggage car makes three round trips a day, and hauls trailers when necessary.

METROPOLITAN TRACTION CHANGES.

THE retirement of John D. Crimmins from the presidency of the Metropolitan Traction Company, of New York City, has given this important position into the hands of H. H. Vreeland, of New York.

Mr. Vreeland is Mr. Crimmins' personal choice for the position, and the most friendly relations exist between the ex-president, the incumbent and the company. Mr. Vreeland is a railroad man of wide experience and a manager of undoubted repute. He was born at Glen, N. Y., in 1858, and began his railway career in 1874, with the Flushing, North Shore & Central, where he remained until 1881. At this latter date he came to the Northern system, and has been identified with it ever since.

Mr. Vreeland's experience has been of the most varied character, and it has been his good fortune to learn every detail of passenger traffic through actual experience.

Personally Mr. Vreeland is a most affable, gentleman, and in height is above the average.

The position of president of the Metropolitan Traction Company is one that has been filled with the greatest credit by Mr. Crimmins, who brought it through the throes of organization and consolidation, and whose management has been of the most thorough and firm type.

We regret to lose Mr. Crimmins from the fraternity, while we are pleased to welcome another steam road man into the ranks of intramural rapid transit managers.

THE GIBBS' TROLLEY.

THE Gibbs' trolley, shown in the accompanying engraving, is designed to obviate some of the inherent disadvantages of trolley bases now in use and introduces new principles not made use of in others. Referring to the illustration it will be seen that the essential features consist of an upright tube, in which the pole is fixed, and bearing on the bottom two jaws which pivot on two shafts fixed in a base. This allows the trolley to be run in either direction without swiveling if thought advisable. The swiveling feature is also introduced to allow of the easy taking of curves. On the upright tube is slipped a loose collar, over the compression spring and from which run chains, to eye bolts on each side of the base, thus producing, when the trolley pole is pulled down, a compressive effect in the spring, due to the leverage. It will be noticed that when the pole is upright the leverage is greatest and the spring pressure slight. This feature is of great value in work where the height of the line varies from 14 to 22 feet, as it produces an easy motion and even pressure of the trolley head peculiar to this form of base. It will be readily seen that this is necessarily the case, as the spring acts against an unbalanced leverage, and when in an almost upright position the weight of the pole and pole socket will aid the spring in returning the trolley to a vertical position. In other trolleys no advantage is taken of this principle, the result being that the spring must either be compressed that much more or a stronger spring used. When the trolley is lying flat with the car roof the pull is lessened. Only enough pressure is aimed at to return the trolley quickly in low and drawbridge work. This principle, that of decreasing the pressure as the trolley wheel descends, has been heretofore unused but on inspection will be found correct. In cities where there are drawbridges or elevated structures, this action will be found of immense value, as the quick destruction of trolley wheels and heads is partly produced by the intense hammering due to an excessive and unnecessary spring pressure.

The base consists of but eight separate parts, readily removable, if broken by any cause, and made interchange-

able by special machinery. Harrison & Carey, of the Nuttall Railway Supply Company, Chicago, are sole agents for this attractive device and have adopted it as their standard trolley. Several large orders have already been received from important roads.

KILLED BY THE CURRENT.

A HEART-RENDING account of the sudden and painful demise of one Frank Arnith at the power house of the Minneapolis Street Railway Company, is given by the papers of that city, and attributed, of course, to the deadly trolley current.

An autopsy showed beyond a doubt that the death of the young man was caused by the electric current. So far, so good. An interview with a prominent electrician of Minneapolis unraveled the mystery of how a man was killed by 500 volts, by explaining that a 100-light arc plant at the station was the immediate cause of the accident. The method of contact is not known, as no one saw the act. It is supposed, however, that it occurred at the switch board. The voltage of this arc plant was about 5,000, and the victim of misplaced confidence and switches probably received the entire benefit of the plant.

The ignorance of the average reporter is usually attributable to carelessness, but the above is a specimen of telling only half the truth.

At the recent accident at Lowell, Mass., when a fly-wheel divided itself in twain, an intelligent young man of

the Boston press sent back the startling information that the accident was caused by a short circuit between the engine and the dynamo! Some wealthy syndicate ought to start a kindergarten for the reporter, and then enact a law touching compulsory education. It's bad enough to have the King's English butchered, but to have science garbled in addition to sins of syntax is too much.

COL. F. K. HAIN, of the Manhattan L of New York City, after his recent visit to Chicago, wrote a public letter in which he commends the World's Fair and Chicago, and compliments the rapid transit facilities of the windy city as surprisingly large and remarkably efficient.

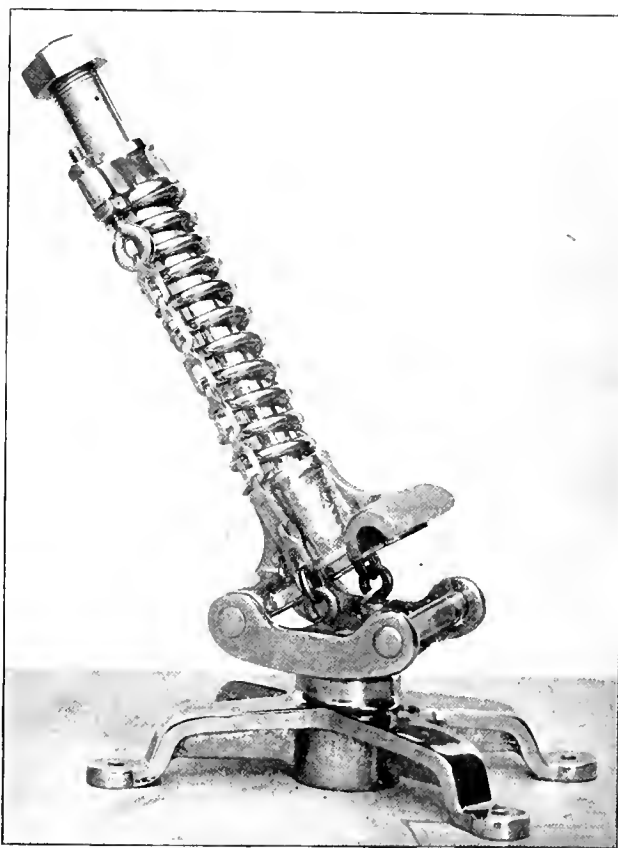

THE GIBBS' TROLLEY.

PRESIDENT JOHN A. RIGG.

THE president of the Traction Company, John A. Rigg, of Reading, Pa., was born in Reading, and is about 45 years of age. He has been connected with the street railways of that city since their inception in 1873, and was superintendent of the Reading City Passenger Railway for many years prior to his election as president of the Reading Traction Company. He is recognized as one of the best informed street railway men in the east. After a long service with the street railways there, in 1892 he was elected first vice-president and general manager of the People's Railway Company of Philadelphia. He served in that capacity for about a year when he returned to Reading, May 1st, 1893 to become president and general manager of the newly organized Reading Traction Company, which had leased all the railways of that city. He is now equipping the lines of the company, embracing some thirty miles of track with electricity. He has given the problem of street railways thorough study, both upon its theoretical and practical side, and for many years the street railways of Reading under his official direction have been recognized as among the best managed in the country.



JOHN A. RIGG.

PITTSBURG COMBINATIONS.

UNION that is strength as well as economy is the last idea in Pittsburg, and was accomplished at 5 o'clock, June 14, 1893, by absorption of the Pleasant Valley Traction Company and the Allegheny Traction, by the Pittsburg, Allegheny & Manchester.

The deal has been under consideration since last winter, but such matters move slowly, and all were not satisfied until the date above set.

The new corporation will have a capital stock of \$5,000,000, divided into shares of \$50, par value. Of this amount Manchester will receive \$3,000,000, Pleasant Valley \$1,600,000, and the Allegheny \$400,000. In the increase the Pleasant Valley gets one extra share for every seven the stockholders had in the old company. Nine members will form the new board of directors. Four will be named by the Pleasant Valley, four by the Manchester and one by the Allegheny.

One set of officers will reduce expense, and the electrifying of several lines will add dividends.

RAIL WELDING ON THE WEST END.

AT last a welder has been put to work on a stretch of actual street railway track and the advantages and disadvantages of a continuous rail will be demonstrated by actual practice within the next six months. The West End road, of Boston, has welded a stretch of track near the city hall in Cambridge. The welding machine has a motor transformer for giving the proper welding voltage from the current derived from the trolley wire. The clamps for holding the rail ends during welding are swung from a crane at one end of the car. Emery wheels for cleaning the rails and water tanks for keeping the parts cool are also at hand. In welding a joint the paving is removed to make the joint easily accessible to the depth of the rails. When the iron has been cleaned with the emery wheels the clamps are lowered and fastened and the current turned on. It takes from five to ten minutes to complete a weld. Before cooling, the head of the rail at the joint is hit a few blows with a sledge hammer to remove the burr.

It is greatly to be hoped that this continuous track will not assume a serpentine form, as is feared by many, but a few months trial will prove more than years of argument.

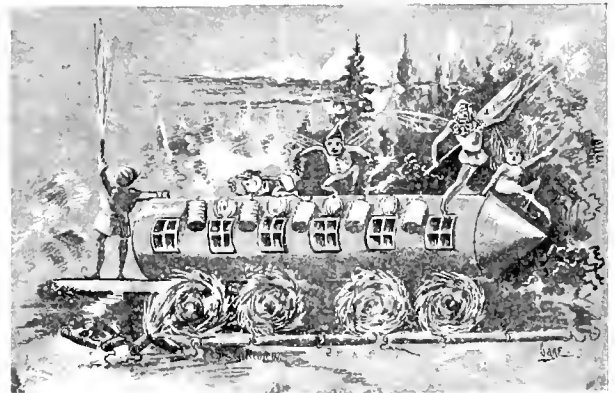

THE MOTORMAN'S DREAM AFTER THE FOURTH

CONDUCTORS TRAFFIC IN TICKETS.

WHERE tickets are sold in quantities at a reduction there will always be the standing temptation to the men to purchase in wholesale on their own account and turn in more or less each day in place of an equal number of cash fares collected. This manipulation has been recently discovered to have been extensively worked on the West Side lines in this city where the cash fare is five cents and 22 tickets are sold for one dollar. The ordinary collections per cable car conductor are \$35 per day and where the men cashed in extra tickets for say \$5, the net profit was forty-five cents, or about \$125 per year. There seems to be no absolute protection against this kind of imposition where the men are disposed to be dishonest, although it is not an out and out steal as in the case of a straight knock-down. As a result of the investigation quite a few new conductors have been required to fill sudden vacancies.

WESTINGHOUSE, CHURCH, KERR & COMPANY IN MACHINERY HALL.

IN the fore front of the great engine exhibit in Machinery Hall stands the beautiful array of Westinghouse, Church, Kerr & Company's engines. Chief among the interests of this showing is the main plant, consisting of six 1,000-horse-power engines, direct coupled to an equal number of 10,000-light Westinghouse Electric & Manufacturing Company incandescent machines. In the main plant are also two 400-horse-power compounds, belted direct to two 4,000-light incandescent machines of the same make. Three 130-horse-power compounds are next in the list, coupled direct to

THE HOPPES MANUFACTURING COMPANY EXHIBIT.

ONE of the most interesting of the exhibits in the great boiler plant annex to Machinery Hall is the one placed by the Hoppes Manufacturing Company, of Springfield, Ohio. The operative part of the plant is of course, not in plain view of the visitor. It is, however, large and effective enough, as both exhaust heater and live steam purifiers for 5,000-horse-power of Heine boilers are in active operation in the plant.

Besides this, under the care of R. J. Campbell, salesman for the house and World's Fair representative, there may be seen a 300-horse-power exhaust heater and a live

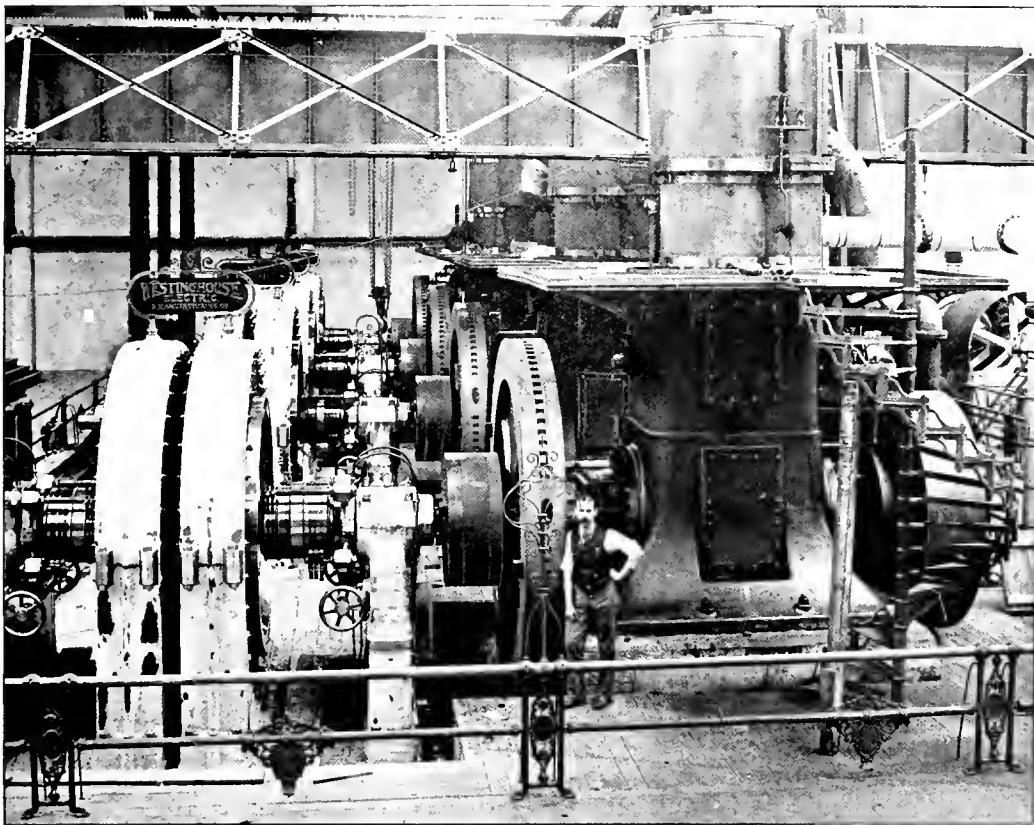

MAIN PLANT OF WESTINGHOUSE, CHURCH, KERR & CO.—MACHINERY HALL.

direct current dynamos, furnishing the current for exciting the fields of the alternating light machines.

In the Annex to Machinery Hall, two 125-horse-power simple engines are doing duty driving the paper-making exhibit.

In the Electricity Building is found the Kodak type described last month in the REVIEW. This, it will be remembered, is a 260-horse-power compound, direct coupled to a Westinghouse 200-kilowatt multipolar railway generator.

The Westinghouse, Church, Kerr Company has in point of horse-power the largest exhibit at the Fair, aggregating 7,500-horse-power. To the engineer the exhibit is of great interest, from the fact that it is the largest display of direct coupling on the grounds.

steam purifier of the same capacity. The purifier pans have been in use and carry the evidences of use. Both of these latter appliances are placed upon the visitor's gallery near the wall and are so concealed by the asbestos covered piping that a just photograph is not possible.

A showcase near the visitor's register shows a number of specimens of scale taken from the Hoppes purifiers. One in particular, a big hard lump of sulphates of lime and magnesia, ought to be a nightmare to any boiler user who turns unpurified water into his water tube boiler. Several tough specimens of soft scale from the heater are shown also. These are mainly carbonates. The city offices of the company are at 8 "Rookery" and W. S. Love, well known to power users, will be glad to talk the matter over with all interested parties.

THE PHOENIX IRON WORKS.

THE three engines shown in the eastern part of Machinery Hall by the Phoenix Iron Works deserve a longer mention than these pages can accommodate. As many of our readers will, however, probably see these designs, it is not necessary to do more than state the facts in the case.

The tandem compound condenser is the latest design of the Dick & Church engine. In this engine the low pressure cylinder is carried on a separate bed frame, which forms the sub-base of the main engine. Previous practice was to attach the rear to the forward cylinder, which was supported from the bed frame of the engine. The new construction is said to attain the double advantage of greater rapidity and at the same time of allowing

THE STANDARD RAILWAY SUPPLY COMPANY.

A NEAT space in street car row, L, N, 9 and 10, is the objective point of many street railway managers, from the fact that here the Standard Railway Supply Company, of which T. C. Roberts is president and Garson Meyers general manager, shows how to keep cars warm during cold weather without cutting the seats. These stoves have at various times been illustrated by the REVIEW, and are seen in so great numbers both in Chicago and elsewhere that we refrain from giving a more extended description.

The space is arranged with a short upholstered seat section in the rear, upon which is placed a Standard car

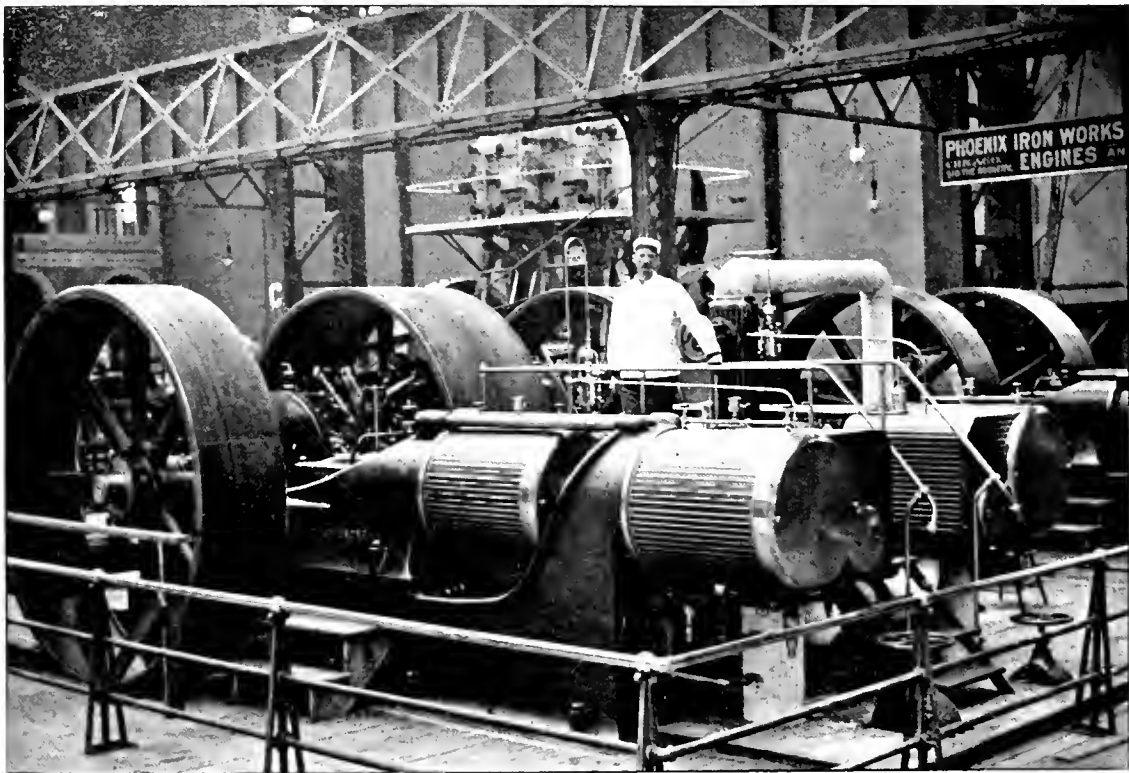

TANDEM-COMPOUND EXHIBIT OF DICK & CHURCH, MEADVILLE, PA

each cylinder to expand independently of the other, still holding alignment. The hoods carrying the overhanging cylinders are rigidly tied together by a rod, which extends from one to the other, over the top of the high pressure cylinder.

The automatic control of the valves of both cylinders by the single governors is a valuable feature in this class of engines, giving practically a regular receiver pressure, and proper distribution of load and temperature between the two cylinders at all points of cut off.

All the wearing parts of the engine are well made, and the entire machine is built with the idea of electric railway service requirements.

A triple expansion condenser of 500-horse-power and a simple engine of 250-horse-power are also shown.

stove of the latest type. This one has a white enameled drum about the pipe, and is a pretty as well as useful piece of furniture. A roof above the stove is supported by brass poles and tastily draped. On either side is another heater of the same type with a blue enamel drum, but set on a small stand close to the polished floor.

On the west side of the space is a 12-foot seat holding a heater and designed to show the small amount of space occupied by the heater even in a short car.

The space well shows the advantage of the Standard heater, and attracts the attention of every manager visiting the row.

EVANSVILLE STREET RAILWAY COMPANY is enjoined from going up the river road to Howell, a suburb.

BALL OF ERIE AT THE FAIR.

ALTHOUGH not a large exhibit the Ball Engine Company, of Erie, Pa., has a very satisfactory display of their particular type adapted to central station work. To the end, as a practical working exhibit, the company has installed in the east end of Machinery Hall one of their 19 by 36 by 18-inch cross compound engines, capable of running from 200 to 250 revolutions economically. This engine runs two 2,500-light Edison machines. The exterior of the engine is pleasing and it is without doubt one of the most compact of all the power producers in the Exposition, occupying a trifle less space than a vertical engine of equal capacity, besides claiming

The low pressure cylinder valve is driven independently by an eccentric not controlled by the governor. Although not automatic it is adjustable by hand so that the point of cut-off in the low pressure may be regulated to suit the various conditions of load.

The one solid piece of steel forming the crank shaft is machined off and key seated to receive the cast iron counter balance weights. The counter balance weights are disc shaped and keyed tight to the shaft.

The governor, after the Ball method, has two weights and two counteracting springs running out from the rim of the governor pulley. Attached at one end to one of the weight arms and at the other end to the piston rod of a dash pot is a third spring. The dash pot consists of an

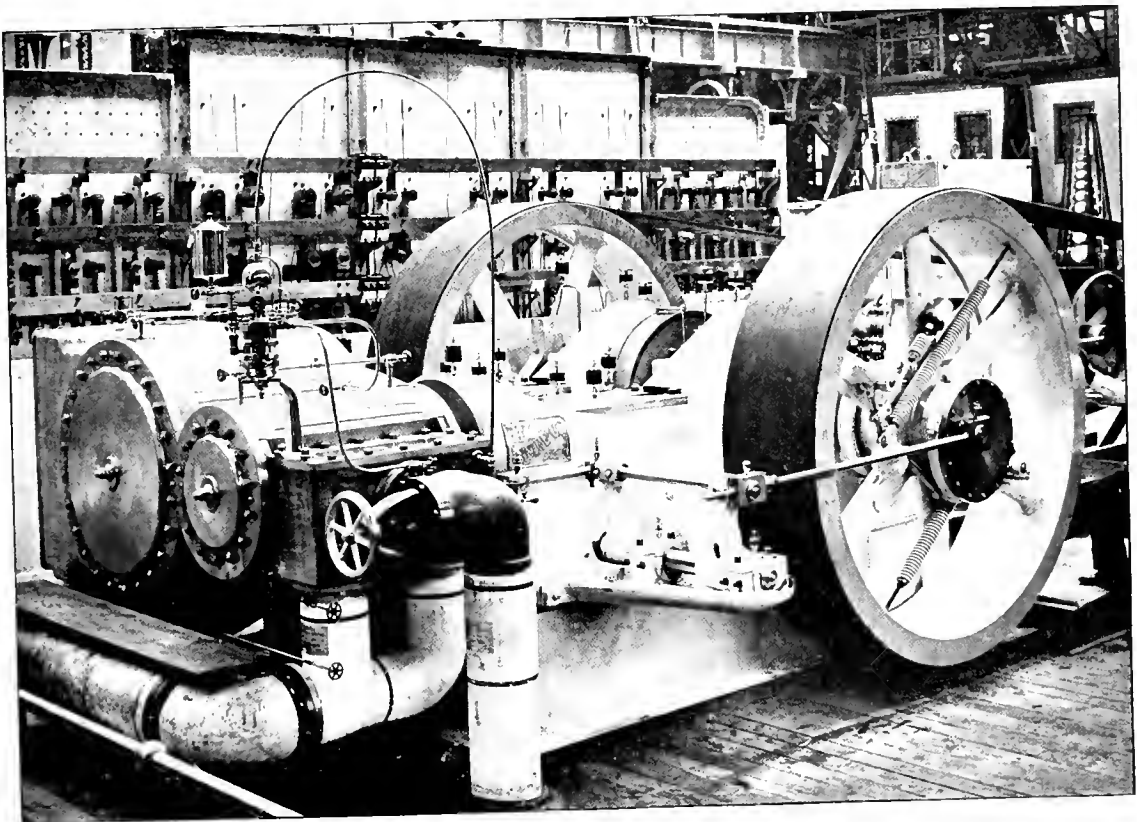

CROSS COMPOUND—EXHIBITED BY BALL ENGINE COMPANY OF ERIE.

the advantage of easy access for manipulation and regulation. The cylinders of the engine are placed close together and it is designed as a condenser.

The special design of this type of engine, built first about two years ago by the Ball Company, is for heavy work and all parts are made with this in view. The cranks are opposite each other one counteracting the effect of the other, thus balancing the machine and giving quiet working at high speeds.

The high pressure cylinder valve in the engine consists of two parts connected in telescopic fashion, allowing each half to adjust itself to its seat. This arrangement makes the valve really double faced. The valve is directly controlled by the governor, making the only automatic cut-off on the engine.

oil-filled cylinder, provided with a piston having an aperture through which the oil passes, as the piston travels in either direction. The spring is arranged for compression or extension, so when the governor weights move the third spring is held tense for a moment, giving stability to the governor until the action of the dash pot releases the tension. The speed is determined by the long springs entirely.

This engine exhausts into a Worthington condenser.

The Ball Company has also a 60-horse-power simple non-condenser, which has been in use for two years, giving the best of satisfaction. W. E. Hansen, erecting engineer of the Ball Company, is attendant engineer, and will be as glad, as he is capable, to explain the merits of the Ball engine.

LANE & BODLEY AT THE WHITE CITY.

THE Lane & Bodley Company occupy their space in section C, Machinery Hall, with three engines, which furnish the power through countershafting for an arc lighting plant composed of Thomson-Houston machines. To the north is a 300-horse-power cross compound, driving seven 50-light arc machines. This is a piece of work of which Lane & Bodley are specially proud. It is their latest new design, "Columbian." The cylinders are 16 and 31 inches in diameter respectively, by 42-inch stroke. It runs at seventy-six revolutions a minute. Their agent who has charge of the exhibit, says that they have tried to make a common sense engine, leaving off all unnecessary sharp corners and

CORLISS AT THE CENTENNIAL.

SOME interest will no doubt be taken in a refreshment of the memory as to the power and dimensions of the famous Corliss engine, built by Geo. H. Corliss for the Centennial in 1876. The Centennial Corliss now doing duty at Pullman, was one of the finest examples of its type ever made. It had a pair of 40-inch cylinders of 10-foot stroke, and developed something in the neighborhood of 1,250-horse-power while in operation. The length of its beams between centers was 25 feet and the diameter of its crank shaft was 19 inches. Its fly wheel measured nearly 30 feet. The Centennial Corliss turned 36 times a minute and the revolutions for the exhibition were 2,355,300. This engine transmitted

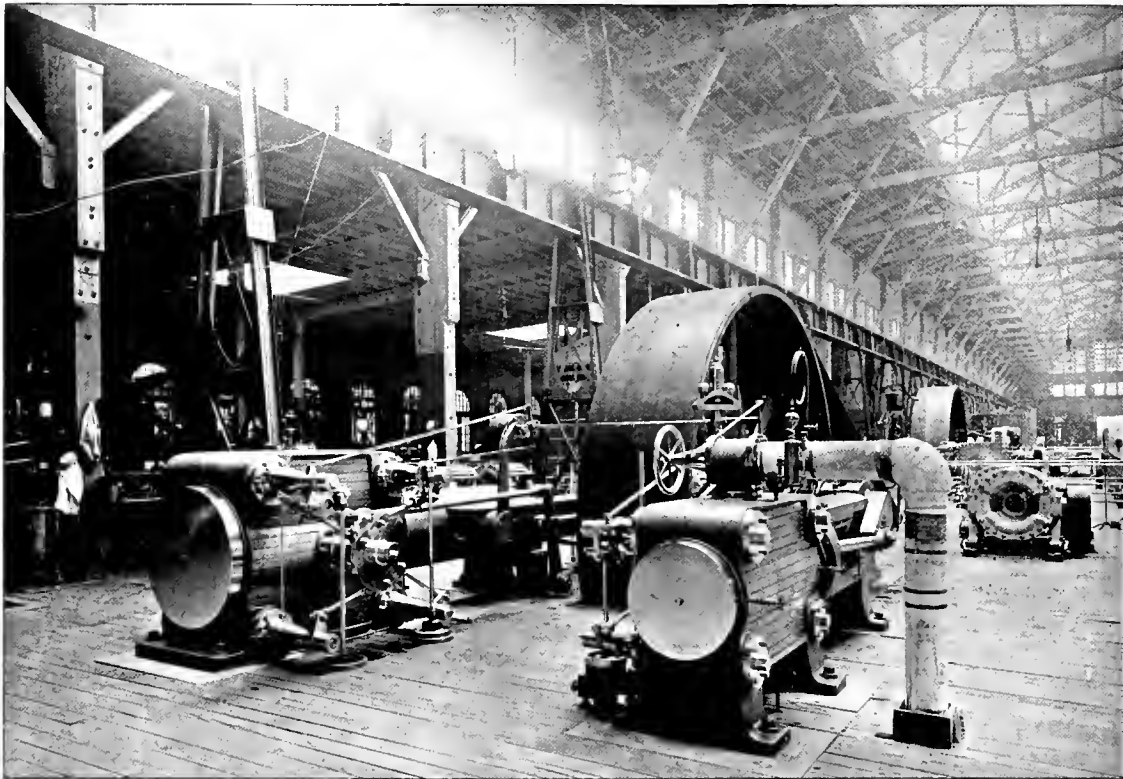

LANE & BODLEY EXHIBIT.

forming a symmetrical piece of machinery. At the south end of the space is a 300-horse-power tandem compound that has been their standard for so many years. This runs six 50-light arc machines. Between the two engines mentioned is a simple engine, running at eighty revolutions and driving four 50-light machines. Lane & Bodley were among the first to finish their exhibit, and it has been on duty furnishing light regularly since the Fair opened, demonstrating in the most practical way the suitability of these machines for central station work.

On July 4th the Chicago City Railway maintained a three-quarter of a minute headway with three and four cars in a train all day. This breaks all records.

its power to a main jack shaft. It requires but a glance to see the vast difference in power making and transmitting of the present day when electricity does the rest. There are four or five engines at the Chicago Exposition that are of larger horse-power than the great Centennial engine and the original Corliss would attract attention only as a curiosity.

APPLICATION has been made for a receiver for the Barre Sliding Railway Company. The capital stock at which it was organized is \$300,000. The structure, partially built, is now on the Midway Plaisance. The company asks the court to stay a seizure of the road for a short time, when it is claimed it will be in operation and all debts paid.

NEW PUBLICATIONS.

TAYLOR, GOODHUE & AMES are furnishing their customers and others with a 212 page catalogue permanently bound in cloth and containing illustrations and prices on nearly everything in the electric light and railway supply line.

THE 1893 CATALOGUE of the Sperry Electric Railway Company, of Cleveland, is a neatly arranged treatise on electric motors, in which the advantages of the bevel gear is incidentally mentioned. It will interest all street railway men.

THE ANSONIA ELECTRIC COMPANY has just issued catalogue No. 44 B. This is a handy resume of house goods sold by the company. A larger and more complete catalogue will soon be issued, but all who express the wish can receive 44 B.

THE UNIVERSITY OF MINNESOTA catalogue just out shows a healthy condition of the mechanical and electrical engineering departments. As formerly mentioned in the REVIEW, the electrical engineering department, under Professor Shepardson, is having a remarkable growth and improvement.

THE UNIVERSITY OF WISCONSIN catalogue for 1892-3 is at hand, Professor D. C. Jackson, the well known electrical engineer, is in charge of the electrical engineering department, and has had no small share in giving the west the splendid educational advantages along electrical engineering lines that it now has.

THE BATES MACHINE COMPANY, Joliet, Ill., will begin mailing in a few days their new catalogue. It is very tastefully gotten up and fully illustrates, in fine samples of the engraver's art, the several types of engines built by the Bates. The front cover will attract special attention, as it shows in relief a very perfect and complete outline of an engine, with every part clearly distinguishable—an effect very pleasing and artistic.

PRICE LIST NUMBER 6 has just been issued by the Okonite Company, Ltd., from the New York headquarters, 13 Park Row. It is a pamphlet of over fifty pages, containing a fund of valuable information concerning the celebrated product of the company. The covers are rich in appearance and elaborately designed, and show a lithographed title into which the well known Okonite trade mark enters conspicuously. They have adopted a new classification of insulators, designating them for low, medium and high tension currents. Railway work comes under medium tension.

RAILWAY APPARATUS OF THE WESTINGHOUSE ELECTRIC & MANUFACTURING COMPANY is one of the most elegant descriptive catalogues ever sent out to the trade. Between the handsome embossed covers will be found descriptions of all the railway machinery now made by the company. Some details of manufacture are also given. Every part is illustrated with a fine half tone engraving. Motors are first taken up; the armature receiving special attention. Then follows the series multiple controller and current diverter, and finally the generators, direct and belt driven. The apparatus is the same that has been on the market for some time, the fine performance of which has been shown to be fully up to the fine appearance of the circular.

THE LAW OF INCORPORATED COMPANIES OPERATING UNDER MUNICIPAL FRANCHISES. Street Railway Review, Chicago. Price, \$15. Three volumes. This is a set of books that should be in the hands of every street railway attorney. The author of this work is Allen R. Foote, Tacoma Park, D. C., the editing attorney being Charles E. Everett, of Cincinnati, O. They are assisted by associate editors, one from each state. This feature makes the treatise specially valuable, as each of the associate editors is able to take up the subject as it is in his particular state. The existence of so many corporations operating under municipal franchises has created a demand for a law treatise dealing specially with such questions, and as this work comes forward to supply this requirement it should meet with a ready reception. It is indexed thoroughly for quick reference. Indeed the whole of Volume III is an index, so that there is no danger that the information contained in these volumes will be unavailable.

DE LAND'S SYNOPTICAL INDEX. To the busy man desiring to keep abreast of the times and in touch with the trend of technical thought, yet

lacking the time to carefully peruse even one journal from cover to cover, we can heartily recommend the synopsis of current electrical literature of the world that forms an essential part in Mr. De Land's magazine, Electrical Engineering, and which is carefully arranged under classified headings. In the June issue appear the titles of sixteen foreign and 114 home publications sent to Mr. De Land for indexing, while the preceding forty pages contain a digest of 330 articles, placed under seventy-six headings. For instance, there are fifteen entries under the heading, "Meters and Measurements." A mere glance through the work will indicate the amount of labor expended in its publication, a work that gains an increased value as each succeeding number appears, and one that merits the support of every electrical engineer, every engineering society and every library.

Custer's Last Battlefield.

A visit to this spot, which is now a National Cemetery, is extremely interesting. Here, seventeen years ago, General Custer and five companies of the Seventh U. S. Cavalry, numbering over 200 officers and men, were cut to pieces by the Sioux Indians and allied tribes under Sitting Bull. The battlefield, the valley of the Little Big Horn, located some forty odd miles south of Custer, Montana, a station on the Northern Pacific Railroad, can be easily reached by stage. If you will write Chas. S. Fee, St. Paul, Minnesota, inclosing four cents in postage, he will send you a handsomely illustrated 100 page book, free of charge, in which you will find a graphic account of the sad catastrophe which overtook the brave Custer and his followers in the valley of the Little Big Horn, in June, '76.

THE COOK ELEVATED ELECTRIC RAILWAY IN TRANSPORTATION BUILDING.

THE Cook Elevated Electric Railway Company have installed and in successful operation in the Transportation Building a perfect working model of the system already built in Tacoma, and which was fully described in these columns last April.

The track is 50 feet long, in the form of an ellipse, and is faithfully constructed in all its parts to a scale of one inch to the foot.

The immense crowd which gather around the exhibit from morning until night are not only attracted by the pretty working of the cars, but that the full sized construction is capable of 200 miles per hour. We have already confidently expressed our belief that the Cook system not only can attain and maintain such a speed; but that it can be accomplished with an absolute guarantee of safety which is possessed by no other known means of transportation. Of this anyone can easily satisfy themselves by an examination of the exhibit.

The system is simplicity itself, is not expensive to construct, and can be rapidly built. When in operation it is difficult to see where numerous repairs can arise. Several of the best known capitalists in Chicago are behind the project, and the next step will be to construct a large line.

PERSONAL.

Prof. GEO. D. SHEPARDSON, Minneapolis, was a June visitor at the Exposition.

WM RICHARDSON, wife and daughter, Brooklyn, spent a week at the Fair in July.

WATERMAN STONE, of the Kansas City elevated, was a Fair visitor early this month.

B. N. PRATT, manager of the Phoenix, Ariz., Electric Railway, has returned from California.

C. F. BERRY, of the Portland, Me., Railway Company, was an Exposition visitor during the month.

GEO. G. CARTER is the superintendent of the World's Fair exhibit of the Ansonia Electric Company.

HENRY HURT, of Washington's cable road, was a June feature of street car row at the Exposition.

DAVID YOUNG has become general manager of the Consolidated Traction Company, of New Jersey.

HENRY C. MEYER, JR., is the representative of the Engineering Record, of New York, at the Exposition.

JOHN N. MURPHY, of Cleveland, well known in street railway circles, was a recent visitor at the REVIEW office.

JOHN DICK, general manager of the Phoenix Iron Works, of Meadville, Pa., was a Chicago visitor of the month.

W. W. SNOW, manager of the Ramapo, New York, Wheel & Foundry Company, was a Fair visitor during June.

A. S. PARTRIDGE, the well known supply man, recently supplied the STREET RAILWAY REVIEW with a pleasant call.

CHAS. W. DAYTON, the new postmaster of New York City, was formerly president of the Rome (N. Y.) Street Railway.

A. FINDLAY SMITH, of Hong Kong, China, and builder of the remarkable mountain road there, was a REVIEW visitor in July.

FRANK A. ESTEP, president and treasurer of the R. D. Nuttall Company, of Allegheny, Pa., was a Chicago visitor during June.

J. R. GATHRIGHT, general manager of the United Tramway Sprinkler Company, was a REVIEW visitor during his visit at the Fair.

J. M. SAEMAN, president of the Sheboygan, Wis., City Railway Company, was a July visitor at Chicago and the STREET RAILWAY REVIEW.

SECRETARY CHAS. L. WRIGHT, of the Toledo, O., Consolidated, was a recent visitor at the REVIEW office. Mr. Wright spent several days at the Exposition.

A. A. ANDERSON, late secretary of the Indianapolis Citizens' Street Railway Company, has removed to Cincinnati in the interest of the Johnson lines there.

J. M. THOMPSON, who has successfully constructed so much cable work in San Francisco, spent ten days at the Fair and went east to take steamer for Europe, where he will make an extended trip.

OSCAR NYCANDER, consulting engineer, and largely interested in tramway and local steamer lines in Stockholm, Sweden, is visiting the Fair, making a study of American railways, and was a caller at the REVIEW office.

A. J. BATES, secretary and treasurer of the Bates Machine Company, Joliet, was a caller at the REVIEW office. He reports their works as brim full of orders and the Bates Corliss as in great favor with users.

Dr. ALBERT SHAW, editor of the Review of Reviews, New York, and to whose ability and energy its wonderful success is almost wholly due, was a frequent visitor at the STREET RAILWAY REVIEW office during his visit to the Fair.

B. H. COHO, of the New York office of the Waddell-Entz Company, has combined two weeks of business and World's Fair, and has reason to be satisfied with his success in both. He made headquarters with J. H. Gates, Chicago manager.

FREDERICK J. WILLSON has severed his connection as general manager of the lines at Battle Creek, Mich., and sold his interests there. He has nearly completed arrangements for a future undertaking and will have something of interest to announce very soon.

L. A. CARR, general manager of the Schenectady Street Railway Company, has resigned his position on account of ill-health. H. S. Cooper, of Washington, D. C., will succeed him. Mr. Carr leaves Schenectady to the regret of all the citizens, and his many friends hope that rest may restore his health.

DR. KOLLMANN, owner of one of the tram lines in Frankfurt, Germany, spent three weeks at the World's Fair, making the REVIEW office headquarters. The doctor is now making an extended trip on the Pacific coast, and on his return to Europe will prepare a report for the German Tramway Association of what he has found in street railway practice here.

R. D. NUTTALL, whose name and appliances are so well known to every street railway man in the land, has resigned from the company which bears his name and will soon be heard from in connection with an important company for the manufacture of street railway supplies. Mr. Nuttall, though one of the youngest men in the trade, is possessed of ability and a wonderful energy which deserves and achieves success.

HERMANN VON LITTRON, of Vienna, who has been spending a month here, was a visitor at the REVIEW office. He has been preparing an exhaustive report on railroads for the Austrian government, whose representative he is, and has made a most thorough and complete investigation. Mr. von Littrow is a very pleasant gentleman, and has made many friends, who regret his visit cannot be long enough to cover the balance of his life.

OTHER street railway visitors to Chicago during the month include:—

E. H. Mehl, Erie, Pa.

J. H. McGill, Denver, Col.

H. C. Tafel, Louisville, Ky.

N. H. Pattee, Monmouth, Ill.

A. R. Jenkins, Henderson, Ky.

Ernest Harper, Anderson, Ind.

T. E. Theberth, Newark, N. J.

C. A. Chase, Middletown, Conn.

Frank Rogers, Muskegon, Mich.

Thos. B. Dixon, Henderson, Ky.

C. A. Wildt, Long Island, N. Y.

HENRY A. EVERETT, Cleveland.

GEO. N. ENGERT, Springfield, O.

W. H. SINCLAIR, Galveston, Tex.

L. M. Thomas, East Liverpool, O.

A. H. Bradley, New Haven, Conn.

JAS. R. GOODRICH, Hartford, Conn.

Homer E. Safford, Plymouth, Mich.

J. H. Konersman, Indianapolis, Ind.

Chas. L. Wright, of the Consolidated, Toledo, O.

GEO. P. WIDNER, of the Philadelphia Traction Company.

GUY WILKINSON, Promotor Washington & Baltimore Electric Railway.

President J. M. Seaman, of Sheboygan, Wis., City Street Railway Company.

CHAS. CLEMINSHAW, president of the Troy City Railway Company, Troy, N. Y.

S. F. HAZELRIGG, formerly purchasing agent Citizens' Railway, Indianapolis.

S. C. HOLLEY, vice-president Danbury & Bethel Horse Railway, Danbury, Conn.

CHAS. H. AUSTIN, CHAS. J. OBER, of Nashua, N. H.; W. H. BROWNE, Greenville, Mich.

M. E. Jones, Cripple Creek, Col.; F. L. Cuddeback, Pueblo, Col., 6227 Lexington avenue; C. W. Case, Milwaukee; Geo. H. Keating, Bay City, Mich.

E. H. FOX, Phoenix Glass Company; H. Macfarland, Austin, Tex.; H. P. Richardson, Concord, N. H.; M. T. Burke, manager Terre Haute, Ind., Street Railway Company.

W. W. McNamee, Wabash, Ind; H. M. Lyman, Canton, O; J. F. Pratt, Indianapolis, Ind; Walton Stone, Kansas City Elevated; J. Luttrell Murphy, Lexington, Ky.

George C. Rough, Peoples' Street Railway, St. Joseph, Mo; F. W. Henshaw, Ft. Worth, Tex.; P. H. Hoover, New York; Chas. L. Wright, Toledo, O; Chas. S. Smith, Denver, Col.

John J. Cruikshank, Jr., Hannibal, Mo; Eugene Shaw, Eau Claire, Wis.; Walker Miller, superintendent Streator (Ill.) Street Railway; Jas. Lillie, president Escanaba (Mich.) Street Railway; Chas. Wenstenfeld, manager Elgin (Ill.) City Railway.

Harry Noll, Williamport, Pa.; C. S. Wakefield, Dallas, Texas; E. T. Cridge, Troy, N. Y.; C. G. Hussey, Pittsburg, Pa.; J. H. Martin, Pittsburg; Ed. Atkinson, Jr., Henderson, Ky.; George D. Durham, Phillipsburg, Mont.; H. E. Safford, Plymouth, Mich.

W. S. Poling, Anderson, Ind.; Marcellus Reid Cleveland, O.; E. B. Rhea, Joplin, Mo; F. Wayland Brown, Youngstown, O; Fred P. Werner, Milwaukee; Chas. H. Dolger, Milwaukee, Wis; F. J. Wilson, secretary, Battle Creek, (Mich) Electric railway; Andrew Smith, Muscatine, Ia.; W. F. & J. Barnes, Rockford, Ill.

THE HIEATZMAN UNDERGROUND TROLLEY SYSTEM.

WHILE the conduit system will naturally be confined to the larger cities there is a strong and growing interest in its success. The Hieatzman system of conduit electric railway is based on a series of patents granted to A. E. Hieatzman, of

purpose of holding the underground trolley. Having a single and independent conduit, it is claimed, reduces the cost of construction. With this system as proposed, there is also plenty of room to drain the conduit, a necessity not always provided for. Our engravings show sections through the yokes or supports. At all other places the conduit is open from the slot to the masonry bottom. Cleaning of the drain is accomplished by flushing from the city water works. Ordinarily it is intended to have

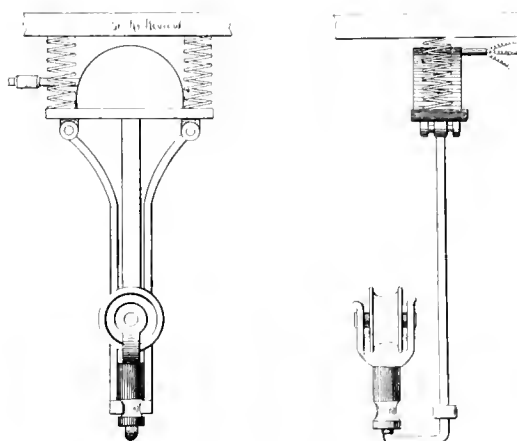

SIDE VIEW.—THE UNDERGROUND TROLLEY.—END VIEW.

the conduit three feet deep. As shown in our engraving, the center can be used as a duct for electric light, telephone or telegraph wires. It goes without saying that the conduit is entirely independent of the track and can be laid where the track is already down. The trolley conductors are to be of steel rail well bonded. These conductors are well protected from the slot, and the trolley arm is specially designed for conduit work, part of the arm being hard rubber. In very wet places the conduit would be made as deep as is necessary to carry off all the water.

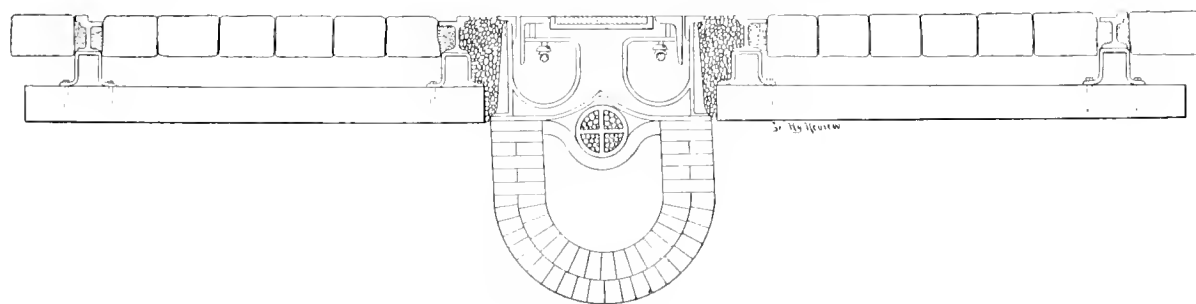

CROSS SECTION—HIEATZMAN CONDUIT SYSTEM.

Baltimore. The distinguishing characteristic of this system is the location of the conduit, which is placed between the tracks. There are some manifest advantages to be obtained by the location of the conduit between the tracks. The most important of these is, that at the conduit and its environments do not have to serve as a roadbed. Not being hampered by the necessity of making a conduit and roadbed in one, the inventor has a chance to design a conduit for the express and single

KANSAS CITY railways report heavy increase of traffic for the last six months.

THE operation of electric cars in Baltimore raises such a dust the company is about to put on sprinkling cars.

JOHN A. COYLE has resigned the presidency of the Lancaster Traction Company, and also of the Lancaster and City.

ELECTRIC LOCOMOTIVE AT THE WORLD'S FAIR.

ELECTRIC motors have been gradually creeping up in size to a point where they can be favorably compared with steam locomotives. The motor cars on the Intramural railway have hitherto been the nearest competitors the iron horse has had, but the General Electric Company has outdone itself by putting on exhibition just south of the

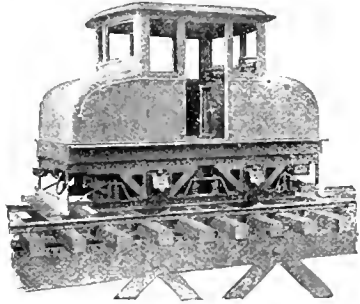

Transportation annex, a 30-ton electric locomotive, built at Lynn. It is the first machine of the kind to operate under the same conditions as a steam locomotive. The normal speed for which it is designed is 30 miles an hour, and it is of course best suited for elevated railway and light railroad work. It is a compact mass of iron and copper, running on four 44-inch wheels and measuring 15½ feet long, 11½ feet high and 8 feet 4 inches wide. The draw bar height is 2½ feet from top of rail. The calculated draw bar pull is 12,000 pounds. The motor armatures are directly on the axles and the motors are attached to the truck frame

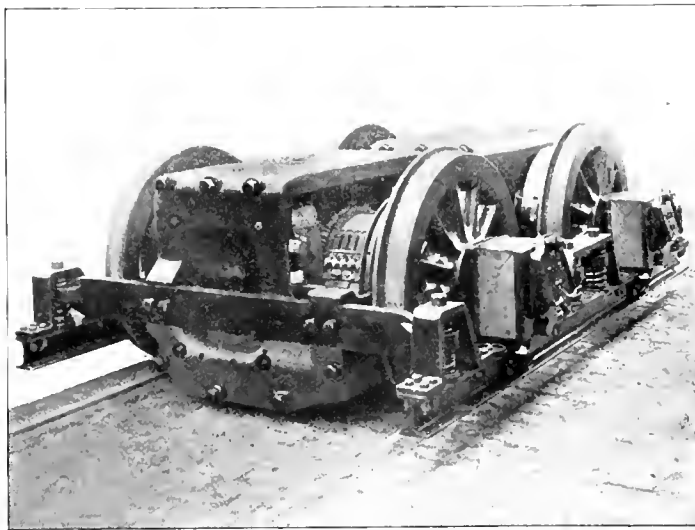

MOTOR TRUCK, ELECTRIC LOCOMOTIVE

through spiral springs, allowing a play of the wheels on an irregular roadbed. These springs have the same mission as the motor cushioning spring on an ordinary

motor truck. The fields are cast iron and the armature coils sunk in mica lined slots. The armature shaft, which is hollow, is connected to the locomotive axle inside of it by a universal coupling. With the series-parallel controller which is used it has been proven that the starting is smoother and the speed more easily regulated than on a steam locomotive. The engineer's cab rests on the heavy I beams of the truck. Air for the brakes is compressed with a pump having a diameter of 6 inches, with a 6 inch stroke and run by a small motor running regularly at 675 a minute. The rheostat governing this motor is automatically regulated by the air pressure. On long

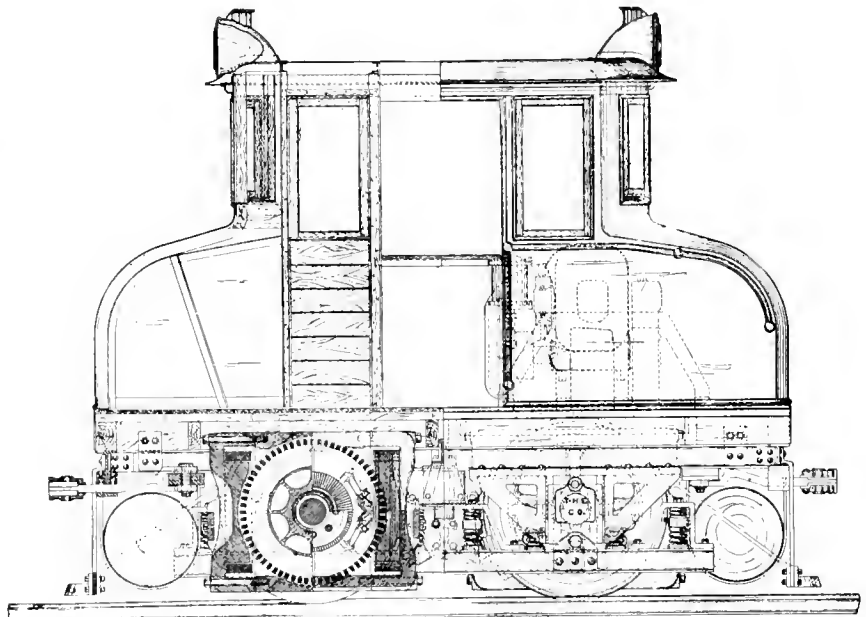

LONGITUDINAL SECTION ELECTRIC LOCOMOTIVE.

lines the cost of overhead copper necessary to run such locomotives is prohibitive in the present state of the art, but for crowded lines in cities where the conditions are most favorable for generating power in large quantities and where noise and dirt are serious objections, the electric motor has an immediate field and will probably come into use in a short time.

THE PIER MOVEABLE SIDEWALK.

AFTER numerous vexations, delays in getting power from the Exposition Company several weeks elapsed after the mechanical arrangements were perfected before sufficient power was turned on to keep the walk moving. About July 1, however, the department at Machinery Hall acquired power enough and since then the walk has been in successful commission.

The successful consummation of the idea is particularly grateful to Max E. Schmidt, who has been untiring in his efforts for its completion and to R. McC. Smith, whose constant attendance and earnest efforts as manager is deserving of particular mention.

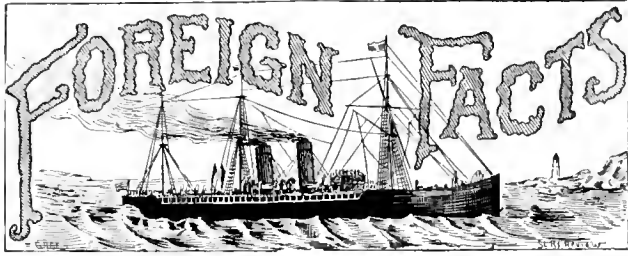

THE tramway power station at Hobart, Australia, is nearly finished.

THE lines at Havre, Lyons and Bordeaux are changing over to electricity.

MILAN is to have an electric railway $3\frac{1}{2}$ miles long, equipped with the Thomson-Houston system.

THE Liverpool Overhead Railway Company are selling tickets at a reduction of ten per cent on amounts over one pound.

THE habit of some English tramways of charging extra fares on Sunday was recently brought before Parliament for action.

THE tramways of Glasgow will in a year's time pass into the hands of the city. The municipality has already placed an order for 200 cars.

THE high price of hay in England at present is making tramway managers feel blue, and may have some effect in hastening the adoption of electricity.

THE Madras (India) Electric Tramways Company has decided to adopt the conduit system. As nearly as can be made out from the descriptions, the conduit used will be a plain open one, similar to a cable conduit.

THE Laurent-Cely accumulators have been at work on some of the Paris tramways since last November. Another line has recently been put in operation between the Opera and St. Denis. About 11 miles are now so worked. The storage battery will be put on all the lines.

IN the tramways-telephone case, Sir Courtenay Boyle says that "at Preston where the electric lighting company's conductors were not sufficiently protected from earthing arcing had taken place, and certainly gas and water pipes had been materially injured, and a very serious accident was narrowly avoided. The water pipes were eaten away by electrolytic action."

THE London Electrical Review, under the head of "Leakage Current from Electrical Tramways," says: "It is generally admitted that the electrical tramway companies never intentionally use the earth as a return. One of the tram lines is generally used, the rails being bonded together with a copper strip or wire in order

to make a continuous length. The question which arises in our minds is whether some improvement might not result by transversely connecting the two rails at intervals with a copper wire. It seems reasonable to assume that there might be some advantage in doing this. Perhaps some of our readers may have had experience in this direction; if so, we should be glad to have their views. On referring to a back number of an American magazine, we find that this plan has been adopted on an American line."

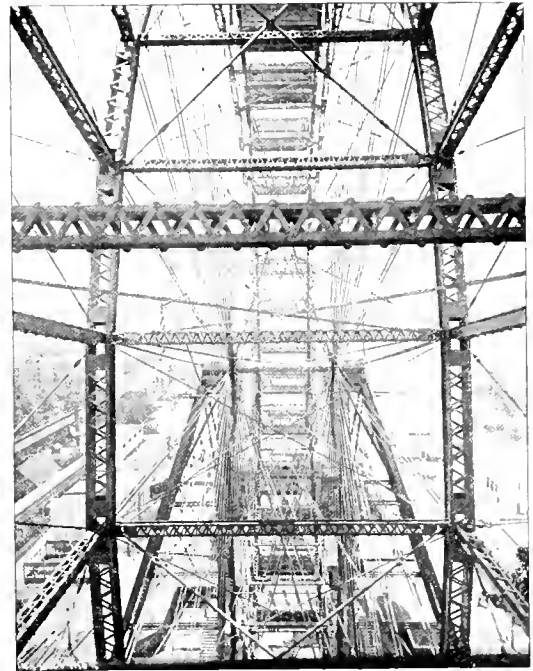

HALF WAY UP IN THE FERRIS WHEEL.

THE above illustration is from a photograph taken from one of the cars of the Ferris Wheel at the moment when the car was half way up. The immense steel shaft is plainly seen, and the girders and braces which form the structure are also clearly shown. The view is taken looking west.



APPROACHING TOP OF WHEEL.

HALF FARES.

Interesting Facts from All Parts of the Country Boiled Down for Busy Readers.

THE Omaha street railway are putting in smoke consumers in compliance with recent smoke ordinance.

THE driving drums of the Broadway cable plant will be enlarged from 12 to 16 feet for higher cable speed.

It is proposed to fit up an electric railway plant as a feature of the electrical engineering course at Cornell.

THE Dartmouth & Westport, Mass., Railway have improvised a tower car for overhead line work out of an old box car formerly used for freight.

A NEW car on the Sixth avenue "L" line, in New York, is said to have such elastic springs as to cause a case of seasickness.

ANOTHER underground conduit railway was tried at Coney Island, June 18. The system is the property of the Universal Electric Company.

It is said Russel Sage is responsible for the absence of smoking cars on the Manhattan L, and that he does not approve of the nicotine vice.

THE water works company at Pueblo, Col., have rented current from the electric railway to operate an electric fountain at the Colorado Mineral Palace.

THE Reading, Pa., Morning Herald, published a profusely illustrated Columbian edition, in which the street railway system of that city received a full page description.

A VERY sensible and proper city ordinance is about to be adopted in Richmond, Va., making it unlawful for funeral processions to take possession of the street car tracks.

THE Pasadena & Mt. Wilson Railway, connecting the city with the summit of the mountain, and fully described in the REVIEW in previous issues, was opened July 1, and is in daily operation.

THE electric road in San Diego, Cal., is about to spend \$75,000 on a park to contain 160 acres, and to be modeled after the famous park in Honolulu, where an engineer is now copying the plans.

THE Chicago & North Shore has opened up the southern portion of its line between Chicago and Evanston. The traffic outlook is very bright. The power house, now nearly complete, is at Edgewater.

THE electric lines of the Chicago City Railway on Sixty-first and Sixty-third streets have been doing a land office business lately. It is no uncommon sight to see one motor car hauling two heavily loaded trailers.

THE Philadelphia Record says of the trolley that "It has been tried for months in a densely peopled section of the city, and under this severe test the dangers to life and property attributed to this system have proven mythical."

THE Electric Railway & Power Company, of Tiffin, O., recently opened up a beautiful pleasure resort called Riverview Park. Streams are made use of in various ways, both to furnish boating and romantic waterfalls and rivulets.

IN New York they have mashers and "glarers." A glarer is a long eared creature which infests the L cars and persistently stares at the pretty girls; which latter want separate cars from which the glarer shall be debarred.

BUSINESS men in Pittsburg are beginning to seriously consider the question of side tracks into their warehouses and wholesale houses, with a view to running freight cars from steam roads at night, over the cable and electric lines.

It is suggested that where tracked streets are paved with sheet asphalt, that the company be allowed to use asphalt blocks outside the rails, or at least at joints. This would very greatly reduce the expense of raising joints and other track repairs.

A. F. ESPERSON, of Seattle, Wash., has invented an indicator for notifying the occupants of houses along the line who may desire it, of the approach of a car, so that they may have time to catch it, and not be obliged to waste time watching for it.

AN odd suit was brought against the Omaha Street Railway, in which a fireman claimed \$15,000 for being required by the engineer to fire the boilers on a day when he was not feeling well. The court decided the company was not responsible for the commands one employee gave another.

THE New England Street Railway Company, capital \$5,000,000, in \$25 shares, now owns the Winchester avenue line, of New Haven, Conn., and also those of Plymouth, Gloucester, Natick, Haverhill and Amesbury. The company's business is to own, operate, purchase, sell and construct street railways.

DUPLICATE cables are being laid in the Broadway line, New York, to guard against any possible accident, and a telegraph system with boxes at intervals of five and six hundred feet will, when finished, enable the conductor to be within easy communication with the power house. A similar system of electric signals has long been in use on the West and North Side lines in Chicago.

A CLEVELAND reporter who appreciates a good thing, and a nine mile ride for five cents, managed to smuggle the following into one of the dailies there: "There is no other city in the country that gives so much oppor-

tunity as Cleveland in this regard, and thousands take advantage of it on warm nights. Street railways may be octopuses and monopolies and all that sort of thing, as corporation counsels call them, but they are splendid things to have about."

ANDREW CARNEGIE thinks it is the "robber baron" who is now being robbed, and names the eighth wonder of the world as the following: Two pounds of ironstone purchased on the shores of Lake Superior and transported to Pittsburg; 2 pounds of coal mined in Connellsville and manufactured into $1\frac{1}{4}$ pounds of coke and brought to Pittsburg; one-half pound of limestone mined east of the Alleghenies and brought to Pittsburg; a little manganese ore, mined in Virginia and brought to Pittsburg; and these $4\frac{1}{2}$ pounds of material manufactured into one pound of solid steel and sold for 1 cent.

THE Broadway cable cars, as predicted in the REVIEW two years ago, are creating a noticeable current in the great procession of vehicles on that street. The Advertiser recounts a recent experience thus:

It gladdens the gripmen, most of whom are old drivers, to see how briskly the teamsters lash their horses and turn sharply out in obedience to the first clang of a cable car bell. There was an almost impenetrable jam of trucks and wagons on Broadway just above Chambers street. Two policemen worked like beavers to break the pack. They made but little progress. Presently a cable car came sailing up Broadway. The gripman rang his gong three or four times about midway of the line of City Hall Park, and without reducing his speed bowled along toward the glut of vehicles. The teamsters were instantly stirred into amazing activity. Those astride the uptown track lashed their horses while roaring at those round about to "get a move on." Horses reared and plunged whips cracked and in a jiffy an aisle was opened for the swiftly approaching car, the gripman of which grinned tantalizingly at the teamsters as he passed them.

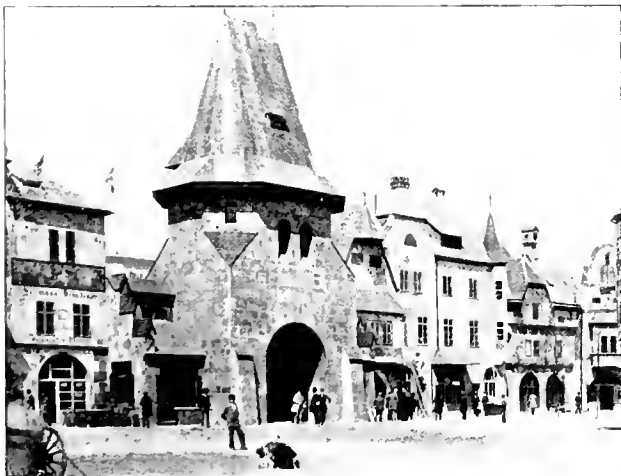

"OLD VIENNA"—MIDWAY PLAISANCE, WORLD'S FAIR.

"TICKET," said the collector, to a holder of an annual pass, who being a frequent rider believed his face so well known as not to require the formality of showing his pasteboard.

"My face is my ticket," replied the dead head.

"Very well," said the conductor, rolling up his sleeves, "my orders are to punch all tickets."

TYPE "G" OVERHEAD MATERIAL.

THE great and increasing popularity of the standard appliances of the Railway Equipment Company, Pullman Building, Chicago, and the reputation of the company for furnishing only the best class of material, makes a description and illustration of such devices of interest to purchasers. During the last five years this company and its predecessors, all under the management

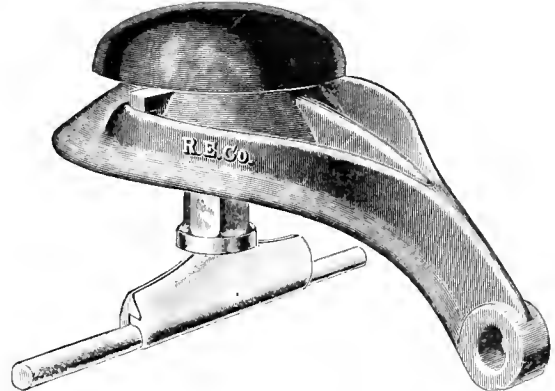

of W. R. Mason, have equipped hundreds of electric roads with the most satisfactory material. The illustrations show the type "G" overhead material, which has been adopted by a large number of the leading electric roads during the last two seasons. It is claimed this material is superior on some accounts to any other now on the market. All of the castings are made of malle-

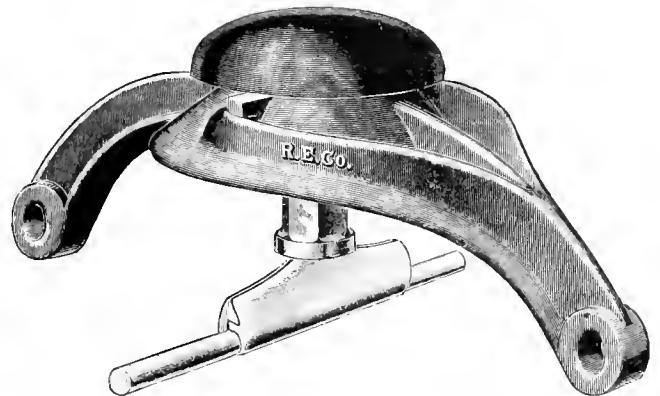

able iron, the Railway Equipment Company being the first to adopt this material. The Chicago clamp is too well known to need any extended description. It is in use from Maine to California, as well as in foreign countries. The insulator is in one solid piece and is an absolute protection against leakage. This advantage is readily appreciated by practical men. The insulating material is the special hard rubber composition adopted by this company several years since, and which has the best insulating and lasting qualities. The type "G" material is also made in bracket and bridge hangers.

GEO. WOODWARD, retiring foreman of the Noble street barn of the West Chicago Street Railway, was presented a handsome diamond ring by his associates. Woodward becomes clerk of the Circuit Court.

CAUGHT ON THE RUSH TRIP.

American Street Railway Association.

D. F. LONGSTREET, PRESIDENT, Denver, Col.
 DR. A. EVERETT, FIRST VICE-PRESIDENT, Cleveland, O.
 JOEL HURT, SECOND VICE-PRESIDENT, Atlanta, Ga.
 W. WORTH BEAN, THIRD VICE-PRESIDENT, St. Joseph, Mich.
 WM. J. RICHARDSON, SECRETARY AND TREASURER, Brooklyn, N. Y.
 EXECUTIVE COMMITTEE—THE PRESIDENT, VICE-PRESIDENTS, and JOHN G. HOLMES, Pittsburg, Pa.; J. D. CRIMMINS, New York City; THOS. MINARY, Louisville, Ky.; JAS. E. CHAPMAN, Grand Rapids, Mich., and BENJ. E. CHARLTON-HAMILTON, Ont.
 Next meeting, Exposition Building, Milwaukee, third Wednesday in October.

Massachusetts Street Railway Association.

President, CHARLES B. PRATT, Salem; Vice-presidents, H. M. WHITNEY, Boston, AMOS F. BREED, Lynn, FRANK S. STEVENS; Secretary and Treasurer, J. H. EATON, Lawrence.
 Meets first Wednesday of each month.

Ohio State Tramway Association.

President, A. E. LANG, Toledo; Vice-president, W. J. KELLY, Columbus; Secretary and Treasurer, J. B. HANNA, Cleveland; Chairman Executive Committee, W. A. LYNCH, Canton, O.
 Meets at Cincinnati on the fourth Wednesday in September, 1893.

The Street Railway Association of the State of New Jersey.

President, JOHN H. BONN, Hoboken; Vice-president, THOS. C. BARR, Newark, Secretary and Treasurer, CHARLES Y. BAMFORD, Trenton; Executive Committee, OFFICERS and C. B. THURSTON, Jersey City; H. ROMAINE, Paterson; LEWIS PERKINS, JR., Trenton.

The Street Railway Association of the State of New York.

C. DENSMORE WYMAN, PRESIDENT, New York.
 D. B. HASBROUCK, FIRST VICE-PRESIDENT, New York.
 JAS. A. POWERS, SECOND VICE-PRESIDENT, Glen Falls.
 W. J. RICHARDSON, SECRETARY AND TREASURER, Brooklyn.
 EXECUTIVE COMMITTEE—D. F. LEWIS, Brooklyn; JOHN N. BECKLEY, Rochester, J. W. McNAMARA, Albany.
 The next meeting will be held at Rochester, September 19, 1893.

Pennsylvania Street Railway Association.

JOHN A. COYLE, PRESIDENT, Lancaster.
 JOHN G. HOLMES, VICE PRESIDENT, Pittsburg.
 H. R. RHODES, SECOND VICE-PRESIDENT, Williamsport.
 L. B. REIFSNIDER, SECRETARY, Altoona.
 WM. H. LANIONS, TREASURER, York.
 Next meeting, Harrisburg, September 6, 1893.

Alabama.

MOBILE, ALA.—Committee of the general council agree to allow the Mobile Street Railway to extend.

Arizona.

PHOENIX, ARIZ.—The Valley Street Railway Company has changed its name to the Phoenix City Company, and increased its capital to \$1,000,000. The directors of the new company are William Christy, B. N. Pratt, H. B. Mitchell, C. F. Ainsworth, George W. Creighton. "The line will be built this summer," says Mr. Pratt.

Arkansas.

LITTLE ROCK, ARK.—Circuit court renders judgments against the City Electric Railway as follows: People's Bank of Paris, Ill., \$15,754; National Bank of Grand Rapids, Mich., \$5,247; First National Exchange Bank of Port Huron, Mich., \$5,000. These were for notes given by the street railway and discounted. All the cases were appealed.

California.

OROVILLE, CAL.—Council repeals F. C. Danforth's railway, power and light franchise.

SAN DIEGO, CAL.—The electric railway is to build a park and summer resort to cost \$75,000.

OAKLAND, CAL.—The board of public works is ordered to tear up certain tracks of the Oakland Consolidated.

LOS ANGELES, CAL.—Geo. L. Bush, Fred Carter, John T. Jarvis, et al., incorporate the Riverside Electric Company at \$100,000, to build an electric railway.

SAN FRANCISCO, CAL.—The Southern Pacific Railway Company wants loop rights at the foot of Market street. This will give the company great advantage over other lines. The matter was laid over one week by the State Board of Harbor Commissioners.

SAN FRANCISCO, CAL.—The S. F. & S. M. R. R. Company suffers a defeat in court, the General Electric Company having obtained every legal sanction to take possession of the machinery in law. President Behrend Joost says that a private assignment has avoided a crisis.

Canada

MONTREAL, CAN.—The Corriveau-Williams syndicate has transferred its franchise and interests to the Montreal Park & Island Company, of which Louis Beaubien is president. Williams, Corriveau, D. A. Smith et al. are stockholders.

Chicago.

CHICAGO.—The Siemens-Halske Company, of America, certifies to increase of capital stock to \$1,000,000 from \$500,000.

CHICAGO.—Marcellus Hopkins has been appointed general manager of the Alley L. Vice W. T. Barnard granted leave of absence.

CHICAGO.—It is said that the North Chicago Street Railway Company will buy the southwest corner of LaSalle avenue and Illinois streets for new shops.

CHICAGO.—A. H. Hill says of the Jefferson Street Railway Company that cars will be running in September.

J. P. MALLETT, of the Englewood & Chicago, says his line will surely be built this year.

Colorado.

PUEBLO, COL.—City Railway may move its fair grounds line as injunction has been dissolved.

COLORADO SPRINGS, COL.—Manitou town council declares M. A. Leddy's franchise illegal and matter was laid on the table.

DENVER, COL.—Denver Consolidated Electric Company brings suit against the Standard Underground Cable Company for \$52,490.88. Claims that a cabled delivered was useless.

DENVER, COL.—The Tramways will sell the Broadway power house and build a new one. The Pearl street addition will extend from Alameda avenue two miles, and connect with the South Tremont line.

DENVER, COL.—Pleasure Resort Railway Company incorporated, to build line through North Denver. Elects officers: President, E. E. Sommers; vice-president, L. F. Kimball; treasurer, C. C. Skiles; secretary, W. Thorn; attorney, F. J. Haugh. Liberal aid is promised.

DENVER, COL.—A floating indebtedness of \$100,000 is to be cleared from the Tramway's books. The present capitalization of \$1,000,000 is 200 per cent above par and it is thought best, therefore, to increase the capital to \$3,000,000. The corporation will thus reorganize. The building will go up soon.

Connecticut.

NORWICH, CONN.—W. A. Larrabee resigns superintendency of the street railway in favor of John Wilcox.

NEW LONDON, CONN.—M. B. Waller resigned June 15 as superintendent of the Horse Railway Company. Mr. Crocker, of Boston, succeeds him.

HARTFORD, CONN.—Hartford & Wethersfield Street Railway Company is authorized to change to electricity, to extend, and increase capital stock to \$1,000,000.

HARTFORD, CONN.—Chartered: Hartford, Manchester & Rockville Tramway Company, with Maro S. Chapman, N. T. Pulsifer, A. D. Claflin, A. J. Wickham, E. C. Hillard, W. H. Prescott, Geo. Maxwell and E. Steves Henry as incorporators. Capital stock is \$200,000.

ENFIELD, CONN.—Incorporated: The Enfield & Longmeadow Electric Railway Company, by Chas. H. Briscoe, John L. Houston, J. Warren Johnson, Joseph N. Allen, Lyman A. Upson, Thompson S. Grant, Benjamin F. Ford, Loren H. Pease, Chas. W. Clark, Geo. B. Fowler, Geo. T. Mathewson and Geo. F. Chapin. The authorized capital is \$30,000, which may be increased to \$100,000.

District of Columbia.

WASHINGTON, D. C.—The Washington & Arlington road will extend. This is the result of the recent litigation.

Idaho.

KENDRICK, IDAHO.—The new tramways scheme to build from Kendrick to the Potlach Ridge will be a farmers road and the cost is estimated at \$4,000.

WEISER, IDAHO.—The Idaho Electric Railway, Light & Power Company files articles of incorporation. To build from Weiser to Seven Devils. H. T. Randall and Ohio capitalists are interested.

Illinois.

ALTON, ILL.—The Alton Electric Street Railway Company will put four new engines in its power house.

ALTON, ILL.—The electric will not probably be built to upper Alton. The old horse line franchise interferes.

BELLEVILLE, ILL.—All franchises of the St. Louis & Belleville Railroad Company are revoked for non-compliance with terms of franchise.

CHILLICOTHE, ILL.—A. H. Reutinger is appointed receiver of the street railway. It is understood that this means completion and betterment of the line.

ALTON, ILL.—Directors of the Alton Electric Railway elect J. F. Porter, vice president and general manager; J. H. White, secretary, and J. G. White, treasurer.

Indiana.

INDIANAPOLIS, IND.—Citizens Street Railway buys cars of the St. Louis Car Company.

INDIANAPOLIS, IND.—Citizens Street Railway Company will build a new power house. Site chosen.

LOGANSFORT, IND.—The Logansfort Street Railway Company increases capital from \$10,000 to \$200,000.

INDIANAPOLIS, IND.—A. A. Anderson, formerly secretary of the Citizens, goes to Cincinnati in the employ of the Johnson's new line.

ELWOOD, IND.—It is proposed to extend the electric line to the Alexandria stone quarries; hauling stone and gravel in addition to passengers.

MICHIGAN CITY, IND.—H. W. Albee, of Chicago, is here looking up the sale of the Automatic Turning Work's boilers for use in the Lake City's power house about to be built.

LA FAYETTE, IND.—La Fayette Street Railway Company gives mortgage to the Real Estate & Trust Company, Philadelphia, for \$225,000, to be used in paying debts and buying equipment.

NORTH VERNON, IND.—The North Vernon & Vernon Street Railway elects directors and the following officers: H. Grinstead, president; L. T. Wilkerson, vice-president; J. C. Cope, treasurer; E. L. Wagner, secretary; S. H. Grinstead, Albert Amick and J. S. Bailey, executive committee.

INDIANAPOLIS, IND.—Citizens Street Railway Company secures important ruling in the franchise case. The decision means that the city had no right to grant a franchise to another company during the charter life of the Citizens' Company, and in so doing the city has violated its contract.

GREENCASTLE, IND.—The Greencastle Street Railway reorganizes. The capital stock has been increased from \$10,000 to \$100,000 and the following directors have been elected: Jesse W. Weik, Frank G. Gilmore, James H. Dietrick, John S. Dowling and Henry C. Lewis. The company proposes to use electric and horse power.

Iowa.

SIoux CITY, IA.—The Cable Company has gone into the hands of a receiver.

CEDAR FALLS, IA.—A street car line from Normal to Cedar Falls is a feasible thing.

CEDAR RAPIDS, IA.—Bids will be received by the city for a large amount of brick paving.

DUBUQUE, IA.—Dubuque Light & Power Company files deed of trust with Old Colony Trust Company, of Boston, to secure \$400,000 bonds, payable in seventeen years, at 6 per cent interest.

IOWA CITY, IA.—Haines Bros. & Tilden, of Kinderhook, N. Y., assure Iowa City through the General Electric that a road will be built here. G. W. Atterbury, representing the Haines Company locally, has just arrived.

FT. MADISON, IA.—Following are new officers for the Street Railway Company: President, D. A. Morrison; secretary, Howell Jones; treasurer, J. C. Brewster; directors, J. B. Morrison, Chas. H. Peters and A. S. Johnson. The president was authorized to communicate with a view to replacing mule power by electric power.

SIoux CITY, IA.—President John Pierce asked that a receiver be appointed for his road, the Sioux City Cable, and Chrys Mohler, former superintendent, was appointed such. The D. T. Hedges failure, and inability to realize on bonds, resulted in the failure. Since the start the road has lacked \$75,000 for paying operating expenses.

Kansas.

JUNCTION CITY, KAS.—Chas. C. Adams, Kansas City, agrees to put in railway and light system here on fair terms.

KANSAS CITY, KAS.—General Manager Clark, of the West Side, says he will have the West End extension ready in a few days.

Kentucky.

LOUISVILLE, KY.—The Louisville Steam & Electric Motor Company, burned some time ago, winds up its affairs. The stockholders will realize 50 cents on the dollar.

Louisiana.

NEW ORLEANS, LA.—The stockholders of the Crescent City Company agree to the merger with the New Orleans Traction Company.

NEW ORLEANS, LA.—The Crescent City Railroad Company make transfer of stock to the New Orleans Traction Company amounting to a merger. Mr. Littell presided at the meeting.

Maine.

FAIRFIELD, ME.—A. F. Gerald, of this place, is making preparations for building his new lines at New Brunswick, Calais and Mt. Stephens. A bridge is to be built by the towns interested.

Massachusetts.

HOLBROOK, MASS.—Parties holding franchise in Braintree ask for rights here for line.

SPRINGFIELD, MASS.—The street railway companies will be compelled by the city to use fenders.

WORCESTER, MASS.—The Consolidated Street Railway Company ask for a belt line, which will probably be granted.

ATTLEBORO, MASS.—H. M. Daggett, Jr., has bought the majority or stock of the Attleboro, North Attleboro & Wrentham Street Railway Company.

NEWTON, MASS.—The Newtonville & Watertown Street Railway Company elects the following officers: President, George W. Morse; treasurer, James W. French; clerk, John C. Lane. It is said this list will finish the construction and resign. It is thought the line will then be absorbed by the Newton & Boston.

NEWBURYPORT, MASS.—The People's Street Railway Company to build line from Newburyport to West Newbury elects officers, president, F. S. Car, West Newbury; clerk, F. W. Noyes, West Newbury; treasurer, H. O. Delano, Merrimac; directors, F. S. Carr, West Newbury; H. O. Delano, Merrimac; J. S. Payne, Amesbury; Thomas Smith, O. G. Chase, F. W. Noyes.

HAVERHILL, MASS.—Haverhill, Groveland & Merrimack Valley Railways go out of existence by combination with the Lawrence, Lowell & Haverhill Company. N. E. Norton will take the management of the Lawrence division and Franklin Woodman of the Haverhill lines. President Campbell will be general manager, M. J. Ellard, assistant treasurer, and H. E. Abbey is in charge of the accounts, and G. E. Tripp is the auditor of the company.

Maryland.

FREDERICK, MD.—Loren N. Downs, New York, has been elected president; Dr. Upton Sharretts, of Frederick, vice-president; Edgar L. Miller, of Frederick, secretary, and C. V. S. Levy, of Frederick, attorney of the Frederick & Middleton Electric Railway. It is expected that ground for the new road will be broken in about ten days.

Michigan.

DETROIT, MICH.—W. H. Wells, as attorney for Hugh McMillan, buys the Detroit Electrical Works for \$1,000,000.

BENTON HARBOR, MICH.—Public meeting decides against street lighting by the Street Railway Company. No car track extensions will be made either, consequently.

DETROIT, MICH.—Fort Wayne & Belle Isle Street Railway elects directors: E. H. Butler, E. S. Heineman, Seligman Schloss, D. M. Ferry, D. Whitney, Jr., N. W. Goodwin and F. G. Russell.

BATTLE CREEK, MICH.—The Citizens Electric Company's board of directors elected the following officers: President, Frank Turner; vice-president, W. H. Mason; secretary, Joel Hopkins; treasurer, Fred A. Alward.

Minnesota.

MINNEAPOLIS, MINN.—The Street Railway Company will build a \$6,000 car barn at Lake Harriet.

WINONA, MINN.—The Street Railway Company will extend track to Gilmore Valley. The bonus asked by the company has been raised. Supplies to be bought.

Missouri.

ST. LOUIS, MO.—The Union Railway Company begins running electric cars. The line is owned by the Hamilton syndicate.

KANSAS CITY, MO.—The superintendent of the Metropolitan, Walter Gillam, has been promoted to the position of general purchasing agent for the Metropolitan system. H. H. Rogers is made general manager and Chas. Cobleigh retains position of assistant superintendent of the Elevated.

KANSAS CITY, MO.—The General Electric has transferred the Vine Street Electric Railway to the South Suburban Railway Company, which latter has filed a certificate of increase of stock from \$100,000 to \$150,000.

The Central Tramways Company, recently incorporated with Robert Gillam as principal, has secured right of way on several valuable streets.

ST. JOSEPH, MO.—St. Joseph Traction & Lighting Company has its contemplated improvements under way. General Manager VanBrunt has placed several supply orders and will place more.

Montana.

HELENA, MONT.—Closed car burned by a short circuit; loss, \$4,000; insurance, \$2,500.

BOZEMAN, MONT.—W. E. Hale, of Minneapolis, attorney for the receiver of the street railway, says that affairs are in good shape and that the contemplated improvements may be made after August 1.

Nebraska.

FREMONT, NEB.—Fremont Street Railway Company sells franchises and property to Frank Fowler, for \$3,160, or less than half value.

LINCOLN, NEB.—Organized: The City Street Railway, by K. N. Morse, Fred Meyer and Frank Fowler. The paid up capital is \$45,000.

BEATRICE, NEB.—Frank Oakley is elected to succeed G. M. Johnson, resigned, as general superintendent of the Rapid Transit & Power Company.

New Hampshire.

MANCHESTER, N. H.—General Williams says that after a thorough investigation at the coming Milwaukee convention he will invest in considerable supplies. An electric line will be installed.

New Jersey.

ASBURY PARK, N. J.—Vice Chancellor Pitney, of New Jersey, grants injunction prohibiting the operation of the Asbury Park & Belmar Railway.

NEWARK, N. J.—David Young, general manager of the Consolidated, is already at work preparing to reconstruct and re equip. About \$2,000,000 will be spent in and about Newark.

NEWARK, N. J.—The Consolidated Traction Company (Crimmins' syndicate) has gained control of the Newark Passenger Railway Company, gaining thus control of the New Jersey roads.

JERSEY CITY, N. J.—The Passaic Elevated Transit Company of Hudson county incorporates at \$2,000,000 for an elevated from Jersey City to Newark. Farmers' Loan & Trust Company of New York loans \$2,000,000 on mortgage.

BRIDGETON, N. J.—The directors of the Bridgeton & Millville Turnpike Company, the Bridgeton Rapid Transit Company, and the South Jersey Traction Company consolidate as the South Jersey Traction Company. At a meeting of the company George Wood, president of the Millville Cotton Manufacturing Company, was made president; Richard W. Clay, vice-president; and Walter H. Bacon, of Bridgeton, secretary and treasurer.

New York.

POUGHKEEPSIE, N. Y.—The Waddell-Entz storage battery traction will be tried here.

JAMESTOWN, N. Y.—The Street Railway Company is granted franchise for extensions on several streets.

GLEN FALLS, N. Y.—Glen Falls, Sandy Hill & Ft. Edwards Electric Street Railway increases capital from \$120,000 to \$150,000.

BUFFALO, N. Y.—Edward Edwards, for thirty years superintendent of the street railway, has resigned. A. J. Porter, his assistant, succeeds him.

NEW YORK, N. Y.—John D. Crimmins declines re-election as president of the Houston, West Street & Pavonia Ferry Railway Company.

ILLION, N. Y.—Mohawk & Illion Street Railway elects C. W. Carpenter, vice-president; R. M. Devendorf, treasurer; H. D. Alexander, secretary.

BUFFALO, N. Y.—M. L. Failing, J. G. Taylor, M. Hoag, and J. A. Kuck, of Buffalo, organize the Niagara Electric Railway Company, to build between Pekin and Lewiston.

KINGSTON, N. Y.—The Colonial City Electric Railway Company has been incorporated with \$175,000 capital, for the purpose of building a railroad six miles long in Kingston.

AMSTERDAM, N. Y.—J. H. McClement, president of the Amsterdam Street Railway Company, and J. Seaver Page, of New York, think of extending the Amsterdam road to Groversville, twelve miles.

LOCKPORT, N. Y.—Prominent citizens of Lockport will incorporate to build road from Williamsville to Lockport to cost \$100,000. Those probably interested are Mayor Darrison, W. B. Hall, A. C. Hall and others.

SYRACUSE, N. Y.—The new officers of the Syracuse, Fayetteville & Manlius are: President, R. R. Spaulding; vice-president and general manager, E. W. Emmons; treasurer, C. B. Freeman; assistant secretary, M. J. Ostrander.

GLEN FALLS, N. Y.—The Street Railway Company has had a proposed branch road surveyed from Fountain Square to South Glen Falls, and the branch will probably be constructed within a few months.

ITHICA, N. Y.—Cayuga Lake Electric Company is incorporated for fifty years life. The principal holders are Alfred Hand, Scranton, Pa., Dr. F. Van Vleet, Ithica; Henry S. Hand, Brooklyn, N. Y.; H. E. Hand, Scranton, Pa. Capital stock, \$50,000.

ALBANY, N. Y.—Consolidated Car Heating Company reduces stock from \$2,500,000 to \$1,250,000 and elects Robert C. Pruyn, president; Daniel D. Sewall, vice-president; William G. Rice, treasurer; Edward A. Groesbeck, secretary; James F. McElroy, consulting engineer; Jas. H. Sewall, superintendent of construction.

HOOSIC FALLS, N. Y.—Incorporated: The Hoosic Railway Company, to construct an electric railroad about four miles in length, from the Fitchburg railroad station in the village of Hoosic Falls, through the village streets to Walloomsac; capital, \$60,000. Directors: G. C. Moses and F. H. Twitchell, of Bath, Me.; William Holmes, Joseph Buckley, S. D. Locke and others, of Hoosic Falls.

MIDDLETOWN, N. Y.—Incorporated: The Middletown-Goshen Traction Company, for constructing a street surface railroad in Middletown, about ten miles in length; capital, \$100,000. Directors: B. F. Low and A. D. Seaman, of Middletown; E. G. Wrightman, S. W. Roberts, W. B. Rockwell, M. J. Wightman, F. W. Bleckley, and B. H. Throop, of Scranton, Tenn.; and Samuel Harris, of Cleveland, Ohio.

GLOVERSVILLE, N. Y.—The transfer of the Webb Littaner interests in the Fonda, Johnstown & Gloversville road combines the steam and electric lines. The headquarters will still be at Gloversville. The new directors have elected as officers of the road: President, Hon. James Shanahan, Tribes Hill; vice-president, James P. Argersinger, Johnstown; treasurer, J. L. Hees; secretary, George M. Place, Gloversville. Lawton Caten has been appointed superintendent in place of R. T. McKeever, resigned. Headquarters will remain at Gloversville.

POTSDAM, N. Y.—Incorporated: The Racket River Railway Company, to construct a standard gauge road about twenty miles in length, to be operated by steam or electric power, from Potsdam to and through the village of Pierpont to the village of Colton, with a branch at or near Hannawa Falls to Parrishville, in St. Lawrence county; capital, \$350,000; directors, W. Wyckham Smith, William Wills, Foster L. Backus, A. L. Chatterton and George R. Crossley, of Brooklyn; Russell L. Kinsay, of Buffalo; Frank E. Bennett, of Topeka, Kas.; J. L. Ludwig and A. R. Dodge, of New York City.

Ohio.

WARREN, O.—Phoenix Iron Works have sold another engine to the Trumbull Electric road.

CINCINNATI, O.—The Mt. Auburn Cable Railway makes application to open certain streets for loop.

PORTSMOUTH, O.—The Portsmouth Street Railway & Light Company is incorporated at \$125,000.

DAYTON, O.—The city council gives the Traction Company a fifty-year franchise, putting affairs on a good basis.

CANTON, O.—It is stated that the Pennsylvania Railroad will build another interurban to Massillon and other towns.

LIVERPOOL, O.—Al. Johnson, of Cleveland, is making improvements on the Liverpool-Wellsville line and will make more.

CINCINNATI, O.—D. J. Hauss has invented a new electric motor. It is to be used on the Mt. Auburn Inclined Plane Railroad.

CINCINNATI, O.—The Consolidated has seven franchises under preparation to ask that all horse lines may be changed to electricity.

NILES, O.—Mineral Ridge & Niles road will elect officers and plan extensions July 10. W. T. Williams, president, and H. C. White, secretary.

CHILLICOTHE, O.—A. H. Reutinger is appointed receiver of the Street Railway Company at suit of the Western Electric Company vs. Geo. F. Woolston.

CINCINNATI, O.—Mt. Auburn Cable road has failed to take up its semi-annual coupons, due to the tight money market and late power house fire.

NORWALK, O.—Norwalk, Lawfield & Southern Street Railway Company, president, Hon. J. A. Williamson, hopes to begin building in the near future.

CINCINNATI, O.—The Cincinnati, Covington & Newport Street Railway and the Covington & Cincinnati Suspension Bridge Company have consolidated.

PIQUA, O.—Col. W. P. Orr, of Piqua, and A. P. Beebe, of New York, are completing arrangements for extending the street railway line to Sidney from Piqua.

DAYTON, O.—Barney & Smith Company intend to begin to manufacture street cars immediately. They are already steam car builders, but will enlarge their plant.

WARREN, O.—The Youngstown & Ohio River Railway has elected officers as follows: President, C. H. Smith; secretary, R. W. Tayler; treasurer, K. E. Barringer.

SPRINGFIELD, O.—Wayne Neff and Mr. Hafner, both of Cincinnati, have secured right-of-way between Xenia and Springfield for their electric line. Will build at once.

AKRON, O.—The commission appointed for the purpose will not give franchise to existing companies but will advertise for bids. The citizens along the route will petition for a line.

CANFIELD, O.—Youngstown & Canfield Electric road elects, president, Judge Jos. R. Johnston; vice-president, Samuel Ewing; treasurer, Alex. Dickson; secretary, J. Cal Ewing.

TOLEDO, O.—T. P. Brown says that he will build road to Maumee over private right of way if he cannot gain franchise and unless Mr. Lang takes advantage of his recently acquired rights.

CLEVELAND, O.—Geo. Anderson, of Detroit, and D. R. Cook, Hastings, Mich., will build an electric railway to Chippewa Lake. Both are good railway promoters and will probably make a go of the affair.

CINCINNATI, OHIO—Stockholders of the Mt. Lookout, Pendleton & E. Walnut Hills consolidated with the Delta Station & Mt. Lookout Dummy line. John Kilgour owns dummy line and will electrify the system.

CLEVELAND, O.—Cleveland City Railway Company decided June 7, to let contracts for new engine, generator and boiler and six more cars, new transfer system to be introduced, offices to be removed to the Cuyahoga building.

SANDUSKY, O.—The Sandusky, Milan & Huron Electric Railway elects the following board of directors: H. Gilcher, J. L. Hull, J. D. Parker, T. B. Taylor, J. C. Gilchrist, Henry Kelley, Geo. H. Dewitt, John Whitworth, J. T. Mack, Valentine Fries, (Milan), W. H. Price, (Norwalk), S. E. Crawford, (Norwalk).

CLEVELAND, O.—Cleveland Crosstown Railroad Company organizes at \$10,000. The incorporators are Sidney H. Short, Jotham Potter, L. A. Russell, Wm. C. Scofield and Geo. F. Scofield. West Side & Gordon Park Street Railway Company is incorporated by Wm. C. Scofield, Chas. W. Scofield, Geo. F. Scofield, Sidney H. Short and L. A. Russell.

CINCINNATI, O.—Lee H. Brooks, Jos. Rawson and J. W. Dawson have organized a stock company to manufacture steam and street railway rolling stock on the plan of the Michigan Car Company. The new company is to be called the Columbian Car Works and is stocked at \$1,500,000.

John Kilgour, president, and J. A. Collins, secretary of the Cincinnati Street Railway Company, enter certificate to increase of capital stock from \$6,750,000 to \$10,000,000.

Pennsylvania.

NEW CASTLE, PA.—J. C. Whittle, of Beaver Falls, buys the electric lines for \$600,000. Will buy supplies.

COLUMBIA, PA.—A. J. Kaufman is president and J. W. Yocum treasurer of the Columbia & Washington Street Railway Company. Work will begin October 1.

PHILADELPHIA, PA.—The Philadelphia Traction Company votes to increase stock from \$7,000,000 to \$9,000,000. This is to meet expense of change to electricity.

EAST HARRISBURG, PA.—Stockholders of the East Harrisburg Street Railway Company will meet August 21 to vote on increase of capital from \$500,000 to \$1,000,000.

CHESTER, PA.—Charter is granted William Henry Sayen, Joseph R. T. Coates, Frank Fennimore, Samuel S. Kent, Jesse M. Baker, and James S. Austin, for electric railway from Chester to Upland, and other points.

TYRONE, PA.—The Tryrone Electric Street Railway elects president, Dr. G. W. Burket; secretary, M. S. Falck; directors, Dr. G. W. Burket, M. S. Falck, A. A. Stevens, H. L. Sholly, S. B. Templeton, James Pritchard, W. F. Wise.

PITTSBURG, PA.—Mayor McKenna has signed the Homestead & Pittsburg Street Railway ordinance, the Central Traction ordinance and the Highland & Schenley park ordinance. He has withheld his signature from the Bloomfield railroad ordinance.

YORK, PA.—York & Dallastown Street Railway Company organized at \$60,000 capital by William H. Lanus, John W. Steacy, Logan A. Marshall, Grier Hersh and Frank Geise, Esq., all of this city. The line will be six miles long. No equipment yet bought.

PITTSBURG, PA.—Chartered: Pittsburg, Crafton & Mansfield Street Railway Company, capital \$500,000. The officers are: President, John C. Reilly; directors, Thomas S. Bigelow, John C. Reilly, William J. Burns, J. D. Callery, W. J. White, Pittsburg. The road will be ten miles long and will be operated by electricity.

PHILADELPHIA, PA.—The Germantown Passenger Railway Company elects the following board of officers: President, Collins W. Walton; secretary and treasurer, Joseph Koch; directors, Collins W. Walton, Meyer Siedenbach, Clarence B. Moore, William Duller, Samuel H. Jorden, Martin V. Burton.

YORK, PA.—The York County Electric Railway elects the following officers: Adam F. Geesey, president; Charles C. Frick, treasurer, and W. F. Bay Stewart, I. W. Allen, Harry K. Weiser, H. W. Heffener, Dr. I. C. Gable, J. E. Schall, S. S. Flinchbaugh, Adam Kohler, Dallastown, and Wm. H. Peters, Dallastown, as directors. The York & Dallastown road elect W. H. Lanus president and Frank Geise secretary. Both companies are after the right of way.

Tennessee.

NASHVILLE, TENN.—The United Electric loses its shops and car sheds by fire; loss \$10,000.

LYNCHBURG, TENN.—J. L. Murphy, agent for a construction company, addresses citizens on behalf of an electric railway.

NASHVILLE, TENN.—On July 20, M. S. Buckingham, trustee, will sell the East End Street Railway Company to the highest bidder.

Texas.

WACO, TEX.—Waco Electric Street Railway Company is about to issue bonds to the amount of \$300,000; of this \$200,000 will be used to retire old bonds and \$100,000 to betterments.

SAN ANTONIO, TEX.—Wanted: A thoroughly competent electrician and machinist to take charge of our mechanical and electrical department. None but a first class man need apply. Salary satisfactory. Address "Machinist," care STREET RAILWAY REVIEW.

Utah.

OGDEN, UTAH.—The Ogden Electric Railway Company files papers against the City of Ogden, asking \$10,000 damages, incurred by the paving commissioner tearing up plaintiff's tracks.

MT. PLEASANT, SANPETE COUNTY, UTAH.—The Mt. Pleasant Electric Light Company is now organized and will furnish light and power for the town of Mt. Pleasant. L. J. Jordan will be president; Wm. Zabriskie, vice-president; W. D. Candland, secretary, and Alif Erickson, treasurer. These and James Larson form the board of directors.

Vermont.

BURLINGTON, VT.—Vice president Powers says that the electric will be running in six weeks. The General Electric has the contract for electrical work.

Washington.

SEATTLE, WASH.—Ranier Electric Railway & Power Company and the Seattle Consolidated, of which D. T. Denny is principal stockholder, is in the hands of a receiver with assets much larger than liabilities.

TACOMA, WASH.—It is reported that J. H. Cummings, formerly superintendent of the Tacoma Railway & Motor Company, is about to undertake building a competing system here backed by Chicago capitalists.

West Virginia.

WHEELING, W. VA.—Two ordinances to extend the street railway system are killed in the council.

Wisconsin.

MILWAUKEE, WIS.—Capt. Pabst is allowed to lay steam and electric supply pipes on various streets.

EAU CLAIRE, WIS.—One of the Eau Claire Street Railway barns burns with contents and two cars. Loss \$6,000.

MILWAUKEE, WIS.—The Hinsey line is bought by Chas. E. Pfister at receiver's sale for \$200,000. To be sold to the Consolidated by Pfister.

SAN ANTONIO, TEX.—President W. H. Weiss says the San Antonio Street Railway is in the market for one each of the following: 26 inch lathe (engine, 10 feet long; 12-inch shaper with milling attachment; 24-inch power drill; 12-inch double tool emery grinder; 25 feet of 2-inch shafting with hangers, boxes, and pulleys to run the above. All the above tools to be furnished complete with counter shafts and hangers, also one combination lathe chute to take in work 12 inches in diameter.

PATENT OFFICE GOSSIP.

THE past month's patent record has been noticeable for the large number of patents granted on trolleys and overhead devices. The first one of these is No. 498,776, an already rather well known device for holding

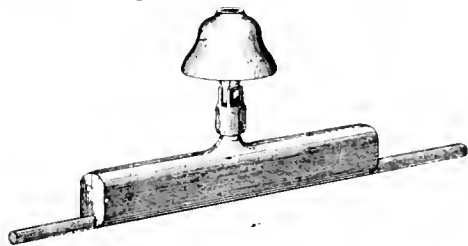

No. 498,776.

trolley wires, having two halves held together by dovetailed grooves.

OUR illustration of the "Trolley wire finder," No. 499,095, explains

itself. It is intended to help the nervous conductor find the wire. The forks which extend up and out for some distance from the wheel are normally in the position shown by the dotted line and when the trolley is off the wire and is being held down by the rope, the finding fork is up

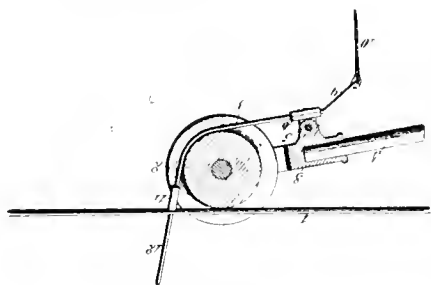

No. 499,095.

where it is of use in guiding the wheel to the wire.

No. 499,112 presents some rather interesting and peculiar features. As shown in the illustration Mr. Henry would make the guard wires help the ground return circuit. For this he connects the guard wires to earth at every pole. These wires, doing double duty as guard and

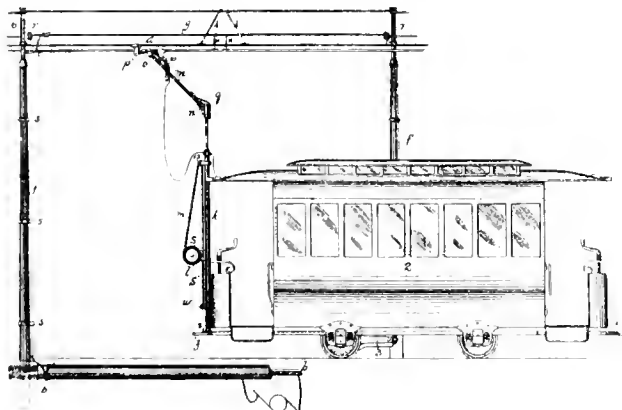

No. 499,112.

return wires, are three in number, one above and one on each side of the trolley wire. This triple arrangement lessens the danger of short circuits between guard and trolley. The guard wires being necessarily the same potential as the earth, are of course made safe.

THE trolley wire support, No. 499,143, the details of which are shown, is arranged to break the connection of any fallen trolley wires with the balance of the line. One half of the hanger only makes connection with the other when the trolley line is straight, as it is when in normal condition. It would be impossible to have live wires on the street with such hangers, but the expense and inconvenience would in most cases prohibit it.

No. 499,805 is a system of automatic electric signals, whereby an electric line crossing a railroad is notified of approaching trains. The signals are normally at danger an essential quality of practical signal systems of this kind.

No. 499,812 is a very simple device, whereby the taking up of the slack in the brake chain of a car is made to lower a tender, the supposition being that a fender is generally needed when the brake is being applied

No. 499,943 is a trolley wire hanger in which the wire is slipped in from above, a form not without advantages as to strength, and certainly not more cumbersome than many present hangers.

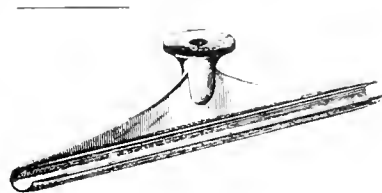

No. 499,943.

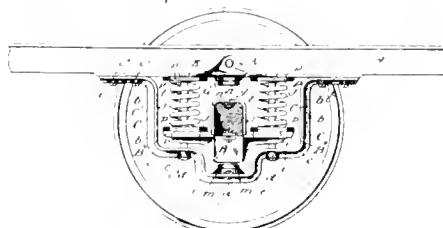

No. 500,129.

No. 500,129 is a very neat form of truck, patented by Moses G. Hubbard, of this city.

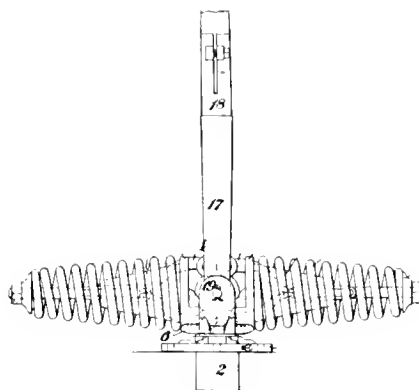

No. 500,263.

THE next thing in the trolley line is a trolley base, No. 500,263. The outer ends of the springs are attached by flexible connections to the pole socket as indicated by the dotted lines.

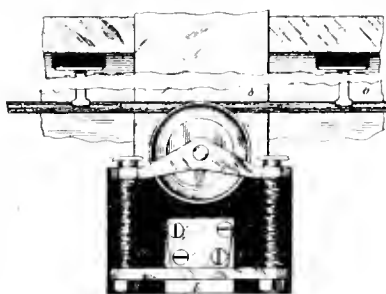

No. 500,306.

A TROLLEY for use in conduits, which may some day be in demand, is No. 500,306. It is built on the principal of some street car trucks.

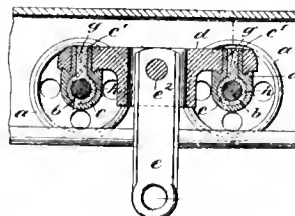

No. 500,375.

ANOTHER trolley on the "double truck" principle is No. 500,375. It is downward pressing, and the likeness to barn door wheels is striking. The patent also covers means for lubrication as shown.

No. 500,488 was included in this list because it might become a factor in the solution of the problem of the electrolysis of pipes.

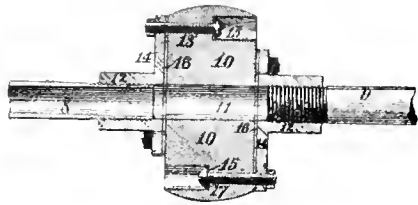

No. 500,488.

STREET RAILWAY PATENTS.

Selected list of patents relating to Street Railway Inventions, granted during the past thirty days, reported especially for the STREET RAILWAY REVIEW, by Munn & Co., Patent Attorneys, 361 Broadway, New York, N. Y.

{ ISSUED JUNE 6, 1893.

- Clamp for electric conductors, Axel H. Englund, Chicago, Ill. 498,776
- Street rail cleaning brush, James A. Gowans, Toronto, Can. 498,785
- Closed conduit for electric railways, Chas. J. Kintner, New York, N. Y., assignor one-third to Gustav Stahl, Philadelphia. 498,852
- Conduit railway trolley, Michael H. Smith, Halifax, England. 498,906
- Trolley stand, James R. Griffith, Chicago, Ill. 498,932
- Electric railway trolley, James R. Griffiths, Chicago, Ill. 498,933
- Cable railway apparatus, William T. Smith, Baltimore, Md. 499,048
- Railway rail joint and fastening, Parker P. Smith, Jeannett, Pa. 499,049
- Trolley wire finder, James Case, Rochester, N. Y. 499,095
- Overhead electric railway, John C. Henry, New York, N. Y. 499,112
- Electric railway trolley, George W. Hooper, Rochester, N. Y., assignor by direct and mesne assignments of three fourths to John A. Stewart, Jas. S. Baker and Alfred Green same place 499,115
- Trolley wire support, Carl Peterson, Brooklyn, N. Y. 499,143
- Railway chair, Frederick C. Weir, Cincinnati, O. 499,154
- Automatic signal for street railways, Jacob G. Hartman and Elijah Baker, Baltimore, Md. 499,163
- Automatic signal for street railways, Jacob G. Hartman and Elijah Baker, Baltimore, Md. 499,164
- Trolley-wire curve, R. M. Hunter, Philadelphia, Pa., assignor to the Thomson Houston Electric Company, of Connecticut. 499,167
- Friction clutch for electric motors, Olof Dahl, Paterson, N. J., assignor to the Dahl Electric Company, of New Jersey. 499,183

ISSUED JUNE 13, 1893.

- Safety support for trolley wires, Hiram K. Whitner, Chicago, Ill. 499,270
- Electric switch, Jas. F. McElroy, Albany, N. Y., assignor to the Consolidated Car Heating Company, of Wheeling, Va. 499,363
- Conduit electric railway, William R. DeVoe, Shreveport, La. 499,374
- Overhead trolley wire switch, Rudolph M. Hunter, Philadelphia, Pa., assignor to the Thomson-Houston Electric Company, of Connecticut 499,461
- Gearing for electric railway cars, John C. Henry, New York, N. Y. 499,633
- Trolley wire hanger, Chas. E. Elliott, Boston, Mass., assignor to the Revere Rubber Company, same place. 499,662

ISSUED JUNE 20, 1893.

- Crossing device for street car tracks, Hugh Shay and Edward Keating, Detroit, Mich. 499,759
- Electric railway grade crossing device, Joseph B. Stewart, Haverstraw, assignor one-third to Joseph P. Bradfield, Syracuse, N. Y. 499,805
- Car fender, Joseph N. Wiczorek, Boston, Mass. 499,812
- Trussed trolley board for electric cars, Henry Cochran, Chester, Pa. 499,871
- Safety attachment for street cars, Louis E. Dubois, Toronto, Canada 499,910
- Trolley wire hanger, Lorenz Spillman, Columbus, O. 499,943
- Closed conduit for electric railways, John C. Henry, New York, N. Y. 500,065

- Electric railway trolley, John C. Henry, Westfield, N. J. 500,070
- Electric railway system, Chas. J. Reed, Orange, N. J., assignor one-third to Gustav Stahl, Philadelphia, Pa. 500,104

ISSUED JUNE 27, 1893.

- Car truck, Moses G. Hubbard, Chicago, Ill. 500,129
- System for supplying electricity to railways, Michael H. Smith, Halifax, England. 500,256
- Trolley support, William Duncan, Allegheny, Pa. 500,263
- Conduit railway trolley, Ernest P. Warner, assignor to the Western Electric Company, of Illinois. 500,306
- Construction of permanent ways for railways or tramways, Jonathan E. Billups, Cardiff, England. 500,366
- Trolley, William H. Brodie, Brooklyn, N. Y. 500,375
- Rail joint, Frederick H. Heath, Minneapolis, Minn., assignor to the Heath Rail Joint Company, Waterloo, Ia. 500,388
- Rail joint, Frederick H. Heath and Edward P. Caldwell, Minneapolis, Minn., assignors to the Heath Rail Joint Company, Waterloo, Ia. 500,389
- Rail joint, Frederick H. Heath and Edward P. Caldwell, Minneapolis, Minn., assignors to the Heath Rail Joint Company, Same place 500,390
- Automatic disconnecter for trolley wires, Ray N. Noyes, Haverhill, Mass. 500,417
- Auxiliary car motor, William H. Schalliol, Chester, Pa. 500,432
- Automatic circuit breaker, Alexander Wurts, Pittsburg, Pa., assignor to the Westinghouse Electric & Manufacturing Company, same place 500,456
- Insulating device for preventing electric currents in pipes, Simeon D. Gratiaa, St. Louis, Mo., assignor to the Fay Gas Fixture Company, same place 500,488
- Inclosed conductor for electric railways, John A. McGregor, Chicago, Ill., assignor one-fourth to Homan R. Powers, same place 500,506
- Brake handle, Samuel A. Burns, Bridgeport, Conn. 500,529



IN THE ALPS.

FRIEND.—“Try to hang on for another couple of minutes. The guides will soon be here with ropes to rescue you.”

JARLEY (who has fallen over the cliff, and is hanging on to a little ledge with one hand).—“All right, old boy. I can stand it. I haven’t traveled from the Battery to Harlem hanging on L road straps for ten years for nothing” (resumes reading his paper).—Harper’s Weekly.

MILWAUKEE'S PALACE—HOTEL PFISTER.

The Street Railway Convention of 1893 Will Stop at One of the Most Complete and Elegantly Furnished Hotels in the World.

WHEN the street railway man takes his annual vacation in October, and makes the meeting of the American Street Railway Association a part of the event, he leaves behind all the care and worry to which he must so soon return, and for a few brief days thoroughly enjoys the best there is in life. It is quite natural, therefore, that the question of where he will stop during convention becomes a matter of personal interest, and the selection is made after determining what is the very best.

made the chief attraction and surpass this, but it is safe to say there is not another marked by such uniformity of excellence and in which such unity has been preserved throughout construction, equipment, furnishing and finishing.

The structure is substantial and genuine from the base-ment to the roof. Nothing about it has been neglected or slightly done, and not a feature has been omitted which might add to the comfort, safety or entertainment of the guests.



HOTEL PFISTER—MILWAUKEE. OPENED MAY 1, 1893.

The Street Railway Association has put up at some pretty nice hotels during the course of its twelve years of existence, and some of them are admittedly hard to beat. But this year Milwaukee has provided a hostelry which is justly entitled to rank among the best in all the world: in fact, it shares with only one other the claim of being the finest on this continent. There are some larger, it is true, although the Pfister is no ordinary sized building, and its eight stories tower majestically above the surrounding buildings, and its favored location admits of abundant light and air on all sides. There are also a few hotels in which some one or two special features are

Rarely has so good taste been shown in the furnishings and decorations of a house as is at once noticeable here. That much-abused word, "elegant," is the one which can be most appropriately used in describing the hotel. Everything, from the lobby up through the building to the magnificent dining hall, is suggestive of elegance and still suggestive of comfort. Yet so unobtrusive are the rich decorations and furnishings, so quiet in their character, no feature seems to be conspicuous or over-done. There are furnishings and decorations on every floor between the lobby and the dining hall that appeal to the artistic sense and which deserve study, but

one is conscious only of the general pleasing effect. If it is the highest art to conceal art, then the highest art

all sides, and would be a noticeable building in any city. The imposing portico, with its enormous granite pillars and heavy stone frieze on the Jefferson street side, is one of the striking features of the exterior.

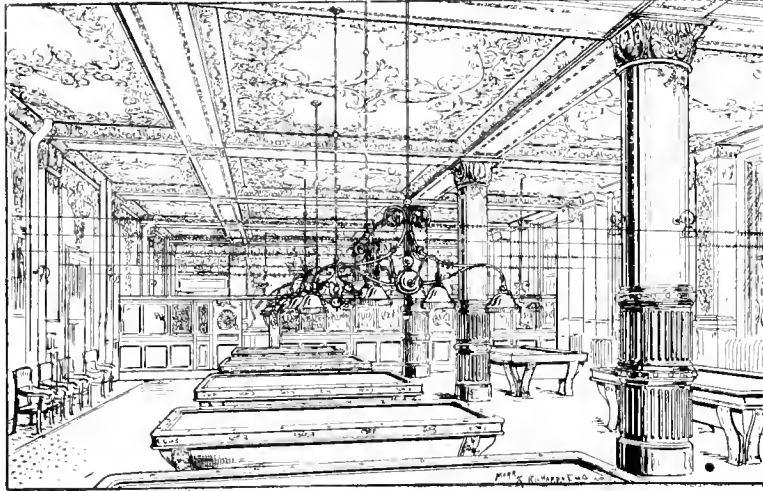

BILLIARD ROOM—HOTEL PFISTER.

is expressed in the furnishings of the Hotel Pfister.

ABSOLUTELY FIRE-PROOF.

The phrase "absolutely fire-proof" should become inseparately attached to the name of the Hotel Pfister, and it will be when the public comes to know how applicable it is. Architecture and building trades have not yet designed or constructed a building for human habitation more

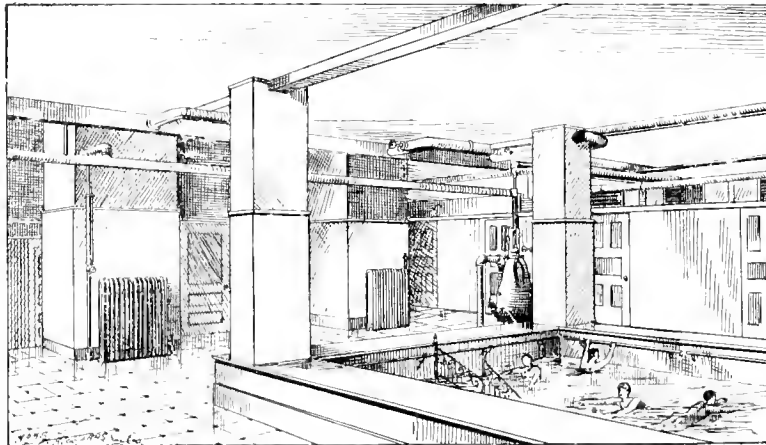

SWIMMING BATH.

thoroughly fire-proof throughout than is the Pfister. It has been said for it that any room in it could be filled with inflammable material and the material be set on fire, and it could burn out without the occupants of adjoining rooms ever knowing that there was a fire near them. The building is so constructed that it is practically impossible for fire to spread from one room to another or from one floor to another. No one who travels any, or who ever sleeps in a hotel, needs to be told how important a consideration is the fireproof qualities of an hotel.

ARCHITECTURE.

The Hotel Pfister exterior is of the Romanesque style of architecture, with modifications required for the uses for which the structure was erected. The first three stories are of rock-faced lime-stone, and the upper stories of cream brick and terra cotta trimmings to match. The structure has a massive appearance from

which occupies the lake side of the seventh floor. In this room the decorators have produced an

artistic and pleasing effect which is not to be portrayed with illustrations or painted in words. Like the lobby, it must be seen to be appreciated. The managers, however, have not stopped at elegant surroundings, but furnish a service and set a table which are both superb.

THE LOBBY

just mentioned, whether seen by sun-

light or sparkling with hundreds of electric lights at

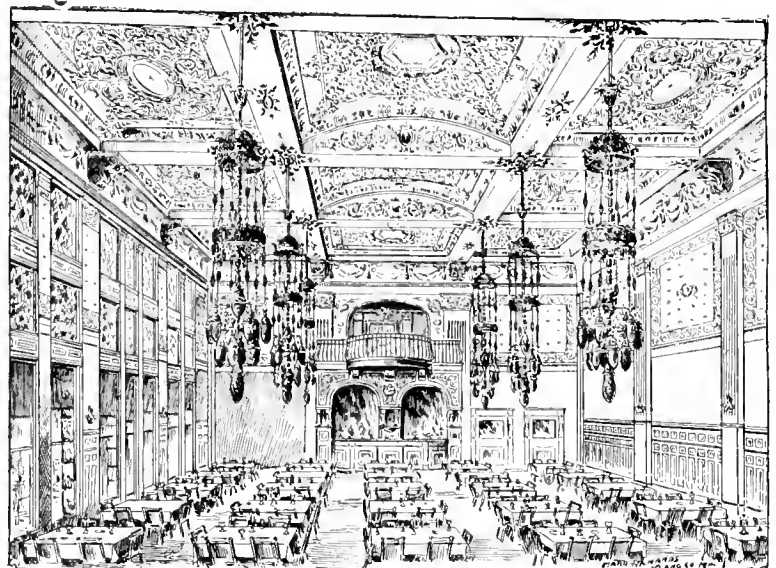

MAIN DINING ROOM—SEVENTH FLOOR.

night, is a sight to be long remembered. The decorations are of the heraldic order and produce a beautiful effect. The counter, which is 60 feet long, is of Algerian onyx and French marble, and marble has been freely used throughout the interior. At the Wisconsin street entrance repose two immense bronze lions, purchased in Rome, and the gift of one of Milwaukee's enterprising citizens.

We will not attempt a description of the bridal chamber, the banquet room, the gentlemen's and the ladies' parlors, nor the gentlemen's cafe. All these, with numerous other features, will afford a delightful trip of inspection to the delegates and their ladies in October.

The house is run on both the American and European plan, with rates ranging from \$4.00 to \$7.00 per day on

all the entertaining features provided by the Milwaukee Street Railway, the coming cannot fail to be the largest and best meeting the Association has ever held.

DENVER'S AMALGAMATION.

THE executive committees of the Denver Tramways Company and the Metropolitan system have resolved upon a consolidation of interests. The culmination will come August 6, but the preliminaries are already arranged. The bonded indebtedness of the Tramways is \$2,600,000 and an additional issue of \$500,000 will bring the total liabilities up to \$3,100,000. This makes a capitalization at \$4,000,000 favorable.

The Tramway has been asked to sell to the City Cable

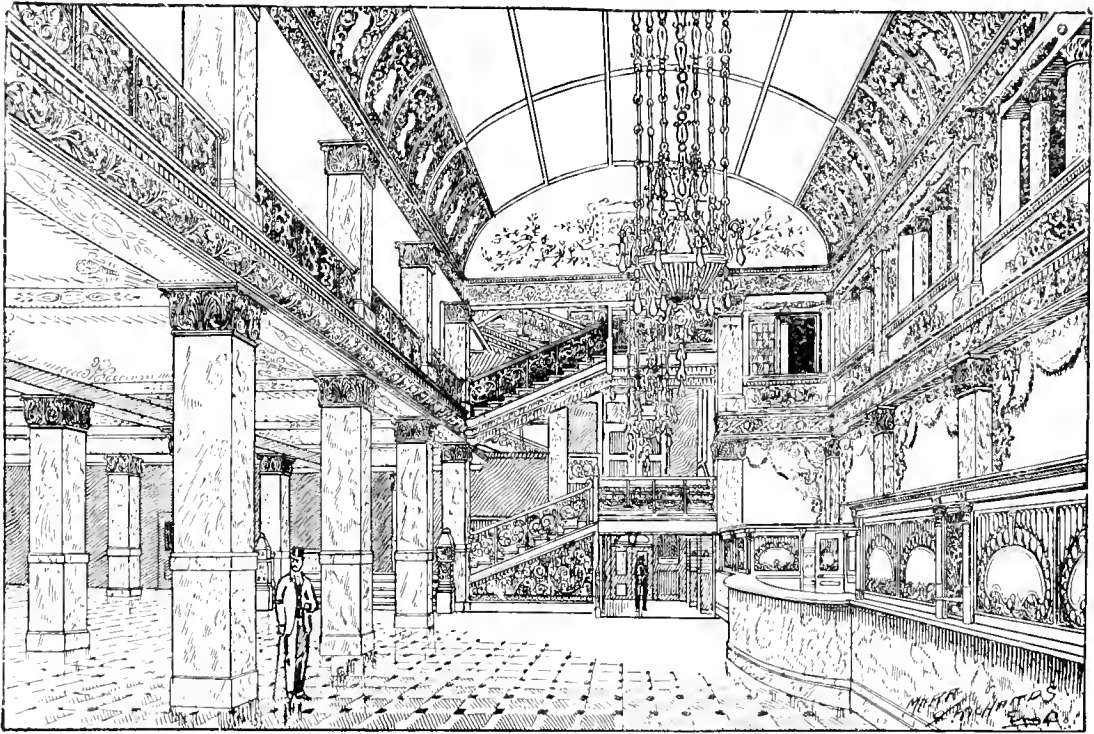

THE LOBBY—HOTEL PFISTER.

the American, and \$2.00 to \$5.00 per day on the European plan. The hotel has become a favorite with commercial men, for whom are provided the finest sample rooms in the west. The restaurant is also very popular, and another prominent feature is the facilities for private dinner parties and banquets.

The hotel is owned by prominent and wealthy Milwaukee men, with Chas. F. Pfister, several times a millionaire, as president, and S. H. Brown, one of the best hotel men in the country, manager. The building is brand new, having been opened only last May, and as Mr. Brown says, can take care of the entire convention easily and have room to spare. We might add the rates are reasonable, and that many applications for accommodations have already been received for rooms during convention week. With such princely accommodations and

and the offer has been refused, but those who claim to know say that the Tramways will buy the Cable. The Tramways are said to be in good financial condition and the rescinding of a large order recently was based upon the stringency of the money market.

No definite decision has been made as to the change of motive power on certain lines. The annual election made R. Evans, president; J. J. Reirhman, vice-president; W. G. Evans, secretary, and F. A. Keene, treasurer.

IN Paris, each passenger as he enters an omnibus station, is given a ticket bearing a number which entitles him to a seat in the bus when his turn comes, as indicated by his number. Tickets to the value of 75,000 francs were last year lost and thrown away, which expense the company is casting about for a means to obviate.

ECHOES FROM THE TRADE.

J. W. WALKER, president of the Shiffler Bridge Company, of Pittsburg, made the REVIEW a pleasant call last week.

THE LEWIS & FOWLER and the St. Louis Car Company are each building fifty cars for the Brooklyn City Railway.

CHAS. P. UPHAM, general manager of the Lincoln, Neb., Electric Railway, was a June visitor at the Exposition.



Uncle Cornstalk (just arrived in town) —“Hey there! where be one of them slots I he'd tell of?”

City Railway—the little consolidated.

THE AKRON BELTING COMPANY, of Akron, O., is a new belt furnisher, made by the consolidation of the Akron and Brigger belting companies.

GEORGE CUTTER is importing a fine line of French carbons, including some motor brushes, that he assures us are far superior to the American makes.

THE ANSONIA ELECTRIC COMPANY have just placed on the market their new adjustable pipe bracket. Their first order was for 300, shipped to Piqua, Ohio.

THE STANWOOD MANUFACTURING COMPANY is in receipt of constantly increasing orders for their car steps. The testimonials of users are flattering in the extreme.

AHEARN & SOPHER, Montreal, have equipped the new power house of the Montreal Street Railway with Westinghouse multiple generators, of which they are Canadian agents.

THE ROBINSON MACHINE COMPANY, Altoona, Pa., has removed its main office to 915 and 917 Drexel building, Philadelphia, where future communications should be sent.

THE STANDARD PAINT COMPANY still finds an increasing demand for their insulating paint and insulating compounds. “P & B” has become almost a household word among electricians.

THE J. W. FOWLER CAR COMPANY, of Elizabeth, N. J., has its new works well in hand, and will soon be able to take care of all orders. Prospects are good for a large business.

THE PHOENIX IRON WORKS, of Meadville, Pa., are sending out neat invitations calling attention to their World's Fair exhibit in section C, No. 27, Machinery Hall, World's Fair.

SIEMENS & HALSKE, of Berlin, have received the contract for wire, electric machinery and plant for the transmission of power from Niagara Falls to Hamilton, Ont. The plant will cost \$1,200,000.

HARRISON & CAREY, of the Mutual Railway Supply Company, have been appointed sole agents for the Billings drop-forged commutator segments. The agency covers the Western and Northwestern States.



“Guess I'll jest drop in a nickel and git one on them accident politics, so I won't get hurt.”

CHAS. HATHAWAY of Cleveland, called on the STREET RAILWAY REVIEW during the week. Mr. Hathaway is visiting the Fair with the rest of the boys, and has evidently left two or three score of his years in Cleveland.

THE LEWIS & FOWLER MANUFACTURING COMPANY, of Brooklyn, is now well installed in their new building. The company is full of work, and the large number of cars and railway appliances ready for delivery attest the continued excellence of their specialties.

THE INTERNATIONAL FARE REGISTER COMPANY, Chicago, of which A. H. Englund is secretary and general manager, may be justly proud of the fact that this register has been selected by the Western Dummy Company for use on the Intramural Railway at the World's Fair grounds.

THE MCGUIRE MANUFACTURING COMPANY, Chicago, reports a number of new orders. The Toronto & Montreal Street Railways who have heretofore built their own electric trucks, have given orders to the company for a lot of their Columbian trucks, one of which they have had in service for nearly a year.

THE PITTSBURG STEEL HOLLOWARE COMPANY, of Allegheny, Pa., finds its business increasing each month and is shipping all orders promptly. From their point of view the street railway business is good. They have found the perfection of their old gongs and devices such that no changes have been necessary this year.

J. M. JONES' SONS, West Troy, N. Y., recently shipped five handsome new open motor cars to the Utica, New York, Belt line. They are 26 feet in length, contain eight cane-bottomed seats and have a seating capacity of 40. The cars will be put on the New Hartford, Whitesboro and New York Mills lines immediately.

THE GARTON-DANIELS ELECTRIC COMPANY, of Keokuk, Ia., report that the Garton arrester is doing all that is claimed for it. An order from Belgium has just been received and a large foreign business is expected in the near future. A new descriptive folder containing comments and letter of commendation has just been issued.

THE M. C. BULLOCK MANUFACTURING COMPANY, Chicago, has removed its city office from 39 South Canal street to S, E, section P, 21, Mines and Mining Building, Jackson Park, whither all visitors are cordially invited. This office is at the disposal of all of the friends of the company, and mail and telegrams may be forwarded to it.

THE AMERICAN CAR COMPANY, of St. Louis, reports work day and night.



"Bean awaitin' most five minutes now; p'raps I better tell 'em my name and how I'm in a hurry to—"

A new two-story building containing pattern and supply rooms, as well as a large paint shop, have been added to their facilities. Recent orders from Racine, the Southern Railway Company, of St. Louis, Calumet and North Chicago roads, Chicago, are reported.

THE PITTSBURG STEEL HOLLOWARE COMPANY, of Pittsburg, Pa., is doing a large business in gongs. Lewis & Fowler, of Brooklyn, the St. Louis Car Company, the Brownell Car Company, the Lamokin Car Company, Adams & Westlake, of Chicago, and others, are recent buyers of large quantities. The pure tone and durability of the gongs are their chief characteristics.

THE EASTERN ELECTRIC CABLE COMPANY, of Boston, have found the turning away of orders which cannot be filled on account of being three months behind, a little monotonous, and are pushing to completion additions to their works. A three-story factory, 60 by 151 feet; a

power house 40 by 50; three 80-horse-power boilers and one 125-horse-power engine, are among the improvements.

THE LACLEDE CAR COMPANY, of St. Louis, has a late order for one hundred 18-foot closed cars for the Philadelphia Traction Company. This makes 250 cars ordered of Laclede from Philadelphia's big company. Bemis trucks are specified. The Duquesne Traction Company, of Pittsburg, and the Twin Cities Company are late buyers, while Cincinnati comes in with new orders.

THE WILLIAMS ENGINE & CLUTCH WORKS, Beloit, Wis., has had a change in management, W. H. Wheeler and C. E. Wheeler retiring from the board, the latter also resigning his office of secretary and treasurer. H. F. Probert, succeeds as manager and G. W. Sparks as secretary and treasurer. The facilities for the output of engines, friction clutch pulleys, hangers and other specialties will be increased.

THE AMERICAN BOLT COMPANY, of Lowell, Mass., are manufacturing, among other excellent railway specialties, a new trolley wire hanger, the joint invention of Miles F. Brennan, treasurer of the company, and Philip J. Begley, superintendent of the Lowell Street Railway. It is designed for use on bracket arms and bridges and under elevated railroad structures, and is giving excellent service on the Lowell road.

THE EDDY ELECTRIC MANUFACTURING COMPANY have just closed a contract through their Chicago office for the equipment of Whitman & Barnes agricultural implement factory, at West Pullman. This calls for twenty-six motors, ranging from 3 to 5-horse-power, and two direct coupled generators, one of 200 kilowatts and the other of 65 kilowatts. They also have the contract for the ventilation of the World's Fair boiler room.



"Gosh to 'mighty—wisht I hadn't done it."

THE WEST END STREET RAILWAY, of Boston, ordered of the Brownell Car Company a year ago two sample accelerator cars. After using them and carefully noting the results, they have just placed an order with the same company for fifty. No higher praise can be given than this of the many advantages the accelerator car, and as between the Brownell accelerator and the Pullman double-decker, which was tried at the same time, the former has won a positive victory.

A VERY sensible suggestion is made by the Engineering News that trade catalogs be made to conform to some standard size, say 6 by 9 inches. In our own field there are almost as many sizes as there are catalogs. Many of these publications contain much valuable reference matter in the way of tables and rules, and really are deserving of a place on the office book shelf. A more nearly uniform size would help insure a permanent place, instead of being thrown on a table or shelf to be covered up and forgotten.

THE BERLIN IRON BRIDGE COMPANY, of East Berlin, Conn., is putting up the new plant for the Worcester Traction Company, at Worcester, Mass., which will consist of a power house 89 feet wide and 116 feet long, and a car shed 95 feet wide and 290 feet long. The construction will be of iron and brick and will be fire proof. The same company have also received the contract for the new power station for the Atlantic Improvement Company, of Astoria, Long Island. There will be two buildings, a boiler house 62 feet wide and 85 feet long, with a dynamo room 70 feet wide and 130 feet long, the latter provided with a traveling crane.

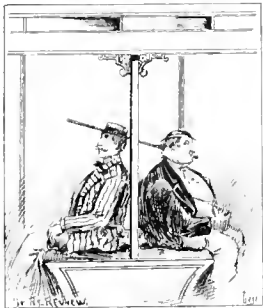

BRIM FULL OF DISCOMFORT.

B. M. BARR, of Cleveland, O., has recently become district representative of the Eddy Electric Manufacturing Company. Mr. Barr's long connection with the Edison Manufacturing Company and his retention with General Electric Company on account of his business ability, have given him a large acquaintance in electrical circles and his new position will no doubt be as creditably filled as were his former business connections. Within the last month he has closed a number of orders, among them one 2,000-light plant complete, together with power, for the Cleveland Opera House; one 1,000-light machine, one 65 kilowatt direct connected dynamo and several smaller lighting plants, besides a number of motors varying from 5 to 15-horse-power, aggregating 400-horse-power.

THE INTERNATIONAL REGISTER COMPANY, of Chicago, report business in their fare register very brisk. Contracts have been made during the past month for the equipment of the following roads with their portable registers: Tacoma Railway & Motor Company, Tacoma, Wash.; Bay Cities Consolidated Railway, Bay City, Mich.; West Street & North End Electric Railway, Seattle, Wash.; Calumet Electric Railway, Chicago; Seattle City Railway Company, Seattle, Wash.; Electric Railway, Light & Power Company, Anaconda, Mont.; Muscatine Electric Railway, Muscatine, Ia.; Fort Clark Street Railway, Peoria, Ill.; Mobile Light & Railway Company, Mobile, Ala.; Ottawa Electric Street Railway,

Ottawa, Ill.; Citizens' Street Railway Company, Kalamazoo, Mich.; Columbian Intramural Railway, World's Fair Grounds.

WINDING THE WESTINGHOUSE MULTIPOLAR.

THE accompanying engraving is an interesting view of a daily operation in the Westinghouse Electric & Manufacturing Company's factories. It shows the process of winding the Westinghouse multi-

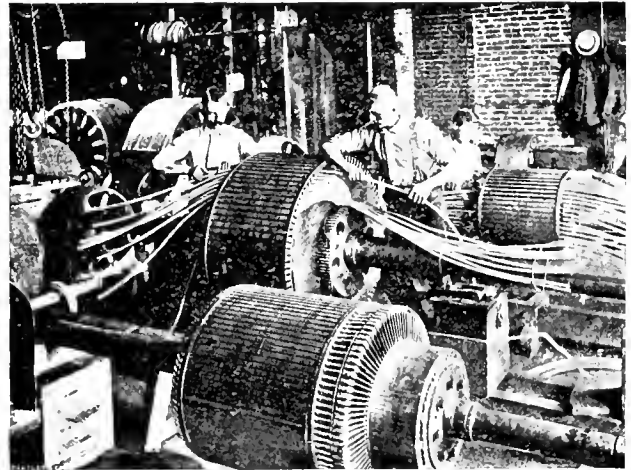

WINDING A WESTINGHOUSE MULTIPOLAR.

polar generators, and the method of handling the heavy conductors.

TROUBLE IN THE POWER PLANT.

"You have a wheel," said the dynamo,
To the engine who cranky grew,
And made a piston stroke at him;
Whereat the boiler flue.
The shaft turned 'round—
'Twas round before—
The governor dropped his belt;
The valve took off its plain wrist-pin
And asked how the packing felt.
The coal turned white,
The whistle blew,
The cable wrapped on its drum;
And the live steam hit the pipe so hard
It sprained a joint or two.
The cylinder took its jacket off—
Acknowledged it was a bore—
And threatened to leave its iron bed
And never condense any more.
The stoker turned a dinner pail;
The band wheel played a chant,
And a farmer at the window asked
For a seed from the power plant

Street Railway for Sale.

The street railway in a growing manufacturing city of 25,000; 8 miles track, 11 cars; 65 horses; two good barns, one new, and all necessary apparatus. Franchise has 25 years to run under very favorable conditions. City growing rapidly. Present lines have a good business, but parties who purchase can realize a handsome thing by changing to electricity. Property is unencumbered, and very favorable terms will be made to right parties. Owner has other business interests which demand his time. Address,

"SPLENDID OPPORTUNITY,"

Care Editor STREET RAILWAY REVIEW.



WINDSOR & KENFIELD,
PUBLISHERS AND PROPRIETORS.

269 DEARBORN ST., - - - CHICAGO.

Published on the 15th of each month.

SUBSCRIPTION, - - - TWO DOLLARS.
FOREIGN SUBSCRIPTION, - - - 20 SHILLINGS.

Address all Communications and Remittances to THE STREET RAILWAY REVIEW,
269 Dearborn Street, Chicago.

H. H. WINDSOR, Editor. F. S. KENFIELD, Business Manager.

CORRESPONDENCE.

We cordially invite correspondence on all subjects of interest to those engaged in any branch of Street Railway work, and will gratefully appreciate any marked copies of papers or news items our street railway friends may send us, pertaining either to companies or officers. Address:

THE STREET RAILWAY REVIEW,
269 Dearborn Street, Chicago

Entered at the Post Office at Chicago as Second Class Matter.

This paper member Chicago Publishers' Association.

VOL. 3. AUGUST 15, 1893. NO. 8

THE tabulated statements made by the American Exchange and Review for June, 1892, shows that the total number of fires in Massachusetts dwelling houses for the past fifteen years was 12,814, and of this number electric wires caused three.

CABLE construction in New York City is enjoying a genuine boom, and twenty additional miles are now contemplated by the Metropolitan Traction Company. The new lines involve no such engineering difficulties as were experienced on Broadway.

PLANS for the Midwinter Fair at San Francisco are being rapidly consummated and the enterprise bids fair to be a success. Nearly all the local transportation lines are already making extensions to the park, and are laying permanent tracks. The transportation facilities will be excellent.

THE Supreme Court of Wisconsin decides that a paving contractor has no power to obstruct street car tracks in the progress of his work, where it is shown such work has been and can be done without such interference, and where the paver's contract with the city does not expressly delegate to him such privilege.

THE opening of the Matlock cable road adds one more to the list of cable traction in England, and is undoubtedly the most complete thus far built in that coun-

try. The line is quite short, but has a rise of three hundred feet, and its construction involved not a few difficult problems. It is already carrying a good business and a freight service will shortly be added.

EVEN if there is some question as to the genuineness of the nutmeg manufactured in Connecticut, the governor is considerable of a man when one considers the "pull" he must have now. The last legislature empowered him to appoint "street railroad," "railroad" and "steamboat police," and it has been found necessary to ship in an extra supply of "influence."

THE system of evening excursion tickets as adopted at Delaware, Ohio, and described in this number, is full of suggestions and the plan can profitably be adopted in a large number of cities. It creates riding, and fills the cars at a time when they would otherwise carry light loads. It also has the double advantage of incurring no additional expense and popularizes the road.

IN spite of the uncertainty which prevails in financial circles and the misfortunes which have come to many of the manufacturing interests in this country, the street railways and their supply men have held their own nobly. A very considerable amount of new work is going forward and the showing for the year, while below that anticipated, promises to make a handsome showing.

STREET railway securities in Chicago have suffered with other stocks during the past ten days, in one instance, City Railway, which is traded in but little, selling down to 220. This, however, was on a forced sale, and was quickly taken. It subsequently recovered to 270. West and North Chicago cables also suffered. The prices at which these securities are quoted are the result of the close money market and in no way indicative of values, as all three companies are earning a much larger revenue than ever before, and have continued to do so all the season.

THE inventor is now turning to safety car fenders, very much as the young man's fancy is said to turn to love, in spring. As usual, many of them are evolved from the minds of people who do not know a trolley base from a wheel base; others promise to produce something of practical value and use. A few exaggerated types contemplate a sliding net, which reaches almost to the leading car. It is needless to remark that no such atrocity will ever be adopted. There is, however, a good field for a perfect car fender, but to be successful it must be much more simple in construction and action than very many which are now being advocated in the daily papers. It is to be hoped that at the Milwaukee convention there will be a fender field day, in which all the new fangled life saving devices shall be given an actual demonstration. To weed out the useless ones, it might be well to condition entrance to the trial on every inventor being required to stand in front of a high speed car and show the rest of us how he picks himself up.

A REMARKABLE case has just been unearthed in this city—remarkable rather in its complete exposure than in its rarity—and recounted in full in this issue, under the title of “Deliberately planned accidents.” It is a strange but true confession of a young man who attempted first personal injury and later suicide, as a means of defrauding an insurance company out of heavy damages. The efficiency of the cable car system is incidentally illustrated in the fact that while the young man deliberately threw himself in front of a rapid moving train he failed to secure any injury and was forced to shoot himself in his progressive method of self-mutilation. The very strange feature of the case is, the man is well educated and cultured, and beyond any question is in his right mind. If money is the root of all evil it is very evident the vintage of '93 in Chicago includes some mighty tough snags.

SLEEP is, apparently considered, in Chicago, a great luxury, and one that must be paid for. Some visitors to our knowledge have paid for a small bedroom sums running from four dollars to four pounds. Thus sayeth the Electrical Review, of London. We have known people to pay three hundred dollars for an animal worth about fifty dollars, but it was because they were ‘horsed’ for not knowing any better; and if some “visitors to our knowledge” paid twenty pounds for a small bed room in Chicago in the year of grace 1893 they must have taken it for the entire World’s Fair season. The truth is, hotel accommodations are cheaper and better in Chicago to-day than in any other city on this continent, and the supply provided has been so extensive there are two rooms for every guest. An English contemporary also further jeopardizes his welfare in the next world by the ridiculous statement. “It would be almost cheaper to take an outgoing train from Chicago, in order to sleep.” It is a fact Chicago people are the most energetic on earth’ but they do take a nap occasionally, and without the necessity of leaving town either. Very desirable rooms within walking distance of the Fair can be had for one dollar per day.

AS predicted in these columns, the visit of our European friends to the World’s Fair is destined to become a most powerful factor in hastening the day when mechanical traction shall displace animal power in the propulsion of street cars, across the water. Already the good work has begun and in a recent issue of the leading daily, in Manchester, England, appears a long letter from one of the prominent citizens of that city who is visiting Chicago. He is amazed and delighted at the demonstrated capabilities of both the cable and electric lines in our large cities and heads his letter “Electric Cars in America: why not here?” He grasps the great problem of distribution of population and closes with these words:—“I have seen these cars worked under all conditions, and comparing our system with theirs we seem to be a long way behind in providing adequate traveling accommodation for the public. I think that if a cheaper

and quicker means of traveling were adopted in Manchester and Salford, it would be a great relief to the population in the congested parts of the city, as the public would then be able to live as cheaply outside the city, and in a purer and more healthy atmosphere.”

THE death of John Stephenson brings a feeling of sorrow and regret to the entire street railway fraternity. Although personally known to comparatively few of the present generation of railway managers, it may safely be assumed his name and reputation is held in high esteem by every street railway in the world. Himself the pioneer in the building of street cars, he has lived to witness his first crude efforts expand and develop into a tremendous industry, and magnificent systems of intramural transportation grow into an absolute necessity of the cities which have been called into existence within the span of his four score years and four. The story of his life is full of interest to old and young, and to the latter affords a splendid example of the reward which comes to the young man of integrity and purpose. John Stephenson was a man whose life and business was made to conform to the religion he not only professed but thoroughly believed. Crowned by all the glories of a grand old age, he has been called away, but his name will ever live, not only in the memory and respect of those who knew him, but by the thousands who in years to come are to be called into the service of street railway management.

A RECENT ordinance has gone into effect in Baltimore, compelling street cars to make their crossing stops on the near side of streets, and conceived as a “safety measure.” Its passage was unsuccessfully opposed by the companies and the arrangement is very unpopular with the public, and works a special hardship on strangers, as the rule is in force in no other large city to our knowledge. As might be expected, much time is lost in making crossings in this way, as the stopping of the car before going over the cross street gives teamsters an opportunity to pull in front of the cars, and even after the go ahead signal is given the gripman must wait until the street is clear. Truck drivers, as a rule, will stop when an approaching car is about to cross their street, which gives the car a quick and safe crossing, but when the order is reversed and the teams practically given the right-of-way, a whole car load of passengers are made to wait the slow progress of two or three loaded wagons. With this repeated at every crossing in the down town district the annoyance can readily be imagined. The judgment of the best street railway managers is positively in favor of making the crossing before stopping for passengers, and we fail to see any possible advantage, unless it might be that women in leaving the car would perhaps be more likely to face ahead on account of the crossing being in that direction. The disadvantage of landing passengers in the street instead of on the cross walk in muddy weather must prove very great. Incidentally we call attention to this as another instance of the obvious impropriety of municipal management of street railways.

ONE of the most interesting and promising uses to which electric cars may be put, is about to be given a practical demonstration in the city of St. Louis. The city dispensary is in the heart of the city, while the insane asylum, poor house, female hospital and city hospital are some considerable distance out. At present the removal to any of these, involves both danger to the patient and a heavy expense to the city. Dr. Homan, the health commissioner, has conceived the idea of an electric ambulance car, mounted on extra springs, and fully equipped as an emergency hospital on wheels. Bunks for patients, and a full complement of instruments, medicines, a skilled surgeon and a trained nurse are included as a part of the equipment. The ease and speed with which the car can run, and the advantages of light, air and room in which to work, combine to make the facilities well nigh perfect. The electric mail cars now in commission in St. Louis are a splendid success, and we predict even greater for the ambulance car. There are districts in many cities where it would not be advisable to substitute the car for the present wagon, but there is in every city a wide field and a most promising future for the new hospital on wheels.

WE are enabled this month to publish extensive figures on the economy of electric railway power plants. One set of results is from a very small system, the other from a very large one. That from the Cedar Rapids plant is specially interesting, because so few figures have been published from small stations and because it shows that by proper station design and the employment of intelligent men the economy is not necessarily much lower than with large plants. At Cedar Rapids the equipment is not that which is supposed to be capable of the highest duty, but the results are among the best. The Minneapolis tests bring out many items of interest in regard to the economy of different fuels and types of machinery. On account of the varying character of a street railway, load efficiency tests are rather difficult and that is probably the reason that so few roads have any idea what they are doing in the way of station economy. The car mile is a far less difficult basis to figure on than the horse power hour in railway plants and is coming to be pretty generally accepted as a standard of comparison. Every road should know what this item comes to in its station and if the result is not favorable as compared to others using the same fuel it should investigate by systematic tests until it finds the reason for such discrepancies.

THE fourth annual report of the Inter-State Commerce commission for the year ending June 30, 1891, is just issued from the Government printing office. One of the most striking statements is found in the geography of new railroad tracks. Of the ten groups into which the United States is divided by the report the greatest amount of new track is found in group V which includes Kentucky, Tennessee, Mississippi, Alabama Georgia and Florida, with a gain of 868 miles; and group IV, second, Virginia, West Virginia, and the two Carolinas with an increase of 802 miles. It will be remem-

bered that prior to the war the South led the North in the number of miles of railroad, and was building at a much faster rate. It is now beginning to recover in this respect and the conclusion of interest to street railway men lies in the fact that those elements which make activity in steam railroad construction possible, mean the growth of southern cities and the construction in them of new electric lines. Florida and South Carolina have each christened their first electric within the past few months, and the work accomplished and decided on in New Orleans, the city from which the Gulf States take their keynote, will be very large. It is a development which will be far less rapid than has characterized the northern cities, for there are few large cities in the south, and the people there are slow to act and have less capital to do with. But the work so far has been uniformly good and the future of electric railway building in the south for the next few years is good.

THE failure to electrocute murderer Taylor in the Auburn prison with a 1,700 volt shock, places those papers which are eternally howling about the "deadly trolley," with its 500 or less volts in a decidedly defenceless position. In the Auburn case every possible advantage was insured to give the victim the full benefit of the current, while it could rarely ever happen that a trolley wire would have an equal opportunity, and also is limited to less than one-third the voltage which was employed so unsuccessfully at Auburn. It would seem as though there had been about enough of this barbarous killing by inches, unless the design is to make the execution a double lesson to evil doers by emphasizing it with intense suffering. In that case the old style public execution of being drawn, quartered, and having one's head elevated on a pike-staff, would seem to be more like the real genuine article. Capital punishment doubtless cannot yet safely be abandoned, but in the name of common humanity, let it be effected decently and in order. A death chamber, which could be instantly filled with noxious gases, causing first insensibility followed by speedy death, would seem to fill all requirements and be both easy of manipulation and positive in action. It certainly would seem time to relieve so good and useful an agent as electricity from what appears little less than a prostitution of its honest purposes. In any event let us hear no more of that "deadly trolley."

STORAGE BATTERY DECISION.

JULY 18, Judge Coxe handed down a decision declaring the patent of the Electrical Accumulator Company, covering the Faure process, of putting on the active material of a storage battery in the shape of paste, to be void, owing to the previous expiration of the Spanish patent on that process. The defendant in the case was the Julien Electric Company, representing the Consolidated Electric storage Company. This latter company owns the fundamental Brush patents on the storage battery and, although the Faure patent is expired, the Consolidated claims that this fact is of no value to the public.

JOHN STEPHENSON.

The Builder of the First Street Car—A Brief History of an Intensely Interesting Career—At the Age of 84. His Death Occurs at His Home in New Rochelle.

THE passing away of the venerable John Stephenson again reminds us that the institution of street railways and their beginnings are becoming a part of history, and to few men has it been given to see their first labors so grow into recognized importance and significance. And to no man has this unusual happiness come more fully.

Out of poverty into wealth, out of labor into ease, out of insignificance into world wide reputation: the founder of an industry and enjoying the attendant honor—is not that a rare combination of all that makes life worth living, or industry worth the battle? And that too, deservedly. Men have fought for liberty and died in chains. Men have struggled for knowledge and died at the stake. Men have founded industries and perished in poverty, but here is a life that found a full fruition of early toils and pains.

The early part of this century, whose genius marks its children, and the cosmopolitan influences exerted on Mr. Stephenson's impressionable years may have had more effect than we are now able to trace.

In relation to this it may be stated that July 4, 1809, was John Stephenson's birthday and County Armagh his natal place, while his father, James Stephenson, was an Englishman and his his mother a Scotch woman. In 1811 the family removed to New York and here John Stephenson received an essentially American training. Young Stephenson passed his school days at the Wesleyan Seminary in New York city, and afterwards, in obedience to his father's wish, mounted the merchantile office stool to learn the theory of merchandising. After three years of this training the young man successfully urged

his father to apprentice him to a coachmaker, Andrew Wade by name, where the mechanical proclivities of the future street car builder could have free scope. Mr. Stephenson was at this time 19 years of age. The two years that he remained in Wade's shop were busy ones, for after the day's work the young coach builder spent his evenings studying mechanical drawing and designing.

Andrew Brower, who was owner of the pioneer stage line of New York, having started his line in 1827, was Wade's chief patron in repair work and naturally met the coachmaker's assistant in his professional duties. Brower quickly recognized the youth's abilities and persuaded the young man to leave his employer and begin business on his own account. This he did, and after two years apprenticeship opened the embryonic factory of the John Stephenson Car Company, limited. This was May 1, 1831, and with small capital and unlimited courage John Stephenson launched his first business venture at 677 Broadway, New York. His patron was as good as his promises and kept the little shop busy with repair work. Larger affairs, however, reign-

ed in Stephenson's brain and the omnibus was created. A number of these were built for use in New York streets and were becoming very popular, when on March 29, 1832, a fire demolished the entire premises occupied by the Brower stables and the Stephenson shops, leaving both patron and client without plant or means. The fire carried away Mr. Stephenson's original \$400, together with the \$1,200 increase, which the growth of business had added to the original sum.

With little delay however, and stout heart and willing

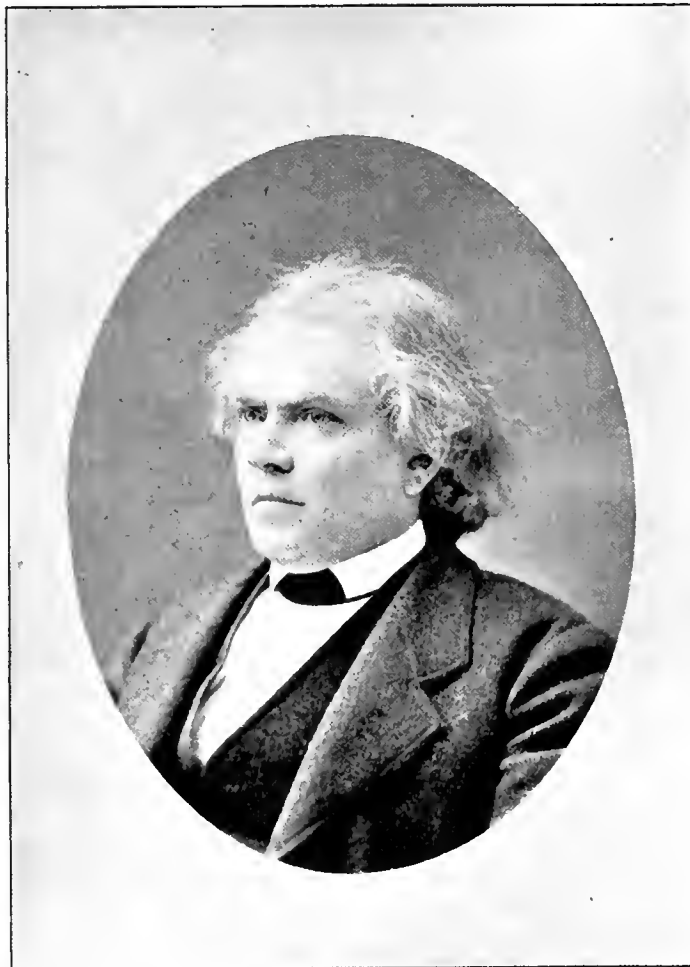

JOHN STEPHENSON.

Inventor and builder of the first street car. Born, July 4, 1809. Died, July 31, 1893.
(From a photograph loaned by his daughter.)

hands Mr. Stephenson began again the following May. This time at 264 Elizabeth street. It was in this shop that the first street car was built, and operated upon the first street railway, the New York & Harlem; the first branch of which ran from Prince street to Fourteenth street. The initial trip was made this same year, 1832 with great ceremony.

The John Mason, for so this first car was baptised, was an immediate success. It was named after the president of the road and quickly followed by the "Mentor," the "For-get-me-not" and others. The first car made its initial trip November 29, 1832, and carried the members of the common council and other distinguished citizens. A patent was granted on this car and the original papers signed by Andrew Jackson, president of the United States, is still in possession of the Stephenson family. Other early orders were from Patterson, N. J., Brooklyn and Jamaica, N. Y. and from Cuba and Florida.

In 1836 Mr. Stephenson purchased ground for a factory at 129th street and Fourth avenue, but the financial crisis of that year drove him to the wall and another time he began life over again. All his creditors were paid fifty cents on the dollar in the first instance and seven years later every one was paid in full. Mr. Stephenson's unswerving honesty refused to take advantage of the bankruptcy law and every penny of the debt was fully and finally paid.

In 1843 a new factory site at Twenty-seventh street and Fourth avenue was bought and in seven years paid for, factory, debts and all liabilities. In 1852, the Second, Third, Eighth and Ninth avenue roads in New York were granted charters and Mr. Stephenson, as a matter of course, received the contract for the cars. This was the beginning of active car building and since then Europe, Asia, South America and even Africa have called upon the John Stephenson Company, Ltd., for cars, carrying to every quarter of the earth the name and fame of John Stephenson. The little shop has grown to a factory employing 500 hands, with a capacity of four cars a day, and the street railway interests fostered there have increased now beyond any certain calculation.

In 1833 Mr. Stephenson married Miss Julia A. Tieman, whom he survived but two years.

Since the death of Mrs. Stephenson the family has consisted of one daughter, Mrs. D. W. Pugh, and two sons, J. B. and S. A. Stephenson, who are interested in the Stephenson Company.

Of late years the family residence has been at New Rochelle, N. Y., on the Boston Post road, where a magnificent granite residence was erected. Here, in peace and plenty, John Stephenson passed his last years.

His death occurred July 31, at 5 o'clock p. m., and resulted from a general weakening of the system, consequent upon a severe attack of the grip three years ago.

Until the Thursday before his death Mr. Stephenson was able to attend to his official duties with as clear sagacity as ever, and with the ability that has characterized his entire career.

By faith a strong Methodist, Mr. Stephenson was

always a firm friend of all religious and philanthropic work, and many a young man owes his advancement in this world to Mr. Stephenson's teachings, examples and practical help. A thorough musician, for years he was a member of the New York Sacred Music Society, and for forty years he was choir leader. Always refusing political preferment, although often urged to become active in public life, he has ever remained the same sterling, honest, public spirited citizen and clean-lived man, whose death removes him from a large circle of strong friends and a large number of admirers.

ST. LOUIS STREET CAR AMBULANCE.

ST. LOUIS seems to have a quicker appreciation of the adaptation of the electric railway than any other city. She started with a postal mail car, the first of its kind in the world, and now proposes to put in service an ambulance car.

The idea originated with Dr. George Homan, the city health commissioner, and promises to become a most important auxiliary in the work of his department, the object being to displace horse vehicles in conveying patients to the hospitals.

Three large institutions of this character, namely, the Insane Asylum, Poor House and Female Hospital, are grouped in a suburban location some miles distant from the central part of the city, where the city dispensary is situated, and from which place all classes of disabled and



ELECTRIC AMBULANCE CAR.

dependents are forwarded to the proper institution provided therefor. All these institutions, and the city hospital as well, are in near relation to or directly on the route of one of the principal railway systems (the John Scullin lines) and this fact was one of the considerations that determined the employment of this class of vehicle for the purpose stated. It is intended that the cars shall be run on schedule time, starting from the central part of the city, receiving en route such sick or injured persons as may be found necessary, and delivering to the several institutions those respectively assigned to them.

Of course a special car will be required, and will be fitted with bunks for such patients as cannot sit up, and with seats at the rear of the car for those who are not so weak or disabled. Extra springs will be placed under the car body, and probably under the bunks, so that the jar of transportation will be almost wholly overcome. The comparison between this car and the wagon

ambulances now in use in all cities will bear about the same relation that an easy phaeton on a boulevard does to an omnibus running on cobbles.

At the forward end of the car, shelves, racks and lockers will contain all necessary instruments, medicines and appliances for emergency use. Everything necessary for the successful treatment of all classes of emergency cases, surgical, obstetrical, poisoning, etc., will be at hand, and a skillful surgeon and trained nurse will accompany each car for the care and relief of patients. In brief it will be an emergency hospital on wheels, and there can be no doubt that its utility in the several points of speed,

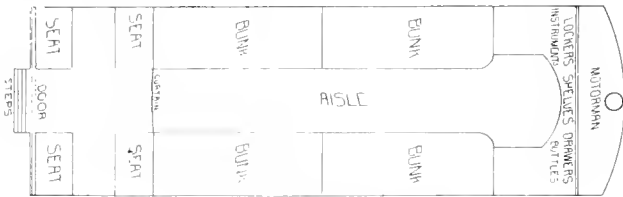

PROPOSED PLAN AMBULANCE CAR.

safety, ease, efficiency and economy will quickly make the introduction of the system in every city a necessity. The advantage of room, light, air and ease of motion place it far in advance of the ordinary hospital ambulance, in which little is possible beyond a hurried and thereby possibly fatal trip to the hospital. The ambulance car, on the other hand, has every facility for the immediate relief of the patient, and as every surgeon knows, in emergency cases this often decides the fate of the injured person.

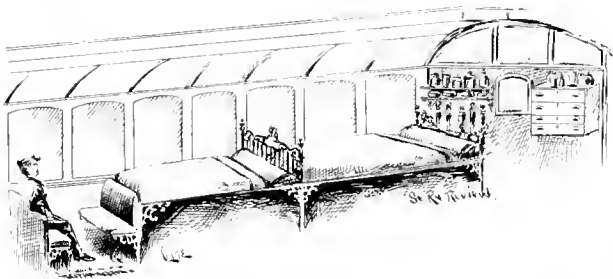

INTERIOR AMBULANCE CAR.

There are, of course, congested business districts where it will be impossible to dispense with the wagon systems, but for long hauls, such as are usual in most cities, there is a magnificent future for the electric ambulance car, which can go anywhere electric lines extend.

Mr. Scullin is greatly interested in the plan and has given Dr. Homan practically carte blanche. The final plans for the interior arrangement of the car are not yet fully decided on, but we illustrate the one which will in all probability be adopted.

THE council of the city of Paris has voted 3,000 francs to pay the expenses of the chief engineer of lighting and highways to America and the World's Fair. He will be required to report on the state of electric traction and lighting in America, or as an English contemporary puts it, "upon the exhibition in general, and America in particular as to lighting and electric traction."

COLD STORAGE FIRE.

OUT of the smoky horror of the burning of the Cold Storage Warehouse of the Hercules Iron Company; after the sickening recital of scenes that makes men's blood run cold, comes a flower of sympathy that knows no boundaries of state, city, race or condition. It grows from the human heart, and brands the lie upon the proverb of "man's inhumanity to man."

It is needless here to recount the number of the victims, or to tell an eye witness' story of the horrible moments between the time when the crowd regarded the fire as a huge joke and the awful united groan that went up when the first brave fireman dashed himself to death on the roof below the tower.



COLD STORAGE FIRE—INSTANTANEOUS PHOTOGRAPH AT MOMENT WHEN ESCAPE WAS DISCOVERED IMPOSSIBLE.

It is not our place to examine the witnesses and place the blame of the death and injury of a score of brave fellows, who willingly went into the death trap at the order of their chief and the call of humanity. Our engravings tell the story better than the words of a poet or the brush of a painter. The camera is your best reporter, always truthful, always effective, and to you, reader, we leave the story told by it.

The first engraving shows the beginning of the fire, just after the flames had fastened their fangs on the lower part of the Tower, cutting off all escape by the interior stairway.

The REVIEW correspondent has mounted the Intra-mural Railway at the Colonade, from which station

smoke could be seen floating in a thin nimbus above the top of the tower. When the train had reached the Transportation building the fire was well under way, and the firemen could be seen clustering on the fatal ledge of the tower top. On reaching the Service building station, flames could be seen bursting from the lower part of the tower and from the main roof. Thus the awful swiftness of the conflagration may be understood. By this time the correspondent had reached the ground, and was standing transfixed and powerless against the Transportation Annex. The tower fell, carrying with it human lives, the number of which only the day of judgment will reveal.

tric light plant. Its cylinder measurement was 13 by 12 inches, and was perfectly adapted for its functions. In appearance it gave an impression of extreme rigidity and strength, the deep and broad frame, heavy wheels and shafts, and compact design all contributing to this general effect. We are sorry that the conflagration precludes an engraving of this engine, which the REVIEW hoped to illustrate in this issue. It may be said, however, that this is not the last chance, by any means, of illustrating the Ames Engine Works designs, as they are rapidly becoming favorites among central station engineers. Although they have been upon the market but a short time and are among the highest priced engines, their



COLD STORAGE FIRE—INSTANTANEOUS PHOTOGRAPH AT INSTANT WHEN TOWER FELL.

Our engraving shows this fall of the tower, and is a powerful and speaking likeness of the awful holocaust.

LOSS OF THE AMES ENGINE EXHIBIT.

There was at the Cold Storage Building a complete power plant of the most modern pattern, which was destroyed with the other valuable and expensive machinery installed by the Hercules Iron Company.

Among the engines lost, the largest was a 100-horsepower automatic, built by the Ames Iron Works, of Oswego, N. Y., which was used exclusively for the elec-

sale has been so rapid that the company is about to erect new shops to keep pace with this increased popularity. The new shops are about 100 by 400 feet in dimension by three stories in height. The Chicago office, at 18 South Canal street, will be pleased at any time to explain the advantages and prices of the Ames product.

A ROCHESTER man has a device for stepping an electric car within three feet when running at full speed. At the rate most electricians run there would not be much of a car left to stop at the end of a week.



A ZIPERNOWSKY dynamo is shown by Schneider et Cie, of Creusot, France, in Machinery Hall. It is for alternating current work and at 500 revolutions has a capacity of 25 amperes at 2,000 volts.

In honor of Mr. Stephenson the Stephenson Car Company's exhibit in street car row was draped in black and closed to visitors. A notice over the door of the car explained the cause of the mourning.

JULY 31 was engineer's day at the Fair, when the American Society of Mechanical Engineers visited the exposition in a body. A regular program was performed, including a visit to the moving sidewalk on the pier and a trip in the Ferris wheel.

ONE of the most beautiful sights is the view of the Ferris wheel, from the elevated railroad after night when the monster merry-go-round is lighted by thousands of incandescent lights. The two rows of lights give the appearance of two immense wheels of fire.

VISITORS at the Fair will be interested in learning that the light but substantial building occupied by the Oil Well Supply Company, which is seen from the intramural cars just south of Machinery Hall, was built by the well known Shiller Bridge Company, of Pittsburg, Pa.

ACCIDENTS at the Fair have of late been rare. R. McSmith, however, spent several days nursing a sick toe, caused by dropping a section of the moving sidewalk on that useful member, and Mr. Putman, of the W. F. & J. Barnes exhibit narrowly escaped amputating his own finger in a cog wheel.

THE Westinghouse direct coupled unit in Machinery Hall has just been put into commission. The generator is a continuous current multipolar and the engine a compound Allis-Corliss. The armature is in the shaft between the two main bearings and a fly wheel is provided to steady the speed.

FRENCH bells for electric work are shown by A. Domage, of 74 Boulevard Voltaire, Paris, in Machinery Hall. They are in round, twisted and link type and finely finished. A 32-inch belt made of pieces of leather cut $\frac{3}{4}$ of an inch wide and sewed together with the edge for bearing surface is a notable feature.

R. W. POPE, secretary of the Institute of Electrical Engineers, and his cordial welcome to the cool quarters of that body, are appreciated by all visiting electricians. The Institute headquarters are in the gallery of the Electricity building, in the south end. At any hour of the day several well known electricians may be seen there.

THE intramural road is doing a good business every day and evening. There is nothing more restful after a hard day's tramp about the grounds than a cool, high ride on this road. The view from the line at night when the electric lights render the World's Fair the Jackson Park addition to Paradise, is second only to a view from the Ferris tension wheel.

ONE of the double reduction camels in Cairo street surprised a harmless looking dude the other day, by making a single mouthful of his hat. The headgear was of the circus tent variety and no doubt when the camel comes to die and his stomach is examined (see Wood's Nat. Hist., vol. 1, p. 770 et seq), a hat string and a silk marker will be found wound up in his stomach.

NEAR Queen & Company's exhibit, in the northeast part of the Electricity building, the Miyoshi Electrical works of Tokyo, Japan, have installed an interesting exhibit of bamboo electroliers and a number of large views of earthquake scenes. The company was founded in 1883, and makes dynamos, motors, telephone and telegraph material. The work is characterized by the usual Japanese delicacy of execution.

CALIFORNIA is one of the best represented of all the states. Besides the big California building, the Mining, Agricultural, Transportation and Manufacturies buildings contain worthy exhibits of Californian skill and soil. In Machinery Hall, the Golden State and Miner's Iron Works, of San Francisco, shows a slide valve Corliss engine, the invention of I. F. Thompson. The leading features are: one eccentric, all flat side valves; exhaust valves fixed; steam valves, quick action. It stands in Section M, No. 43.

THE VAN NUIS AND THE ALBERT & J. M. ANDERSON EXHIBIT.

AT the very beginning of street car row on the north side and at the end thereof is the very complete display of Albert and J. M. Anderson, of Boston, side by side with the exhibit of Ajax switches and Fulmen lightning arresters, shown by C. S. Van Nuis, of New York. Both are under the complete care of T. A. Matthews, of New York.

The Ajax switches are mounted upon three slate panels and make a handsome showing of shining brass against the black background. They are of 400 amperes capacity, one, two, three pole station types, and of the neatest and most durable construction. Weston ammeters are attached. The center panel contains also an Adjax lightning arrester which has had the best of results in actual use. A prominent electric manufacturing company

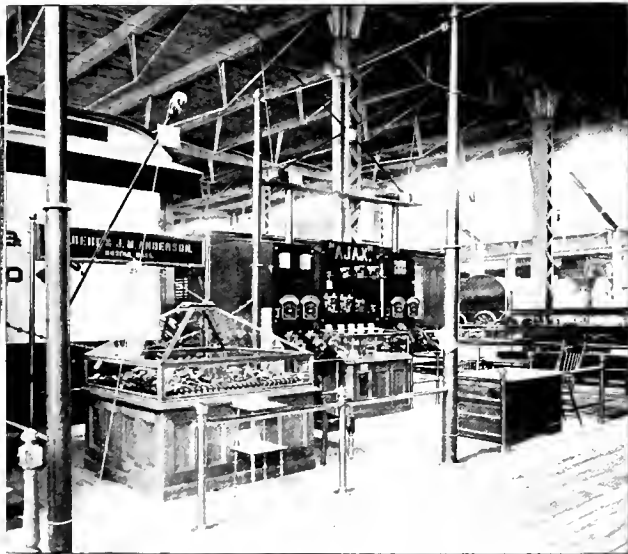

THE ANDERSON & THE VAN NUIS EXHIBIT.

located in Electricity Building, recently bought a number of Ajax arresters for protection of their exhibits, after learning the lesson of prevention by losing \$2,500 of valuable machinery in one fell stroke.

The inventor of these appliances gives his personal and undivided attention to this improvement and construction of his specialties, which insures their workmanship and reliability. The central station man who neglects to investigate the Adjax switches and arresters makes a serious mistake.

A. & J. M. ANDERSON

have a very artistic and complete display of their specialties immediately to the west of the Van Nuis exhibit. Here, extending across the entire space is a trolley wire, completely arranged with joint insulators, bracket arm insulators, hangers, Aetna railway bell insulators and other A. & J. M. Anderson line material.

On a fine oak stand near by, a glass exhibition case shows a full line of the above materials, together with the

other well known Anderson specialties, including bracket arm hangers, bridge insulators, G. N. single curve pull off and double pull off, Globe strain insulators and the famous Brooklyn insulators, trolley wire ears, anchor or strain ears, feeder ears, spare lamp bracket, trolley wheels, base and parts of the Boston trolley and the famous West End trolley wheel.

On the floor at the west limit of the space, unfortunately not well shown in our engraving, is a Pivotal Boston trolley complete. The base is movable laterally, to accommodate curves and switches, but at the same time is of strong and durable construction, long enough to distribute the strain and as light as is compatible with security. The pole may be pressed almost flat to the floor, so that its action on the car roof would permit the passing of low bridges and under doors without danger or inconvenience. It always rises to the occasion and its depression is only momentary, two very good attributes of trolley poles as well as of men.

The exhibit attracts wide attention among all classes of street railway men, from the manager to the conductor, one appreciating the line work and economy of the Anderson apparatus and the other becoming quite ecstatic over the Pivotal Boston trolley. The trolley is equipped with the West End trolley wheel, which attracts its due amount of attention.

Mr. Matthews, the gentleman in charge, is interested in the Ajax specialties, but is also capable of giving pointers on the Anderson materials.

THE WIRE EXHIBIT OF THE ROEBLING SON'S COMPANY.

THE exhibit of John A. Roebling Son's Company although closely allied to electrical and transportation interests is to be found in the Manufacture Building near the northeast corner of the main floor. The view here shown was taken from the north gallery looking southwest. The most prominent feature of the exhibit is of course the big cable reel, a description of

which can be read from the photograph itself. It represents the size and form of construction of the reel upon which will be shipped the cable for the Third avenue line in New York. It is twelve feet in diameter and ten feet wide. The cable is 1½ inch, the size that is now running

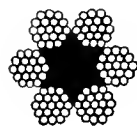

on Broadway, a section of which is here shown. It is composed of six strands of nineteen wires each. The painting at the south is of the Brooklyn bridge; that wonderful engineering achievement which immortalized the name of Roebling. It is by William H. Lippincott, of New York and is a view from the Brooklyn side looking southwest. The exhibit of course contains some samples of the cable used in this structure. They are composed of 6,000 No. 7 galvanized steel wires laid straight and bound together every 8 inches. Each side of the picture are rosettes of wire rope tapering from 3 to ¼ inches in diameter. Below these are specimens of flat

wire rope. One of the standard grips of the Chicago City Railway is a feature of the exhibit, as well as a number of sheaves and other appliances for rope transmission. In the line of copper wire for electrical purposes there is a pyramid of different sized reels of crescent rubber covered wires, a show case full of magnet wire for field and armature winding, and a one mile reel of No. 0 hard drawn copper trolley wire, besides a num-

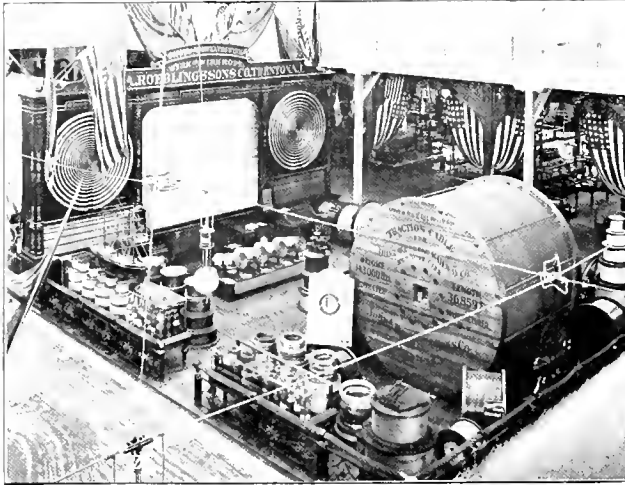

THE ROEBLING EXHIBIT.

ber of minor samples of lesser importance. Lead covered cables for underground work are shown in a variety of forms one specially interesting feature being a board of sample joints for lead covered cables. Taken altogether this exhibit is one excellently typifying the important part Roebblings Son's Company has played in the engineering works of this country, during the term of its existence. The display is in charge of Chas. H. Sewall.

THE TAYLOR TRUCK EXHIBIT.

THREE spaces are jointly devoted to Taylor trucks in conjunction with other devices. In the Transportation Building, the J. M. Jones exhibit shows a truck fully equipped under car, as mentioned and illustrated in the June number of the STREET RAILWAY REVIEW.

At Z, 4, Transportation, there will also be found a Taylor truck in joint showing with the Genett air brake, described in a previous issue of the REVIEW. The truck here is raised off the floor, and may be examined with great ease.

In Electricity Building, with the General Electric Company's exhibit, is shown a Taylor truck, upon which is mounted a Thomson-Houston motor. The exhibit is altogether a practical one, showing the Taylor truck mounted with motor, carrying the car body, and its action under the Genett brake.

The Taylor Company is now getting ready to manufacture a new double truck, from which the best of results are anticipated. Experts to whom the plans have been shown pronounce it a first-class article.

BROWNELL'S ARTISTIC EXHIBIT.

IF ever art has risen to its highest ideal and "felicitous fulfillment of function," illustrated to the joy of the artist and the pride of the practical man, street car row in the Transportation Annex shows it.

In aisle L, next west of the A. & J. M. Anderson exhibit, stands the Brownell car, which is the immediate animus of the above remarks. The car is of the accelerator pattern, on which President F. B. Brownell has been granted patent rights, and the design of the car is to show the artistic and novel in street cars for exhibition and not for competition. It is hardly worth while to state here the many advantages claimed for the accelerator, but suffice it to say that the points are: First. In location of the doors so that larger loads can be carried inside the car and on the platform, with a minimum of time for unloading with comfort and safety. Second. The increase in receipts and reduction in expenses consequent on the above conditions, with the results given in the Latin motto on the car displayed.

The car shown at the Exposition is of the 20-foot body closed pattern, with 4-foot platforms, thus making 28 feet over all. The width of the body is 7 feet 6 inches at arm rail, or over all 7 feet 10 inches. The capacity is "room for one more," with seats for 26 and room for 112 passengers without obstructing the passage to and from the street.

Beginning with the ground. The car is mounted on a Brownell improved non-oscillating electric motor truck, fitted with Brownell & Company's improved radial draw bar, with eye-beam slider, and the steps are solid wrought metal with rubber pads.

The car is painted in Cadmium yellow and white, lettered in gold in pure empire design, harmonizing in every detail with curtains, rug and carvings. The whole effect being congruous and elegantly quiet.

On one panel appears the following Latin legend: "Capacitas, pecuniae, dividendae, commoditas," which means capacity, money, dividends and commodiousness.

The scheme of interior decoration is to show what civilization has accomplished in the new world since the Columbian advent, celebrated by the Exposition. The color scheme of the interior is white and gold. The ceiling is decorated by artists whose works have held place in the salon of Paris. In the decorative work and with the above mentioned motif, one side represents semi-realistically the Puritans of New England, and the difficulties encountered by them with the Indians, even in their worship; the great prairies, the buffalo and the Indian; the far west, the cliff dwellers and the deserts. The opposite side shows the change resulting from the victory of civilization over the rude, wild and untamed. The figures represent science, sculpture, painting, music, mining and agriculture. The dome shows a discoverer of the new world with olive branches, and a goddess of plenty with roses.

The seats and backs are old gold colored silk plush upholstered with curled hair, and the glass, in keeping, is

polished plate. The curtains are satin damask ivory and gold and the doors are of select mahogany, four to a car, accelerator style. The floor is laid with wood slat mats covered with walton rugs.

The seat fronts are of 3-ply veneer perforated, and finished in white.

The metal trimmings are gold plate, Roman gold finish, and the lamps are combination oil, with electrolier in the center of the car.

The car roof is of the Brownell improved trussed form; the outside section being made of 3-ply veneer in one piece, all surmounted with their patented improved trussed trolley bridge.

The whole car is a picture of elegance and attracts the careful examination of every passer-by.

pany, has general oversight of the exhibit; but the cars speak for themselves.

The art decoration is the most expensive ever put into a street car and cost \$2,000, and are worthy of Mr. Brownell's well known ability to judge in such matters. In closing, we might state that the Brownell exhibit is built for exhibition only and not entered for competition.

THE EUREKA TEMPERED COPPER COMPANY, OF NORTH EAST, PA.

ON the west gallery of the Electricity building, south of the center, the Eureka Tempered Copper Company, of North East, Pa., has a beautifully designed booth, the walls and floor of which are

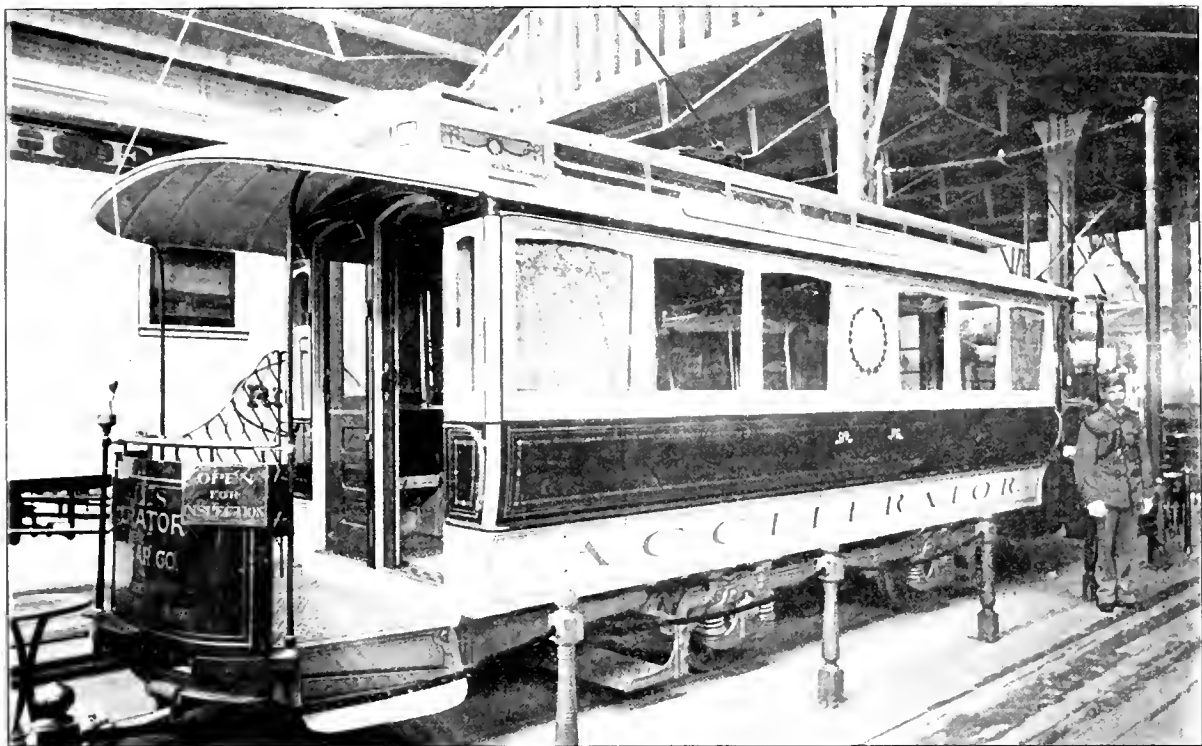

BROWNELL CAR COMPANY WORLD'S FAIR EXHIBIT.

A few of the minor details, which go far in the general appearance of the car, are the oval, beveled plate glass mirrors on the interior, one on each side, in white and gold hand carved frames, and the circular exterior of the platforms with wide nose pieces, giving a straight exterior outline.

The car can be turned into a summer car by removing all doors and using storm curtains.

Next to this beautiful car is a complete Brownell Car Company truck and burglar proof fare box, which complete the exhibit in the Transportation Annex.

In the Electricity Building, however, the joint exhibit with the Westinghouse Electrical & Manufacturing Company, shows another accelerator ready, wired and waiting the inspection of visitors.

Sales agent W. B. Allen, of the Brownell Car Com-

pany, devoted to the display of the products of tempered copper.

The wall case is divided into eight compartments, filled with commutator bars, roll goods, trolley wheels, armature bearings and fine cast copper specialties. This process of annealing copper was discovered accidentally by an oil prospector in Pennsylvania, who immediately took advantage of this fortuitously gained knowledge and has built up around the discovery a magnificent and increasing business.

The Eureka Company publish several analyses and substantiate the claim that no chemicals are introduced to bring the copper to the degree of hardness shown, and mechanical experts have tested the strength of the finished product most severely.

The company makes particular application of its goods

to electrical industries and besides the specialties mentioned above have been doing a large and satisfactory business in dynamo brushes. Many flattering recommendations from light and power plants all over the country give evidence of the truth of the statements.

THE W. F. & JOHN BARNES EXHIBIT.

ONE of the most noticeable exhibits in the beautiful Machinery Hall, is that occupying section 14 Column J, 36 and filled with the products of W. F. & John Barnes, of Rockford, Illinois. The exhibit is at the south-west corner of the fountain square. In the center of the group of machines and drills a pretty turret, or small tower, on the top of which the friends of the company may observe Machinery Hall in a birds-eye view. All visitors will be made particularly welcome by J. E. Putman, of Rockford, who has charge of the exhibit.

five, five-and-a-half and six lathes are also on exhibition and ready for inspection, these are for fine machinists and particularly adapted to the use of electricians.

One of the most interesting of the machines shown is an engine lathe without the cone pulley. The different speeds are obtainable by a equal arrangement of the friction disc and leather bound pulley, which takes the place of the cone pulley. The sixteen-inch friction lathe is claimed to have 20 per cent greater efficiency than the old style cone pulley lathes. This lathe is shown in operation at the exhibit and attracts considerable attention.

COL. D. B. DYER, of Augusta, Ga., well known to REVIEW readers as president of the Augusta Railway Company, has a most interesting collection of Indian curiosities, which he has kindly placed on exhibition in Anthropological building at the World's Fair. The the

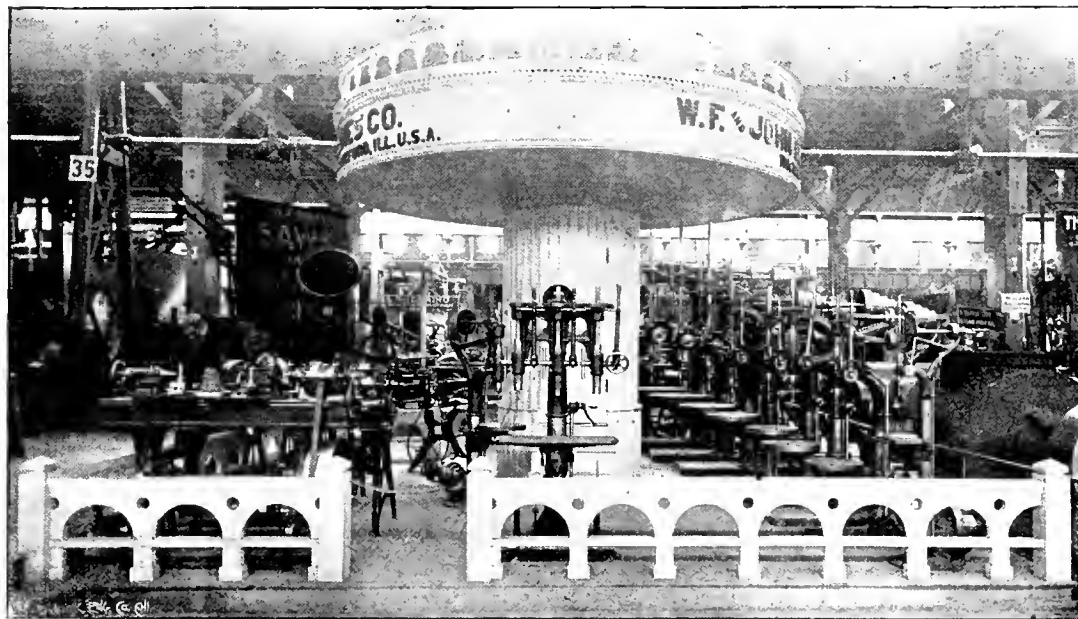

THE W. F. AND JOHN BARNES' EXHIBIT.

Ranged about the center turret the observer may see every appliance manufactured by W. F. & John Barnes.

Of particular interest the REVIEW man noted a new 20-inch drill, which has a self feed and automatic stop. The company claims that this drill is the best produced and are willing to place it in competition with any drill of the same size in the market. In addition the back gear is on the 22½-inch drill. The drill is a beautiful instrument and gives the following feeds; lever feed, hand worm feed, power self feed, automatic stop and quick return. Each feed may be used independently of the others and without requiring any extra motion on the part of the operator.

The friction disc drill is shown and the sensitiveness and work at any range of speed is shown. Twenty-inch, 22½-inch, 25-inch, 28, 34 and 42-inch drills are shown, all running.

Foot power lathes are shown either with velocipede or treadle motion. Their number four, four-and-a-half and

exhibit occupies a prominent position in the northwest corner of the main floor of the building. The collection was made while Col. Dyer was in the Indian service and includes among other objects of interest, an Indian "tepee" model complete, the famous Washington medal presented in 1795, the Harrison peace pipe presented in 1814. Both of these are in solid silver. An elk tooth dress made of 1,500 elk's eyeteeth, and a Cheyenne scalp shirt, decorated with the hirstute appendages of 100 Ute and Pawnee polls. The remaining features of dress and equipment are well worth seeing.

THE government of Madras has refused the extension of six months' time on the construction of the Madras Tramways. The reason given for refusal is that the guaranteed capital of \$375,000 was not paid upon time. The Indian press deprecates the action of the government saying that the people should be consulted.

THE SHEFFIELD CAR COMPANY AT THE FAIR.

ABOUT January 1 the Sheffield Velocipede Car Company changed its caption leaving out the word "Velocipede" as a restrictive clause. In fact the scope of operation as well as the increase in business in every department demanded a heading that would signify the enlarged operations of the company. The Sheffield Car Company of Three Rivers, Mich., makes every variety of light cars, railway velocipedes and specialties of a like nature. Their factory is well equipped in every particular for the accomplishment of special work, making every part of a light car from wheel to handle.

At the World's Fair the Sheffield Company has a

The Westinghouse Electric & Manufacturing Company has in its railway exhibition a side equalizing street railway truck of the Sheffield make.

The cross equalizing truck known to the catalog as No. 1. E. Truck is built for either double or single reduction motors and adaptable for any make. Its weight is 3600 pounds with a wheel base of 6 feet. The wheels are 33 inches diameter. The side equalizer cataloged as No. 2. E. Truck is essentially of the same dimensions but different in design.

The Three Rivers equalizing electric motor trucks, claim five points of advantage, namely; less wear on the track as the blow on the rail is to a degree modified; longer life of car body, as all twisting strains are obviated; great ease and comfort to the passengers; less expense in motor repairs; freedom from oscillation.

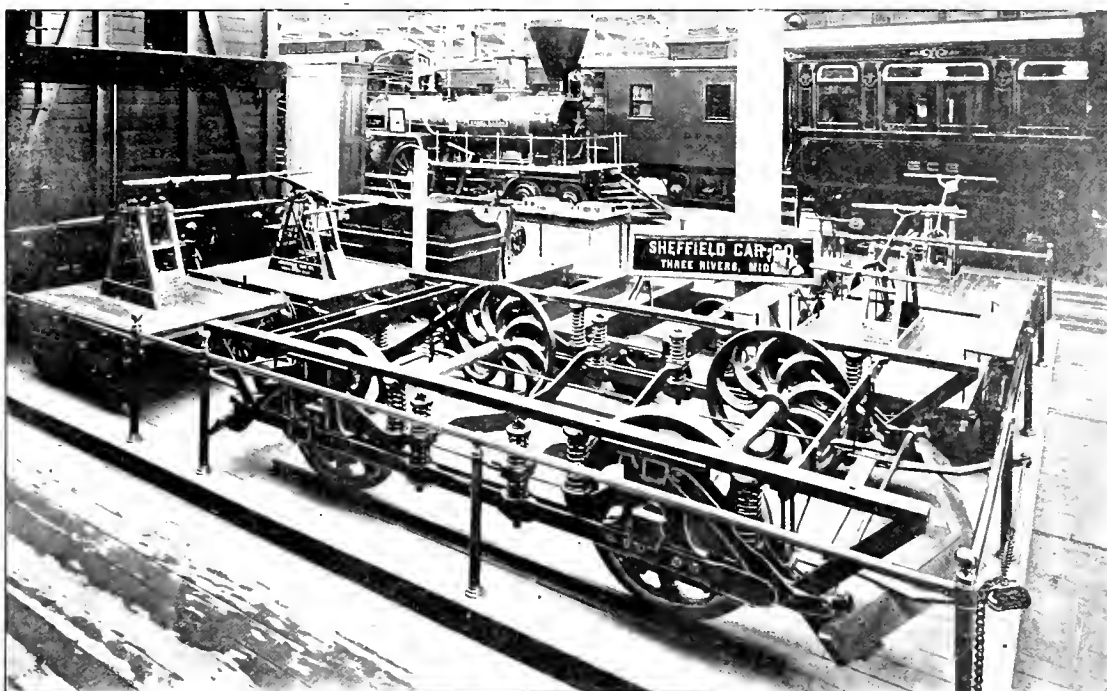

SHEFFIELD CAR COMPANY'S WORLD'S FAIR EXHIBIT.

magnificent exhibit a part of which is shown in our engraving. The space occupied is N., N., and O., s., posts 13 and 14, Transportation Annex and the display is a complete catalog of the devices and cars made by the Sheffield Company.

Here are shown a cross equalizing street car truck, railway and tunnel velocipedes, number 1 and 2 hand cars, a light inspection car, a track laying car, a side dump car, a center dump car, two plantation cars such as are use extensively on the sugar plantations of Louisiana, flat cars, and a sail car, a new scheme for harnessing the wind for the benefit of the inspection gang and an odometer car for measuring track mileage. The latter is of the greatest importance to railway superintendents and is the invention of a practical man. In fact most of the cars shown are designed by men who have had the greatest experience with cars for the various uses intended.

In the No. 2. Truck the strain is equalized by a side equalizing bar introduced upon one side of the truck, thus giving a three point suspension to the car body giving the advantages discussed above. In the No. 1. truck the equalizing of the strains is provided for by a cross equalizing bar introduced at one end of the truck giving as in the other case, a three point suspension. The absorption or neutralizing of strains is thus accomplished, to the benefit of the track and the saving of the motor and car body. As to the construction of the trucks their strength and durability are due to the care used in the selection of material and the heavy type of the material used. The wheels are of improved pattern and ground to a perfect match in circumference after being pressed upon the axle. Any special make of wheel will be furnished to specification. The axles are solid rolled steel fitted up as nearly perfect as possible. The boxes are of improved type and self-oiling.

The bearings are made for heavy and continuous wear and are accurately fitted to the axle. The supporting truss rods of the trucks being carried wholly on the spring base gives special facilities for carrying long bodies upon short wheel base with large carrying capacity without the use of double truck cars. The workmanship of the trucks is first class throughout and the best results have been carefully kept in view.

The exhibit is in charge of E. B. Linsley, of the company who will take pleasure in quoting prices and substantiating claims. Among the roads using these trucks may be mentioned; The Pleasant Valley Street Railway, of Pittsburg, the Allegheny & Manchester, the East Cleveland line of the Cleveland consolidated, the Milwaukee Street Railway Company, The Utica, N. Y. Street Railway Company, the Lindell of St. Louis, and the Chattanooga, Tenn., Street Railway.

GEO. CUTTER IN ELECTRICITY BUILDING.

NOT far from the executive offices of the Electricity building on the east side of the gallery George Cutter has installed an exhibit that is equally interesting to the electrician and street railway man.

The display is arranged on several display boards, three of which are shown in our engraving. The artist found that, to get an adequate idea of the exhibit with a camera

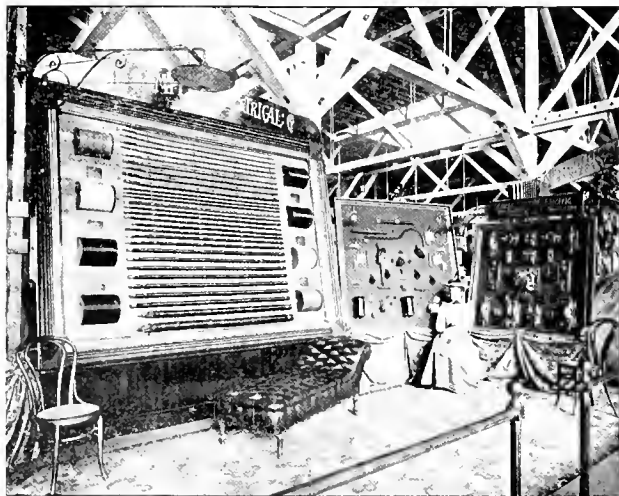

GEO. CUTTER EXHIBIT.

a part of the exhibit must be left out. Hence there is not shown a full display board of P. and S. china cleats and some other of the Cutter specialties. One prominent feature is the large display of wires made by the Simplex Electrical Company. Among these are some fine caoutchouc cables such as have been used both for station connections and for mains in prominent Chicago buildings; the one at the lower edge of the board being four inches in diameter. Another sample which was shown our representative with much pride, was that of the 500,000 circular mil feeder wire, of which ten tons have been used

by the Chicago City Railway Company. Other sizes are shown in abundance. Then there is a small display of fine French carbons, such as Mr. Cutter expects to furnish for motor and dynamo brushes.

The remainder of the exhibit is devoted to Mr. Cutter's own specialties, including the "devil in the cap" pulleys. The Boulevard street hoods, described in our last issue, light the space at night, and Simplex tree insulators are shown to advantage. There are shown besides a number of electric light devices and the Pattee lamp-hour recorder which is frequently used as a meter on 500-volt circuits. Another show board has a fine line of main switches in single, double and treble pole styles, ranging up to a thousand amperes. In designing these Mr. Cutter has discarded the use of an auxiliary contact close to the joint, and carries the current to the blades through a series of thin and flexible copper ribbons. In this way he gets plenty of carrying capacity at the joint without increasing the work of throwing the switch.

Mr. Cutter or his representative will always be at the space to explain these devices and welcome the street railway or electric light man.

SIEMAN'S MULTIPHASE RAILWAY MOTOR.

TO the electrician there is not, perhaps, within the walls of Jackson Park, a space containing a display of more absorbing interest than that of the Siemens Company, of Berlin, Germany. To the railway electrician the exhibit of the great German firm is of particular importance in one respect, in that it has on exhibition a complete review of the recently completed three phase tramway system, perfected and tested last winter at the Charlottenburg factory of the Siemens Company. It will be remembered by readers of this magazine that the April number contained a short notice of a 1,100-foot electric railway that was to be installed as the Siemens traction exhibit. This never materialized, through no fault of the Siemens management, and the present multiphase railway exhibit is part of the material brought over at considerable expense, to complete the proposed exhibition road. The Siemens' space in Machinery hall was to have been utilized as the power plant and triphase generators, motors, transformers, and sufficient cable and overhead devices were on the side tracks for that purpose when circumstances forbid the consummation of the plan. As the Siemens multiphase and alternating apparatus are of the same type, it took but two days to change the connections of the armature of the multiphase apparatus to the use of alternating current, with the exception of the exhibit to be described.

The three phase railway motor, ready mounted on a German single truck, stands ready for inspection in the Siemens & Halske space, below the northeast gallery of the Electricity building, under the immediate supervision of Mr. Caemmerer, of the Charlottenburg factory. The motor in appearance is smaller than the average American type and of several hundred pounds less avoirdupois,

scaling only 1,760 pounds. It is mounted on three bearings, two on the front axle of the truck and one on the rear frame. The truck-frame bearing is a rubber circular cushion, which acts as an elastic support for the motor, taking up a part of the shocks and hammer blows due to irregularity of the track. The much abused worm gearing is successfully used in this motor. The pitch of the screw is very steep, with three threads. To the steepness of pitch is attributed the ability of the motor to run down hill without the application of motive power. By turning the wheel of the truck exhibited the armature may be made to revolve. As to its efficiency, Mr. Caemmerer informed the REVIEW representative that this type of motor and gear had been in constant and successful operation at the factory road at Charlottenburg, and that it had undergone with honor the critical inspection and supervision of the imperial railway commissioner and distinguished electricians and scientists.

The motor is entirely iron clad, with the exception of a few terminals. In construction it is very well prepared for the radiation of heat involved in all continuous machines, as all know, and especially in single reduction multipolar motors. In the latter the heat is kept concentrated, and is a continual source of annoyance and expense to the user, as the efficiency is thereby impaired to a considerable degree. In the three phase motor shown, the radiation of the heat is accomplished by its generation on the exterior of the core, from whence it is readily diffused to the surrounding air.

In this three phase motor there are two points of considerable importance, especially in connection with their use in American cities where the conditions are essentially hard. The first point is, that by the use of transformers the system lends itself without the employment of very heavy feed wires to the transmission of electrical energy over great distances, and secondly, the machine is capable of very rapid reversibility. The latter is obtained by the absence of the commutator, which is substituted in the triphase by three rings, upon which brushes are set in sliding contact, so that in reversing the circuit connections on the motor, the armature acts as an extremely powerful brake, and that without sparking of any kind.

The motor shown is designed for 20-horse-power, with capabilities of exerting three times that amount for a short space of time as occasion may require, as on switches, grades or curves. This is accomplished by one movement on the part of the motor man. At the factory road the truck and car carried one of two trailers, and experiments were made to test the braking capacity of the motor. The load was represented by weights put in the car. At a speed of about 12½ miles an hour the machine was suddenly reversed, stopping the train within a car's length. All the inanimate passengers having been previously warned to "hold on tight," no casualties or bruises were reported to the claim agent. The starting torque, as hinted above, is very great, and the motor starts the instant the current is sent through the windings.

To explicate the construction and use of the three phase system, which may not be very well understood by

American street railway men, a few general remarks may be added. In this system three wires are necessary, ordinarily two overhead trolleys and one ground wire for the third current, similar to the American practice of return current, completed through the rail. This is to an extent a drawback, but less serious than appears at first sight, and only of this nature as long as we compare this system with the single trolley system. However for elevated roads, underground or conduit systems, these objections cease or become insignificant. The overhead structure is by no means unsightly and the speed of 12½ miles an hour (recorded above) is not the maximum speed of the motor. The recorded speed was that attained on the factory road which was especially constructed for a test road. The factory line has a length of about a mile, with a sharp curve of small radius in the middle. The system requires a triphase dynamo and a system of converters. In the road contemplated at the World's Fair the current was to have been generated at 400 volts, which is then transformed by step-up transformers to 3000 volts for the transmission line. At various points on the railway system step-down transformers are placed, whose induced current is sent to the trolley wire at 600 volts potential for use by the motor. By this means all the concomitant advantages of the continuous and alternating currents are obtained, together with the economy attending a cheap overhead construction and long distance transmission, without loss of energy. In this way a water power which may be many miles from the town or seat of operation of the light or power company may be utilized and as water power is ordinarily inaccessible, long distance transmission holds out some brilliant possibilities under circumstances fatal to ordinary practice. The transformer belonging to this system is also shown at the Siemens-Halske space and is worthy of particular mention. This transformer differs from American practice inasmuch as the latter practice is to use three transformers of standard type rather than designing new construction, while the Siemens-Halske transformer consists really of three transformers, whose magnetic circuits are closed only through one another, thus making this multiple transformer a single self-contained device for this special purpose. This transformer is under American patent right.

Thus by means of transformers any generating voltage may be used, together with any safe voltage for the motor, bringing up a number of possibilities for the economic operation of light and power plants. The special agent at the Exposition reports a commercial road in Europe now under construction.

THE West & South Town Road, of Chicago, will be equipped by Siemens-Halske of America.

A NEW cable grip has been invented by Henry A. Shipp, of Atwater, Cal., in which the chief novelty lies in the gripping action of the jaws, which instead of being opposite are placed one in advance of the other and simultaneously working on opposite sides of a fulcum.

MCINTOSH AND SEYMOUR AT JACKSON PARK.

NEARLY in the center of the great power plant in Machinery Hall, or to speak by the card, at Section H, Column A. B.—23 stands the largest of the exhibits made by McIntosh & Seymour, of Auburn, N. Y.

This is the 1,200-horse-power double tandem compound engine illustrated herewith, and deserves a longer description than our space admits. Its dimensions are as follows: diameter high pressure cylinder 18 inches, low pressure 32 inches, common stroke 36. Its speed is 112 revolutions per minute. The main bearings are 14 inches in diameter by 24 inches in length and the diameter of

The copper heating coils in the receiver are fed from the high pressure cylinder steam jackets. The main bearings are provided with water jackets. Ball and socket main bearings are provided with oil settling chambers and circulating pumps for continuous oiling.

Besides this engine in Machinery Hall there will be found in the Intramural power house a 290-horse-power McIntosh Seymour tandem compound condensing, coupled direct to a 200 kilowatt General Electric railway generator. This engine has a 13-inch high pressure cylinder 23-inch low pressure with a 22-inch stroke. The steam pressure is 125 pounds. The speed is 150 revolutions per minute.

In Electricity Building a similar engine of 350-horse-power is coupled to an alternating dynamo with provi-

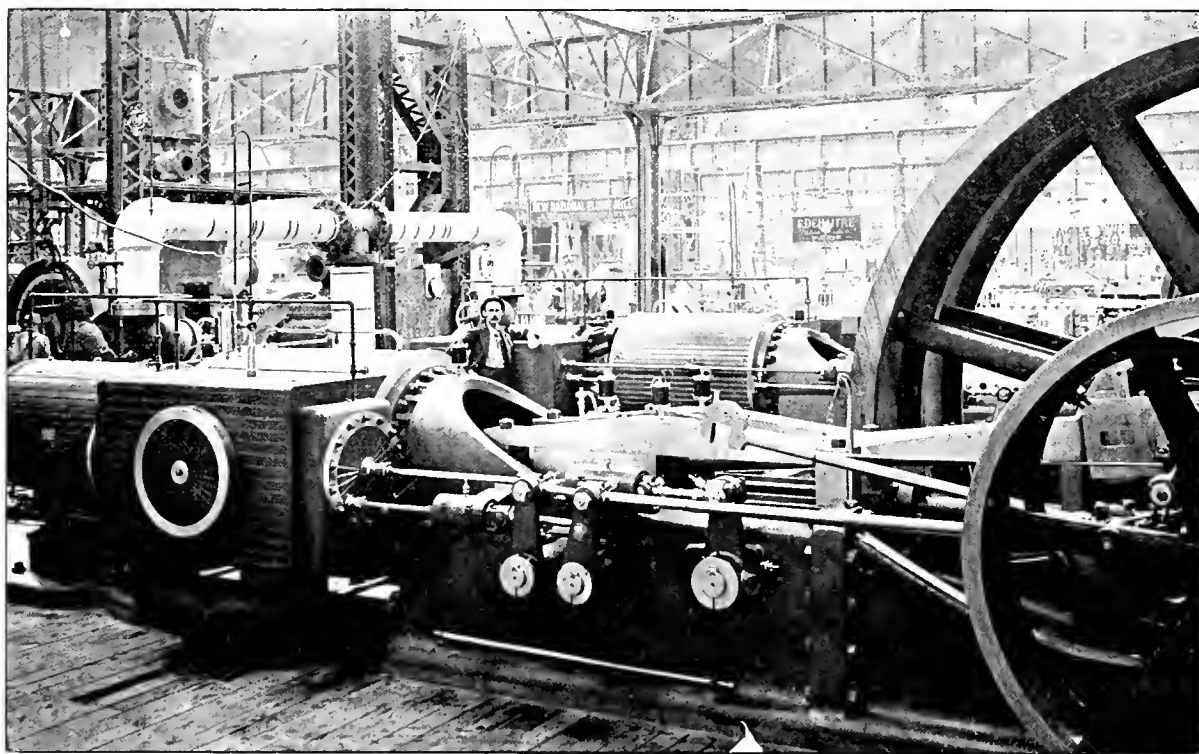

MCINTOSH & SEYMOUR DOUBLE TANDEM COMPOUND, 1,200 HORSE-POWER.

the shaft between the bearings is 16 inches. The fly wheel is 16 feet in diameter by 78 inches face, with a weight of 62,000 pounds, making a total weight of the engine 250,000 pounds.

The engine is strongly built and all wearing parts are cast from a special heat of hard, close grained charcoal iron. The pistons are hollow cast and put on the rod by forcing upon the taper, with shoulder beyond and held in place by a nut secured by a locking device.

There are several features to which attention is called. The main valves are of the piston type with adjustable seats, and auxiliary cut off valves are driven by the governor.

All valve gear is driven from auxiliary drag link shafts giving free access to parts without disturbing the shaft.

sions for sliding field piece away from the armature. This is in section C, space 9.

The McIntosh and Seymour representation does not show the smaller types which are made by this company nor the large vertical engines of different types.

At a recent meeting of German engineers at Wurtemberg, in a lecture on the comparative cost of electricity and compressed air Mr. Cox gave the result of some thorough experiments. The basis was the transmission of 217-horse-power over a distance of three miles. Compressed air cost \$37,500 and electricity \$27,500. In efficiency Mr. Cox averred that electricity was superior in a ratio of 69 per cent against 46 per cent.

BUCKEYES AT THE FAIR.

UNDER the charge of E. Baillie, the Buckeye Engine Company, of Salem, Ohio, has a fair and complete exhibit of their various types of engines in Machinery Hall. Some months ago the REVIEW gave a catalog of the Buckeye engines that were to be placed. This month we present an engraving of a part of this fine display, together with a more detailed account of the engines shown.

The exhibit is prominently placed; occupying a position a little west of the center of the power plant and running north and south.

The first that salutes the eye is the large proportions of a triple expansion condensing engine of 1,500-horse-

horse-power, slow speed, 110 revolutions per minute. The cylinder is 16½ inch bore and the stroke is 30 inches.

A medium speed, simple engine, non-condensing, of 130-horse-power is number five. It turns 175 and has a 13-inch bore and 21-inch stroke.

The sixth and last is a high speed, non-condensing, 130-horse-power, 225 turns, with cylinder measurement 13 by 16 inches.

An interesting feature of this display is, however, not apparent from the outer aisle and the investigator should go to the southwest corner of the space, where a unique arrangement shows the cylinder and valve gear of the Buckeye type of engines. This is done by dividing the cylinder and valve gear longitudinally showing the "ground plan."

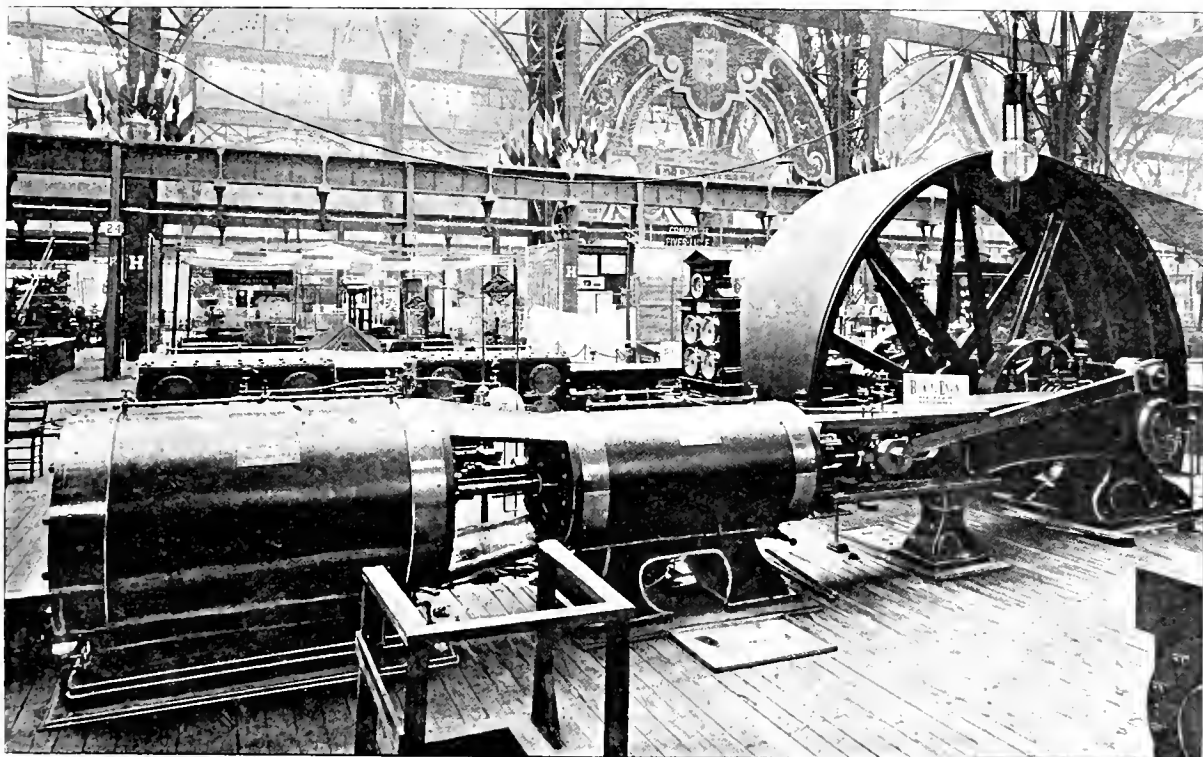

BUCKEYE 1,500 HORSE-POWER TRIPLE EXPANSION ENGINE IN MACHINERY HALL.

power. Its speed is 85 revolutions per minute and its cylinders measure for the high pressure, 20 inches; for the intermediate, 32½, and for the low pressure, 36 with a 48-inch stroke. The band wheel of this engine is 20 feet in diameter with a 74-inch face and weighs 25 tons.

The second engine is a cross compound, medium speed, 150 revolutions and 350-horse-power. Its high pressure cylinder is 14½ inches; low pressure, 28 inches with a 24-inch stroke.

The third is a tandem high speed, non-condensing, of 175-horse-power, with 225 revolutions per minute. Its cylinders measure 11 inches for high pressure and 21 inches for low pressure. It has a 16-inch stroke.

Number four, a simple, non-condensing type of 180-

By a manipulation of the governor the different points of cut off can be seen from the earliest to the latest. The valve gear is in motion from a small counter shaft, and the cut off can be observed from the beginning of the stroke to 3-5 of the stroke. This detail is as happy in execution as in idea and is surrounded continually by visiting stationary engineers and interested power users.

"This is an oil-fired mean trick," said the boiler flue to the oil burner at the Exposition-plant.

"Well, you need not get hot about it" replied the burner. But just then the safety valve began to hiss: so peace was restored and the belligerents smoked together in silence.

MCEWEN'S ENGINE.

OCCUPYING section C. No. 13, of the Machinery Hall power plant, the McEwen Engine Company, of Ridgeway, Pa., has established one of their well known engines in actual service. The engine in question is a standard type tandem compound condensing of 200-horse-power. Its high pressure cylinder is 14 inches, low pressure 23 inches and stroke 18 inches. Its speed is 220 revolutions per minute. The engine carries two band wheels of 84 inches diameter and 16-inch face. The steam pipe for the McEwen engine is 5 inches in diameter and the exhaust is 10 inches. The total weight of the engine is about 22,500 pounds.

The engine drives two C & C dynamos which supply the power for the elevators in the Administration Building. The satisfactory action of the McEwen engine, its cool running and its quietness are points clearly visible

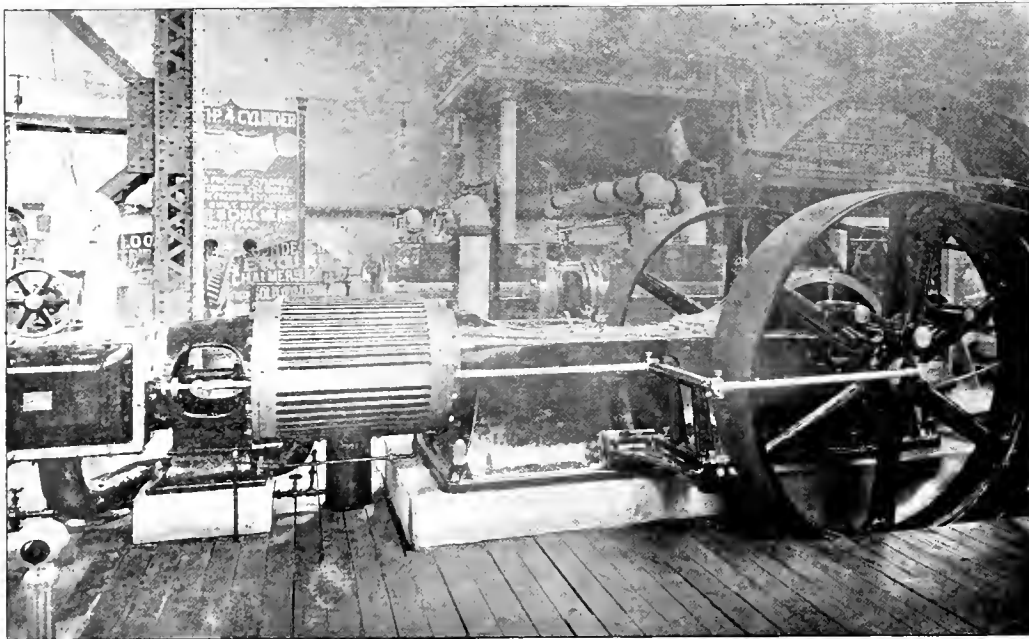

MCEWEN ENGINE AT WORLD'S FAIR.

and to assure the buyers that everything is as represented, a fine brass sign shows the following guarantee. This guarantee reads:—

“The engine shall not run one revolution slower when fully loaded than when running empty and a reduction of boiler pressure from the greatest to that necessary to do the work will not reduce the speed of the engine one revolution. Any engine failing to meet this guarantee becomes the property of the purchaser upon the payment of \$1.”

IN New Orleans some malicious person placed a pistol cartridge on the street car track. When the conductor of the first car to pass, ran ahead to signal his car over a railroad crossing, the bullet was exploded and wounded him in the leg.

ELECTRIC LINE ON ST. CLAIR STREET, CLEVELAND.

THE work of changing the St. Clair street line Cleveland, from horse to electricity is progressing nicely. Additional engine power is being put in the station of the cable road for the purpose, the selection having been a 300-horse-power Bass engine of the Corliss type. The track is being relaid with 90 pound girder, nine inches deep, laid on ties spaced to two feet, and spliced with a 38-inch joint splice, using 12 one-inch bolts. When completed there will be no better in the city. Wires will also be placed over the Superior street cable line to enable the West Side electrics which came into the consolidation, to operate into the East Side. When in working order alternate cable and electric cars will use that line from the viaduct east. The cable cars will not be abandoned as reported in several electrical journals.

ELECTRICITY DRAWS THE TRAFFIC.

SINCE some time in May, the Thirty-fifth, Forty-seventh and Sixty-first street lines of the Chicago City railway have been operating with electricity. The records of passengers carried for June 1892, and June 1893 are interesting studies. On Thirty-fifth street the receipts were \$5,000 above June of last year. On Forty-seventh street the increase was \$8,000 over last year. On Sixty-first the increase was \$40,000 over last year, but this latter does not form a good basis of comparison because the World's Fair traffic must be figured in. On the first two however the World's Fair travel is extremely small. The Sixty-first street equipment uses 25 motors, each having one or two trailers which load full both ways from five in the morning until after midnight.

THE JOHN STEPHENSON COMPANY'S
EXHIBIT.

THE street car exhibit at the World's Columbian Exposition would be far from complete without the presence of the handiwork of the pioneer car builder, John Stephenson.

As it is, the John Stephenson Company, Ltd., of New York City, is well represented at L. s., Column 5, 6 and 7, Transportation Annex, by an historical and practical display. Historically, the exhibit shows two mammoth crayons of the John Mason, the first street car in all its primitiveness, and next abutting a modern cable car of the latest pattern.

The cars shown are two in number. One is a cable grip car such as is used by the Broadway line and the other an electric for the Elmira & Horseheads Street Railway, of Elmira, N. Y. In addition there is exhibited a Tackaberry truck.

The cable car is of a 22-foot body with long platforms measuring 32 feet over all with double doors at each end. These are of the twin pattern, moving simultaneously and giving ample exit and ingress. The car body rides low on the truck, the steps are wide and safe and the grab handles are specially well adapted for their purpose.

board of health, Philadelphia, has officially approved this method of ventilation. The seats extend the whole length of the car body and are most comfortably shaped, while

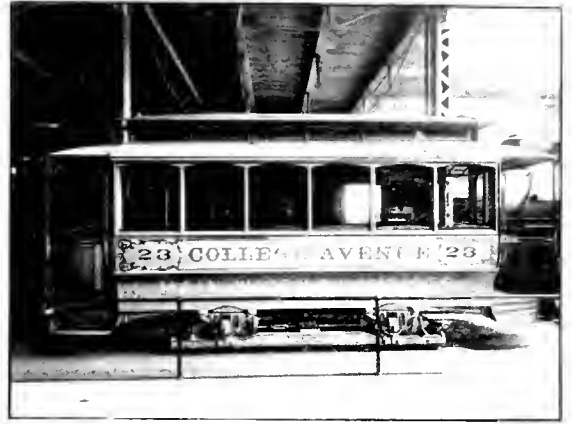

STEPHENSON ELECTRIC CAR.

the window sashes fit closely, at the same time sliding freely and noiselessly.

The Pintsch gas system used in the cars on Broadway is not shown and the cars furnished with lamps. The standard register operated by rod connection is used in the

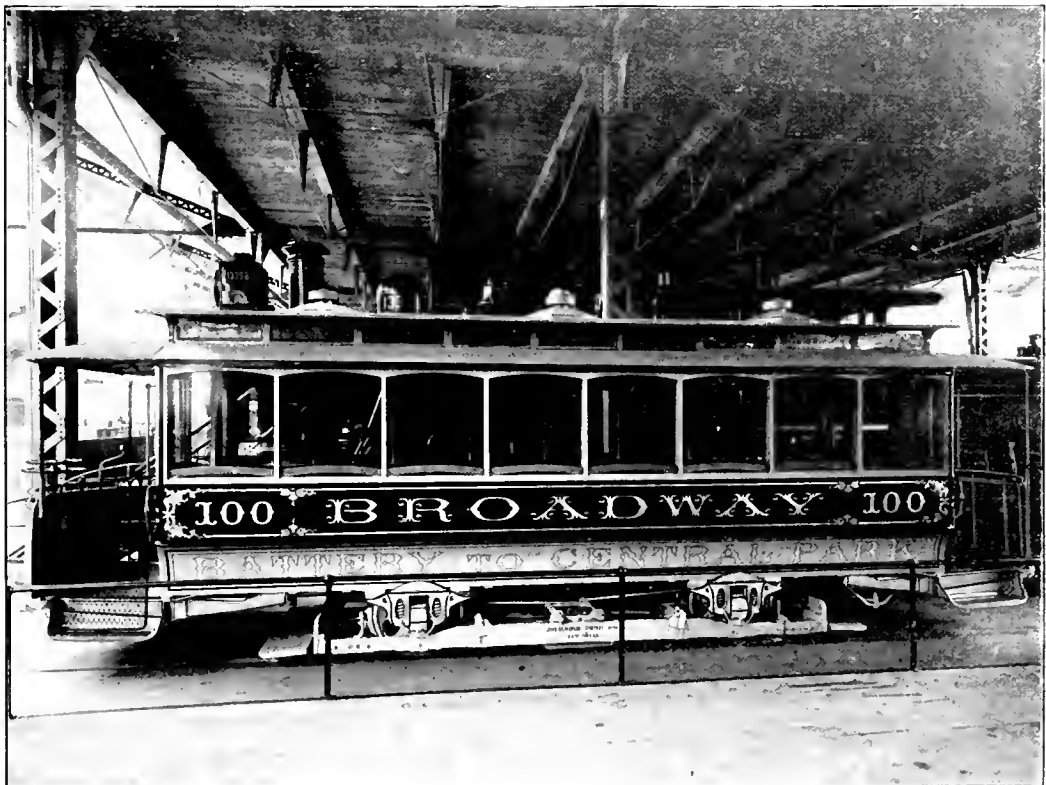

BROADWAY CAR, BUILT BY JOHN STEPHENSON COMPANY.

The car is painted buff on the outside with an elegant finish. Valentine's varnish is used and brush marks are entirely absent. The interior is made for practical work as is the entire display. The ceilings are perforated mahogany, with opening at the verges for coolness. The

car, thus preventing the passenger from assisting the conductor to ring up fares.

The car does not resemble the ordinary grip cars, as the gripman operates the brakes and grips by a wheel grip and brake, one above the other. At the right is a

lever for throwing the cable out of the grip when passing the power stations. The life guard is hinged to the front of the truck and is easily adjustable. Repairs are easily accessible.

The electric car is wired for Westinghouse motors. It painted light buff and brilliantly finished. It is mounted on a Tackaberry truck. This car is furnished in quartered oak with elegantly upholstered seats, fine window shades, double doors and surmounted by a Stephenson improved trolley bridge. The roof is monitor and the ceiling quartered oak.

The cars are both regular type work and show to the best advantage the high grade of car building done by the Stephenson Company.

The exhibit is in charge of Paul H. Pages, of New York, who is always ready to show the visitor the advantages of the Stephenson car.



P. H. PAGES.

was described in the REVIEW of February, 1891. To an American it seems strange that the country which was so early in the field with an electric railway in practical (as distinguished from experimental) operation, should at present be so far behind us in this line. The tramway in question derives its power from a waterfall. This fact is the secret of an electric line being constructed here at so early a date. The line is somewhat similar in character to some of our interurbans. The greater part of the way it is enclosed like a steam road. The most peculiar feature of the line to an outsider is the fact that "goods wagons," such as are used on the highway, are used for freight. Our engraving shows a train made up for its trip. The

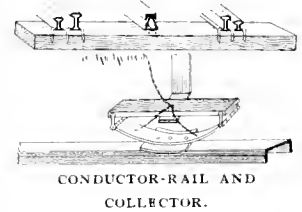

CONDUCTOR-RAIL AND COLLECTOR.

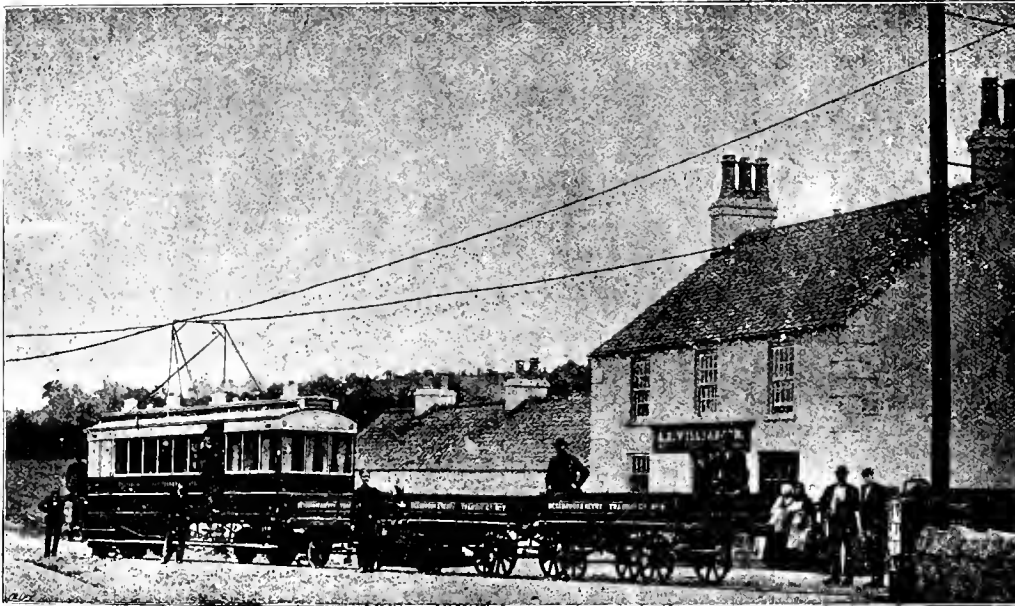

TRAIN OF GOODS WAGONS—AN IRISH TRAMWAY.

Besides the Transportation Annex exhibit the Stephenson car is shown in connection with the Westinghouse Electric and Manufacturing Railway exhibit in Electricity Building, and the Stephenson truck in connection with the General Electric railway space.

The entire display is one that will interest the practical man and send him away with a good impression of the Stephenson car.

AN IRISH TRAMWAY.

FOR eight years past an electric railway has been running between the manufacturing town of Bessbrook and the port of Newry, three miles away. There is only one older electric road in the United Kingdom, that between Portrush and Bushmills, Ireland, which has been running ten years, and which

motor car carries passengers, and the trailers are the freight wagons. How flat tired wagons are made to do service on a railway is made plain from a glance at the track. The "wagons" run on the outer rails. The inner rails, which are the ones on which the motor cars run, are about one inch higher than the outer, and serve as flanges to keep the wagons on the track. The wagon tires are $2\frac{3}{4}$ inches wide.

Except at the grade crossings, current is taken from an inverted U-shaped rail between the track rails. When first laid this was placed on blocks soaked in boiling parafine.

These have since been replaced by glass insulators. The pressure is 250 volts. At grade crossings an overhead trolley is used, the form of which is shown in the engraving of the train. The revenue from the goods wagons is very considerable.

BOYS STEALING RIDES ON CARS.

How Can it be Stopped—City Ordinances in Cleveland and Kansas City, which Solve the Question—
The Need of a Similar Ordinance in Every City.

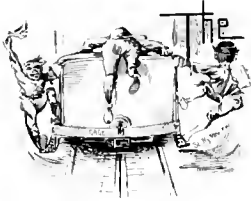

THE AVERAGE American boy has precious little regard for his own personal safety so long as he can have a good time. Hence the old custom of stealing rides on the street car, or "hitching on," as the railway man technically terms the offense, has constantly increased and grown more intolerable as one horse line after another has changed to electric or cable power. With the increased speed thus secured the danger has proportionately increased to the hitcher on, and relatively his enjoyment of the sport. The danger lies not so much in the jumping on and off as in the fact that in dodging the conductor the offender is apt to forget that cars are approaching on the other track and it is in this way a large proportion of the accidents occur. It is fun for the boys but it is death to the dividends for the company; for however blameless and helpless to prevent an accident of this kind, a generous jury seldom takes but one view of such matters, and even a legal victory involves heavy attorney's fees.

The need of some kind of municipal law, or police regulation which shall make this nuisance an offense punishable by a fine would not only be a welcome relief but is being seriously considered in several cities. In Oakland, Cal., an ordinance is being prepared, and on this subject Assistant Superintendent Tucker says:—

"We are absolutely helpless now. When we catch a boy whose father we know will not raise a row we spank him, but any boy whose daddy we are not acquainted with we let go. We might have an assault and battery case or something like that against us if we treated him the same way. It may seem strange but it is a fact nevertheless that we are absolutely without any protection in this regard and that it is all sheer luck that we have not killed a dozen or two promising coming citizens already. But the thing is getting pretty bad with these dangerous crossings and with the increased travel we think that something ought to be done."

There seems to be no city ordinance specially covering this subject, in New York, Brooklyn, Chicago, Pittsburg, Minneapolis, St. Paul, Baltimore, Denver or Boston. There is, however, a state law in New York which applies, but the difficulty of enforcing such a state law through the police department renders it practically inoperative, for the only way in which relief can be secured will be through the adoption of a police regulation, making it incumbent on the police department to enforce. The New York statute is as follows:

CHAPTER 585. LAW OF 1880.

An Act for the prevention of accidents to children.

Sec. 1. No minor child within this State, not being a passenger, shall be allowed upon the platform or steps of a railroad car drawn by steam, or of any omnibus, street

car or other vehicle drawn by horses, and the parents or guardians of any child who shall permit such child to ride or play upon the steps or platform of any such railroad car, omnibus, street car or other vehicle, shall be punished on conviction by a fine not less than five dollars nor more than ten dollars."

The making of the parent or guardian liable for offenses of minors under their charge is an excellent provision, and would have special influence on the working classes, the children of which are usually compelled to play in the streets and thus furnish the majority of offenders. Many a parent who would not be constrained from the danger involved to forbid his boys from stealing rides on cars, would at once become directly interested in an exercise of parental authority if there was a constant liability to be assessed a fine.

The two cities where specific ordinances are in force are Cleveland and Kansas City. In these places it rests upon the police department to arrest violators, and if the police become at any time careless in their duty, the company has only to advise the chief stating what lines and about what hours of the day the annoyance exists and an extra officer will straighten matters out in short order.

It is seldom necessary to make more than one or two arrests even though the fine be suspended, to have a salutary effect on the small boy for several blocks in all directions. The Cleveland ordinance is as follows:—

EXTRACT FROM CLEVELAND CITY ORDINANCES.

Sec. 999. Any boy or girl of the age of five years and upwards, who shall wantonly, mischievously or sportively, step or sit upon the steps of any railway car, for the purpose of surreptitiously riding thereon, or shall in any manner cling to the steps or railing at either end of any street railway car, or to the sides thereof, while the same is in motion, or under way in its track, for like wanton, mischievous or sportive purposes or intentions, shall be subject to and pay a fine of not exceeding five dollars, as the court may in its discretion determine.

The above seems to cover the case in hand fully and effectively. The Kansas City ordinance is more comprehensive but less explicit, making no distinction between a child under 15 years of age who boards a moving car with the intention of becoming a passenger and one who has no idea of paying a fare. The application of course, would be in enforcing it only against those who were evidently offenders.

THE KANSAS CITY ORDINANCE.

No. 3,724. An ordinance prohibiting persons under fifteen years of age from getting on or off of street cars while in motion.

Be it ordained by the common council of Kansas City:

Section 1. It shall be unlawful for any person under the age of fifteen years to get on or off or attempt to get on or off any cable, grip, electric, horse or other street car while such cars are in motion.

Section 2. Any person violating the provisions of Section 1 of this ordinance shall be deemed guilty of a misdemeanor and upon conviction thereof before the City Recorder shall be fined not less than one dollar nor more than one hundred dollars.

Section 3. All ordinances or parts of ordinances in conflict with this ordinance are hereby repealed.

Approved Nov. 16th, 1891, Benj. Holmes, Mayor.

The evil is evidently on the increase in most cities and parents and the public certainly ought to co-operate with the street railway companies in securing the passage of such a law in every city. There can be no good reason raised against it, and there is everything in its favor. The fact that with such an ordinance in force the company would enjoy a stronger defense in court is of much less moment than that its enforcement would reduce accidents from this source and consequent damage claims to almost nothing. The company would far rather be protected from having accidents forced upon it, than in any line of defense which could be set up. The case sums up in the recent remark of the manager of one of the largest roads in the country, who says,—“Street railways are, of course, under very great risk of liability of accident to these small boys, and it certainly would seem that the law making authorities, or law enforcing authorities, should protect us in the matter.”

ELMIRA-HORSEHEADS INTERURBAN OPENED.

THE first trip of the electric line from Elmira to Horseheads, N. Y., was made June 28. The party was made up of city officials, President Leland, of the line, C. H. Baldwin, treasurer and manager and various eminent citizens.

On the arrival at Horseheads the party was banqueted by president Leland. The return trip was made in 27 minutes.

ARGENTINE STREET RAILWAYS.

A LATE blue book published by the authorities of this republic, shows a healthy state of tramway enterprise, at least as far as length of lines is concerned. The city of Buenos Ayres is well supplied. In December, 1892, Anglo-Argentine boasted 65 miles of track, the City of Buenos Ayres 40 miles, Rural 28, the New Company 24, the National 25, other companies 68, giving a total of 250 miles.

Tramway enterprise dates back 24 years and most of the important lines have been running since 1871.

The average passengers a month since 1873 is as follows:—

1873,	-	-	-	-	-	1,010,000
1884,	-	-	-	-	-	1,902,000
1890,	-	-	-	-	-	4,670,000
1892,	-	-	-	-	-	5,452,000
1893,	-	-	-	-	-	6,810,000

The number of cars and horses have not kept pace

with traffic increase: since in 1890, 6,500 horses pulled 396 cars and carried 56,000,000 passengers; in 1892, 5,916 horses pulled 383 cars and carried 65,000,000 passengers. There are 3,000 men employed on the various Buenos Ayres street railways.

Most of these tramways are owned in London, and with the usual perverseness of the British merchants and bankers are managed from London without any direct knowledge of local affairs.

The city papers of Buenos call for several changes in management, principally newer and more commodious rolling stock and better car service, together with a management of the lines from a knowledge of local conditions.

THE SCRANTON AND CARBONDALE TRAC- TION COMPANY.

OUR readers should not confound this road with the present electric road in Scranton, or the little road in Carbondale, seventeen miles north of Scranton. This road is the connecting link between the two cities. It acquired the right of way of the Blakely & Dickson Traction Street Railway Company, which extends along the old Providence and Carbondale turnpike, from Scranton north to the town of Archbald, and connects all the towns and villages north of Scranton in the Lackawanna Valley.

The contract for the entire roadbed and track construction was given to the Johnson Company, of Johnstown, but work was delayed, owing to heavy frosts and mud, until the last of May. It was practically the first of June before tracklaying was fairly under way. J. G. White & Company, of New York City, have the contract for the overhead line work, etc. There will be sixteen cars, eight open and eight closed vestibule cars, which will be equipped with the General Electric Company's latest type of 25-horse-power motors. The Berlin Iron Bridge Company, of East Berlin, Connecticut, have the contract for the fire-proof buildings, and the entire road will be first-class in every respect. The road is laid with 56-pound T-rail throughout, on extra heavy ties, placed two feet between centers.

The entire construction is under the supervision of A. H. Chadbourne, who temporarily moved up to Scranton to give this his personal attention. The road will be opened this month, and will be the most important link in the railway systems of the Lackawanna Valley, as it gives direct communication to a large outstanding population into the heart of Scranton. This population is now indifferently served by steam roads, whose energies are devoted to the carrying of coal rather than to passengers.

George A. Fletcher, a wealthy merchant of Philadelphia, is the president, and Alfred N. Chandler, of Louchheim & Company, bankers, of Philadelphia, has charge of the finances of the company. The Lackawanna Trust & Safe Deposit Company, of Scranton, are the trustees under the mortgage.

GREEN TANDEM COMPOUND ENGINE.

THE Altoona Manufacturing Company, already widely and favorably known as the manufacturers of the highest grade of engines, have added another laurel to their reputation by placing on the market a tandem compound engine which overcomes one of

wrench the high pressure cylinder head can be taken out. The valve motion is in no way interfered with. The packing is a new design, double metallic, lasting four or five years without attention. These engines are specially suited for heavy electric railway work, and the excellent

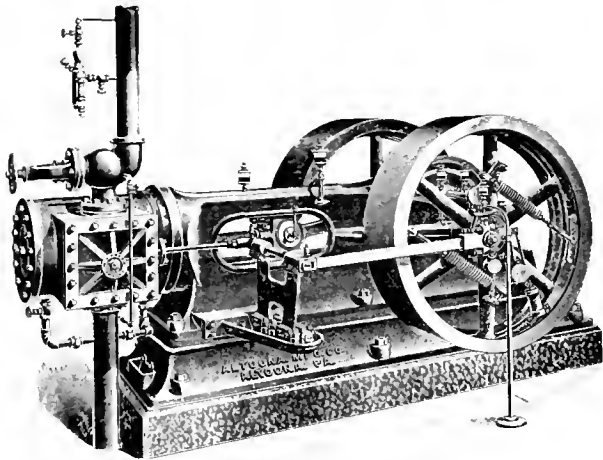

THE M. A. GREEN AUTOMATIC CUT-OFF ENGINE.

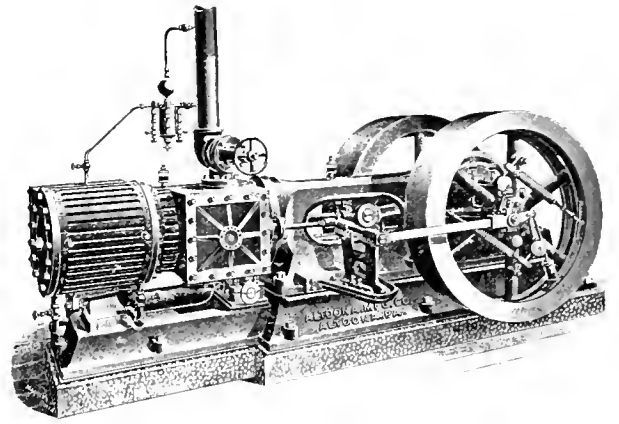

THE M. A. GREEN AUTOMATIC CUT-OFF TANDEM COMPOUND.

the principal objections to the tandem type as heretofore built. It is pretty generally admitted that the tandem compound is the most desirable form, but for the difficulty in getting at the high pressure piston. The tandem is more compact, less complicated and slightly more econ-

performance and careful construction of their simple engines bespeaks for them success.

TRAMWAY traffic in Liverpool, for the week ending June 10, shows a decrease of \$7,500 over the corresponding week last year.

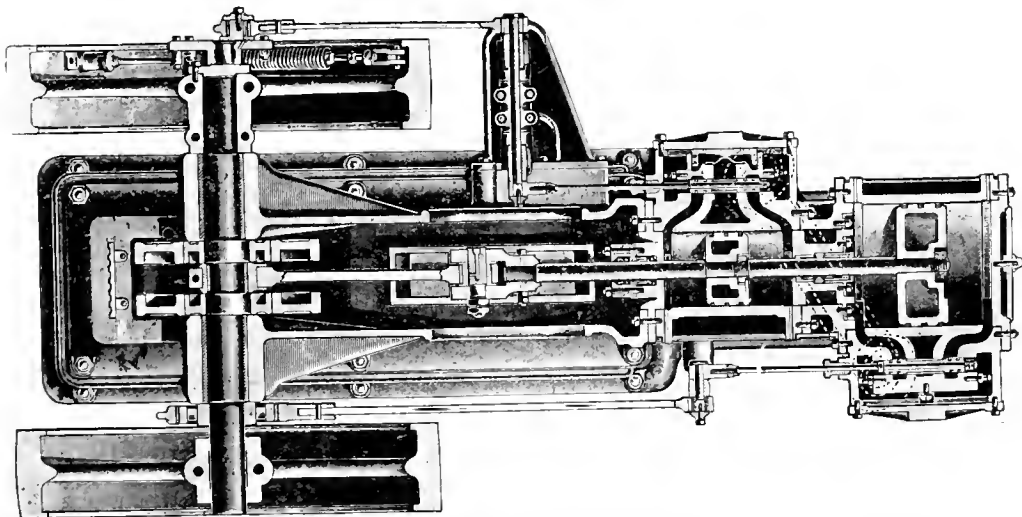

PLAN OF GREEN TANDEM COMPOUND.

omical, on account of the fact that no steam is needed to cushion the low pressure piston and the exhaust can therefore be run at the lowest possible back pressure. All that is needed, then, is a form of construction that makes accessible the high pressure cylinder, in order to make the tandem compound the most desirable type for most purposes. How the Green engine accomplishes this an inspection of the horizontal section will show. The low pressure cylinder head is removed in the ordinary way. By unscrewing two jam nuts the low pressure piston head is loosened and by the use of a socket

THE DENVER COMPANY'S PICNIC.

THE Denver Tramway Company gives the employes an annual picnic. This year the festivities were held at Rocky Mountain Lake, to which place the company furnished transportation, spread the board and paid the bills. Field sports, dancing, boating, and brass bands enlivened the day, which was enjoyed by 250 men with their wives, sweet hearts and families. A hearty co-operation of the corporations and employes is one of the most noted elements in the Tramway's management.

STREET RAILROAD POLICE.

IN Connecticut they now have full fledged official street railway police, clothed with all the powers and blue buttons which belong to the old line article. At the last general assembly amendments to the statutes were made by which the governor may appoint such officers. The bill reads as follows:—

“The governor may, from time to time, upon the application of any railroad, electric or other street railroad, or steamboat company, engaged in the business of transportation in this state, commission, during his pleasure, one or more persons designated by such company, who, having been duly sworn, may act at its expense as policemen upon the premises used by it in its business, or upon its cars or vessels. When any such commission is issued or revoked the executive secretary shall notify the clerk of the superior court of each county in which it is intended that such policeman shall act.

“Every railroad, electric or other street railroad, or steamboat policeman may arrest in his precincts for all offenses committed therein, and bring the offenders before proper authority. Every such policeman shall, when on duty, wear, in plain view, a shield bearing the words “ Railroad Police,” “Street Railroad Police,” or “Steamboat Police,” as the case may be, and the name of the company for which he is commissioned.”

Several appointments have already been made under this act, among the most recent of which are eight men for the Derby & Ansonia street railway. If a company ever should have occasion to doubt a conductor’s system of handling the finances, we wonder how it would work to have him sworn in as a special officer to watch himself.

ANOTHER CASE OF CIRCUMSTANTIAL EVIDENCE.

QUITE a thrill of horror was created among the readers of the New York dailies by the sensational account of the—as described—intensely tragic death of Charles Mitchell, a lineman in the employ of the Woodbridge & Turner Engineering Company, when engaged in construction work of the electric railway at Brigantine Beach, N. J.

At the time of his death Mitchell was at work guying a pull-off on a curve at Fifty-ninth street. The guy broke and he fell from the travelling tower car. The result of the autopsy by Dr. Ulmer, of Atlantic City disclosed the fact that death resulted from heart disease, from which the deceased had been a sufferer for a long time, and that the shock of the fall and not the current—550 volts—was responsible.

As usual, and evidently without any desire to inquire into any other possible cause, the reporters siezed upon the opportunity to dilate upon the terrors of the deadly trolley. To have told the truth would have limited the description to a few brief lines and placed the occurrence on the plane of the common place. But all the possibilities of death from a current capable of doing fatal work

were invoked to depict the unfortunate case in question. All this may be journalistic enterprise but it is anything but the truth, and the intelligent public are fast becoming aware of the fraud practiced on them in this kind of wild-cat stories, and those papers which persist in this amusement will simply throw a mantle of doubt over statements which are true and deserving of acceptance and belief.

A FLORIDA MULE.

FLORIDA is good for something else than bananas and summer resorts. It grows mules. Not the long eared braying variety with dull minds, no souls and light heels.

Oh no!

Florida mules are trained for street car service and this is the result.

The Jacksonville Street Railway Company has a big gray mule which is a matter of pride. This mule has a mild and benevolent countenance and a sweet smile. He is not afraid of a bushel of oats. He knows a trick or two and can warble “After the Ball” in so melliferous a bray that you are dissolved in tears. When this mule wants a drink he goes of his own will to the hydrant, turns the faucet with his teeth and flushes his long esophagus with a barrel of water. When his thirst is quenched he turns off the stream and goes back to his stall.

When hitched to a car he will stop at a signal from an old lady two blocks away and wait for her. He slows down without a word for active young men and treats young ladies with the greatest consideration. He is valued at \$1,200. The above tale is vouched for by The Lyre, a Baptist Sunday school organ, published at Tallahassee.

TRAVEL IN ST. LOUIS.

THE quarterly report of the St. Louis lines for the three months ending June 30 shows a heavy business, as follows:—

	Trips	Passengers
Baden & St. Louis	5,462	137,366
Bellefontaine	30,407	1,087,353
*Cass Avenue & Fair Grounds	145,006	1,678,506
Citizens'	207,336	2,600,304
Jefferson Avenue	46,622	539,036
Lindell	286,100	3,801,125
Missouri	285,964	1,955,148
People's	58,240	1,292,069
Broadway Cable	213,740	3,378,898
St. Louis & Suburban	35,921	2,243,304
Southern Electric	75,881	1,479,177
Union Depot, including Mound City	235,120	3,894,459
Total	1,625,799	26,186,745

*Includes the Northern Central and Union lines.

The increase over the same period last year is more than two and one-half million passengers.

In the description of the Hietzman underground trolley system in our July issue it was erroneously stated that part of the trolley arm was hard rubber. Soft rubber is used, and constitutes one of the special claims of the device.

THE MATLOCK CABLE TRAMWAY.

The Recently Completed Cable Road—Numerous New Applications for Safety—Interesting Construction—
A Great Success.

SITUATED in the picturesque county of Derbyshire, on the banks of the classic Derwent, lies the township of Matlock. Here invalids from all parts of the world may be found seeking lost health by drinking the waters of the mineral springs and undergoing the drastic treatment at the various hydropathic

often to the principal street in the town at the bottom of the hill would require to be a fairly healthy one.

The want of a means of conveyance for both passengers and goods was keenly felt, and a local company was formed, with George Croydon Marks, M. I. C. E., as their engineer, who retained the services of W. N. Colam,



SCENES ON THE MATLOCK, ENGLAND, CABLE RAILWAY.

The Power House.
Double Deck Car.

Drawing in the Cable.
Entrance to Car House.

establishments. These establishments are very numerous, the higher levels of the town being almost exclusively occupied by them. The main public road from the turnpike in the valley where the Midland Railway station is situated, is both tortuous, narrow and very steep. It is over this road that most of the traffic is conveyed, both passenger and goods. When it is mentioned that in a distance of 2,310 feet this road rises 300 feet, it will be readily understood that the invalid who could stroll

M. I. C. E., the well-known cable tramway expert, as consulting engineer. Parliamentary plans, etc., were made and ultimately in 1891 an Act of Parliament was obtained to construct a cable line, and thus to some extent the municipal difficulties were overcome.

The physical obstacles now presented themselves in detail to the engineer, and these were found to be of considerable magnitude, owing to the fact that the road could not be altered in plan or action to any great extent.

This caused the gauge of the line to be fixed at three feet, six inches, so as to make the encroachments on the stationary limit of nine feet, six inches, from rail to curb, as few as possible.

The road is only half a mile long, with a rise of 300 feet in 770 yards. This gives an average gradient of 1 in 7.7 feet, but in certain portions it is as steep as 1 in 5 and as narrow as 20 feet between curbs. It is single track, with a passing place or siding at the lower terminus, a passing place about two-thirds the way up and a fork siding at the higher terminus running into a traverser in the depot, which is used each journey. Engineers will understand the problem when we say there are six curves where the track and conduit is single, varying from under 200 feet to 1,000 feet radius.

As a matter of fact, though the company had their Act of Parliament, the whole scheme was in a large measure an experimental one. No similar line had ever been presented to the Board of Trade Inspector to undergo his stringent tests as to public safety, etc. The financial risk of a mechanical failure or the refusal of the Board of Trade Certificate was very considerable; and it was not until the scheme was submitted to Dick, Kerr & Company, Ltd.; of London, whose eminence and enterprise is well known, that the company was encouraged at all in their scheme. Dick, Kerr & Company studied the route thoroughly, after which they agreed to construct the line, engines, boilers, driving gear, permanent way, cars, etc., and in fact hand the line over to the company as a working concern, having passed the Board of Trade Inspector.

Their judgment has been sound and their work entirely successful, the line having been thoroughly tested by General Hutchinson on March 1st of this year, and passed

ascending and descending the hill, and the car stopped with each of the brakes; i. e., the wheel brake and the slot rail brake. The line was opened for public traffic

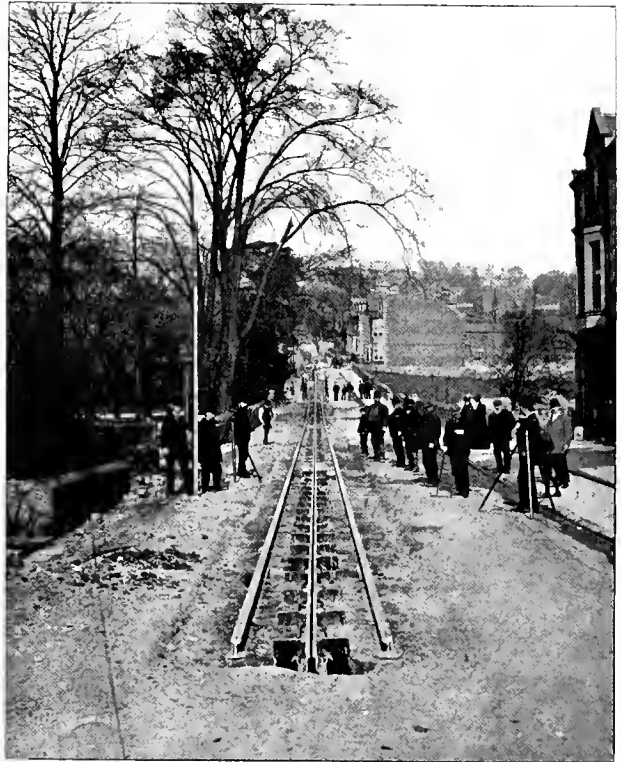

SECTION OF LINE READY FOR PAVING.

on March 28th, just in time for the Easter holiday traffic, very great at Matlock, and which it successfully carried. It has since been carrying the public without a hitch.

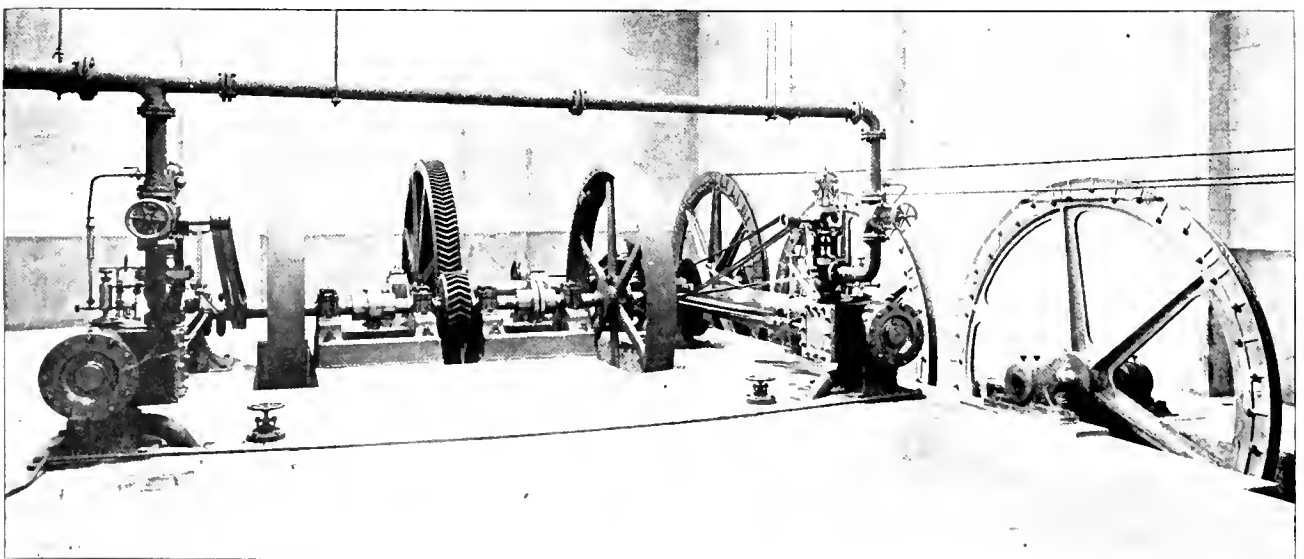

DRIVING MACHINERY MATLOCK CABLE RAILWAY.

with his complete approval. During this inspection General Hutchinson caused a loaded car to be used. The cable was dropped on the steepest parts of the road both

We will now briefly describe the line as constructed. To begin with the permanent way, it will be seen from the illustrations that the pulley pits are drained by a 6

TRACK CONSTRUCTION.—MATLOCK CABLE RAILWAY.

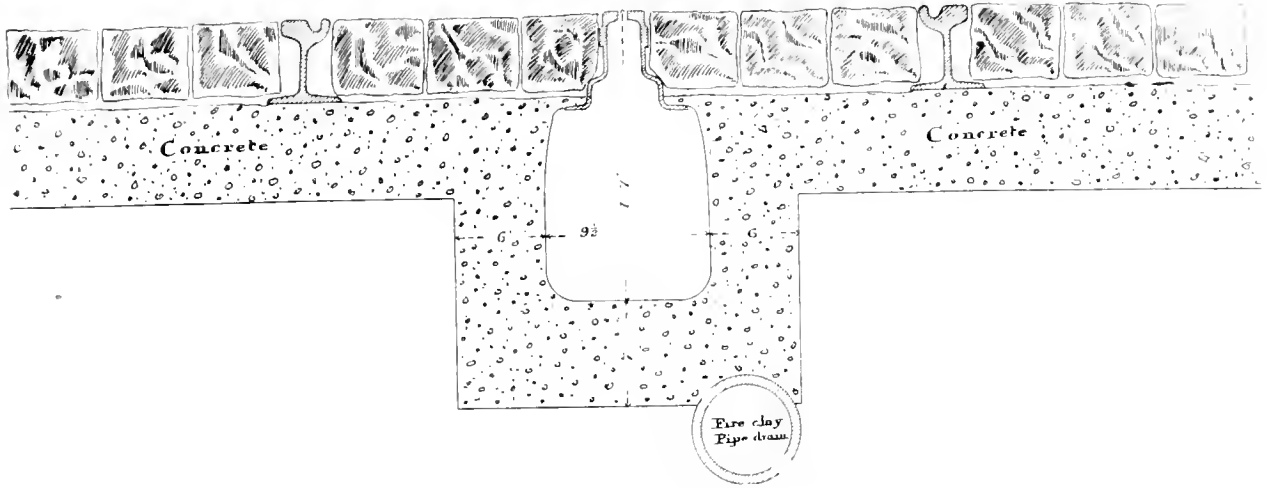

CROSS SECTION OF TRACK BETWEEN YOKES.

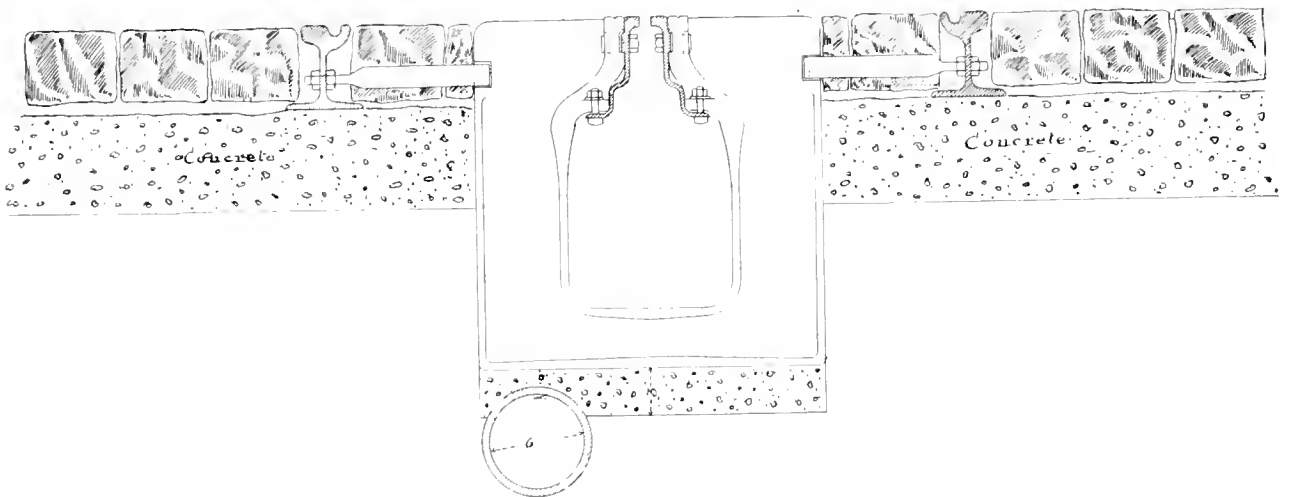

CROSS SECTION AT YOKES SHOWING TRACK RAIL BRACES AND MANNER OF BOLTING SLOT RAIL.



CROSS SECTION OF PULLEY PITS SHOWING MAN HOLE COVERS.

inch pipe drain which is laid under the conduit and which connects each pulley pit. This saves a great many sewer connections and allows a small conduit to be used, the dimensions of which are only 1 foot, 7 inches from top of slot rail to bottom of conduit and 9½ inches broad between the concrete walls.

The slot rails and yoke are both of a special design by Mr. Colam. The yokes are 155 pounds in weight and are placed at 3 feet, 6 inches centres. Both the web and the flange of the slot rail are bolted to the yoke jaws, as shown in the cut. The tube or conduit is formed of concrete in which the yokes are imbedded. The materials used in mixing this concrete are as follows:—

Derbyshire grit stone, broken to pass through a 2 inch ring,4 parts
Grit quarry sand.....2 parts
Portland cement.....1 part

The different constituents were mixed on a platform turned over twice dry and twice wet before putting in position.

The yokes and slot rails were bolted together, levelled thoroughly, packed with concrete, and afterwards lined with a theodolite, both curves and straight; the concrete

the pulleys being allowed, they are fitted with wood blocks to prevent horses slipping on them, and show a minimum of metal on the surface. The terminal pulleys 8 feet diameter are hung vertically, the cable making half a figure 8 around them.



The depot is situated 300 feet above the lower terminus, with a particularly elegant facade looking across the Derwent valley. The building comprises boiler and engine house, car shed, traversers and waiting rooms, offices, lavatories, workshops, etc. The two boilers are of the "Cornish" type, single flued, with vertical water tubes crossing the flue. They are fitted with most efficient mechanical stokers, which are worked by a small donkey engine. Those stokers act in every way as smoke consumers, and since they were first started no appearance of smoke has been seen from the mouth of the chimney stack which is 100 feet high. This is a most important matter in a health resort like Matlock, and the possibility of the tramway giving rise to smoke was a cause of anxiety to some members of the local board, who

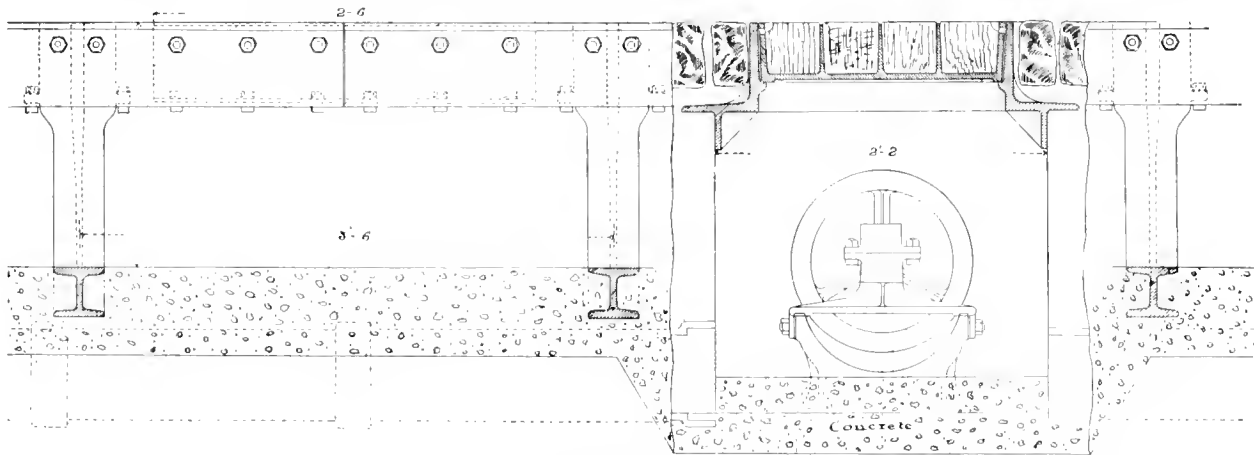

SIDE ELEVATION PULLEY PIT.

was then put in to form walls of conduit and foundation for girder rails.

These were laid direct on this concrete foundation, being packed under flange with fine concrete and tied to the webs of the yokes by short tie rods. This is clearly shown in the cut of the cross section of track. The line between the rails and 18 inches outside track rails, is paved with Derbyshire grit setts, 5 inches deep and 4 to 5 inches broad, and grouted with cement grout, composed of 3 parts grit sand, and 1 part best Portland cement. The setts are laid flush with the slot and track rail heads. This particular local stone was selected as it affords a certain foothold to horses which is essential on such a gradient.

The ordinary vertical pulleys where the line is straight are 49 feet apart, and on the curves there are both horizontal pulleys and special rocking or tilt pulleys spaced from 3 feet 6 inches centers to 10 feet 6 inches centers according to the radius of the different curves. The hatches and covers are specially small, only clearance for

have however since the start been agreeably surprised by the result of the stokers.

The driving power consists of a pair of high pressure horizontal engines each capable of driving the cables, with two couplings on the crank shaft. In case of the break down of either engine it can be uncoupled and the other put to work in a few minutes. The cylinders are 14 inches diameter with 28 inch stroke, and are fitted with "Proell" automatic valve gear. The engine shaft 6 inches diameter and 18 feet 6 inches long, is geared to the counter-shaft 9 inches diameter and 17 feet 6 inches long (carrying the driving drum), by helical toothed spur and pinion wheels. On this counter shaft there is a friction clutch whereby the driving drum, or grip pulley, as it is called by English engineers, can be thrown out of gear and the cable stopped without stopping the engine, in about ten seconds.

All shafts and pulley spindles throughout the whole line excepting the engine shaft, are lubricated by petroleum grease, in Stauffer's lubricators. The engines and

crank shafts have syphons in which is used ordinary lubricating oil.

The cars are double-deckers, carried on a pair of bogies, and seat 31 passengers. There are six cross seats above, each of which except the ones at the end of the car have reversible backs. The wheels are 21 inches diameter with a truck wheel base of 4 feet 9 inches, and 13 feet 9 inches from center to center of trucks. From rail to car body is a half inch less than two feet and from sill to top of hand rail is 9 feet 4½ inches, making height over all 11 feet 4 inches.

The box proper is 12 feet 9 inches long, with inclosed platforms at each end, from which the stairs ascend, 4 feet 9 inches long; giving a total length over all of 23 feet. The extreme width of car body is 6 feet 8 inches. The gripman occupies a space directly in front of the car body, with a railing in front, between which and the dash is a space for passengers to pass to the steps leading to the roof seats. The platform steps are placed at the corners of the car, one at each end.

Steel sills are used to form the car box frame, of 4 by

Referring again to cross section of track, the construction will be readily understood. The slot rails are of Bessemer steel rolled to the section shown, and weigh 40 pounds per yard. All the bolts, tie-bars, etc., are of best Staffordshire wrought iron. The track rails are the girder pattern of 65-pound Bessemer steel.

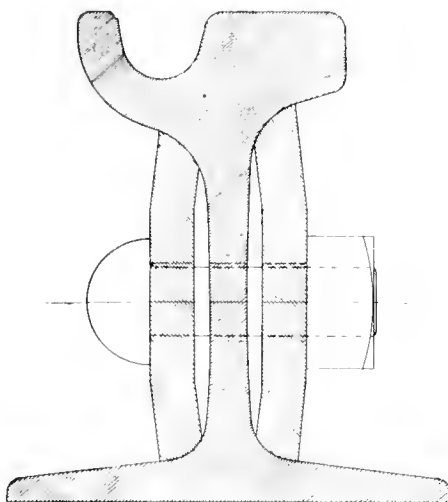

TRACK RAIL—ONE-HALF ACTUAL SIZE.

The grippers used are Colam's patent. They are hung on the gantry carried by the bogie axles: the lower jaw is actuated by a vertical screw spindle, the upper jaw being fixed to a steel plate locked to this gantry. The gripper is so constructed that it can be raised out of the conduit and hung entirely clear of the roadway, allowing the car to be run on an ordinary line, in the depot or elsewhere. It can also, in case of breakage, be taken out entirely and replaced by another in about seven minutes at any part of the road where a gripper hatch may be.

Both jaws are faced with soft cast iron dies which can be renewed in five minutes when worn out.

The cable is 3⅜ inches in circumference, 8½-inch Lang's lay, composed of 6 strands of 7 outside wires, 6

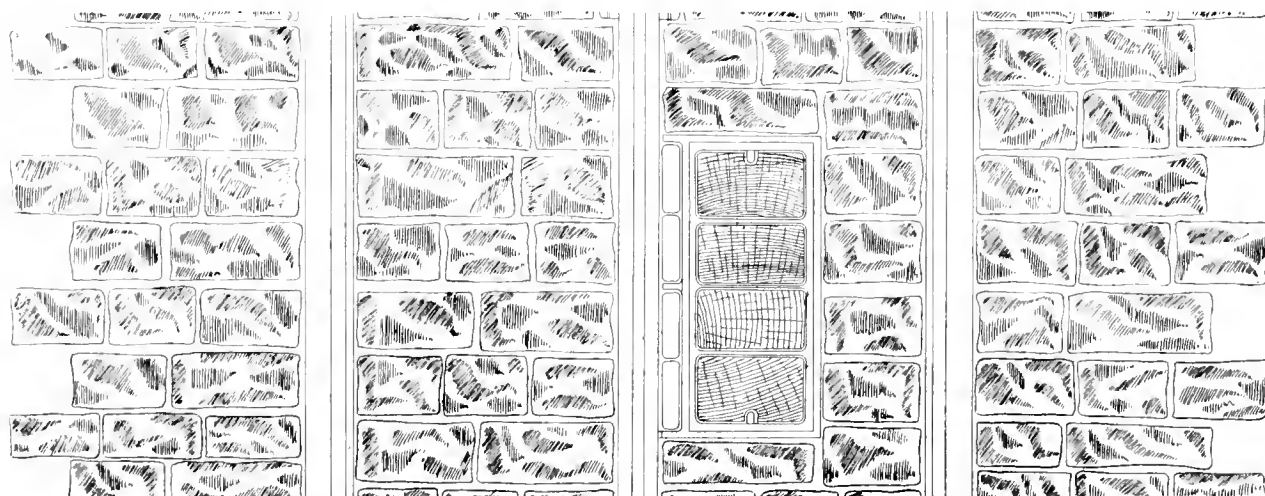

PLAN VIEW OF TRACK SHOWING MANNER OF PAVING MANHOLE COVERS.

2¼ by ¾ inch channel iron. There are two sets of brakes the wheel and slot rail, the latter the joint invention of Mr. More and Mr. Marks and has proved very effective. It will be best understood from the engraving, and it will be noted works as a clamp, grasping the slot rail from above and below. At present no trailers are hauled. The line being in a quiet country town with little traffic, a ten minute service only is run and two cars are sufficient for this, an extra one being held in reserve in the depot in case of any breakdown. Each car runs 40 miles per day through a road partly occupied by shops and partly by small houses.

inside, 5 around one of 3¾-inch lay; the diameter of the wire is 0.101 inch. The core is of best white manilla hemp rope, three strands hard laid, well soaked in oil. The average breaking strain of the wire was 90 tons to the square inch.

The line so far has only been worked for the conveyance of passengers but the directors hope shortly to carry all kinds of goods and materials, but principally coal, which will be a considerable source of income to them, besides being a boon to the inhabitants of the higher portions of the town.

The whole work; permanent way, engines, boilers

cars, cable, etc., was constructed, equipped and started by Messrs. Dick, Kerr & Company, Ltd., London, under the personal supervision of their engineer, James More, Junior, A. M. I. C. E.

machinery and equipment, which are the admiration of all who have inspected this model line.

In the first 43 days of operation of the line 51,287 passengers were carried, or an average of 1,200 per diem.

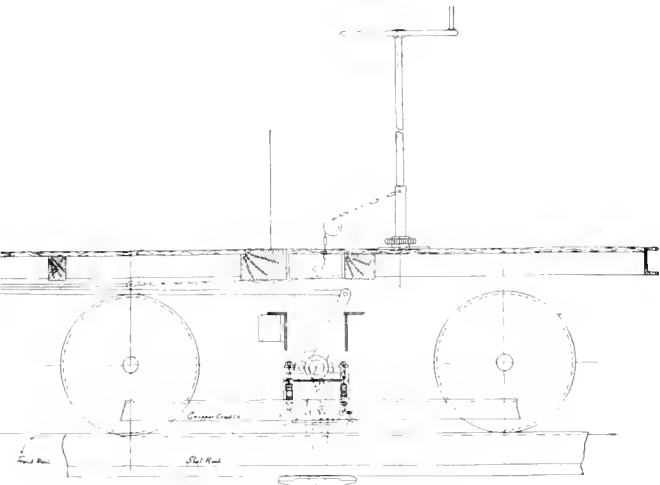

SIDE ELEVATION—SLOT RAIL BRAKE.

In the construction of the line numerous contingencies arose demanding instant attention, but to the intelligent

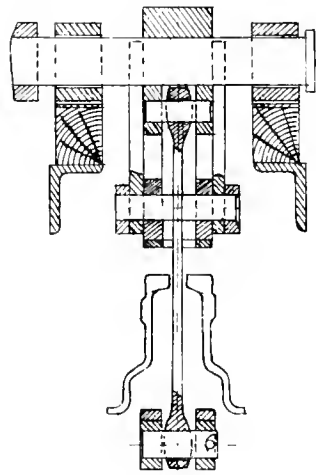

END VIEW—SLOT BRAKE.

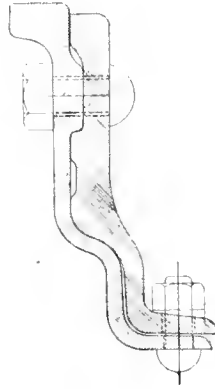

SLOT RAIL—ONE-THIRD ACTUAL SIZE.

judgment and quick decision of Mr. More, much of the success of rapid construction is due, and the road as fin-

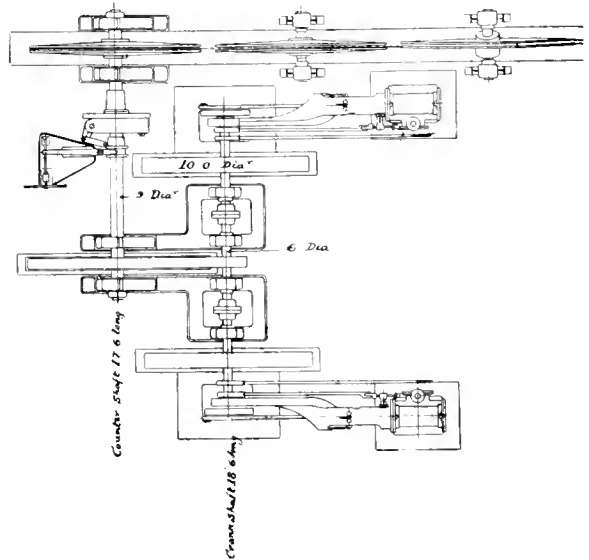

PLAN OF DRIVING MACHINERY.

The receipts were \$1,280 for this time, but as people become accustomed to riding the receipts will indefinitely increase. The local papers are full of praise for the new system and the relief it gives from cabmen's extortions.

WHILE in this country we have been mainly exercised in the problem of heating railway carriages, Indian engineers have been endeavoring to find some satisfactory way of cooling them. The latest device for this purpose is described in an Indian technical journal, and consists of an automatic arrangement by which curtains suspended across an open trap-door in the carriage are kept saturated with water. These curtains are let down over the fore-end of the carriage, covering the trap-door in whichever direction the train is traveling. In addition to this arrangement there is a revolving punkah fitted with fans, which is kept in constant motion while the train proceeds on its way.

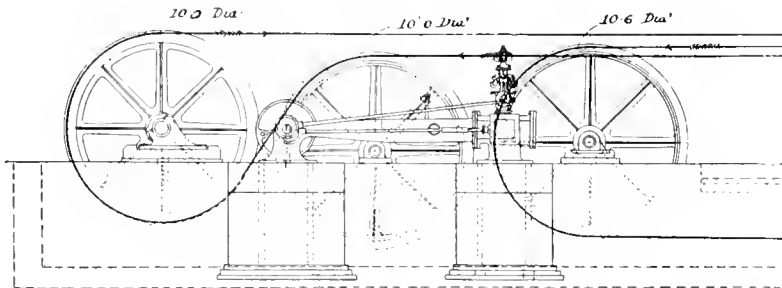

SIDE ELEVATION—CABLE DRIVING MACHINERY.

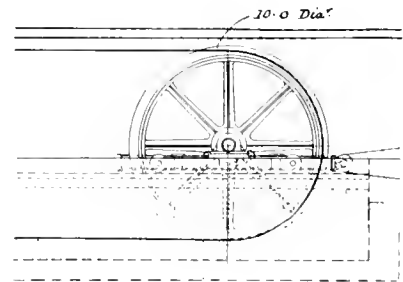

ished and in successful operation is no less a credit to his skill as a constructing engineer than to the builders of the

A RECENT electric railway concession has been made for a road from Berned to Altstatten, Germany.

OAKLAND'S ELECTRIC COMBINED.

SEVERAL months ago the STREET RAILWAY REVIEW published an outline of a large and very reasonable scheme of combining the street railway interests of Oakland, California. The man in the case was said by our correspondent to be F. M. Smith, better known as the Borax King. When the REVIEW reached the Golden Gate the Oakland papers took great pains to deny the allegation. Time has told, however, and the REVIEW prophesy is well verified.

Mr. Smith, besides being one of the wealthiest men on the coast, is one of California's cleverest financiers and the REVIEW welcomes him to the ranks of street railway generals.

First obtaining control of the California & Nevada Railroad, Mr. Smith announced that a new ferry would

DANGERS OF HORSE CARS.

AN extraordinary affair, says an English contemporary, happened at Greenwich, one evening lately. A Lewisham servant girl on a tram car approaching Greenwich complained of feeling ill. On arriving at the terminus a train inspector, seeing the girl was really ill, hailed a cab, that she might be drawn to her home. A crowd gathered, and as none of the female element would accompany the girl, the inspector got in the cab with the young woman. The cab had gone only a short distance when to the inspector's dismay his companion was delivered of a child.

Had it occurred on an electric car we presume the New York papers would had laid the mishap to the "deadly trolley."

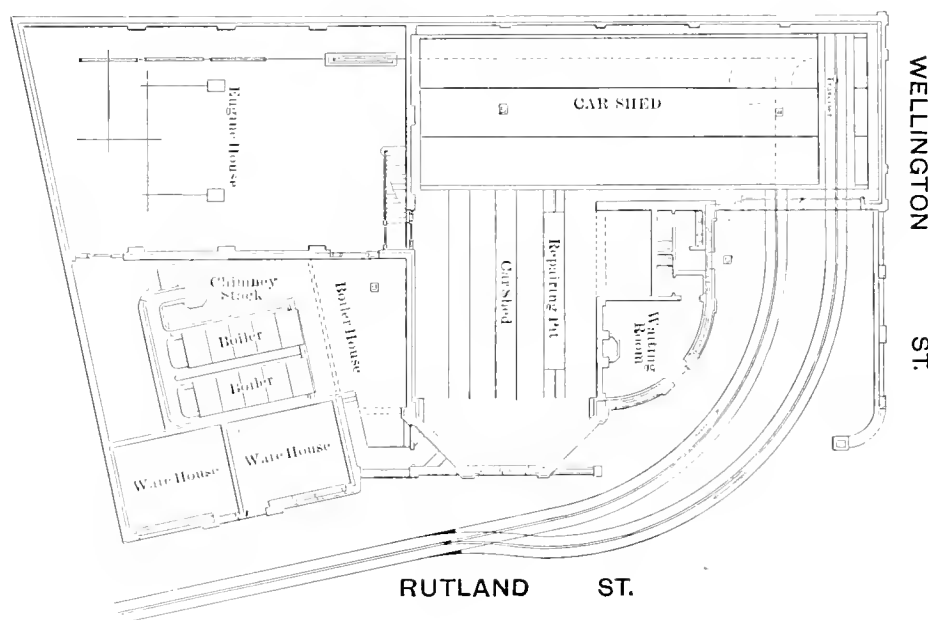

GROUND PLAN MATLOCK CABLE POWER HOUSE.

be established at Emeryville, and the pier was set abuilding. But how to get people to the ferry was the next question. Next, Oakland gossips understood that Mr. Smith and his colleague, H. M. Miner, the theatrical manager, backed by eastern capital, had acquired a controlling interest in the Consolidated. It was a battle of kings, in which George W. McNear, president of the Consolidated, arrayed his forces against the Borax royalty.

Now, although Mr. McNear is nominally and for peace sake president, Smith, et al., hold the power behind the throne. The twelfth street line was built by Mr. Smith and added to this system, now publically announced.

Mr. Smith has another big scheme in view. It is proposed to build from Piedmont to Emeryville and run in connection with the ferry. This gives the syndicate control of 25 miles of road and ten miles of franchise and no doubt the Alsip-Whitmore franchise will become part of the system.

A PENNSYLVANIA MORTGAGE.

THE affairs of the Pennsylvania Traction Company are being crystalized as fast as possible. On July 21 a mortgage for \$700,000 was given by the company to the Provident Life & Trust Company, of Philadelphia. This secures the issue of seven hundred \$1,000 bonds and the Provident Company was appointed trustee.

The mortgage states that the Pennsylvania Traction Company proposes to include in its line the Lancaster & Philadelphia Electric Road, which is to be an extensive interurban, uniting Harrisburg and Philadelphia by way of Malvern, Downingtown, Coatsville, Parkesburg, Lancaster, Mount Joy, Elizabetown & Middletown.

The Pennsylvania Company is composed of J. J. Patterson, S. M. Patterson, Robert McMinn, of Millintown John D. Skiles and J. H. Brown, of Lancaster, with J. J. Patterson as president.

D. H. LOUDERBACK.

BY a strange coincidence, the subject of this month's portrait was born in Davenport, Iowa—the city in which he now controls the street railway system. At the time of his appearance in that pioneer town in 1848, there was little there to indicate that it would some day have a street railway. Mr. Louderback's career has been one closely identified with electrical progress. Beginning with the telegraph in its comparatively early days, he has followed the advance guard of applied electricity through the beginnings of the telephone and electric light, until the present finds him with electricity's youngest offspring, the electric railway.

Mr. Louderback was educated at Philadelphia, and at Madison University, in the state of New York. His first business position was in the train dispatcher's office of the New York Central, at Buffalo, in 1864. Two years later he entered the Western Union employ, at Philadelphia. In 1868 he started on his own account a system of independent telegraph offices, located at Philadelphia, Washington, New York, Chicago, and Long Branch. These received the messages of the opposition companies on a commission basis. These offices were sold out at a large profit in '73. From 1876 to '79 he was engaged in the business incident to various important offices in the Western Electric Manufacturing Company, at New York, Philadelphia and Chicago. This company, now the Western Electric Company, was prominent in the telephone business. In 1879, under the direction of H. McKay Twombly, he made the contracts for the consolidation of the telephone business of the Western Union and Bell companies. In return for this service he received a half interest in the franchises which comprised the Southern Bell Telephone Company, which he afterwards helped to organize in seven South Atlantic states. In 1880, in connection with the late General Anson Stager, he organized the telephone companies of Ohio, Indiana, Iowa, Illinois and Michigan, holding the position of vice-president and managing director until 1887. Meanwhile, in 1883, with General Stager he organized the Western Edison Light Company, controlling Illinois, Iowa and Wisconsin, and was its secretary until it was sold to the parent Edison Company in 1886, when the Chicago Edison Company was organized. Of this latter he was general manager during the installation of the present station, and continued in that position until 1888, when he retired from all business on account of nervous prostration from overwork. During a trip to the Pacific coast in 1889 he bought control of the Tacoma Railway Company, and was for a time vice-president. He afterwards sold to Henry Villard and associates. He returned to Chicago in 1890, and became managing director of the Davenport & Rock Island Railway in December, '90, and afterwards president. In June, 1891, he took hold of the Chicago North Shore Street Railway Company. Owing to delays in getting franchises in four municipalities, work was not begun until March 15th, 1893. It was completed June 11, 1893, a rapidity characteristic of Mr. Louder-

back's push. He has probably succeeded in interesting more capital in electrical enterprises than any other man now living in the United States. He combines the strong forces of a wide experience with all the energy of a young man, to which must not be omitted a genial temperament, which makes meeting him in either a business or social way, a positive pleasure.

THE TROLLEY AS A HYPNOTIZER.

THE wonders of modern science never cease. Electrical science and the science of electric or trolley cars in particular is in the lead. It takes the New York papers to discover things, too. The New York World is one of them. Its latest is that of a small boy whom it calls "Charlie." Charlie loitered on the car track when a "trolley" was coming his way. According to the World his companions called "Look out, CHARLIE! Run!" Charlie's mental processes were fairly at work and the necessary nerve action had almost reached a point where muscular action would have done the rest, when in an unfortunate moment the motorman stepped on the button which sounds the gong. That did the business. Charlie was transfixed; or as interpreted by the "World", hypnotized. The foot which had lifted from the ground in the first motions of walking remained poised in air, the body slightly inclined forward, remained balanced on the other foot, the outstretched arm had all the symptoms of a pedestrian; but there each member halted

His "eyes were sot."

Evidently the motorman should be instructed to whisper in dulcet tones when Charlie-boys roost on the track; or turn the car out on the side of the street and go around small boys; or display a green flag to indicate another car following on some track. Or, possibly, though no one seems to have thought of it Charlie's mamma might inoculate Charlie against such hypnotic influences, by short-circuiting his pants with a slipper whenever he seems inclined to make a ground return of himself.

CELLULAR OPESTACITIS.

PHILADELPHIA lawyers have been proverbial for years, but just now comes a Philadelphia doctor with a story which, if true, is interesting to the medical fraternity as well as to street railway men.

James Maguire, a conductor on the Market street cable line is in one of the hospitals suffering with what is termed medically cellular opestacitis or bell arm. James is a conductor on the forward car and the habit for listening for "his bell" followed by the mechanical reaching for the bell strap has developed this strange ailment. The muscular movement has become second nature to Maguire and his trained muscles and nerves act more quickly than his brain. To such an extent has this progressed that at the tap of any kind of a bell his hand shoots up for a bell cord. The disease is not without parallel but is at least a curiosity.

Street Railway Review



D. H. LOUDERBACK,
CHICAGO.

*President Davenport & Rock Island Street Railway.
President Chicago North Shore Electric Railway.*

PERFORMANCE OF STREET RAILWAY POWER PLANTS.

Interesting Figures from a Paper Presented at the Mechanical Engineering Section of the World's Engineering Congress, by William A. Pike, Consulting Engineer, Minneapolis, and T. W. Hugo, Mechanical Engineer, Duluth, August 3, 1893.

THE paper, as indicated by the above title, gives the complete results of tests made during the last year and a half at three power houses of the Twin City Rapid Transit Company, of Minneapolis and St. Paul. The authors of the article were employed by the above company to make the tests, and they are therefore entirely non-partisan. The greater part of the corps of thirty observers employed in making the test were engineering students from the University of Minnesota. The regular employes took no part in the testing work, simply keeping the plant in its usual working condition.

The objects of the tests were—

1. To ascertain the cost of motive power per car mile (a) as furnished by the tri-cylinder condensing Corliss engines at Power House No. 1, Minneapolis (Third avenue); (b) as furnished by the tri-cylinder condensing engines at the Hill Street Power House, St. Paul; (c) as furnished by the two cylinder non-condensing Westinghouse engines at the Thirty-first Street Power House, Minneapolis.
2. To obtain data as to the economy of the boilers used.
3. To obtain data as to the relative value of crude petroleum and coal as a fuel.
4. To compare the cost of furnishing power by large tri-cylinder condensing engines and small Westinghouse two-cylinder non-condensing engines; or concentrated vs. subdivided power.

Due precautions were taken to find that all measuring instruments were correct. Steam gauges were compared with a mercury column, and either corrected or calibrated therefrom. Indicator springs were compared with a correct gauge and calibrated accordingly. Thermometers were tested at boiling and freezing points, and compared with a standard instrument. Scales used were adjusted and certified to by Fairbank's Morse & Company. Pyrometers were compared with a standard thermometer in a smoke flue, and a table of corrections made. The water meter was calibrated by weighing the water actually discharged.

Observations from which the results were obtained were taken every ten minutes—the timekeeper sounding a gong which gave the signal to all. Water and fuel were weighed before use. As it was necessary to take all the indicator readings at the same time, an electro-magnetic device was used to bring the pencils of the indicators against the drums at the same instant. These magnet coils were in series and consumed about 12 amperes. Each coil was of about 1 ohm resistance.

Every conductor was furnished blanks on which it was noted every ten minutes:

- (1) Whether car was moving or stopped.
- (2) Number of passengers.
- (3) Location of car.
- (4) Whether car was lighted or not.

Test No. 1 was made on Power House No. 1, Minneapolis, beginning 4:20 a. m., March, 5, 1892, and closing 1:30 a. m., March 6, 1892, a time of 21 hours and 30 minutes. The power house contains two tri-cylinder condensing Allis Corliss engines, belted to a line shaft from which are run sixteen 175 kilowatt and two 89 kilowatt Edison generators, and a 100 light arc machine. In giving the results of these tests we will publish only the final results, as only such have any value for comparison, and hence any interest to the busy reader. The figures are as follows:

Average total horse-power during run including lighting.....	1237.9
Ratio of horse power of condenser engines to that of main engines.....	1 $\frac{1}{10}$ per cent
Ratio of total steam used in jackets to steam used in cylinder.....	9 $\frac{1}{10}$ per cent
Loss by friction (difference between steam and electric horse-power).....	12 $\frac{1}{10}$ per cent
Steam used in cylinders and jackets per horse-power per hour.....	19.05 lbs
Evaporation of water per pound of oil as used.....	11.87 lbs
Evaporation of water per pound of oil from and at 212°.....	13.50 lbs
Cost per total horse-power per hour.....	\$0.0099
Cost per horse-power per hour delivered to line.....	\$0.0125

Total mileage (from auditor's office).....	17,451
Cost per car mile.....	\$0.0151
Cost per car hour.....	\$0.108
Total number of passengers carried.....	66,990
Cost per passenger.....	\$0.00392

These figures include labor (exclusive of chief engineer and electrician) fuel, waste and oil, and also the heating of the station, which could not at that time be separated from the total power.

Test No. 2 was made on the St. Paul plant, beginning 4:40 a. m., March 23, 1892 and ending 2:00 a. m., March 24, 1892, lasting 21 hours and 20 minutes. The machinery in use consisted of two tri-cylinder condensing Allis Corliss engines. These are belted to two shafts to each of which shafts a generator is coupled by a friction clutch. The results read:

Average total horse-power during run available for car use.....	756.2
Ratio of horse-power of condenser engines to horse power main engines.....	1 $\frac{5}{10}$ per cent
Ratio of total steam used in jackets to steam used in cylinders.....	13 $\frac{1}{10}$ per cent
Loss by friction (difference between steam and electrical horse-power).....	17 $\frac{1}{10}$ per cent
Evaporation of water per pound of oil as used.....	11.54 lbs
Evaporation of water per pound of oil from and at 212°.....	12.73 lbs
Cost per total horse-power per hour.....	\$0.00887
Cost per horse power on the line per hour.....	\$0.01074
Total mileage.....	9,848
Cost per car mile.....	\$0.01443
Cost per car hour.....	\$0.1446
Cost per passenger.....	\$0.004969

Test No. 2 c was made on the St. Paul Power House, using coal instead of oil.

Water evaporated per pound of coal.....	6.4 lbs
Water per pound of coal from and at 212°.....	7.5 lbs
Cost per indicated horse-power per hour.....	\$0.01659
Cost per average horse-power on line.....	\$0.01294
Ratio of cost of power burning coal to cost burning oil 120:100 or coal costs more than oil.....	20 per cent

This set of figures includes the cost of extra labor using coal.

The following table is headed, "Relative cost of power burning oil at \$0.0226 per gallon and burning coal at prices varying from \$2.00 to \$4.85 per ton, assuming an evaporation from the coal of 7 $\frac{1}{2}$ lbs. water from and at 212°." This is of course derived from figures obtained in the foregoing tests.

COAL AT \$2.00 PER TON.

Cost per horse-power per hour.....	\$0.005631
Saving over oil.....	37 $\frac{1}{10}$ per cent

COAL AT \$2.25 PER TON.

Cost per horse power per hour.....	\$0.006099
Saving over oil.....	31 $\frac{1}{10}$ per cent

COAL AT \$2.50 PER TON.

Cost per horse-power per hour.....	\$0.00655
Saving over oil.....	26 $\frac{1}{10}$ per cent

COAL AT \$3.00 PER TON.

Cost per horse-power per hour.....	\$0.007452
Saving over oil.....	16 $\frac{1}{10}$ per cent

COAL AT \$3.50 PER TON.

Cost per horse-power per hour.....	\$0.008354
Saving over oil.....	6 $\frac{1}{10}$ per cent

COAL AT \$4.00 PER TON.

Cost per horse-power per hour.....	\$0.009256
Cost above oil.....	3 $\frac{1}{10}$ per cent

COAL AT \$4.50 PER TON.

Cost per horse-power per hour.....	\$0.010158
Cost above oil.....	13 $\frac{1}{10}$ per cent

COAL AT \$4.85 PER TON.

Cost per horse-power per hour.....	\$0.01069
Cost above oil.....	19 $\frac{1}{10}$ per cent

From these figures the relative economy of any coal, the evaporating power of which is known, can be computed. For example, a coal which has an evaporating power of only $\frac{1}{2}$ of that stated would be equivalent to coal at $\frac{2}{5}$ the price.

Test No. 2d was made at the St. Paul Power House, July 23, 1892, with the object of ascertaining the relative value of hard coal screenings mixed with 2 $\frac{1}{2}$ % per cent bituminous screenings and costing \$1.40 per ton, and oil at \$0.0258 and \$0.0261 per gallon; and to obtain the efficiency when one engine was doing all the work, more generators having been added to each engine. The test lasted ten hours, from 9:15 a. m. to 7:15 p. m. The results are:

Water as evaporated per pound of coal.....	5.72 lbs.
Equivalent water from and at 212°.....	6.18 lbs.
For the period from 10 a. m. to 5:20 p. m.:—	
Water evaporated per average horse-power hour.....	21.99 lbs
Water from and at 212° per horse-power hour.....	23.74 lbs
For the period from 3:20 to 5:20:—	
Water as evaporated per horse-power hour.....	20.42 lbs
Water from and at 212° per horse-power hour.....	22.05 lbs
Average electrical horse-power from 10 a. m. to 5:20 p. m.....	737.35
Same from 3:20 p. m. to 5:20 p. m.....	\$12.20
Per cent of friction to total horse-power.....	19.12 per cent
Cost per hour of extra help required to handle coal.....	\$0.55
Cost per horse-power hour (including labor, waste and lubrication).....	\$0.00515
Cost per horse-power per hour, burning oil \$0.0258 cents per gallon (calculated from test No. 2).....	\$0.009952
Saving over oil as above when burning screenings.....	48 $\frac{1}{2}$ % per cent
Effect on efficiency of running engine nearer its proper rating.....	6 $\frac{1}{10}$ % per cent

Oil and waste per day, Test No. 1.....	\$14.71
Cost per horse-power hour (fuel, labor, lubrication and waste), Test No. 1.....	\$0.00881
Cost per electric horse-power hour, Test No. 1.....	\$0.01004
Cost per car mile, Test No. 1.....	\$0.01346
Cost of power, Test No. 2.....	\$112.61
Cost of labor, Test No. 2.....	\$23.83
Lubrication and waste, Test No. 2.....	\$7.82
Cost per horse power hour, Test No. 2.....	\$0.00895
Cost per electric horse-power hour, Test No. 2.....	\$0.01083
Cost per car mile, Test No. 2.....	\$0.01464
Cost of fuel oil, Test No. 3.....	\$99.04
Cost of labor per day, Test No. 3.....	\$16.83
Cost of lubrication and waste, Test No. 3, per day.....	\$4.02
Cost per horse-power hour, Test No. 3.....	\$0.01110
Cost per electric horse-power hour, Test No. 3.....	\$0.01336
Cost per car mile, Test No. 3.....	\$0.01904

In test No. 3 less than half the power of the plant was used, and consequently allowance must be made for the fact that the item of labor was somewhat high in proportion. It is claimed that no more labor would be necessary to run the plant at its full capacity.

The authors then make a comparison of the cost of concentrated power as against subdivided power, which we quote in full.

"In making this comparison the results as obtained from above tests at Thirty-first street are compared with those obtained from the test of the triple expansion engines at Power House No. 1. In order that the results may be properly compared the following assumptions are supposed to apply to both plants, though they were different when the test was made

Cost of fuel oil per gallon.....	\$0.0257
----------------------------------	----------

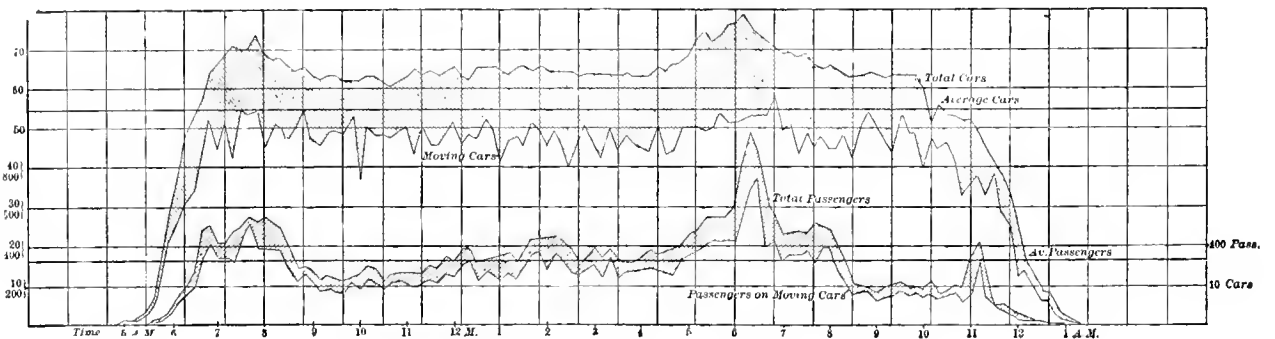

DIAGRAM OF CARS AND PASSENGERS.—ST. PAUL, MARCH 23, 1893.

Test No. 3 was made on the Thirty-first street station October 21 and 26, 1892. The plant consists of ten 16 by 27 by 16-inch Westinghouse compound engines, nine of which are belted directly to Thomson-Houston generators, and one to an exciter and arc light machine. On October 21 a steady load test was made, the generators feeding into a steady resistance. The main result of interest in this test is that the ratio of steam used in atomizing the fuel oil, to the total steam, was found to be the surprising amount of 13 $\frac{1}{10}$ % per cent.

Test No. 3 b was made with the Thirty-first street plant in actual service, October 26, 1892, lasting 20 hours and 40 minutes.

Average horse-power.....	522.5
Maximum horse-power.....	901.25
Minimum horse-power.....	77.49
Average electric horse-power.....	434.2
Percentage of loss between engines and line (by difference).....	16.9 per cent
Equivalent water from and at 212° per pound of fuel oil.....	14.48 lbs
Equivalent evaporation per pound of standard coal.....	9.87 lbs
Cost of fuel oil per car mile.....	\$0.1573

SUMMARY OF ALL TESTS—COMPARATIVE COST PER HORSE-POWER HOUR.

From the tests made at the Thirty-first street station under the title of "Test No. 3," it is determined that the cost of running the necessary pumps and atomizing the fuel oil is in percentage of the whole power.....	15 $\frac{1}{10}$ % per cent
Cost in percentage of whole power of atomizers, Test No. 1.....	13 $\frac{1}{10}$ % per cent
Cost of labor per day, Test No. 1.....	\$51.50

Evaporation from and at 212° per pound of oil.....	14.48 lbs.
Total car mileage to be provided for.....	17,118
Average horse power for 21 hours 30 minutes for above mileage, Power House No. 1.....	1,203.5
Average horse power for 21 hours 30 minutes for above mileage, Thirty-first street power house.....	1,173

Note.—This difference comes from the difference in friction at the two stations. At No. 1 it is estimated at 20 per cent, and at Thirty-first street at 17 per cent.

The following figures, which are as close as could be obtained from the auditor's office, are the basis of the "fixed charges" which go to make up total cost, and will serve as a basis of comparison:

Value of real estate and building, assumed to be the same for both plants for comparison.....	\$35,000
Value of engines, Power House No. 1.....	\$60,000
Value of boilers, Power House No. 1.....	\$25,000
Value of line shafting, Power House No. 1.....	\$15,500
Value of belting, Power House No. 1.....	\$5,000
Total.....	\$105,500
Value of engines at Thirty-first street.....	\$35,000
Value of boilers at Thirty-first street.....	\$25,000
Value of belting at Thirty-first street.....	\$1,500

Total.....	\$61,500
Rate of interest on investment.....	.6 per cent.
Rate of depreciation on machinery.....	10 per cent.

COST OF LABOR, POWER HOUSE NO. 1.

10 men at \$55 per month.....	\$ 550
4 men at \$65 " "	260
1 man at \$75 " "	75
1 man at \$80 " "	80
1 man at \$100 " "	100
Total.....	\$1,065
Or \$35.50 per day.	

COST OF LABOR, THIRTY-FIRST STREET.

6 men at \$55 per month.....	\$330
1 man at \$75 " "	75
1 man at \$100 " "	100
Total.....	\$505
Or \$16.83 per day.	
Cost of superintendence, estimated at \$2.75 per day per station.	

COST OF LUBRICATING OIL AND WASTE, POWER HOUSE NO. 1.

Cylinder oil, 126 gallons per month, at 50 cents.....	\$ 63.00
Engine oil, 94½ gallons per month, at 25 cents.....	23.62
500 pounds of waste at 10 cents.....	50.00
Total.....	\$136.62
Or \$4.55 per day.	

COST OF LUBRICATING OIL AND WASTE AT THIRTY-FIRST STREET IF ALL ENGINES WERE IN USE.

Cylinder oil and waste, 63 gallons.....	\$ 31.50
Engine oil.....	12.00
Crank case oil, 378 gallons.....	56.70
Waste, 200 pounds.....	20.00
Total.....	\$120.20
Or \$4.00 per day.	

TOTAL COST PER DAY OF 21 HOURS 30 MINUTES AT POWER HOUSE NO. 1—CAR MILEAGE 17.18.

Fuel oil for 1,203 horse-power at rate of 25.4 pounds water per horse-power per hour, from and at 212°, and 14.48 pounds water from and at 212° per pound, oil.....	7,258 gals
Cost at \$0.0257 per gallon	\$186.53
Interest on machinery.....	\$17.58
Interest on real estate and buildings.....	\$5.59
Depreciation of machinery.....	\$29.30
Lubricating oil and waste.....	\$4.55
Labor.....	\$35.50
Superintendence.....	\$2.75
Cost per car mile, Power House No. 1, for fuel oil, lubricating oil, waste and superintendence	\$0.013333
Cost per car mile for interest and depreciation.....	\$0.003065
Total cost per car mile, power house No. 1.....	\$ 0.16398

Note—This includes, as it should, 4.5 pounds per horse-power hour for condenser engines, pumps, atomizing oil, etc.

TOTAL COST PER DAY OF 21 HOURS 30 MINUTES AT THIRTY-FIRST STREET STATION IF CAR MILEAGE WERE 17.118.

Fuel oil for 1,173 horse-power at rate of 33.27 pounds water per horse-power per hour.....	9,200 gals
Cost at \$0.0257 per gallon.....	\$236.55
Interest on machinery.....	\$10.11
Interest on real estate.....	\$5.59
Depreciation of machinery.....	\$16.88
Lubricating oil and waste.....	\$4.02
Labor.....	\$16.83
Superintendence.....	\$2.75
Cost per car mile, Thirty-first station, for fuel oil, labor, lubricating oil and waste and superintendence.....	\$0.01513
Cost per car mile for interest and depreciation.....	\$0.00190
Total cost per car mile Thirty-first street.....	\$0.01703
Percentage in favor of concentrated power.....	3% per cent

In this comparison of concentrated and subdivided power it has been our object to put both plants on the same basis as far as it is proper and to make the results depend upon the real difference between the two.

For these reasons the Thirty-first street plant has been treated as if it were covering the same mileage as the No. 1 plant, and that it required the same horse-power on the line to do it. The result as given above shows very little difference in cost per car mile, and if the pressure at the engines were 140 lbs., as required by the contract for the engines, we estimate that at least 6 per cent would be saved in steam*, and therefore in fuel oil, which would bring the total cost per car mile down to \$0.01615 for the Westinghouse plant as compared with \$0.016398 for the No. 1 plant, or 1½ per cent less."

Among the numerous other tabulated results one of the most interesting is that taken from the conductors' record. One taken during test No. 1, at Minneapolis, shows the average ratio of moving cars to total cars to be .811. The average horse-power per moving car was found by the same test to be 12.562. Test No. 2 shows the ratio of moving cars to be .730 and the horse-power per car to be 19.65.

*The authors explained when the paper was read that the piping in the station caused a considerable drop in pressure, hence the calculated increased efficiency of 6 per cent.

ILLUMINATED SIGN ON THE CALUMET.

A DEVICE that can be made use of to advantage where there is a multiplicity of lines, and one that will be appreciated by the public, who are always grateful for indications as to the proper route, is shown in our engraving of the "Calumet Electric to Pullman."



ELECTRIC SIGN—CALUMET RAILWAY.

It is located at the intersection of Stony Island avenue and Seventy-ninth street, this city. The importance of having a sign of this kind can be understood when it is learned that five lines converge at this point, a part of which belong to the Calumet Electric Railway and a part to the South Chicago City Railway. Moreover, they have only been running a short time, and the public are unacquainted with the routes. There would therefore be abundant opportunity for confusion at this point were it not for the sign. It is at least a very suggestive idea. Such signs can be used with advantage not only for indicating routes, but for advertising special attractions at pleasure resorts, and other points reached by the road. The sign in question has about 240 lamps, and takes at 500 volts about 24 amperes. Small lamps of low voltage

STREET RAILWAY LAW.

EDITED BY MR. FRANK HUMBOLDT CLARK, ATTORNEY AT LAW, CHICAGO.

City revoking Street Railway Franchise.

This case holds that a city may revoke a grant of a franchise to a street railway company by repealing the granting ordinance, even after the track has been laid, when in the judgment of the City Council, safety, convenience and the proper regulation of the use of the street require it.

In the opinion, the Court said:

The control of the city over the streets is attended with the duty of preserving them for their legitimate purposes. They are intended for the passage of the people over them, on foot, on horseback and in vehicles, on their various occasions of business, convenience and pleasure. It is not competent for the city to defeat the primary purposes for which they were dedicated to the public use. They are highways, and must be maintained as highways so long as they are kept in existence. The power over the streets is held on the same trusts as the other legislative powers conferred on the Mayor and City Council. It is intended to be used for the purpose of preserving them in the character of streets in such condition as may be most suitable for the public use. It is of incalculable importance to the public interest and there can be no more reason to suppose that the city can abridge or surrender this legislative power than any other. In the State of New York, where a railroad company may, by the constitution and statutes, acquire an estate in perpetuity in the streets, it is held that statutes authorizing telegraph companies to erect and construct the necessary fixtures for their lines upon public streets, could be repealed after the fixtures had been erected. These were general, public legislative acts, in the exercise of the police power of the state, and therefore they were not beyond the reach or touch of future legislation. The legislature did not intend to divest itself, and could not divest itself of its control over the streets for the public welfare, and we must infer from the language used that it did not intend to bind itself by an irrevocable grant. If therefore these acts are to be construed as merely conferring a license which has been acted upon by the plaintiff, the legislature could revoke the license or modify it in anyway or at any time when the public interest might require it. If an ordinance cannot be repealed which will reduce Lexington street to the condition which we have described, then truly the City Council have lost all control over the streets, and have renounced their legislative power, and it will be demonstrated that they have the power to destroy their utility for the legitimate purposes of streets, and to convert them to places of extreme peril to life and limb, but not the power to keep them in a condition suitable for their ordinary use as highways. Our municipal governments were not instituted for the purposes of making any such result possible. The repealing ordinance was passed because, as stated in the preamble, the City Council thought that it was required by "the public safety and convenience, and the proper regulation of the use of the streets." These conditions for the repeal

were within their legislative judgment and discretion, and the evidence showed that the ordinance has "a real and substantial relation" to the objects proposed. It is therefore not subject to supervision or review by the courts. This legislative authority over the streets, delegated to the City, is sometimes classified as belonging to the police power—that is to say, that great power which embraces the protection of life, limb, health and property, and the promotion of the public peace and safety. It is a high conservative power of the utmost importance to the existence of good government. It has been most emphatically declared by the Supreme Court of the United States on several occasions that a state cannot limit its exercise of this power by contract, or in any other way. Some of the best known and most striking cases are *Stone vs. Mississippi*, 101 U. S. 814; *Beer Co. vs. Massachusetts*, 97 U. S. 25; and *Fertilizing Co. vs. Hyde Park*, id. 659. But supposing this designation not to be appropriate in the present instance, the name given to the power is of no importance. It is expressly conferred by the legislature. Maryland Court of appeals, *Lake Roland El. R. Co. vs. Mayor, etc., of Baltimore*, 8 notes of cases, 43.

(NOTE.—"The legislature of the state has full and preeminent authority over all public ways and places. But the legislature, instead of exercising this authority directly, unusually confers upon the municipal authorities the power to control and regulate the roads and streets within their jurisdiction. Just how far these powers extend in any particular case, must be determined by the special charter or legislative enactment by which the authority is conferred." Elliott on roads and streets, 327.

In granting a railway company the right to use its street the municipal corporation exercises a governmental power delegated to it by the legislature, and the ordinance when accepted is in the nature of a contract, but it is not a contract entirely beyond the municipal or legislative control. No contract can be made which assumes to surrender or alienate a strictly governmental power which exists for the welfare of the public. It cannot be doubted that a company which secures the right to use the streets of a municipal corporation, does it subject to the police power resident in the state as an inalienable attribute of sovereignty. Same, 564.

The state or its authorized agencies may require a street railway company to do whatever is regarded to be for the health, safety and welfare of the people. The authority to enact measures for these purposes never passes from the people, all corporate rights being accepted subject to this sovereign power. The rights of the municipality, however, cannot be extended so far as to permit it unnecessarily to limit or restrict the operation of the railroad company, nor to authorize any act that will destroy the company's franchise or arbitrarily interfere with its business. Booth on Street Railways, 222.

"The exercise by the State, at any time, of its police power, cannot be construed into a violation of the Federal Constitution, as impairing the obligation of contracts, notwithstanding its effect may be to repeal existing charters or otherwise invade the terms of legislative engagements" American & English Encycopaedia of Law, Title "Constitutional Law" page 747.

"The doctrine that grants of franchises are contracts, has been frequently invoked in efforts to protect corporations from the operation of laws passed in pursuance of the police power of states. But all agree that the Legislature cannot bargain away the police power of the state, and while irrevocable grants of property and franchises may be made if they do not impair the supreme authority to make laws for the right government of the people, no legislature can curtail its power to make such laws as they deem proper in matters of police." Same, Title, "Franchises," page 621.)

Street Railway Review

Contributory Negligence—Failure to look and listen—Driving on temporary Roadway.

Owing to a washout, the city constructed a temporary roadway about 120 feet in length near a street car track, and persons driving along the street were compelled to cross the track when they reached the temporary roadway and again when they left it. *Held*, that a driver of a wagon, with full knowledge of the dangerous character of the place, crossing the car tracks on the temporary roadway without looking for an approaching car, which struck him as he was attempting to cross again, was guilty of contributory negligence and could not recover from the street car company.

Where the temporary roadway was of sufficient width to permit the street cars to pass wagons and other vehicles, the motor-man was guilty of no negligence in failing to stop the car or slacken its speed after discovering the driver on the temporary roadway, since he was not bound to anticipate that the driver would attempt to cross the tracks in front of the car.

(Supreme Court of Washington. *Christenson vs. Union Trunk Line*, 32 Pacific Reporter 1018.)

Municipal Corporations—Control of Streets—Interfering with Street Railway.

Spokane city ordinance authorizing a street railway company to construct its tracks in the streets, provided that "nothing herein shall be deemed or construed to mean that the city relinquishes any of its rightful authority over the streets * * * but the city shall have full power to enter upon said streets or any parts thereof for the construction of sewers or other public works."

Plaintiff brought the action to restrain the defendants from proceeding with the construction of a certain sewer, for the reason that in the prosecution of the work the railway of the plaintiff would be greatly interfered with.

It may be said, as a general proposition, that the city has absolute authority over the streets and every part thereof for the purposes of constructing sewers or making other improvements which the welfare of the city demands. The grant of a franchise to a street railway company would be subject to this general rule, even although there was no reservation of any rights of the city in the ordinance by which said franchise was granted. To give any force to such reservation at all, it must be held to apply to that portion of the street in controversy. The city had the right to construct the sewer in the center of the street as it was proposing to do.

(Supreme Court of Washington. *Spokane Street R. Co. vs. City of Spokane*, January 31st 1893, 32 Pacific Reporter, 456.)

Obstruction of Street-car track by paving Contractors—Rights of Street Railway.

Contractors under contract with a city to pave a certain street, have no power to obstruct the passage of street cars over such street during the paving of the same, where the contract gives no such power, and it is shown

that such work has been and can be done without such interference.

(Supreme Court of Wisconsin. *Milwaukee Street R. Co. vs. Adlam*, 55 Northwestern Reporter, 181.)

Street Railway laying Track without Authority—Acquiescence on part of City—Ordinance requiring track to be torn up.

The appellant brought an action against respondents to prohibit them from interfering with its street railway upon Division street in the city of Spokane Falls. On July 16, 1886, the city by an ordinance of that date, granted to appellants' assignors the right to lay down, maintain and operate a street railroad upon certain streets, which were named, of which Division street was not one; but in building its road it laid a portion of its track on Division street. On March 14, 1889, the Spokane cable railway company obtained a similar franchise from the city for the construction, operation and maintenance of a cable railway on sundry streets, among which was Division street. The Spokane Cable Railway Company had in part complied with the terms of its ordinance by laying down certain rails, one line of which was on the outside of each of the rails of complainant's original track, this having been done by agreement between the two companies. Subsequently, and before the commencement of this action, the Spokane Cable Railway Company had sold and assigned to the appellant all of its rights under the ordinances granting to it authority to maintain a cable railway in Division street. The City Council, on June 16, 1890, passed a resolution requiring the plaintiff to tear up all of its rails on Division street, and cease operating its line of railway upon said street. The supplemental complaint showed that notwithstanding a restraining order issued by the Superior Court, the respondents had destroyed a portion of the appellants track; that the police officers of the city have protected the City Park Transit Company in laying down its track in place of appellant's thus torn up, and that other portions of the track of appellant were still intact, respondents, however, threatening to dispose of that in like manner. A municipal corporation should not be permitted to stand by and see large amounts of money invested in enterprises of this sort, by persons who act under the mistaken view that they have legal authority. The road was operated for upwards of two years, during which time the city made no objection, and from year to year levied and collected taxes upon this very property, and up to this time, so far as complaint shows, no objection has been made to the operation of a street railroad upon Division street. The appellant, we think, has succeeded to whatever right the Spokane cable railway had under the ordinance authorizing the maintenance of a cable railway on Division street. The mere fact that the grantee of a franchise to lay and maintain a cable railway, should have laid down a railway not adapted to the use of the cable, but only adapted to use by means of horses, would not constitute the horse railway a nuisance which could be abated by the municipal corporation at its pleas-

ure. In such a case the only proper course would be for the city to take such proceedings as would result in compelling the operation of the road by cable instead of by horses. A franchise of this kind is a contract which it does not lie in the power of either party to abrogate by such summary measures as were taken in this case.

(Supreme Court of Washington. Spokane Street Railway Company vs City of Spokane. June 20, 1893, not yet reported.)

*Statute requiring Street Railroad to keep Roadway level—
Supervision of Engineer.*

A statute requiring a street railway company to keep the roadway level with the rails, between them and two feet outside, under the supervision of the state engineer, is not complied with by the mere approval by the engineer of what has been done, where the roadway is not in fact level.

(Supreme Court of Nova Scotia. Joyce vs. Halifax St. R. Co., 24 Nova Scotia Reports, 113.)

THE Duplex Street Railway Track Company, with offices at 51 Wall street, New York, assigned July 17, without preference, to John D. Elwell. The company is said to have done a \$500,000 business last year. The liabilities are \$100,000 and the assets about the same. The company was organized in June, 1891, at \$1,500,000. A number of prominent men are in its directory. Inability to borrow money was the cause of the failure.

SPECIAL STREET RAILWAY EXCURSIONS.

THE steam roads have long appreciated the revenue derived from special excursions (or have until the opening of the World's Fair), and hence we have summer excursions to the north, winter excursions to the south and far west, and harvest excursions in the fall. As has been so earnestly advocated in these columns, the street railway manager can profit by studying many of methods employed on steam roads, especially in the case of lines operating in the smaller cities, where there is less in the way of public attractions to draw out the crowds.

The Delaware Electric Street Railway, of Delaware, Ohio, is among the less pretentious roads, with a cross-town line running east and west about three miles; a north and south line of about two miles, and a belt line. The company have seven cars, with six in ordinary service. Five of the cars meet at a transfer station every fifteen minutes. The business of the road did not warrant a double equipment of closed and open cars, and while the day riding was very satisfactory, there was a big falling off after 7:30 p. m, except on Saturdays. To offset this, the company engaged a band for the season, which gives a free concert every Thursday evening, at Greenwood Lake, at the east terminus. This draws out a big crowd, and insures good riding for that evening. But there were still four evenings a week when there was no

attraction, and the sight of the lean and ill-favored loads set Manager F. P. Welch to thinking, and so he advertised a street railway excursion at ten cents an excursion. The regular fare is five cents, or six tickets for twenty-five cents with privilege of one transfer, and as the excursion rate covered the entire tracks operated by the company, and gave twice as much riding as was ordinarily furnished for ten cents, Manager Welch found it necessary to restrict the use of the ticket somewhat, which he did as follows:

EXCURSION TICKET.
DELAWARE
Electric Street R'y Co.
Good only for date and hours indicated.
Tuesday Evn'g, July 18, 1893, from 7 p. m. to 10:30 p. m.
Each coupon good for one continuous trip over any of the Delaware Electric Street Railway lines if not detached.
No Transfer Checks will be given on this Ticket.
Children over five years will not be carried on this ticket free.
This Ticket Not Transferable.

To the ticket were attached eight coupons, covering four routes out and the same returning, or permitting the holder to ride the length of any one line four times and return. Coupons read thus:

Good for ONE FARE, if not detached, this date only, from 7 until 10:30 p. m.
--

The scheme was advertised on Sunday and Monday, and as a trial 500 tickets were printed, and put on sale through the change boys. In a short time every ticket was disposed of, and demands made for many more. The idea seemed to strike the public all in a heap, and the next excursion was even a greater success. So satisfactory has the plan proved, the summer evening excursion is now a fixture, and occurs regularly on two nights a week. This, with the band Thursday and the regular heavy riding Saturday night, leaves only two unfilled dates per week. Just what to do with these Manager Welch has not fully decided. At last accounts he was hunting for a job lot of barns, which he could buy cheap and advertise a real conflagration.

At first it was feared the special rate might clash with the regular cash fare, and that advantage would be taken of the rate by riders who would have traveled anyway. But the fact that the detached coupons are of no value, together with the close time limit, was found to afford an entirely satisfactory protection to the company.

The excursion ticket, however, is a scheme which can be very successfully worked in very many places, and as can be readily seen, creates riding which otherwise would have no existence, fills the cars at a time when they would otherwise go with but small loads, and popularizes the road and its management with the public.

STERLING SUPPLY COMPANY'S SAND BOX.

THE very effective sand box adopted by the Broadway cable line in New York, and made by the Sterling Supply Company, of 47 Cedar street, that city, is here illustrated in cross section. The frame work of the box is cast iron and the gears, hoppers and valves of malleable iron. The reason for this construction is to

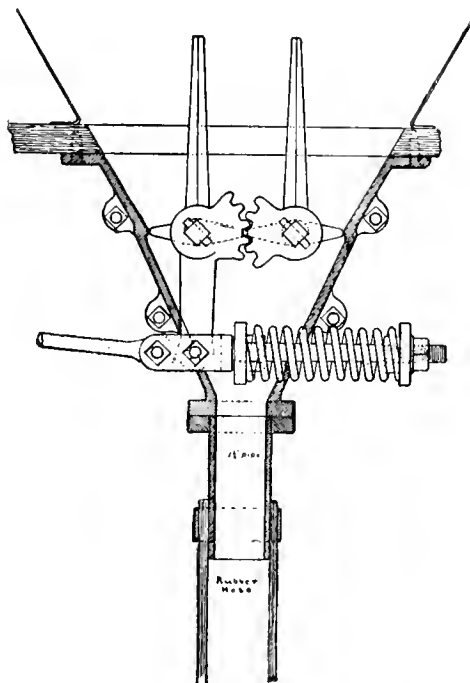

STERLING SAND BOX.



STERLING FARE REGISTER.

guard against breakage when stone or coarse material gets mixed with the sand. Outside the box and serving to hold it shut is a powerful spiral spring $\frac{3}{8}$ inch in diameter. The rod at the left is connected to a bell crank attachment under the car platform. This bell crank is in turn worked by a pin extending through the car floor. They can also be operated by levers with a

handle running up the dashboard. The company makes a device for throwing up the hose attachment when not in use by the same movement that closes the box.

The Sterling Supply Company also make three types of fare register: the dial faced, used on Third avenue, New York, the double disc used on Broadway and the old reliable disc, used for nine years on Twenty-third and Bleecker streets. That used on Broadway is the latest pattern. Taken altogether they have a rather large representation of their products at work in the eastern metropolis, and all are giving complete satisfaction.

STARTING THE BLUE ISLAND CABLE LINE, CHICAGO.

THURSDAY, July 27, will be a long remembered day among the natives along Blue Island ave., this city. The preparations so long and thoroughly made by the West Chicago Street Railroad to give this extensive territory rapid transit had been so far completed, that the time for visible results had arrived. A few minutes after noon, Assistant General Manager Crawford donned a new pair of buckskin gloves and with a representative of the STREET RAILWAY REVIEW mounted grip No. 1591, to which was attached one of the handsome new trailers. That Mr. Crawford is as familiar with the practical workings of every detail as with office duties was evident from the skillful manner in which he handled the train on the trial trip. Superintendent Nagl followed close behind with another train. The inauguration was carried out quietly so far as the company were concerned, but not so the natives along the line. They swarmed on and about the cars, anxious to ride, if only a few feet, on the first train. The streets were filled with thousands emptied from factories, stores and tenements at that hour, and the train swept down and back the line amid one prolonged cheer. Everything worked perfectly and the officers, the company and the Pennsylvania Iron Works, which built and installed the magnificent plant, are to be heartily congratulated on their unqualified success.

INVENTORS of canal trolley systems are notified by Superintendent Hanna, of the New York state department of public works, to make trials on the Erie canal before October, 1.

JUDGE ALFRED C. COX, of the United States Circuit Court, handed down a decision, July 21, in the American Cable Railway Company versus the Mayor, Alderman and Commonalty of Brooklyn, N. Y. This case regarded the rights of Daniel J. Miller to patent No. 271,727, bearing on the invention of the combined support or carrying pulley for cable roads in the United States. It was decided in favor of Miller last April and a commission was appointed to assess damages. Time was given the bridge trustees of Brooklyn bridge (who use the device) to come to terms. In failure of this an injunction will be put in force.

OLD GIRDER RAIL AS BRIDGE JOINTS.

IN Lincoln, Neb., a considerable portion of the lines were originally laid with 38-pound Johnson girder. As long as the horses were in use this answered very well, but with the change to electricity the joints naturally began to suffer. The choice very soon stared General Manager Upham in the face, of relaying his lines with heavier iron or giving the joints a more visible means of support. He instructed his roadmaster, Daniel Sullivan to do what he could and Mr. Sullivan at once tackled a pretty big job. There was on hand plenty of odd lengths of the girder rail already mentioned, and some full lengths which were so pounded on the ends they had been taken up. The illustration shows the plan adopted, which was to saw up old rail into suitable lengths. Two pieces were used at each joint. Where the joint was suspended, the pieces covered two ties; where the joint came over a tie the bridge rested on three ties. The supporting rails are spiked on the outside;

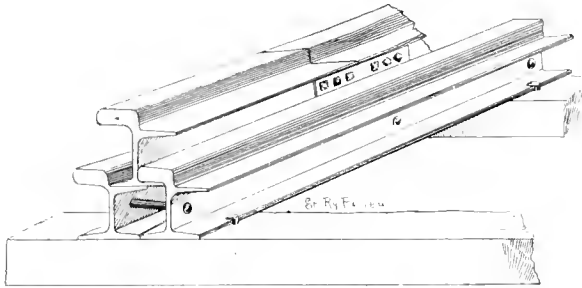

METHOD OF USING 38-POUND SCRAP GIRDER FOR BRIDGE JOINTS.

one of them carries the track rail, the other acts to hold it in position, which it does, firmly and securely. The supporting rails are bound by gas pipe 3 inches long and $\frac{3}{4}$ inch diameter passing through holes drilled in the web of the supporting rails and bolted at each end. In the joints laid, two of the gas pipe bolts were used, but Mr. Upham believes three, one at each end and one in the center, would be better. The usual splice bar should be retained on the track rail and comes just above the edge or top of the inside supporting rail. Where paving is brick, the lower course of brick is left out and the upper course placed against the rail in the ordinary manner; with cedar block, the blocks are notched for the length of the supporting rails with a hatchet or saw, so they will fit up snugly against the rail. Several hundred of these joints have been down several months and Mr. Upham pronounces them first rate for supporting light rail. For new construction Mr. Upham would recommend a heavier rail in the first place, in which case it is doubtful if the arrangement would show as great economy in proportion to the light rail, especially if scrap rail had to be purchased to make the joints. But where light rail is already down and too good to throw away, the system abundantly serves the purpose of strengthening the rail until its usefulness is gone. The cost of the joint where the company has a lot of scrap 38 pound Johnson girder on hand, and with the value of scrap steel at \$10 per ton,

would be about 65 cents, because the scrap rail could be sold for as much after it had been used, as before; and if it were necessary to purchase scrap rail the cost would be about \$1.40 per joint. The trouble of placing the joint is less than would be supposed, as the supporting rails are the same height as the chairs they displace. We are indebted to Manager Upham for the above information and sketch.

CANADIAN VOLTS.

[Special Correspondence.]

ALTHOUGH Montreal has not suffered the rending shock of a Sunday street car controversy, street railway matters have been before the public to some degree.

The new superintendent of construction of the Montreal street railway, Mr. Brothers, deserves great credit for the rapidity with which he has pushed the new connections. His work of six miles of double track from McGill to Hochelega is one of the quickest track laying feats on record.

The Montreal Street Railway Company reports the total receipts for July at \$17,269 or an increase of \$9,000 over July '92. The number of car miles has increased from 93,601 to 282,696. The company has just contracted for 500 additional horse-power from the Royal Electric Light Company, arranging a new schedule for Exposition week, so that 60 cars an hour will reach the grounds. The Company authorizes the directory to issue bonds to the extent of \$700,000.

New firms are not now very prolific, on account of the stringency in money. Messrs. Chryster & Lewis, of Ottawa however decide to incorporate a company which will provide electrical light, heat and power and will buy and amalgamate other existing plants in Canada.

Ottawa, with the accustomed enterprise, will probably be the first to introduce street railway mail service in Canada. A special car for her Majesty's mail will be built.

Sunday cars in Toronto have been the subject of many doubtful disputations and some bitter feeling between the pros and antis. Meetings have been held by both factions and letters of many words and strong language have flooded the papers. The street railway company very properly does not engage in the fight but will abide the popular vote, which will be taken the latter part of this month.

DURING the recent riots in Paris the tramcars suffered considerable damage; in some cases being overturned and used as a barricade by the infuriated mob. Our illustration, copied from the London Graphic, shows one of these disasters.

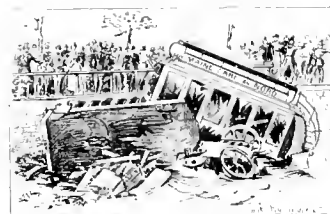

THE LUNKEN GATE VALVE.

FOR several years there has been almost no progress in the valve industry. The old globe valve is still the standard in spite of its many shortcomings. The main objections to the globe are, of course, the difficulty with which it is repaired and the great frictional loss in passing through a crooked opening. Lately there has been a slight tendency towards gate valves. The Lunkenheimer Company, of Cincinnati, will shortly

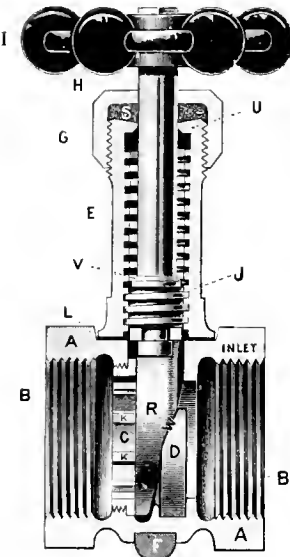

Fig. 1.

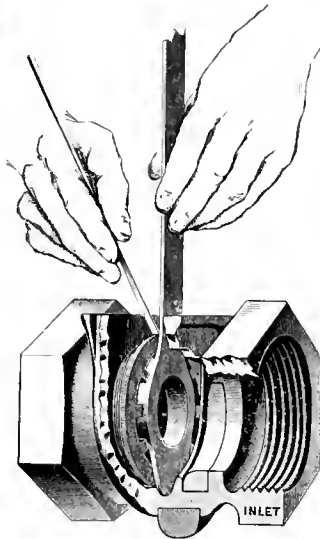

Fig. 3.

put on the market a new gate valve, offering great facility of repair with compact and strong design. Its construction can best be seen by an inspection of the cuts.



Fig. 2.

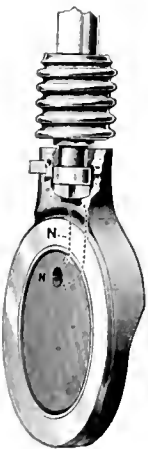

Fig. 4.

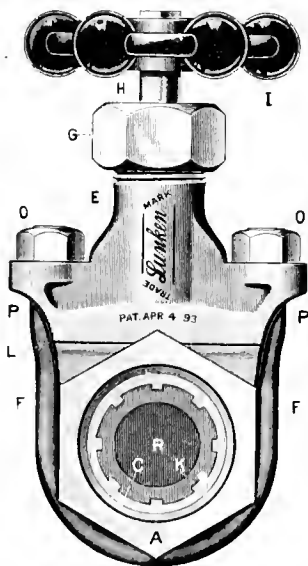

Fig. 5.

Figure 1 is a sectional view showing the valve closed. The disk R is held against the seat C by the wedge D. The seat C is easily renewable. The form of this seat is shown in Figure 2. The wrench for putting in and

removing the seat is furnished with a spanner at one end and a ring at the other. When a seat is to be put in it is placed on the ring end of the wrench and guided into the threads as shown in Figure 3, the turning being done by a knife or similar instrument. The spanner end is then used to screw the seat in tight. The seat is provided with lead packing. Figure 5 is an end view of the com-

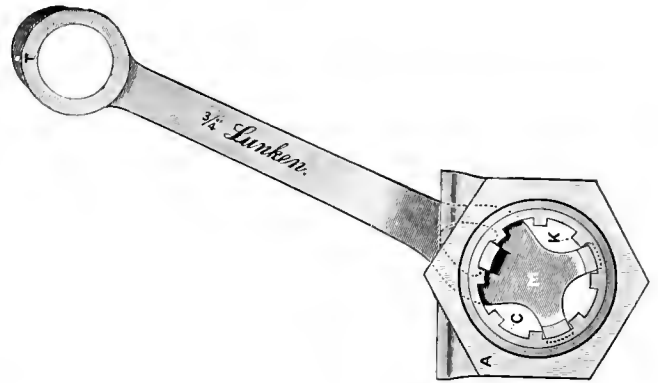

Fig. 6.

plete valve. Figure 6 shows the wrench as applied to the valve seat. The valve is perfectly balanced, almost a necessity with high pressures. The by-pass which is opened by the stem is shown in Figure 4. These valves weigh much less than globe valves of the same capacity and are to all appearances a very serviceable and economical type.

THE STREET CAR CODE.

NO less an authority than Figaro, the leading Parisian newspaper, has taken up the question of street car politeness. We may take Figaro's decision as final unless reversed by Ward McAllister.

Figaro was asked the following question thus stated: "Shall a gentleman, seated in an omnibus or street car, all the seats being occupied, give up his seat to a lady who may then appear?"

Figaro says, "In a public conveyance each one should occupy the place for which he has paid." This decision was arrived at from a canvass of the polite, one of which class says, "When a lady is content with a cheap mode of locomotion provided by such conveyance she accepts the conditions entailed. In most cases a woman is able to see whether or no all the seats are occupied. If there is no vacant seat and she enter she assumes the conditions of seatlessness."

To permit a gentlemen to disturb himself when a few minutes' wait would bring a car with plenty of room says Figaro, shows want of feeling. And nothing, continues this authority, is more out of place than a long drawnout refusal of a seat.

"A woman in a public conveyance should remain standing when there is no vacant seat, just as a man does in similar circumstances." The dictum has gone forth.

To give a seat to a sick or infirm person, or a woman carrying a child, is not politeness, that is charity.

Keep your seats gentleman.

LIGHTNING IN A CABLE PLANT.

ELECTRIC railway men will wonder why lightning should attack a cable plant. In fact it has been supposed that electric plants had a monopoly on that article. This idea has been disproved by an occurrence at the Twenty-first street cable plant of the Chicago City Railway. During the past month Chicago was visited by one of the most severe thunder storms known here for years. Lightning discharges at the rate of two or three a second could be seen from a favorable point of observation. About one o'clock in the morning, a few minutes before shutting down time, the men in the station felt a slight shock and the cable machinery slowed down for an instant. Where the lightning came from or where it went no one knew. The fact remained however that on one of the 500-horse-power engines, two keys in the crank rod, one at the crosshead end and one at the crank end were so loosened that the engine had to be immediately shut down. These keys were each held in place by two set screws. No other traces were found of the lightning's work. New keys were put in and the engine found to be all right. One of the men claimed that he was whirled around by the shock and was at the same time enveloped in a blue phosphorescent light. Another claims at the same moment to have seen the lightning strike a church steeple one block away. One of the men within three feet of the engine in question felt but a slight shock. At any rate the accident was a most peculiar one and strengthens the belief that what men do not know about lightning would fill a large library.

AUSTRALASIAN ELECTRIC LINES.

THE trolley triumphant has conquered Australia. Hobart, Tasmania, is the location of its latest fortification and here is installed one of the most complete power houses yet built south of the equator.

Our readers may now dust off their geographies and discover that Tasmania is a big island lying 150 miles south of the Australian mainland, and that Hobart, its metropolis, is a handsome little city of 50,000 inhabitants situated on the coast and nestling at the foot of the mountain.

It is a progressive place if it is in the antipodes, and nothing proves it more clearly than the electric railway that is now in commission there.

The power house is a complete affair. Marshall multi-tubular steel boilers are used, four in number, of 60-horse-power each, rated at 160 pounds steam pressure. The smoke stack is 90 feet high with a 5-foot flue. Two 100-horse-power Marshall feed water heaters and a Worthington pump are boiler accessories, and the boilers themselves are covered with asbestos.

The engine room is as complete, being equipped with Willan's patent central-valve high speed engines, compound, coupled direct to Siemens compound wound dynamos. The dynamos run at 350 revolutions per minute.

The overhead wire is of galvanized steel. The station equipment is complete of the Siemens type.

The cars were built by the Lancaster Wagon Company and will seat 48 passengers, 24 below and 24 outside. Two Siemens 15-horse-power motors are carried by each car. The cars are lighted by electricity.

Another dynamo is to be installed in the plant to furnish light for the Tasmania Exposition, which corresponds to a state fair here. The Honorable C. H. Grant and J. Syme are the local directory, and L. L. Murray the Australian representative of Siemens Brothers, installed the plant.

This line is but a forerunner of other lines in the colonies and a part of the future network of electric roads that the twentieth century will behold.

ANNUAL MEETING OF THE GREAT BRITAIN TRAMWAY INSTITUTE.

IN the opening remarks made by W. J. Carruthers Wain, it appears that although there was an increase in the number of passengers carried during the last year, there was a decrease in the net earnings of the Great Britain tramways. This was owing to the increased burdens put on the tramways by the local governments. The United States was cited as an example of what unrestricted tramways would work in the way of accommodation of the public and increase in mileage. He also stated only 33 miles of electric road have been built in England since 1883, against 3,532 miles since 1887 in the United States. Many English tramways were no more than paying expenses, and it was exceedingly difficult to induce capital to invest in such enterprises.

L. Epstein, of the Epstein Electric Accumulator Company, gave a report of the performance of the Epstein cells on the Birmingham Central Tramways. These cells have been doing duty since last December. There are six cars equipped and two sets of batteries for each car. In all there are 10,000 plates. Up to date it had not been necessary to repair a single plate. The Epstein Company maintains the batteries for a contract price of 1½d. (three cents) a car mile. The Battery Company have so far had the best of the contract. Mr. Epstein stated that he was willing to take a contract at 1d (two cents) a car mile.

The plates used are, according to samples now at the STREET RAILWAY REVIEW office, of thick lead, longitudinally grooved. The active material is formed on them. These plates are strong and furnish good electrical conductivity, while the longitudinal grooves afford a large surface for active material. The main objection, of course, is the weight.

The statements of Mr. Epstein were corroborated by Mr. Carruthers-Wain, the manager of the Birmingham lines. No figures were given as to the net income of the tramway itself as to whether it could afford to pay such a maintenance price per car mile, but the balance sheet of the company, soon to be published, will tell.

CINCINNATI LAND SLIDE.

JULY casualties include an unique accident at Cincinnati, which succeeded in stopping street cars and wrecking the track as successfully as a Parisian mob. On July 18 the banks of Brown street showed a wavering tendency and by the next day a complete abandonment of the street railway was forced. The loose dirt was so deep that piles could not be procured of sufficient length to reach the solid ground. Six houses were more or less moved. Our photograph was taken at the beginning of the trouble and does not show the most moving portion of the affair.

IMPALED ON A STREET CAR.

AN accident, as terrible as it was unusual, occurred on a Taylor street open car in this city. An inventor who had been placing a safety device at the ends of the Harrison street bridge, to prevent teams

the accident, and her friends being summoned received her last wishes. The surgeons then withdrew the splinter when death resulted in a few minutes from hemorrhage. Mellon the inventor is now in jail.

A REMARKABLE ENGINEERING FEAT.

FEW passengers on the Brooklyn elevated, traveling up and down Myrtle avenue, were aware that the track and structure beneath them was being lowered.

But such was the case. Between Navy street and the Vanderbilt avenue station was a heavy and expensive grade which seemed to defy remedy. Engineer-in-chief Nichols however began cogitating on the subject and at last resolved to lower the grade for 900 feet. This stretch included the grades which was 106 feet to the mile. It was begun June 2 and finished in six week, without stopping a single train. The plan of operation was this. The structure was first wedged with heavy wooden pil-



THE LAND-SLIDE IN CINCINNATI.

from falling into the river when the bridge was open, carelessly left a lever out of position, used as a part of his device. This wooden lever, several feet in length, fell at the instant when the car was passing, and the outer end dropped in such a way as to pass entirely through the body of one of the female passengers, and penetrated the back of several seats. It was found impossible to remove the patient except by sawing the lever as close to the body as possible. She was then hurried to the hospital in a police ambulance. Consciousness being restored the patient was informed of the fatal nature of

lars 15 inches square and as each one was riveted in place the iron columns along side of it were removed and four or five inches of it cut off. It was then replaced and the road bed lowered to it by means of hydraulic jacks.

Flagmen above kept their eyes on approaching trains and only when a train was a minute and a half or so distant would the hydraulic jacks lower the road bed into place. The work was necessarily slow and the undertaking rather a discouraging one, but has proved very successful.

LABOR IN SMALL POWER PLANTS.

IN no particular does the practice of roads differ more than in the relative number and efficiency of the men employed in the station. In the following article it is the intention to present briefly the actual working conditions of several moderate sized plants. The smaller the plant of course the more important the item of station attendance becomes in proportion to the total expense of operation. In the smallest plants it very often exceeds the coal bill.

In no department is there such temptation to practice false economy as there is in this. It is an easy matter to reduce the pay roll one half by hiring cheaper and fewer men. It is therefore but natural that the poverty stricken road should adopt this expedient but it is sure to bring disastrous results. It is a time honored saying among business men that the cheapest hands are the most expensive to keep. Cheap men will generally loaf enough of their time to make them less efficient in proportion to their wages than their better paid brethren, to say nothing of the carelessness and irresponsibility of the former. In regard to the quality of the help employed there should be no question. That a station is running on a small pay roll is no indication that it is operated cheaply. It may be running down constantly for the want of proper attendance. The saving is generally more than taken up by the repair account under such circumstances.

The figures herewith presented have been compiled in their present form for an approximate comparison of results. It is of course difficult to obtain exact figures on this kind of work and as far as actual value for comparison goes this makes little difference. The item headed "number of cars running" in the majority of the cases is the number in operation from the time of starting till the hour of shutting down. The reason for this is that the roads being small, it is necessary to run the cars at definite intervals, and this, together with the fact that the traffic is tolerably constant, makes a material changing of the number of cars on the road from hour to hour impracticable. In some cases here given the number of cars during the day undergoes some change, but it is not likely that this seriously effects the problem.

No. 1 is the smallest road on the list and will be considered first. It is not valuable for comparison because it is a combination lighting, railway, and heating plant and it is impossible to separate the expense.

The showing is as follows:

ROAD NUMBER 1.

Number of cars running.....	7
Rated horse-power of machinery running.....	250
Firemen day shift.....	2
Firemen night shift.....	2
Engineer day shift.....	1
Engineer night shift.....	1
Total number men employed in station.....	6
Average load.....	100-horse-power.
Horse-power hours.....	1,500
Horse-power hours per day per man.....	300
Cars per man.....	1.16

It is safe to say that four out of six men at work around this station could easily do the work for the railway part alone. The machinery ordinarily run is a high speed engine direct belted to a 200 kilowatt generator.

The next plant although small is of excellent design and is kept in the best of condition. The road is usually supplied with power from a 300-horse-power Corliss belted direct to a 200 kilowatt generator.

ROAD NUMBER 2.

Number of cars running.....	10
Rated horse-power of machinery running.....	300
Day fireman.....	1
Night fireman.....	1
Day engineer.....	1
Night engineer.....	1
Total number of men employed in station.....	4
Average load.....	120-horse-power
Horse-power hours.....	2,160
Horse-power hours per day per man.....	540
Cars per man.....	2.50

We now come to a size of station where the wages of the head engineer should be counted in as a part of the station expense although he is not in actual duty in the engine room. In the two already taken up the head engineer was on duty either on the day or night shift. In those to follow, the head engineer is not counted among the regular help, as shown in the table.

ROAD NUMBER 3.

Number of cars running.....	18
Rated horse-power of machinery running.....	600
Day firemen.....	2
Night firemen.....	2
Day engineer (and helper).....	2
Night engineer.....	1
Total number of men employed in station.....	7
Average load.....	250-horse-power
Horse-power hours.....	4,500
Horse-power hours per day per man.....	643
Cars per man.....	2.59

The engine is a 600 horse-power Corliss direct belted. It is thought that the station force could be somewhat cut down without difficulty, as until recently the engines used were of a type requiring more attention and more fuel than the present machine.

ROAD NUMBER 4.

Number of cars running.....	30
Rated horse-power of machinery running.....	500
Day firemen.....	4
Night firemen.....	4
Oiler, day.....	1
Oiler, night.....	1
Engineer, night.....	1
Engineer, day.....	1
Total number of men employed in station.....	12
Average load.....	300-horse-power
Horse-power hours.....	5,400
Horse-power hours per day per man.....	450
Cars per man.....	2.50

Machines in this case are 75 kilowatt run from line shaft by a 500 horse-power Corliss.

ROAD NUMBER 5.

Number of cars running.....	40
Horse power of machinery running.....	600
Day firemen.....	3

Night firemen.....	2
Day engineer and dynamo men.....	3
Night engineers and dynamo men.....	2
Total number of men employed in station.....	10
Average horse-power.....	100
Horse-power hours.....	7,200
Horse power hours per day per man.....	720
Cars per man.....	4

ROAD NUMBER 6.

Number of cars running.....	45
Men day shift.....	10
Men night shift.....	6
Total number of men employed around the station.....	16
Average horse-power.....	540
Horse-power hours per day.....	9,720
Horse-power hours per day per man.....	607
Cars per man.....	2.81

Number 5 is a new station operating direct belted 300-horse-power Corliss engines. The firing is done by hand. Number 6 is composed of a large number of small high speed engines of about 125 horse power. Mechanical stokers are used with upright boilers. The best showing is that made by Number 2, when the smallness of the plant is considered. The fact that the chief engineer's salary does not have to be figured in as a separate item brings the cost of labor to a figure that will compare favorably with much larger plants.

Number 5 and 6 can be best compared and such comparison is not without its lessons. Number 5 is operating only five less cars than Number 6, yet the station force is more than one third less. There is evidently a chance here for a comparative study of station design. Number 6 is as was before stated a station of small units. Each one of the units takes but slightly less attention than the large units of which number 5 is composed. This is saying nothing of the increased fuel economy of the large units which in turn acts to noticeably lessen the labors of the coal heaving department. There are however, other considerations that go to increase the pay roll of Number 6. The coal instead of being shoveled out of the cars directly in front of the boilers, has to be wheeled some distance. It would do a great many designing and constructing engineers good to take a short course in coal heaving in some badly arranged boiler rooms. It would bring to their minds as nothing else could (unless it is footing the bills for firemen's helpers) the importance of providing for the quick and easy handling of coal and ashes. It may be argued that coal heavers are cheap but as a fact the small amount of coal the average cheap laborer will handle in a day is something remarkable. Much has been said about power station design from an electrical and mechanical engineers' standpoint, but the man who does the actual work around a station knows that the difference between a large and a small station force for the same output lies mainly in the details of boiler and engine room.

Above all things it is important that the men in charge of a station should be "able to scent trouble a mile off." The man who does not have the inborn intuition, that an ounce of prevention is worth a pound of cure, has no place around a power plant. The only way to avoid shut-downs and break-downs is to remedy every little

trouble at its beginning. For this reason there are some men that are specially unsuited to station work however much ability they may have in other directions. "Eternal vigilance" and the faculty of seeing that repairs are made the minute they are needed are the requisite qualities of a good station attendant.

The number of cars run per man in the station is perhaps as reliable a basis of comparison as any. With a power plant of up to date design there should be no reason why three 16 foot cars could not be run per man in the station for plants running from 10 to 20 cars.

The reason that so few of the plants from which figures are here given make as good a showing as this is due to a variety of reasons. Number 2 would no doubt do it for some of its cars are long double truck interurbans. The other stations are not of modern design so that although operating a large number of cars the station pay roll is large. The number of men necessary to run a station is extremely dependent on the designer of the plant, be it large or small.

EFFECT OF DRIVING SPIKES IN WOODEN TIES.

NOT only are there spikes and spikes, but even more frequently are there men who know little of the art of driving them. The Engineering News publishes the following illustrations from photographs furnished by a correspondent on the A. T. & S.

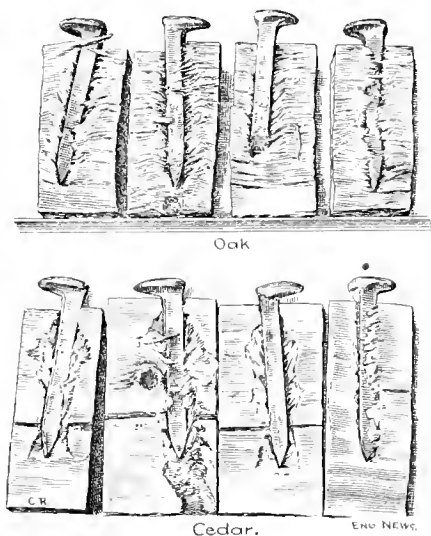

F. Railroad, in Kansas, showing the effects of spikes driven into oak ties and cedar ties.

After the spikes were driven the ties were sawed into small blocks inclosing the spikes, and these blocks were subsequently split open at the spike holes.

A WRITER in Indian Engineering says that for roofs of moderate span old rails can not be beaten, but intimates that old rails may be very expensive items if one does not know how to use them.

THE PIKES PEAK COG RAILROAD.

THE Manitou & Pikes Peak Railway, ascending the highest accessible mountain in the world, has been in operation since June 30, 1891. The moving spirit in its construction was Z. G. Simmons, of Kenosha, Wis., who has earned a considerable reputation for his large undertakings in the northwest. He went to Colorado primarily for his health, but the temptation to build the much talked of line, and bring Pikes Peak summit within easy reach of the ordinary traveler, was too great to be resisted. Mr. Simmons gave not only his capital, but his personal supervision to the enterprise. The Abt system of cog wheel road, which has been in use in the Old World, was the one decided on. Surveys were made in

back up the Engleman Canon trail. The hardships of construction were great. The light atmosphere made work difficult, and it is estimated that the cost of labor averaged \$1.00 an hour. The road is a trifle under nine miles in length, and the rise amounts to a perpendicular distance of a mile and a half, or about 850 feet to the mile. The maximum grade is 25 per cent, or one foot in four. About one-quarter of the distance has this grade, the average being 16 per cent. At distances varying from 100 to 600 feet, anchors of strap iron are bolted to the ties and carried up grade to fastenings in solid masonry. The Abt system of cogs in use here has two cogged rails in the center of the road. Six driving wheels from the locomotive mesh in these—three on each rail. Cog rails are 21 to 31 pound, and 80 inches



VIEW OF CANYON.

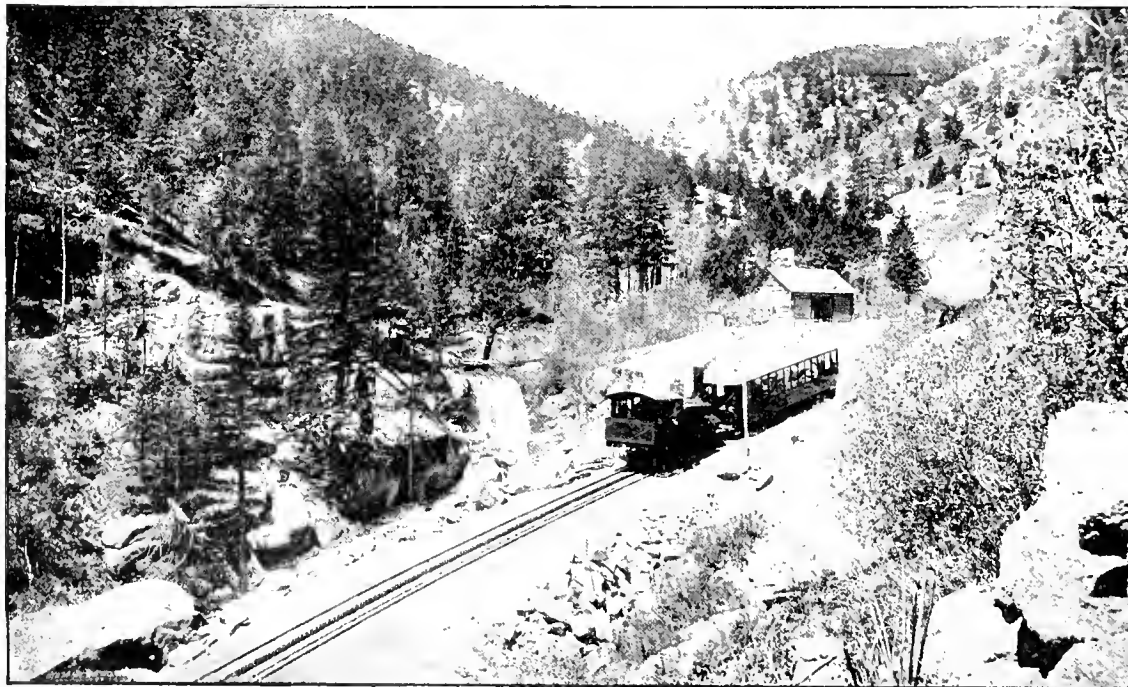

HALF-WAY HOUSE—MANITOU & PIKES PEAK RAILWAY.

1888 and '89, and the grading was begun in September, '89, by the contractors, Lantry Brothers, of Strong City, Kansas. All materials and supplies were sent on burro

long. The locomotives weigh 25 tons. On an average grade the boilers are nearly level. Track was laid from the bottom up. The track rails are 40-pound T, and the

standard gauge is used. The roadbed is of gravel, 15 feet wide. The single car which is used with each locomotive is provided with separate brakes, in case those on the locomotive give out. Three Vauclain compound engines have supplanted the simple ones in use at first. The number of passengers carried the first season was 9,700, and the second season 16,700. During last August the demand for tickets was far in advance of the capacity of the road, and while additional facilities have been provided this year, the indications are they will be none too large. The officers are: President, John Hulbert; vice-president and treasurer, Z. G. Simmons; secretary, J. B. Glasser; general manager, H. S. Cable.

Occasionally some daring individual makes the descent on an improvised tobogan, the best record to date being sixteen minutes for the nine miles. Within the past week three men attempted the foolhardy undertaking of breaking the record and were pitched down the mountain. The trip in the cars, however, is one of absolute safety.



SUMMIT OF PIKES PEAK—ELEVATION 14,147 FEET.

PAPERS SAID THE PEOPLE DIDN'T WANT THE TROLLEY.

IN vivid recollection we call to mind the daily wail for months of the New York papers that the citizens of Brooklyn did not want the trolley. Judging from the press, nothing short of a great popular uprising of the people was imminent should electric cars be put in. That was a few months ago. As an evidence of how the people did not want the trolley, the elevated roads in Brooklyn are in desperation, and one, the Kings county L, has even petitioned for a reduction of its assessment on account of a loss of 5,000 passengers daily, which it asserts now ride on the electric cars. The Brooklyn Elevated also claims a loss of 7 per cent of business on Fifth avenue and 8 per cent on Lexington from the same cause. The L people now talk of adopting electricity for themselves. It does beat all how the people hate the trolley!

ALUMINIUM SILVER.

THE above is the name given to a remarkable alloy, which has been developed as a result of nearly twenty years' of experiment by one of the leading metallurgists in the United States, a gentleman who has long held a very high position in the service of the Government. The name has been chosen as indicative of the characteristic properties of the alloy, and not because aluminium and silver form essential constituents. In color, lustre, hardness, specific gravity and resistance to oxidation and discoloration, it closely resembles and possesses the properties of these metals.

One of the alloys was rolled into a plate and submerged on a ship during a cruise in the Pacific. It was free from barnacles or corrosion after several months, and had no galvanic action upon iron. The tests indicated greater durability than copper, at half the cost. In other tests, of which we have positive knowledge, most remarkable

results have been obtained from its use as an anti-friction metal, running for hours without any but the first few drops of oil and coming out smooth, clean and without heating. The metal can be hammered and rolled, and when poured does not contract in cooling.

By thoroughly cleansing the surface of sheet-iron by a bath of dilute acid, then removing the acid, immersing the plate in a certain saline solution, and then in a bath of melted alloy, the surface becomes coated with a material fully equal to tin for all uses to which tinned iron is applied and at a considerable reduction of cost. Gen. Herman Haupt, C. E., has conducted a series of very severe tests and pronounces the new metal in many respects the most remarkable and valuable alloy ever discovered, and one specially suited to many purposes in electric work.

ONLY two months until convention. Make your plans early and carry them out.

PICTORIAL EVENTS OF THE MONTH.

THE Chicago & Indiana Electric Railway is the title of a new enterprise, which claims to have let contracts for 500 miles of iron, and promises to construct a line between Chicago and Indianapolis, with branches as shown in the accompanying map. Shops for the manufacture of their cars are slated for Noblesville. High speed passenger service for day, and freight at night, is the plan, the Chicago line to be double, the others single track.



In 1874 bobtail cars were introduced on the horse lines in San Francisco, and were not entirely withdrawn until last month. The first horse cars were put on July 3, 1869, and to popularize the line run free all day on July 4. In 1874 they were changed to bobs, which gradually gave way to the cables, until now the last has passed from sight, though dear to the hearts of some of the old timers.



CABLE and electric cars have not infrequently given the police and fire departments a timely lift, but general attention was recently attracted to a Brooklyn horse car, which chased a thief. A passenger on the front platform was suddenly relieved of his gold watch, the thief jumping off and running ahead of the car. The driver put on his spurs and put the old horses on a double quick. After a chase of several blocks a policeman hove in sight and joined in the pursuit, which resulted in arrest of the robber and recovery of the ticker.



On the Lake Roland Electric, in Baltimore, the trolley on one of the late cars caught in the wire and was broken off. Lineman Scott was equal to the occasion, and procuring a piece of insulated wire, connected one end through the car roof, and standing on the car, held the other against the trolley wire. There was considerable illumination, but the car was brought in all right.



THE annual crop of tin can eating goats in New York City is placed at over 50,000. One old patriarch, rejoicing in the name of Stonewall Jackson, never knew defeat, that is, until he bucked the electric car on the DeKalb avenue line. For years his amusement had

been to plant himself firmly in the horse car track, raise particular Cain with the horses, and compel the drivers to get off and rout the enemy with a whip. But one day a

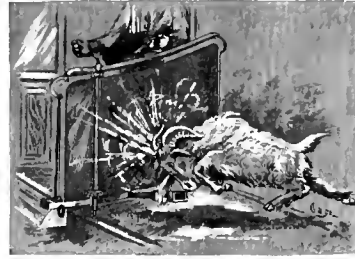

car appeared minus the horses. Stonewall struck his regulation attitude and then something with a fearful gong and flames of blue fire hit back. One horn was sprained, his whiskers caught in the drawbar and were extracted, and one eye will have to do the work of two hereafter. It was a complete Waterloo, and the former terror of East New York is now as docile as a clam.

THERE was a fierce canine which lived on Clark street in the World's Fair city, and rejoiced in the name of the "North Side Terror." Tige was a fighter from Goose Island, and his owner had realized large money in many a hard fought pit, where the other dog was regularly devoured by Tige. On this day Tige slipped away from his master and took a voyage of discovery on his own account. The slot of the cable road attracted him. The hum of the fast moving cable was a declaration of war, and he tried to chew a section of slot rail. Just then the rope around his neck in some way dropped through and caught the cable. Tige's head was well fastened to his body, or that first jerk would have severed all communication between the two. Down the street he went, now sliding on his feet until they were blistered, now dodging the missiles with which the boys got in their unerring work of revenge. Fully a half mile was covered, the fat Dutch owner bringing up in the far distance, when the cable reached the curve, and the rope parted just in time to give that dog one more chance for life. He travels in the alley now.



JULY 3 was a big day in Kalamazoo; bigger even than the Old Settlers' annual picnic, or the day when the man fell out of a balloon. The electric line was finished. The mayor rode at the front end of the procession, next behind the band, and everybody else that could get in afterwards. They filled the cars; then they swarmed around and on top like bees, and rode as long as they could hold on. All the country 'round about for miles was there, and fireworks in the evening rounded up the big event.



CAUGHT ON THE RUSH TRIP.

American Street Railway Association.

D. F. LONGSTREET, PRESIDENT, Denver, Col.
 DR. A. EVERETT, FIRST VICE-PRESIDENT, Cleveland, O.
 JOEL HURT, SECOND VICE-PRESIDENT, Atlanta, Ga.
 W. WORTH BEAN, THIRD VICE-PRESIDENT, St. Joseph, Mich.
 WM. J. RICHARDSON, SECRETARY AND TREASURER, Brooklyn, N. Y.
 EXECUTIVE COMMITTEE—THE PRESIDENT, VICE-PRESIDENTS, AND JOHN G. HOLMES, PITTSBURG, Pa.; J. D. CRUMMINS, New York City; THOS. MINARY, LONISVILLE, Ky.; JAS. R. CHAPMAN, GRAND RAPIDS, Mich., and BENJ. E. CHARLTON, Hamilton, Ont.
 Next meeting, Exposition Building, Milwaukee, third Wednesday in October.

Massachusetts Street Railway Association.

President, CHARLES B. PRATT, Salem; Vice-presidents, H. M. WHITNEY, Boston, AMOS F. BREED, Lynn, FRANK S. STEVENS; Secretary and Treasurer, J. H. EATON, Lawrence.
 Meets first Wednesday of each month.

Ohio State Tramway Association.

President A. E. LANG, Toledo; Vice-president, W. J. KELLY, Columbus; Secretary and Treasurer, J. B. HANNA, Cleveland; Chairman Executive Committee, W. A. LYNCH, Canton, O.
 Meets at Cincinnati on the fourth Wednesday in September, 1893.

The Street Railway Association of the State of New Jersey.

President, JOHN H. BONN, Hoboken; Vice-president, THOS. C. BARR, Newark, Secretary and Treasurer, CHARLES Y. BAMFORD, Trenton; Executive Committee, OFFICERS and C. B. THURSTON, Jersey City; H. ROMAINE, Paterson; LEWIS PERBINE, JR., Trenton.

The Street Railway Association of the State of New York.

C. DENSMORE WYMAN, PRESIDENT, New York.
 D. B. HASBROUCK, FIRST VICE-PRESIDENT, New York.
 JAS. A. POWERS, SECOND VICE-PRESIDENT, Glen Falls.
 W. J. RICHARDSON, SECRETARY AND TREASURER, Brooklyn.
 EXECUTIVE COMMITTEE.—D. F. LEWIS, Brooklyn; JOHN N. BECKLEY, Rochester, J. W. McNAMARA, Albany.
 The next meeting will be held at Rochester, September 19, 1893.

Pennsylvania Street Railway Association.

JOHN A. COYLE, PRESIDENT, Lancaster.
 JOHN G. HOLMES, VICE PRESIDENT, Pittsburg.
 H. R. RHODES, SECOND VICE-PRESIDENT, Williamsport.
 L. B. BEIFSNEIDER, SECRETARY, Altoona.
 WM. H. LANIONS, TREASURER, York.
 Next meeting, Harrisburg, September 8, 1893.

Alabama.

MOBILE, ALA.—The Electric Railway will begin operations Aug. 10.

MOBILE, ALA.—Mobile & Spring Hill Electric Railway has begun operation by electricity. J. H. Bleon is general manager.

MONTGOMERY, ALA.—Montgomery Light & Power Company is to furnish power at present for the Terminal & Cloverdale Street Railway.

MONTGOMERY, ALA.—The Cloverdale and the Montgomery Terminal consolidate and increased combined capital to \$350,000. Electricity will be put on immediately.

Arizona.

TUCSON, ARIZ.—Organized: The Tucson Water, Electric Light & Power Company, by Sylvester Watts, St. Louis; Henry A. Lawton, Terry Parker, Stanton Park, and Jas. W. Parker, of Atchison, Kan., at a capital of \$50,000.

Arkansas.

FORT SMITH, ARK.—Six miles of electric railway is to be put in here on or before June 5, 1894. At present eight and one-half miles of horse line are in operation. S. McLoud is purchasing agent and general manager.

California.

SAN FRANCISCO, CAL.—California Street Cable Company elects J. B. Stetson, president; Antoine Borel, vice; Albert Stetson, secretary.

OAKLAND, CAL.—Oakland Consolidated Street Railway Company elects A. H. Clough and W. H. Chickering as directors. These represent the F. M. Smith interests.

SAN FRANCISCO, CAL.—Metropolitan Railway Company has received a decision in franchise case declaring that franchise can not be granted, but may be auctioned off to highest bidder.

OAKLAND, CAL.—The Twelfth Street Electric begins operations. David Rutherford, formerly of the Consolidated, is superintendent, and F. M. Smith is controlling owner of the new line.

SAN FRANCISCO.—A large amount of construction will be made by the Mission Street, Market Street, Omnibus, and Southern Pacific Companies, to reach the grounds of the Midwinter Fair.

SAN FRANCISCO, CAL.—Pacific Underground Electric Railway Company organized at \$100,000, by F. S. Chadbourne, John F. Burgin, A. Craig and D. B. Richards, of San Francisco, as directors.

SAN FRANCISCO, CAL.—F. M. Smith, the "borax king," has finally secured all the street railway interests in Oakland. He will now build to Piedmont. The syndicate has control of 35 miles now.

LOS ANGELES, CAL.—C. W. Stewart has on foot a scheme for a boulevard and electric railway to Santa Monica. Right of way is secured, and claims are made that capital from the east is behind the scheme.

SAN FRANCISCO, CAL.—There is a prospect of a fight to the knife between the Southern Pacific with the Davie people. The trouble will be inaugurated with cut rates. The Oakland Consolidated is in the deal with Davie.

SAN JOSE, CAL.—The Chappellet franchises are in possession of Le Roy G. Harvey & Company, who ask that immediate action be taken to extend time limit of building. Harvey & Company claims are of assignee, but the franchises in question have lapsed.

NEVADA CITY, CAL.—F. Broeckman, Peter Tautphaus, J. Guttenbach, Dr. Liel rick, et al., who will build the Nevada City, Grass Valley & Marysville road, are making preliminary arrangements to begin active business. The Yuba county supervisors have been asked for a charter.

SAN FRANCISCO, CAL.—The San Francisco & San Mateo are sued by Griffin Wheel & Foundry Company for \$336.00 for goods sold. The sheriff has taken control of the road on writ of replevin of the General Electric for \$100,000 debt. Things are now ready to come to a head. Bad management is alleged.

OAKLAND, CAL.—W. F. Rudolph, F. M. Smith's lieutenant, says that the proposed feeder to Emeryville cannot be built this season on account of the stringency in the money market. The Twelfth street line announces Warren Olney, president, and Warren Olney, Jr., secretary. The Southern Pacific has bought the control of the Sessions' Street Railway, in Oakland, for \$240,000. Lines aggregate 7½ miles.

LOS ANGELES, CAL.—Judge Van Dyke rules on the cable case that holders of the first mortgage bonds amounting to \$1,324,355 come first; the Illinois Trust and Savings Bank, second, as holders of \$1,360,000, second issue of mortgage bonds; and parties claiming small judgments last. Frank J. Thomas is appointed commissioner to make sale within thirty days. In case sale fails to realize sufficient amount balance holds first against the Los Angeles Cable Railway, and any balance due on second mortgage enters against the Pacific Railway Company. As the Consolidated Electric of this city controls the first mortgage bonds the property will almost certainly pass into its possession.

Canada

VANCOUVER, B. C.—City council discusses question of purchasing Street Railway & Light plant for \$360,000. Committees of stockholders and aldermen appointed to confer in the matter. A vigorous spirit of municipalization is aroused.

MONTREAL, CAN.—City council gives the street railway rights of extension of their lines.

LONDON, ONT.—Col. J. M. Clark, formerly of the Windsor & Amherstbury Street Railway, asks franchise of the London city council.

Chicago.

CHICAGO.—Incorporated: Gough's Automatic Street Car and Station Indicator, at \$500,000, by Carroll Gough, Neville Begley and Parker Gough.

CHICAGO.—The West & South Towns Street Railway Company changes the name to the General Street Railway Company of Chicago and say they will use five Patton motors.

Colorado.

DENVER, COL.—City cable is about to begin construction of new line along Thirty-eight and Watervliet avenue. Surveyors are now at work.

BOULDER, COL.—The street railway here will probably be used for freight service, and the Union Pacific line into the mountains will be operated as an electric line.

DENVER, COL.—General Electric brought attachment suit against Denver Lakewood & Golden Railway for \$5,705. Case afterwards settled and attachment released.

PUEBLO, COL.—On petition of the General Electric Company, E. B. Shattuck, of Pueblo, is appointed receiver for the Pueblo City Street Railway Company and the International Trust Company, also party to the action. Liabilities are \$700,000. General Electric holds \$500,000 in bonds.

DENVER, COL.—Denver Tramways Company and the Metropolitan have combined their systems with a capitalization of \$4,000,000. The Tramways' bonded indebtedness is \$2,600,000, and \$500,000 will be issued. Considerable changes in motive power will be made, and the other lines will be drawn into the combine shortly. The annual Tramway & Metropolitan election resulted as follows: President, Rodney Curtis; vice-president, John J. Reithman; secretary, W. G. Evans; treasurer, F. A. Keener.

Connecticut.

BRIDGEPORT, CONN.—The Bridgeport Railway Company, the Bridgeport Horse Railroad Company, and the East End Railroad Company have consolidated under the name of the Bridgeport Traction Company. The capital stock of the new corporation is \$2,000,000, and the roads are soon to be operated by electricity.

BRIDGEPORT, CONN.—Bridgeport Railway Company (consolidated) elects president, Colonel N. H. Hett, of the Standard Oil Company, who is a resident of this city; vice-president, Elias S. Ward, Newark; secretary, General T. L. Watson, Bridgeport; treasurer, William Sherer, Newark. Capital stock, \$2,000,000; to be operated by electricity.

Delaware.

WILMINGTON, DEL.—As a result of the annual meeting of the Wilmington City Railway, additions will be made to the power plant and several cars bought.

District of Columbia.

WASHINGTON, D. C.—Representative Hicks, of Altoona, applies to Postoffice department for placing postal boxes on electric cars of new line from Altoona to Hollidaysburg. Favorably considered.

Georgia.

COLUMBUS, GA.—North Highlands Electric secures its franchise. Work must commence in six months and be completed in twenty-four months or road is forfeited to city.

ATLANTA, GA.—New offices of Atlanta Traction Company are: Thos. B. Felder, president; W. H. Norris, secretary; Judge Rosser, Judge Hines, E. T. Shubrick and W. Rosser, directors.

Illinois.

CENTRALIA, ILL.—Centralia Street Railway Company has ordered cars for the street railway.

OTTAWA, ILL.—Arthur Whittington, electrician for the City Electric Railway, resigns, and is succeeded by Mr. Chapman, of Peoria.

TRENTON, ILL.—City of Trenton will give free franchise, and consider proposals for electric light plant. City will use twenty-three arc lights or more.

GALESBURG, ILL.—The Street Railway Company elect officers as follows: President, Wilkins Seacord; vice-president and treasurer, Robt. Chappell; secretary, H. F. Arnold.

CENTRALIA, ILL.—Organized: The Centralia Light & Power Company, for a general electric business, by E. S. Condit, Jacob Kohl, Geo. L. Pittinger, C. C. Davis, G. E. Eis, Seymour Andrews, James Benson, F. Kohl, and S. M. Warner.

Indiana.

PORTLAND, IND.—Electric line from Pennville to Marion is talked of.

INDIANAPOLIS, IND.—St. Louis Car Company gets contract for twenty-five closed cars, to be delivered by Oct. 1.

HUNTINGTON, IND.—W. H. Thompson, of Lima, O., is in the city looking up the location and route of his street railway planned here. He has asked nothing so far.

MARION, IND.—The Marion, Montpelier & Camden Electric Railway promoters discuss the road. James Brownlee, of Marion, chairman; L. R. Knight, of Montpelier, secretary.

TERRE HAUTE, IND.—Terre Haute Car & Manufacturing Company assign to H. J. Baker, the attorney for the company. Liabilities, \$191,000; assets, \$600,000. Liabilities wholly for material.

MUNCIE, IND.—The Burlington, Vt., directors of the Muncie Street Railway Company elect officers and decided to put in an electrical equipment. Russell Harrison's syndicate deal to buy the line was declared off.

INDIANAPOLIS, IND.—The Chicago & Central Indiana Electric Railway Company asks the commissioners of Marion county the privilege of running their tracks along highways of said county to Broad Ripple and thence to city limits.

INDIANAPOLIS, IND.—The Citizens' Company hold a meeting with J. E. Riddell, engineer, of Pittsburg. Contracts signed with new Electric Light Company for rented power. The Buffalo safety fender was adopted. Several other minor contracts made.

TERRE HAUTE, IND.—Creditors of the Terre Haute Car Works favor its management by the old officers of the company. The creditors choose A. J. Crawford, president of the Northern & Southern Rolling Mills, Major Collins, of Brazil, and J. F. Brinkman as trustees.

Iowa.

SIoux CITY, IA.—National Park Bank, of New York, begins suit against Sioux City Street Railway Company for \$42,000, to establish validity of a claim against defendant which is now in receiver's hands.

MUSCATINE, IA.—Muscatine electric Railway Company elects officers as follows: President, Geo. W. SeEVERS; secretary and treasurer, H. W. SeEVERS. Board of directors, G. W. SeEVERS, H. W. SeEVERS, P. B. SeEVERS, C. E. Lofland, W. P. Hawkins, all of Oskaloosa, Ia.

DES MOINES, IA.—The Des Moines Street Railway companies have formally united as the Des Moines City Railway Company. The officers are as follows: J. S. Polk, president; G. M. Hippee, vice-president; E. M. Hunter, treasurer; G. H. Huttonocker, secretary; G. B. Hippee, general manager. The capital stock of the new company is \$3,000,000.

Kansas.

TOPEKA, KAN.—Edison electric light plant damaged to extent of \$12,000 by fire. Dynamos lost.

LEAVENWORTH, KAN.—It is possible that Elias Summerfield may be appointed receiver of the Putnam lines. M. Summerfield, of Lawrence, attorney for the Memphis people, asks that a receiver be appointed.

Kentucky.

FRANKFORT, KY.—The Capital Street Railway Company will extend their lines.

LOUISVILLE, KY.—Phil Helfrich has been appointed manager of the Highlands Electric road, of New Albany.

Louisiana.

SHREVEPORT, LA.—The Shreveport Electric Railway, Land & Improvement Company has been seized on judgment for \$1,600. It is thought the complications can be arranged.

Massachusetts.

LOWELL, MASS.—Hereafter the Lowell & Suburban Company will do its own lighting. A new safety fender is on trial.

PROVINCETOWN, MASS.—Authority granted Isaac N. Fellows, of Natick, to build electric line along highways of the town.

LOWELL, MASS.—Gardner P. Wells, of the General Electric Company, assumes duties as superintendent of the Lowell & Suburban, Vice Philip Begley, resigned.

HYDE PARK, MASS.—The Suburban Street Railway has bought large part of Ballard estate, and will erect shops and barns. All contract will be closed soon. Power will be rented temporarily.

MALDEN, MASS.—J. E. Sewall, superintendent of the Lynn & Boston Railway, and General Manager E. C. Foster, of the East Middlesex road, meet to discuss equipment of the road with electricity. Resolved to put on electric cars within four months.

Maryland.

BALTIMORE, MD.—The Southern Electric Company voluntarily assigned, July 23. J. Frank Morton is president. Assets estimated at \$160,000, and liabilities at \$100,000. Company protects all creditors by deed of trust to M. N. Packard for \$300,000.

FREDERICK, MD.—Hughes & Rigby, of Baltimore, agents for Siemens & Halske, have gained part of contract for equipment of the Frederick-Middletown Electric Railway. Sprague, Duncan & Hutchinson, of Baltimore, are the engineers. Work to be pushed at once.

CUMBERLAND, MD.—The Cumberland Electric Railway elects J. G. B. Roberts additional to the board of directors and the following officers: Geo. L. Wellington, president; Lloyd Lowndes, vice-president; J. H. Holzshu, secretary and treasurer, and W. Wilner Roberts, Jr., superintendent and manager.

BALTIMORE, MD.—Active electric railroading is on the boom in Maryland. The Baltimore, Middle River & Sparrows' Point Railroad Company has been incorporated at \$400,000, by B. Gatch, Levin F. Morris, Frank W. Trimple, John J. Forrester, Jas. Sloan Hoskins, and George R. Willis. The company has asked permission of the county commissioners to lay the tracks over several important suburban and city-limit routes.

Michigan.

SAGINAW, MICH.—Employees arrange as branch of Brotherhood of Street Railway Employees, with sixty-nine members. J. Kline, president.

DETROIT, MICH.—Street railway employees elect A. Dill, of the Fort Wayne & Belle Isle, president, and D. Dilworth traveling delegate. M. G. Moore is secretary.

MT. CLEMENS, MICH.—Reilley, Huebner & Erskine have secured a franchise for a line from Mt. Clemens to Detroit on the Gratiot road. The conditions are very stringent.

DETROIT, MICH.—Citizens' Street Railway Company makes offer: Rapid transit, workmen's tickets, transfers, and five-cent fares; city may purchase at six months' notice; controller may have access to books; surplus profit to go into a sinking fund.

Minnesota.

DULUTH, MINN.—City council instructs city attorney to attack franchises of Duluth Street Railway Company to compel issuance of transfers.

STILLWATER, MINN.—J. C. Nethaway, attorney for Allen Curtis, files complaint to foreclose mortgage on Stillwater Street Railway. Mortgage is for \$60,000.

ST. PAUL, MINN.—Assemblyman Reardon introduced order to compel the Street Railway Company to put in a line to Wacouta street. The council will probably not try to compel the company to extend its loops.

STILLWATER, MINN.—W. C. Masterman is appointed receiver of the Stillwater Street Railway Company. Supt. Howitt was appointed receiver a year ago, and now Masterman joins him for the St. Louis Car Company interests. Citizens think the line will soon come under the hammer.

Missouri.

ST. LOUIS, MO.—T. C. White & Company, electric specialty dealers, fail.

ST. LOUIS, MO.—The Northern Central has begun operation by electricity.

ST. LOUIS, MO.—The formal combination of the Union Depot, the Mound City, and the Benton-Bellefontaine lines is made. It represents \$4,000,000 stock.

ST. LOUIS, MO.—The Edison Illuminating Company increases capital stock from \$350,000 to \$4,000,000, with assets at \$1,000,000 and liabilities at \$900,000.

KANSAS CITY, MO.—West Side Street Railway Company is negotiating the purchase of the Amourdale Electric with the Kansas City L. The line will extend to the stock yards.

ST. JOSEPH, MO.—Deed filed conveying Peoples' Street Railway from Master in Chancery to St. Joseph Traction & Lighting Company. New company will issue \$1,100,000, in 5 per cent gold ten-year bonds, and placed mortgage with the Central Trust Company, of New York, to that effect.

ST. LOUIS, MO.—The St. Louis & Kirkwood Electric Railway applies for charter. Capital, \$100,000; directors, Dr. John Pittman, Geo. D. Edwards and Geo. W. Taussig, of Kirkwood; Jeremiah Fruin, of St. Louis, and J. D. Housman, Sr., of Windsor Springs. The company will operate a line from Forest Park to Meramec Highlands. A city connection is said to be already made.

Mississippi.

MERIDIAN, MISS.—Edison Electric Light & Power Company has charter extended to cover operation of electric railway line.

MERIDIAN, MISS.—A deal is nearly complete to consolidate the Electric Light & Power Company and the Meridian Railway Company.

Montana.

HELENA, MONT.—Attachment on Helena Electric Railway has been released by the Cruse Bank, as the \$20,000 note has been paid.

New Jersey.

NEWARK, N. J.—The ordinances giving franchises to the Consolidated Traction Company have been passed over the veto of the mayor.

NEWARK, N. J.—Ten routes have been voted to the Consolidated Traction Company. A protest by citizens was unheeded by the board of works.

NEWARK, N. J.—Suburban Traction Company files mortgage for \$1,500,000 to American Trust Company, securing issue of 5 per cent thirty-year bonds; \$80,000 to be put on market immediately.

JERSEY CITY, N. J.—Steven B. Dod, president of the North Hudson County Railway Company, resigns, and Miles Tierney, of New York, is elected his successor. Failing health is Mr. Dod's reason for resigning.

JERSEY CITY, N. J.—Chas. B. Thurston offered his resignation as president of the Jersey City & Bergen and the Newark Plank Road companies, which was not accepted. David Young was elected vice-president.

CAMDEN, N. J.—Camden Horse Railway Company gains victory over West Jersey Traction Company, Vice-chancellor Pitney refusing to grant injunction against former corporation against laying track on certain streets in Camden.

TRENTON, N. J.—Judge Green dismisses injunction suit of the Newark Accumulator Company against the Consolidated Storage Company of Camden. This dismissal practically holds patents on the Faure battery as expired. This decision implies that the patent on storage battery has expired throughout the world.

PATERSON, N. J.—Paterson & Little Falls, the Grand Street and the Peoples' Park Railway consolidate, to be known as the Paterson & Little Falls Consolidated, at \$250,000 capital; \$50,000 of which will be used for improvements. Officers are: President, F. C. VanDyke; vice-president, C. A. Johnson, of Brooklyn; secretary, John J. Scanlon.

NEWARK, N. J.—Newark Passenger Railway Company elects new board of directors: A. Q. Keasbey, Thos. J. Wilson, John R. Hardin, E. J. Moore, and William Ripley, et al. Thos. J. Wilson was elected president, in place of Thos. C. Barr, and E. C. Clay was elected secretary and treasurer. All Newark lines will be immediately electrified, and two roads to Jersey City will be built.

PLAINFIELD, N. J.—A new syndicate, composed of General Manager Jacob L. Stadelman, of Bale, Pa.; Secretary John N. Bethel, of Philadelphia; Chas. E. W. Smith, of Morristown, treasurer. Directors: A. D. Thompson, Plainfield; Lewis C. Manns, of Philadelphia; R. F. Hill, New York, and William N. Mills, Boston, have organized to build a road north and south to connect existing electric lines and steam road systems, to form a great suburban system. Forty miles of new road will be built.

New York.

ROCHESTER, N. Y.—Windsor Beach line opens for business July 19. Ira W. Ludington is superintendent.

ALBANY, N. Y.—Albany Street Railway increases capital stock to \$1,500,000, and will build a belt line, improve roadbed, and add to present equipment.

BINGHAMPTON, N. Y.—Geo. K. Ridgeway has accepted superintendency of the Hornellsville Street Railway Company and begins at once in his new position.

HOOSICK FALLS, N. Y.—Chas. B. Storey, of the Falls Railway Company, has ordered generators, ties and poles. Work will begin as soon as sewers along route are completed.

GRAND ISLAND, N. Y.—Organized: The Grand Island Electric Belt Line Company; capital, \$24,000. Directors: John D. Scanlon, Syracuse; Fred. T. Gates, Medina; Frank B. Gibbs, Buffalo, and others.

GLENS FALLS, N. Y.—Glens Falls, Sandy Hill & Ft. Edwards Street Railway elects J. M. Coolidge president; Loren Allen, vice-president; B. B. Fowler, secretary and treasurer. Extension will be made to South Glens Falls.

BUFFALO, N. Y.—At the meeting of creditors of the John T. Noye Manufacturing Company, the committee after examination of accounts reports that the assets ought to realize a sum far in excess of existing indebtedness, and that the appointment of a receiver is not advisable. Creditors are advised and urged not to institute proceedings for recovery, as in that event officers of company will make immediate action for receiver in order that no one be given any preference. Committee is satisfied the best interests of all will be fully protected by allowing the company to reorganize, arrangements for which are being pushed.

NEW YORK CITY.—Extensive plans for Columbus & Lexington Avenues Cable road are made by Contractor John D. Crimmins. New power houses will be erected along the route of the new lines. Two other new roads are projected by the Metropolitan.

NEW YORK CITY.—Alfred C. Cox, U. S. circuit judge, decides that the American Cable Railway Company has entire right to the combined support or carrying pulley in the United States and can recover damages for infringements in the past. This effects the Brooklyn bridge cable.

NEW YORK CITY.—President H. H. Vreeland, of the Metropolitan, has begun the scheme to consolidate all the New York roads with the syndicate lines. At a meeting of the stockholders of the different roads the same officers were elected as follows: President, H. H. Vreeland; vice-president, D. B. Hasbrouck; secretary, C. E. Warren; treasurer, Hans S. Beattie, and auditor, W. J. Ramsey.

Ohio.

COLUMBUS, O.—The Crosstown Street Railway, it is stated, will not accept the franchise granted it by the city.

CINCINNATI, O.—Cincinnati Street Railway Company reelects old board of directors and executive officers.

LIMA, O.—W. H. Thompson, of this place, is negotiating quietly for an extension of the electric into Huntington.

CINCINNATI, O.—Line of electric railway from Oakley to Madisonville is to be rapidly and vigorously pushed.

PORTSMOUTH, O.—Mr. Whiteley, the Springfield contractor, is on the grounds with a large force of men. Work will be pushed now to the end.

CLEVELAND, O.—Russell-Scofield Street Railway grants not passed by city council. The company will make another vigorous effort to get franchise.

YOUNGSTOWN, O.—A proposition is made by the Pittsburg capitalists of the Lantermans' Fall road and the Youngstown & Canfield corporation to combine.

WARREN, O.—The county commissioners grant rights to the Warren-Sharon Electric road. A bond of \$25,000 must be given, and work must begin not later than Aug. 1, 1894.

COLUMBUS, O.—Tracks of the West Broad Street Electric connected with those of the Columbus Street Railway, and the Broad street lines will be operated by the Columbus Company.

YOUNGSTOWN, O.—H. H. Hamilton and Morgan Evans, together with the Pittsburg Land Company, will push a street railway and land deal. A large lot of land has been bought and will be platted and sold as soon as the street railway is built. Operations to begin at once.

GREEN SPRINGS, O.—Proposals will be received by J. B. Maule, village clerk, until August 14, for construction and operation of street railway route No. 1 in Green Spring. This is the Tiffin, Green Spring & Clyde Electric Street Railway Light & Power Company scheme.

CINCINNATI, O.—The Cincinnati, Oakley & Madison Avenue Electric Railway is opposed by the Consolidated. When the county commissioners were asked for a franchise the Consolidated alleged that the road was to be turned over to the Mt. Adams & Eden Park Company.

COLUMBUS, O.—Columbus & Westerville Electric Railway Company is succeeded by the Columbus Central Railway Company. Road is now guaranteed to be built soon. Colonel Moses H. Neil, of Columbus, was elected president of the new company and J. F. Barry, of New York, secretary. The local representatives will be, T. A. Simonds, G. W. Meeker, Dr. F. H. Houton and F. W. Merrick. The road will probably meet some opposition yet.

Pennsylvania.

JOHNSTOWN, PA.—Johnstown Passenger railway will extend through Daleborough, giving a long new line.

DU BOIS, PA.—C. E. Bostwick resigns superintendency, and is succeeded by M. D. Wayman, of Ford City.

CARLISLE, PA.—O. H. Ormsby and S. R. Ickes, of Altoona are here looking up right of way for new lines to connect several villages.

WASHINGTON, PA.—Stockholders of the electric railway meet and raise \$4,000 of the \$20,000 needed to take the road out of receiver's hands.

PITTSBURG, PA.—The council has passed an ordinance that has been approved by the mayor compelling street railways to use safety fenders of approved pattern.

PITTSBURG, PA.—Crafton council gives right of way and makes definite arrangements for line and transfer with the West End Passenger Railway Company.

PHILADELPHIA, PA.—Electric Traction Company will at once proceed to electrify lines of the old Tenth & Eleventh streets passenger, and the Second & Third street lines.

PITTSBURG, PA.—The Manchester Traction Company asks permission to extend 500 feet, and also petitions for right to operate old Transverse road by electricity instead of horses.

PITTSBURG, PA.—Pittsburg & Suburban Rapid Transit Company decides to increase capital from \$160,000 to \$300,000. A few more cars are also ordered. The road is to be double tracked.

PITTSBURG, PA.—The Central Traction Company (union of the Pittsburg & Duquesne Traction companies) has obtained franchises for short line to East End. A transfer system will be inaugurated.

WILKES-BARRE, PA.—Chas. F. King & Company have begun work on the electric railway for the mine of Coke Bros. & Company. They will also figure on electric power for pumps, ventilation and other machinery.

ALTOONA, PA.—O. H. Ormsby, of this city, and Dr. S. R. Ickis, of Pittsburg, are chief movers in the Cumberland Valley Electric Railway Company, which will build from Carlisle to Mount Holly and several other neighboring villages.

Rhode Island.

NEWPORT, R. I.—Superintendent Brown, of the street railway resigns and several changes in management are rumored.

PROVIDENCE, R. I.—The Pawtuxet Valley Electric Railway will be owned almost entirely and controlled by the United States Traction Company, of New York. The officers elected were: President, N. W. Aldrich, vice-president, Henry L. Green; secretary, H. V. A. Joslin; treasurer, Cyril A. Babcock.

Tennessee.

MEMPHIS, TENN.—A bonus of \$1,500 is raised, and now F. G. Jones promises an extension of the electric to Avondale.

McMINNVILLE, TENN.—Chartered: The McMinnville & Smithville Electric Railway; incorporators, W. G. Crowley, J. L. Calvert, A. B. Hooper, Z. P. Lee, B. M. Webb, T. B. Potter, and others.

MEMPHIS, TENN.—The Johnson avenue extension will be finished in about thirty days, and more will follow when money is easier. The Dummy line purchase by Citizens' Company is denied by both parties.

MEMPHIS, TENN.—Citizens' Street Railway has closed the deal for the ownership of the Suburban Electric Railway. This adds five miles to the system. Consideration, \$50,000, and assumption of \$85,000 indebtedness.

KNOXVILLE, TENN.—Charles J. Pogue is in Ohio collecting \$250,000, which he will use in electric railway enterprise here. Right of way is secured, and a mile track will be built at the terminus. The road is now regarded as a "sure thing."

WINCHESTER, TENN.—J. W. Hudson, president of the Winchester Electric Railway, is ready to let contract for cedar piling from fifty feet long and ten inches diameter down to fence posts. Bids wanted on oak as well as cedar. Colonel Hudson will select cars in St. Louis. Other equipment will be let there also.

Texas.

DALLAS, TEX.—The Dallas Electric Company files resolution to increase capital stock to \$600,000 from \$400,000.

FORT WORTH, TEX.—The Fort Worth-Dallas electric line is said to be well backed and that equipment is now being bought. Some wise-aces say, however, that the right of way will be used for a steam line which wants admittance to Fort Worth.

Virginia.

ALEXANDRIA, VA.—The Spear electric railway and real estate enterprises are now abandoned because of stringency in money market.

Washington.

TACOMA, WASH.—Court has given rolling stock of the Tacoma & Puyallup electric to employes to sell to apply on wages. Road will cease operations for the present, at least.

SEATTLE, WASH.—Seattle City Railway Company elects officers as follows: President, J. M. Wilmans; vice president, F. W. Wilmans; secretary and manager, O. S. Buckbee.

SPOKANE, WASH.—Jas. A. Clark has been awarded contract by the Washington Water Power Company for the proposed extension of the Arlington Heights Railway to Hillyard.

PALOUSE, WASH.—S. Z. Mitchell, Portland, president Palouse Electric Company, and Manager B. J. Mahlum, will make extra efforts to increase the use of electricity and extend service.

SEATTLE, WASH.—Guy C. Phinney asks a franchise over certain streets and avenues from Yester avenue and Fourth to Woodland Park on Green Lake for an electric. City council grants same. Work will begin next winter.

SEATTLE, WASH.—Seattle City Railway, known as the Yesler avenue line, is sold by J. M. Wilmans, S. C. Wilmans, and F. W. Wilmans, to a syndicate represented by Fred. E. Sanders. The new men as trustees are, F. E. Sanders, L. D. Bruns, N. B. Sanders, J. W. George, S. Bryant, J. W. Hall, and J. K. Hall. F. E. Sanders is now in San Francisco on business connected with the road, but eastern money is in the deal. O. S. Buckbee, general manager, retired August 1.

Wisconsin.

MILWAUKEE, WIS.—Milwaukee Electric Street Railway organized out of the Hinsey line recently sold. New company has \$300,000 capital stock and incorporated by Chas. Pfister, Chas. Landsee and Chas. Quarles. Road may be either sold or operated.

Custer's Last Battlefield.

A visit to this spot, which is now a National Cemetery, is extremely interesting. Here, seventeen years ago, General Custer and five companies of the Seventh U. S. Cavalry, numbering over 200 officers and men, were cut to pieces by the Sioux Indians and allied tribes under Sitting Bull. The battlefield, the valley of the Little Big Horn, located some forty odd miles south of Custer, Montana, a station on the Northern Pacific Railroad, can be easily reached by stage. If you will write Chas. F. Fee, St. Paul, Minnesota, inclosing four cents in postage, he will send you a handsomely illustrated 100 page book, free of charge, in which you will find a graphic account of the sad catastrophe which overtook the brave Custer and his followers in the valley of the Little Big Horn, in June, '76.



PATENT OFFICE GOSSIP.

THE management of the patent office has deservedly been given a thorough roasting by the technical papers during the past month. The office is now over a month behind with its issues. The giving of the engraving work into inexperienced hands is claimed to be the cause of the delay.

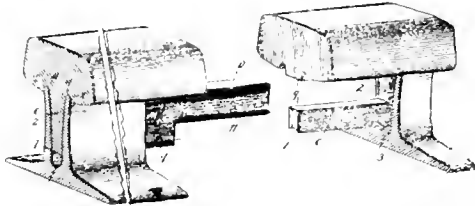

No. 500,825.

THE compound rail, No. 500,825, appears to be a not altogether impractical form, and one that might help the rail joint question.

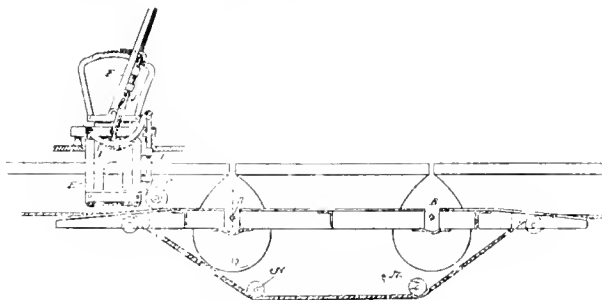

No. 500,903.

THE cable crossing and releasing device, No. 500,903, has the grip released by the advance wheels as shown.

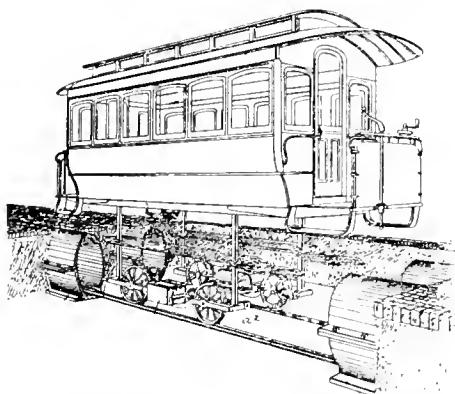

No. 500,953.

WE publish as a curiosity the illustration of the conduit railway, No. 500,953, in which the entire running gear is placed underground.

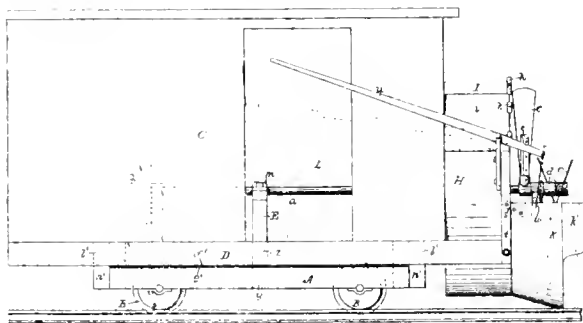

No. 501,028.

THE track cleaner, No. 501,028, works on the principle of the blower. The snow is taken up by the scoop and thrown back by a wheel having inclined blades like a windmill and then is taken by a bucket-wheel.



No. 500,906.

THE peculiarity of the brush for street sweepers, No. 500,906, is that some of the steel broom strips are flatwise and some edgewise. See illustration.

STREET RAILWAY PATENTS.

ISSUED JULY 4, 1893.

Deflector and ventilator for passenger cars, Charles E. Berry, Cambridge, Mass.....	500,555
Equalizing device for cars, John Gosney, Wilmington, Del., assignor to John A. Brill, Philadelphia.....	500,573
Rail chair, Michael Maloney, Ironton, O.....	500,589
Railroad-rail, Ernest R. Esmond, New York, N. Y.....	500,688
Railroad crossing, Henry Elliott, St. Louis, Mo.....	500,706
Compound railway-rail, John C. Telfer, Kansas City, Mo.....	500,825
Cable releasing device and crossing, Adam Jeffreys, San Francisco.....	500,903
Brush for street sweepers, John Jones and Alexander Gillies, Toronto, Can.....	500,906
Street car, Jas. Marshall, Toronto, Can.....	500,924
Transfer table for railways, Arthur J. Moxham, Johnstown, Pa.....	500,929
Railroad rail chair, Arthur J. Moxham, Johnstown, Pa.....	500,931
Conduit railway insulator, Geo. E. Noyes, Washington Grove, Md.....	500,937
Electric railway system, Frederick S. Perrin, Lynn, Mass.....	500,943
Overhead electric railway, John C. Henry, Westfield, N. J.....	501,009
Track cleaner, Geo. W. Ruggles, Charlotte, N. Y.....	501,028

ISSUED JULY 11, 1893.

Joint for railway rails, John C. Pennie, Washington, D. C., administrator of Julius Schmidt, deceased.....	501,159
Electric circuit closing device, William Sears, Boston, Mass.....	501,258
Fender for electric cable or other similar cars, William J. Nunn, Hyde Park, Mass.....	501,294
Street Sweeper, Thomas C. Myers, Cleveland, O.....	501,352
Street Sweeper, Thomas C. Myers, Cleveland, O.....	501,353
Cable grip, Robert A. McLellan, Portland, Ore., assignor one-half to Franklin L. Fuller, same place.....	501,467
Trolley wire hanger, Alexander W. Meston, St. Louis, Mo.....	501,481

A Few Facts Concerning the Big Four Route to the World's Fair.

"Isn't one man as good as another?" asked an orator in the course of a stump speech, and a voice in the crowd replied, "Yes, and a blamed sight better!"

Now, it is a good deal the same with the Big Four Route to Chicago; it is a "blamed sight better" than any other line. Why? In the first place the train service, equipment and road bed are unequalled by any railroad in the country; in the second place, the Sleeping Cars, Parlor Cars and Day Coaches are the finest specimens of the car builder's art that ever ran on wheels; in the third place (now read this carefully), all trains of the Big Four Route enter Chicago along the Lake Front, stopping at Midway Plaisance, the Main Entrance to the World's Fair Grounds, 60th St., Hyde Park, 39th St., 22nd St., 12th St., and land passengers and baggage convenient to all the World's Fair Hotels and Boarding Houses, as well as the down-town Hostleries. Think what this means! You are landed with your baggage within a few minutes walk of your stopping place, avoiding the long tiresome transfer across the city necessary via other lines. All ticket agents throughout the country are supplied with Big Four tickets, and if you wish to enjoy the Fair to the fullest possible extent ask for tickets via Big Four Route. For further information address D. B. Martin, General Passenger Agent, Cincinnati.

IF ANY of our readers have an extra copy of Index to Volume I, (for the year 1891) please advise us. Also copies March, 1893.

BURSTING OF A FLY WHEEL.

WITHIN the past month a peculiar accident occurred at the central station of the Memphis Light and Power company, in the bursting of a flywheel which was also the driving pulley. The wheel was 11 feet diameter; 50 inch face, and weighed about 15,000 pounds. It was built in halves, had two sets of arms, eight on each side. The shaft was 8 feet 6 inches between the cranks, and the diameter of the journals was 8 inches, number of revolutions of the engine per minute in service was 152. The fragments of the broken wheel flew in the direction of the travel of the wheel, front and rear, going in a direct line, except where deflected by striking some object in its path. One large piece, weighing several hundred pounds went to the rear and passed through a 12 inch brick wall between the engine room and the boiler room. Three large pieces went

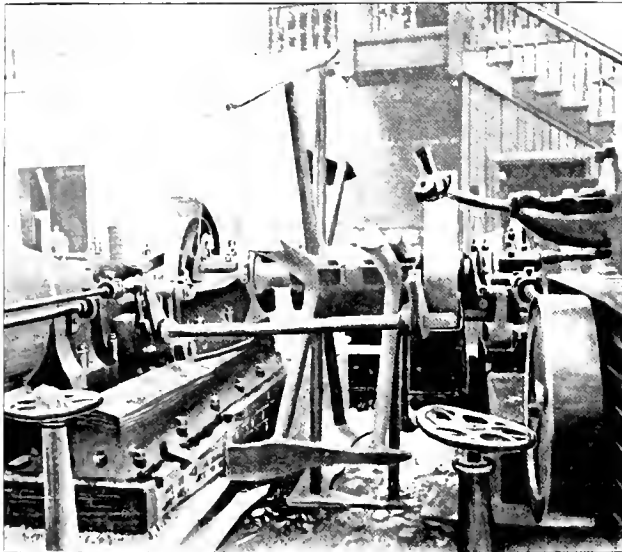

END VIEW OF WRECKED WHEEL.

through the roof, one of them carrying about 20 feet of belting with it, and all three were found lying on the roof after the accident, while the ends of the belt hung into the engine room from the hole in the roof. Another piece going through the roof fell into a lot across the street. What must have been a portion of the wheel went to the front and knocked out a hole about 5 by 6 feet in a 20 inch brick wall between the engine room and shaft room, and completely demolished a belt tightener with a 50 inch face, under which the belt from this engine passed on the shaft room side. Some of the flying pieces cracked two pulleys on the line of shafting, but there was no damage of any consequence, done to the engines, and beyond the loss of the wheel and the belt tightener, the damage was principally confined to injury to the building from the broken portion of the wheel. The wheel was driven by two compound condensing engines of 225-horse-power each, one being coupled on each side. It was very evident the belt did not part until the wheel burst, and it is believed the restraining influence of the double .18-inch

leather belt prevented greater damage than occurred. One of the engines had been overhauled but has already been run several times without load and worked normally, and the engineer desired to give a final trial, to see if the bearings heated before putting her into service for the night. He stood between the two, with a hand on each throttle, and had just given the order to his assistant to be ready to clutch in on the engine he had in hand,

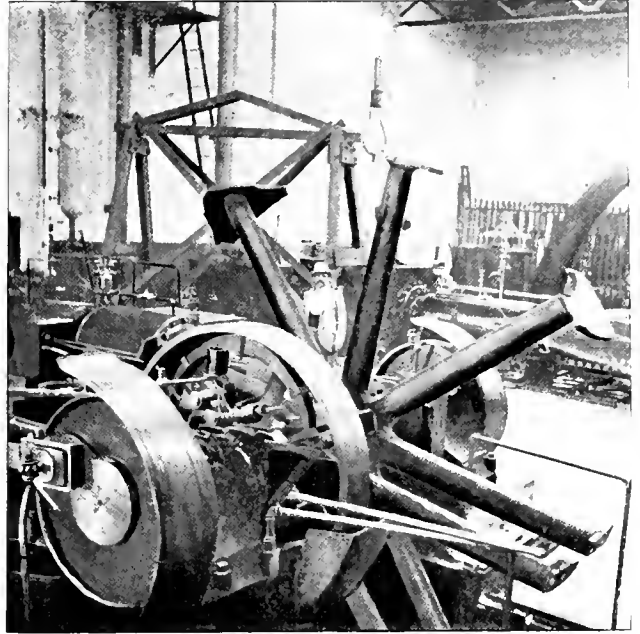

SIDE VIEW OF WRECKED WHEEL.

when he should give the signal. The load was not put on for the signal was not given, as the engineer was instantly killed by the flying fragments of the wheel which burst a few moments later. A most careful investigation by competent experts utterly failed to discover any reasonable cause which could have occasioned the accident. Our illustrations are from photographs taken by the REVIEW artist the morning after the accident and show how complete was the wreck of the wheel. The event seems properly classed among many singular and inexplicable accidents in which blame cannot be justly placed on anyone and which human foresight seems incapable of anticipating and preventing.

ONE OF THE OLD FAMILIES.

THE press sometimes recognizes progress. The Chester, Pa., News, gives the following paragraph in relation to the kicker:

"It's funny," said an old resident "that there should have been such opposition to the electric railway. Suppose we went back to horse cars! Why, the people who kicked the hardest would growl themselves hoarse. Yet it has ever been so. People kicked when the stationary steam engine was introduced, they kicked when the locomotive came, and the same family of growlers will have their descendants here to oppose every other onward step."

FOREIGN FACTS.

THERE is said to be a dearth of good draughtsmen in India.

THE council of Cork has given consent to the use of overhead construction.

THAT wonderful aggregation, the Heilman locomotive, is still being experimented with and commented on.

THE Amir of Kabul has ordered a survey for a steam tramway to bring stone from the hills five miles away.

DICK, KERR & COMPANY, London, have the contract for the construction of the Greenock Corporation Tramways.

THE electric tramway at Remscheid was opened last month. It is on the Thomson-Houston system and was constructed by the Union Electricity Company, of Berlin. It is owned by a company, half of the stock being taken by the municipality.

THE Glasgow Tramways & Omnibus Company carried 26,147,666 passengers during the past half year, with gross receipts of \$600,000, an increase of \$60,000 over the corresponding period for last year. The trackage remains the same, 31.26 miles.

THE Highgate-Hill cable road, London, has been inspected by the board of trade committee and the line will probably be opened soon. Some opposition of a local board has delayed matters. It is understood that W. J. Carruthers-Wain will associate himself with the line.



WRECK OF THE AUSTIN DAM.

AN electric railway has recently been put in commission at Santa Fe de Bogata, Columbia, South America.

THE telephone has again been beaten in England. Electric traction is free to use a ground return, and a metallic circuit is recommended to the telephone companies.

CAPE TOWN, South Africa, has lately put in service a street car of the American pattern, seats and springs. The local press is enthusiastic in its praise except for the side seats.

TRAMWAY matters are lively in Buda-Pesth. The company in that city carried in 1892, 14,000,000 passengers, as against 8,500,000 in 1891; receipts increased nearly 50 per cent, and stand at 766,000 florins; a dividend of 7 per cent was paid, and 28,000 florins placed to reserve. The remaining capital is 150, or 50 per cent premium.

BREAK IN THE AUSTIN DAM.

OUR engraving, which is taken from the Engineering News, shows the condition of the recently broken dam at Austin, Texas. The break was caused by the water leaking into a crevice in a stratum of rock on which the headgates rested. An excavation for a canal at a point 100 feet above the gates came very near the crevice, and finally the water found its way into it, enlarging the crack into a soft stratum of rock. It was intended to use the dam when completed for general power purposes, including the electric railway. Some attempt is being made at present to repair it by building a coffer dam. The work is under the care of the city of Austin, and the loss entailed reaches away up in the thousands. The accident is attributed to a change in plans growing out of a change in engineers. As originally planned the disaster would not have been possible.

COST OF POWER ON THE CEDAR RAPIDS AND MARION CITY RAILWAY.

IT is very seldom that reliable tests are made on any but the largest power plants, and it is therefore with special pleasure that we are able to present some figures on the performance of the station at Cedar Rapids, Iowa. The figures are the result of several months' observation, by the chief engineer, R. B. Holbrook, formerly of Chicago, and known to the engineering profession as the "slide rule crank," a title of which he is, rightly, not in the least ashamed. That the results are reliable, all who are acquainted with Mr. Holbrook and the painstaking character of his work will feel sure. If there are any doubters a trip to Cedar Rapids and



R. B. HOLBROOK.

an investigation into the methods will remove all skepticism. The station is equipped with one 22x42 and two 14x14 Reynolds-Corliss engines, each having a condenser and heater; three return tubular boilers 5x16 feet with forty-four 4 inch flues each: one 300 kilowatt and two 80 kilowatt Thomson-Houston multipolar generators. The large engine and generator which are direct belted are the ones generally used.

There were operated during the test on August 3, two 34-foot double truck inter-urban cars weighing 6,000 pounds each, equipped with two W.-P. 50 T.-H. motors each: one express car weighing 12,000 pounds with the same equipment, and eight 16-foot cars weighing 9,800 pounds each, equipped with one E.-R., G., T.-H. motor. The three heavy cars run six miles from the power house over grades of 5 1/2 per cent. The running time for the six miles is 28 minutes, and this includes numerous stops. There are also grades on all the other lines.

For several months Mr. Holbrook has been at work determining the performance of the plant. The results were so surprisingly low for so small a station that great care was used in checking up, to be sure that the figures were reliable. Now, however, after so many days' tests it is thought that there is no doubt as to the accuracy of the results.

During the month of June the plant burned, according to the shippers' weights (which are certainly not too high) 51 tons of Iowa soft coal slack (or screenings), costing 60 cents a ton. The car mileage for the month was 8,812 or 256 car miles per ton of coal, making the cost per car mile 2 3/6 cents. Mr. Holbrook gives as his opinion that with six or eight more sixteen foot cars in service this figure could be lowered considerably. An average day's run may be seen from the figures of a test August 3, 1893.

Duration of test (fires banked 6 hours).....	24 hours
Average steam pressure.....	65 pounds
Average temperature of feed water.....	130°
Pounds of coal burned.....	9,600
Pounds of combustible.....	7,680
Per cent of ash and clinker.....	20 per cent
Total water evaporated at temperature of feed.....	44,500
Water evaporated per pound of coal, actual conditions.....	4.6 pounds
Water evaporated per pound of coal from and at 212°.....	5.15
Water evaporated per pound of combustible actual conditions.....	5.8 pounds
Water evaporated per pound of combustible from and at 212°.....	6.4

Total car miles during test.....	1,325
Miles run per ton of coal.....	275
Cost of fuel per car mile.....	\$0.0033

Even considering the fact that the soft coal slack burned is a very cheap fuel, containing as much combustible as Iowa lump coal, costing nearly twice as much, this is a remarkable record, and it is to be doubted if any of the larger roads can make a better showing. The record of the actual cost of fuel for a month's run divided by the car mileage is certainly as reliable and practical a basis of comparison as could be wished.

So far we have dealt only with the cost per car mile. There are however a number of interesting and valuable points for the steam engineer that were brought out in connection with these long continued tests. When it was first decided to determine the efficiency of the plant, men were set to work taking simultaneous readings from the ammeter and engine indicator. It was thought that in this way the loss in engine and dynamo by friction, etc., could be determined. This method was found worthless because no two readings give the same ratio between the indicated horse-power and electrical horse-power. The reason for this is that the fly wheel of the engine is at some moments giving out energy and at others receiving it. The following method was finally adopted for obtaining horse-power readings. A pointer and scale were attached to the engine governor. By taking several hundred cards at different boiler pressures, this indicator has been accurately calibrated and several thousand indicator readings taken at 10 second intervals. From these readings the average horse-power for the hours between 7, a. m. and 9, p. m. is found to be about 120. During this period the water consumption is generally 36,000 pounds, or 21.5 pounds of water per indicated horse-power hour. This is for an engine developing an average horse-power of less than one-half its rated capacity, —nearly up to the record for this type of engine on a steady load.

The device finally settled upon for measuring water is here illustrated. Water meters were tried and found unreliable and for continuous testing such as was done here, weighing all the water was out of the question. This device is simply a chamber in which the water is kept at a definite head as shown by a glass gauge at the side, and allowed to escape through a certain sized vent. The supply is from the overflow of the air pump. It was found by actual trial what weight of water would run per minute with a given head, and being once calibrated all

that was necessary was to note the time of starting and stopping the meter. The vent is a round hole cut in an iron diaphragm. The water is discharged into a barrel in which is the suction of the boiler feed-pumps. No trouble is experienced in maintaining a constant head of water, or in keeping the boiler supply running at the

same rate as the meter. With a $\frac{7}{8}$ inch orifice and 15 inch head of water 5,760 pounds are discharged per hour. A 1-inch orifice and 12-inch head discharges about 6,150 pounds and with a 24 inch head about 8,000 pounds. The formula for calculating is:

$$\text{Velocity per second} = \sqrt{\text{head in feet} \times 8.02 \times .62}$$

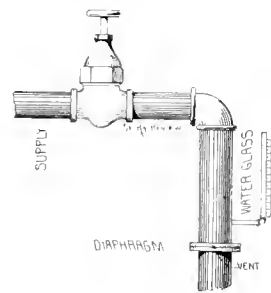

WATER MEASURING DEVICE.

Having the velocity the number of cubic feet and hence number of pounds flowing per second can be determined from the size of the vent. The device is cheap and simple yet about as reliable as any known plan for measuring water.

It may be of interest to some to know the results running condensing as against non-condensing. It has been proved in this plant that the saving by the use of condensers is from 22 to 25 per cent in fuel.

It is found that the number of passengers carried from day to day did not appreciably affect the coal consumption or the average horse power, yet there was quite a variation in the fuel and steam required on different days with the same car mileage. This has been noticed on several plants and would bear further investigation. It can not always be accounted for by a wet track though this of course covers some cases.

ALUMINIUM TICKETS.

WE present herewith the first illustrations published of the aluminium tickets now in use on the Citizens' Street Railway of Kalamazoo, Mich. The adult's tickets are sold at the rate of six for 25 cents, and the childrens' at 10 for 25 cents. They are



not sold by the company's employes, but are sold in quantities by the store keepers, who handle them exclusively. The aluminium is so light as to be easily distinguished from silver. As soon as tickets are turned in they are sold back to the storekeepers.

There was a young man of Eau Claire
Took a Ferris wheel ride through the air,
But the air growing thinner,
Unsettled his dinner;
To say nothing at all of his hair.

DELIBERATELY PLANNED ACCIDENTS.

A World's Fair Exhibitor Throws Himself in Front of a Cable Train to Secure Accident Insurance—An Unusual Confession of a not Unusual Scheme to Secure Money.

EARLY in 1891 we published an article recounting several incidents in illegitimate damage claims which had come under our own personal observation. It was then shown to what extent irresponsible persons, aided by shyster lawyers, attempted to bleed street railways for accidents which never had any existence. The Tribune of this city publishes the confession of a desperate young man who carried out his intentions to defraud even to the extent of almost losing his life. While his claims were directed against insurance companies, his statement is none the less interesting. He secured an accident policy for \$20,000 in May and made the first claim early in July. So numerous were his accidents an agent investigated Mr. Hicks, and the following is the result:—

Gentlemen: The written statements I have made to you and to other insurance companies concerning my having been accidentally injured are false, every one of them, as I have met with no accidental injury of any sort or kind, at any time or place, and because I have been fairly caught by your Chicago agent I offer this as an honest confession of my dishonest intentions. My injuries were self-inflicted; the first was June 27, at Adams street and Michigan avenue, when and where I voluntarily threw myself under a street car. I did it for the purpose of having the said car pass over my left hand and wrist and so injure the same that it would have to be amputated at that point, but miscalculating the time and distance, the wheels of the car, notwithstanding the car was derailed passed over the back of my hand without breaking a bone. What I wanted from your company and the others whose policy I held, for I knew what each provided, was the amount of money in one lump sum for the loss of my hand.

My failures to bring about the disabled condition which was to secure me the money I was after, determined me to make a second attempt to beat the insurance companies, and so, during the next week, I resolved to kill myself, and to do it in such a way as would surely cause the belief that it was purely accidental. July 4 I bought a revolver, fully determined to end my existence that night. I reasoned that if I could not make a non-fatal injury benefit myself I might be able to make a fatal injury benefit for my mother. At 8 o'clock p. m. I went to Groveland Park for the one purpose of carrying out my plan, but at the last moment my courage failed me. As my original idea of benefiting myself came to my mind again I shot myself through the left hand and then went to Dr. McMichael's Sanitarium for treatment, which was also a part of my scheme, every detail of which I went over fully. My object, from first to last, was to raise money, and I was perfectly willing to risk my life or limb to secure it. I succeeded in defrauding others and I did my best to defraud you, but failed because your agent was too smart for me.

I was perfectly satisfied to part with it for that price, and I was disgusted when I found the shot which I had put through my hand had not hopelessly crushed it. I did all I could to induce the surgeon who attended me to amputate it anyway. But the fates were against me and I have failed in all my schemes ignobly. Now, please do not imagine me a fool or insane or a man who has acted hastily, for I have an active brain, a perfectly sound mind, and in conclusion let me say that I gave many serious hours to the perfection of my scheme.

ROBERT HICKS.

In forwarding his report of the affair to the Eastern office the Chicago agent writes:—

There has been some doubt in the minds of the public as to whether a man would deliberately commit an act of this kind and be in his right mind. We beg leave to state that the person in question had an interview with the writer a few hours before this statement was made, and it would be impossible to meet with a more intelligent, courteous and affa-

ble gentleman than Mr. Hicks. We submit this matter in the interest of the business, as many honest people object to the close investigation of accident claims. This may enlighten them to the necessity of it.

While cases where deliberate injury is planned and practiced are numerous, it is seldom so complete a confession is secured, and the article is worthy of preservation to use in a time of need when agricultural jurors cannot believe such things possible. The young man has settled with the company, and left town.

THE MOVING SIDEWALK.

OUR illustration of the moving sidewalk, presented on this page, shows a portion of the loop at the west end of the structure, with the peristyle and Casino in the background. The crowd is not an average one, as usually there are many more coolness-seeking mortals enjoying the breezes of Lake Michigan.

The sidewalk is now in permanent operation on the pier and the results so far accomplished are in every way

and engineers is the fact of the small horse power required to operate the system. The total weight of the train is about 500 tons empty, and while loaded with 4,000 passengers 800 tons. From indicators at the controlling station it is seen that to move the entire affair but 105 electrical horse-power are necessary.

Although the line is built upon the hollow pier, there is not the least noise attending the running of the train, although the curves are short. In fact, so silent is the movement that but for the motion of the cars, which can be seen, a person standing 25 feet away would be in total ignorance of the existence of this novel means of locomotion. From popular talk and judicious advertising, however, no one leaves the White City without at least one trip on the moving sidewalk. The structure is substantial and no repairs have been so far required.

Still another point of interest is the fact that on this plant, for the first time in our knowledge, are placed two continuous pieces of steel, without joint, each 4,300 feet long, and that, owing to the mode of construction which



THE MOVING SIDEWALK IN OPERATION.

satisfactory to the management and the public at large. The only disappointment experienced has been that the power was not furnished by the Exposition Company at the time agreed upon, namely, upon the fifteenth of April. This occasioned a delay of nearly two months and the road was not opened for traffic until July 1.

Since that time the road has carried to date 200,000 passengers of both sexes and of all ages and conditions, without accident or delay. Aged people and little children and women as well as men quickly adjust themselves to the idea and, beyond a few shows of lingerie, no casualties have occurred. Uniformed guards stationed at the entrance gates tell the passengers simply that in stepping on they must "step right foot first" and on leaving the order is "step left foot first." This simple reminder is sufficient for the most nervous old lady that ever came from Kokomo.

Another feature that astonishes visiting railway men

has been adopted, there is no difficulty experienced from the expansion and contraction of these long pieces of steel. This is certainly a point of interest to engineers and metal workers.

On the whole, it must be said that on account of the low fare, which is only five cents, and which permits the passenger to remain in his seat as long as he pleases, the moving sidewalk is one of the most popular attractions on the grounds, as well as the most novel.

A. L. IDE & SON'S EXHIBIT AT THE FAIR.

THE well known firm of A. L. Ide & Son, of Springfield, Ill., is well represented in Machinery Hall power plant, by six engines. They range in size from a baby 16-horse-power simple 6 by 6, to a 225-horse power compound, measuring 13 by 16-inch stroke. The small engine is direct coupled to a 150 light machine-

While the 224-horse-power is the pride of the plant, having a record of a continuous run of 740 hours, from March 28, and in this time making 10,800,000 revolutions without shut down. We represent this engine in our engraving with the card attached which vouches for the magnificent work performed. Besides these a 175-horse-power simple engine, 16 by 16 inches, and a 70 horse-power simple engine in the boiler room, complete this display. A novelty in the form of a model Ideal has been lately installed. It was built by the Springfield watch factory and is to run by compressed air. It is a beautiful piece of mechanism. The patent Ideal power transmitter is shown in connection with the exhibit which consists of running the belt over two pulleys between which the band wheel runs. The advantages claimed for this style of transmission are that it economizes space and facilitates stopping and starting the load on either side without stopping the engine.

The principal claims for the Ideal engines are: auto-

TUNIS BRUCE GRIFFITH.

THE recent death of Tunis B. Griffith, manager of the Hamilton Street Railway, of Hamilton, Canada, removes from the Dominion railway circles one of its most esteemed members.

Mr. Griffith was born in 1854, in Norfolk county, Ontario. His father was a railroad man on the Great Western line, and after a thorough education at the University of Michigan, Mr. Griffith went into the same line of work as telegraph operator. Here his ability soon won a ticket agency at Hamilton. During the Manitoba boom and the Centennial year, Mr. Griffith acquired considerable money, which laid the



THE LATE T. B. GRIFFITH

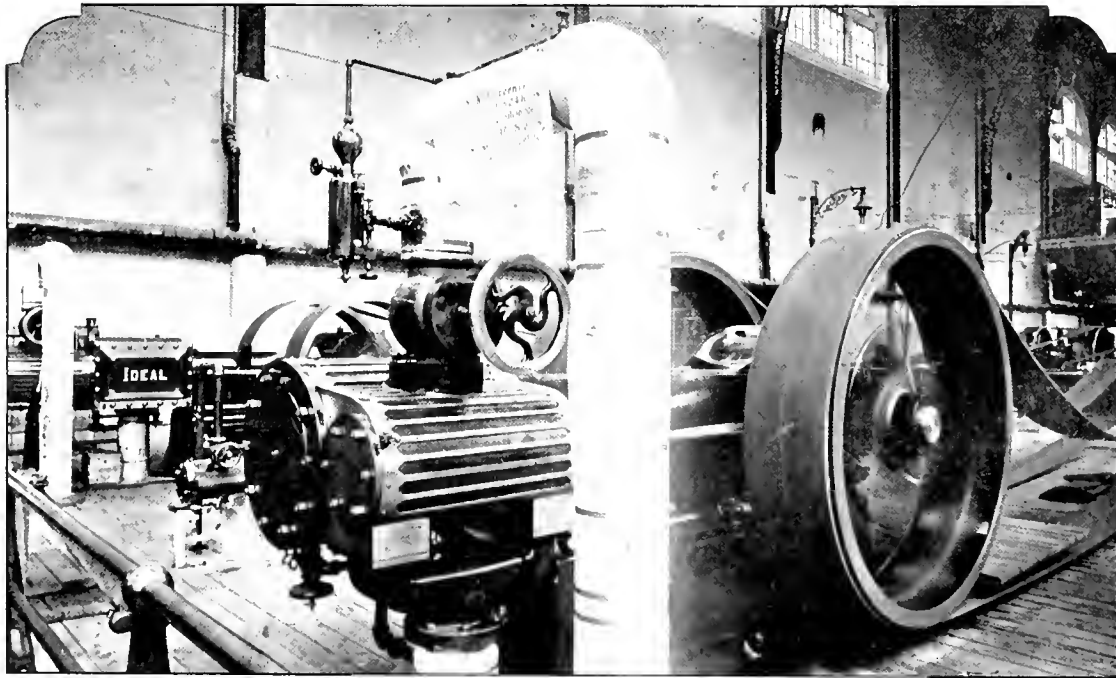

IDE'S WORLD'S FAIR ENGINE.

matic lubrication, by a method that is regarded by the engine builders as perfect: the connecting rods are of steel and tested to six times the working load before use in the engines; the new form of crosshead is a steel crucible casting with phosphor bronze slides attached at top and bottom. These are considered special details. The main shafts are of hammered open hearth steel, the cylinders of close grained charcoal iron and all other parts are made of the most adaptable material, by experienced workmen, under careful supervision.

The Ideal governor is of special design and close regulation and is justly a matter of considerable pride to the manufacturers. The engines at the Exposition are doing splendid steady duty and should be carefully studied.

foundation of his fortune, which his sagacity and unremitting industry has built up.

In 1885 Mr. Griffith and his brother bought a controlling interest in the Hamilton Street Railway Company, which was at that time in the most miserable condition of bobtail destitution, without any particular prospects for the present magnificent patronage. Mr. Griffith set about the organization of a company and the establishment of a modern road, to which the citizens of Hamilton owe much comfort, and the appreciation of which is fully proved by its thriving condition. The recent renewal of the company's charter and the conversion of the road to electric traction are but incidents in the career of the Hamilton, road due to his energy and public spirit.

A TROLLEY POLKA.

THE events which attended the fight for franchise of the electric lines of the New Orleans & Carrollton road, shared little of that rapidity of action which characterizes things electrical. The franchise which was finally granted, to replace mules with motors, was secured only after many hard fought battles, beginning in 1888 and kept up persistently until victory was secured. In this a citizens' organization played an active and important part, and as fast as one petition was refused by the city council, another was presented forthwith. The officers of the company, of course, held a prominent place in the efforts made, and were several times assisted by O. T. Crosby, himself a southerner by birth and who married a New Orleans lady—who addressed the city council on behalf of the road. Finally, as previously related in full in the REVIEW, the road was opened and has proved a great success. A New Orleans composer, who has already achieved an enviable reputation, has just celebrated the event by writing "A Trolley Polka," dedicated to Superintendent C. V. Haile and the gentlemen prominently connected with the various citizens' committees already mentioned. The piece is proving as great a success in its way as the electric road itself and is becoming as popular. By kind permission of the author, Paul Tulane Wayne, of 127 Canal street, New Orleans, we are permitted to present the music in reduced size to our readers. The citizens now propose to give a grand electric ball, in which the author will lead the orchestra and the first number will be the

"TROLLEY POLKA."

Paul Tulane Wayne

Allegro.

Tempo di Polka.

Copyright 1902 by Paul Tulane Wayne

Trolley Polka. I

An interesting paper was read August 3, before the World's Fair Engineering Congress, by Robert Gillham, of Kansas City, on the "Transmission of Power in Operating Cable Railways."

ECHOES FROM THE TRADE.

THE FIRST street car has been turned out of the C. D. Morse shops, Millbury—a suburb of Worcester, Mass.

R. E. RUST, receiver of the National Electric Manufacturing Company, Eau Claire, Wis., will sell the plant at auction on September 4.

THE BODIFIELD BELTING COMPANY, Cleveland, has gone into a receiver's hands. Assets, \$60,000; liabilities, \$36,000. C. T. Bodifield, receiver.

THE BENEDICT & BURNHAM MANUFACTURING COMPANY, of New York, call particular attention to their solid one piece rail bond, advertised among their specialties.

THE NEW YORK EXHAUST & BLOW PIPE COMPANY, of New York, has just been granted patents on a new exhaust head, for which several claims of excellence are made.

F. E. GILLING, Toledo, has invented a momentum brake in which a manilla rope is wound on a spool, applying the brakes. A company will be organized to manufacture.

THE NEW PROCESS RAWHIDE COMPANY, of Syracuse, N. Y., reports that its street railway business has grown rapidly and that orders from new patrons are booked every day.

THE MEAKER MANUFACTURING COMPANY has introduced its register on the Lynn & Boston Street Railway, which conservative institution has until of late used the old style bell punch.

THE TRAMWAY RAIL COMPANY, Pittsburg, is erecting large mills at Fordham, a new and growing suburb of Pittsburg, and are also providing a large number of neat and attractive homes for its employes there.

THE SOUTHERN RAILWAY CAR ADVERTISING COMPANY, with offices at 77 Edgewood avenue, Atlanta, Ga., will lease advertising privileges from southern roads and retail the space. Judge J. K. Hines is president.

THE ALTOONA MANUFACTURING COMPANY, Altoona, Pa., builders of the M. A. Green automatic engine, have applied a new device for oiling their crank pins, which does away with wipers and annoyances of that kind.

C. F. WASHBURN, vice-president and secretary of the Washburn & Moen Company, died of apoplexy at his home in Worcester, Mass. His loss will be mourned by a large number of business men throughout the country.

THE GILBERT CAR COMPANY, of Troy, N. Y., is at present engaged on an order for 100 passenger coaches for the Lake Street Elevated Railway, of Chicago. The first twenty were shipped July 26 and the others will follow at intervals.

IN reply to a query as to their world's Fair display, the Shultz Belting Company says: "You will please find the same located in our factory, corner Bismarck and Barton streets, in the great city of St. Louis, which always has a fair of its own, running all the year round."

THE PHOENIX IRON WORKS COMPANY, 519 The Rookery, have been awarded the contract for a complete steam plant for City of St. Clair, Mich., comprising one of their 150 tandem compound condensing engines and Manning Vertical boiler; also Pittsburg Construction Company two 100-horse-power compound engines for lighting the Ferris Wheel plant.

SOME very large contracts for railway material have been placed with the Ansonia Electric Company, within the last few weeks. Their new adjustable pipe bracket, as well as the new insulators, are meeting with great success and are being adopted by a large number of electric roads. The Ansonia Electric Company recommends these fixtures for strength and insulation.

OWING to inability to make collections, the John T. Noye Manufacturing Company, Buffalo, has temporarily suspended payments. A creditors' examination found the assets far in advance of the liabilities, and no disposition is offered to ask for a receiver. A re-organization will be effected and it is believed, and hoped, by all who have any knowledge of the gentlemen connected with the management, that they will speedily be in shape once more.

AN order has been closed for fuel economizers in sections, aggregating 3,200 pipes, for the Philadelphia Traction Company, which will be furnished by the Fuel Economizer Company, of Matteawan, N. Y. The capacity of these economizers is sufficient to supply 15,000 horse-power of boilers. Also an economizer for the electric line being built by the Oakland Gas & Light Company, of Oakland, Cal.

"THE TROLLEY POLKA" is the catchy title of a new piece composed in honor of the opening of the electric line in New Orleans. Paul Tulane Wayne, of that city, is the author, and the polka has made a great hit. The music will be found elsewhere in this issue, and the composition published in the regular size of sheet music can be had by addressing the author, Paul T. Wayne, 127 Canal street, New Orleans. Price, 40 cents.

R. D. NUTTALL, on his recent retirement from the R. D. Nuttall Company, was presented with an elegant silver service by his former employes, who wished in some manner to show the esteem in which they held their employer. The deed speaks volumes both for manager and employes. Mr. Nuttall has not yet decided on his future career, but will undoubtedly remain in the active world of manufacture where he has been so successful.

LONGER than the moral law, in fact over 9 feet long, is the list of 130,000-horse-power of Ide engines, set in solid nonpareil, which is being mailed by Ide & Son, Springfield, Ill. Forty-two states and territories and seven foreign countries comprise the list. Second and third orders from the same buyers constitute nearly half the list, while one company has reached its twenty-eighth order and is still coming. It is an interesting and remarkable record and makes a total of about 1,200 engines.

THE ALTOONA MANUFACTURING COMPANY, of Altoona, Pa., has recently installed two of their 300-horse-power 20 by 24 inch automatic engines in the power plant of the Altoona & Logan Valley Street Railway Company. These engines are extra heavy and have done remarkable good service for the past two months. They have been in use day and night for that length of time without shut down. Tests show that the flash loads the engines

THE JOHNSON COMPANY OF JOHNSTOWN.

BESIDES the large amount of rail and special work shown on the street railways of Chicago, the Johnson Company, of Johnstown has a very representative collection in the Transportation annex at L, N, 4 and 5.

Here may be seen racks of standard rails showing sections of from 4 to 9 inches, in depth. There are also displayed, brace and plain tie plates and chairs, standard girder joints and the special Whitten joint.

A piece of track, which is shown plainly in our engraving, gives a clear idea of the Johnson electric welding methods with branches off. This track has electrically welded chairs which promise to be widely used as they become better known. The catalog of interests includes also steel frogs, switch points, mates and a run off, all well arranged. Perhaps the most perfect piece

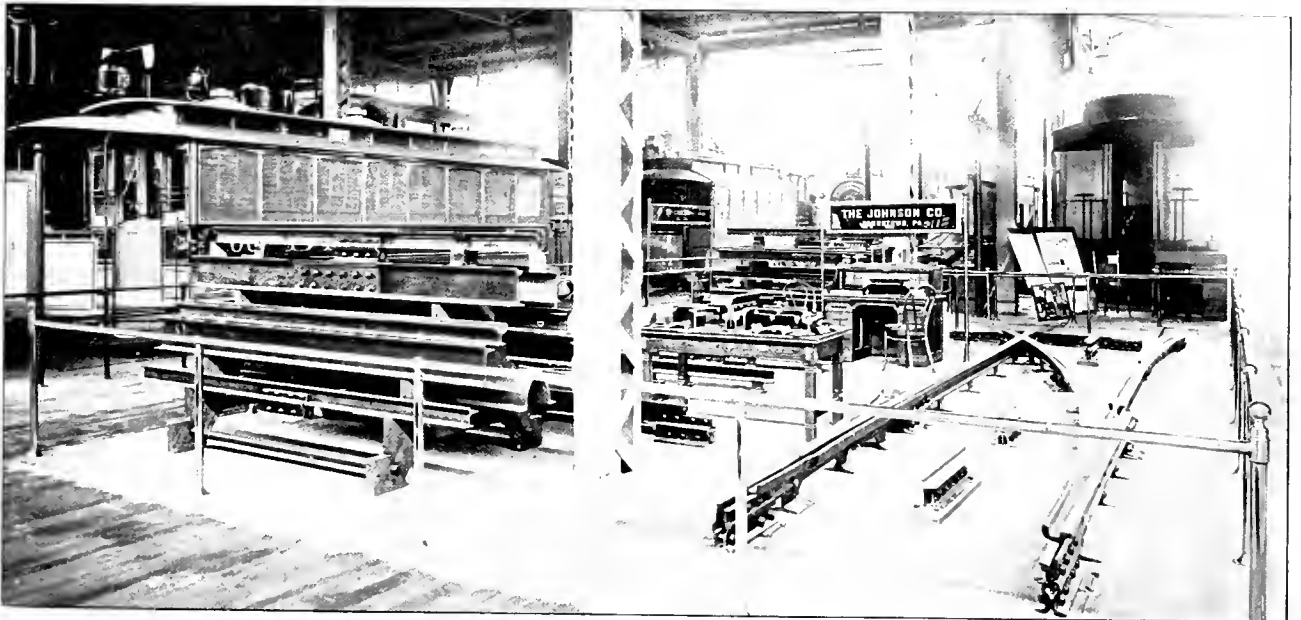

JOHNSON RAIL EXHIBIT.

up to 374-horse-power, and that with that load the engines regulate within one per cent. Each engine has an extra heavy band wheel, 96 inches diameter by 28-inch face, weighing 10 tons each.

FRANK X. CICOTT, whose efforts as managing director of the Railway World, of London, were so successful, has returned to this country, and will open an office in New York city as American agent for George Craddock Company, the manufacturers of cable rope for cable railways, and whose works are at Wakefield, England. These ropes are not unknown, being now in service on the North and West Chicago cable lines, and also used in Kansas City, Washington, Providence, San Francisco, and on the Brixton cable road in London and the extensive cable lines in Melbourne, Australia. Their exhibit at the World's Fair is a very creditable display and in charge of Mr. Shaw.

of electrical welding on exhibition is that of the Thomson Electrical Company in Electricity building. Here is shown an electrically welded curve cross with straight track running through it, made up, of course, of Johnson material. There is also displayed here an electrically welded crossing. Words of commendation of the Johnson rails are needless as they have long been known throughout the United States and are fully appreciated by the hundreds of roads whose experience has been universally voiced in continued and increased patronage.

A NEW bicycle railroad has been patented by Geo. F. Brott, of Washington, D. C. His plan is for an elevated single track line with light steel cars. The road bed is a series of iron columns with U-shaped tops. The car is carried on a single rail at the bottom of the U, while the arms act as supports.

WOOD'S ADJUSTABLE PIPE BRACKET.

THE bracket illustrated herewith was designed by M. M. Wood, Electrical Engineer, of the Ansonia Electric Company, Chicago. By referring to the illustration, it will seem that the bracket is adjustable, all parts being interchangeable. Ordinarily it takes two men to place pipe brackets in position on the poles. The Ansonia Company claim that this bracket can be hung,

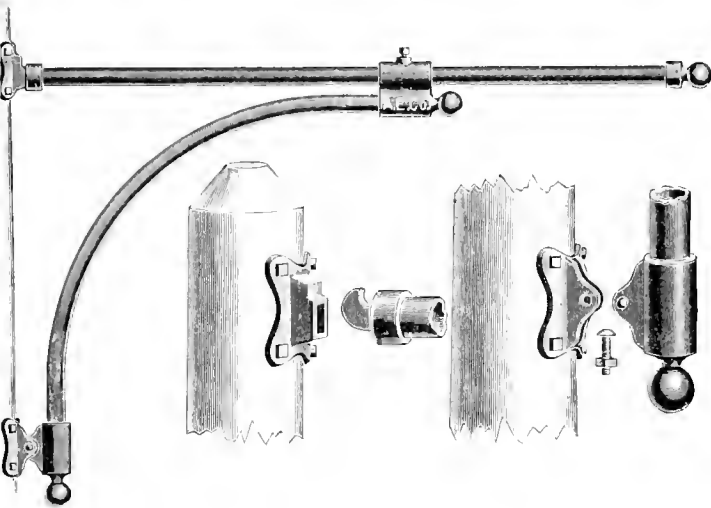

WOOD'S ADJUSTABLE PIPE BRACKET.

and placed in position by one man, and in the shortest time possible, as the upper castings can be placed on the pole before the bracket is placed in position. The bracket is made of $1\frac{1}{4}$ or $1\frac{1}{2}$ -inch pipe, and in 6 or 7 foot lengths. It is handsome in appearance, and its adjustable features recommend themselves to all electric street railways.

THE JUDGES IN TRANSPORTATION AND ELECTRICITY DEPARTMENTS.

WITHOUT any particular recalcitration against the edicts, ukases, and firmens, of John Boyd Thatcher, the Department of Transportation has organized its jury of awards and has gone to work in earnest. The consequence is that Transportation awards will be ready about September 1.

For the street railway group known as 81 there is not an American street railway man, although the STREET RAILWAY REVIEW DAILY, at the request of the department, asked for such nominations. The organization of the jury now stands:

Herrman von Littrow, president, Austria; Prof. Francis Elgar, vice-president, Great Britain; Capt. Conchas y Palau V. M., Spain, second vice-president; secretary, Professor Alex. Oldini, Italy; assistant secretary, James M. Lauder, United States.

To judge the street railway group under the following organization: Robt. Hudson, Australia, chairman; L. F. Loree, vice-chairman, and Prof. Alex. Oldini, secretary, the following have been called: Herr von Borries, Germany; Robt. Hudson, Australia; Hon. A. Haarman, Germany; Herr von Littrow, Germany; Prof. Alex. Oldini, Italy; F. M. Goss, Indianapolis; E. M. Herr, Riverside, Ill; Dr. B. D. Ulbricht, Germany; C. A. Barratoni, England; J. N. Lauder, South Boston, U. S.; L. F. Loree, Cleveland, O.; Chas. Paine, Englewood, N. J. These

are, with the exception of a few Germans, railway men, and no doubt competent, but a street railway man should have been nominated by the street railway exhibitors, as requested by the department.

In the Electrical Department a series of tests are being made which will aim at the most recondite research, and will not be completed until nearly the end of the Exposition. The Electrical judges are mainly professors of electrical engineering and a competent body of men.

The electrical judges are: H. S. Carhart, Ann Arbor; H. J. Ryan, Ithica, N. Y.; B. F. Thomas, Columbus, O.; Geo. F. Barker, Philadelphia; T. C. Mendenhall, Washington, D. C.; R. B. Owens, Lincoln, Neb.; M. O'Dea, Notre Dame, Ind.; W. M. Stine, Chicago; Samuel Raber, U. S. A.; H. O. Rowland, Baltimore; E. P. Warner, Chicago; Dr. Chas. Emery, New York; A. E. Dolbear, Tufts College; William Shrader, University of Missouri; S. B. Ayres, Tulane University; D. C. Jackson, University of Wisconsin; S. Thompkins, Clemson College; R. W. Pope, A. I. E. E.; R. W. E. Ayrton, London; George Forbes, London; Emil Rathenau, Berlin; D. Ulbricht, Berlin; Pierre Dehause, Belgium; A. Aschoff, Brazil; Ahmed Fahrari Bey, Turkey.

A BALLOONIST FALLS AND IS SAVED BY A STREET RAILWAY MAN.

HEROICS are right in the line of action for a street railway man, but few have had the opportunity that befell Mr. McCartney, of New York, who at present is constructing engineer for the electric railway at Norfolk, Va.

The opportunity arose from a balloon ascension, or rather arose from the descension of the balloon. The aeronaut was a woman. A stiff breeze was blowing as the balloon ascended, and before it had risen to a sufficient height to clear the surrounding trees, the navigator of the unstable atmosphere found herself lodged in the top of a huge Virginia pine tree, an hundred feet above the ground. Almost paralyzed by the danger of the woman, who sat motionless on a decayed limb, the crowd made no effort to rescue her, until McCartney sprang forward, saying to his wife "You go to the hotel," and throwing off his coat began to climb the tree trunk, nearly three feet in diameter. The woman, in attempting to move from her perilous position, snapped the tree limb upon which she hung and dangled in mid air. McCartney is a small man, but athletic and plucky. He made his way up the trunk, however, and in about an hour reached a position from which he could throw a rope to the woman; this she grasped, and was drawn to safety. McCartney was the hero of the hour. Tally one more for the deadly trolley.

THE officers of the Wilmington, Del., City Railway for the following year are: Preston Lea, president; Willard Saulsbury, vice-president; G. W. Bush, William Canby, Alex J. Hart and Edward Bringham, Jr., executive committee.

Street Railway for Sale.

The street railway in a growing manufacturing city of 25,000; 8 miles track, 11 cars; 65 horses; two good barns, one new, and all necessary apparatus. Franchise has 25 years to run under very favorable conditions. City growing rapidly. Present lines have a good business, but parties who purchase can realize a handsome thing by changing to electricity. Property is unencumbered, and very favorable terms will be made to right parties. Owner has other business interests which demand his time. Address,

"SPLENDID OPPORTUNITY,"

Care Editor STREET RAILWAY REVIEW.



WINDSOR & KENFIELD,

PUBLISHERS AND PROPRIETORS,

269 DEARBORN ST., - - - CHICAGO.

Published on the 15th of each month.

SUBSCRIPTION, - - - TWO DOLLARS.

FOREIGN SUBSCRIPTION, - - - 20 SHILLINGS.

Address all Communications and Remittances to THE STREET RAILWAY REVIEW,
269 Dearborn Street, Chicago.

H. H. WINDSOR,
Editor.

F. S. KENFIELD,
Business Manager.

CORRESPONDENCE.

We cordially invite correspondence on all subjects of interest to those engaged in any branch of Street Railway work, and will gratefully appreciate any marked copies of papers or news items our street railway friends may send us, pertaining either to companies or officers. Address:

THE STREET RAILWAY REVIEW,
269 Dearborn Street, Chicago.

Entered at the Post Office at Chicago as Second Class Matter.

This paper member Chicago Publishers' Association.

VOL. 3. SEPTEMBER 15, 1893. NO. 9

While our regular publication day is the fifteenth of each month, we deem the annual convention of the American Street Railway Association, which convenes on October 18, of sufficient importance to warrant us in holding our October issue back a few days. Hence, following our custom in previous years, THE REVIEW will appear the morning after the close of that meeting and will contain a full report of the entire proceedings.

THE New York and Boston dailies, which have drawn so many columns of reading matter from the rapid transit agitation in those cities, have suffered a relapse. In the meantime the present excellent facilities are carrying the masses as usual. The impotency of municipal ability to carry out such measures has been fully demonstrated. When additional facilities are secured to those cities we predict it will come from a private, not the public, corporation.

THE Street Railway Association of the state of Maine, recently organized, has fixed the date of its annual meeting in the month of February. The gatherings of the New York, Ohio, and Pennsylvania state associations, each occur the month previous to that of the American. Although the state meetings usually occupy but one day, it would seem that a date more remote from the other would, for several reasons, be advisable. Nearly all who attend the state meetings also are present at the big convention, and it would seem that a new date, say in the late winter or early spring, would bring the members together once in about six months.

SUNDAY will continue to be the Sabbath in Toronto, as the result of the recent election was against the operation of street cars on that day. How much longer the old time custom must remain in force is hard to say, as the defeat of the measure, which was confidently expected to pass, will be a severe disappointment to its friends. The street railway occupied a very manly position and refrained from pressing its own claims, resting on its offer to defray the cost of holding the election, for which the city had no available funds. The matter will now have to go over for a year at least and probably for a considerably longer time, but as to the eventual outcome there can be but one ultimate result. The vote was the largest ever cast, totaling over 27,000, and while the measure was defeated by a majority of 1,003, it was a gain of 3,000 for the Sunday cars over the contest in January last.

THE fuel record of a road operating forty cars, as illustrated and described elsewhere in this issue, discloses the fact that an increase in passenger load either on the motor cars or by addition of trailers, requires a scarcely perceptible increase in fuel consumption, while the addition of each motor car even with lighter load, causes a noticeable increase in fuel consumption. This would indicate that a two-car train once in six minutes is more profitable than two motor cars run on three-minute headway. The infrequency at which a car or train passes a given point should not be carried past the limit where people will walk rather than wait for a car, although from the standpoint of the company the saving in one motorman of the two-car train as against two motor cars would partly offset this loss. It has been the generally accepted opinion that single cars at short intervals earned vastly more than trains at long intervals, but it may be, a test of the relative fuel consumption might discover a heretofore unrecognized element in the question.

A COMPARISON will be found in this number between the earnings and expenses of the underground road in London and the elevated electric line in Liverpool. The figures seem all in favor of the elevated road, which costs to build but a little more than one-third as much as the other, while its earnings per train mile are greater and its expenses per train mile less. This too, in view of the fact that the underground has been three years getting its expenses down to their present figure of 6.48 pence per train mile, while the elevated, running but six months, operates for 4 pence. It is true the former have one more passenger car per train than the latter, but the earnings per train mile are still in favor of the elevated by nearly 2 pence. For the first six months of 1893 the underground paid a dividend of only three-fourths of one per cent per annum, and for the last six months of 1892 but five-eighths of one per cent per annum. Previous to that no dividends were paid. There is very little in the underground system to recommend it to either the financier or the passenger.

THE parting of a brake chain on a steep grade in Cincinnati allowed the car to run away, finally jumping a curve at the foot of the hill, and breaking a heavy telephone pole plunged into a saloon. Two persons were killed and many injured. Prior to the accident the company would have indignantly denied any intimation that its equipment was unsafe or incompetent. It may or may not have made as thorough and frequent inspection of the brake gear as it should have done. It is useless now to discuss those points. The lesson for every manager who is operating cars on steep grades, is to see that a like calamity cannot happen on his lines, and where reasonable precaution calls for it, provide a double equipment of brakes. It is startling to consider that a few cents worth of chain was all that held that car load of precious lives in safety, and when that gave way, they were left utterly helpless. There have been several similar accidents of late, resulting in more or less personal injuries, and one or two fatally. Something must be done, or the cities where such disasters occur will place restrictive burdens on the roads, which the latter will not relish. There are good brakes on the market in abundance, and while the above does not at all apply to many roads where every precaution has already been taken, there are more which it should be the means of awakening to their duty, and in this case individual interests as well.

THE general stringency in money matters has made itself felt since our last issue. Up to that time there had been comparatively few roads on which the riding had dropped to such an extent as to demand a reduction in the usual working force required during the summer season. The shutting down of many establishments employing large bodies of men, and the completion of a large amount of new work, without the inauguration of other new enterprises, has combined to render idle many thousands of employes. As is well known to every street railway man, but not so generally understood by the public, no business feels the financial condition of the masses quicker than the street railway. Not only is there an immediate falling off in the regular morning and evening rush, from the fact that otherwise regular riders have no work to ride to, but many others who still retain employment and are within walking distance, take to walking; the members of families, having less money to spend, visit the stores less frequently, and that large factor in profitable revenue, pleasure riding, suffers a still more radical reduction. In many of the large cities, and even more so in the smaller ones, reductions in operating force have already occurred, and the number of cars is being decreased in proportion to the reduced earnings. While the manager regrets any retrenchment in car service, the situation assumes a condition in which he has no choice in the matter.

ALL arrangements have been perfected necessary to afford the supplymen unsurpassed facilities for display at the Milwaukee convention. The scattering of

exhibits, which have filled the exhibit rooms and overflowed into impromptu sheds and the streets on previous occasions, will not be repeated this year. There will be ample room for all, and to spare. In this connection we would urge exhibitors to prepare and ship their displays several days in advance of what they did last year. At Cleveland the exhibit was in a chaotic and discreditable condition on the first day. By afternoon of the second day it was in fairly good shape to be seen, but was not really ready for business before the third day. Even then several car loads of material were being placed in position, while some exhibits were delayed in railroad transit, and were not even unpacked. It seems a pity, that when so much care and expense has been given to present something creditable, that it should be curtailed and robbed of its purpose by failure to ship in season. It is due the delegates, and certainly is policy, for exhibitors to have everything ready for inspection when the first session opens. This affords delegates abundant opportunity to visit and examine each exhibit, and warrants the expense. A poorly arranged or incomplete display reflects no credit on the firm making it, and the busy, hurried street car manager is apt to give such but a passing glance. The committee have provided everything that could be suggested in the way of space, location, power and facilities. The massing of everything under one roof will be specially appreciated, and it now rests with the exhibitor to do his part as well. Installation may be commenced on October 9.

ANOTHER year has rolled around, and so full of plans and work has it been to our readers, they, with us, can scarcely realize that next month celebrates the twelfth annual gathering of the American Street Railway Association. The importance of this meeting to every street railway man, be his interests large or small, was never as great as at present. It is of the highest importance that every railroad should be represented, and while none but member companies have a voice in the deliberations, all other roads are invited to attend and will be made warmly welcome. A board of directors can make no other investment return as large dividends as voting the necessary expenses to send one or more representatives to this convention. We put it solely on a business basis, although we know of very many cases where the recognition would be but a small one of untiring services, which through long nights and stormy days have been put forth uncomplainingly by superintendents and managers. By all means let the attendance be as large as possible, and those who come will not regret bringing their ladies also, as special provision is made for their comfort and entertainment during those hours when the gentlemen are in business session. The attendance already promises to exceed that of any previous year, the subjects scheduled for discussion are excellent and practical, and others which will arise will be equally so. A goodly number of street railway men from abroad are also expected. We suggest further, that those of our

readers who have been making experiments or adopting new departments in operation come prepared to exchange their experiences each with the other. In this way a vast amount of valuable information may be gathered.

AS every manager knows, there is a surprising scarcity of servicable data as to how other roads are operating. With the vastly increased volume of business which has accompanied the adoption of electricity, the necessity is the more apparent for each manager to satisfy himself that he is operating as cheaply as is possible in each particular case. At each of the last three conventions there has been expressions of strong regret that no two roads seemed to make up their expense statements on exactly the same basis; hence the ability to utilize what few records were available was rendered so uncertain as to become in many cases valueless. At the coming convention in Milwaukee a paper will be offered on this subject and which will undoubtedly prove a most valued and suggestive one. It would be a matter of real congratulation if it could suggest some simple division of accounts, and the association adopt them as standard. This would not necessarily imply any responsibility on the various member roads to change their method of accounts—although most of them could do so to advantage—but rather define a standard basis, on which each road could, from its present system of bookkeeping, make up a uniform statement of operating expenses, in which all would charge the same items to the same accounts. That this should be based on the cost per car mile is generally conceded. The hesitancy which exists on the part of many managers about giving out this information can hardly be considered as well taken. The only way this data can be obtained is by each one contributing his part. If in doing so some roads show a much higher ratio of expense than others, the discovery will certainly be of greater importance to such than to those which are running at less cost, and once a general average is established, it becomes the duty of the less economically managed lines to institute a rigid examination as to why this condition exists. It may be found that what at first glance seems high is, in fact, as low as can be secured under existing local conditions, and, again, it may be found that radical reductions must be made. We know for a certainty that not a few roads, in which wages and fuels should be the same, show a wide range of difference in the cost of running a car per mile, and yet a very small fraction of a cent in this difference amounts to a large sum in the course of the year. The steam roads have long since come to a definite understanding as to what constitutes the items of expense which go to make up the cost of operation, and the result has been of the greatest mutual advantage. There is no good reason why the street railways of the country, whose car mileage per mile of track is many times that of the steam roads, should longer deprive themselves of this data. In the interests of all let some decisive action be taken this year, and a basis of comparison started, which will increase in value with each succeeding month.

STREET railway organized labor has again given itself a black eye, by its defenceless and idiotic action at Indianapolis. The Grand Army encampment was in session and thousands of strangers were in the city. From unquestionable authority the company learned that conductors were taking advantage of the Grand Army men and collecting ten cents when the legal fare is but five, the extra nickel being knocked down. Two conductors were discharged, one of whom admitted the truth of the report. Thereupon the men on the line to the race track struck. The president of the Driving Park Club, in company with the mayor, visited the barns in an attempt to adjust the matter, if only for twenty-four hours. The strikers refused to accede to any arrangement which did not include the re-instatement of the discharged men. An hour later the men on the mule lines drove their cars into the barn. The men on the other lines refused to quit, be it said to their credit. Even were the men innocent, which the facts prove otherwise, the strike, at the time the city was filled with strangers, to whom its freedom had been tendered, and who necessarily required more than ordinary accommodation in transportation, was an admission that the union relied upon the unusual condition in which the company was placed rather than any justice in the strikers' claim. Right and wrong are respectively right and wrong and can never be anything else. No combination of circumstances which temporarily places either side in an unfair position to dictate terms, can change the fundamental laws of justice. The men, who had been receiving good pay from the company, seize upon the instant of its supposed helplessness to cripple it. In a few hours the visitors would all have left the city and then, if it could have been shown the company was wrong and the discharged men honest, it would have been time to demand re-instatement, and failing in this, to strike if only a strike would sustain their convictions. But no. On a moment's notice, without time to determine the innocence of the two discharged men, they quit. The fact that their act occasioned their employers great financial loss seemed worthy of no consideration. The fact that the good name of the city was to suffer by their action counted for nothing. Even all feelings of patriotism for the grand old heroes, whose stooping forms and battle-scarred visages told the pitiful story of exposure and suffering in the preservation of a Union of States and liberty, which has made unions of individuals possible, was all ignored. Shame on the men or union that can so far forget so priceless a debt. Shame on the members of an organization whose dictates require obedience to such commands. Shame on those who would win by might, not right, and on a "union" which is incapable of one throb of patriotism for the Grand Army of the Republic. And yet the walking delegates innocently feel aggrieved that managers "are not friendly to unions."

THE Connelly gas motor is being experimented with on the Croyden Tramway, as is also the storage battery—the latter with the usual success.

THE COMING STREET RAILWAY CONVENTION.

WHETHER so much of electricity and rapid transit has unconsciously entered our mode of life, or whether, as we grow older, the days grow shorter, like those of autumn, we may not know, but almost as a surprise will the announcement come to us all that but four weeks remain before the annual convention of the American Street Railway Association. This, the twelfth yearly gathering, will be held in Milwaukee on October 18, 19 and 20. The progress and growth which has marked the past eleven months promise to yield a corresponding advance in the interests, value and attendance of this meeting. In addition to our own constituency, quite a number of tramway managers from across the water have expressed their intention to be present.

The history of the organization and subsequent gatherings of the association has already been given in these columns and is familiar to our readers. We need only to mention the different cities in which the meetings have been held:

PLACE.	PRESIDENT.	YEAR.
1 Boston.....	Hon. Moody Merrill*.....	1882
2 Chicago.....	H. H. Littell.....	1883
3 New York.....	Wm. H. Hazard.....	1884
4 St. Louis.....	Calvin A. Richards†.....	1885
5 Cincinnati.....	Julius Walsh.....	1886
6 Philadelphia.....	Thos. W. Ackley†.....	1887
7 Washington.....	Chas. B. Holmes.....	1888
8 Minneapolis.....	Geo. B. Kerper.....	1889
9 Buffalo.....	Thos. Lowry.....	1890
10 Pittsburg.....	Henry M. Watson.....	1891
11 Cleveland.....	John G. Holmes.....	1892

* Chairman of organization.

† Deceased.

Membership in the association is vested in companies, not individuals, and while there were fifty-six delegates to the Boston meeting, the initial membership was but twenty-four companies. This number steadily increased until the membership has exceeded 200 during the past year.

RECORD OF MEMBERSHIP.

1882.....	24	1888.....	157
1883.....	62	1889.....	161
1884.....	102	1890.....	173
1885.....	123	1891.....	184
1886.....	140	1892.....	204
1887.....	152

Consolidations in many cities have largely offset the gain in new members, as frequently the purchase of several roads by syndicate has taken as high as four or five names and returned only one. But while the number of members has thus shown an apparently slow increase, the gain in number of miles of track and investment represented has been enormous.

The old time distrust which at first made it somewhat difficult to unite interests which were more or less competitive, has long since been removed, and the personal relations of the gentlemen of the street railway fraternity

was never so strong and honored. Indeed, it would be difficult to find in the representatives of any other great business interest stronger ties than those which bind the street railway managers of America, and the meetings of the association are anticipated with pleasure and remembered with satisfaction.

The program includes the following papers:

PROGRAM.

BEST METHOD OF LIGHTING AND HEATING STREET RAILWAY CARS.

G. F. Greenwood, general manager, Pittsburg, Allegheny & Manchester Traction Company, Pittsburg, Pa.

CAN THE T RAIL BE SATISFACTORILY USED IN PAVED STREETS?

C. Densmore Wyman, ex-vice-president, Central Park, North & East River Railroad Company, New York, N. Y.

DIRECT DRIVEN GENERATORS.

C. J. Field, electrical engineer, New Jersey Traction Company Newark, N. J.

POWER HOUSE ENGINES.

E. G. Connette, general manager, United Electric Railway, Nashville, Tenn.

L. H. McIntire, engineer, Atlantic Avenue Railroad Company, Brooklyn, N. Y.

F. S. Pearson, engineer, West End Street Railway Company, Boston, Mass.

STANDARD FORM FOR STREET RAILWAY ACCOUNTS.

H. I. Bettis, assistant treasurer, Atlanta Consolidated Street Railway Company, Atlanta, Ga.

STANDARDS FOR ELECTRIC STREET RAILWAYS.

O. T. Crosby, Boston, Mass.

Chas. W. Wason, general manager, Cleveland Electric Railway, Cleveland, O.

L. H. McIntire, engineer, Atlantic Avenue Railroad Company, Brooklyn, N. Y.

Thomas H. McLean, superintendent, Citizens' Street Railway, Indianapolis.

C. G. Goodrich, secretary and treasurer, Twin City Rapid Transit Company, Minneapolis, Minn.

STORAGE BATTERIES IN CONNECTION WITH CENTRAL STATIONS FOR UTILIZING SURPLUS ENERGY FOR LIGHTING OR POWER.

C. O. Mailloux, electrical engineer, Metropolitan Railroad Company, Washington, D. C.

In addition, there are other features which can not be announced until the meeting convenes. In the line of entertainment General Manager Payne, of the Milwaukee Street Railway, has provided facilities and attractions which will profitably demand every spare minute.

Arrangements for exhibits have never been as good or the space as large. Both sessions and exhibits will be under one roof in the splendid exposition building, where power, both electrical and steam, will be furnished in abundance. The building is within easy walk of all the hotels, but Mr. Payne will run special cars at frequent intervals for the accommodation of the visitors.

Everything possible has been done by the committee and it only remains for the delegates and exhibitors, by their presence, to make this, as it promises to be, the most important gathering of this highly important organization.

THE PRESIDENT.

TO be chosen as the chief executive of an organization representing as many hundreds of millions of capital as does the American Street Railway Association, is an honor of which any man may justly feel proud.

D. F. Longstreet is specially worthy of the distinction from having been the prime mover in its organization, and an active worker in it ever since. He was born at Killingly, Conn., in 1846. His education was acquired in the east, where the most of his life was spent. At the age of sixteen, or, in 1862, he entered the federal army



PRESIDENT D. F. LONGSTREET.

as a private, serving until the end of the war. At the time of discharge he was nineteen years of age, and without any visible means of support. Nothing daunted, however, he applied for the first position that came to hand, which was that of a conductorship of the Providence, R. I., Street Railway, in which capacity he served seven months. His superiors, however, recognizing in young Longstreet ability and probity, gave him the position of clerk in the general offices, where he spent four years. After which he became successively secretary, treasurer, vice president, and general manager. This was the history of his life for nineteen years. In 1888 Mr. Longstreet removed to Boston and became connected with railway interests there. For the past few years Mr. Longstreet has resided in Denver, Colorado, where he built the West End road about two years ago, of which he is now president.

The reader must see between the lines of this incomplete sketch of Mr. Longstreet's life the hard work, business tact and ability that has raised him to his present position; and must imagine the opinion of his contemporaries in the street railway world by the incident of his election to the highest honor within their gift.

THE SECRETARY.

THE annual appearance of Secretary W. J. Richardson before the American Street Railway Association since the beginning, 1882, has made him the most widely known street railway man in America, while his unfailing kindness to new members and his whole-souled greeting of the old, have made his popularity as large as his acquaintance. His unswerving devotion to his arduous duties, and his recognized ability, make him par excellence the man to fill the position.

Mr. Richardson has been in street railway work all his business life. In 1876 he began by assisting his father in his railway business in Brooklyn, where he remained two years. Then followed a three years course in the collegiate department of the Brooklyn Polytechnic and Collegiate Institute. After graduating, he became superintendent of the Brooklyn, Carnarsie & Rockaway Beach railroad and steamboat line, which position he filled one year and resigned to join his father in operating the Atlantic Avenue lines, then known as Atlantic Avenue, East New York & Greenwood Railroad. When, in 1872, this company was reorganized, Mr. Richardson was elected secretary, which position he held continuously until the transfer of the property.



SECRETARY W. J. RICHARDSON.

In 1873 he married Miss Mary C. Raymond, daughter of J. H. Raymond, L. L. D., president of Vassar college. Mrs. Richardson usually attends the Association meetings.

When, in 1882, the American Street Railway Association was organized, Mr. Richardson, quite against his will, was forced into accepting the double office of secretary and treasurer, which position he has held ever since, also acting in a similar capacity for the Street Railway Association of New York State, formed in 1883. To say that he has contributed more than any other to the success of both associations is but poorly to express the service he has rendered.

THE EXECUTIVE COMMITTEE.

THIS committee, which includes the president and secretary, ex-officio, is the board of directors which practically shapes the policy of the association, and, holding at least two meetings each year, transact a large amount of necessary business which would otherwise occupy much valuable time of the hundreds of delegates. It makes an annual report which is a most valued document, reviewing the past year, and showing the trend of events to come.

In addition to the president and secretary, the members for the present year have been as follows:—

JOHN D. CRIMMINS, of New York, president of the New Jersey Traction Company, and one of the most prominent men in New York City, was born in New York, in 1844. His father was an engineering contractor, and Mr. Crimmins has from the age of sixteen until recently followed the same line of work. He has been for many years the great contractor of New York, having charge of all the larger public works. It is only at a late date that he has entered the field of street railway operation, as distinguished from construction.



JOHN D. CRIMMINS.

JOHN G. HOLMES, of Pittsburg, was born at Pittsburg, the city in which he has been connected with the street railways since 1859. The Citizens' Passenger Railway Company, with which he began, was the first west of the Alleghenies. In 1871 he became treasurer of that company, and in 1888 president. He was president of the association in 1891-2, and has always been among its foremost men.



JOHN G. HOLMES.

T. J. MINARY, of Louisville, is president of the Central Passenger Railroad Company, of that city; general manager of the Louisville Railway Company and president of the Consolidated Street Railway Company of Springfield, Ill. He was born at Versailles, Ky., in 1850, and began his street railway career as secretary of the Central Passenger Railway Company, in 1872. While giving his energies to the building up of this enterprise he also became general manager of the railway company, which is a consolidation, controlling all Louisville lines.



T. J. MINARY.

JOEL HURT, Atlanta, Ga., is president of the Atlanta Consolidated Street Railway Company. He was born in Russell county, Alabama, in 1850. Left without home



JOEL HURT.

or support at the age of fifteen, he worked his own way through academy and college, graduating as civil engineer from the University of Georgia in 1871. For nearly ten years after graduation he was on engineering work with various southern railroads. He has since entered the financial world with great success, being one of the best known men in Georgia, and at

the head of numerous insurance and land companies, besides having developed into a very practical street railway man.

DR. A. EVERETT, of Cleveland, president of the Cleveland Electric Railway Company, was born in Trumbull county, Ohio, in 1821. He bought control of the East Cleveland road in 1860, when the equipment was two miles of track and four "bobtails." From the \$49,000 property of that time to the magnificent consolidation of to-day is a long step, in which Dr. Everett has, until recently, maintained his position at the head of affairs, having retired from active life since last convention. He still takes as lively interest as ever.



DR. A. EVERETT.

J. R. CHAPMAN, Grand Rapids, Mich., is vice-president and general manager of the Consolidated Street Railway Company, Grand Rapids, and of the South Chicago City Railway. He was born in Boston and educated for a civil engineer. Coming west in 1877, he worked for the Missouri, Kansas & Texas Railway until 1881, and then for the Denver & Rio Grande until 1888. In that year, in connection with other enterprises



J. R. CHAPMAN.

in Kansas City, he took up the management of a road there. He went to Grand Rapids in 1891, consolidating the various lines there and adopting electricity. His latest venture is the South Chicago City Railway, completed last spring, and known as one of the model plants of the country.

B. E. CHARLTON, of Hamilton, Canada, president of the Hamilton Street Railway Company, was born in the log cabin of an English settler in the Province of Ontario, in 1835. He has passed through the various positions of farmer's boy, school teacher, successful manufacturer,

railway director, steamboat company director, president of the Hamilton board of trade, councillor, alderman, mayor of Hamilton (three terms), and for eight years has been president of the street railway.



B. E. CHARLTON.

His regular attendance at the conventions, and his long experience in street railway and other work requiring strong executive ability make him a fitting representative of the Canadian membership.

W. WORTH BEAN, of Benton Harbor, Mich., is president of the St. Joseph and Benton Harbor Electric Railway & Light Company. Thirteen years ago Mr. Bean left a wholesale shoe house of Cincinnati, to take charge of the Dayton & Newport Street Railway. Before going to St. Joseph in 1889, he sold this road to the South Covington & Cincinnati. At St. Joseph he soon gained control of the electric lighting of the two cities, and in 1892 built the road of which he is now president.



W. WORTH BEAN.

YE OFFICIAL STENOGRAPHER.

WE present the portrait of a face familiar to all who attend the conventions. It is that of T. E. Crossman, the stenographer. He was born in London, England, January 23, 1863. Mr. Crossman has been connected with the association from the time it was organized, and first began his reporting of the conventions in 1884, when the third annual meeting was held in New York City. He has also reported the meetings in Philadelphia, Washington, Minneapolis, Buffalo, Pittsburg and Cleveland; and all who have received from him a transcript of their remarks for correction, can testify to his accuracy. He has reported all the meetings of the Street Railway Association of the state of New York for the past ten years. Mr. Crossman has also reported the last two meetings of the National Electric Light Association, held in Buffalo and St. Louis, and of the American Water Works Association, held in New York city and Milwaukee.



T. E. CROSSMAN.

His office naturally places him in a position where he renders many appreciated courtesies to the press and delegates, with all of whom his genial manner has made him warm friends.



MILWAUKEE EXPOSITION BUILDING WHERE CONVENTION WILL BE HELD.

THE report of the Birmingham Central Tramway-Company, which operates steam, cable, horse and storage battery cars, shows that during the past year steam cost 11.22d. per mile run; cable cost 6.32d. and horses 10.12., while the much vaunted storage battery cost 16.55d., with receipts at 16.55d. per mile run.

AUGUST 15 saw the opening of electric railway at Essens, Germany. Ten cars were started on trial.

LIVERPOOL tramways and omnibus directors say that they will "make another attempt to apply electric power as a means of haulage of tramway cars."

HISTORY OF RAPID TRANSIT IN MILWAUKEE.

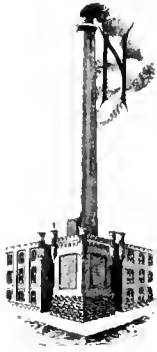

THOSE good old days of Solomon Juneau the favorite and very safe method of intramural transit in Milwaukee was by foot. It is true that this method was not rapid, but it was very safe. No one was seriously injured at grade crossings and a live wire was unknown. Of course a "ground" some times brought grief to the slow but sure method, when Solomon fell down over one of his neighbors pigs on Wisconsin street; but prairie sod is much easier to fall on than is cobble stone pavement, and we may suppose that Solomon arose, kicked the pig, said "sacre" or some other equally expressive swear-word Francaise and proceeded on his way to the corner grocery.

In those Arcadian days, when Juneau and his bold compeers were tenants-at-will of the noble red man, the double tracked cowpath and the double reduction ox did service for freight and passenger traffic between the few and widely separated neighborhoods.

There were long years of growth before Milwaukee was ready for a street railway line, and many more years of development before electric traction was ready for Milwaukee.

In 1859, so the oldest inhabitant informs us, the subject of street railways was first broached and finally, in the course of a twelvemonth, the River & Lake Shore Railway was built. The first ordinance authorized the River & Lake Shore Railway Company to build and operate in the first, seventh and eighth wards, and on May 30, 1860, the first bobtailed car developed four miles an hour and a most tremendous ovation from the 30,059 proud souls of Milwaukee. John Lockwood was the organizer of this pioneer company, and his faith in the city has been well realized in the magnificent electric systems that greet the American Street Railway Association in 1893. Alexander Easton, of Cincinnati, became the first street railway builder in the Cream City, taking the contract and furnishing the first line of single track on East Water street, or Walker's Point Bridge, as it was then styled, to Division street, now Juneau avenue. Geo. H. Walker, Dr. L. W. Weeks, W. J. Johnson and F. S. Blodgett were the elements of the first company, and Mr. Walker, Milwaukee's first street railway manager.

In 1863 the city council passed an ordinance authorizing the extension of the road on the south side of Walker's Point Bridge to Ferry street, on Ferry to Lake, on Lake to Clinton, on Clinton to Florida, on Florida to Hanover, on Hanover to Elizabeth, on Elizabeth to Sixth, on Sixth to Mitchell, on Mitchell to Forest Home, on Forest Home to the cemetery. The franchise was carried out later.

The Milwaukee City Road succeeded the River & Lake Shore Company. This new institution was organized and promoted by John Plankinton, Frederick Layton, Samuel Marshall, Charles F. Hsley and Walter S. Johnson, all well known names in the Milwaukee of to-day, and each leaving to the city a greater legacy in business enterprise and development than perhaps any other set of contemporaneous business men. The capital stock was set at twice that of the acquired company, namely, at \$100,000. W. S. Johnson became manager of the new corporation, and the routes given by ordinance variously modified to suit the increasing size and importance of the city. Isaac Ellsworth became owner of the Milwaukee City's rights and properties in 1869.

Extensions for the next few years were neither numerous nor rapidly pushed, and not until 1875 did the street railway building attempt to keep pace with the necessities of the case. Between 1875 and 1881, however, a number of lines were built, including the double tracking of the National Avenue Line and the betterment of existing routes. During these years tracks were removed from Ferry, South Water, Florida and Greenbush streets.



St. P. Brown

In the autumn of 1881 Peter McGeogh took the reins of the Milwaukee Street Railway, as owner and manager. With commendable enterprise and public spirit, Mr. McGeogh began at once the making of the system what it is to-day. He extended the National Avenue Line to National Park, the Walnut Street Line to the city limits and the Third and Eighth Street Lines to the north boundary of the municipality, besides building several other lines outright. Under the improvements the value of the road rapidly appreciated and became known to eastern capitalists. On December 1, 1888, Wall street men became owners, buying the property at \$1,500,000. In August, 1890, the Villard syndicate became the owners, uniting it with

THE CREAM CITY LINE,

which was incorporated in 1874, in the leafy month of June, by F. B. Van Valkenburg, Jas. B. Turck, J. B. Hoes, Ed. C. Wall and H. S. Mark. Taking up the streets abandoned by the Milwaukee City Company, the Farwell Avenue, Ogden, Jackson and Mason Street Lines were put in operation in 1875. New lines built on East Water street from Juneau avenue across the East Water street bridge to Clinton street, down Kinnickinnick. The Forest Home line was built in 1877, and ten years subsequent all the Cream City Lines were in operation. The first manager of these lines was James B. Turck, who acted with F. B. Van Valkenburg, the first president. Winfield Smith, the prominent Milwaukee lawyer, became president of the Cream City until the absorption by the syndicate.

In April, 1890, the road was sold to a Pittsburg syndicate for \$777,000, and again finally transferred to the Villard syndicate in August of the same year in consideration of \$850,000.

THE WEST SIDE ROAD,

known as the Becker line, was organized in 1874, by John Tesch, John Plankinton, S. W. Green, S. S. Merrill, and S. S. Harrison, with Mr. Tesch as the first president. Franchises were granted on several west side streets, with subsequent ordinances dated 1876, 1879 and 1880, with rights to double track and extend original grants. Washington Becker has been at the head of the line since 1875, and for many years T. J. Durbin has been manager. The road is under agreement to sell to the syndicate lines and two-thirds of the purchase money has been transferred. On the third payment the organization will disband.

THE PFISTER LINE

has a history. In common with all things and men who have histories it is interesting, and consists in ups and downs of various gradients. The line has been almost endlessly in litigation, was the first to apply electricity, and is now in the hands of Receiver Melms, waiting for quiet and consolidation. John A. Hinsey paved the way for electricity, by gaining a franchise in 1888 for a street railway line. The fight for the franchise was an exciting one and the franchise called for the cabling of the streets granted. The Rasmussen cable was suggested as the proper method, but upon the failure of that design in New York the idea was abandoned. In 1889, during an eastern trip, Mr. Hinsey first became interested in electric power, which was then just coming into commercial use. This was in 1889, and in 1890, thanks to Mr. Hinsey's strenuous efforts, the franchise was amended to allow the new power. Rapidly following upon the heels of the grant, 1891 saw the operation of the first electric railway in Milwaukee.

Mr. Hinsey owned 40 per cent of the stock and Mr. Hinckley the remainder, and as the latter did not wish to advance more money, the road was given over to Charles Pfister, on a loan of \$120,000. November 27, 1892, G. J. Melms was appointed receiver, and June 30 of this year the line was formally bought by Charles Pfister, preparatory to a transfer to the Consolidated.



THE OLD MILWAUKEE.

TIME was when cities grew; by natural increase and according to their necessities they spread over the earth and occupied the land. No cunning surveyor drove his stakes where streets and alleys, avenues and boulevards should run. No town lot speculator or subdivision father decreed the names of the thoroughfares or baptized the settlement. Names of streets arose from popular tradition, and settlements acquired their names from circumstances, and the people took their names from the settlement. Such is London, not made by man but by time. So the streets are crooked and their names outlandish. Threadneedle street, Maiden lane, Whitechapel and Rotten Row are all growths, and many families have taken as their patronymic the name of London. With the new world this is different. New York and Boston are more growths than the rest of the cities of the United States, but the majority of our western municipalities are made out of hand.

Milwaukee is partly a growth and partly a product of the city builder. Down near the center of what is now the business portion of the city, the grown part is easily recognizable, while further out along the magnificent avenues of trees and grass lined boulevards, the city-builder's cunning hand is seen.

Such in general is the history of the Cream City. No baptism of blood; no horrible massacres; no strife between the original possessor and the aboriginal owner.

Peaceful possession, generous growth, power, and plenty, such is the history of Milwaukee.

Although the actual settlement of the place dates back only to 1834, the locality was known and designated by the same name at least a century and a half before that time.

The first white settlers in what is now the state of Wisconsin were found at Green Bay, then called La Baie des Puants, where Canadian fur traders had founded a post, followed by the intrepid Jesuit fathers in 1660.

Think, reader, this was less than two hundred years after the discovery of the new world, and little more than two hundred years ago Father Marquette and Sieur Joliet, one bearing the cross and the other the sword, started down the Fox and Wisconsin rivers to the Mississippi. This was in the spring of 1673.

Their return was through the Illinois and the Chicago rivers to Lake Michigan and then coastwise to Green Bay. Undoubtedly the good priest visited Milwaukee at this time, but he says nothing about it as he probably did not observe the Pabst building or stop at the Pfister Hotel.

The next year Father Marquette left Green Bay, bent on establishing a mission on the Illinois river, traveling along the coast to the mouth of the Chicago river, where he was taken ill and detained until the following March. During the journey he stopped at a place which must have been Milwaukee.

Father Claude Allouez followed the same route two years later, carrying the faith to the Indians on the shores of what was then called the "Lake of the Illinois."

Zenobe Membre, a Recollect friar, set out from Green Bay in 1678 to labor among the Indians, taking as his particular field the Illinois. In his party were several distinguished names which have come down the pages of history as household words, Sieur de la Salle, Father Louis Hennepin and Gabriel de la Ribourde, with a number of Indian attaches. A relation of his adventures, published in 1680, tells of a tribe dwelling on the banks of the river Melleoki, which, it may be easily seen, despite the strange orthography, is none other than the one on whose banks now stands the Cream City.

Nothing more is heard of the place until Lieutenant James Gorrell, of the British army, remarks in his journal, kept at the military post of Green Bay, a tribe of Ottawa Indians who lived at Milwacky, and to whom traders regularly come.

The name went through a later modification when in 1817 Samuel A. Storrow writes in his journal that a large tribe of the Menominee Indians were gathered on the Millewackie river. The most reliable derivation of the name is from the Pottawatomic tongue, and means the gathering place by the river. As to the spelling of the name, sectional ill feeling was a cause of division into two orthographic centers. The west side spelled the name *kic* and the east side chose *kee*. The laws, when published, settled it to *kee*, but it was openly charged that the printers were bribed. *Kic* won the day, however, and only one paper, the Milwaukee Sentinel, stuck to the name as fast as the Boston Traveller does to two "P's." Finally, one night the spelling reform enthusiastically broke into the Sentinel composing rooms and abducted every "i", upper case, lower case and italic, in the shop. That settled it, and the Sentinel appeared i-less the next day.

The year 1784 saw the establishment of a trading post at the Milwaukee's mouth, with a few huts and a shiftless band of Indians as habitants.

A few scattering traders and artisans kept the site of the city until, in 1818, Solomon Juneau took charge of the trading post

and became really the founder of Milwaukee. Solomon, with luxurious tendencies and a large family, built unto himself and progeny a log mansion, a likeness of which is found in the text.

Juneau was an upright, open hearted man, with an unlimited confidence in human honesty, which led to his financial downfall, and he who might have been the owner

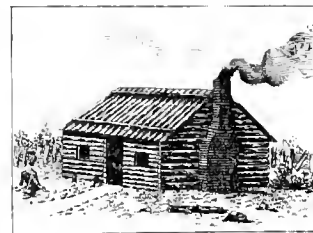

FIRST HOUSE IN MILWAUKEE.

of untold millions died poverty stricken in 1856, among the Indians, who were his first and best friends. The Blackhawk war, of 1832, nearly ended in a general massacre of the remainder of the white population. Only the coolness of Mrs. Juneau, and her remarkable influence over the Indians, averted the calamity, while the greater number of the men were attending a land sale at Green Bay.

So the settlement grew and began to attract others from Chicago and Green Bay, both older and wealthier places.

In 1835 came two men who share, with Juneau, the honor of being the founders of the city, George H. Walker, who came from Chicago with a stock of dry goods, and Byron Kilbourn, who came from Ohio as a United States land surveyor. Kilbourn selected an eligible site on the west side of the river and founded the village of Kilbourn, afterwards known as the West Side. Immigration was now started and the three villages named after their founders were rapidly growing.

Juneau became first postmaster in 1835. Milwaukee Smith, the first full blooded white child was born this same year. On September 19 of this year, the township of Milwaukee held its first election and thirty-nine persons exercised the right of suffrage.

Since then Milwaukee's history has been within the memory of citizens now living, who have seen Duck island grow into a magnificent building and the marsh covering the Fourth ward filled with dry homes. No brick helped the early settlers and the unbroken forests only, supplied the needs of the architect and builder. On the West Side progress was as rapid, and rapid growth ended in phenomenal increase.

The year 1837 brought a panic and a set back which would have destroyed a less solid settlement. The consolidation of the various villages in May, 1839, mark the real beginings of the city, and efforts were made to bridge the river. This ended in a hot war, mob rule and riots of several grades of rancor and hatred. In 1846 Solomon Juneau was elected mayor of the city of Milwaukee, incorporated that year with 9,500 inhabitants.

The improvement of the harbor facilities of Milwaukee began to be agitated in 1835, but not until 1855 was the

work properly done, and until 1876 the improvement was prosecuted.

The Milwaukee and Mississippi Railroad began work in 1849, and in 1857 the Father of Waters was reached at Prairie du Chien. This was the moderate beginning of the Chicago, Milwaukee and St. Paul.

The crisis of 1857 crippled the city's credit and set back its growth, financially, several years.

The city has suffered fifty-eight destructive fires since the first conflagration wiped out Sam Brown's house in 1836. The losses ranged from \$25,000 to \$1,000,000,



MILWAUKEE IN 1859.

and include the twice burning of the city records. The first church was organized November 19, 1836, and was of the Baptist denomination. Since then, thirty houses of worship have been built. The first bank was the bank of Milwaukee, chartered in 1836 and repealed in 1839. Of the famous breweries, the Lake, established in 1840 by Owens & Company, was the first. The first propeller was launched in 1842, she was called the Vandalia. The first newspaper was the Sentinel, issued June 27, 1837, and made a daily January 12, 1850.

So hath Milwaukee grown and waxed great, as is shown in another article on the Milwaukee of to-day. Here is a romance. True, of the practical type, but still a romance of men, growth and grit. It will be found to date when the Milwaukee of to-day is taken up.

* * * * *

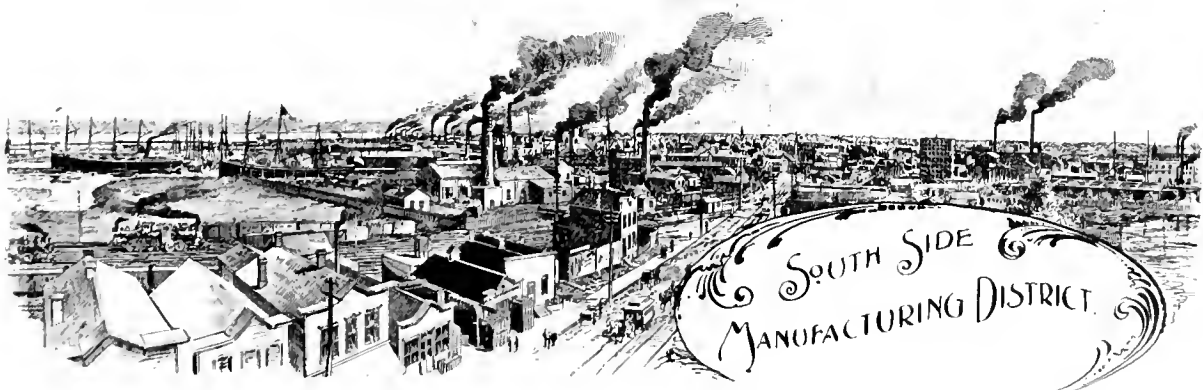

MILWAUKEE OF TODAY.

FROM the days of Solomon Juneau to those which the American Street Railway Association will spend in Milwaukee in October, 1893, covers a long period, in which the great city has developed and become known over all the world. Its location for both mercantile and residence purposes was happily chosen, and the business districts are well concentrated and accessible. Tall office buildings with all the modern conveniences are numerous and are best described in our illustrations. Residences all bespeak that air of prosperity which comes

capital invested in the city is extremely small, being but $8\frac{1}{2}$ per cent. This insures a proud and active interest in the home industries, as will no other single influence.

AREA AND PAVING.

The city is unusually compactly built and comprises an area of only twenty-one square miles within the limits. The prominent streets are very generally and well paved, there being 52.5 miles paved streets, 40 miles of paved alleys and 200 miles otherwise improved. Two-thirds

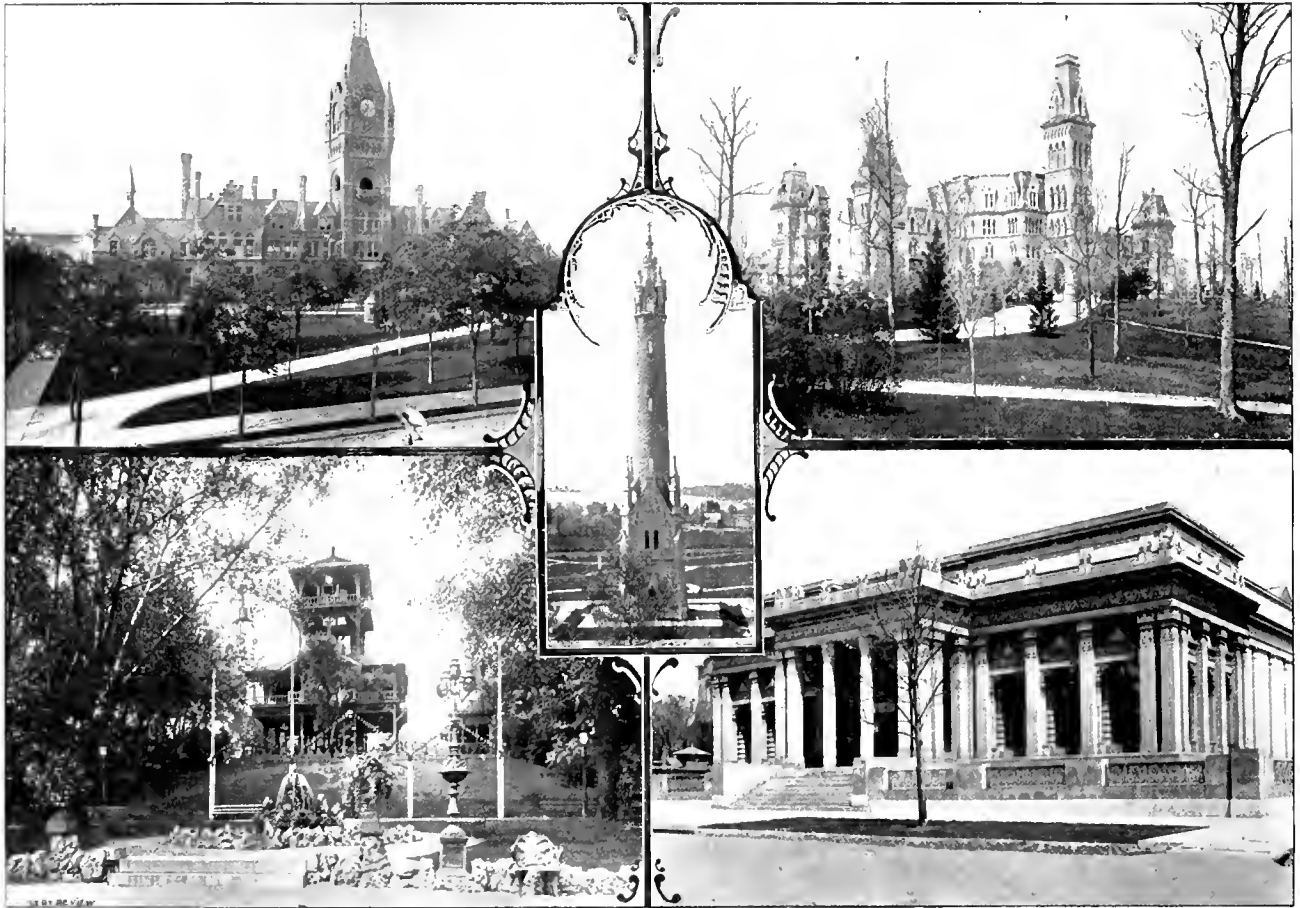

THE MILWAUKEE DEPOT
SCHLITZ PARK.

WATER TOWER.

THE SOLDIERS' HOME.
LAYTON ARI GALLERY.

from ownership by the occupant. It has long been known as a city of homes, to which the large number of costly mansions have added a reputation which other cities have envied. This steady and rapid growth is bringing it into greater prominence each year.

When a city has advantage of mineral wealth, of cheaper water-way transportation, and a rich agricultural, grazing and timber country combined, its growth is guaranteed.

Milwaukee is pre-eminently a self-contained institution. Its business and manufacturing interests, like the city itself, are the result of a natural and healthful growth, and were not forced or "made." The ratio of outside

are of cedar block and one-third granite. No asphalt is used. The present law assesses the first cost of paving on the frontage, and repairs and repaving on the entire ward in which it is. This has led to considerable cheap work where streets were paved for the first time, and the law will soon be changed.

WATER AND SEWERAGE.

The two features of utmost importance to every city are specially well provided for. The water supply is now drawn from an intake 2,220 feet out in the lake and distributed through 250 miles of mains. The principal pumping station is on the shore at North avenue, which deliv-

ers to a standpipe and also to a reservoir on the west side, 148 feet above the lake, from which point it is again pumped to still higher districts. The daily supply amounts to 21,500,000 gallons. A new intake is being built farther out in 62 feet of water.

The 240 miles of sewers all empty into the rivers, and to thoroughly flush the Milwaukee river there has been built the largest individual pump in the world. It delivers each twenty-four hours 450,000,000 gallons, which are discharged into the river at a point three and a half miles from its mouth, thus effectually flushing it at all times. The largest day's record for this work is 520,000,000 gallons.

the southwest, which joins the Milwaukee at its outlet. These afford 12 miles of navigable water, with a depth of 17 to 18 feet throughout the year, and lined with 22 miles of docks. The rivers are spanned by 26 draw-bridges and three stationary bridges. Five are turned by electricity, furnished gratuitously by the street railway company from their trolley circuit, and the others will be electrically equipped in the near future. It is customary to turn a bridge by electricity in one-fourth the time required by hand. Current is led to the bridge motors through a submarine cable. Several are now turned by steam, but will soon be changed to electricity.

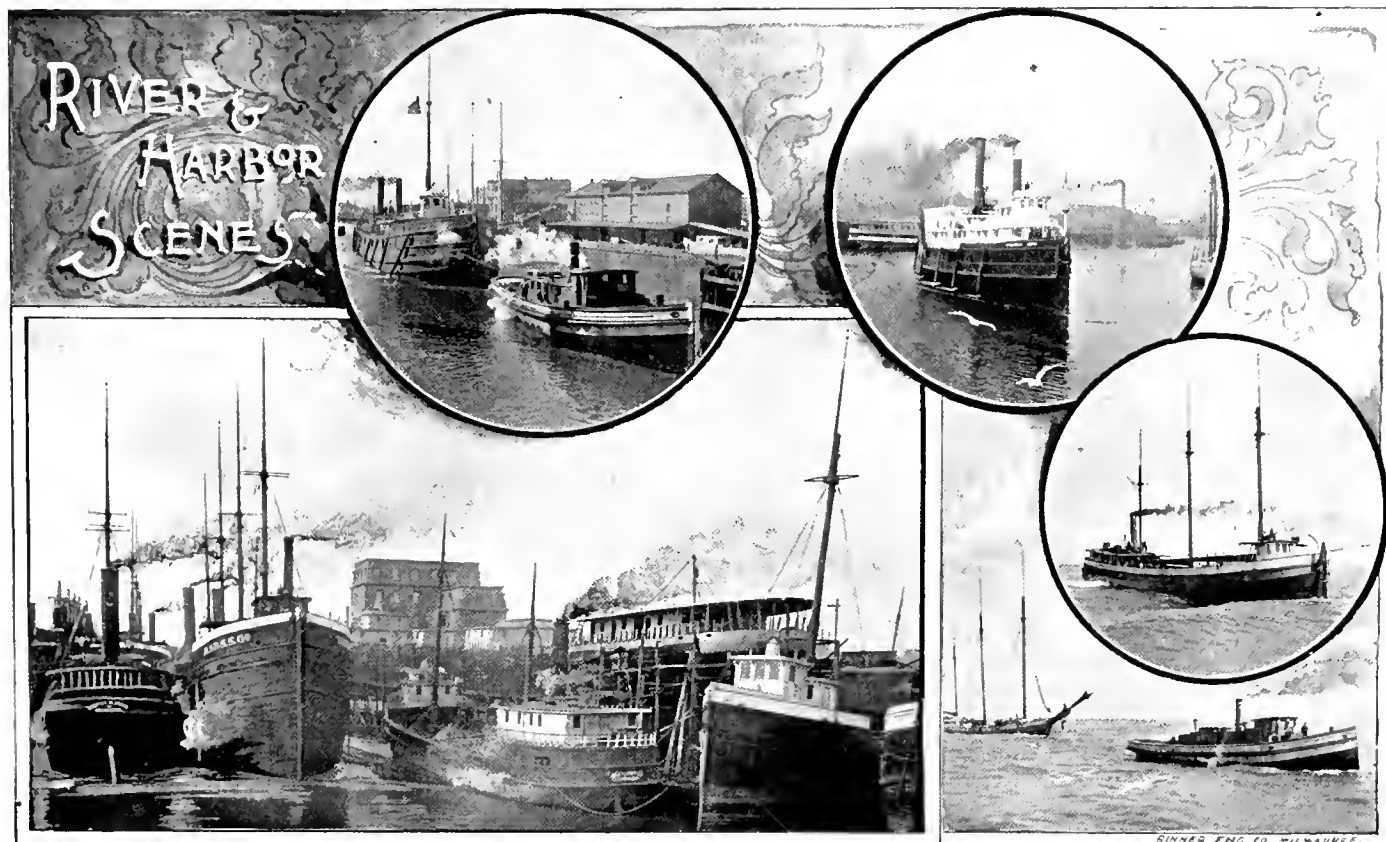

SCENES ALONG THE THREE RIVERS.

CITY LIGHTING.

The city is well lighted, by both gas and arc lights, the latter being furnished under yearly contract with the city at a price of \$110 per lamp per annum. Electricity for business and residence purposes is chiefly furnished by the Edison Electric Illuminating Company and the Badger Electric Light Company. There are many large and interesting isolated plants in the big breweries, hotels and manufactories.

RIVERS AND BRIDGES.

All Milwaukee is divided into three parts by its three rivers. The Milwaukee from the north; the Menomonee from the west, which joins the former a half mile from the mouth of the Milwaukee; and the Kinnickinnick from

THE LAKE MARINE.

As the lake provided the pathway which led the first settlers to Milwaukee, so that lake was naturally the means of their communication with the older civilization of the east, and later with the other cities which became neighboring ports. For many years, in fact, until the steel construction supplanted wooden hulls, ship building was one of the prominent interests of the city. As early as 1836 two steam lighters were built for transferring freight over the bar at the mouth of the river. They were built by Mr. Hubbell, were named the Menomonee and Badger, and were the first vessels launched here. Finest oak timber was abundant in the great forests which extended back from the lake, and as late as 1849

Capt. Clow built the schooner *Honest John*, appropriating all the timber necessary from the forest without the slightest protest from the owners. Vessel building steadily increased, until in the '50's a vessel was launched complete, fitted out in just 46 days from the time of laying her keel. During the war the *Christie* was turned out, and passing through several owners, finally was purchased and put in commission as a blockade runner, but was at last captured and destroyed by a United States cruiser between the West Indies and a Southern port.



THE PABST BUILDING.

At one time two of the yards ranked among the largest on the lakes, and vessels were built to cross the ocean. The last steamers were launched in 1891.

The harbor is one of the best on the lakes, and thirteen lake transportation companies, using over 80 steamers, make this one of their chief receiving and discharging ports, and 150 vessels winter here every year. The harbor has never been closed, and the annual clearances are about 12,000 vessels, with an aggregate tonnage of 6,000,000. Last year the coal receipts by water were 1,000,000 tons; of salt 500,000 barrels, and of lumber 200,000,000 feet.

RAILROADS.

Five well known lines of railroad enter the city, viz.; Chicago, Milwaukee & St. Paul; Milwaukee & Western; Milwaukee, Lake Shore & Western (last month became a part of the C. M. & St. P. system); Chicago & North-

western and the Wisconsin Central. Both the C. M. & St. P. and the C. & N. W. have very fine depots, which are the largest in the state.

The railroad shops of the C. M. & St. P. are among the largest in the country, employing 2,574 men, whose

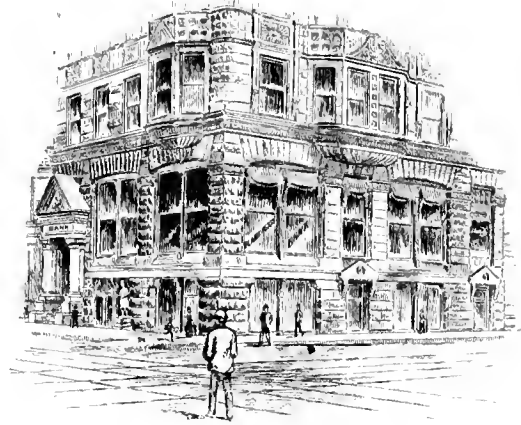

THE PLANKINTON BANK.

wages last year amounted to \$1,600,000, and material costing \$1,366,769 was used in car and locomotive building and repairs.

BANKS.

The record of the financial management of Milwaukee's banks compares favorably with those of her sister cities. From the first, in 1839, these important institutions had increased to thirteen in 1892. For that year

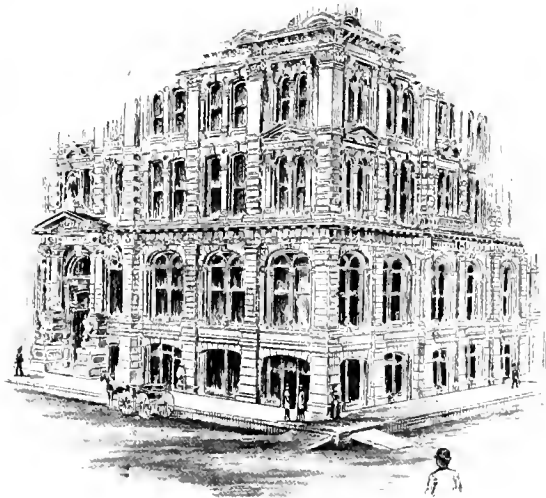

WISCONSIN MARINE AND FIRE INSURANCE BANK.

the deposits were \$977,160,024, an increase of \$11,000,000 over 1891. The total resources were \$42,992,613. The banking capital is very largely owned at home.

MANUFACTURING INTERESTS OF MILWAUKEE.

In its earlier day Milwaukee was known as one of the leading grain markets of the world. As the current of the cereals was gradually diverted through other channels

more attention was paid to manufacture, all the essentials of which are found here. It is a well known fact that a manufacturing establishment producing, say a million dollars of goods a year, will employ fifty times as many men as a wholesale house doing an equal amount of business. Of the groceries wholesaled here fully one-fourth are home-made. In other lines, requiring iron, wood and coal, raw materials are near at hand in the iron mines of her own state and Northern Michigan, from whence also comes lumber, while coal is imported from the east by cheap water freights, or from Illinois. Her immense breweries draw their barley supply largely from the state,

great cities of Europe. It constitutes the largest industry in the city, while one establishment, the Pabst Brewing Company, is the largest in the world, alone producing last year 1,061,788 barrels, while the total output of all the breweries was 2,318,739 barrels.

MILWAUKEE BRICK.

When in 1835 an attempt was made to burn some brick required to build a chimney on Solomon Juneau's house, great disgust and disappointment was occasioned on discovering the little kiln was filled with white or cream colored blocks, instead of the regulation red article.



EAST WATER STREET LOOKING EAST FROM WATER STREET BRIDGE.

as do the tanneries their tan bark. Gigantic as are the breweries they do not in the aggregate constitute but one-tenth of the manufacturing business of the city, a statement of which for 1892 is summarized as follows:

Number of establishments.....	3,500
Number of employes.....	53,873
Capital invested.....	\$94,399,500
Amount of wages paid.....	\$28,967,400
Value of the year's production.....	\$145,294,500

MILWAUKEE BEER.

Who has not heard of Milwaukee beer? Not only is it to be found in every large city on this continent, but it is served on the ocean steamers and is for sale in the

The incipient brick makers concluded Solomon would have to use the hole in the roof another year, and proceeded to throw away the worthless product which had cost them so great pains. Imagine their surprise to discover that the white bricks were of excellent hardness and durability. The extensive use of the light colored brick occasioned the familiar title of the "Cream City of the Lakes," a name for which the breweries were in no way responsible, as many erroneously suppose. The product last year sold for more than \$1,000,000.

PORK PACKING.

John Plankinton started the packing interests of the

city, which have now assumed large proportions. The well known millionaires whose names are associated with the history of this business are P. D. Armour, Frederick Layton, and Patrick and John Cudahy. The last named are now completing a mammoth plant at the new suburb which they have laid out and named "Cudahy." The product is sold in Canada, Europe and the Southern states. For the year ending February 28, 1893, the receipts were, of hogs, 482,483; of cattle, 85,267, and of sheep, 66,948.

THE ILLINOIS STEEL COMPANY

has a branch at Bay View, a suburb of Milwaukee, located on the shores of Lake Michigan. The works were founded in 1866 by Captain Ward, who was also the

THE GRAIN RECEIPTS

in Milwaukee from all sources for 1892 were as follows:

Wheat, bushels	15,204,639
Corn, bushels	1,396,790
Oats, bushels.....	6,716,398
Barley, bushels.....	11,778,298
Rye, bushels.....	1,587,724
Total bushels.....	36,683,849

THE E. P. ALLIS COMPANY,

whose position as engine builders is too well known by street railway men to need special mention, have in their Reliance works a floor space of seventeen acres. The grounds cover five city blocks, or 24 acres. Besides making steam engines they manufacture flour and band

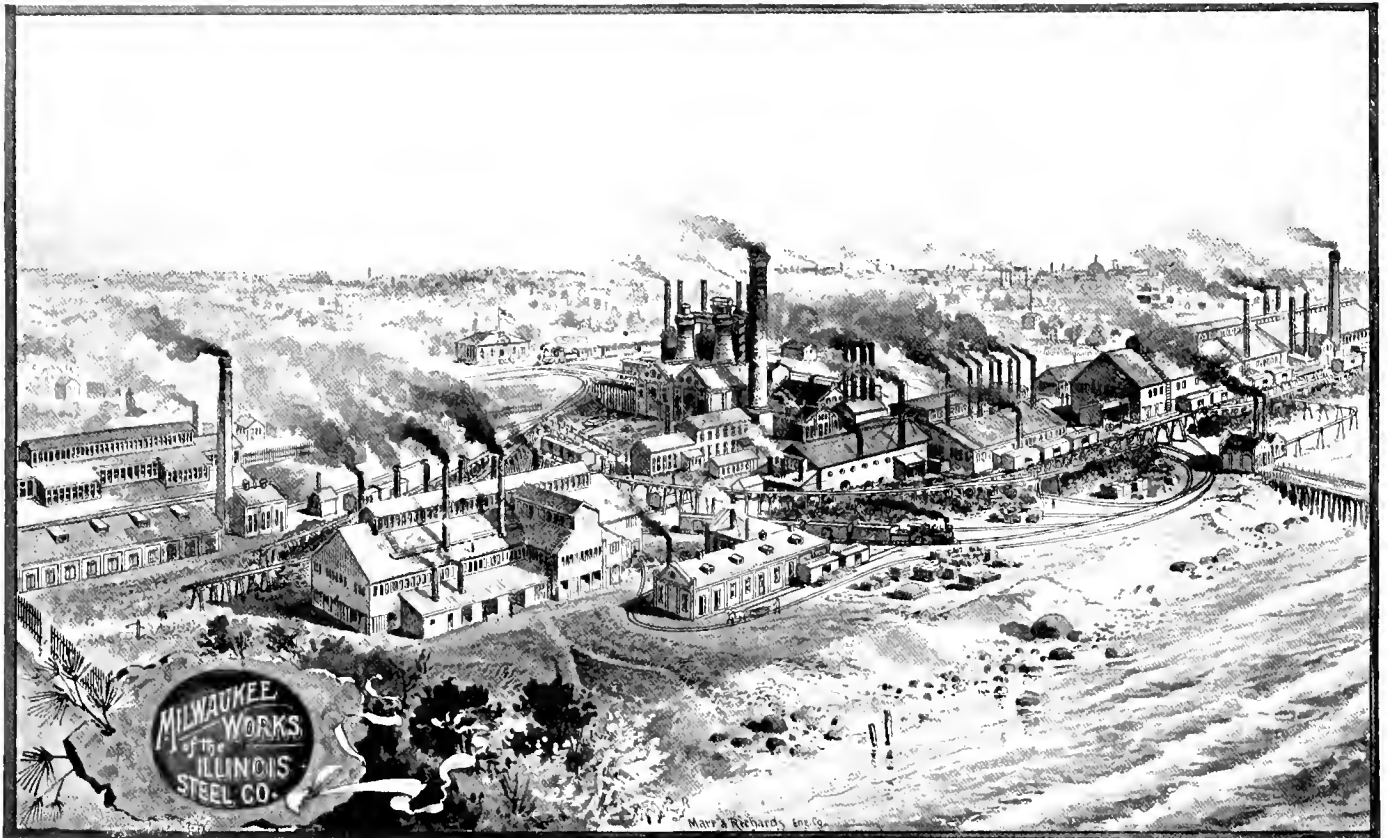

MILWAUKEE PLANT OF THE ILLINOIS STEEL COMPANY.

founder of Ward's Rolling Mills, in Chicago, which later formed the nucleus for the Illinois Steel Company. The Milwaukee Works were built with the design of having a convenient point at which the ore from the Michigan iron districts could be handled without the amount of transportation necessary to carry it to Chicago, and were known as the Milwaukee Iron Works. These mills have since turned their attention to other than crude ore smelting, and now roll various finished iron and steel products. They were taken into the Illinois Steel Company consolidation in 1889. The finished product in 1892 amounted to 107,131 tons. The average number of men employed is 1,350, and the yearly product is \$5,000,000. The manager of these works is Francis Hinton.

saw mill machinery. Beginning thirty-four years ago, they were the introducers of high duty triple and quadruple expansion engines in America, and to-day whenever Corliss engines of unusual size are talked of it may reasonably be expected that they are Allis make. The products of these factories amount to \$3,000,000 yearly, and the monthly pay roll is something like \$75,000.

LAST YEAR

the coal receipts amounted to 1,373,414 tons, of which 469,144 were reshipped.

The lumber receipts were 399,107,000 feet; shingles, 42,774,000 feet; lath, 11,039,000, and cedar posts 603,730.

The receipts of hops were 2,203,568 pounds.
Production of flour was 2,117,009 barrels.

CHURCHES.

Naturally a "city of homes" is found to be a city of churches and Milwaukee is no exception. There are 120 churches, including all the better known denominations, and some of the edifices and cathedrals are very fine structures and expensively decorated and furnished. The Y. M. C. A., with nearly 1,000 members, occupies its own handsome building.

ART AND MUSIC.

Milwaukee has a national reputation for both art and

36 by 49, William Powell Frith; "The King's Trumpeter," 56 by 67, Sir John Gilbert; "The Broken Bank," 51 by 38, Ludwig Bakelmann; "Beatrice and Benedict," 45 by 63, Hughes Merle; "The Hospital Garden," 115 by 72, C. Frithjof Smith; "The Benefactress," 60 by 36, Ernst Henseler; "Want, The Pawnbroker's Shop," 54 by 39, Frank Holl; "The Frolic After the Wedding," 48 by 78, John B. Burgess; "A Lonely Road," 18 by 15, Jean Charles Cazin; "The Latest Acquisition," 56 by 44, Prof. August Holmberg; "The Rivals," Mihaly Munkacsy; "The Surrender of the Moors at Granada, A. D., 1492," Francisco Pradilla; and "In the



WASHINGTON PARK—GRAND AVENUE.

music. The Layton Art Gallery contains one of the noted collections on the continent, and is the gift to the city of one of its millionaire packers, Frederick Layton. The building and grounds cost \$125,000; and while containing but 150 pieces of statuary and canvas both are particularly choice. The life size marble group entitled, "The Rebellion," is the gift of P. D. Armour, and cost \$25,000. Among the paintings worthy of special mention are "Two Goats," by Rosa Bonheur; "The Water Gate," 86 by 70, Emile VanMarkle; "Homer and his Guide," 56 by 82, Wm. Adolphe Bouguereau; "The Pilot Boat," 56 by 40, Edward William Cooke; "Swift and Vanessa,"

Studio," 80 by 63, by Michael Munkacsy. Of these a large number are the gift of Mr. Layton, who makes additions each year when in Europe. The collection is the finest offered the association since its visit to the Corcoran Gallery in Washington.

THE SOLDIERS' HOME.

Perhaps the most interesting place in Milwaukee is the Soldiers' Home. In a beautiful park of 490 acres, largely covered with natural trees, are the attractive and comfortable buildings where upwards of 2,000 of the boys in blue are waiting for the final muster out. The

members of the Home include many whose faces betoken education and ability, but, with comrades from the more common walks of life, hampered and weakened by the exhaustions of war, have waged an unequal battle in the conflict for self support and, at last, have taken refuge in the home which a grateful nation has provided.

It is extremely interesting to spend a day with the "boys," to look into the kindly faces and hear the story of forced marches and hard-fought battles from the lips of men who escaped while hundreds fell. But tears rise unbidden to the eyes of the visitor as he cannot fail to note the bended forms, the faces that tell of a generation of suffering of which the tongue makes no complaint,

mouths through a bank of flowers on the other side; the name of Grant in red geraniums, bordered with delicate foliage plants; and other reminders of old days are at every turn; but floating high above everything else is that flag, a picture set in sky blue, to which the veteran loves to turn his eyes as self communes with memory. The home is commanded by a "governor," Colonel Cornelius Wheeler, to whom the boys are greatly attached.

Guides are employed by the home to show visitors about the grounds and buildings. They are well posted, ready and willing to tell all about the routine and buildings. They can be always found in the hall and about

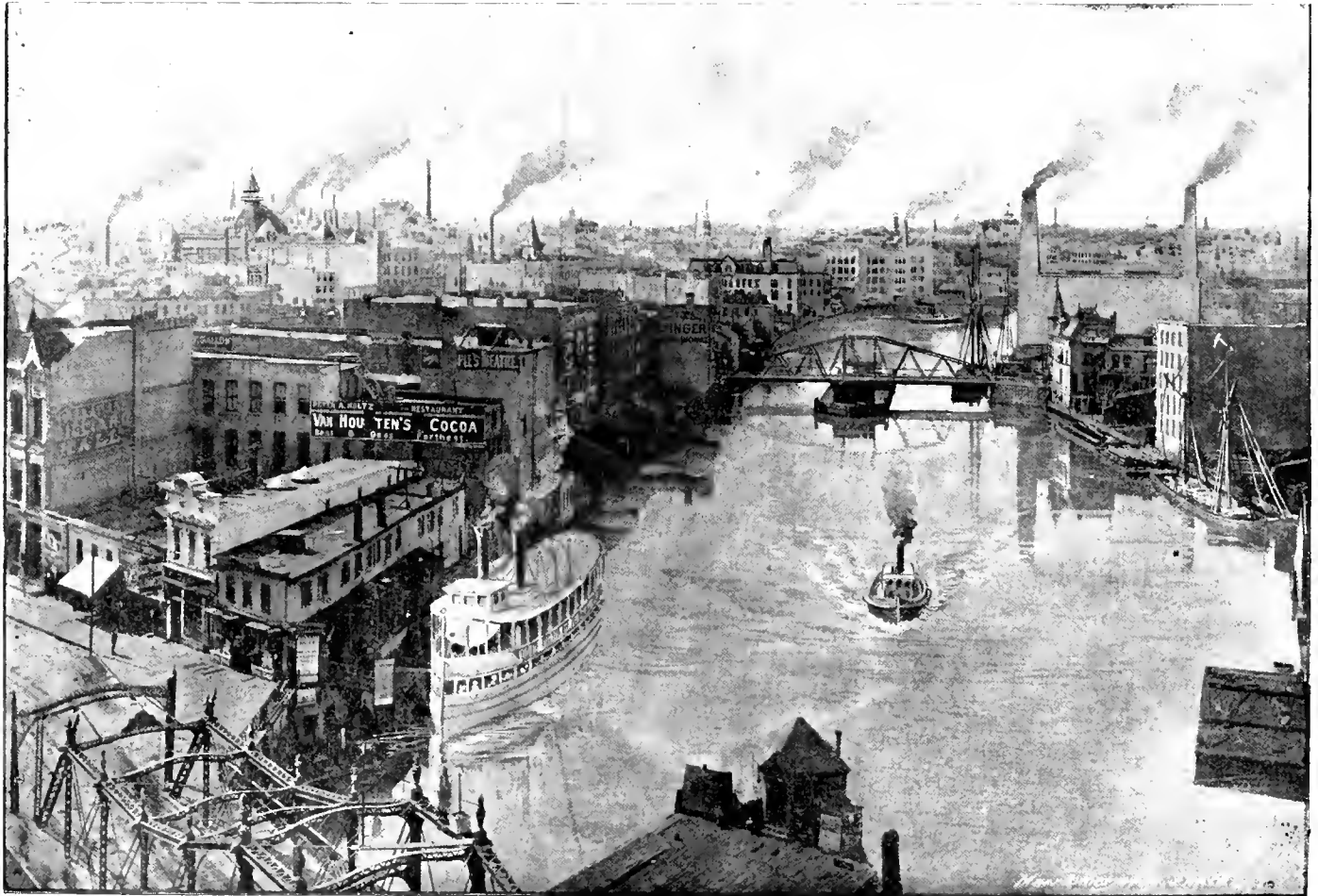

MILWAUKEE RIVER LOOKING NORTH FROM GRAND AVENUE BRIDGE.

and to see that few venture out under the trees in the seats reserved for their exclusive use without friendly cane or crutch. Hardly a week passes but some soldier is transferred from his hospital cot to the quiet cemetery, which friendly trees hide from vision at the home. The caisson carries its silent burden, the band plays its solemn dirge, the chaplain pronounces a few words, a volley echoes through the peaceful valley and the procession returns with the same military precision with which it came.

Brass field pieces rest at picturesque points; a high earthwork, behind which huge cannon poke their silent

the reception room of the main building. A large green house at the home is well worth a visit.

The Soldiers' Home had its start as a result of a fair given by the ladies of Milwaukee in 1866 and raising \$100,000 for the first purchase of ground. It was transferred to the United States government soon after, and is now under the charge of a board of managers appointed by Congress. It is located a mile west of the city limits and four miles from the lake, in a charming grove. The buildings were built for this purpose and are, therefore, cheerful and commodious. The main building contains officers' assembly rooms, sleeping wards and the

dining room, which seats 1,000 at once. At meal time the men file in and remain standing until the bell strikes. All are then seated, each man occupying his own numbered seat. At a second signal the meal is commenced. The table is entirely set in advance and all the work performed by the men. A handsome library has just been completed at a cost of \$15,000. It now contains 7,400 volumes and receives 185 papers and magazines. Inmates of the home are governed by army rules. The present membership is 2,610. They represent every state in the Union, and civil and American wars. Members must retire at nine and not arise until six. Those who are able, do light work around the home one half day each week, and those doing regular work receive pay. Clothing and laundry are free of charge. A chapel, costing \$9,000, seats 600 people, where Catholic and Protestant denominations hold numerous services. The Ward memorial hall contains a first-class theater, fully equipped, where weekly entertainments are given free to the members, the money being derived from the "post fund," which

fund also pays a brass band for daily open air concerts given during pleasant weather. A model farm of 100 acres is conducted. The military feature of a guard house is preserved, for disorderly members. There is also the "canteen," conducted under the supervision of the home and designed to "freeze out" the low saloons that formerly found resting places round about. The income supplies the "post fund" before mentioned. Nothing stronger than beer is sold, ten barrels of which are consumed every day. There is a regular post office on the grounds, entirely separate from that of Milwaukee. The funerals of the home are carried on in a very impressive manner. A Keely Institute is maintained at the home, having been started last winter under the management of Governor Wheeler. Its membership is 204, with a lapse into drunkenness of only thirty-two, in spite of the innumerable saloons in the vicinity. It is said to have greatly increased the order in the home. The local management of the home is under Colonel John L. Mitchell.

THE MILWAUKEE STREET RAILWAY COMPANIES.

BY reference to the article in this number of the REVIEW, on the history of rapid transit in Milwaukee, the progress of the art transportive may be found outlined.

How the transportation is really effected is another story: in fact, this story.

As mentioned in the history, there is now but one

are electrically equipped. The rail is mainly girder, set on chairs, of 63-pound Johnson type. The power house is passed by all the cars on the line, and is situated on Wells street, between Eleventh and Twelfth. It is a three-story brick building, 60 by 120 feet, and contains a 250-horse-power and one 350-horse-power Reynolds Corliss engine, fed by four 100-horse-power upright Rey-

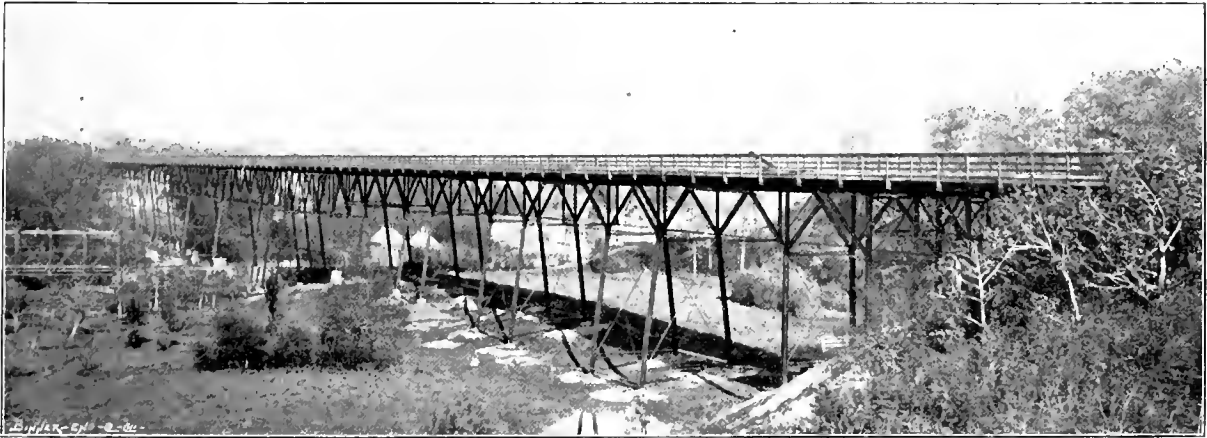

HIGH TRESTLE ON THE WAUWAUTOSA LINE.

active and independent street railway system in Milwaukee, as the two lines known as the Pfister and the West Side lines are just waiting the time when they will be absorbed. It will not be amiss, however, to outline at least the facilities of these two smaller plants, and to begin the investigation let the visitor go down Grand avenue to the handsome stone edifice known as the Loan & Trust Company building. Here Secretary and Manager T. J. Durnin will explain that the West Side Street Railway Company owns 21 miles of track, of which 19

nolds boilers. Four 100-kilowatt Edison generators furnish the current, which is carried by No. 2 silicon bronze wire on side poles. Return is continuous copper. The car equipment consists of thirty-four motor and thirty-five trail cars, built mainly by Jones, with a few cars of other makes. McGuire trucks and Barre wheels are used. The Jones cars and the McGuire trucks are considered by the manager to be superior in strength and durability. The cars are lighted by electricity, and friction brakes are the only ones needed, as the maximum grades are

only 5 per cent. A. McNaughton is superintendent of the line and Washington Becker is president.

THE PFISTER LINE,

in the hands of Receiver Melms, is really known to the law as the Milwaukee Electric Street Railway Company. Charles Pfister is the president; C. Landsee, secretary and treasurer, with Mr. Melms as lord-high-executioner. The offices are in the Academy of Music, on Milwaukee street. The line has thirteen miles of track, with twenty cars, all electric. The line was started April 19, 1890, and has been operated steadily since, in spite of its romantic legal history and many trials. The rail is 45-

show of his real ability, and the present state of the financial situation, which is preparatory to transfer, takes away the interest in the line's equipment that might otherwise be evinced. Mr. Melm's late showing is highly complimentary to the economy of the receiver and places affairs in better shape than they have been before.

This brings us to the real object of the present writing, a description of the plant and line of the

MILWAUKEE STREET RAILWAY COMPANY,

the wonderful improvement of which was the occasion of an extended article in this magazine, in the July issue of 1892.



THE CHESTNUT STREET BARN.
THE FARWELL AVENUE BARN.

THE MILWAUKEE CAR BARN.

THE THIRD STREET BARN.
THE NATIONAL AVENUE BARN.

pound flat on stringers, and does very good service, considering its light weight. At the power house there are no particular practices that differ from the ordinary. The power is ample for the number of cars operated, as 700-horse-power in boilers supply a 350-horse-power Allis-Corliss compound condensing engine, which drives a 300-horse-power General Electric dynamo. The rolling stock is mainly from the St. Charles Car Company, of Missouri, and the late Northern Car Company, of Minneapolis.

Mr. Melms' particular position is one that precludes any

The company has now over 100 miles of track in operation, running a total of 200 cars, with contemplated extensions that will increase the mileage to a considerable extent and bring the system nearer the goal of the "largest electric street railway system in the world."

The system now comprises the old Cream City, the Milwaukee City and two dummy lines, one to the beautiful resort of Whitefish Bay and the other to Wauwatosha, a growing residence suburb.

The gauge of the track is standard, with grades ranging from 6 to 9 per cent maximum. The track is laid

mainly with Johnson girder and Illinois Steel Company girder, with the latter in the majority. The streets are cedar block paved with several long stretches of macadam and cobble. The light traffic on the cedar block gives it some advantages over cobble, but the business streets are better suited with the old fashioned cobble. The company is required to keep the street in repair from curb to curb. The curves on the line are mainly of 40-foot radius, but a few are much closer to a right angle. The Whitefish Bay dummy line is woefully crooked and in sections quite rough, but will be improved and electrified at some future date. The resort at the bay is owned by the Pabst Brewing Company and is well worth a visit. A lovely view of blue lake and blue sky, with the green bluff for a background, is well worth the trip. The Sunday traffic on the line is immense. The electric cars connect with the dummy and the fare to the resort and back is twenty cents.

THE ROLLING STOCK

of the Milwaukee Street Railway is probably the best study in car building that can be found in America, as all the best makes are well represented; most prominently, however, Laclède, American, St. Louis, Brownell, Gil-



A TRAIN ON THE WHITE FISH BAY DUMMY LINE

bert, Jones, Northern, Ellis, Lamokin and Stephenson; mounted on McGuire, Randall, Taylor, Three Rivers, Peckham, and car builders trucks all doing good service. Several eight wheelers, made by the Northern Company and the American Company, are seen. A curiosity in aged cars is a Stephenson 16-foot bobtail, now running as trailer, that was sold originally to the River & Lake Shore Company in the 60's, and has been doing nearly thirty years' service. There are about 200 cars all told.

THE POWER HOUSE

that attracts the most general attention, is the main plant on Edison avenue, formerly River street, near the river, for convenience of fuel carrying and condensing water. The building is an immense affair, measuring 100 by 103 by 95 feet high.

On the ground floor, which is solidly built in concrete and brick, are bedded five 600-horse-power engines, furnishing power for the railway system. These engines are of the Edison vertical triple expansion direct coupled type, designed by J. C. Henderson and built by J. Morton Poole Company, of Wilmington, Del. They measure 16½, 23⅞ and 38½ by 30-inch stroke. They run at 160 pounds steam pressure and carry two 200-kilo-



WHERE THE FEEDERS REAPPEAR OPPOSITE THE POWER HOUSE.

watt dynamos each. They run at 120 r. p. m. and stand 21 feet high. The floor space of the room is 100 by 45 feet and the engine room is 34½ feet high.

The boiler plant consists of 18 Galoway boilers, made by the Edge Moor people, of Delaware. These boilers are arranged in two batteries, of 9 each, one above the other. How it was done is shown in our engraving.

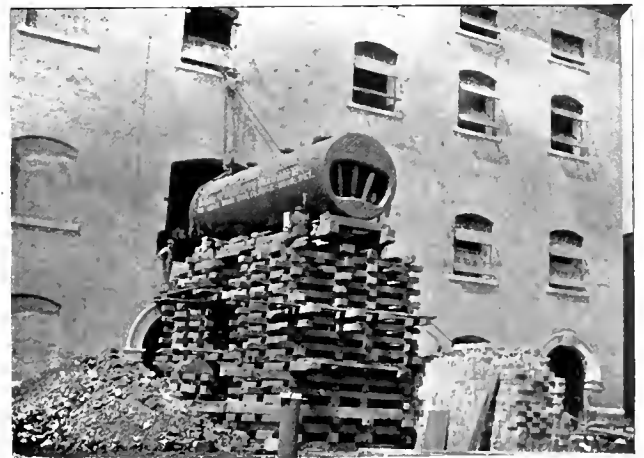

HOW THEY RAISED THE BOILERS TO THE SECOND FLOOR.

Why it was done—well, it economized space. Forced draught from Sturtevant blowers, coal conveyors, Wheeler condensers and Knowles pump add to the completeness of the plant. The headers from these boilers are four in number, 66 feet long and 16 inches in diameter. The horse-power of the boilers is 200 each, all internally fired and working at 160 pounds pressure.

Wass grease extractors and the DeRyke separator are attached to the exhaust and steam pipe of each engine.

The street railway plant is on the ground floor, but upon the second floor, set upon a solid concrete base, are five engines of 300-horse-power for the light plant. The General Electric multipolar dynamos are ten in number, direct coupled to the engine shaft, with the commutators on the face of the armature and practically a part of the winding. There are six feeders to each machine. The gramme ring armature is 84 inches in diameter.

There is at present completed a system 78 miles in length. The Wisconsin Bridge & Iron Company, of Milwaukee, made the handsome and durable center poles.

The meager sketch given here of the system shows only a few broad generalities, which a close inspection will resolve into many interesting particulars.

The temporary plant near the Kinnickinnick avenue barn is a 1,000-horse-power auxiliary to the main plant, intended only for a few months' use, but which now has been doing first-class economical service for nearly a

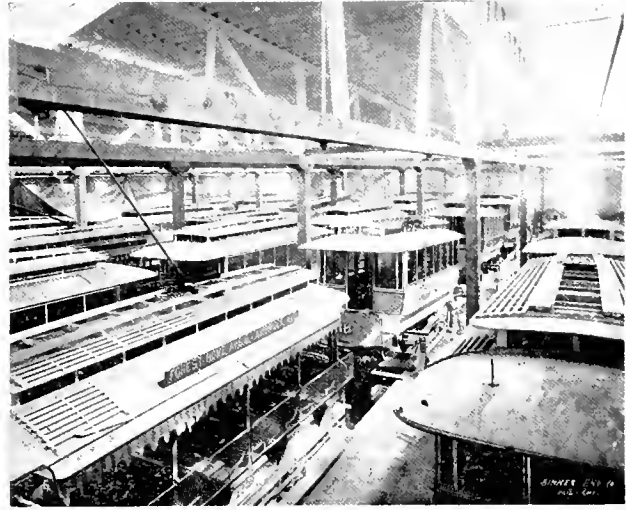
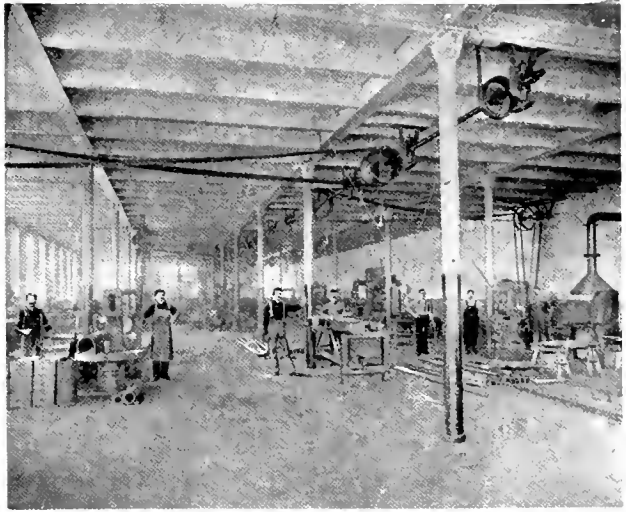
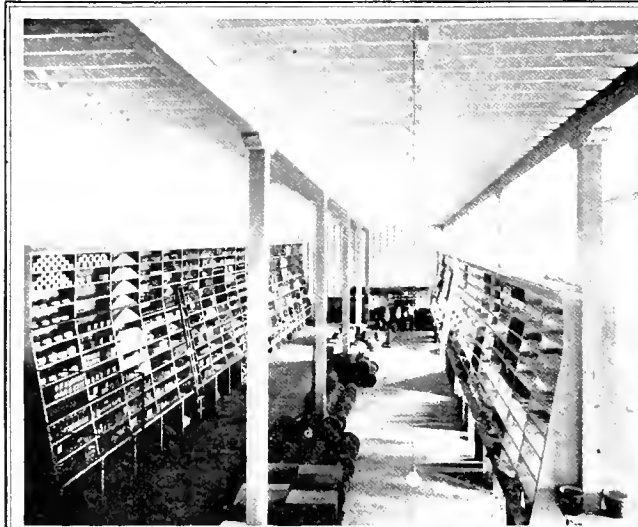

THE STORE ROOM.
A FRONT VIEW.

THE NEW KINNICKINNICK BARN.

THE MACHINE SHOP.
THE CAR STORAGE.

The Italian marble switch board, made by the General Electric Company, is in two sections, one for the dynamos and one for the 40 of feeders. All feeders are laid in Edison underground tubing, feeding in 21 sections. The feeders are fused at both ends. The trolley line is mostly of the center pole pattern and the wire is No. 2 hard drawn copper.

The auxiliary main is of No. 0 wire, and to this main the feeders are connected, and at every fourth pole a sub-feed is taken off the trolley from the auxiliary main.

year. The engines are a second-hand Providence-Corliss and a second-hand Reynolds-Corliss, of 500-horse-power each. The site was formerly a foundry, but in spite of all these conditions the plant is as neat as care and scrubbing can make it.

SOME FEATURES

that are commended to the investigation of visitors at the convention are the methods of ground return, which is by rail and by water pipe, the tension being equalized by

cross wire connections of these two media, at intervals where they are in proximity. Tests show that electrolysis is avoided, and that the return is much better. The street railway company also furnishes power for several of the draw bridges across the river. A 15-horse-power motor is used at these bridges, running by a small trolley, to which power is furnished by submarine feeders. The bridge approaches and skates are of local construction, and very effective. From the light plant, which is for commercial use, some 300-horse-power for stationary motors is rented, besides the 10,000 lights to various business houses and residences. The induced traffic is carefully looked after. Whitefish Bay, on the dummy line; National park, on the Soldiers' Home & Walnut street line, which also passes Soldiers' Home and Schlitz park; the South Side park, reached by the Holton avenue & Bay View line; Shooting park and Lake park,

till December 28, by a horse barn and car barn combined. On this date the whole structure was destroyed. The old building was 270 by 204 feet, and two stories high. Its value was \$35,000, while the machine shops were worth \$30,000, besides \$70,000 in tools, machinery and cars. The rapidity in which rebuilding was completed is notable.

In the second story of the corner front, and extending along Maple street, are several suites of offices for the superintendent and electrical engineer (the office is a combined one), the car accountants and ticket men, the superintendents of operating departments and the service generally, besides a waiting room for conductors and motor-men, with every convenience of bath room, reading tables and clothes lockers. This front has bay windows commanding a full view of both streets for many blocks. Beginning at the south end of the building, on the Maple street front, a commodious office is placed for



BURNING OF THE OLD KINNICKINNICK BARNS, DECEMBER, 1892.

tapped by the Farwell avenue, North avenue, and Mitchell street and Cambridge avenue lines, which also lead to Ludermann's-on-the-River.

Eight bridges are crossed by the street railway, and several railroads offer first-class chances for bad accidents, were it not for the care Mr. Hommell takes of his passengers.

THE KINNICKINNICK SHOPS AND BARN

will be an object of universal interest and should be the subject of close study by the visitor. The structure is situated at the corner of Kinnickinnick avenue and Maple street, on the south side, and is 300 by 300 feet in dimension. The corner front is three stories and basement in height, while the remainder is two stories high and half basement, for car pits.

The present site of the repair shops was occupied up

the use of the stock department. Harry de Steese is in charge and will take pleasure in showing the visitor the room immediately behind the office, which is a magnificent store room, 40 by 60 feet in dimensions, with shelves and cabinets in abundance for the accommodation of the repair force. Next, on the same level, is the armature room, where all the motor and dynamo winding for the entire system is done. All the men are experienced, and when change in the winding is found expedient, it may be done here without the trouble and expense of shipment. The armature room is next the store room, to facilitate the handling of the wire. Twenty men are employed at present in the winding room. A bake oven and in fact every necessary appliance is at hand to make the armature room perfect. It is connected with the machine shop by an electric elevator. The armature

room, in common with the rest of the shop and barn, is lighted electrically.

Immediately below the armature room and extending the length of the building, is the machine shop, where wheel presses, lathes, drill presses, screw cutting machinery, millers and other appliances for rough or fine work are found. An old water-proof, Thomson-Houston, 50-horse-power double reduction motor is installed here as the motive power and faithfully fulfills its function.



MICHIGAN STREET BRIDGE APPROACH.

Forges and anvils, together with a rail bender, enable the company to do all its own smith work and crossing and switch work, besides general repairs.

Next to the machine shop on the north is a boiler room of 30 by 30 feet, containing three boilers, which will later do service for the plant. A store room for underground supplies is also found here, and great coils of submarine cable, Edison tubing and cables give the room a Jules Verne appearance, intensified by the "dim, religious light" from the basement windows. This ends the elevated part of the structure. The rest of it is only slightly raised and is the car barn proper, a good view of which we are able to reproduce. There are eleven tracks, capable of holding over a hundred cars, all told. The pits are electrically lighted and a repairer can go from one pit to another at any place along the tracks. This also facilitates fire fighting and gives good ventilation. The building is of brick and of slow burning construction. At present the reserve equipment is the principal storage.

In course of time a new power house will be built on land already the property of the company, abutting the car barn, and the foundation is already laid for a paint shop, 125 and 325, giving fifty men employment. A side track from the Northwestern railway provides ample facilities for the shipping of supplies. The remaining car barns for the system are situated at Third street,

National avenue, Chestnut street and Farwell avenue, and at Kinnickinnic avenue. They are well represented in our engraving, although giving no points of particular interest.

RAILROAD RATES TO CONVENTION.

THE close proximity to the World's Fair of the convention city, has this year relieved the secretary from the necessity of securing special rates, as the round trip rate to Chicago is, from most points, less than the one and a third rate usually granted the association. Delegates should purchase round trip to Chicago and then buy round trip Chicago to Milwaukee, between which two cities special excursion rates are in force.

HOTELS IN MILWAUKEE.

THERE will be all necessary hotel accommodations in Milwaukee, though the favorite headquarters, the Pfister, will claim the large majority. This hotel is one of the finest on the continent and a veritable



THE HOTEL PFIESTER—THE HEADQUARTER'S HOTEL.

palace, run on both the European and American plan, for which latter the rates are only \$4.00 to \$5.00 per day. It is one of the sights of the city and is conveniently near the exposition building, the Layton art gallery and other public buildings.

EXHIBIT SPACE.

AS described elsewhere, the facilities for exhibit exceed any of previous conventions. Exhibitors should make application at once, addressing W. J. Richardson, secretary, 166 Montague street, Brooklyn. Building will be open to installation on and after October 9. Space will be charged for at the rate of ten cents per square foot.

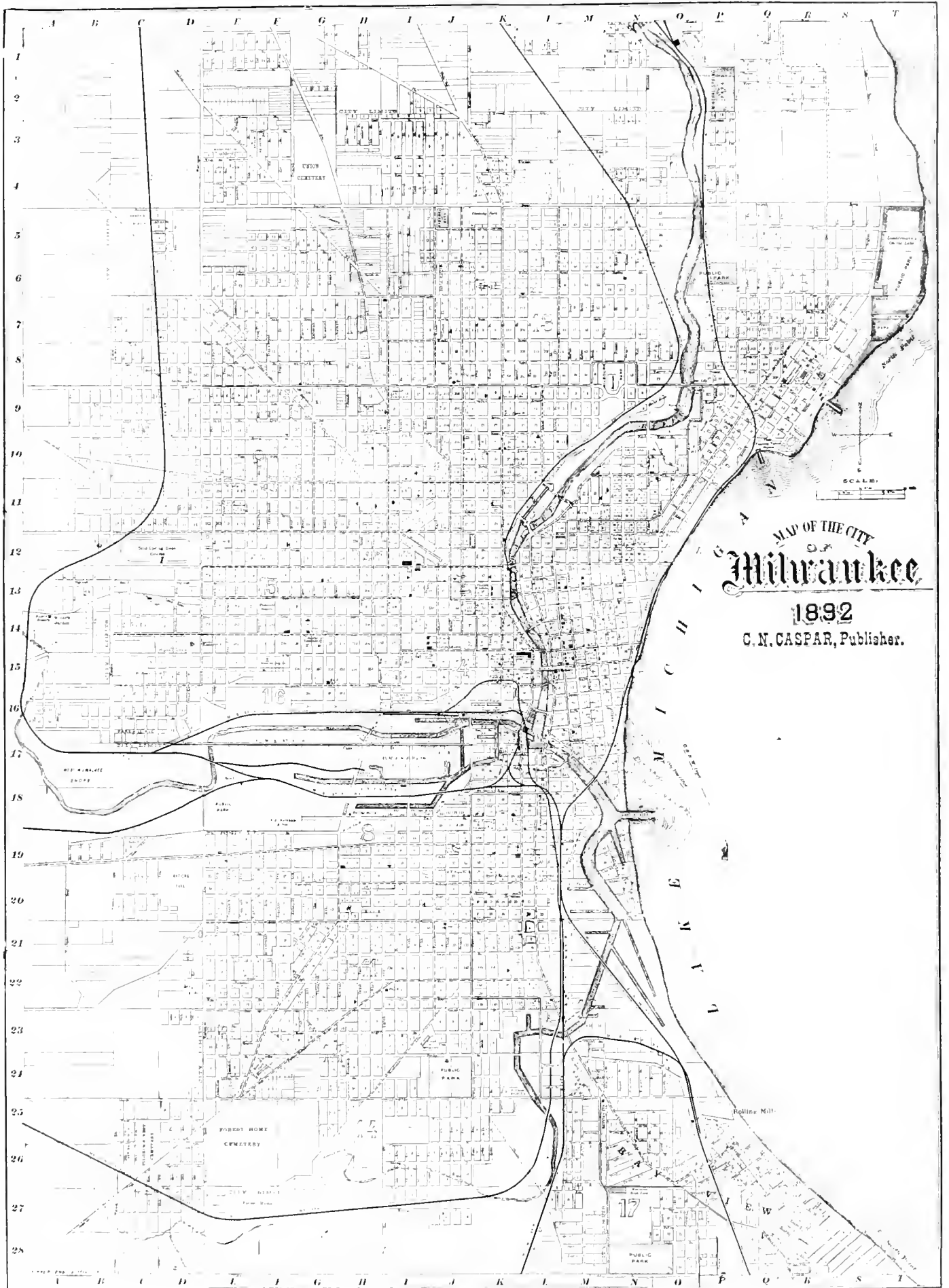

THE STREET RAILWAY MEN OF MILWAUKEE.

WHEN one sees a city whose street railway system is marked by a progressive management, he has no occasion to further question the policy and ability of the men who have it in control. Hence our readers need not be reminded of the strong business qualities which characterize the men who represent the Milwaukee street railways. In this list the most prominent is

HENRY C. PAYNE.

Perhaps the best known man in the double role of street railway manager and statesman is Henry C. Payne, whose generosity as manager of the Milwaukee



HENRY C. PAYNE.

Street Railway Company has made possible the holding of the American Street Railway Association at that Electrical Cream City.

Mr. Payne is 49 years of age and has been a resident and a chief factor in the growth of Milwaukee for the past thirty years.

In the capacity of president of the Milwaukee & Northern Railroad Company and receiver of the Northern Pacific Railroad, he is called brother by our steam road contemporaries. The Wisconsin Telephone Company look up to him as head of that important organization, while his voice is heard in the commercial councils of men that shape the policy of the First National Bank. Besides this wide range of executives duties he is connected with a number of other financial enterprises.

From his interest in local politics, Mr. Payne has been twice delegate-at-large to the national conventions of the Republican party; once at Chicago in 1888, and in Minneapolis in 1892. He has also served his political affiliation as chairman of the state republican organization, and was recently for the third time an active member of the committee that has shaped its national policy

—once as chairman of the executive committee. In fact, in the less than thirty years of his active life, perhaps, no other man in Milwaukee has been more prominent in every phase of public spiritedness.

As a street railway manager he is counted one of the best in the country, and his views carry the weight which always attaches to one of wide experience and superior executive ability. Personally he is a most genial and warm hearted gentleman whose friends are as far reaching as his acquaintance.

ALEXANDER W. LYNN.

The superintendent and electrical engineer of the Milwaukee Street Railway has had the most varied experience of any man in the service. He was born at Saratoga, N. Y., and attributes his great love for water as a beverage to this fact. He is 46 years of age and looks ten years younger than the family bible says he is.

As the youngest of seventeen children, Alexander was required to obtain his own forage. It was this circumstance also that saved him from becoming a spoiled child

After learning telegraphy, and becoming an expert penman, Mr. Lynn taught these branches several years and then ran a mail

route in Wisconsin. Going to Denver to recuperate his failing health he followed up his experiences by becoming in succession a railroad brakeman, a conductor and a farmer. In 1882 Charles Hathaway, of Cleveland, took him into the service of the Racine Street Railway Company and finally made him superintendent. He, in this capacity, also managed the change of the several other lines to electricity. At the end of this time Mr. Lynn went to Milwaukee as superintendent, where he has since been in active and successful street railway work.

GEORGE W. HOMMELL.

The west has drawn largely on New York for street railway men and, as usual, it did so most successfully when Mr. Hommell left his native city for Milwaukee.

It was about fifty years ago that Mr. Hommell discovered America, and it has been thirty or more years since he made his debut in that able, distinguished society of street railway men.

His early education was attained in the excellent public schools of New York City and at College Hill, Poughkeepsie, at which latter institution he was a classmate of Cornelius Vanderbilt. The two men have been life-long friends.

At the breaking out of the late war Mr. Hommell, then but a lad, entered the naval paymaster's office in New York, where he remained twelve years. At the end of



A. W. LYNN.



G. W. HOMMELL.

this period he entered upon the street railway career in which he has been markedly successful. He began railway work under E. S. Dickerson, now deceased, then president of the Third avenue road. A long service here was left to become manager of the Forty-second street road, New York, which he successfully inaugurated. The Battery, Dry Dock & East River was his next field and where he remained until in 1888 Wall street capitalists acquired the Milwaukee Street Railway and placed him in charge. When the Villard consolidation occurred Mr. Hommell became superintendent of the operating department of the entire system.

Mr. Hommell is an unusually active man, and but for his grey beard might be judged ten or fifteen years younger than this truthful sketch avers. He has an interesting family and his son George, junior, is already taking steps in his father's profession. In politics Mr. Hommell is a republican of the most pronounced type.

OTTO M. RAU,

the electrician of the consolidated lines, is one of the many bright, self-made electricians who have made the commercial electric railway and light plant possible.

Mr. Rau was born twenty-four years ago in New York, where his school days were passed, being graduated from one of the excellent high schools of the metropolis.

His railway experience is coeval with the electric railway, beginning, as he did, with the Daft Electric Light Company of Greenville, N. Y., and assisting in the starting of the first practical electric railway at Baltimore.



O. M. RAU.

Finding the railway work to his taste, and having abundant faith in its possibilities, he connected himself with the Electric Traction Company, of Marion, N. J., doing general superintending and overseeing installation.

Among his first works were the lines at Bloomfield and Meriden, Conn., the latter of which, built in 1883, was the largest hitherto attempted.

After this experience and education Mr. Rau became a member of the electrical engineering staff of the Edison General, where he remained until 1891, when he came to Milwaukee to take full charge of the expert work of that important plant.

Mr. Rau is a worthy member of the Milwaukee Electric Club and the inventor of several valuable devices, with other patents now pending on a full line of overhead materials.

T. J. DURNIN.

The manager of the West Side Street Railway, better known as the Becker line, is another young man old in railway experience,

Mr. Durnin was born in Milwaukee in 1862, and began his business career and street railway education at

the same time, when at the age of thirteen, or in 1875, he took a position as office boy with Mr. Becker.

"My subsequent career," said Mr. Durnin, "is not startling. I worked through every successive stage of street railway management. I counted nickels, kept books, superintended construction, conferred with city councils, managed the men, the rolling stock and the kickers. I haven't even had time to fall in love or get married, so you see I've been fairly busy."

Mr. Durnin's business experience has been of the most valuable kind, and whether he remains in the fraternity of street railway men, or goes into new fields, the success attendant on faithful performance of duties and an ability consequent upon such responsible positions as he has held, will surely be his.



T. J. DURNIN.

G. J. MELMS,

the receiver of the Milwaukee Electric Railway Company, is a surprise to people who come to his office expecting to see some staid old gentleman of the usual receiver pattern, for Mr. Melms is but thirty-two years of age, although, if judged by his experience, like the small darkey, "he is 'most a hundred."

Mr. Melms is a graduate from the electrical engineering course of the Institute of Technology, Worcester, Mass., from which institution his good record gave him immediate entrance to the Thomson-Houston Company, with which organization he remained seven years in various important capacities. The first three years' construction work in the United States claimed his attention, in which time he had charge of several large plants.

The following four years Mr. Melms went abroad in special work for the Thomson-Houston, installing plants at Milan, Montpelier, Paris, Geneva, Hamburg and other cities, and during the Exposition at Paris was in charge of the American exhibit of the Thomson-Houston. He also acted as chief engineer of the Parisian sub-company. During his residence in Italy he met, wooed and married the accomplished sister of C. E. L. Brown, the distinguished English electrician.

On his return to America Mr. Melms took charge of the expert work of the Chicago office of the Thomson-Houston until called to the receivership of the Milwaukee road.



G. J. MELMS.

"THE other side of the street, lady," said a Broadway conductor yesterday to a woman trying to stop a car on the wrong side. "But," insisted the persistent woman, "I stood on this side when I took this same car to come down."

OUR BRITISH VISITORS.

PARTIALLY on account of its proximity to the World's Columbian Exposition and partially on account of the lively interest that is awakening in England on the subject of rapid transit, the coming Convention will be honored with the presence of several prominent English tramway managers and rapid transit enthusiasts.

Facile princeps, the most prominent street railway man of the United Kingdom, is the long-time president of the Tramways Institute of Great Britain and Ireland, whose quick interest in all the progress of American street railway practice, makes him almost as well known in Chicago as in London,

W. J. CARRUTHERS-WAIN,

the managing director of the Birmingham Central Tramways, the Croyden, the North Staffordshire and others.

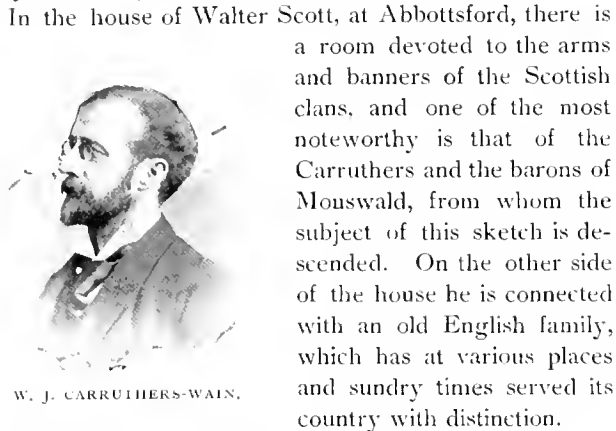

W. J. CARRUTHERS-WAIN.

In the house of Walter Scott, at Abbotsford, there is a room devoted to the arms and banners of the Scottish clans, and one of the most noteworthy is that of the Carruthers and the barons of Mouswald, from whom the subject of this sketch is descended. On the other side of the house he is connected with an old English family, which has at various places and sundry times served its country with distinction.

Mr. Carruthers-Wain's early life was spent in Canada, where he was educated and originally intended for the church. Pending decision on this question he was appointed to a position on the Brighton Railway, of England, and filled in his spare time by reading for the bar, to which his tendencies and inclinations carried him. However, so rapidly was railroading acquired that a brilliant offer of the assistant-secretaryship of the railway company decided him in that noble army of martyrs in transportation service.

Shortly after this, in 1885, his physician advised him to go to Australia for his health, but disregarding this advice, he stayed in the mother country to rapidly advance to the front ranks of financiers. He became subsequently managing director of the Birmingham Central Traction Company, which he raised from £14,000 to £38,000 in four years.

Any street railway corporation which finds itself in a bad state calls upon him and in nine cases out of ten the trouble is diagnosed, the remedy applied, and the undertaking restored to solvent health.

Although little past thirty, in a country where men must be old in years before they become old in experience, Mr. Carruthers-Wain has succeeded as remarkably as can be asked of the most progressive American.

Throughout the kingdom Mr. Carruthers-Wain is

regarded as the authority on all tramway matters, and to him the Tramways Institute owes its present active interest and life. His presence and voice at the Buffalo convention are in pleasant remembrance and a warm welcome awaits his arrival.

From the thoroughly progressive manufacturing center, the very name of which has become a synonym of industry, comes

CHRISTOPHER JAMES,

another distinguished brother of the craft and a member of the Tramways Institute of Great Britain and Ireland, representing the North London Tramway, the North Staffordshire and the South Staffordshire Tramways.



CHRISTOPHER JAMES.

He was born in Cornwall, England, but went to Brazil at an early age, continuing his residence there for many years. He is now, however, domiciled in London, and since 1884 has held the position of consul general for the republic of Paraguay in Great Britain, and at present enjoys the distinction of being the sole representative of that republic in England.

W. HOLMDEN,

secretary of the Birmingham Central Tramways Company. The company has nearly twice as many miles of line in operation as the two other lines in Birmingham, and is regarded as a model road of its kind.

Mr. Holmden was born in Plymouth, Devonshire, and began his business career in the office of Messrs. Collier Brothers, of his native town, who were general merchants, Lloyd's agents and vice consuls for the Sidney, Australia, European government.

At the age of 21 Mr. Holmden went to Birmingham and entered the office of a large metal agent and general broker, but ultimately went into the tramway service, after having held the secretaryships of the Darlaston Steel & Iron Company, Staffordshire, and the Horseley Company, Tipton.

On the removal of the Central Tramways registered office from London to Birmingham, Mr. Holmden became its secretary, in which office his ability has been distinguished for the past eight years.

Mr. Holmden is an enthusiastic and capable tramway man, and looks forward with much pleasure to his first American street railway convention.

WILLIAM WHARAM

is one of the best known tramway men in the kingdom, having been engaged in railway work in various capa-



W. HOLMDEN.

cities for nearly forty years. For the past twenty years Mr. Wharam has been the secretary of the Leeds Tramway Company, one of the most extensive in England, and for sixteen years has united with this office the post of manager, which combination of responsibilities, he has discharged with the greatest credit to himself and his principals.



WM. WHARAM.

Mr. Wharam's fine social disposition has won him many friends, and his long experience as a traffic manager has given

him an enviable position in the Tramway Institute.

Other British members of the Institute are contemplating the trip but were unable to advise us in advance.

THE NEW MANAGER OF THE NEW CASTLE CAR COMPANY.

THE foundation and growth of the New Castle Car Company, of New Castle, Pa., has been so intimately associated with the career of one man that his biography is the history of the concern.

F. A. Hover, the recently elected manager of the company, is a fine illustration of many-phased abilities variously exercised. He was born in 1865, on a farm near Jamestown, Pa., and graduated at Westminster College in the class of '87, taking first honors. Continuing his education, Mr. Hover married a little later and moved to New Castle, where he began the study of law, under the distinguished tutelage of J. Norman Martin. Mr. Martin was soon after appointed to the honor of the bench by the governor of Pennsylvania, and Mr. Hover was elected by a large majority, in spite of his youth, to the select branch of the city council in the place of Judge Martin.



F. A. HOVER.

In 1891 Mr. Hover saw the opportunities that an educated man would have in an active business life and opened one of the largest carriage and wagon repositories in the city of New Castle.

A year later he became assured of the fact that a field for street railway car building was open and accordingly organized the New Castle Car Manufacturing Company.

Entering into the active work of the concern, Mr. Hover took to the road and was so successful that from the start the new company had its shops full of work. In the spring of '93 the company made extensive improvements in the plant and doubled its capacity, and has now elected Mr. Hover general manager.

Mr. Hover's extensive travels and observations, coupled with his thorough and complete education and much practical work and experience, peculiarly fit him for this responsible position.

THE SECOND ANNUAL MEETING OF THE PENNSYLVANIA STREET RAILWAY ASSOCIATION.

THE second annual meeting of the association occurred at the Commonwealth hotel, Harrisburg, Wednesday, September 6. While the attendance was much less than had been anticipated, the gathering was a pleasant and helpful one. President Coyle, being sick, was unable to attend, and Vice-president Rhoads presided, calling the session to order at 11 a. m. A discussion of matters of general interest occupied an hour, after which the nominating committee, J. F. Ostrom, R. E. Wright and W. H. Lanious, offered a report on new officers and place, which was adopted, as follows:

President H. R. Rhoads
 First Vice-President R. L. Jones
 Secretary S. P. Light
 Treasurer W. H. Lanious
 Place of next meeting, Reading, first Wednesday in September.

In the afternoon a ride was taken on the Middletown Highspire & Steelton, to Middletown, a distance of nine miles. A 30-foot open Lamokin car was used, running on a Robinson Machine Company truck, with two 25-Sperry motors. A stop at the power house and an inspection was made of the four compound Wetherell engines; and the four 24-inch and two 48-inch Shultz belts; also the Wetherell clutches.

DELEGATES IN ATTENDANCE.

John F. Ostrom, Middletown, Highspire & Steelton; Harrisburg.
 A. H. Hayward, superintendent, and R. E. Wright, attorney, Altoona & Bethlehem Rapid Transit.
 S. P. Light, Lebanon & Anville Electric.
 J. H. Bickford, C. E., and R. L. Jones, attorney, Reading Traction Company.
 Paul Millholland, general manager Neversink Mountain Railway; Reading.
 W. A. Armstrong, superintendent, Lancaster Traction Company.
 L. B. Reifsnider, secretary, Altoona City Passenger.
 F. B. Musser, superintendent, East Harrisburg Passenger.
 G. F. Greenwood, general manager Pittsburg, Allegheny & Manchester.
 Capt. W. H. Lanious, president, York Passenger Railway.
 H. R. Rhoads, president, Williamsport Passenger.

SUPPLY MEN.

Arthur W. Field, New York, vice-president Peckham Motor, Truck & Wheel Company.
 W. H. Hess, Philadelphia, editor "The Car."
 A. C. Voseburg, Syracuse, secretary New Process Rawhide Company
 Wm. H. Hay, Altoona, president Robinson Machine Company.
 James E. Hewes, Baltimore, Baxter Company.
 S. H. Taylor, Philadelphia, Street Railway Advertising Company.
 T. T. Southwick, Rochester, N. Y., Lubricating Oils.
 W. E. Boughton, Philadelphia, The Johnson Company.
 F. S. Kenfield, Chicago, business manager the STREET RAILWAY REVIEW.
 D. D. Book, Jersey City, Curtis Electric Manufacturing Company.

The president-elect, H. R. Rhoads, was born in 1845, in Philadelphia, and when 18 years of age began as a telegraph operator with the Pennsylvania railroad, and soon became train dispatcher and division chief of the telegraph service. He was a pioneer in telephone service, opening the second exchange in the state at Williamsport in 1879. In 1880 he organized the Central Pennsylvania Telephone & Supply Company, and became president the same year.

In 1890 he purchased the control of the Williamsport Passenger Railway Company, and began the re-equipment of the line with electricity, beside building and extending it.

In 1887 Mr. Rhoads left the employ of the Pennsylvania Railroad to give all his attention to the telephone and electric business, being secretary and general manager of the Lycoming Electric Company, which lights and furnishes street railway power for that city.

Mr. Rhoads is also a stockholder and director in the Norristown Passenger Railway Company, recently electrified and put in commission.



H. R. RHOADS.

S. P. Light, of Lebanon, the newly elected secretary, is of sturdy German parentage, and was born August 30, 1861, at Lebanon. After a thorough education both in the common schools and in college, he read law, and was admitted to the bar in 1883, and engaged in practice in his native town. Corporation practice is his specialty, and especially street railway litigation. Mr. Light was a projector of the Lebanon & Annville road, which was so successful, and a director and



S. P. LIGHT.

counsel for it. He also holds interests in the Wilkes-Barre & Wyoming Valley Traction Company. Mr. Light's valuable legal aid has been more than once exerted in the behalf of street railways of Pennsylvania and as secretary of the association he will be of the greatest value to their interests.

HOW THEY READ THE REVIEW.

They sometimes skip the pictured news,
They may not read editorial views,
But with a zest that makes us glad,
They read, my friend, they read your "ad."

HYDRAULIC WHEEL PRESS.

THE illustration herewith, represents a 100-ton hydraulic machine for swinging 36-inch car wheels, made by the J. T. Schaffer Manufacturing Company, of Rochester, N. Y. It is equipped with special attachments for forcing off and pressing on pinions and gears of electric motors, which gives it an advantage over the ordinary car wheel press. This company makes eight sizes of wheel presses, to accommodate car wheels and drive wheels from 30 to 84 inches in diameter, some of which are portable. The larger machines have double pump, and those having single pump are made for both

hand and belt power. They are so constructed as to be perfectly secure if required to resist a bursting pressure of 6,000 pounds per square inch. The lower tension bar is flatwise, therefore stiffening the line of pressure. Each machine is supplied with a standard gauge, safety coupling, sealed water tank and safety valve.

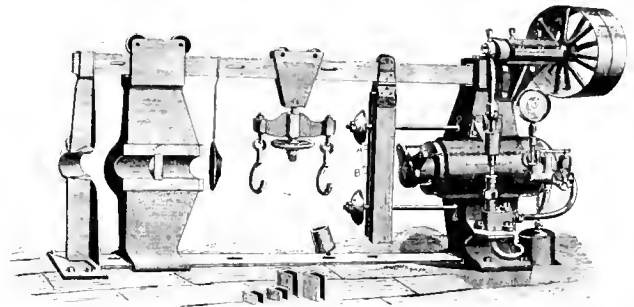

SCHAFER WHEEL PRESS.

This company has also introduced excellent appliances to be attached to any hydraulic wheel press for straightening car axles, and pressing off car wheels from axles on which a motor gear is located near the wheel. All the products of the Schaffer Manufacturing Company are sold under a guarantee.

SIMPLE TRACK BRUSH HOLDER.

THE reversible and adjustable track brush holder made by the Track Brush Holder Company, of Rockford, Ill., is a neat little arrangement for holding an article that is needed on every road. The majority of brushes are either fixed so that they drag along behind the wheels when the car changes direction or have a lot of complicated machinery for raising and lowering. This brush holder is placed on the guard board of the truck at each end. It is thrown up or down and locked

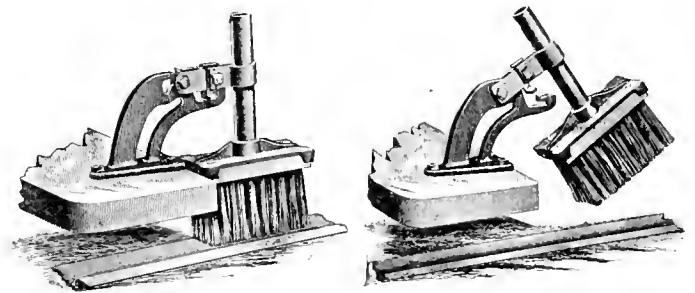

BRUSH SET.

BRUSH RELEASED.

in either position by the motorman at the end of each trip. At Rockford it is the custom to make the change with the switch hook from the car platform. When the brush is down it is held rigidly to the rail and cleans curves and all. It is claimed that brushes will last much longer with this than in other holders doing the same work but allowed to remain down all the time. The device is the invention of a practical railway manager, and is extremely simple yet strong, and can be attached to a car in a few minutes with unskilled labor.

AN HEROIC MOTORMAN.



PRESENT hero of Tacoma is William Gilson, a motorman on the Point Defiance Street Railway, whose courage saved the lives of fourteen passengers one day last month.

Some unknown and unaccountably fiendish villian had piled rocks on the tracks of the Point Defiance line, derailing Gilson's car as it crossed one of the bridged gulches frequent on that road. The car ran heavily against the guard rail, over it, and directly against the side railing, finally tottering on the edge of the bridge, one hundred feet above the bottom of the gulch. Gilson, instead of jumping, as he might easily have done, stood by his car, reversed the current, and applied the brake, saving his passengers and car, just as the front platform projected over the edge of the bridge. The company has peculiarly acknowledged his intrepid devotion to his duty.

NEW CASTLE'S COMBINATION CAR.

A BEAUTIFUL specimen of the car builder's art has just been turned out of the shops of the New Castle Car Company's works at New Castle, Pa., destined for work on the new Wheeling, Martin's Ferry, Bridgeport & Bellaire Street Railway Company's line, which connects the West Virginian and Ohio towns specified in its title. The car is to be used as a combination for passengers and baggage and express for the inter-urban traffic. There is nothing of the "coffin" in the general appearance of the car, but all is light, graceful and pleasing to the taste. From a street railway standpoint it fulfills every function and is strongly made and handily designed. The car measures 26 feet over all, of which space the baggage reserves 10 feet, leaving the

ing door leads through on the interior of the car to the baggage room, which may, at will, be turned into a smoking room, as it is fitted with side seats. The New Castle Company may be well proud of this new design, as well as the good workmanship and thoroughly tested material entering into the car.

TERMINAL FACILITIES IN SAN FRANCISCO.

THE Midwinter Fair, which will be held in San Francisco, has necessitated prompt and considerable new work on the part of the several street railway companies to provide for the increased travel. The energy and determination with which they have already done so, augurs well for the success of the exhibition. Extensions to the grounds have already been

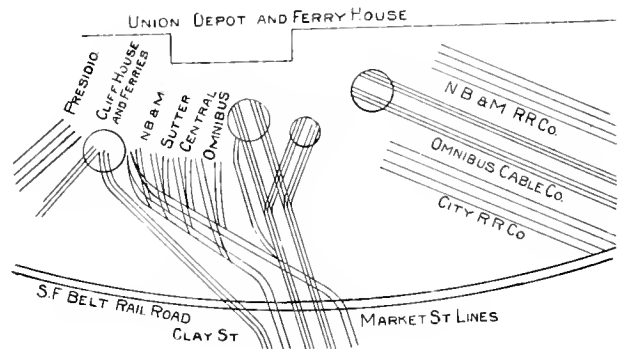

detailed in the REVIEW and now attention is turned to that Castle Garden of San Francisco—the Union Depot and Ferry House. In the plaza in front of this building all the car lines in the city have their terminus. The plan as agreed upon between the several roads and the commissioner is illustrated in the accompanying diagram. In most cases turn tables are used instead of loops or switchbacks.

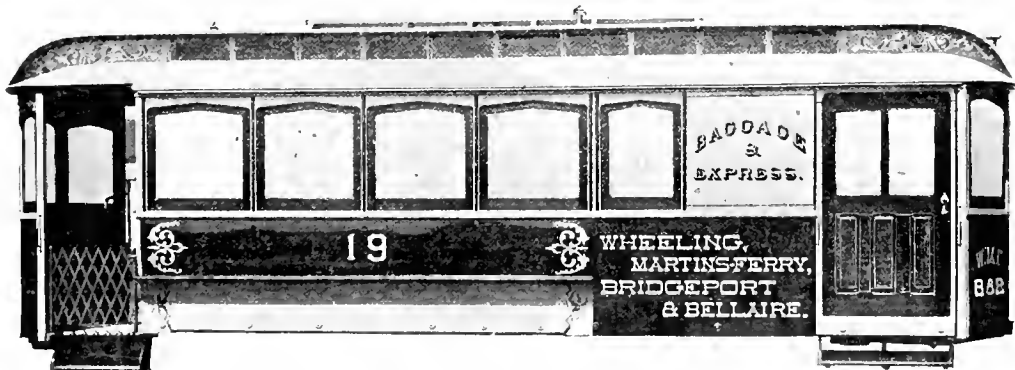

THE NEW CASTLE COMBINATION BAGGAGE-PASSENGER CAR.

remaining 16 for the passengers, except the vestibule, which is 3 feet 6 inches clear. The engraving presented herewith shows clearly the design, with the baggage door shut, and the neat arrangement of the railway company's legend which relieves the side. The interior of the passenger department is elegantly fitted up in the best New Castle style, with carpets, upholstery and colors. A slid-

ROBT. LAWRENCE ADAMSON, general manager of the North Metropolitan Tramway Company, of London, sends us the forty-seventh half yearly report of the company. The report shows a gratifying increase in traffic and receipts, with a total passenger statement of 40,000,000 carried, an increase of 3,000,000. May was the most profitable of the six months reported.

A SIAMESE TRAIN.

HOWEVER active the Oriental intellect may have been ages ago, Asiatic enterprise has been of late mainly exercised in fine schemes for abolishing the opium trade, cholera and idols, and of course European merchants and American missionaries have been at the head of these very commendable movements.

A new missionary has, however, made its advent into the land of perennial bathing suits and fricased rats, and its first chapel is located at Bangkok, Siam. To be direct, the missionary is a line of electric railway and the chapel is the power house.

Heretofore all transportation in this flat country was by pony, and as the animals were cheap, they were regarded as all sufficient, but the Bangkok Tramway Company is made up of progressive men and as electricity worked such wonders in America, they thought that a trial at least would be a good thing for Siam.

With this intent therefore, the Brush Electric Company's aid was invoked and W. J. Davidson, of the Short Electric Company, of Cleveland, was sent thither to supply want.

Davidson, dynamos and all arrived November 15, 1892, and on February 25, '93 the trial trip was made.

The power plant necessary for the line, which is three miles long, consist of two 80-horse-power single cylinder automatic cut-off engines, made by McIntosh & Seymour. The engines are 12½ by 12, running at 284 revolutions.

They are supplied from two horizontal tubular boilers, 16 feet long by 60 inches diameter, working under 80

are lighted by electricity and run at a maximum speed of 20 miles an hour.

On the initial trip a motley crowd of natives were astonished by the new affair, while the management and invited guests enjoyed the sensation occasioned. Our engravings show several local sketches of street railway traffic



CHIEF MARKET PLACE, BANGKOK.

in the kingdom of his most regal majesty, Son of Heaven, etc., etc., the emperor of Siam.

The Vice-Consul General, Robert M. Boyd, writes from Bangkok that the electric railway is meeting with great success, and advises the electrical companies to send representatives east, as more roads will follow personal effort at introducing them.

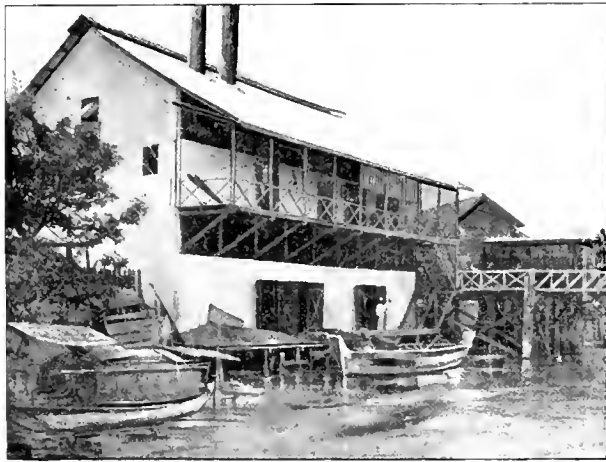

THE POWER HOUSE AT BANGKOK.



SCENE IN JUNGLE ALONG THE LINE.

pounds. Wood fuel is used. Two Short multipolar dynamos furnish the current, at the usual voltage. The switch board is of the completest designs with circuit breakers, lightning arresters and other safety appliances. The overhead wire is of No. 2 hard drawn copper, hung from side poles. The bonding used is galvanized iron. The return is through the rail.

Cars are solidly built of teak, mounted on modern trucks, and carry one 20-horse-power motor each. They

LEIPZIG tramways show a total income of \$502,580, an increase over last year of \$8,885. Expenses had decreased \$19,465. The system is in first-class condition.

It is said there are as many horses still employed in hauling street cars in the city of New York as would equip the entire English cavalry. But just imagine what a fierce charge these fiery streeters would make!

ECLIPSE EXHAUST PIPE HEAD.

THE Eclipse exhaust pipe head, just put on the market by the New York Exhaust & Blow Pipe Company, is designed on a very rational basis as will be seen from the engraving. The exhaust steam as it enters the head is carried near the top and

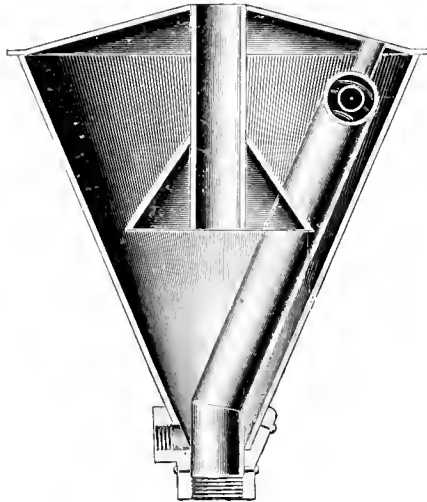

then discharged horizontally around the head giving it a centrifugal motion and allowing the dry steam to escape through the center of the top.

MUNICIPAL MANAGEMENT IN CANADA.

THE signal defeat of the attempt of the Vancouver, B. C., city council to obtain control of the street railway system of that town has been the text of several sermons preached in the editorial columns of the Canadian press. It may be stated that Canadian municipal relations are largely governed by the British customs, mixed in small degree by the infiltration of American ideas. The English method of municipalizing the intramural transportation facilities has been vigorously contended for by the press and as vigorously antagonized by the popular vote. The result is generally a compromise on a 50-year franchise with a purchase clause. Wherever the question has been approached one certain and fatal objection has met the defenders of municipalization.

The objection is the strong fear that the average aldermanic representative is not sufficiently gifted with firmness and honesty to trust with so large a slice of public patronage as would entail upon civic management.

This state of affairs forms important and reliable data for the judgment of similar propositions elsewhere. Canadian civic corporations and street railway corporations are new together. British tradition of public ownership of public enterprise is strongly marked and, in the main, the leaders in thought are essentially British. There is, however, a mighty undercurrent of rebellion against this idea and a general distrust of this time honored proverb. Not always is it expressed by individuals and almost never by the press. However, by their fruits are they

known, and the simple fact that Canadian street railway enterprises are conducted by private corporation, after a strong fight for municipalization, shows that majority good sense for which Anglo Saxons are famed.

AN ANCIENT KICKER.

PREJUDICE against electric railways brings to the minds of many old timers some of the objections made against the steam roads when the application of the locomotive to traction was first made.

In England the country gentlemen were informed that the smoke would kill all the game birds in reach of its pernicious fumes, and the general public was informed that the weight of the engine would prevent its moving. Foxes and pheasants would cease to exist in the neighborhood of a railway and the race of horses would become extinct.

Farmers were possessed of the idea that oats and hay would be no more marketable.

Sir Isaac Collin, with eloquence worthy of a better cause, said in the house of commons: "What is to be done with all those who advanced money for making and repairing the turnpike road? What is to become of the coachmakers and harnessmakers, of coachmen and coach masters? Is this honorable body aware that the smoke and noise made by this infernal machine, when going at the dizzy speed of twelve miles an hour, will fill the grazing cattle with dismay? Iron will be raised 100 per cent in price and probably altogether exhausted. It will disturb every particle of peace and quiet in the kingdom."

However, Sir Isaac's "bones are dust, his good sword rust, his soul is with the saints—we trust," while the steam engine has grandly served its great and useful end and is giving slow place to electricity and the Sir Isaac's of the present day still have food for reflection and recalcitration.

DYNAMO BRUSH GRINDER.

A NEAT little appliance that will be handy to have around the machine shop is here illustrated. It is called a dynamo brush grinder, though by taking off the universal side rest it can be used as any other emery wheel for common grinding. It takes up a floor space of 20x24 inches and weighs 500 pounds. For quickness and accuracy the old way of brush grinding stands no comparison with the new. The machine is made by the Springfield Emery Wheel Company, of Bridgeport, Conn., and will undoubtedly pay for itself several times each year.

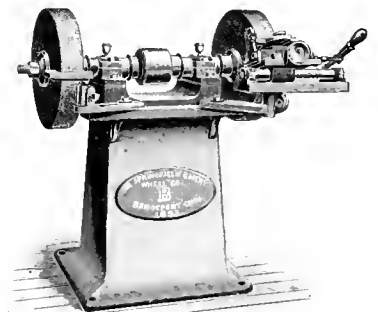

A SWEDISH STEAM MOTOR.

WE illustrate herewith a street car steam motor which, unlike so many others, has been in successful operation for about six years on the South Side Street Railway of Stockholm, Sweden, giving good satisfaction. There are twelve cars of this kind running every day of the year on lines where there are grades of eight per cent.

The engine room is 6 by 8 feet, and is located at one end of the car with open front. The upright boiler is of a type quite extensively used on the continent, having tubes arranged in tiers at right angles to each other.

fully furnish any further particulars that may be desired about the motor to those who wish to investigate the matter more fully.

An interesting feature in connection with these motors is the track on which they run. Instead of using a grooved rail two T rails are bolted together a proper distance apart, the effect being the same as that of the grooved rail. The cost is, of course, more, but the ease of keeping the groove clear probably makes up for the difference. European practice differs from American in nearly every respect and it is sometimes of value to observe how the persevering European will bring to perfection methods that have been cast aside in America.

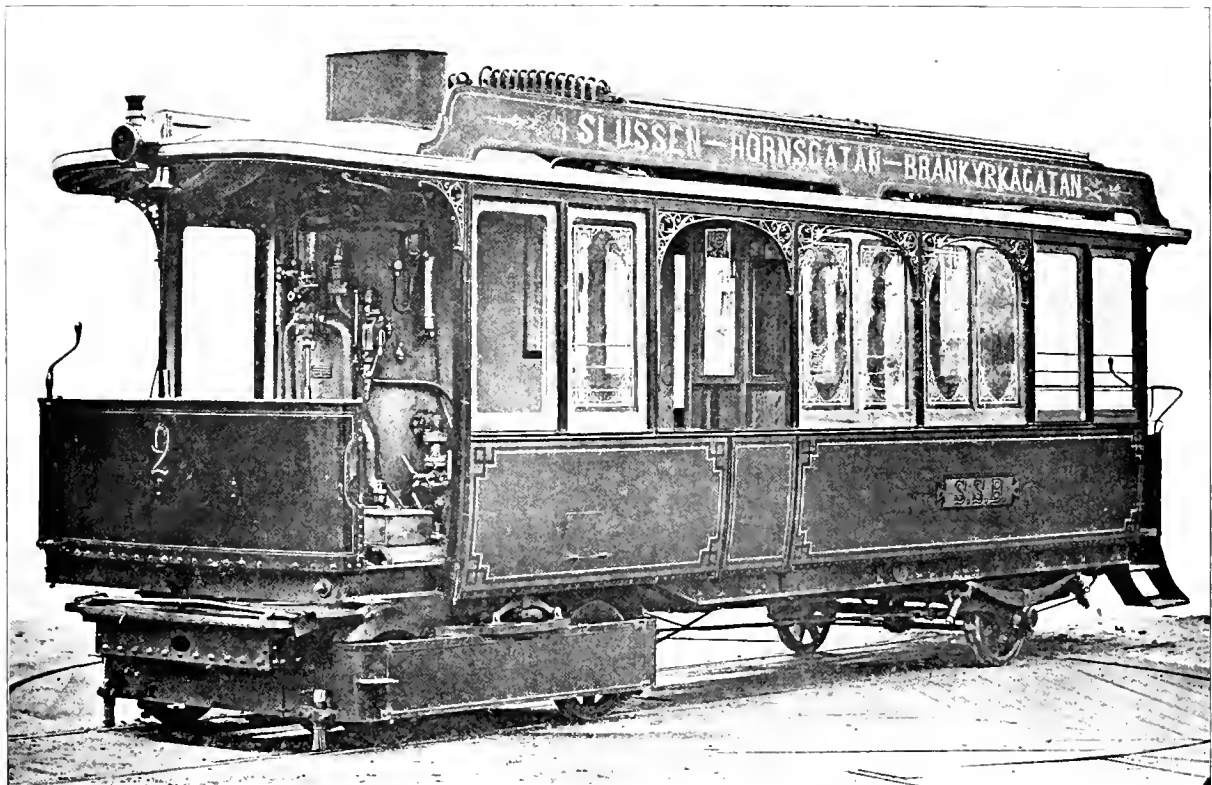

STEAM MOTOR USED AT STOCKHOLM, SWEDEN.

The fuel is coke and the supply is carried in pails placed inside the dashboard. The engine has two horizontal cylinders, 8 inches diameter by 15 inches stroke, and is being run with a pressure of 150 pounds.

In order to do away with the noise of the exhaust steam this is carried directly into a condenser located on the roof of the car and the condensed water is brought back to a tank placed below the floor. The engineer controls the motor by means of the levers seen in the engraving, which are so located as to be within easy reach of the engineer as he faces forward. This motor car is built by the Atlas Works, Stockholm, Sweden. We are indebted for the engravings to Gust. Ryd, of the Atlas Works, who was recently a World's Fair visitor. Geo. Carlson, 850 Seminary avenue, Chicago, will cheer-

THE TROUBLESOME TRANSFER.

THE street urchin, the transfer check and the dishonest conductor have succeeded in the past in defrauding the West End of Boston in this manner. The inhabitants of East Boston on landing at the Ferry have long been importuned for their transfer slips, and, thinking to give the boys a free ride, have presented them to the little beggars. The young rascals, however, waited until a sufficient number had been collected and then turned them over to the third party for a small consideration. The slips would then be turned in as fares by the various conductors initiated and the road was made loser to the extent of as many cash fares. Six conductors are now looking for other means of livelihood.

IN SALT LAKE.

LITTLE Johnny and Willie of Salt Lake City find a new amusement in electrical researches with the street railway circuit as an experimental device. A guy wire through the breaking of the insulator became charged, and the small boy, on ascertaining this highly interesting condition, improved matters by throwing over the live wire a long piece of wire used in hay-baling. With this, dogs were shocked and cats electrocuted with the unvarying joy evinced by boys and vivisectionists. Two good little boys, however, sons of the Episcopal clergyman, tried to swing on the new plaything and in consequence have burned hands and a very tired feeling.

A BACK PLATFORM ROMANCE.

CUPID is not only no respecter of persons, but seems also to have little regard for place. At least, one of Captain Hurt's conductors so thinks, and all Atlanta thinks so with him.

One of the Captain's conductors is a ruddy-faced, heavy-set, dark-eyed young man with a wavy mustache, and tender, loving heart. One day as he was on his usual trip to the Ponce de Leon springs, two stylishly dressed school girls, of the best type of Southern ladies, boarded his car. Both fair and fare became a hazy unreality to the young conductor, and before he was aware the little god had aimed a deadly electric shaft at his manly blue-coated bosom.

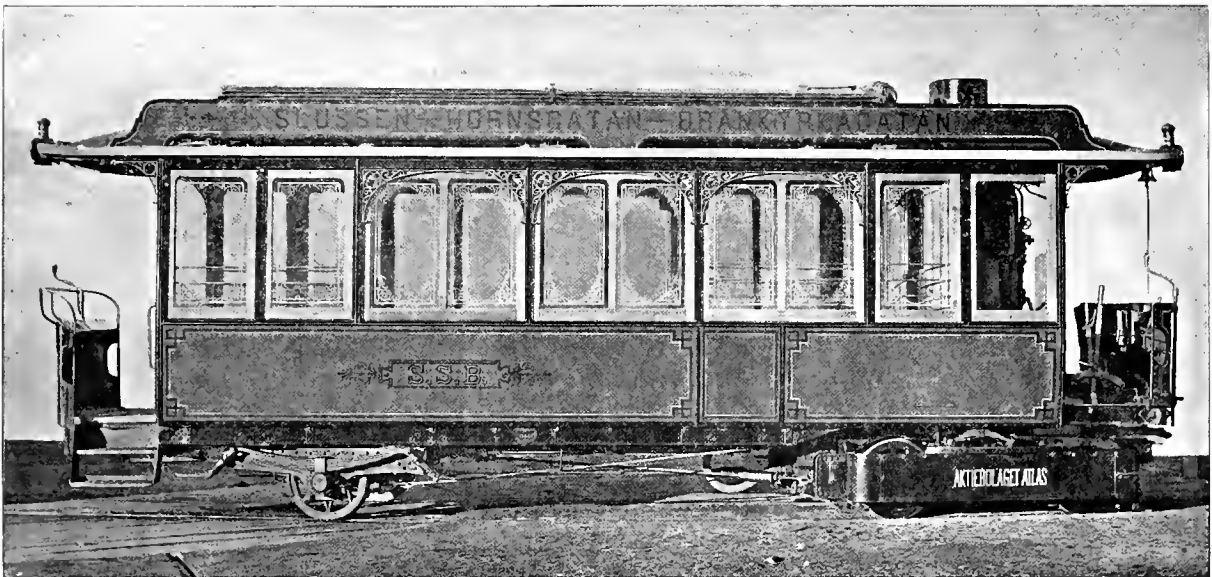

SIDE VIEW STEAM MOTOR USED AT STOCKHOLM, SWEDEN.

IF DOCTORS DISAGREE.

RESPECTFULLY we ask the New York, Brooklyn and other city journals, whose trolley howls have rent the atmosphere, to glance at the following from the Louisville Courier-Journal:

"In many journals the headlines over reports of trolley and cable car accidents entirely ignore the legal doctrine of contributory negligence. Probably in a large majority of cases the injury is directly the result of the recklessness of the person injured. But, as a general rule, the report is introduced to the reader by a headline suggesting the sacrifice of another victim to the criminal carelessness of the people who operate the road. There can be no increase in the rapidity of transit without a corresponding increase of danger. The elevated car, as well as the street grade car; the horse car, as well as the cable or trolley car, carry danger with them. The degree of danger is in proportion to the velocity of motion and the all important factor in rapid transit of reduction of time lost in stoppage. In most cities more rapid transit costs the passenger no more money."

She smiled. He reciprocated. The deed was done. Beyond the help of a 50-horse-power motor, the conductor was head over heels in love.

As the fair passenger descended from the car, the darling knight of the bell pressed his card in her little hand with fond hope and palpitating heart.

A little later a letter from the young lady gave the young man the most severe lecture on the propriety of approaching young ladies. He answered with an abject apology, but said he couldn't help it if fifty Captain Hurts had seen the deed.

The letter was answered, and the course of true love, contrary to proverbs, ran so smoothly that the young lady has recently left her lovely country home to buy her trosseau in Atlanta.

All of which goes to show that the coachman has resigned in favor of electricity.

THE great city of London is without regular service of all-night cars or even omnibuses. The street cars do not venture out until after 4 o'clock in the morning and are scarce even then.

ELEVATED VS. UNDERGROUND ELECTRIC TRACTION IN ENGLAND.

THE City & South London, the underground electric road in the great metropolis, has been in operation now nearly three years, and the London Electrician publishes a diagram in which the earnings and operating expenses are compared with those of the elevated in Liverpool. The operating conditions would appear to be under many similar conditions, both using a third rail for the conductor from which the current is taken by a sliding shoe. The London underground road operates trains consisting of a locomotive, which carries no passengers, and three passenger coaches. The Liverpool road operates trains of two passenger cars, each of which has a motor equipment. A comparison of cost of construction and operating expenses is as follows:

	City and South London Railway.	Liverpool Overhead Railway.
Length of line open.....	3 1/8 miles	5 1/8 miles
Total capital expended on line open.....	£873,000	£528,000
Capital expenditure per mile of line open.....	£280,000	£103,000
Present rate of passenger traffic per annum.....	6 1/4 million	4 1/3 million
"Loco" and generating expenses per train mile.....	6.48d	4d
Passenger earnings per train mile run.....	24.7d	26.6d

From this it will be seen that although the underground has been in operation over two years and the elevated about six months, the latter shows an economy in operation of over 50 per cent per train mile, while the difference in earnings is less than 2 pence per train mile. Also that construction expense is almost three times as great for the underground as for the elevated. It is also a question as to whether the underground road can much further reduce expenses, as a heavy reduction has already been made as shown by the following diagram:

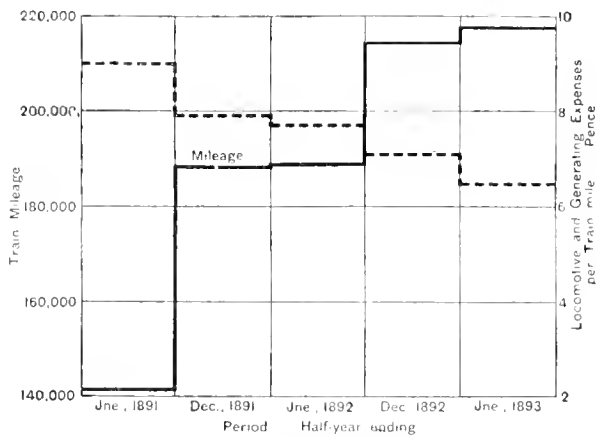

There certainly can be no question as to the popularity of an elevated line over one underground. The former, also, is a constant advertisement of itself, while the other is visible only by an elevator descent into the bowels of the earth. Our own American rapid transit commissions, or what is left of them, might do well to carefully study this little argument in figures.

NORTH CHICAGO ROAD WILL NOT INCREASE ITS STOCK.

A WIDESPREAD report that the North Chicago Railway Company was about to follow the example of the West Chicago Street Railroad Company, in issuing \$1,100,000 in new stock, has been peremptorily denied by Mr. Yerkes. The rumorists gave color to their ideas by asserting the reason of the increase to be the contemplation of a new tunnel to connect the North and South divisions of Chicago.

Mr. Yerkes, in speaking of the rather acrimonious discussion between the West Side Company and the Stock Exchange, says: "The fact that the West Chicago Company did not first inform the Exchange of the increase brought about a strained relationship, which is now smoothed over. I would also add that no one knew positively that there would be an increase in stock and there could therefore be no inside trading. Some of the new stock will be issued for improvement, but no great work is to be done."

The late stringency in the money market has had its effect on street traffic in Chicago, despite the millions of visitors who have been in the city. The difference, however, is not of moment, and affects only pleasure riding.

TROLLEY MALARIA.

THE last and greatest danger of the trolley system as unfolded by the Brooklyn Times, is that the overturning of the earth in the reconstruction of road beds will fill the air with miasma colic, and perhaps be conducive to corns. This medical authority says: "As soon as the company begins work on many streets malaria is confidently expected to become epidemic." To our own untherapeutic intellect the difference between the malaria and sickness occasioned by the introduction of the trolley may be offset by the constant menace to human life that the horse car affords. The faces of several thousand animals dried up and blown to the four winds of heaven may be innocuous to Brooklynites, but as for the rest of the world, give us good clean trolley miasma.

WHAT KILLED HIM?

WE have had previous occasion to compliment British coroner's juries and we take this opportunity to further felicitate the race which produced the jury that gave the following verdict, after duly sitting on the body of Richard Roe, Esq:

"The jury returned a verdict of 'Death from old age and debility, possibly accelerated by an accidental injury sustained by being knocked down by a bicycle and then run over by a tram.'"

The paper gives no comment on the verdict, but it really seems that some of the enumerated causes might have caused the old man's death.

A GUERNSEY RAILWAY.

JUST why the Isle of Man and the smaller isle of Guernsey should be so enterprising in the matter of electric traction our occidental view is unable to discern. Be what it may both of these appendages of the parent Britannia have electric railways.

Guernsey's tramway is a mild surprise to the Johnny Bull, one of whom says in a recent article: "One of the first things which strike the stranger as he lands at Guernsey, and begins to use his eyes, is a curious arrangement of gallows-posts erected at intervals with wires running all along between. Before he has had time to compute the probable proportion of criminals in the population which could necessitate so lavish a system of hanging, and to regret his too hasty arrival on the island, a full tram car will dawn upon his horizon, running swiftly along without horses and apparently connected by a fishing rod with the wires overhead. Then, if he be an electrician, and has recently had occasion to

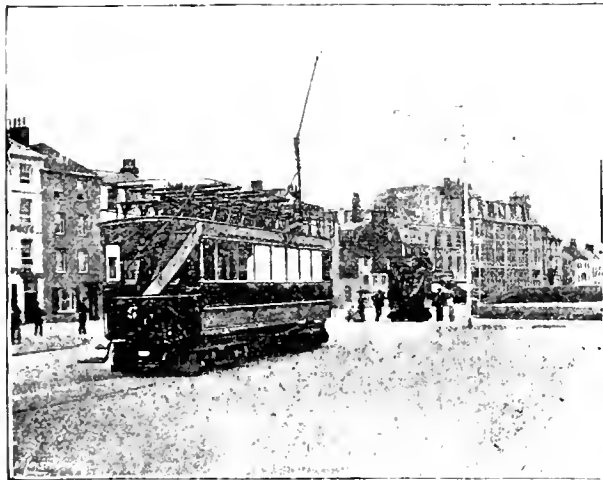

GUERNSEY'S TRAMWAY.

study the subject, it may occur to him that this is an overhead trolley electric tram line, with an earth return, like the one at Leeds."

The Guernsey line is nearly three miles long and runs an equipment of nine cars, carrying an average of 3,000 passengers a day at a uniform rate of two cents for any distance. The power plant is a wonderfully neat and compact arrangement of two 25-nominal-horse-power Marshall engines equal to 100 indicated horse-power as a maximum; two Siemens generators each giving out 100 amperes at 500 volts, and boilers so piped that they are interchangeable. The cars are equipped with Siemens motors driving by chain gear and running from 5 to 12 miles an hour. The cost of the electrical equipment is said to have been about \$20,000 with an additional \$1,000 for the reserve plant. As the line was a disused steam road most of the track was ready to bond without additional cost. The line is giving satisfaction with a profit to the company.

PLAIN ARGUMENT IN FAVOR OF GROUNDING.

IT may help those who are meeting with the opposition of insurance companies, in the matter of selling power from grounded (or "earthed") railway circuits, to be able to refer to the following article from the London Electrical Review. Under the heading, "Earthing up to Date," it says:—

"Prevailing practice and prejudice are powerful obstacles to progress and improvement, and in no branch of the electrical industry is this so evident as in the matter of earthing one of the mains of an electric distribution system. There are many staunch advocates of so doing, and it is a marvel that anyone should remain unconvinced of its benefits in every respect when the facts are so simple to grasp. It may be unwelcome and irksome to some of our readers to have trueisms repeated, but for the benefit of many who are interested, and have not followed up the subject, we must introduce some repetitions. The troubles with electric mains may be indexed by the simple word leakage. Gas and water pipes, and the mains themselves, are destroyed by the leakage currents; buildings are fired by leakage currents, and telephones and telegraphs are disturbed by the leakage. All these troubles will continue to increase in direct ratio to the extension of the supply network, and the effect on any particular faulty spot in the system is greatly enhanced by the increase of leakage through extension. Those who do not advocate earthing, claim that by not earthing there is greater facility for testing to earth; but if this statement is put in other words it will be better understood, viz., there is a greater facility for finding out the faulty condition of the system, and involving one in the vain effort to cure it. It gives no clue for preventing it; and in this vain endeavour to improvement, higher insulation and increased multiplication of "ignition" fuses, an increase of crackable pottery, and now the extra complication of double-pole section switches are imposed on the contractor, to retard his industry. This condition of affairs has been considerably sustained by a strong following of a well-devised advertisement known as insurance rules, against which electrical lambs merely meekly bleat, instead of acting on their convictions, and carrying out the work on a basis that has every prospect of being an absolute cure, and, in any case, must certainly reduce the leakage disease. The story, however, is an old one, but



must be repeated to complete the article. Take, as an example, Fig. 1. Installation A leaks at x, and installation B at z; the current takes its course through earth, and does what it likes; but now connect the — main to earth, and the result is that the fault, x, is harmless, and the leakage through z is confined to its own installation. There is

no longer any circuitous course for the current to take and to damage gas and water pipes, and influence telephones, etc.; the earth of the — main is at the door or point of connection. The only difference to the former condition of leakage introduced by earthing the — main, is to effect the confinement of any leakage to each individual installation, or to remove it altogether, which is more likely. We say the only difference, because before wilfully earthing, the main was already earthed at numerous doubtful points over the system. Simultaneously with earthing the system, or as soon thereafter as possible, it would be the duty of the authorities to connect the faulty side of each installation to the earthed main, and if this is effectually done, the earth leakage would be reduced to such a minimum that the trouble might be considered removed. It cannot be said either that this is any very great undertaking; a test is a simple and quick operation, and the wires are easily reversed at the D. P. fuse. It should, moreover, well repay a supply company by saving of leakage."

This is the opinion of a conservative English journal and yet there are numerous "progressive" Americans that oppose the practice. Prejudice is not evidently confined entirely to the stubborn Englishman.

BOYS STEALING RIDES ON CARS.

THE article in our last issue under the above title has drawn out a large number of letters from street railway managers, favorable to the passage and enforcement of the municipal regulations suggested. We cited Cleveland and Kansas City as two cities where such ordinances were already in effect, and now add Toledo, Ohio, to the list. In that city an ordinance has been in force for several years past, and as General Manager Lang informs us, has proved very beneficial to both the public and the company. It may prove suggestive to others desiring to frame such a law and we give it in full as follows:—

THE TOLEDO ORDINANCE.

"The act of jumping on, or hanging on, to street cars, carriages, sleighs, or other vehicles, while in motion in the streets of the city of Toledo, shall be considered an offense, and any person or persons who shall get upon, or attempt to get upon, any street car, for the purpose of obtaining a ride thereon, without paying his or her fare, or if a carriage, sleigh or other vehicle, without the consent of the owner or driver thereof be first obtained, shall be deemed guilty of an offense, and shall be subject to arrest by any person or persons having police authority, and upon conviction thereof shall be liable to a fine of not less than one dollar nor more than five dollars; or to confinement in the city prison, or such place as may be hereafter provided by the city council, not less than six nor more than twenty-four hours; or both, in the discretion of the court."

As will be noted the fine is nominal and yet amply sufficient to act as a lesson to offenders. It also does not

compel the court to impose the fine unless in its judgment the case warrants it, as frequently the arrest of the offender is sufficient punishment. In some respects the Toledo ordinance is better than those quoted last month, and certainly is simple, comprehensive and effective.

STATION FORCE.

BY CHARLES BODE, CHIEF ENGINEER NORTH SIDE RAILWAY
FORT WORTH, TEX.

IN your last issue of THE REVIEW I noticed a comparison of station forces and their relative outputs. These comparisons I have always found very valuable, as they are apt to inspire those in charge of their respective departments to do better, or at least, do as well. In concluding your article you state that it should be good practice with modern machinery for each station employe to represent three cars in the case of small stations. I think, with the proper machinery, I could make each man represent five cars. Our practice has been 4.25 per man, as follows: One cross compound condensing engine 300-horse-power; three 62 kilowatt generators; one 500-horse-power boiler with coal tank and elevator and automatic stoker (on account of the quality of the coal this stoker is idle and the fire managed by hand); two common tubular boilers, 65-horse-power each. These latter boilers do the work while the larger boiler is cleaned and repaired. The crew consists of two engineers and two firemen. Coal consumption is 5½ tons per day; average horse-power 225. Seventeen cars run seventeen hours a day. The same crew could handle machines heavy enough to operate twenty-five cars. I do not consider our station an ideal one, as it admits of many improvements. We have not had a shut down for months, and then only for a few minutes.

DIDN'T CARE IF HE WAS A GRIPMAN.

THE Van Beer's panel, which was loaned by Mr. Chas. T. Yerkes to the Belgian section of the art gallery, attracts all lovers of the Belgian painters delicate touch and expression.

The Belgian commissioner is a haughty young man with a brown mustache and with him spake a stout woman with tortoise shell lorgnettes.

"What can I get that picture of Ada Rehan for?"

"I don't know," replied the haughty young man.

"Can't you estimate?"

"I cannot, madam."

"Why not?"

"Because it is owned by Mr. Yerkes."

"And who is this Mr. Yerkes?"

"He's a street car man."

"Well," with a sniff, "I should think in these hard times a street car man would be glad to sell a picture."

"You forget madam he is the conductor of a great street railway system."

"Well," with an expressive shrug, "I don't care if he is a gripman." And she went thence.

CITY AND SOUTH LONDON.

IT SAGGED.

Failure of the Chicago & Central Indiana Scheme.

OUR readers have had abundant opportunity to read detailed descriptions of the City & South London underground electric railway, but now, for the first time, a photograph of one of the trains is presented to the public. The platforms are carried on



INTERIOR CITY AND SOUTH LONDON CAR.

the extended frames of the bogie trucks, instead of being continuous with the car floor. Guards are kept at each platform to open and close gates and doors as on our elevated roads. Side seats are used. The lamps for

THE great Chicago & Central Indiana railway scheme was found to be too long and in consequence it sagged woefully. T. J. Pennington, of air ship fame, was the principal promoter of the scheme, but claimed that an English capitalist yclept T. Wilkinson, had \$2,000,000 back of Pennington's ideas. W. D. Keep, a Chicago attorney, was put forward as a director, to give color to the solidity of the scheme. M. S. Foster, also of Chicago, is said to have held stock in consideration of the use of his name as director.

Mr. Keep, in an interview with a REVIEW representative, said: "I have had no stock in Pennington's scheme, hold no stock in the Chicago & Central Indiana road and I wouldn't take it as a gift. The use of my name is unauthorized and as far as my acquaintance goes I haven't seen him for six months. The scheme was investigated by W. K. Carlisle for me some time ago and reported as all on paper." Mr. Carlisle was out of the city and Mr. Foster could not be found so that the REVIEW investigation ends as to the men.

The Illinois Steel Company knows of no rail contract and the General Electric is unacquainted with any electricity supplies that have gone into the maw of the Pennington scheme. In fact the whole affair was so young that it is not likely that anyone has been investing in Mr. Air-ship Pennington's latest. The chief losers are the few laborers who were on the grounds to make a show of working.

AN English coroner's jury, sitting on what remained of a line repairer, who fell from a lofty pole while trimming an arc light, decided that the fall and not the shock was

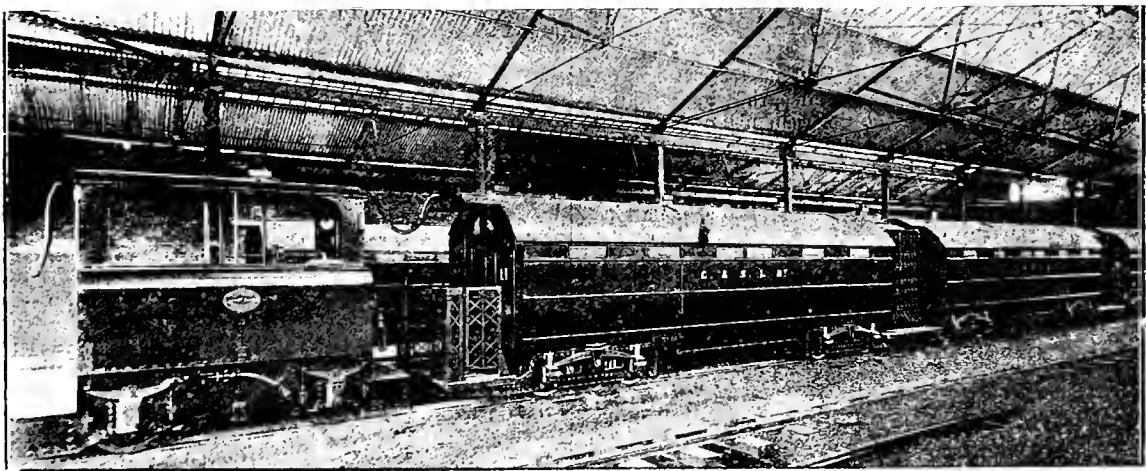

ELECTRIC TRAIN CITY AND SOUTH LONDON RAILWAY.

lighting the interior of the cars are said to vary greatly in brightness on account of the changes in voltage. The engraving is reproduced from the London Electrical Engineer.

the cause of death, although the "the shock was doubtless sufficient to startle him." Such unrestrained vigor of expression is new to American readers, whose appetite has been raised on "Juggernauting" and such.

STREET RAILWAY LAW.

EDITED BY MR. FRANK HUMBOLDT CLARK, ATTORNEY AT LAW, CHICAGO.

Injury to Child by Car Left with Unfastened Brakes.

Where a street railway company leaves a car standing in the street with unfastened brakes, contrary to the city ordinances, it is not liable to a child who goes on the car to play, and is injured by the flying back of the brake.

In the opinion the Court said:—

Leaving the cars in the street as it did, was not an invitation or license by the defendant to him to play upon them, even though defendant knew that they were calculated to attract children, and did in fact attract them. Knowledge on the defendant's part that they attracted children was not an invitation or license to them; otherwise the fact that one knowingly maintained on his own premises an object that allured children, would constitute an invitation to them. Nor could an invitation or license be implied from the negligence of the defendant, if there was negligence in leaving the cars in the street. The most that can be said for the plaintiff is that the defendant, knowing that the cars would be and were attractive to children, was bound to anticipate what actually occurred, and to exercise a corresponding degree of care to see that the cars were securely fastened and guarded, and is liable for an injury occurring to the plaintiff's intestate, through its failure to do so. This assumes that all that the plaintiff is required to show is that his intestate acted as reasonably might be expected of him. But he might do that and still be a wrongdoer and trespasser, and contribute by his conduct to the injury which he received. If he did, then the fact of his youth, and the fact that the defendant's negligence also contributed to it, would not render the defendant liable. If the cars had been set in motion by other children, and the plaintiff's intestate had been injured by them while lawfully upon the highway, the defendant clearly would have been liable. But he was using the highway and the cars for play, and was a joint actor with other children in causing that to happen which resulted in his injury. We might fairly assume, if it were necessary, that a boy ten years of age and of ordinary intelligence would know that he had no right to play on cars which a street railway company had left standing in the street. Upon the declaration as we interpret it, we do not think that, under the decisions in this state, the plaintiff is entitled to recover.

(Supreme Court of Massachusetts. *Gay vs. Essex Electric Street R. Co.* 8 Notes of Cases 52).

[NOTE.—"A child injured while trespassing has no right of action, unless injured by negligence of defendant when the injury might have been avoided by ordinary care on defendant's part. But when a child of tender years commits a mere technical trespass, and is injured by agencies that to an adult would be open and obvious warnings of danger, but not so to a child, he is not debarred from recovering, if the things instrumental in his injury were left exposed and unguarded and were of such a character as to be likely to attract children, excite their curiosity and lead to their injury while they were pursuing their childish instincts, such dangerous and attractive instrumentalities become an invitation by implication. This is the principle of the turn-table cases, in which children have been allowed to recover for injuries caused by playing with railroad turn-tables which were left unfastened and open to public access. American and English Encyclopaedia of Law."]

Collision with Grip-Car—Evidence—Distance Within Which Car Can be Stopped.

In an action against a city street railway company to recover damages for negligently colliding with a horse-car at an intersection of the track-ways and thereby causing the death of the plaintiff's intestate, it is competent to show, as bearing on the question of negligence, that defendant's grip-car was not so near the point when the horse-car was crossing the cable track, as to make it impossible to stop it before it came in contact with the horse-car.

In such case a witness testifying as to the possibility of stopping a cable car within a stated distance, can answer as to the source and basis of his knowledge. If such witness has been in the service of street car companies, a reference by him to previous experience and observation, will not be improper, because it may tend to show that he was qualified to give evidence as to the distance within which it was possible to stop such a car.

(Supreme Court of Illinois. *Chicago City Railway Co. vs. McLaughlin.* 25 Chicago Legal News 396.)

Electric Street Railway—Teamster Driving in Track.

A teamster driving along the track of an electric street railway, is not guilty of negligence in failing to get off the track when the car comes along, when he tries his best so to do, and would have done so but for the reason that the rails were wet and slippery, and the ice and snow thereon held his wheels, nor in turning towards the other track instead of attempting to turn out on the side away from it, where he had no reason to anticipate that he would be unable to drive off the track at any time, and get out of the way of a car.

The conductor on an electric street car, who sees a loaded team upon the track, endeavoring to get off, but unable to do so because the wheel slipped along the rail, who has ample time to stop the car before it strikes the wagon, is guilty of negligence where he does not attempt to slacken the speed of the car until within twenty feet of the wagon.

(Supreme Court of Wisconsin. *Will vs. West Side R. Co.* 54 Northwestern Reporter 30.)

Injury to Passenger Alighting—Sudden Starting of Car.

If the conductor of a street railroad car negligently fails to observe whether a passenger has alighted, or knowing that he has not, negligently starts the car too soon, and in consequence of that, a sudden jerk of the car takes place and throws him down, and is the immediate cause of his falling and injury, and the accident would not have happened but for that fact, such negligence as might be imputed to him in being on the steps of the car cannot, under the circumstances, be properly held to be contributory negligence.

It is the duty of a street railroad company to stop when a passenger is about to alight, and not to start the car until he has alighted.

(Supreme Court of the United States. *Washington & G. R. Co. vs. Tobriner*. 147 United States Reports 571.)

Crowded Condition of Car—Passenger Standing on Step—Contributory Negligence—Directions of Driver.

A passenger injured by being knocked off the front platform of a street car, was not guilty of contributory negligence as matter of law, in riding on the step outside of the gate, where the car was so crowded that there was no other available space, and he was received as a passenger, and was by the driver permitted and directed to take such position.

Standing on the front platform of a street car, outside of the gate, by the permission or direction of the driver, is not so obviously dangerous as to prevent a recovery by a passenger who was knocked off the steps without his fault.

A statute providing that street railway companies in a certain city shall not be liable for injuries to persons caused by their getting on or off the cars at the front end, does not apply to a passenger who when injured was not getting on or off, but was riding by direction of the driver on the steps of the front platform.

(Supreme Court of Missouri. *Seymour vs. Citizens R. Co.* 21 Southwestern Reporter 739.)

Center Pole too Near Track—Injury to Passenger—Contributory Negligence in Having Arm Out of Window.

A passenger upon an electric street car is not guilty of negligence *per se* which will prevent her recovery for injuries from her arm coming in contact with a center pole set too near the track, in resting her elbow upon the sill of the car window, from which it is made to protrude by a sudden motion of the car.

(United States Circuit Court, Eastern District of Louisiana. *Schneider vs. New Orleans & C. R. Co.* 54 Federal Reporter 466.)

Action for Death of Child—Excessive Speed of Car—Team Frightened.

A street railway company is not guilty of culpable negligence, rendering it liable for the death of a child, because its car was going faster than the maximum speed allowed by the city ordinance, where the mules hitched to the car became frightened at an engine and started up the street, and before they had gone more than about fifty yards, the child ran in front of the car, only about three or four feet in advance of the mules, and so near that the driver was unable to avoid the accident.

(Supreme Court of Virginia. *Trumbo vs. City Street Car Co.* 17 Southeastern Reporter 124.)

Injury to Person at Street Crossing—Failure to Ring Gong—City Ordinance.

Failure to ring the gong of a cable car while passing a street crossing is negligence *per se*—especially where

such failure violates an ordinance of the city requiring the gong to be kept sounding until the crossing shall have been passed.

A street railway company is not relieved from liability for injuries occurring because of failure to ring the gong of a cable car while passing a crossing as required by a city ordinance, by the fact that the ordinance in terms requires the persons immediately in charge of the car, and not the company, to give the warning.

Failure to ring the gong upon a cable car while passing a crossing is not excused by the fact that the gripman's hands were otherwise necessarily engaged, and that the conductor was temporarily absent from his post.

A person crossing a cable street railway track at a street corner on a dark and foggy night, was not, as a matter of law, guilty of negligence contributing to his being struck by a car passing the intersection of the street without the warning required by ordinance, where a car going the other way somewhat obstructs the view, and he heard no warning from other persons, although the car which struck him had a headlight, and bystanders shouted to him to get out of the way.

(Supreme Court of California. *Driscoll vs. Market Street Cable R. Co.* 32 Pacific Reporter 591.)

Passenger Carried by Destination—Alighting Before Car Has Stopped.

The alighting from a street car before it has come to a stop, by a passenger who has been carried by her destination through the conductor's carelessness, cannot, as a matter of law, be declared negligence, regardless of attending circumstances, such as the speed of the car and the conduct of the conductor.

(Missouri Court of Appeals. *Duncan vs. Wyatt Park R. Co.* 48 Missouri Appellate Reports 659.)

AS HARTFORD SEES US.

A CORRESPONDENT of the Hartford Times writes back to his paper in regard to Chicago street cars. He observes:—

"The Chicago cable or electric car waits for nobody. It never comes to a full stop until the terminus of the line is reached. Eastern people stand on the corner and make signs to the conductors, but it is no use. If you want to get aboard you have to step lively and jump for the car. Chicago people seem to have no trouble in hopping on and off the cars. The women do it as gracefully as the men, and if anything were needed to refute the libel on the size of a Chicago girl's foot, it is the agility with which she transfers it from the crosswalk to a fast moving car, or vice versa." We fear the young writer has tarried too long at the seductive California orange cider.

THOMAS ROBB, timekeeper for the Brooklyn Heights Railway Company, entered fictitious names on the pay roll and drew the money to the extent of \$3,000. He is in jail. Robb is 46 years old and worked for \$14 a week.

THE VARIATION OF COAL CONSUMPTION IN POWER PLANTS.

THE fact that the coal consumption of a railway station does not vary as the passengers carried, is well known to those who have kept daily records. The accompanying curves are the result of a study to determine upon what item the fuel account depends. The road on which the observations were made is operating on an average forty cars. The lines are level, with a considerable number of curves. Machinery aggregating 900-horse-power maximum capacity is kept in operation. The curves show the record of a month's run. While the results do not show that the fuel bill is dependent on any one item, nor do they entirely settle the question as to the reason of the variation in the coal consumption, they nevertheless help to throw light on some points. As would be expected, the coal used is most nearly

economical to run trailers than to run extra motors cars and also that more people hauled per motor calls for very little more power. This also accords with the fact that the more people hauled per motorman the better it is for the company's financial department.

THE HISTORIC SITE OF THE GREEN BAY POWER HOUSE.

THE recent purchase of the house and grounds of Mrs. H. O. Crane, of Green Bay, Wis., by the Green Bay Electric Railway Company, for a power house site, aroused the latent memories of the oldest inhabitant.

The location is historic, dating back to the "Green Bay settlement" times of 1829. Here Judge Arndt established the first "tavern" in the settlement and the first ferry

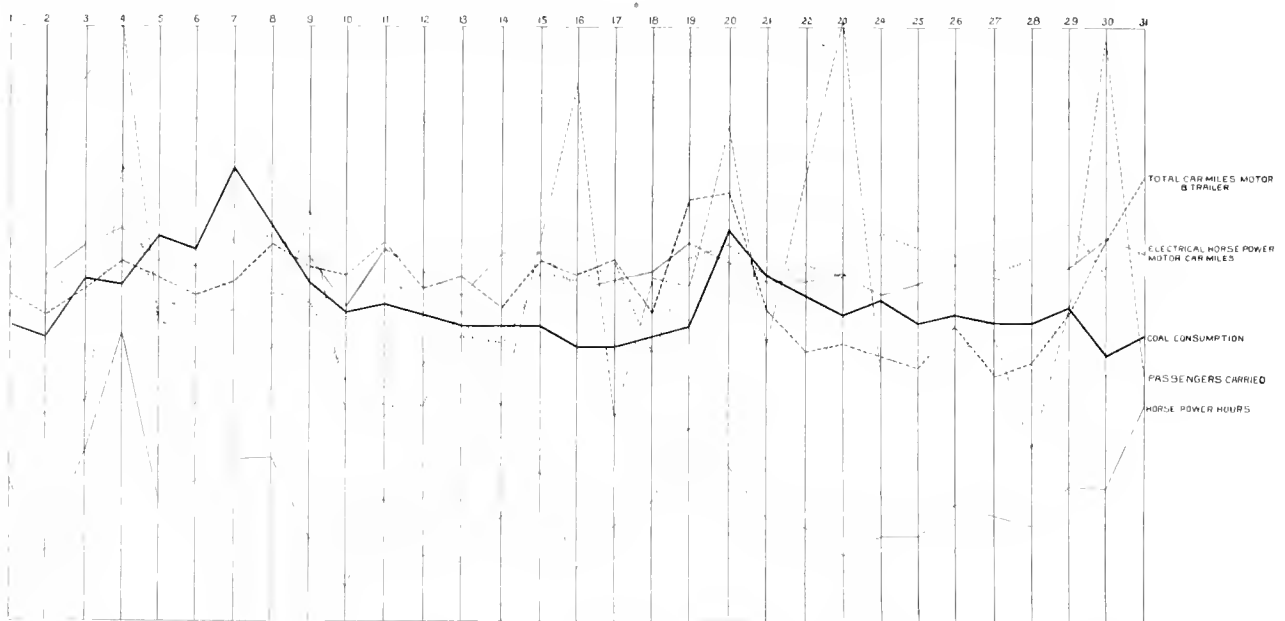

CURVES SHOWING RELATIVE VARIATION OF FUEL, HORSE-POWER, PASSENGERS, MOTOR CAR MILES, ELECTRICAL HORSE-POWER AND CAR MILES.

dependent on the horse-power hours. These two items do not vary exactly in the same ratio, but it is thought by those in charge that the discrepancies between these items can be accounted for by variations in the quality of fuel, in the firing, slight changes made on the engines, draught, etc. The horse-power hours in turn are most nearly dependent on the motor car miles, the trailers not having much influence. This is as was anticipated, because ammeter readings taken on the cars showed that there was but little difference in the current consumption of the motors with and without trailers. So many items come in between the coal pile and the motor that it is hard to determine exactly what causes the variations. The month of July, during which the record was taken, was uniformly dry and temperate, but there are, nevertheless, many unaccountable differences between the different items.

The main useful lesson taught by these curves is that within the limits of public accommodation it is more

across the Fox river to the Fort Howard military reservation. The place is redolent of anecdote of the old Martinet, Maj. Twiggs, U. S. A., afterward general, who was wont to publicly cowhide his men if the stringent military rules were overstepped. A drunken baker in his command once spoiled a batch of bread, for which misdemeanor summary vengeance was wreaked. The major made the unfortunate baker publicly eat a loaf of the spoiled bread without a drop of water.

On this spot the first Green Bay store was built, and here the first lake schooner, the Wisconsin, was constructed.

A tablet should mark the historic spot now taking its place in modern history by conversion of the last and greatest triumph of human intellect.

AUGUST 31 the cable car ran its last trip on the Seventh street line, St. Paul, which has just been electrically equipped. The hill line is still using cable.

DEAD WEIGHT IN CAR BODIES.

THERE has been, of late, a noticeable tendency to criticise the increased weight of car body that has followed the adoption of electricity. It has been claimed that the steam car builder, with his heavy patterns, has had too much influence on the weight of street railway rolling stock. No one ought to be better able to discuss this question than the makers themselves, who have had the opportunity of a more extended observation than anyone else. The REVIEW has communicated with several and their answers present all sides of the question.

BROWNELL CAR COMPANY.

F. B. Brownell looks at the problem more from a consumer's standpoint. He says:—

"The use of mechanical motors for street car propulsion has developed a demand for larger cars, which, of necessity, must be heavier in proportion. Our idea is that every pound of dead weight in cars, over and above what is necessary for requisite strength, is a detriment and means additional constant expense for fuel when the car is in operation. Especially is this item heavy on electric roads, where the consumption of power is in direct proportion to the load carried. It is for railroad operators to decide whether it is more economical to keep up car equipments than track repairs, fuel and other machinery. It is possible that with electric motors additional weight might be required to give necessary traction. We are still making a study to build our cars as light as is possible, consistent with the service and loads carried."

ANOTHER PROMINENT CAR BUILDER

whom we are not at liberty to quote, expresses the opinion that the old idea derived from carriage building, of combining the greatest strength and lightness, was the correct one. When steam car makers began on street cars they brought in unnecessary weight, greatly to the detriment of the roadbed and equipment. The custom recently adopted of having the truck furnished by one party, the car body by another and the junction made by still another is not conducive to the life of the car body. The preservation of the car body is not sufficiently thought of by most truck builders.

LAMOKIN CAR WORKS.

Henry Cochran, superintendent of the Lamokin Car Works, says:—

"The car bodies built by us, for electric service, are about 1,000 pounds heavier than the horse car of the same size. This has been found necessary, as the construction of the horse car was too light to stand the strains called for by electric service. One reason for this is the higher rate of speed. The average motorman delights in showing the speed of his car, giving the motor all the current he can, and before he knows it he is at the next street and some one is there to get on. He throws off the current and sets his brake as hard as he can, bringing the

car up with a jerk. It is this way of handling a car which tries every joint in it, and this is why we found it necessary to make the car heavier. Another reason is the rough and hurried manner in which the road bed, ties, and rails are put down. We find that unless cars are built very strong that we get the blame, no matter what the conditions of the road bed. Some of the trucks in the market afford no support for the body except near the ends. This necessitates heavier sills, to enable the body to support itself. Again, many railway managers insist on carrying 18 and 20 foot car bodies on 6 to 6½ foot wheel base. They must also have a vestibule on each end of this body, or a large roomy platform, and the builder must build strong enough to meet all these things or his cars are no good, and so I might go on citing many reasons for heavier construction.

"Notwithstanding what may be said to the contrary, we had to come to it. The car body has not increased in the same ratio as the running gear. The old horse car gear weighed from 900 to 1,200 pounds, whereas the electric truck weighs anywhere from 3,000 to 5,000 pounds. Add to this 5,000 more for motors and fittings and you have a total of 8,000 to 10,000 pounds against the old gear. This mass of steel and iron is almost rigid in comparison to the old gear, and to this the car body is bolted and is whirled and twisted along at a gait of from 15 to 20 miles per hour with sudden starts and stops. Don't you think it is necessary to build them heavier? I do not think there is much needless weight used in steam cars. Take a car of the heaviest construction and in three years, after running on express time with the use of the air brake, every joint in it will work.

"My opinion is a car cannot be too strong, as you cannot form an adequate idea of the enormous strains consequent on high speed and sudden starts and stops."

It seems to the REVIEW that the questions as to whether car bodies or tracks are easier to repair cannot be discussed, for the reason that they are interdependent. The idea that car bodies should be heavier to compensate for the increased shaking up they get with rough tracks, is all right when considered from the standpoint of the car builder, who acts in self defense, but it is not all right from the operator's standpoint. A poor track demands a heavy car, which in turn acts to greatly increase the roughness of the road. A good road will admit of a light car, which in turn saves the roadbed and rail joints. The argument is unquestionably in favor of smooth tracks and light cars. The horse cars running as feeders to the Chicago cable systems, are run as trailers on the cable trains, yet there is probably as much wear and tear per mile on them, when on the horse lines, as on the cable, for the reason that the cable lines are so much smoother. At least the light cars in this instance seem to stand up very well, although the suddenness of starting and stopping is as great as on any road. As we said before, the car builders have been driven to heavier construction because of the rough treatment their cars receive, and this is a fault that can only be corrected by the street railways themselves by track improvement.

THE BRIGANTINE TRANSIT COMPANY.

SOME highly learned old economist once said that he who makes two blades of grass grow where formerly but one existed is a benefactor of mankind. Just what that philosopher would say of a man who enables a thousand people to travel where one could not formerly go, may be supposed.

Such is the deed, however, performed by the Brigantine Transit Company of Brigantine Island, N. J. Brigantine Island, across Aboscon Inlet from Atlantic City, has for many years been a favorite resort for hunters and fishermen, and was more inhabited by retiring folk who liked to be just near enough, and not

The plans for the entire undertaking were safely entrusted to Chas. H. Warner, of New York, as consulting, and F. C. Bates as resident engineer.

On March 1 the railway was begun and on June 24 the first car was sent over the seven miles of single track. Just what change was wrought by the introduction of the

electrics may be read from our engravings or told by the thousands of visitors who during the summer have enjoyed the recreation of Brigantine beach. The power house and car barn shown in our engraving are situated at the middle of the line and are built with corrugated iron sides and roof. The car barn has a capacity of nine cars.

The power is furnished by two 75-horse-power Man-



FREIGHT LOCOMOTIVE.



POWER HOUSE AND CAR BARN.

POWER HOUSE SITE AS IT APPEARED LAST YEAR.

too near, the whirl of fashionable life at Atlantic City.

The great drawback to the popularity of the island and to its development into a resort of prominence was the lack of transportation facilities. The choice of travel was a la Hobson, either by sail boat, for which any price might be asked, or by train, 28 miles, at the cost of three hours' time. To develop this spot, which Dame Nature had originally intended as a resting place for weary humanity, a syndicate of Philadelphians, under the name of the Brigantine Transit Company, laid well-considered plans for a steam ferry from Atlantic City to Brigantine beach, and an electric railway the length of the island.

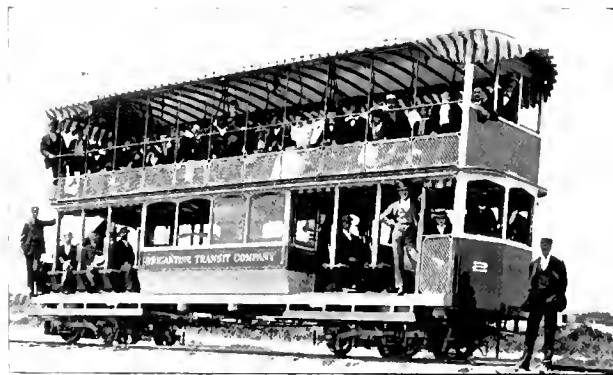

THE BRIGANTINE DOUBLE DECK CAR.

ning vertical tubular boilers, built by Bigelow & Company of New Haven, and a 150-horse-power Westinghouse compound engine coupled to a multipolar General Electric dynamo. The fuel used is pea coal and the consumption averages 3,500 pounds a day of eighteen hours.

A double wire General Electric overhead system is used, suspended by special clip and Medbury insulators, the second wire obviating an insulated feed wire and the use of overhead frogs and switches. The cars are double deckers, 38 feet long and accommodating 150 people; two waterproof 50 General Electric motors, with 9 turn armature, are used to each car, geared to thirty-

five miles an hour maximum. The steel ferry steamer operated in connection with the railway carries 250 passengers and is fitted with a 6,000 candle-power search light. The ferry schedule is 6 a. m. to 10.30 p. m., with the electric railway running half an hour later.

The traffic to Brigantine Beach has increased almost incredibly. During June the company carried 1,300 passengers, in July the number increased to 41,000 and the first half of August showed a traffic of 36,000.

The pavilions on Brigantine Beach are owned by the company and situated at the termini of the line and were built from designs of the consulting engineer.

The railway runs within a few feet of the beach in some places and in others is nearly 1,000 feet from the



THE STEAMER BRIGANTINE.

shore line, but the entire route gives a splendid view of the ocean on one side and of the salt meadows between the island and the main on the other.

The officers of the company are J. Rush Ritter, president; William Hacker, treasurer; Geo. H. Cook, secretary; and J. T. Skerrett, general manager.

THE WATER POWER ELECTRIC ROAD AT SALEVE.

AN interesting and unique mountain railway has just been put in commission at Saleve, Switzerland.

The line, to be brief, is arranged in three sections of equal length, which meet at Mounetier-Mairie. The first is to Etrembieres, the second to Veyrier, and the third to Treize-Arbres. Each line is about two miles long, with an average gradient of 1 in 100, the maximum being 1 in 20. The generating station at Arthaz is actuated by water power driving Thury dynamos direct coupled to slow speed turbines. The turbines are regulated to forty-five turns a minute, the dynamos also running at this extraordinary slow speed, being therefore very large in proportion to their output.

Each dynamo gives 275 amperes at 600 volts, and is 10 feet in diameter, the armatures measuring 8 feet 6 inches. The dynamos weigh 19 tons each. The shafts

are vertical, and, as stated, direct coupled to the turbines, the field magnets being supported on special bed-plates.

As far as we know, these machines enjoy the title to the distinction of being the largest direct current machines built of this type, but on account of the slow speed are not nearly as effective as they might be with a

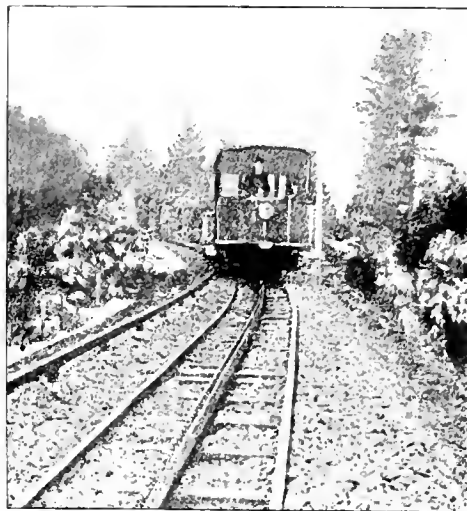

TRACK, COG AND CONDUCTOR RAILS.

little more skillful application of the very advantageous water power.

The power is taken from the Arve river, with 600-horse-power available as a minimum, with a drop from the head to the tail race of only 10 feet. To develop the power three turbines are used, one for week days' supply, one for Sundays and holidays, and one as a

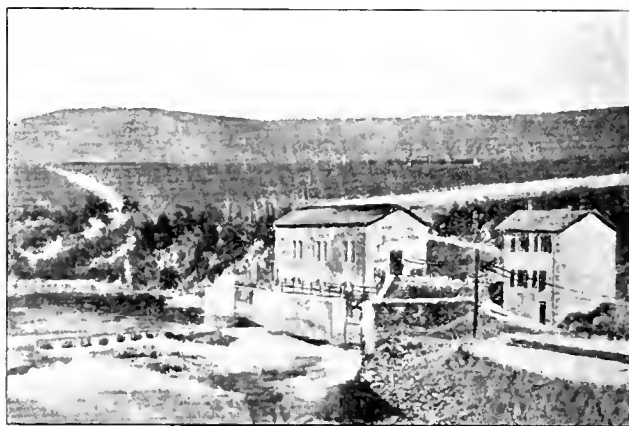

THE POWER STATION, SALEVE.

spare unit in event of accident. A small turbine is maintained in addition, driving the exciter for the large generator magnets.

A constant speed is maintained for the exciter, and as far as possible the same practice is followed with the larger machines, but the excitation of the large dynamos is controlled by an automatic governor, actuated by a relay wire.

The overhead wire supplying the conductor is carried

on strong posts. The conductor is a Vignole rail running parallel to the ordinary rail and carried by iron chairs on porcelain insulators.

A brush collects the current from the rail. An interesting feature of the economics of the line is that the third rail, being of the same section as the traction rails, may be used with the latter interchangeably when either

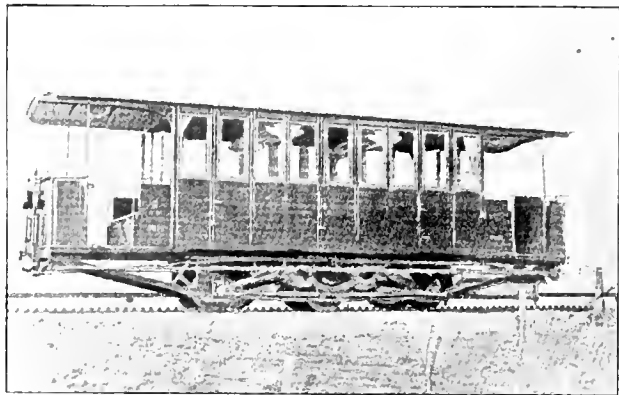

SIDE VIEW OF SALVE CAR.

becomes worn. This is made possible by the fact that the middle rail is laid reversed, to present as broad a surface as possible to the brush. There is a loss of 15 per cent of the current generated, in the conductors.

The Thury type motor is used, 4-pole, 30-horse-power, at 600 revolutions. The factor of safety is sharply looked

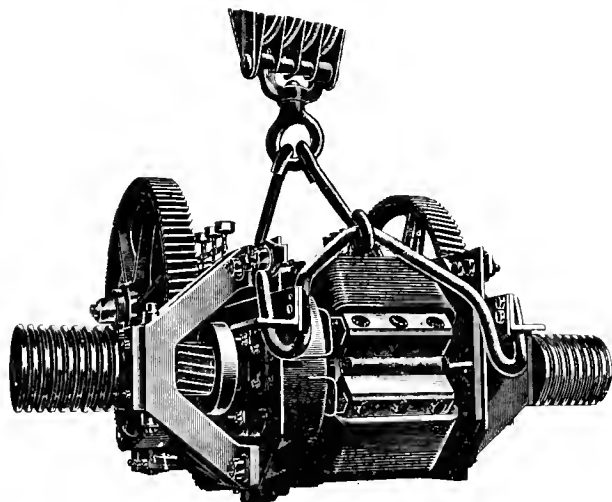

THE THURY MOTOR.

after, and the motorman has eight brakes at hand, four friction, two electric and two dead-stops. The electric brakes are the motors themselves, which may be run as generators. In addition to all this the usual ratchet device prevents running back on grades.

The cars are handsome vehicles of the combination type, and weigh 12 tons when loaded.

The motors drive pinions which gear into a rack after the method so common on the mountain railways in Switzerland and elsewhere.

PERFORMANCE OF THE OGDEN CITY STREET RAILWAY PLANT.

BY W. H. SMITH, ELECTRICIAN AND SUPERINTENDENT OF MACHINERY.

NOTING a test given by R. B. Holbrook, on the Cedar Rapids & Marion City Railway, in the August REVIEW, I thought it might be interesting to some to know what other roads are doing. The following test was selected at random from tests made covering several months of last year.

The station is equipped with two compound condensing engines of the Corliss type, 16 by 28 by 48, made by Fraser & Chalmers of Chicago, with condenser and heater; three return tubular boilers, 56 by 18 feet, with seventy 4-inch flues, made by the same company; and three 125-kilowatt Edison generators. There were run on that day, August 20, 1892, four 20-foot double truck cars equipped with two 25-horse-power single reduction Edison motors, two 16-foot cars with one 25-horse-power single reduction motor, and two eight-seat open cars equipped with Westinghouse double motors, 15-horse-power each, two to the car. Grades from 2 to 7½ per cent; running time ten miles per hour, including all stops. Coal was weighed on our own scales as we used it. The steam gauge, water meter and temperature of feed water were read every hour. Common slack coal was used at a cost per ton of \$2.

Duration of test (fire banked seven hours).....	24 hours
Average temperature of feed water.....	150 deg.
Average pounds steam pressure.....	117
Pounds of coal burned.....	7,830
Pounds of ash.....	515
Pounds actual combustion.....	7,315
Per cent of ash.....	6.5
Amount of water, 754 cubic feet, or in pounds.....	47,125
Pounds of water evaporated to one pound of coal.....	6
Pounds of water evaporated to combustion.....	6.44
Car miles.....	1,042
Cost of fuel per car mile.....	\$0.0075
Average electrical horse-power per hour.....	141
Pounds coal burned per electrical horse-power.....	3.32
Two engineers, one at \$125 per month and one at \$100.....	\$7.50
Two firemen, at \$65 per month each.....	\$4.33
One pound colored waste.....	\$0.065
One pound white waste.....	\$0.085
One gallon engine oil.....	\$0.55
One gallon cylinder oil.....	\$0.65
Cost per electrical horse-power per hour, including engineers' and firemen's salaries, coal waste and oil.....	5.8 cents

The Thompson wattmeter was used and read every twelve hours. In looking over our old reports I have found some tests that would give a better showing; but, as I have noted above, this test was taken at random from a number covering several months.

We have found that the nearer the plant has been run up to its capacity the cheaper it can be operated per car mile. We have had the same experience as to variation of fuel and steam, the car mileage track and atmosphere being equal, as one day in this climate is just like the preceding day for weeks at a time. The number of passengers carried did not seem to make any appreciable difference, and we have been, so far, unable to solve the

problem. Running condensing or non-condensing will make a difference in the coal account of about one ton per day.

A BIG BELT BUILDER.

AMONG the greatest and most flourishing industries that have built up with the progress of mechanical science is that of the belt maker. Time was when any makeshift would do the duty of a power transmitter, and the energy lost by early attempts at belt making, if properly conserved, would keep half our present factories going during these hard times and save expense at that. Now, however, the belt maker is as responsible and necessary an agent as the engine builder, and the two are interdependent to an extent that can only be appreciated by actual experience. Belts have grown wider and thicker and longer until it seems almost necessary to



J. A. J. SHULTZ.

belt makers to take hides of the ordinary size and piece them together for the benefit of the central station manager. Prominent among the belt makers of the age is the wellknown St. Louis house founded by J. A. J. Shultz, of St. Louis, seventeen years ago. When Mr. Shultz began to make belts their advantage for mechanical traction was quickly demonstrated, and this large branch of manufacture has become an important item, as the reports of the large sales of Shultz belting to street railway plants clearly show. Mr. Shultz introduced among other improvements the surface tanning of leather for belting. The process leaves the interior clear rawhide, insuring elasticity, strength and durability. Business flourished with the growth of demand and in 1877 the Shultz Belting Company was organized, with a paid up capital of \$300,000, and Mr. Shultz became president. W. P. Mullen was made vice-president and B. C. Alvord, secretary and treasurer.

The works, which are illustrated herewith, are situated at Bismarek and Barton streets, St. Louis, and comprise one, two, three and four story buildings, covering an area of 200 by 166 feet. The machinery in the factory is of the best and most complete special designs, and a special tannery on the premises insures workmanship that can be



THESE ARE THE BELTS THAT SHULTZ MADE.

breed up a special variety of cattle for that purpose, at least as large as elephants with their integument laid in strips already joined. Until that time, however, we shall have to depend upon the skill and enterprise of our

guaranteed. The pliable interior and the soft outside grain makes the Shultz belt the ideal of strength and pliability and utmost working power. All belting is stretched twice before being put together, and is equally

adaptable to hard service and rapid motion on small pulleys and in every form of twist connection. The adherence of the surface of the belt to the surface of the pulley insures great driving power.

Shultz belting has won an international reputation, and shipments are made all over the world of the patent sable rawhide and patent rawhide lace leather. A recent ship-

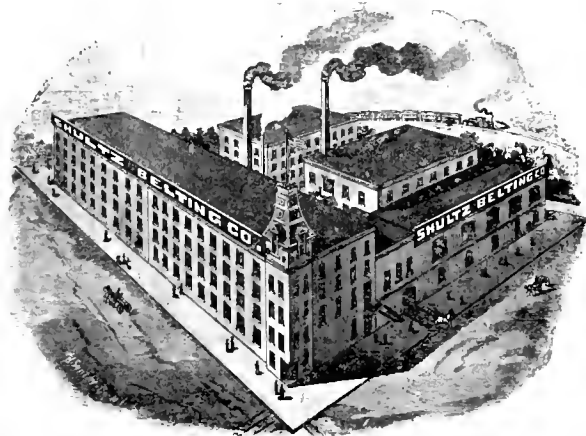

THE SHULTZ FACTORY.

ment of 20,000 feet of belt to Moscow, Russia, is one of hundreds of like exportations.

The work consumes upward of 30,000 hides annually, and the business, under the direction of President Shultz, is growing rapidly.

The buggy was directly across the tracks of the Scranton railway, and the motorman rang his gong

SPRINKLING CAR AT FORT WAYNE.

THE tank car here illustrated was built by the Fort Wayne Electric Railway and is in daily use on the road. The tank will hold fifty barrels of water. It is filled at stations on the line, but in another season connections will be made with the city hydrants so as to use a four-inch fire hose, and it is thought that the tank can then be filled in about twelve minutes. The car weighs 8,000 pounds itself, and the water 10,000 pounds additional. The tank once filled will sprinkle about three and a half miles of single track. The track is gone over twice a day. The sprinkler is used as a trailer and towed by any of the motor cars. By making the bottom of the tank-car itself perfectly waterproof a motor could be put on the car, but as there is always some danger of the water splashing on the motor, General Manager M. S. Robison thought best to use it as a trailer. The tank is 7 feet wide, 11 feet long and 5 feet high. There are two cross partitions inside of the tank to keep the water from splashing against the ends when the car is in motion. These partitions commence 6 inches from the bottom of the tank and end 6 inches from the top of the car. The car is of the same width as the tank and 19 feet long, leaving a three-foot platform at each end. The sprinkling part is directly under the car, between the front and hind wheels, extends 6 inches beyond the rails on each side and is one foot from the top of the rail. There are in the sprinkler three rows of holes, $\frac{1}{8}$ inch in diameter and $\frac{1}{2}$ inch apart, running the entire length of the tube. The advantage of keeping

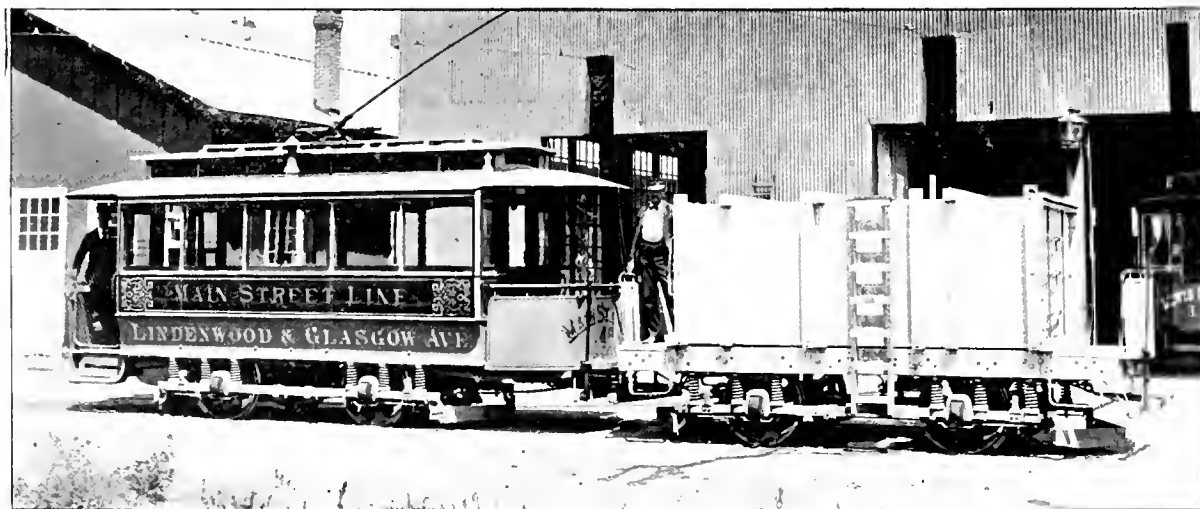

"THE TANK WILL HOLD FIFTY BARRELS OF WATER."

fiercely for the warning of the obstructionist. Finally patience ceased to be a virtue, and he began: "Git out of that track, you blankety-blank chump, or I'll smash your blank gig into blankety-blank smithereens." The buggy thus adjured turned to one side, and an extremely pretty woman, with laughing eyes, said, "Oh, excuse me." The headlight was eclipsed for the rest of the trip by the motorman's vigorous blush.

the rails wet and clean are too well known to need emphasis. The saving in power and wear and tear on machinery, besides the increased comfort to passengers, on suburban lines where the city sprinklers do not run, are sufficient arguments for track sprinkling.

THE Dallas cable railway has passed into the possession of the Queen City Railway of that city.

HANDSOME CARS OF THE JEWETT CAR COMPANY.

THE Jewett Car Company, of Jewett, Ohio, is fast making a record for itself as builder of some of the most attractive cars to be found anywhere. Our illustrations show one each of the single and double truck

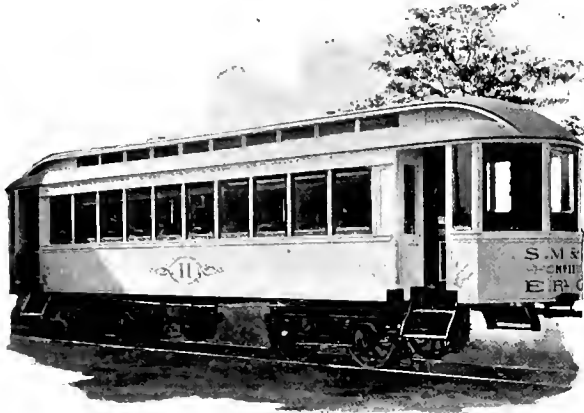

vestibules recently delivered the Sandusky, Milan & Norwalk road. Great pains have been taken in selection of

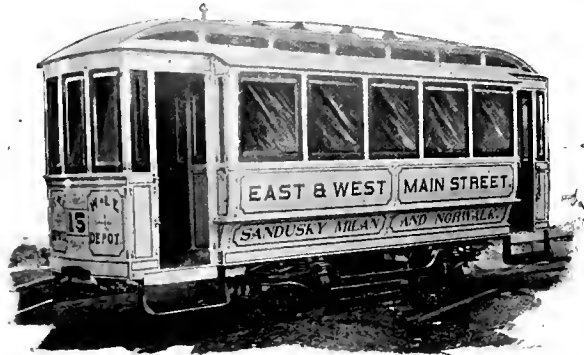

material and workmanship, and the determination to build a strong, serviceable car is no less than that of making it attractive within and without.

MAYNARD'S CABLE ROAD BRAKE.

OUR illustrations show the action of a cable road brake that has been tried with success on an incline cable track at Kansas City. It is very simple, and at first examination of little promise. Actual trial, however, demonstrates that it will stop almost anything.

The wheels, which are free to turn, are six inches in diameter and two inches thick. One pair presses above the slot rail, the other from below. At the trials in Kansas City the car was allowed to attain a speed which the spectators thought would result in certain destruction, but the car was quickly brought to a stand. The steel shank A A is in one piece, pivoted at D so that a movement of the lever handle from a vertical position causes the wheels

to exert an enormous clamping pressure, and yet avoiding an instant stop. The brake is quite inexpensive, and is the invention of K. A. Maynard.

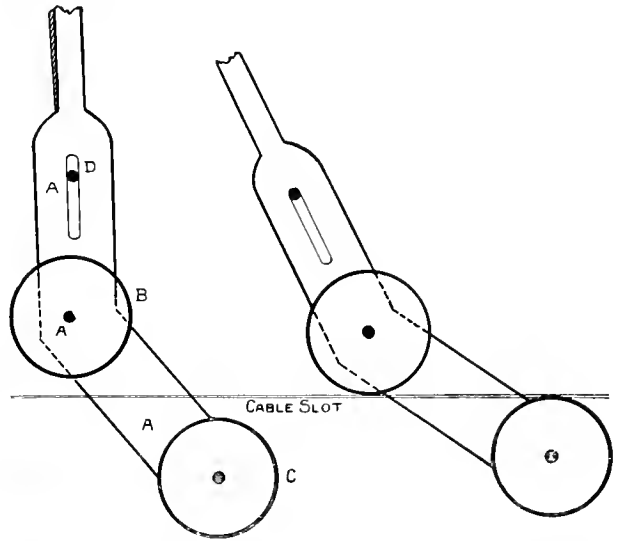

A A—Brake lever, all one piece of steel. B—Two wheels which revolve upon upper side of slot rails. C—Corresponding wheels on under side of slot rails. D—Pivot on which brake swings.

THE VOGAN BROTHERS' SANDER.

AMONG the several sand boxes offered street railways, that of the Vogan Brothers Manufacturing Company, New Castle, Pa., is one of the simplest and most economical. The illustration is a complete

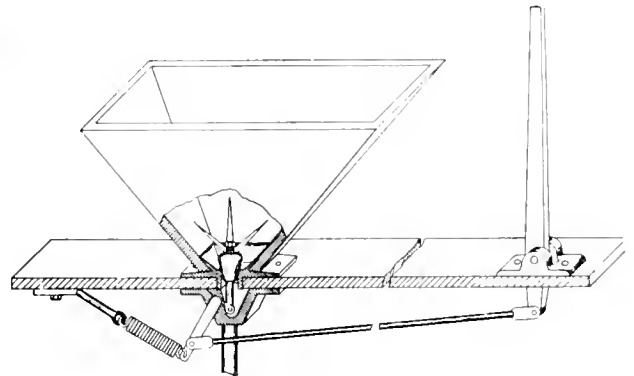

VOGAN BROTHERS' SAND BOX.

description of the device to every practical manager. It is made for both lever or foot power as desired, and is already giving excellent satisfaction on twenty-five roads.

Another device manufactured by the same firm, which commends itself, is the steel radial draw bar, in which the

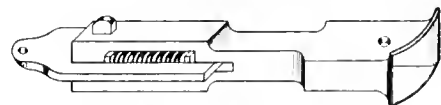

VOGAN BROTHERS' SPRING DRAW HEAD.

spiral draw spring is in the bar, allowing of a direct pull on the spring on even the shortest curves, and preventing at all times that unpleasant jerking and surging which is experienced in the operation of trailers.

R. D. NUTTALL.

AN OBITUARY.

THE street railway fraternity loses in the death of Robert D. Nuttall one of its pioneer supply men, and an upright, honorable and every ready friend. Mr. Nuttall's demise occurred August 29, at his home in Allegheny, Pa., where he succumbed to an attack of



THE LATE R. D. NUTTALL.

typhoid pneumonia. The fatal disease was contracted in Toronto, Canada, whither business relations led him. Robert D. Nuttall was born in 1863, near Pittsburg. At the age of 14 he was apprenticed to the machinist's trade, and from that date was dependent upon his own resources. His phenomenal success, therefore, can only be attributed to his naturally brilliant mind, his devotion to duty, and his upright business practice.

At the age of 18 he began a two-year service in locomotive engineering, but returned to his trade at the time when electricity first began to attract attention as a locomotive power. To this branch of industry he turned, and in 1887 organized the R. D. Nuttall Company in a very humble way with \$500 capital. Several changes in partnership and the rapid growth of the work saw the plant increase its stock to \$50,000, with Mr. Nuttall as president.

In July of this year Mr. Nuttall retired from the company, and was casting about for new channels for his energy, thus sadly interrupted.

He leaves a wife but no children, parents, one sister and five brothers. In a recent letter to the REVIEW he wrote of the pleasure he anticipated in renewing his street railway acquaintances at the coming convention, on which occasion he will be sadly missed by a very large circle of friends.

IRON AS A CONDUCTOR.

AN English author, in discussing the different metals and their cost in electrical distribution recently, showed that iron was the cheaper, when the simple first cost of the metal was considered. That is, to conduct a given current with a given loss, the cost of the actual metal necessary would be less in the case of iron than with copper. However, the bulk of iron necessary increases the cost of installation, so that copper is cheaper. The prices upon which these calculations were made are English, but the same will hold true with American prices. This statement again brings to mind the idea of using rails as return feeders. Bulk amounts to little in

this case. It is simply a question as to whether the iron can be laid and bonded at a cost below that of bare copper wire. The Intramural Railway at the World's Fair furnishes an example of the use of iron as a feeder wire. When it is laid underground, bonding would be more difficult to properly accomplish than on the Intramural structure, but it would not be nearly as difficult as on a railway track where there is a motion of the rail ends. Especially where old rails are available, the use of iron for return feeders would seem to be worthy of consideration, as it might very easily be made economical in some places. A given bulk of copper weighs more than iron in the ratio of about 25 to 21, and the conductivity of iron is about one-seventh that of copper. Accordingly, rails at \$32 a ton would be equivalent to copper at thirteen cents a pound, not including the bonding of the iron.

THE ELECTRICAL CONGRESS.

THE electrical congress, which convened in this city for the week beginning August 21, brought together by far the largest number of distinguished electricians in the history of the science. It was probably a more truly representative congress than any that have been held here this summer, consisting as it did of the cream of the profession from all countries, called together by an enthusiasm that exists among few other classes of men. The tone of the meeting tended more to the scientific than the practical, if we may use the distinction. Section "C." in which pure practice was to be discussed, was productive of many valuable papers and discussions, although it had none directly touching electric traction, which is rather strange, considering the place the latter subject has taken, as compared with other branches of electrical work. In the discussion of Professor Jackson's paper on "Underground Wiring in the United States," the recent troubles in Cambridge from the electrolysis of the lead cable coverings by the railway current were mentioned. It was said that the trouble was lessened by running copper feeders from the grounded pole of the station generators to points along the line. The transmission of power by multiphase currents was discussed at some length, in which connection the Westinghouse transmission exhibit was fully described.

The congress was closed formally on Friday afternoon, at which time the different sections all assembled to hear the report of the chamber of delegates on international electrical units.

OHIO STATE TRAMWAY ASSOCIATION.

THE annual meeting of the Ohio Tramway Association will occur in Cincinnati on Wednesday, September 27, and, as usual, will occupy one full day. No special programme of papers has been prepared, as the experience of last year proved the greater value of general discussion of questions of special interest. Attendance promises to be good, and the meeting a very interesting one.

CAUGHT ON THE RUSH TRIP.

American Street Railway Association.

D. F. LONGSTREET, PRESIDENT, Denver, Col.
 DR. A. EVERETT, FIRST VICE-PRESIDENT, Cleveland, O.
 JOEL HURT, SECOND VICE-PRESIDENT, Atlanta, Ga.
 W. WORTH BEAN, THIRD VICE-PRESIDENT, St. Joseph, Mich.
 WM. J. RICHARDSON, SECRETARY AND TREASURER, Brooklyn, N. Y.
 EXECUTIVE COMMITTEE—THE PRESIDENT, VICE-PRESIDENTS, and JOHN G. HOLMES, Pittsburg, Pa.; J. D. CRIMMINS, New York City; THOS. MINARY, Louisville, Ky.; JAS. R. CHAPMAN, Grand Rapids, Mich., and BENJ. E. CHARLTON-HAMILTON, Ont.
 Next meeting, Exposition Building, Milwaukee, third Wednesday in October.

Massachusetts Street Railway Association.

President, CHARLES B. PRATT, Salem; Vice-presidents, H. M. WHITNEY, Boston, AMOS F. BREED, Lynn, FRANK S. STEVENS; Secretary and Treasurer, J. H. EATON, Lawrence.
 Meets first Wednesday of each month.

Maine Street Railway Association.

President, WILLIAM R. WOOD, Portland.
 Secretary and treasurer, E. A. NEWMAN, Portland.
 Next meeting will be held the first Wednesday in February, 1891.

Ohio State Tramway Association.

President A. E. LANG, Toledo; Vice-president, W. J. KELLY, Columbus; Secretary and Treasurer, J. B. HANNA, Cleveland; Chairman Executive Committee, W. A. LYNCH, Canton, O.
 Meets at Cincinnati on the fourth Wednesday in September, 1893.

The Street Railway Association of the State of New Jersey.

President, JOHN H. BONN, Hoboken; Vice-president, THOS. C. BARR, Newark, Secretary and Treasurer, CHARLES Y. BAMFORD, Trenton; Executive Committee, OFFICERS and C. B. THURSTON, Jersey City; H. ROMAINE, Paterson; LEWIS PEIRINE, JR., Trenton.

The Street Railway Association of the State of New York.

C. DENSMORE WYMAN, PRESIDENT, New York.
 D. B. HASBROUCK, FIRST VICE-PRESIDENT, New York.
 JAS. A. POWERS, SECOND VICE-PRESIDENT, Glen Falls.
 W. J. RICHARDSON, SECRETARY AND TREASURER, Brooklyn.
 EXECUTIVE COMMITTEE.—D. F. LEWIS, Brooklyn; JOHN N. BECKLEY, Rochester, J. W. McNAMARA, Albany.
 The next meeting will be held at Rochester, September 19, 1893.

Pennsylvania Street Railway Association.

JOHN A. COYLE, PRESIDENT, Lancaster.
 JOHN G. HOLMES, VICE PRESIDENT, Pittsburg.
 H. R. RHODES, SECOND VICE-PRESIDENT, Williamsport.
 L. B. REIFSNEDER, SECRETARY, Altoona.
 WM. H. LANIONS, TREASURER, York.
 Next meeting, Reading, September 5, 1891.

Arkansas.

CAMDEN, ARK.—Camden Electric Light & Power Company plant sold at receiver's sale to General Electric Company (Chicago office) for \$30,000. Plant will be improved.

California.

LOS ANGELES, CAL.—Chas. Button, plaintiff, vs. Southern California Motor Road Company, is suit to recover \$5,736.00 with interest and costs.

SACRAMENTO, CAL.—Rumored that the recently incorporated American Investment Company has a line from Sacramento to Walnut Grove in view.

SAN DIEGO, CAL.—A. B. Spreckels, owner of the electric railway, has just returned from Japan. He will decide about extension proposed for the road here.

SAN DIEGO, CAL.—Col. A. B. Spreckels, president of the San Diego Electric Railway, will build an extension to Coronado with other improvements.

MODESTO, CAL.—The board of supervisors has granted a franchise for an electric railroad from Oakdale to the Tuolumne county line to J. W. Dunlap and J. W. Woodside.

SAN FRANCISCO, CAL.—The San Francisco, Stockton & San Joaquin railway scheme is going forward rapidly. The road will pay from the start. It will be a steam line.

OAKLAND, CAL.—Superintendent Grimm will take the late J. W. Tuckers' place, and no one will be added to the management. The Central avenue road has made a big cut in fares.

LOS ANGELES, CAL.—A company has been formed to buy the Blue Line and \$250,000 is subscribed to carry out the measure. This purchase will be made at the time the Cable Railway is sold.

SAN FRANCISCO, CAL.—To tap Russian Hill & Presidio Heights an electric road is to be built. The men behind the enterprise are: Collector of the port, John H. Wise; Henry Epstein, Jas. D. Byrnes, Captain Chas. Goodall and George A. Audenreid.

SAN FRANCISCO, CAL.—Park branch of the San Francisco & San Mateo Electric Railway is surveyed and will be running by Nov. 30. A horse car line for Washington street in Presidio Heights will be built by Improvement Club. Geo. R. Sanderson, president.

SAN FRANCISCO, CAL.—M. D. Stein, for some time past auditor of the Omnibus Cable Company, has been elected president of the road, in place of Gustav Sutro, resigned. Mr. Sutro remains a director. Stein is a very young man, a brother of the vice-president of the Omnibus Company recently deceased.

OAKLAND, CAL.—Oakland, San Leandro & Haywards Electric Railway Company files notification of decision to increase their bonded indebtedness from \$250,000 to \$500,000, in order to guarantee the payment of bonds to the amount of \$250,000, issued by the Twenty-third Avenue Electric Railway Company, absorbed.

Canada

TORONTO, CAN.—Owing to a dispute between Electric Railway Company and the city the laying of rails has been delayed. Threats were made of lynching the mayor by the 500 men thus thrown out of employment.

Chicago.

CHICAGO.—Judge Dunne has appointed Edward Eldridge receiver for the Q. & C. Company. The capitalization of the company is \$200,000, assets \$135,000, liabilities \$114,000.

CHICAGO.—Claims against the Ansonia Electric Company should be sworn to and sent to James B. Waller, assignee, room 47, No. 115 Monroe street, Chicago, within three months.

CHICAGO, ILL.—The Metropolitan L road has taken out building permits to erect ten stations along its line. They will be of brick, one story and basement, and will cost \$2,000 each.

Connecticut.

HARTFORD, CONN.—Contractor D. F. Keenan is pushing the Glastonbury extension. The line work will soon be put in.

NEW HAVEN, CONN.—The State Street Railroad Company has filed a mortgage of \$280,000 to the Massachusetts Loan & Trust Company.

NEW BRITAIN, CONN.—The street railway will extend their line to Berlin. Plans will be soon submitted to the council and no opposition is expected.

NORWALK, CONN.—Norwalk Tramways Company votes to reduce the capital of \$250,000 to \$100,000. Next spring the company will build lines to New Canaan, Westport, Roton Point and Stanford.

NEW HAVEN, CONN.—Suit is begun against the West Haven, Morris Cove & State Street Railway by Sprague Electric Railway & Motor Company, of New York, enjoining against use of certain fixtures.

NEW HAVEN, CONN.—President Hoadley B. Ives, of the Fair Haven & Westville Road, has publicly declared the road ready to begin making contracts for electric equipment. The trolley cars will be running by Christmas. Extensions on West Chester avenue and other streets will be made.

ROCKVILLE, CONN.—The Rockville & Ellington Street Railway Company elects the following officers: President, A. M. Young, of Waterbury; vice-president, N. D. Granne; treasurer, W. F. Marsh, of Bridgeport; secretary, R. S. Hicks, of Stafford Springs. The company will build the road as soon as possible.

NEW HAVEN, CONN.—The West Shore Railway Company incorporated by Henry Sutton, W. W. Ward, J. D. Dewell, Chas. K. Brush, Israel M. Kelsey, S. Harrison Wagner, all of New Haven, will probably open operations on a 11-mile electric railway to be completed by next July. Capital stock is \$100,000. All the men are prominent local capitalists.

Delaware.

WILMINGTON, DEL.—The Chester & Wilmington City Railway Company is incorporated by Jas. C. McComb, W. A. C. Hardcastle, Congressman J. B. Robinson, of Media, Pa.; J. Clayton Erb, William G. Hill, Peter J. Hughes, of Philadelphia; Richard R. Kenney, Garrett J. Hart and Register Ezekiel T. Cooper. Rights of way are already obtained for the most of the route.

District of Columbia.

GEORGETOWN, D. C.—Georgetown & Tennallytown Electric Railway decides to issue \$60,000 in bonds, to cover present indebtedness

Georgia.

AUGUSTA, GA.—Col. D. B. Dyer, will extend the electric railway and do freight and express business.

Illinois.

ALTON, ILL.—Work has begun on the Alton Electric Railway power house.

BELLEVILLE, ILL.—East St. Louis Electric Railway Company files deed of trust given to the Mississippi Valley Trust Company to secure payment of \$500,000 of its bonds.

PEORIA, ILL.—General Electric Company take possession of the Fort Clark Railway. F. W. Horne becomes president; J. A. Tranerick, of McCarthysville, Ga., is secretary.

BELLEVILLE, ILL.—City council grants franchise for electric road to the General Electric Railway Company of St. Louis. Construction to begin in thirty days and road to be finished in six months.

CANTON, ILL.—Organized and incorporated: The Canton City Railway Company, by J. M. Snyder, C. H. Martin and C. N. Henckle; to carry passengers, baggage and freight. Franchise already granted.

SPRINGFIELD, ILL.—The directors of the Consolidated held a meeting at Louisville and decided on some extensive improvements and extensions. The directors are: T. J. Minary, St. John Boyle, J. W. Gaulbert and Wm. Jarvis. C. K. Minary is resident manager.

Indiana.

RICHMOND, IND.—A. A. Titsworth is now superintendent of the City Railway Company.

MUNCIE, IND.—Council grants a thirty-five year franchise to Citizens' Street Railway on nearly every street in the city.

MARION, IND.—W. C. McWhinney has returned from New York and Philadelphia where he has bought considerable supplies.

MARION, IND.—Marion Electric Railway Company is pushing work on the Marion end of the line and the work will be finished on time.

INDIANAPOLIS, IND.—Thos. H. McLean, of New York City, has taken his new position as general manager of the Citizens' Street Railway.

NEW ALBANY, IND.—The Light, Heat & Power Company will buy an additional engine. The 250-horse-power is not sufficient for all the bridge cars.

RICHMOND, IND.—Richmond Electric Street Railway Company, by A. D. Titsworth, superintendent, announces that several new cars will be added to the service.

TERRE HAUTE, IND.—Assignee H. J. Baker, of the Terre Haute Car & Manufacturing Company, asks privilege to rebuild part of burned plant and go to work. Petition granted.

INDIANAPOLIS, IND.—L. A. Boyd, superintendent of the Citizens' Railway Company, has tendered his resignation, to take effect as soon as his successor can be appointed. No reasons given for the action.

HAMMOND, IND.—Judge Gillet appoints Hobart M. Godfrey, of Hammond, as receiver for the Hammond & East Chicago Street Railway Company. Silverman's bank failure is principal cause of the action.

SHELBYVILLE, IND.—Judge Hord, of the Shelbyville Electric Railway Company, says that the action of the council will not affect the building of the line and that as soon as money is easier the railway will be built.

MUNCIE, IND.—The new Citizens' Electric Street Railway Company files articles of incorporation. It consolidates old Citizens' and the Muncie Company's at \$300,000, of which \$100,000 is preferred, 7 per cent. The directors of the new company are: J. Smith Talley, of Terre Haute; Edward Wells, of Burlington, Vermont; George F. McCulloch and Charles Miller, Muncie; James W. Landrum, of Terre Haute. Dummy line will change to electric.

Iowa.

CHARLES CITY, IA.—An electric railway will be established from here to Shell Rock.

MUSCATINE, IA.—T. L. SeEVERS, resident manager of the electric line, says he will build the Musserville extension as soon as money is easier.

SIoux CITY, IA.—Sioux City Electric Railway power house said to have been damaged by bursting fly wheel. Later reports deny this.

Kansas.

LEAVENWORTH, KAN.—W. F. Putnam, president of the Leavenworth Electric Railway Company, has given a chattel mortgage for \$8,000 on electrical goods bought last February. Mortgage is in favor of the Westinghouse Company.

LEAVENWORTH, KAN.—M. Summerfield, of Lawrence, says that a new company will be formed here to take up the old road. H. L. Turner, of Chicago, will be president, and E. G. McInness will be treasurer; backed by Boston capital. Turner is now here.

ATCHISON, KAN.—B. P. Waggoner applies for new charter for electric railway and light company. Capital to be \$250,000. Edward Morton, A. J. Harwi, J. C. Fox, David Kelso, et al, are interested. All are solid local financiers.

ATCHISON, KAN.—Dr. W. L. Challiss resigns the presidency of the Street Railway Company, and B. P. Waggoner is elected to fill the vacancy. He takes possession as agent for Edward Morton.

TOPEKA, KAN.—Potwin council has under consideration a franchise drawn by President Baker, of the Topeka Street Railway Company. This, if granted, will mean the electrifying of the now bobtail line to Potwin suburb.

Kentucky.

LOUISVILLE, KY.—Street railway company reduces its force. About fifty employes are retired.

Louisiana.

NEW ORLEANS, LA.—The franchise of the New Orleans City & Lake Railroad was bought recently at auction by Peter Caulfield, an alderman, for \$1,000,000. Some time ago the property, which consists of sixty-six miles of track, was bought by the Seligman-Disston syndicate of New York, but the company wished to wait for an extension of franchise to fifty years. The syndicate offered \$700,000 by a representing broker, but Caulfield bid over him. Mr. Caulfield claims that he bid \$1,000,000 in the interest of the city, as the franchise was worth it.

Maryland.

BALTIMORE, MD.—The White Line Cable begins business. The electric line from Huntingdon avenue to Hampden has been begun.

BALTIMORE, MD.—City Passenger Company awards contract to Johnson Company of Johnstown, the Westinghouse Company, E. P. Allis and others.

BALTIMORE, MD.—Thos. Craddock, Baltimore, B. F. Graff, Owings' Mills, Arthur A. Rich, Reistertown, Geo. Atkinson, Glyndon, et al., are chairmen of committee to extend electric road to their various towns.

BALTIMORE, MD.—The Leonhardt Pneumatic Safety Car Fender Company, of Baltimore City, incorporated by Wm. Leonhardt, David M. Newbold, Harry C. Gaither, Geo. F. Faust, John H. Leonhardt Nicholas N. Rittenhouse, Chas. E. Savage, William Hopps, and David M. Rittenhouse to manufacture the fender invented by William Leonhardt.

Massachusetts.

TEWKESBURY, MASS.—The select men give the Lowell & Suburban Company another hearing and a franchise will be probably granted.

BILLERICA, MASS.—The selectmen of this village are petitioned by Henry H. Savage, Martin L. Hamblet, Chester W. Clark, Charles F. Brown, William A. Lang, Geo. E. Quimby and J. Howard Eames. They will form a new company to operate to and through several towns.

LOWELL, MASS.—The directors of the South Side Street Railway just formed are: Maynard E. Clemens and Winslow Goodwin, of Andover; C. T. Guild, North Attleboro; A. C. Russell, J. L. Chalifoux, and Larkin T. Trull, of Lowell, and W. S. Knox, of Lawrence.

Haverhill, MASS.—Haverhill aldermen grant extension of time for building the Hillsdale branch of the Lowell, Lawrence & Haverhill Electric.

GARDNER, MASS.—J. Walter Davis, L. A. Greenwood, J. H. Whiting, G. R. Godfrey, E. A. Colby et al are moving for an electric railway at this place. A franchise is granted and routes approved. Capital is stated at \$75,000.

Michigan.

GRAND RAPIDS, MICH.—The Street Railway Company reports that the closing of factories has decreased the business of the Street Railway Company.

GRAND RAPIDS, MICH.—The Consolidated has elected A. J. Bowne, L. H. Withey, J. R. Chapman, Grand Rapids; J. J. P. O'Dell, J. M. Hagar and S. K. Martin, of Chicago, directors. Old officers will be re-elected.

SAGINAW, MICH.—President Snow, of the Saginaw Union Street Railway Company, says that it will pay to extend his line to the factories and that he will take immediate steps to procure franchise.

MONROE, MICH.—J. H. Dawson, of Toledo, H. H. Johnson, of Philadelphia, and H. J. Warner, of Brooklyn, are trying to interest people here in an electric road from Toledo to Detroit, via Monroe. They want a franchise.

Minnesota.

ST. PAUL, MINN.—The East Seventh Street Cable has been changed to electricity and the Rondo street extension of the electric line will soon be ready for service. This is considerable advantage to the system.

DULUTH, MINN.—The Duluth Street Railway is again running. Citizens committee arranged the strike.

Missouri.

KANSAS CITY, MO.—W. E. Winner and F. O. Hadley have received their franchise for a line on Fifteenth street.

ST. LOUIS, MO.—A new electric line is to be built to the Manchester road. Surveyor B. E. Johnson, of Kirkwood, will survey the line. Evangelical Lutherans of St. Louis, are in the company.

ST. LOUIS, MO.—Financial stress compels St. Louis & Suburban to take off four through trains. This is on account of shutting down of factories and shops.

Nebraska.

BEATRICE, NEB.—Brush Electric Company applies for a receiver for the Beatrice Rapid Transit & Power Company. Temporary arrangements are made to keep things going.

New Jersey.

JERSEY CITY, N. J.—Ordinance giving the Consolidated Traction permission to use electricity on nearly all the important streets, passed over Mayor's veto.

CAMDEN, N. J.—The West Jersey Traction secures the right over the Haddonfield Pike for its line. It is reported that the Traction will absorb the Camden Horse Railway Company.

New York.

KINGSTON, N. Y.—The Colonial Electric Railway Company files bonds for \$10,000. The road is to be completed in one year. Bondsmen are Wendell Goodwin and Frederick Swift. E. H. Loughran is president of the company. The American Surety Company of New York guarantee the bond.

NEW YORK CITY.—The Columbus & Ninth Avenue Railway Company files mortgage to the Ninth Avenue Railway Company, the New York Guarantee & Indemnity Company as trustee, for \$3,000,000. The Lexington Avenue & Pavonia Ferry road gives mortgage for \$5,000,000 to the Central Trust Company as trustee.

HUDSON, N. Y.—Consents are given for an extension of the Hudson Electric.

SCHENECTADY, N. Y.—Application for receiver for the Schenectady Street Railway granted; John Muir, of Brooklyn, appointed by court. Alleged that the company is utterly unable to meet its obligations incurred by improvements and cost of operating during the last hard winter.

MECHANICSVILLE, N. Y.—The village trustees have granted a franchise to the Mechanicsville & Stillwater Railway to change to electricity and put in T rails.

BROOKLYN, N. Y.—Brooklyn, Bath & West End files certificate in Kings county clerk's office increasing capital from \$600,000 to \$1,000,000. The bonded indebtedness of the road is \$552,000.

NEW YORK CITY.—Judgment for \$12,762, against the Duplex Street Railway Track Company, is rendered in favor of Schwen Manufacturing Company, of Pittsburg.

LOCKPORT, N. Y.—City council decides to extend life of the Lock City Electric Railway.

BUFFALO, N. Y.—H. E. Heller, an electrician of many years standing has been appointed superintendent of the Buffalo, Kenmore & Tonawanda Street Railway Company.

BINGHAMPTON, N. Y.—The North Chenango Street Line and the Brevier Street Line have been merged, and interchange for one fare.

UTICA, N. Y.—Incorporated: The Extension Car Step Company at \$100,000, by Chas. W. Hackett, president; vice-president, A. C. Salisbury; secretary and treasurer, I. J. Griffiths.

SYRACUSE, N. Y.—Syracuse Consolidated Street Railway Company, which for three years has done all the street railway business in the city, has gone out of business by the formal transfer of all its rights and properties made to the Syracuse Street Railway Company, which is capitalized at \$1,000,000. The owners of minority stock in the Consolidated charge fraud against the majority holders and claims that the meeting which transferred the stock was held in secret.

BROOKLYN, N. Y.—Stephen Noonan, superintendent of the Long Island Railroad, has been appointed superintendent of the New York & Rockaway Beach Railroad.

Ohio.

CLEVELAND, O.—Ford Washburn Company has closed contract to furnish the Cleveland & Berea Railroad with storage battery cars.

CLEVELAND, O.—Frank R. Merchant, 607 Society for Savings Building, is receiver for the Mark Railway Equipment Company and for Mark & Sterling. The company will probably not resume.

SANDUSKY, O.—Sandusky, Milan & Huron Electric Railway Company has been placed in the hands of J. C. Gilchrist, receiver, of Vermillion. Failure is attributed to the fact that Cleveland capitalists did not take up \$75,000 bonds as expected. The company is perfectly solvent, with property twice as large as its liabilities.

COLUMBUS, O.—Board of Public Works rejects bids for the street railway route over West Mound street, made by the Columbus & Harrisburg Electric Railway Company, through President Jos. W. Briggs and Secretary Gideon D. Martin. The company did not put up any bond, and the men mentioned were the only bidders.

MARTINS FERRY, O.—The Bellaire Street Railway Company will hold a special meeting October 7, to elect officers and consider propriety of leasing line or selling line, property and franchise to the Bellaire, Bridgeport & Martins Ferry Railway Company. Call signed by J. K. Jolly, et al.

AKRON, O.—The superintendency of the Akron Street Railway has not been filled. F. A. Seiberling and C. J. Hardesty will act in that office.

YOUNGSTOWN, O.—The Youngstown, Park & Falls Electric Railway is incorporated at \$65,000 by G. A. Baker, J. Harris McEwen, James Hively, Harry G. Hamilton and Morgan Evans. They wish to begin work without waiting for outside capital.

SANDUSKY, O.—The Sandusky, Milan & Huron will be in operation soon, owing to a recent agreement between Receiver Gilchrist and the furnishers of cars and dynamos.

AKRON, O.—J. E. Metlin, superintendent of the Akron Street Railway, is dead. He was well known in Cleveland.

NORTH BALTIMORE, O.—The road projected between here and Welker by J. J. Geghan is now in fair prospect of being carried through.

TOLEDO, O.—The Hotel Victory and the Put-in Bay Electric Railway are said to be on the market. L. S. Baumgardner intimates as much.

WOOSTER, O.—B. M. Barr, who was granted franchise here for an electric railway, asks extension of time on account of closeness of money market.

CINCINNATI, O.—Cincinnati Street Railway Company is preparing ordinance to change motive power on five or six routes the franchise of which expires. They provide 5 cent fare and 2½ per cent gross earnings to the city.

CINCINNATI, O.—An unexpected turn has given assurance to the Cincinnati, Oakley & Madison Avenue Electric Railway people that the county commission will grant them franchise.

CLEVELAND, O.—The Russell and Scofield ordinances for street railway lines have been lost in council.

FINDLAY, O.—Hon. Geo. B. Kerper, of Cincinnati, president of the Findlay Street Railway Company and the Hancock Electric Light & Power, is making arrangements to light the city. He says that the Findlay-Fostoria Electric will not be pushed now on account of stringency in the money market, but that the scheme will not be dropped.

SPRINGFIELD, O.—Right of way has been granted to J. W. Neff for a line between Springfield and Xenia. The line is over the Yellow Springs pike road. Bids for ties and material are advertised. See previous dailies for particulars.

TROY, O.—Electric Railway power house here is damaged slightly by fire. No large machinery is lost.

WARREN, O.—Warren Electric Railway Company elect T. B. Clawson president in place of C. P. Northrop.

CLEVELAND, O.—The Big Consolidated agrees on the Rochester system of transfers.

CINCINNATI, O.—Judge Evans grants application for receiver for S. H. Parvins & Son., advertising agents; liabilities, \$50,000; assets, \$100,000, mostly accounts.

YOUNGSTOWN, O.—Dullness in traffic compels the street railway company to drop a number of employes. The Youngstown & Canfield line has unexpected opposition developed by Mile Creek Park commissioners, who refuse right of way.

CHILLICOTHE, O.—The street railway business is picking up, and traffic is warranted better facilities.

Oregon.

PORTLAND, ORE.—James Steel, Geo. A. Steel and Jas. B. Cleland have filed supplementary articles of incorporation for the East Side Railway Company, to equip the Willamette valley with power, telegraph and railways.

SALEM, ORE.—John H. Pedrick vigorously denies the allegation that he is about to begin a canvass for capital to build an electric line to Portland.

Pennsylvania.

NORRISTOWN, PA.—The Norristown, Bridgeport & Conshohocken Traction Company applies for charter. The incorporators are Edward S. Perot, Morgan R. Wills, Henry Freedley, Hiram R. Rhoads, Cornelius Gallagher and others.

LEBANON, PA.—On a guarantee of six per cent the Lebanon & Annville Street Railway has been leased to the Lebanon & Myerstown Company.

FRANKLIN, PA.—The officers of the company proposing to build from Franklin to Oil City are James Roy, president; H. R. McCalmont, secretary; Geo. S. Davis, treasurer; J. H. Donly and A. H. McKelvey, directors; all well-known business men of Warren, Pa.

PITTSBURG, PA.—The Street Railway Company that will build to Mansfield elects: President, C. J. McDonald; Wm. Roseburg, treasurer; E. K. Morse, engineer. The intention is, as formerly, to start on the construction of a line from Water street tunnel, Mount Washington, and proceed to Mansfield.

LANCASTER, PA.—The Lancaster & Columbia Traction Company has bought the Mountville bridge and ended the litigation with the Pennsylvania railway.

WEST CHESTER, PA.—The Suburban Railway Company is chartered at \$400,000, with a proposition to build sixty-five miles of street railway. The directors are William Jenks Fell, Robert C. Fulton, Philadelphia; Francis Fennimore, St. David's; Mahlon M. Child, Wilmington, Del.; and William S. Kirk, West Chester.

HARRISBURG, PA.—Attorney General Hensel refuses quo warranto requested against Gettysburg Battlefield Railway and decided all points in favor of the trolley line.

NORRISTOWN, PA.—J. H. Passmore, formerly superintendent of the Newark Rapid Transit Company, has been appointed superintendent of the Norristown & Bridgeport line.

PITTSBURG, PA.—The Pittsburg, Beltzhoover & Knoxville Railway organized by Jas. M. Bailey, of Allentown, president; Wm. H. Minch, Jas. H. Roberts, Robt. A. Carter and Alex M. Neeper, of Pittsburg, will build a new Hill road on the South Side.

SUNBURY, PA.—Superintendent Frantz, of the Sunbury & Northumberland Electric Railway, is to be succeeded by Martin Withington, Jr., of Northumberland. Officers elected: Dan Coolidge, president, Johnstown; S. P. Wolverton, Sunbury, secretary and treasurer; C. M. Clements, et al., directors.

CARLISLE, PA.—Oliver H. Ormsby and S. Ritter, of Pittsburg, gain franchise for an electric railway through the village.

LANCASTER, PA.—Columbia & Donegal Street Railway decides to prosecute the work of extension. Supt. F. S. Given is buying supplies.

Texas.

DALLAS, TEX.—North Dallas Street Railway sold by E. O. Tension for \$25,000 to the trustee, C. L. Wakefield, who is secretary and treasurer of the Queen City Railway Company.

Tennessee.

CHATTANOOGA, TENN.—The Chattanooga Electric Railway Company wins a decisive victory in the courts over the obstructionists, and the Cowart street line will be rapidly pushed to completion.

WINCHESTER, TENN.—The building of the Winchester-Decherd Electric is delayed by non-payment of certain grading contracts. Will be settled satisfactorily.

Utah.

SALT LAKE CITY, UTAH.—The ordinance granting franchise to Otto Stallman and Stephen A. Estes has been passed.

Washington.

SEATTLE, WASH.—The Madison Street Cable Railway Company rejects the franchise granted it by the council. The conditions are too hard.

TACOMA, WASH.—J. T. Mitchell, of Tacoma, is appointed receiver of the Point Defiance, Tacoma & Edison Belt Line.

SEATTLE, WASH.—G. C. Pbinney, of 110 Seneca Street, Woodland Park, Seattle, is in the market for 600 tons 60 lb. steel T rail, with angle fish plates and bolts, and 300 tons of center bearing steel girder with fastenings. State price f. o. b. with terms of purchase.

TACOMA, WASH.—The Tacoma Railway & Motor Company are restrained from abrogating an agreement by which traffic is transferred to that line from the Tacoma, Lake Park & Columbia River Road. The latter line fears the former is actuated by Northern Pacific Railroad Company.

SEATTLE, WASH.—O. S. Buckbee retires from management of Yesler avenue cable, and is succeeded by R. E. Sander.

West Virginia.

MOUNDVILLE, W. VA.—The Secretary of State has issued a charter to the Benwood Street Railway Company, of Moundville. The incorporators are: J. W. Burchinal, of Moundville, B. F. Peabody, Leonard Eskey, Jas. E. Doyle and Henry Riddle, of Benwood.

WHEELING, W. VA.—The Citizens' Street Railway Company has been leased by the Wheeling Railway Company.

Wisconsin.

MILWAUKEE, Wis.—Receiver Melms says he has \$188,413 to pay claims amounting to \$187,368 against the Milwaukee Electric Railway Company.

Custer's Last Battlefield.

A visit to this spot, which is now a National Cemetery, is extremely interesting. Here, seventeen years ago, General Custer and five companies of the Seventh U. S. Cavalry, numbering over 200 officers and men, were cut to pieces by the Sioux Indians and allied tribes under Sitting Bull. The battlefield, the valley of the Little Big Horn, located some forty odd miles south of Custer, Montana, a station on the Northern Pacific Railroad, can be easily reached by stage. If you will write Chas. F. Fee, St. Paul, Minnesota, inclosing four cents in postage, he will send you a handsomely illustrated 100 page book, free of charge, in which you will find a graphic account of the sad catastrophe which overtook the brave Custer and his followers in the valley of the Little Big Horn, in June, '76.



HIS MALADY.

His neck was like a spiral spring,
Though not a freak was he;
He only went to the Fair one day,
But tried it all to see.

CHICAGO CITY RAILWAY CUTS A MELON.

THE Chicago City Railway have declared a dividend almost unparalleled in the history of dividend paying enterprises. In addition to the regularly quarterly of three per cent, which has not been varied from in nearly ten years, an extra of 2 per cent was declared, and a division ordered pro rata among stockholders of \$4,500,000 stock and \$3,000,000 of bonds of the Alley "L" in this city. The total amount per share thus paid is equivalent to \$70 per share.

The Annual Meeting at Milwaukee.

Those who contemplate attending the annual meeting of the American Street Railway Association at Milwaukee, Wis., October 18, 19 and 20, will be pleased to learn that reduced rates for this occasion are announced by the popular Northwestern line.

In point of location, construction, equipment and service, this route takes rank with the best railways in the United States, and especially is this true of the line between Chicago and Milwaukee. Skirting the picturesque shore of Lake Michigan nearly the entire distance, the perfect condition of its track permits a high rate of speed with absolute safety and comfort, and frequent fast express trains, equipped with standard day coaches, new and luxurious parlor cars and dining cars, provide a service which meets the requirements of the most exacting.

The Chicago ticket offices of the Chicago & Northwestern Railway are located at 208 Clark street, and passenger station, corner Wells and Kinzie streets, and further information concerning rates, times of trains, etc., can be obtained upon application at either address, or by communicating with W. A. Thrall, general passenger and ticket agent, Chicago, Ill.

PATENT OFFICE GOSSIP.

No. 502,538 is interesting, not only on account of the reputation of the inventor, but because it seems to cover the distribution of alternating currents at high pressure for railway purposes. The specifications describe a system of alternating current mains, supplying current to converters along the line of the railway. These converters in turn supply the motors.

No. 502,539 differs from the preceding one only in that the converters are placed on the motor car, instead of along the line.

No. 502,629 is a simple automatic form of trolley guard, the forks of which are weighted so that normally they extend upon either side of the trolley wire, but will yield enough to save trouble at turnouts and crossings.

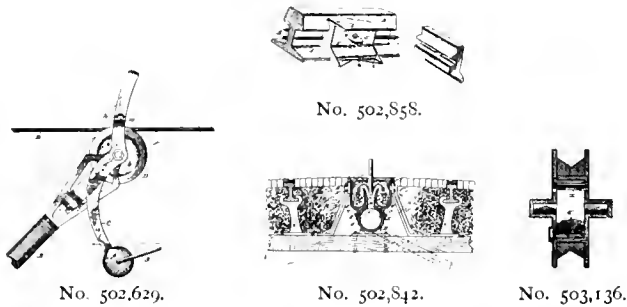

For details of 502,842 see illustration.

THE recent agitation of the ground return question is beginning to bear fruits, as is shown by several patents this month. No. 502,858 provides for an insulated feed wire running alongside the rail and bared at intervals, at which places it is attached to the rail by clamps, in the manner shown in the engraving. The supplementary feed wire is run along the other side of the rail. The clamps at the points of contact are covered by an insulating block.

No. 503,136 is a trolley wheel, made in interchangeable parts, to allow of replacing those worn out the soonest. An oil chamber is also provided. See illustration.

STREET RAILWAY PATENTS.

COMPILED BY THE STREET RAILWAY REVIEW.

ISSUED JULY 18, 1893.

Regulating electric locomotives, John B. Blood, Lynn, Mass., assignor to the General Electric Company of New York.....	501,488
Trolley wheel, Edgar M. Tousley, Jamestown, N. Y.....	501,548
Electric railway conduit, Irving J. Cook, Newark, N. J.....	501,676
Removable side wall for cars, Lee D. Craig, San Francisco, Cal.....	501,677
Device for preventing rails from spreading, Thomas H. Dahill, Alfred Center, N. Y., assignor two-thirds to W. C. Dunham and W. B. White, same place.....	501,678
Grip opener, William P. Courtney, Oakland, Cal.....	501,764

ISSUED JULY 25, 1893.

Electric railway trolley, Elmer A. Sperry, Chicago, Ill., assignor to the Sperry Electric Railway Company, Cleveland.....	501,968
Electric locomotive, Elmer A. Sperry, Chicago, assignor to the Sperry Electric Railway Company, Cleveland.....	502,020
Car fender, Chas. T. Grilley, Boston, Mass.....	502,037
Trolley wire and hanger, Earl P. Wetmore, Helena, Mont.....	502,088
Rail joint, Randolph G. Ward, Charleston, S. C.....	502,153
Street car jack, George F. Pearson, Lowell, Mass.....	502,200
Conduit system for electric railways, Frank Wynne, London, Eng.....	502,216
Connector for track circuits, Edward H. Goodman, Pittsburg, assignor to the Union Switch and Signal Company, Swissvale, Pa.....	502,229
Electric railway trolley, Charles J. Van Depoele, Lynn, Mass., Albert Wahl and Charles A. Coffin, executors of said Van Depoele, deceased, assignor to the Thomson-Houston Electric Company, Boston, Mass.....	502,243

ISSUED AUGUST 1, 1893.

Electric locomotive, Rudolph M. Hunter, Philadelphia, Pa., assignor to the Electric Car Company of America, same place.....	502,297
Tramway vehicle, Carl Luhrig, Dresden, Germany.....	502,442
Locomotive vehicle, Carl Luhrig, Dresden, Germany.....	502,443
Truck for street cars, Henry F. Shaw, Boston, Mass., assignor to the Shaw Radial Car Truck Company, same place.....	502,503
Electric railway trolley base, Otto Rau, Jersey City, N. J., assignor one-half to Robert S. Dobbie, New York, N. Y.....	502,530
Converter system for electric railways, Geo. W. Von Siemens, Berlin, Germany, assignor to Siemens & Halske, same place.....	502,538
Electric railway system, George W. Von Siemens, Berlin, Germany, assignor to Siemens & Halske, same place.....	502,539
Trolley head, Robert S. Dobbie, Jersey City, N. J., assignor one-half to Otto Rau, Milwaukee, Wis.....	502,553
Box bridge joint for railway rails, Edward Samuel, Philadelphia, Pa., assignor to Wm. Wharton, Jr. & Company, same place.....	502,587
Trolley guard, George Moore, Boston, Mass.....	502,629
Insulator, Louis McCarthy, Boston, Mass.....	502,677

ISSUED AUGUST 8, 1893.

Subway for electric railway conductors, Isaac La Rue Johnson, Washington, D. C.....	502,821
Trolley wire insulator, Louis McCarthy, Boston, Mass.....	502,826
Electric railway conduit, Robert R. Zell, Baltimore, Md., assignor one-half to Henry C. Kirk, Jr., same place.....	502,842
Supply system for electric railways, Wilton F. Jenkins, Richmond, Va.....	502,858
Car fender, Millard F. Field, Taunton, Mass.....	502,959
Attachment for steel rail brooms, Alfred E. Wilson, Rockford, Ill., assignor to James S. Ticknor, same place.....	503,024
Car truck, John H. Graham, Boston, Mass., assignor to the Consolidated Railway Supply Company, same place and Providence, R. I.....	503,044
Truck for motor cars, George W. Lacy, Kingston, N. Y., assignor by mesne assignments to Elzada Lacy, same place.....	503,092
Electric rail bond, Benjamin C. Seaton, Nashville, Tenn., assignor one-half to William S. Barkley, Indianapolis, Ind.....	503,101

ISSUED AUGUST 15, 1893.

Trolley wheel, John F. Hall, Lincoln, Neb.....	503,136
Street car gear, Moses G. Hubbard, Chicago, Ill.....	503,142
Controlling switch for electrically propelled vehicles, Harry P. Davis, Pittsburg, Pa., assignor to the Westinghouse Electric & Manufacturing Company, same place.....	503,279
Cable railroad, John W. Dotson, Chicago, Ill., assignor one-half to Richard J. Clark, same place.....	503,666
Trolley wire fender, Henry C. Jones, Montgomery, Ala.....	503,421
Tramway switch, Augustin C. L. Engstfeld, Memphis, Tenn.....	503,474
Insulator, Louis McCarthy, Boston, Mass.....	503,549
Electrical supply system for railways, Joseph W. Bates, Minneapolis, Minn.....	503,566

A Few Facts Concerning the Big Four Route to the World's Fair.

"Isn't one man as good as another?" asked an orator in the course of a stump speech, and a voice in the crowd replied, "Yes, and a blamed sight better!"

Now, it is a good deal the same with the Big Four Route to Chicago; it is a "blamed sight better" than any other line. Why? In the first place the train service, equipment and road bed are unequalled by any railroad in the country; in the second place, the Sleeping Cars, Parlor Cars and Day Coaches are the finest specimens of the car builder's art that ever ran on wheels; in the third place (now read this carefully), all trains of the Big Four Route enter Chicago along the Lake Front, stopping at Midway Plaisance, the Main Entrance to the World's Fair Grounds, 60th St., Hyde Park, 39th St., 22nd St., 12th St., and land passengers and baggage convenient to all the World's Fair Hotels and Boarding Houses, as well as the down-town Hotelries. Think what this means! You are landed with your baggage within a few minutes walk of your stopping place, avoiding the long tiresome transfer across the city necessary via other lines. All ticket agents throughout the country are supplied with Big Four tickets, and if you wish to enjoy the Fair to the fullest possible extent ask for tickets via Big Four Route. For further information address D. B. Martin, General Passenger Agent, Cincinnati.

LACLEDE'S EXPOSITION CAR.

ON the exhibition tracks, just south of the Transportation building, at Jackson Park, the Laclede Car Company has on exhibition one of its well known cars. It is not strictly speaking an exhibition car, but rather an ordinary type car on exhibition. It is mounted on a McGuire truck, with Griffin wheels, and is wired for Westinghouse motors, carrying two 15-horse-power of this type.

The car measures 30 feet over all, with extension platforms and safety gates thereon. Double doors at the end give easy access at all times and plenty of air in summer. The large French glass windows, six in number, admit plenty of light and for summer use can be lowered until the car will be essentially a summer car. No attempt has

THE BASS ENGINE EXHIBIT.

AMONG the Corliss engines at the Machinery Hall power plant none attracts more attention than the elegant cross-compound condenser exhibited by the Bass Foundry & Machine Works, of Ft. Wayne, Ind., whose scope in street railway fields has been previously described in the STREET RAILWAY REVIEW.

This Corliss is as stated, a cross compound condensing engine, 16 and 30-inch cylinder, by 42-inch stroke. The driving pulley is 16 feet in diameter by 42-inch face. The Wheeler Condenser & Engineering Company made the efficient condenser which is used with this engine, and although it was intended to represent the Bass Foundry and Machine Works at the great Exposition, no extra finish was put on, thus leaving it as intended—a represent-

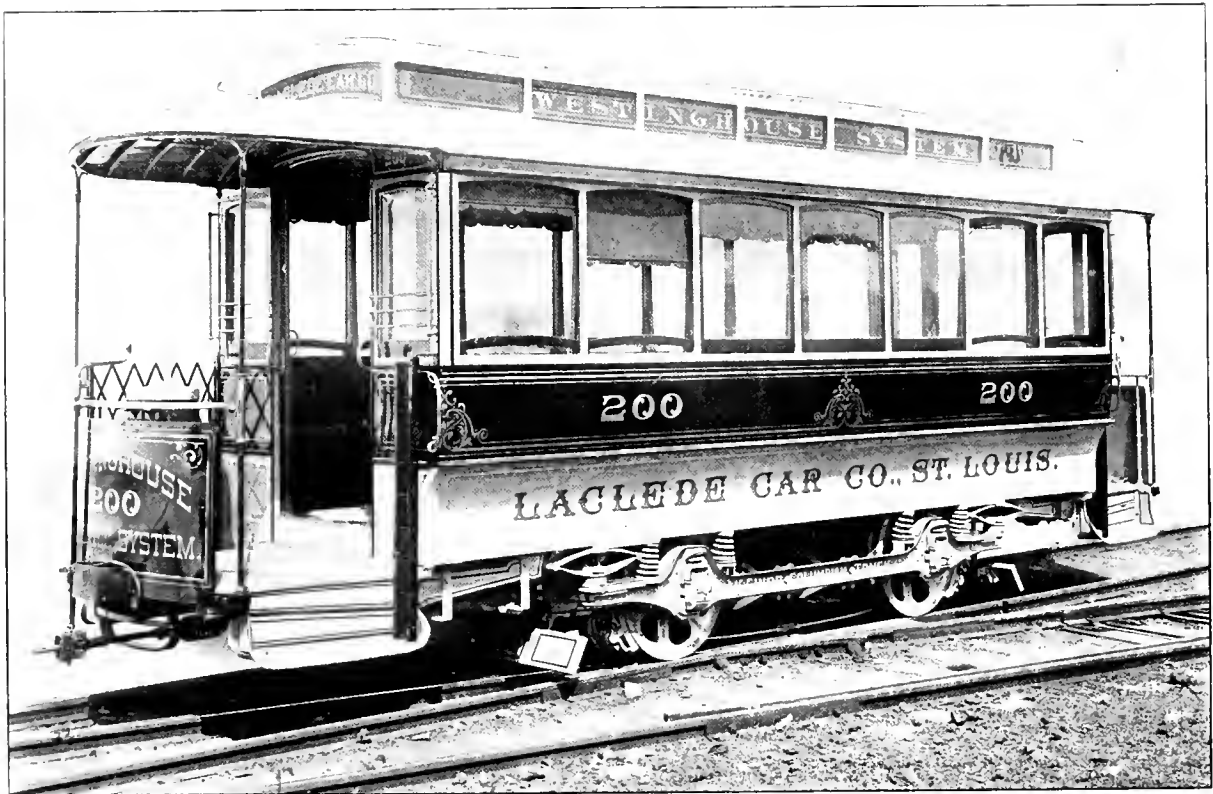

LACLEDE CAR AT WORLD'S FAIR.

been made at decoration other than the neat treatment of the ceiling and panels in buff, slightly figured. The outside is also treated in buff and mahogany, giving a businesslike effect to the whole car. Brass mountings set off the platforms and give them a substantial look. As stated, the car is built according to the usual specifications of the Laclede Company, which is sufficient guarantee of its strength and durability. There is not much interest displayed as yet in the exhibit tracks, but when the street railway men come, Laclede's car will have its full audience of discriminating spectators.

An auction of "bone motors" is the expressive language of a daily paper in recounting the sale of a lot of old street car horses in a neighboring city.

ative piece of mechanism. The engine is nominally rated at 300-horse-power with 125 pounds steam pressure, with a speed of 70 revolutions per minute.

To a casual glance the most striking features of the Bass Corliss are its symmetrical proportions, heavy construction, superior finish, care of workmanship and noiselessness of the valve gear. A closer inspection will show close regulation and fineness of material in every part of the machine.

In the construction of the girder, iron is freely used and according to the usual Bass foundry method the metal is distributed as carefully as possible to avoid hidden strains in the casting.

The guides are securely tied together by a ring of metal at the forward end and directly over the center foot,

thus carrying the strains from the top guide direct to the foundation. The guides are bored and the end flange of the girder faced with the same bar to insure accurate alignment.

Although lack of space prohibits a disquisition on the governor and valve gear, it may be well to call particular attention to the Porter type of governor used by the Bass Works and of which they are particularly and justly proud. Light balls are used running at high speed, making the governor quickly responsive to any sudden fluctuation of load and hence particularly adaptable to street railway work. Another feature to which particular attention is directed is the releasing or valve gear which is of a special design. Its quietness of action is particularly noticeable. The dash pots are of improved design, and prompt and quiet in action. They are unaffected by sudden variation of load. The finishing of the various

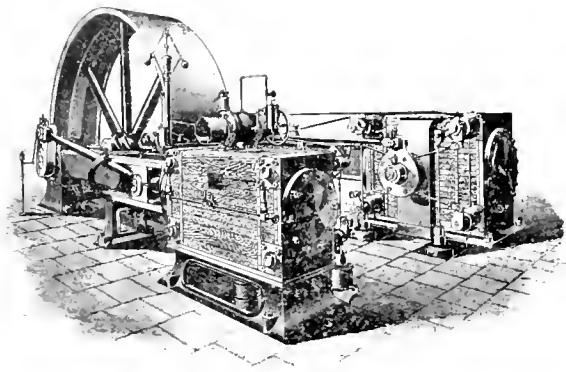

BASS WORLD'S FAIR ENGINE.

parts is congruous and attractive, the cylinders being jacketed with quarter oak and trimmed with nickel mountings. The cylinder heads, rods, crank face, governor valve gear and similar parts are all high polished and pleasing to both mechanical and artistic taste.

As the Bass Foundry and Machine Works have in connection with their machine shops a large steam forge, boiler shop and an extensive foundry, it may be surmised that their faculties for the equipment of power plants are sufficiently adequate, and as all work is under the personal supervision of the company much stress is put upon its even quality.

Our engraving represents a view of the above described engine, showing the two cylinders, the high pressure with live steam pipe on the left and the low pressure on the right.

BRAZIL BRIBERY CASE.

BRAZIL, in the state of Indiana, has been all agog over the alleged bribery of the city council by John D. Sourwine, the vice-president of the new Electric Railway Company. A Chicago man named Edward Childs, a former employe, brought the charges, and claimed possession of letters criminating the council and Sourwine. An investigation proved the charge entirely false and exonerated everyone except Childs, who evidently told more than he knew.

THE MAINE STREET RAILWAY ASSOCIATION.

WITH commendable enterprise and a far-seeing business policy, the street railway men of the State of Maine have formed an association for their mutual advancement and the influence and strength that comes from union.

On August 15, the day for which the preliminary meeting was called, the invited members met at the commodious offices of the Portland Railway Company at Portland.

Ten roads were represented, as follows:

Portland Railway Company, William R. Wood, president; Waterville & Fairfield Railway & Light Company; Bath Street Railway Company, A. F. Gerald, general manager; Biddeford & Saco Street Railway Company, E. H. Banks, president; Monsam River Road, Sanford, Everett K. Day, superintendent; Rockland, Thomaston & Camden Railroad; Augusta, Hallowell & Gardiner Railroad, George E. Macomber, president; Fryeburg Horse Railway, Seth W. Fife, general manager; Lewiston & Auburn Railway Company, F. W. Dana, president.

The constitution and by-laws were adopted, not differing materially from those of similar associations, and officers elected as follows: President, William R. Wood, Portland; secretary and treasurer, E. A. Newman, Portland; directors, William R. Wood, Portland; Fritz H. Twitchell, Bath; A. F. Gerald, Fairfield; J. Manchester Haynes, Augusta; George E. Macomber, Augusta; E. H. Banks, Biddeford; Everett K. Day, Sanford; Seth W. Fife, Fryeburg; Frederick Laughton, Bangor; Frank W. Dana, Lewiston.

The annual meeting will be held the first Wednesday in February, thus not interfering with the American Association and with the numberless other associations and reunions that occur each summer.

After the business session the gentlemen sailed down the harbor to Cushing's Island and made merry at the Ottawa house, the guests of the Portland people.

The formation of this association is the precursor of others in states where united effort would be more effective and where street railways are more numerous.

The State of Maine is to be congratulated on its enterprising street railway men.

THE London Tramways half yearly report reads as follows: Car receipts, \$337,290, an increase of \$12,000 over the corresponding period of last year. Expenses of provender, stable, etc., \$126,065, showing a decrease of \$6,500. The traffic expenses, principally wages, repairs and renewals, \$139,445, an increase of \$4,100, leaving a net profit of \$71,280, an increase of \$15,500. The average number of cars for the half year was 110, compared to 114, and the passengers carried were 12,380,000, against 11,729,000. The increase is accounted for by the fact that London weather was unusually bright.

NEW PUBLICATIONS.

THE IDE ENGINE COMPANY have issued their 1893 catalog, setting forth the value of the high speed type and describing the popular "Ide" and "Ideal."

THE Westinghouse Electric and Manufacturing Company has followed their descriptive catalog of railway apparatus with one giving handsome engravings of all their machinery and appliances.

THE NEW ENGLAND MAGAZINE has passed into the hands of Warren F. Kellogg, formerly treasurer of the Boston Post. Under the new management the publication will lose none of its high qualities.

WHAT AND WHY of Geo. Cutter's Headquarters, is a neat 12-page folder, giving a very interesting and readable description of that great "hive of industry," containing a small city of four thousand workers—"The Rookery."

LIPPINCOTT'S MAGAZINE for August has an account of some of the World's Fair statuary, entitled, "The Lady of the Day." The "Men of the Day" taken up in this number are Sir J. E. Millais, Sir Arthur Sullivan, General Diaz and Phillip D. Armour.

STATISTICS OF RAILWAYS IN THE UNITED STATES for the year ending June 30, 1891; prepared by Edward A. Moseley, Secretary of the Interstate Commerce Commission. This is the fourth annual report of the commission. It treats only with steam roads. The showing for railway investment is as usual rather poor.

REPORTS FROM THE CONSULS OF THE UNITED STATES for July, 1893, has an interesting article by Consul-General Geo. H. Wallace, of Melbourne, on paving in Australian cities. Wood blocks of certain native Australian woods were found to give excellent satisfaction, though the total cost of paving was \$672 a square yard.

HELIOS is the title of a handsome 160-page book issued by the Heine Safety Boiler Company of St. Louis. It will be found of great value to the mechanical engineer, containing much more valuable and practical information than the majority of text books, and much exclusive data. The Heine people are to be congratulated on the volume they are able to present to steam engineers, as well as commended on the pains and money they have spent to make the volume worth something more than a mere catalog.

THE ELECTRIC TRANSMISSION OF INTELLIGENCE AND OTHER ADVANCED PRIMERS OF ELECTRICITY, by Edwin J. Houston, W. J. Johnston Company, 41 Park Row, New York. Price, \$1. This is the last of Professor Houston's excellent series of primers on electrical subjects. As in the other books of this set the matter is taken up in a plain straightforward way that is characteristic of Professor Houston's work. The subjects treated are the telegraph, the telephone, electrolysis, electro-metallurgy, the storage battery, electro therapeutics, electric annunciators and alarms, electric welding, electricity in warfare, and some miscellaneous applications.

POOR'S MANUAL OF RAILROADS for 1893; A. C. McClurg & Company, Chicago; price, \$6. This is the 26th edition of this well known reference book and it is also by far the best one yet published, containing nearly a thousand pages of reading matter. One specially valuable feature is the introduction of reliable colored maps of each state. In brief, the manual contains reliable information in regard to the mileage, routes, stocks and bonds, debts, costs, traffic, earnings, expenses, dividends, organizations, directors and officers of all the steam roads of the United States,—an invaluable fund of information for those connected with railroads in any way.

THE LIMA REGISTER COMPANY, of Lima, O., has reorganized under better circumstances, and will soon market a new and improved fare register. The new company is a strong one, and the register is eminently first-class. The readers of the REVIEW will hear the particulars later.

PICTORIAL EVENTS OF THE MONTH.

CINCINNATI'S horror of September 3 is still the subject of comment throughout the country. On the above date, Avondale car, No. 664, plunged down the grade at Hunt street with a broken and useless brake clanking after it. Three persons were fatally injured and forty seriously hurt. The car was crowded with Sunday pleasure seekers and the accident list thus enlarged. The car crashed into a telegraph pole at the bottom of the hill, splitting it almost in two and cutting the pole smoothly in two, found its final stop almost against the saloon door. In act, pieces of the car broke the glass front of the grog shop.

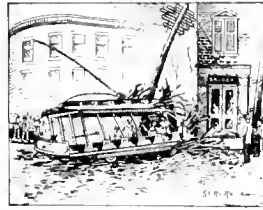

WHEN the sheriff went to levy on the property of Berend Joost's San Mateo & San Francisco Electric Railway recently, he found no cars in the barn awaiting his advent. In fact the witty Joost had a little scheme that would cause the sheriff some difficulty in gathering in the spoils. Joost kept his cars in the next county and to keep them safely, armed his courageous conductors and provided them with nice striped blankets wherewith to wrap themselves as they sweetly slumbered on the seats and dreamed of sheriffs and home sweet home.

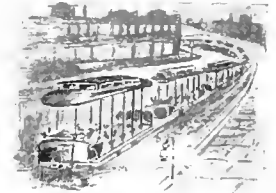

MILLIONAIRE (soi-disant) Wilkinson, whose escapade in relation to the late and fortunately unlamented Central Indiana Railway scheme, tells a sad story. He claims that the wily and psychic Air-ship Pennington hypnotized him, and while under the "influence" made him sign papers which, in his right mind, would have been repudiated by him.

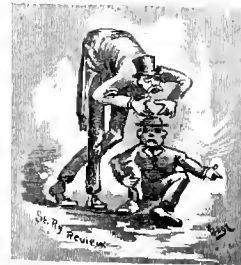

The hypnotic doge is becoming as popular as emotional insanity used to be. Train robbers, embezzlers, fools and frauds find in hypnosis a valuable plea and a ready excuse for all sorts of mad freaks of crime and wild schemes for making money easily. Fortunately few suffered from the hypnotising of Br'er Wilkinson or a long tarry in some cool reformatory might be prescribed for his recovery.

THE city of Toronto, Canada, has been all torn up over Sunday car service. The Antis, supposed by themselves to be led by angels, and the Pros, said by the Antis to be led by Beelzebub, met in bloodless encounter at the polls, August 26, and decided by a majority of only 1,000 to not have Sunday cars. The Sunday walker will now be enjoined, we presume.

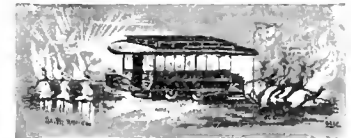

WHEN a real-live elephant gets upon its hinder legs and calls a halt to a cable car, the North Side, Chicago, gripmen, will meekly halt and call "all aboard." This comes from an experience with a pachyderm at the corner of Ontario and Clark streets. It seems that a one-elephant circus that winters north of Lincoln park was returning to hibernation. At 11 o'clock, September 4, they passed the above location, and his elephantship, angered by much tie-walking, concluded to stop a car and ride home. The intelligent beast did just what half his human contemporaries would have done if they had the strength. He simply smashed a car. After several hard blows and much argument from the keeper, the elephant was persuaded to walk.

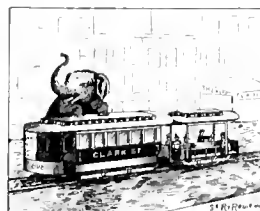

ECHOES FROM THE TRADE.

J. J. DEKINDER, consulting engineer, has removed his offices to Rooms 1206-1208 Betz building, Philadelphia.

GEO. CUTTER, the Rookery, always does the elegant. His latest is a pretty little pamphlet called "Echoes from Electricity Building."

P. S. BEMIS, western agent for Peckham Motor Truck & Wheel Company, has removed his headquarters from the Phoenix building to the Monadnock Building.

THE RAILWAY REGISTER COMPANY, New York, will go to convention. The company is running at its full capacity and, in consequence, Manager Edward Beadle is happy.

THE MEAKER MANUFACTURING COMPANY, Chicago, will attend the convention. J. W. Meaker will represent the fare registers, without which the convention would hardly be complete.

THE FALLS RIVET & MACHINE COMPANY, of Cuyahoga Falls, O., is about to market a new stand and box. E. L. Babcock, the president, will attend the convention, but no exhibit will be made.

THE NEW PROCESS RAW HIDE COMPANY, of Syracuse, N. Y., has been doing good business, and will be represented at convention by A. C. Vosburgh and T. W. Meachem, in charge of an exhibit.

GUY C. PHINNEY, president and general manager of the Woodland Park Electric Railway, Seattle, and one of the most prominent men in the city, died suddenly of heart disease, on Wednesday, September 13.

AFTER giving the Garton street railway arrester a thorough trial, the Panama Electric Street Tramway, of Panama, (Columbia,) have equipped their cars throughout with them, and the equipment has been shipped.

THE Crossley brake is in use on the Cleveland City Railway, the Cleveland Electric Railway and the Connelly Gas Engine Company, everywhere giving great satisfaction. It is at present being tried on the Chicago City Railway.

THE INTERNATIONAL REGISTER COMPANY, Chicago, will soon market a new stationary register. A. H. Englund, secretary and general manager, will attend the convention, with representatives of their registers, both stationary and portable.

THE MOSHER ELECTRIC COMPANY, Chicago, whose arc lamps are specially designed for use on street railway circuits, will exhibit at the Milwaukee convention a series of ten arc lamps on an alternating circuit. Delegates should be sure to see this display.

J. M. DENNISTON, at 802 Monadnock block, Chicago, has taken the general agency for the R. D. Nuttall Company's gears, pinions, bearings and trolleys. Mr. Denniston is an affable gentleman and, as his goods need no introduction to the trade, his success is assured.

THE BUCKEYE ENGINE COMPANY, of Salem, O., will attend convention in the person of G. A. Barnard, now World Fair's agent. The Buckeye, for electric work, is making a splendid record, and the company says the street railway orders exceed the lighting plant orders.

THE LEARY SWITCH COMPANY has completed its new factory at the corner of Broad and Ontario streets, Utica, N. Y. The new plant is a complete one, with its own power and machinery. The switch is becoming very popular among street railways throughout the country.

VISITORS to Milwaukee, desiring photographs and illustrated souvenirs and guide books of the city, will find a large selection at the establishment of C. N. Caspar, 437 East Water street. Mr. Caspar is also a publisher and has recently issued the most complete map of the city yet published.

THE PHOENIX IRON WORKS COMPANY, 519 The Rookery, has just sold the Northern Light Electric Company, of Wahpeton, North Dakota, and the Marine City Electric Light Company, of Marine City, Mich., 100-horse-power compound non-condensing Dick & Church engines.

C. H. HANSON, 44 Clark street, Chicago, is making a specialty of aluminium tickets for street railway use. The Kalamazoo tickets illustrated in our last issue were made by Mr. Hanson and, as then stated, are giving complete satisfaction to the company and the public. Mr. Hanson will have an exhibit at Milwaukee.

THE NEW HAVEN CAR REGISTER COMPANY, of New Haven, Conn., report a rapidly increasing demand for their product, the New Haven fare register, and state that in addition to the many valuable features their register possesses, they have added another for the purpose of indicating the amount of the fares registered.

WADE & BETTIS, electrical engineers and contractors, Gould building, Atlanta, Ga., are representatives of Siemens & Halske in the south, and will do a general engineering business. H. I. Bettis, well known to all street railway men, formerly manager of the Atlanta Consolidated, and Geo. H. Wade, formerly with the General Electric, compose the firm.

THE HOPPES MANUFACTURING COMPANY, of Springfield, O., report the sale of their live steam feed water purifiers and exhaust steam feed water heaters as

extremely active. Recent orders aggregate over 10,000-horse-power, not including 1,000-horse-power for the Columbus Street Railway Company, and 1,000 for the Elmira, N. Y., Illuminating Company.

THE BALL ENGINE COMPANY, of Erie, Pa., has secured an order for a 100-horse-power Ball Engine from the Brooklyn Navy Yard; S. E. Olsen & Company, of Minneapolis, buys two 100-horse-power Ball engines, and the Wilkesbarre Electric Light Company has recently purchased a 125-horse-power engine from J. W. Parker & Company, Philadelphia agents of the Ball Company.

THE death, recently, of E. E. Dennison, of E. W. Clarke & Co., bankers, of Philadelphia, removes from the street railway field a bold and successful financier. Mr. Dennison died of typhoid fever, at the age of thirty-four. He was organizer of the different electric railway syndicates in Louisville, New Orleans, Buffalo, Rochester, Columbus, Lynn, Scranton, Atlantic Avenue Brooklyn, Paterson, Passaic, Newark and other places.

J. HOLT GATES, western manager of the Waddell-Entz Company, reports that they are placing a large motor in the new Illinois Central depot, Chicago, to operate a 60-inch Sturtevant fan, and also a large number of motors for a mining and transmission plant in Michigan. Despite the dull times, considerable work is being done. Agencies have been established in all the principal western cities, where prices are quoted and work installed.

THE RAILWAY EQUIPMENT COMPANY, Pullman building, Chicago, is in receipt of a letter from the Worcester Consolidated Street Railway Company, which is equipped with type G material of the Equipment manufacture. The letter says: "We have about completed our overhead work and it ought to be a big advertisement for your company, as we have the most perfectly equipped road in the country. Every part is first class."

ALBERT FISHER, who has so successfully handled high speed engines for many years, has been appointed the representative in this territory for the Altoona Manufacturing Company, and has opened an attractive office at 1025 Monadnock building, Chicago. Mr. Fisher has years of experience, which make him thoroughly familiar with the needs of railway and lighting plants, and this, combined with a wide acquaintance, makes him one of the strong forces in the field.

THE CLONBROCK STEAM BOILER WORKS, New York, whose mammoth exhibit in Machinery Hall has attracted so much attention, are about to ship one 1,500-horse-power boiler to the Island of Trinidad, where several of their boilers are already in service on an immense sugar plantation. They are also shipping to the Sandwich Islands among other foreign orders. In spite of the general depression, their works, the capacity of which was doubled last fall, are constantly running under full time.

THE STANDARD CAR COMPANY, whose address is lock box 112, Milwaukee, have developed a steam motor especially adapted to traction work, and are pushing to early completion a new car thus equipped, which they hope to have ready in time to exhibit at the convention. It involves several radically new principles, and also works without visible or audible exhaust. The officers of the company are F. A. Merrill, president; Ezra Dederick, vice-president, and N. Merrill, secretary and treasurer.

THE LEWIS & FOWLER MANUFACTURING COMPANY, of Brooklyn, is now taking orders for electric snow sweepers. This sweeper has done satisfactory service for the past three seasons. It has been almost alone in its class, and has vindicated its right to public attention and patronage by its successful fight against the hard snows of last winter, which many of our readers will remember from personal experience. A snow storm taken early and kept up with, by a Lewis & Fowler sweeper, is as harmless as a spring shower.



DOESN'T LOOK LIKE A CROSS GIRL— BUT SHE IS.

C. E. HEALY, of Detroit, the well known inventor of the Healy motor, is about to market a mine locomotive of radically new construction. The machine is an all out and out new departure in bringing out the mine product on the little mine cars, occupying no more height or width than the little cars and at the same time it is in first cost and general economy and favorable results said to be ahead of other power for like service on comparatively level mine tracks, or such lines of no more grades than a traction wheel motor could do the work.

THE MOSHER ELECTRIC COMPANY, 123 to 127 Ontario street, Chicago, has put its street railway lamp on the following roads: Paducah, Ky., Street Railway Company; South Chicago, Ill., South Chicago City Railway Company; Savannah, Ga., Street Railway Company; Los Angeles, Cal., Electric Railway Company; Cedar Rapids, Ia., Light & Power Company; and on the Omaha Street Railway Company, Omaha, Neb. The

lamps are doing the best and most economic service, in spite of the heavy variation of voltage. The Mosher lamp will exhibit at Milwaukee.

THE publishers of the Street Railway News, which has suspended, have our sympathy. They were the first in the field with a weekly paper and have made a determined and gallant fight. Despite all their efforts they were unable to furnish both the paper and the time to read it. Street railway managers are the busiest and hardest worked men in their community and have about all they can do to read one or two monthlies; while with the most of them a weekly piles up on the desk with unbroken wrapper until, in an occasional fit of house cleaning, the janitor dumps them into the waste basket.

A CORRECTION.—Referring to the article on the La Crosse bond wire, which appeared in our July issue, we erroneously attributed the invention to the wrong man. A correction of the mistake was written for the August issue but, through a printer's error, left out. We therefore wish to state that the invention of this effective device belongs to A. von Hoffman, electrician, of Milwaukee, who holds the patent. In speaking of the device, Clement Smith, of the LaCrosse Street Railway, says, writing to Mr. von Hoffman: "I believe that your bond is the best in existence and shall aid you in every way to secure its general use." Eighteen thousand of these bonds are used in the construction of the Milwaukee line. All of the latter are of No. 6 soft galvanized iron.

THE resignation of Henry M. Whitney from the presidency of the West End Street Railway Company, of Boston, removes from street railway circles one of the men to whom electric traction owes its proud boast of bringing forward the shrewdest, most politic and best educated class of men in the country. Mr. Whitney's service in street railway work gave Boston rapid transit, Massachusetts its impetus toward better intramural facilities. To say that he will be missed from street railway circles is as unnecessary as it is commonplace. Mr. Whitney becomes president of the Dominion Coal Company, of Boston and Nova Scotia, in which he is interested. His resignation was occasioned by a multiplicity of responsibilities, which made it a physical impossibility to attend to all.

THE MEDBURY INSULATION, made by the Fibrite Company, of Mechanicsville, N. Y., is rapidly growing in favor. The claims made for it are: It is the strongest insulation made; it shows the highest resistance of any; it is absolutely waterproof; it is the best made and guaranteed; it is for sale at all railway supply houses in every large city. Insulation as every other detail of electric railway practice has grown from crude forms to this present excellence aiming always at perfection. The Medbury insulation is no exception to the rule and to accomplish the end sought, H. J. Medbury, whose years of experience have been spent in research, has brought forth this

superior insulating material. Many street railways will use nothing but Medbury and a continued popularity is assured.

OUR DICTIONARY OF TECHNICAL TERMS.



A HEAD COLLISION.



A REAR END COLLISION.



A ROUND TRIP.



A SHORT CIRCUIT.

WILLIS L. ADAMS, whose street railway acquaintance includes nearly every state in the country, is making a splendid success with his extensive line of general street railway supplies. His offices are at 84 Adams street, this city, a most convenient location, where the visiting manager will always find a warm welcome. He carries in stock at his Chicago warehouse, thus permitting of an immediate shipment, a full line of railway supplies of all kinds, including insulating materials, hard and soft rubber goods and porcelain insulators, in all sizes, shapes and quantities. E. O. Reed, formerly with the H. W. Johns Company and later with the Love Electric Traction Company, travels from the Chicago office; and Charles E. Rowe manages the Boston office, at 116 Bedford street, that city. Both gentlemen have an extensive acquaintance and popularity. In spite of the depression in railway business, Mr. Adams has enjoyed an excellent business all through the hard times, and has taken several large contracts within the past week.

THE COOK HIGH SPEED ELEVATED ELECTRIC EXHIBIT.

ONE of the most attractive exhibits in transportation annex is that of the Cook model high speed line. The model comprises a track 50 feet long, in the form of an ellipse and built to a scale of one inch to the foot. Two cars are constantly operated in opposite directions, one car on the inside and one on the outside rail. A detailed and illustrated description of the system has already been given in these columns.

HALF FARES.

Interesting Facts from All Parts of the Country Boiled Down for Busy Readers.

THE Davenport Street Railway Company continues its system of monthly prizes with continued good effect.

THE Buffalo Railway Company are now carrying over 100,000 passengers daily and have 1,200 names on its pay roll.

THE electric line between Hartford and Glastonbury, Conn., is carrying mails and furnishing an excellent service to the department.

ON the twenty-fourth day of August the South Halsted street branch of the West Chicago Street Railway Company began operations.

BICYCLES to the number of 5,000 are in use in Toledo, Ohio, this year, and on some lines the effect on earnings, though very slight, is perceptible.

THE Metropolitan Railway Company of San Francisco has received the first installment of its added equipment from Carter Brothers Car Works, of Newark, Cal.

A WILD-EYED scheme for an electric railway from Galveston to Houston is organized with the usual "flattering assurances," that are pretty sure to flat out.

MRS. T. EDWARD HAMBLETON, wife of the president of the Baltimore Traction Company, died August 25. Mrs. Hambleton was 54 years of age and a most estimable lady.

TWO strictly up-to-date boys at Paterson, N. J., recently turned the juice on to two big motor cars in the electric railway barns and let them go. Both cars were smashed.

AN ordinance is pending in Cleveland to limit car speeds to five miles an hour on bridges and curves, six miles in business district, eight and fourteen miles in residence and outside districts.

AFTER twenty years' operation the People's Street Railway of Pottsville, Pa., has paid a dividend. The Philadelphia & Reading controls the line and the first dividend was a good big one—eight per cent.

MAIL cars are now running between Marion and Cedar Rapids, Iowa, over the electric road. Service began July 18. Previously it was carried in wagons at \$280 a year. Three mails a day will be carried.

THE 17-year old daughter of Ferdinand Meyer, of St. Louis, signaled her papa's departure to the World's Fair by eloping with one William Bull, a conductor on the Broadway cable line of St. Louis. Pundsters aver that the event is a "horse" on Mr. Meyer.

THE electric railway between Olean and Allegheny, N. Y., has a field of usefulness in running funeral trains between the two places, for the accommodation of the Olean catholics, who have no cemetery. Only the friends of the deceased travel on the cars, the body going by hearse.

AT Bay City, Mich, the electric road is forced to pay the city an annual rental of \$50, for the water the company pumps from the lake through its own pipes and with its own machinery. As it seems to own the water as well as the earth, the name might not inappropriately be changed to "Pay City."

FRED TAYLOR, a lineman of the Mobile Electric Railway had a close call. He was running a new feeder, and when at the top of a 30-foot pole accidentally touched a live light wire. He became insensible and fell, but caught on a guy wire, where his companions rescued him. Recovered in a few minutes.

NEW MEXICAN rivers sometimes hold a teaspoonful of water and an hour later become raging torrents. In a little town beyond the Rio Grande is a small park near the banks of one of the spasmodic streams, and when a flood suddenly fills the water course the street cars carry the following idiomatic inscription, "The River Waters To-day."

AT Bridgeport, Conn., several discharged men sought to form a union of the street railway employes, to secure their own re-installment. Col. Heft promptly put a quietus on the union business by stating no union men would be used by the company, though he favored a strictly benevolent association, and would himself contribute liberally.

THE fifteenth annual Rhode Island clam dinner tendered the electrical fraternity by the American Electrical Works, of Providence, was celebrated Saturday, September 2, at Haute Rieve, and was fully up to its famous predecessors in every way. As a souvenir of the event a handsome deck of cards, bearing the date and place, was handed each guest.

THE NEW YORK STATE CONVENTION.

THE eleventh annual meeting of the New York State Street Railway Association will be called to order at 10:30, September 19, at Powers Hotel, Rochester, N. Y..

The following papers will be presented:

"Recent Improvements in Cable Traction," by Geo. W. McNulty, of the Broadway and Seventh Avenue road, New York; "The Return Circuit of Electric Railways," by Thomas McTighe, electrical engineer, Atlantic avenue road, Brooklyn. President Wyman will probably not preside on account of stress of other business, leaving the chair to the safe hands of vice-president Hasbrouck. Secretary Richardson will be present.

PERSONALS.

HUGO KOESTLER, chief engineer of the Austrian state railway, was an August caller at this office.

ENGINEER ADOLF PRASCH, inspector of the Austrian state railways, was a REVIEW caller of the month.

W. M. STURGES, long superintendent of the Utica Belt Line Railway, resigned his position September 1.

DR. A. EVERETT, of Cleveland, made a pleasant call upon the REVIEW offices while doing the Fair this month.

JOHN MUJR, of Brooklyn, has been appointed receiver of the Schenectady Street Railway, of Schenectady, N. Y.

JOHN PATTERSON, of the Hamilton, Ont., Radial Electric Railway, was a recent World's Fair and STREET RAILWAY REVIEW visitor.

ROBERT VON RECKENSCHUSS, C. E., official referent on street railways of the Imperial Austrian commission, was a visitor at the office of the REVIEW.

R. B. HOLBROOK, the bright engineer of the Cedar Rapids, Ia., Street Railway Company, called at the REVIEW office recently. Mr. Holbrook and a brother engineer were doing the Exposition.

M. J. SULLIVAN, of the Electrical World, was married on Tuesday, August 15th, to Miss Frances Reed, at Freeport, Ill. A number of Chicago friends attended. The REVIEW, together with hundreds of friends, extends congratulations.

W. H. TAYLOR, of New York, is in Chicago, as western representative of the Street Railway Journal. Mr. Taylor makes his headquarters at the Journal office, in Electricity building, at the Fair, and at the Street Railway Gazette office down town.

A. LANGSTAFF JOHNSTON, Richmond, Va., with his family, has been spending two weeks in Chicago and at the Fair. Mr. Johnston returns to commence construction on a contract he has taken in Philadelphia. While here he made the REVIEW a call.

HENRY A. NEWELL has returned as superintendent of the Broadway & Seventh Avenue Road of New York City. He was transferred a few months ago to the Twenty-third Street Line. Mr. Newell has been with the road for twenty years.

ON the retirement of W. A. Larrabee from the superintendency of the Norwich, Conn., street railway, the employes presented him with a purse of \$100. John Wilcox succeeds Mr. Larrabee, who goes into the employ of E. P. Shaw, of Newburyport.

H. H. LITTELL and family, of Buffalo, have taken up their residence at the Hotel Niagara, Buffalo, where their friends will find them in the future. Mr. Littell called on the REVIEW during the recent two weeks he spent at the Fair, accompanied by Mrs. Littell.

ARTHUR E. BAKER, of the Baltimore Car Wheel Company, was a recent caller at the REVIEW office. Mr. Baker has the qualities necessary to make a thoroughly wideawake, American business man of the highest type, and is becoming well known in the street railway field.

W. J. CARRUTHERS-WAIN, has been re-elected president of the Tramways Institute of Great Britain and Ireland. He is director of half a dozen big English tramway enterprises and a favorite with all his employes. He has parliamentary ambitions of the unionist order.

GEO. K. RIDGEWAY, on his resignation from the superintendency of the electric railway at Binghamton, N. Y., to accept a similar position at Hornellsville, was presented with a fine silver tea service by his former employes. A. W. Brockway succeeds Mr. Ridgeway.

W. W. HATCH, formerly of Kankakee, Ill., and now constructing twenty-five miles of electric lines connecting Goshen and Elkhart, Ind., made us a pleasant call. Eventually the interurban will be extended beyond Goshen, and freight as well as passengers carried.

T. H. McLEAN, who is known by reputation to the entire street railway fraternity, and personally to an unusually large number of street railway men, as one of the brightest managers in the country, has assumed his new duties as general manager of the Citizens, of Indianapolis.

C. K. MacFADDEN, formerly constructing engineer for Taylor, Goodhue & Ames, has taken charge of the expert engineering work for Bartholemew, Stow & Co., Chicago. Mr. MacFadden's well-known scientific acquirements and business qualifications will make him eminently capable of his new position.

WM HAZELTON, 3RD, has resigned from the Short Electric Railway Company, of Cleveland, to connect himself with some street railway enterprises in which he and some friends are interested. Mr. Hazelton's success in manufacturing is due to the same energy and foresight which will, no doubt, be shown in his new enterprise.

NICOLAUS AMUNDSEN, civil engineer and telegraph and street railway inspector of the city of Christiana, Sweden, was a recent visitor at the REVIEW office, in quest of street railway knowledge for a complete report to his home government. Mr. Amundsen is making an extended study of the electrical industry in America.

C. B. THURSTON, who has been president of the Jersey City & Bergen Railroad since 1882, asked to be relieved of the responsibility, owing to the many demands on his time in other directions. The board refused to receive his resignation, and retained his services as chief executive by electing David Young vice-president and general manager. Under Mr. Thurston the running headway was reduced from 10 and 20 minutes to 2 and 5, and other improvements made in the same proportion.

PARANITE DISPLAYED.

THE southwest part of the Gallery of Electricity contains half a dozen handsome displays, chief among which may be noted the pavilion of paranite lamp cord, covering the exhibit of the Electric Appliance Company. This canopy is made of 30,000 yards of the famous Paranite wire, composed of 1,440,000 feet of No. 30 copper wire.

Besides the canopy, several reels of the O. K. weather proof wire, and Paranite may be seen grouped about the floor of the space.

Paranite wire, as all know, is made by the Indiana Rubber & Insulated Wire Company, of Marion, Ind., and is particularly adapted for car and power house wiring, as it is strong, safe and durable, three requisites of a desirable insulated conductor for this important part of an electric railway installation.

ON Saturday, September 9, the whole Transportation building went into gala attire and entertained its friends. A committee of the exhibitors, ably headed by Major Pangborn and staff, arranged for a procession of exhibits of transportation, the like of which has never been seen and never will be seen again. Esquimo dog teams and reindeer, old coaches, old engines, and in fact, everything that was moveable, paraded the grounds before a quarter of a million of delighted people. The committee contained the names of prominent exhibitors, transportation department judges and lay brethren interested in the affair. The thanks of the entire transportation department is due Major Pangborn, marshal of the day, Secretary T. H. Young of the commission and the staff which carried through the most successful of parades yet attempted.



WINDSOR & KENFIELD,
PUBLISHERS AND PROPRIETORS.

269 DEARBORN ST., - - - CHICAGO.
Published on the 15th of each month.

SUBSCRIPTION, - - - TWO DOLLARS.
FOREIGN SUBSCRIPTION, - - - 20 SHILLINGS.

Address all Communications and Remittances to THE STREET RAILWAY REVIEW,
269 Dearborn Street, Chicago.

H. H. WINDSOR, Editor. F. S. KENFIELD, Business Manager.

CORRESPONDENCE.

We cordially invite correspondence on all subjects of interest to those engaged in any branch of Street Railway work, and will gratefully appreciate any marked copies of papers or news items our street railway friends may send us, pertaining either to companies or officers. Address:

THE STREET RAILWAY REVIEW,
269 Dearborn Street, Chicago.

Entered at the Post Office at Chicago as Second Class Matter.

This paper member Chicago Publishers' Association.

VOL. 3. OCTOBER 15, 1893. NO. 10

As usual this issue has been held back a few days to include the report of the annual convention.

OUR MEDAL.

THE STREET RAILWAY REVIEW has the proud distinction of being the only publication devoted to transportation interests, receiving a medal at the World's Columbian Exposition. This medal was granted on claims of excellence of illustration and typography, scope and character of its articles both in preparation, originality and evidence of research. The REVIEW has long worn the medal in the hearts of its thousands of friends and readers, who will share with us the honor of this latest public recognition.

FOR the first time in thirteen years, the Chicago City Railway experienced a disastrous fire, on the evening of October 12, in which 461 horses were burned to death. As has so often happened before, the frightened and desperate animals, when turned loose, huddled together and refused to be saved.

ANOTHER fly wheel accident, this time in one of the largest and most recently constructed plants, calls attention to what seems to be a poorly understood subject. These little pleasantries that wheels have had of

late of getting fly and going on a bust are altogether too serious and expensive an entertainment to be often indulged.

THE paper on power house engines, by Mr. Connette, sounds the key note when he says, "The standard of maximum efficiency attainable should be ascertained with each portion of the plant, and each part brought up to that standard." His method of offering a premium for economical firing can also be adopted to advantage by many roads.

THE awful hurricane which visited the South Atlantic coast states October 1 and 2, occasioned considerable direct loss to street railways, and further loss in inability to operate, pending the clearing of fallen trees and other debris which covered the tracks. One manager writes us, "If you could have seen our line after the storm, you would have thought it had engaged in a prize fight and lost the battle."

THE paper prepared by T. J. McTighe for the New York convention, on "the return circuit," is published this month as a continuation of the discussion on this subject that has been going on in the REVIEW for nearly a year past. The views expressed may be taken as representing the most advanced thought on this question, agreeing as they do with the opinions advanced by the majority of writers in our columns. The supplementary wire seems to be justly falling into disrepute, for the reason that it combines extra expense with inefficiency.

IN striking contrast with the action of employes in several roads which have of late been obliged to reduce all expenses, including wages, is the manly attitude of the employes of the Suburban Traction Company, Orange, N. J. Knowing that travel had fallen off heavily, owing to factories along the line having closed, they voluntarily addressed a letter to the manager, saying they had agreed to accept a reduction in wages until travel had recovered if it would enable the road to pull through. The action of the men was a great surprise to the officers of the company and thankfully accepted, although it is not intended that the men shall eventually be the losers by this unusual and commendable offer. The road is to be congratulated on having men who unmistakably have its best interests at heart, and could the same spirit prevail generally there would be much smoother sailing for both companies and men.

ONE of the most interesting electrical events of the World's Fair was the tug of war, Railroad Day, between a Baltimore & Ohio switch engine and the electric locomotive. While the steamer pulled its antagonist across the line, there seems to be every reason to believe the victory was chiefly due to its greater weight. The trial, therefore, has very much to encourage electricians, even though the question of comparative economy of operation was not put in issue. There is no doubt that so far as the electric locomotive for heavy hauling has

progressed, the steam engine is the more economical to operate. But already there are many places where economy of operation is the smallest consideration, and at such places must we look for their introduction. No one dare say, however, that when the electric locomotive has had one-tenth as many years' development as its steam brother, it will not be able to become a valorous rival. It has just hatched; wait until it feathers out, and see it grow.

THE street railway employes of Chicago, especially the conductors and drivers are entitled to a great deal of credit for the splendid work they have exhibited the past few months. To them has been delegated the unprecedented task of caring for the safety and lives of the visiting hundreds of thousands, many of whom are as little familiar with street car operation as they are with the Chinese language. Cars crowded to the boards with passengers, many of whom were as helpless as children; and multitudes of others who take to the middle of the road just as they are accustomed to do at home, have called for a constant and sharp watch in all directions at one moment. It has been one long drawn out nervous strain covering a period of six months, and to these faithful men the close of the Fair will be a relief and relaxation little appreciated by the general public. There have been some accidents to life and limb in spite of all precautions, but no more than seem always inevitable to such gatherings, and no one knows how many hundred serious accidents would have been recorded but for the guardianship of the much abused conductor and driver. The street railway boys of Chicago have made a Columbian record, deserving of a medal.

SEVERAL of our steam railway exchanges, in commenting on the steam-electric locomotive contest, railroad day, express the belief that if electricity is adapted to long distance train hauling, it will be by the application of motors to each car, rather than motors in the first car or "engine." Practically, this is good, as each car and its load would then furnish its own traction weight instead, as now, of offering nothing but a dead weight to be pulled. But against this, under present methods of motor control, the difficulty in making the proper connections from one car in a train to another and bringing all of these connections to the front end of the train, are almost unsurmountable obstacles in the way of running long trains, with a motor for each car. That the running of such trains is possible cannot be doubted, but that it will soon be practicable is a serious question. Where a part of the train weight can be made available for traction, by fitting up one car with motors, as on the Intramural Railway, it is all well enough, but the multiplicity of connections, the large number of motors to be taken care of, and the lower efficiency of small motors cannot compete with concentrated power, as it is on a locomotive where all repairs and troubles are located in one machine. If electricity replaces steam there will probably be some material changes in present train service, probably by

increasing the number and decreasing the length of trains, but it would be an unexpected turn of affairs that would put a motor under each car of a train.

SOME of our English exchanges are greatly exercised over what they profess to believe a failure of the World's Fair, and one remarks "probably no other scheme introduced to the world, with such a blowing of trumpets, has ever fallen so flat," and continues with the statement that "the visitors are mostly country folk, coming from a radius of about 300 to 500 miles." We confess the attendance of "folk" from across the water, especially from England, was far short of what our English friends owe themselves, but the day this is written the REVIEW has received callers from Chili, Germany, Austria, South Africa and Australia, all attending the Fair, and it is not a very good day for visitors either. It is true, in giving to the world the grandest production known to history, Chicago has contributed, as individuals and as a city, the unprecedented sum of ten millions of dollars. No other city on the face of the globe could, or would have done the same, nor would any other have produced such buildings and grounds in the same length of time. No one in Chicago is complaining because there is little prospect of getting back any considerable part of the ten millions, the people who whine about it don't live in this town, though some of them do in England. All the debts will be paid, and Chicago will have what is better than a few contemptuous millions, the satisfaction of having more than fulfilled its promises to the world, and in her own inimitable manner. The only really "flat" thing about the Fair is the ignorant criticism of people who have not seen it. That our foreign brothers are in much dense ignorance, is evident from a letter of condolence from a gentleman in London received by the REVIEW, based on the "continued and terribly stormy weather which had so largely interfered with the Fair!" On the day the letter was received there had not been a drop of rain here in nearly three months. There is an evident need of trolleys, or something, over there to wake the people up.

AN old fossil in Brooklyn, who grinds out letters to the daily papers, and hides under the sympathetic signature of "Humanity," is greatly exercised because a small boy, who, as nearly as can be determined, was stealing a ride on the car, was run over and had a leg crushed, as Humanity says, "by the trolley." After experiencing all the thrills of horror of which Humanity was capable, he winds up with the progressive demand of: "Give us the horse cars; they are best after all!" Experience has not demonstrated, however, that on the basis of the same number of passengers carried, the horse cars fail to get in their work quite as effectually as the cable or electric. We even know of at least one city where both horses and mechanical power are used by the same company, in which the harmless and inoffensive horse car has for a long time carried the palm for deadly execution, and carried it away up high, too. It may be more painful to lose

an arm or a leg by a "trolley" than under the wheels of a good old horse car—we cannot speak from personal experience—but that is an open question, and admits of much argument in favor of the former method of amputation. Humanity hangs out the same old objection that was raised when the first steam road thundered along at fully eight miles an hour. The world moves; moves faster every year, and the great mass of the public demand a faster moving street car than was satisfactory ten years ago. The responsibility for accident arising from rapid transit largely belongs to the public which demands that kind of transit. One of the best authorities on street railway management, himself at the head of a large eastern syndicate operating in several cities, wrote us a few days ago and concisely but pointedly defined the situation in the following words: "The people of rapidly growing cities desire the benefits which come from rapid transit on street car lines; rapid transit cannot be had unless the cars move fast. If people are careless or indifferent while on the street where cars are running, accidents are quite certain to happen no matter how careful the men are who have charge of the cars."

HALF FARES.

Interesting Facts from all Parts of the Country Boiled Down for Busy Readers.

THE Minneapolis Street Railway Company has the funeral car business under consideration.

CHAS. BODE, chief engineer of the North Side Street Railway, Fort Worth, was a Chicago visitor in September.

MANAGER W. A. GRANT, of the Niagara Falls Park & River Railway, entertained a distinguished party of Canadians with a trip over his line on October 4.

CONDUCTOR ENOCHS, of Austin, Texas, got a good strong 500-volt shock the other day, being knocked down and slightly burned, but was on duty in twenty-four hours.

A TROLLEY car in Brooklyn had a race to keep out of the way of a runaway team, and succeeded in coming out victorious, though with a somewhat frightened motor-man and load of passengers.

THE Chicago Electric Club has grounded, owing to a short circuiting of the monthly dues, and the fact that members are too busy to give it the time necessary to maintain interest at a proper voltage.

THE Evansville, Ind., strike was settled by fixing twelve hours as a day's work, at fifteen cents per hour, until such time as business shall improve, when the former rate of seventeen cents is to be resumed.

THE damage done to the New Orleans lines by the recent storm on the gulf was not serious. The tracks

were washed away to some extent and were under water in many places, but the most trouble was experienced by the falling of trees.

GEORGE E. PRATT, of the Lamokin Car Company, of Philadelphia, has distinguished himself as an efficient worker in all matters pertaining to the good of the transportation exhibitors. He was secretary of the executive committee on Transportation Day.

LIFE saving fender No. 504,641 was tried on the DeKalb avenue line in New York a few days ago and pronounced by the Electrical Subway Commissioners to be the best they had yet seen. The undertakers don't like them. They say it musses up a corpse so.

THE photographer of the battlefield of Gettysburg, W. H. Tipton, is suing General D. E. Sickles for \$10,000 damages. General Sickles was president of the New York State board of Gettysburg battlefield commissioners, and the difficulty arose on the question of the useful and now much admired trolley road. Mr. Tipton was largely responsible for the road and General Sickles was insanely antagonistic to it. Mr. Tipton asserts that Sickles influenced the New York veterans against his (Tipton's) photographic business.

THE late rule of mob law at Roanoke, Va., called out a new use for electric cars. Our readers will remember that at this time a negro murderer was confined in the jail and an attempt was made by the infuriated people to lynch him. Orders were telegraphed to Salem, seven miles distant, to hold the militia in readiness, and an electric car was detailed to stand prepared to transport the troops. This opens a new possibility of usefulness for the electric car and will no doubt grow upon municipalities as has the street car mail service.

THE Connelly gas motor factory, of this city, has turned out in all twenty-one motors for the North Chicago Street Railroad. They are being run regularly on the Sheffield avenue line, and on the Garfield avenue and Center street line. A petition presented to the city council by a few of the property holders along the above lines, asking that the motors be abolished, was apparently uncalled for and unwarranted and supported mainly by soreheads and kickers. The corporation lawyer has decided that the city has no power to prohibit the use of these motors.

FOR one long breathing spell of a whole day the Chicago papers praised the street railway facilities of Chicago. That time was the next day after the great Chicago Day crowd. Complimenting the Illinois Central express trains, the Times says: "But while this is said for the Illinois Central, it must not be construed as in any sense a reflection upon the other lines. All did their duty. All met the situation satisfactorily, everything considered. The other lines were the boats, the South Side cable, and the elevated. Whoever was good tempered and patient did not fail of satisfactory transportation."

A SPLENDID CONVENTION.

Milwaukee's Unbounded Hospitality—Abundance of Room for Everybody and Everything—Attendance at Sessions Largest Ever Held—Fine Display of Exhibits—Elaborate Banquet.

EVERYTHING at Milwaukee conspired to make the meeting an unbounded success. Hotel accommodations were good and ample; the weather was fine; the whole of an immense exposition building was at the disposal of the association; and the arrangements of the local committee were perfect. The attendance of street railway officials was large, though the effect of exhibits at the World's Fair was noticeable, as the display was fully one-fourth smaller than last year, but under the circumstances larger than

somewhat settled and systematic appearance. Space was quite equally taken by the exhibitors in their respective lines, and many of the booths were made attractive with bunting. There was a decidedly marked tendency however, this year, toward the practical in the way of decorations. Inasmuch as the display lasts so few hours, the plan would be a most sensible one to follow in future years.

In the sessions, attendance was larger than ever before and the papers attentively listened to, although the difference in interest was marked between those papers which had been printed in advance and which members could hold and follow the reader. The association should endeavor some way to enforce this perfectly suitable ruling that all papers must be in hand at least two weeks in advance of meeting. With a whole year in which to prepare this is no hardship.

Everything was previously arranged. At the convention assembly room, several of Mr. Payne's best looking conductors, in uniform, were ever present to register newcomers and act as guides. In this connection it is proper to note the remarks, on all sides, complimenting the polite and gentlemanly conduct which was exhibited on all the cars, not only toward visitors, but regular patrons.

General regret was expressed that, owing to poor health, Mrs. Henry C. Payne was unable to give as much time to the ladies as she would have liked to have done. She had not been unmindful of their comfort, however, and all the arrangements which had been so fully and thoughtfully made, were of her own planning. It was at her own personal request that the very unusual and delightful privilege was accorded the visiting ladies of viewing the beautiful art collections, at the mansions of Mrs. Allis and Mrs. Metcalf. Miss Jones, a niece of Mrs. Payne, and a most accomplished young lady, ably represented Mrs. Payne.

Transportation between hotels and convention building was admirable. Special cars for the exclusive use of visitors were run constantly, and a special book of tickets, good on any line in the city, was furnished the guests.

Cars, sweepers and heavy supplies were hauled by the local committee and delivered at the exposition, and more than one exhibitor was astonished to find, instead of a long hunt in a strange place for a sidetracked car of goods, that it was in his assigned space in the building all ready to unpack.

The entertainment in rides, both electric and in carriages, places of interest to visit and attention on every hand, abundantly proved the well known hospitality of Milwaukee and its splendid street railway men, who spared no effort to make the occasion what it was—an unqualified success.

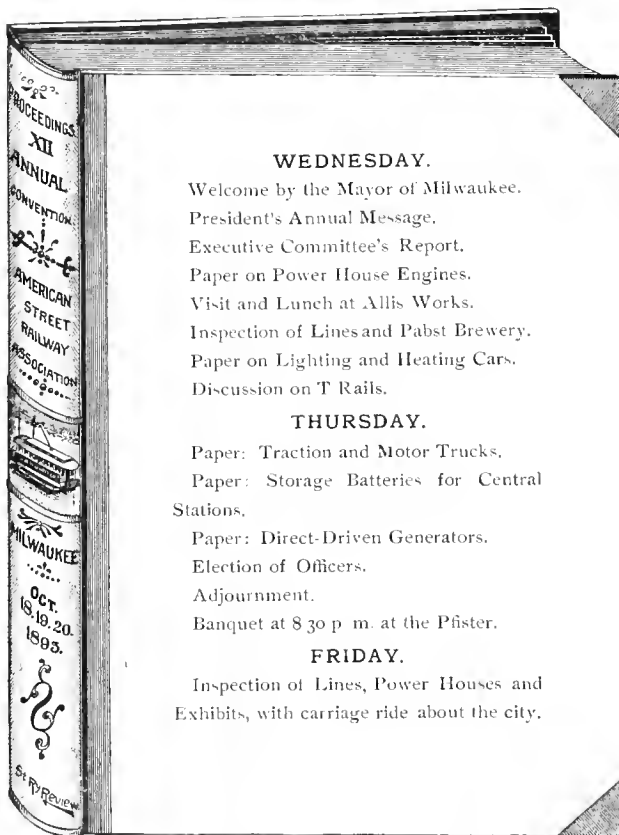

could reasonably be expected. The advantages of having business sessions and exhibits all under one roof was evident and not a minute was wasted. A fine brass band in the gallery of the exposition played during the day and evening, and the decorations of the building were tasty and extensive. The location of exhibits to insure an aisle on at least two sides of every space was especially satisfactory. There was no crowding although several thousand citizens called to see the display.

All Tuesday night busy forces of experts, in all the various diversities of railway supplies, were busy in getting their exhibits in shape for the opening day. In spite of all this a great deal remained to be done at daylight, and it was not until after noon that the floor assumed a

Everything was auspicious for a good convention as the members gathered in the art room of the Exposition, and indulged in the annual greetings and hand shakes. But few had met since a year ago and many were the jokes at some brother who had grown gray or bald.

WEDNESDAY MORNING SESSION.

Promptly at 10:30 the convention was called to order by President Longstreet, who introduced Mayor Koch, who welcomed the Association in the following words:—

“MR. PRESIDENT AND MEMBERS OF THE AMERICAN STREET RAILWAY ASSOCIATION:

“It affords me great pleasure in meeting you to-day in our city and in our Exposition building. I welcome you and extend to you the freedom of the city.

“Gentlemen, you are interested in one of the great forces of modern times, which builds up large cities, and gives us the convenience of rapid transit. The street railways are great factors in our progress. They relieve the large cities from being over-crowded, and allow the spreading of our population over widely extended territories, thereby giving the people the benefit of fresh country air in the suburban neighborhoods, which is of inestimable value to the health and happiness of the population of large cities.

“I hope this meeting will be productive of much good and have a satisfactory result. I hope also that besides the practical part of this meeting, you will enjoy your visit to our city, and that friends here will take good care of you. Gentlemen, you are welcome.”

President Longstreet then replied as follows:

“MR. MAYOR:

“On behalf of the American Street Railway Association I have the honor to thank you for your cordial welcome, and to assure you in advance that we shall take away from your beautiful city many pleasant memories. We have already been advised of the very liberal arrangements which have been made for our entertainment by the local committee, and I assure you it will be our own fault if we do not go away with a knowledge of your city and its institutions only equalled by that of the oldest inhabitant. We are gathered here in annual session for a two-fold purpose—to exchange ideas and experiences with each other and to see the display of goods which we all have to buy, as made by the companies who manufacture them. It was intended that this should be the most complete exhibition we had ever witnessed, and but for the special exhibit at the World’s Fair which most if not all our members have had an opportunity to inspect, and for the unexpected delay in freight delivery, it would have been much more perfect than it is, but such as it is we invite you Mr. Mayor and those you represent—the entire population of this goodly city to examine it with us.

“Should the crowd get so large that we cannot see the goods ourselves then we shall be obliged to limit the admission by ticket, but if the public will call when the members are in business session I think there will be no difficulty in accommodating all who wish to come.”

PRESIDENT LONGSTREET’S ADDRESS.



GENTLEMEN OF THE CONVENTION:—

I wish to express my gratitude for the honor conferred upon me a year ago by my election to the highest office within your gift, and my deep regret that circumstances, entirely unexpected, and over

which I have seemingly had little or no control, have confined me in a part of the country far removed from the center of our business interests, and so much of my time has been necessarily devoted to other business interests, of a personal nature and of vital importance to me, that I do not feel that I am fully in touch with the affairs that have brought us together, at the close of one of the most eventful years in our history, as an organization.

This has been a busy year in the great work of consolidation, re-organization and active progression; the financial cloud, which has hung so threateningly for so many months over every industry in our land, has had its retarding effect upon our particular industry, but perhaps it has affected our business in a lesser degree than any other branch of business employing so large a capital.

The hundreds of millions of dollars interested in urban and suburban transportation will always be a safe investment; if, in our enthusiasm, we have sometimes over-discounted the future, we have only to wait a little longer period for the dividends which are sure to come.

Financial panics, through which we are now passing, are of irregular occurrence, yet they are sure to reappear, affecting receipts and making economies of management a subject of deep study.

In my experience, covering a period of nearly thirty years, I have found it better to keep up the quality of service at such times, even at the expense of dividends for the time being; the public, by a more liberal patronage, will eventually more than make up the loss which would follow on the heels of a reduced and debased service; the faithful employe and the road bed and equipment should be the last to suffer.

Economies should begin in other directions, in the purchase of supplies, in better methods of work, and in improved appliances, aiming always for the best service, at the least possible cost; and that, gentlemen, is the fundamental principle of the prime reason for our organization; and that is why, in just such times as we are now passing through, we should see if some plan cannot be devised which will increase the usefulness of our association.

One such plan was proposed by me a year ago and was referred to the executive committee. After a careful consideration of the matter, the committee decided to give an object lesson of that plan at this time, and therefore arrange for an exhibition on a grand scale, of all the appliances used in our business.

While the usual financial stringency and the special

exhibit at the World's Fair have served to detract very much from the completeness which we had hoped for this exhibition, yet it will be sufficient as an indication as to what might be expected from a continuous exhibition of this kind.

The statistics of our business, which a dozen years ago looked so large, are dwarfed into absolute insignificance by the figures of to-day, and yet the work has only just begun; very much more progress will be made in the next decade than has been made in the last, and therefore an active struggle to get the best results and to keep thoroughly "up to date" in all the details of construction, equipment and management will be worth more to our interests than can be foretold.

The papers to be read and discussed at this meeting will be enumerated in the report of the executive committee which is to follow, and I am sure they will be interesting and instructive. It is hoped the delegates will enter fully into these discussions so as to bring out all the ideas which belong to the subject.

Not of the least importance at these annual gatherings is the social intercourse and friendly interchange of information and ideas, not only on the floor of the convention but in the exhibit rooms, at hotels and wherever members may meet.

Intelligent men, in the same line of business, coming together from all parts of a vast country, such as is covered by our membership, cannot but be of aid to each other in establishing principles which should govern the conduct of our business.

This feature will grow with each succeeding convention; new and energetic blood is being yearly infused into our meetings, and as it meets with the sturdy pioneer, each will rub off the other something they will take home to think about, and to their mutual benefit.

Without trespassing further upon your time I commend the business of the convention to your hands with full confidence that the discussions will be full and complete and that the results will be satisfactory and beneficial to every delegate present at this twelfth annual convention.

Thanking you, gentlemen, for your kind attention and giving you each a hearty welcome and a God speed, we will now proceed with the regular order—the report of the executive committee. (Applause.)

EXECUTIVE COMMITTEE REPORT.

MILWAUKEE, October 18, 1893.

THE AMERICAN STREET RAILWAY
ASSOCIATION.

GENTLEMEN:

Your executive committee respectfully submits the following report:

MEMBERSHIP.

At the opening of the meeting in the city of Cleveland there were

204 companies members of the Association.

At that meeting, and during the year, the following companies have joined:

Alexandria, Va. Washington, Alexandria & Mount Vernon Railway Company.
Bay City, Mich. Bay Cities Consolidated Railway Company.
Chattanooga, Tenn. Chattanooga Electric Railway Company.
Chicago, Ill. Calumet Electric Street Railway Company.
Great Falls, Mont. Great Falls Street Railway Company.
Hazelton, Pa. Lehigh Traction Company.
Ironton, Mich. Twin City General Electric Company.
Norristown, Pa. Norristown, Bridgeport & Conshohocken Traction Company.
Philadelphia, Pa. Hestonville, Mantua & Fairmount Passenger Railway Company.
Racine, Wis. Belle City Street Railway Company.
Roanoke, Va. Roanoke Street Railway Company.
Wilmington, N. C. Wilmington Street Rail Road Company.
Worcester, Mass. Worcester, Leicester & Spencer Street Railway Company.

The following changes in the names of members have taken place:

Cleveland, O. Cleveland City Railway Company in place of Cleveland City Cable Railway Company and Woodland Avenue & West Side Street Rail Road Company.
Des Moines, Ia. Des Moines City Railway Company in place of Des Moines Street Rail Road Company.
Dover, N. H. Consolidated Light & Power Company in place of Union Street Railway Company.
Long Island City, N. Y. Steinway Railway Company in place of Steinway & Hunter's Point Railway Company.
Mobile, Ala. Mobile Street Rail Road Company in place of Mobile Street Railway Company.
Ottawa, Ont. Ottawa Electric Railway Company in place of Ottawa City Passenger Railway Company.
Pittsburgh, Pa. Pittsburgh & Manchester Traction Company in place of Pittsburgh, Allegheny & Manchester Traction Company.
Reading, Pa. Reading Traction Company in place of Reading City Passenger Railway Company.
Springfield, Ill. Springfield Consolidated Railway Company in place of Springfield City Railway Company.
Springfield, O. Springfield Railway Company in place of Springfield Electric Railway Company.
St. Louis, Mo. Southern Electric Railway Company in place of Southern Railway Company.
Syracuse, N. Y. Syracuse Street Rail Road Company in place of Syracuse Consolidated Street Railway Company.
Waterbury Conn. Waterbury Traction Company in place of Waterbury Horse Rail Road Company.
West Haven, Conn. Winchester Avenue Rail Road Company in place of New Haven & West Haven Horse Rail Road Company.

The following changes of names of companies by substitution, the new companies succeeding the old, have taken place:

Canton O. Canton-Massillon Electric Railway Company in place of Canton Street Railway Company.
Cleveland, O. Cleveland Electric Rail Road Company in place of Brooklyn Street Rail Road Company, Broadway & Newburgh Rail Road Company and East Cleveland Rail Road Company.
Fort Wayne, Ind. Fort Wayne Electric Railway Company in place of Fort Wayne Street Rail Road Company.
Minneapolis and St. Paul, Minn. Twin City Rapid Transit Company in place of Minneapolis Street Railway Company & St. Paul City Railway Company.
Portland, Ore. Portland Consolidated Street Railway Company in place of Metropolitan Street Railway Company.
Scranton, Pa. Scranton Traction Company in place of Scranton Street Railway Company.

The tendency of the times is still towards consolidation in the street railway business, as in every other.

The following companies, now being controlled and operated by member companies, have therefore withdrawn:



Boston, Mass. Boston & Revere Electric Street Railway Company by Lynn & Boston Rail Road Company.

Cincinnati, O. Mt. Adams & Eden Park Incline Railway Company by Cincinnati Street Railway Company.

New York, N. Y. Broadway & Seventh Avenue Rail Road Company, Central Park, North & East River Rail Road Company, Forty second Street & Grand Street Ferry Rail Road Company and Twenty-third Street Railway Company by Houston, West Street & Pavonia Ferry Railway Company.

Philadelphia, Pa. Second & Third Streets Passenger Railway Company by Frankford & Southwark Passenger Railway Company.

Salem, Mass. Naumkeag Street Railway Company by Lynn & Boston Rail Road Company.

The following companies have also withdrawn:

Asheville, N. C. Asheville Street Railway Company.

Attleboro, Mass. Attleboro, North Attleboro & Wrentham Street Railway Company.

New Orleans, La. Canal & Claiborne Rail Road Company.

Sioux City, Ia. Sioux City Street Railway Company.

As the result of these changes, there are now 197 members.

MINUTES OF SPECIAL MEETING OF THE COMMITTEE.

The time of the last annual meeting was so fully occupied that it was impossible for the executive committee to meet during the session. A special meeting of the committee was held in the city of Milwaukee on Wednesday, December 7th, 1892, the minutes of which are as follows:

Minutes of special meeting of the executive committee, held in the club room of the Plankinton hotel, Milwaukee, Wednesday, December 7, 1892, at 3 o'clock p. m.

There were present the president and Messrs. Bean, Minary, Chapman, Charlton, Thomas H. McLean, representing John D. Crimmins, and upon invitation, H. C. Payne, vice president and manager of the Milwaukee Street Railway Company.

Letters of regret were received from Messrs. Everett, Hurt and Holmes.

Mr. Bean moved that the Plankinton hotel be selected as the headquarters of the association for the next convention, provided suitable arrangements can be made for the meetings of the executive committee and the banquet. Carried.

Mr. Minary moved that we secure the Exposition building on the terms offered, namely, two thousand dollars for two weeks rent, and that the business meetings be held in the assembly hall of the Exposition building. Carried.

Mr. Bean moved that Mr. Payne be requested to ascertain from all the hotels the number of rooms and the prices per day therefor, that they will reserve for one week previous to the meeting, for delegates in attendance at the next convention. Carried.

On motion of the President, the following resolution was unanimously adopted:

WHEREAS it is evident to this committee that the best interests of the Association would be served by a less abundant supply of wines at the annual banquets, therefore, be it

RESOLVED, that this committee especially requests those who will have charge of the banquet preparations to limit the supply of wines to be used.

Mr. Bean moved that the price to be charged exhibitors at the Exposition be made at the rate of 10 cents a square foot, and not less than one hundred feet be allotted to any exhibitor, nor more than two thousand feet, except by special arrangement with the Secretary. That the notices to be sent to manufacturers and inventors shall state that arrangements may be made for power at cost, so that if power is desired, the extent may be made known in the application, also, that special arrangements may be made for a limited number of exhibits in the booths now on the floor. Carried.

The following subjects were chosen on which special reports should be prepared: "Storage Batteries in Connection with Central Stations for Utilizing Surplus Energy for Lighting or Power." "Direct Driven Generators." "Best Method of Lighting and Heating Street Railway Cars."

On motion, O. T. Crosby, Charles W. Wason, L. H. McIntire, Thomas H. McLean and C. G. Goodrich were appointed the Committee on Standards for Electric Street Railways.

The Secretary submitted a map of the United States, on which was plotted the street railway companies, members of the Association being in blue and non-members in red.

It having been referred to the Committee to consider the feasibility of the formation of an Industrial Institute under the auspices and control of this Association, the Secretary submitted the following proposed act of incorporation of the American Street Railway Institute:

AN ACT TO INCORPORATE.

THE AMERICAN STREET RAILWAY INSTITUTE.

The people of the state of _____, represented in senate and assembly, do enact as follows:--

Section 1. D. F. Longstreet, A. Everett, Joel Hurt, W. Worth Bean, William J. Richardson, John G. Holmes, John D. Crimmins, Thomas J. Minary, J. R. Chapman and Benjamin E. Charlton, at the present time the officers and executive committee of the American Street Railway Association, and such persons as may hereafter become officers and members of the executive committee of the American Street Railway Association, only, however, while connected officially with any street railway company that is a member of the American Street Railway Association, are hereby created a body corporate, by the name of the American Street Railway Institute, to be located in the city of _____, for the purpose of establishing and maintaining in said city a permanent collection and exhibition of street railway supplies and manufactures, and of encouraging, developing and disseminating experimental, statistical and scientific knowledge, relating to the construction, equipment and operation of street railways, for the purpose of increasing the accommodation and comfort of the traveling public by improving the service and reducing its cost.

Section 2. Said corporation shall have power to make and adopt a Constitution and By-Laws, and to make rules

and regulations for the admission, suspension and expulsion of its members, and their government, the number and election of its officers, and to define their duties, and for the safe keeping of its property, and from time to time to alter and modify such Constitution, By-Laws, Rules and Regulations. Until an election shall be held pursuant to such Constitution and By-Laws, the persons named in the first section of this Act shall be and are hereby declared to be the trustees and managers of said corporation and its property.

Section 3. Such corporation may purchase and hold, or have any real and personal estate necessary and proper for the purposes of its incorporation, provided they shall not hold real estate which shall exceed one million dollars in value.

Section 4. Said corporation shall possess the general powers, and be subject to the restrictions and liabilities prescribed in Title -, Chapter -, Part -, of the Revised Statutes.

Section 5. This Article shall take effect immediately.

CONSTITUTION.

ARTICLE I.

This corporation shall be styled The American Street Railway Institute.

ARTICLE II.

The several persons named in the Charter and such others as may be added to their number, shall be the trustees to manage the offices, property and business of the corporation.

ARTICLE III.

The trustees shall meet annually on the third Wednesday in October, at the same place at which the regular annual meeting of the American Street Railway Association is held, and elect the officers and committees for the ensuing year. They shall also meet at any other time to transact special business, on a call of the secretary, who shall issue such call whenever requested so to do, in writing, by five trustees, or by the president, and give written notice to each trustee of such special meeting and of the object thereof, at least ten days before the meeting is held. A majority of the trustees for the time being shall constitute a quorum for the transaction of business, but five trustees may adjourn and transact current business, subject to the subsequent approval of a meeting at which a quorum shall be present.

ARTICLE IV.

Section 1. The officers of said corporation shall be a president, a vice-president, a secretary and treasurer, all to be elected from the trustees. The offices of secretary and treasurer may be held by one and the same person. These officers shall be elected by ballot, and the persons having a majority of the votes cast shall be deemed duly elected. They shall hold their offices one year, or until their successors shall be elected and qualified.

Section 2. The board of trustees shall appoint each year, in such manner as it may direct, the following standing committees. These committees are all to be elected from the trustees, and the members shall hold office for one year, or until their successors shall be elected and qualified. The board of trustees shall also have authority to appoint such other committees or officers as they may at any time deem desirable, and to delegate to them such powers as may be necessary.

ARTICLE V.

Section 1. The president shall have a general supervision and direction over the affairs of the corporation, and shall preside at all the meetings of the Institute and of the trustees. In his absence or inability to act, the vice president shall act in his place. The president shall be a member ex officio of all standing committees. He shall be paid such salary as shall be fixed by the executive committee.

Section 2. The secretary shall be present, unless otherwise ordered by the board of trustees, at all the meetings of the Institute and trustees

and committees. He shall keep a careful record of the proceedings of such meetings, shall preserve the seal, articles and correspondence of the Institute, shall issue notices for all meetings of the trustees and various committees, and perform such other duties as the board and president may direct. He shall be paid such salary as shall be determined by the executive committee.

Section 3. The treasurer shall receive and disburse the funds of the Institute. He shall make a full report in writing at each annual meeting of the trustees, showing the receipts and disbursements, the balance of money on hand and the outstanding obligations of the Institute, as far as practicable, with such suggestions as to the financial management of the Institute as he may deem proper.

Section 4. The accounts of the Institute shall be kept at the general office, in books belonging to it, which shall at all times be open to the inspection of the trustees. He shall give such bonds for the faithful performance of his duties as the board may direct. He shall be paid a salary, to be fixed by the executive committee.

ARTICLE VI.

The executive committee shall consist of nine, including the president, vice-president and treasurer. The other six members of the committee, elected in October, 1893, shall forthwith draw lots for one, two and three years respectively, and the terms for which those drawing the two and three years respectively were elected, are hereby extended to cover those periods, and, hereafter, at each annual election, two members of the executive committee shall be elected to serve for three years. They shall have the control and regulation of the exhibits, library and other property of the Institute, and shall have power to purchase, sell and exchange the exhibits and books that are the property of the Institute, and direct the arrangement of all exhibits, to employ agents, to regulate the manner and terms of exhibiting the Institute to the public, and generally to carry out in detail the directions of the trustees, but the executive committee shall not incur any expense or liability for the Institute for any purpose exceeding the amount received, as herein provided. Five members of the committee shall constitute a quorum for the transaction of business.

ARTICLE VII.

The auditing committee shall consist of three trustees. It shall be their duty to examine and certify all bills presented against the corporation, and no bills shall be paid unless first approved by the president, or the chairman of the executive committee in writing. They shall also have the books of the Institute duly audited at least once in six months, by an authorized public accountant, to be selected by them.

ARTICLE VIII.

The finance committee shall consist of four, including the treasurer. It shall be their duty to take charge of, and invest the funds of the Institute in its name, and to take all proper measures to provide for its support, and they shall have the sole custody of the securities belonging to the invested funds of the Institute, subject to the order of the board of trustees.

ARTICLE IX.

The nominating committee shall be composed of three, to whom shall be first submitted the name of any person other than hereinbefore provided, who desires to become a member of the Institute. The committee shall report on such candidates from time to time, as they may deem to be for the interest of the Institute, and upon their unanimous recommendation, and the payment of the sum as herein provided, they shall become members.

ARTICLE X.

By-laws may from time to time be made by the trustees, providing for the care and management of the property of the corporation, and for the government of its affairs, and may be amended at any meeting of the trustees by a vote of a majority of those present, after a month's notice in writing of such proposed amendment.

ARTICLE XI.

The contribution or subscription of \$1,000 or more to the funds of the Institute, at any one time, shall entitle the person giving the sum to be a Patron of the Institute, who shall have the right in perpetuity to appoint the successor in such patronship.

The contribution or subscription of \$500, at one time, shall entitle the person giving the same to be a Fellow, who shall have the right to appoint one successor in such fellowship.

No appointment of a successor shall be valid unless the same shall be in writing, endorsed on the certificate or by the last will and testament.

The contribution of \$100, at one time, shall entitle the person giving the same to be a life member.

Any person may be elected by the trustees to any of the above degrees who shall have given to the Institute books or property, which shall have been accepted by the executive committee, or by the president, to the value of twice the amount in money requisite to his admission to the same degree, and the president and secretary shall issue diplomas accordingly, under the seal of the Institute.

The trustees may also elect honorary fellows of the Institute in their discretion.

ARTICLE XII.

No alterations shall be made in this constitution unless at an annual meeting of the trustees, or at a special meeting called for this purpose nor by the votes of less than a majority of all the trustees, nor without notice in writing of the proposed alteration, embodying the amendment proposed to be made, having been given at the preceding annual meeting.

BY-LAWS.

I.

Patrons, fellows, or their successors, and life members are each entitled to the payment annually of such a rate of interest on their subscriptions as shall be determined by the board of trustees, so long as said patronship, fellowship or life membership shall be in force.

II.

Any trustee who shall fail to attend two consecutive annual meetings shall cease to be a trustee, unless excused by the board.

III.

Any vacancies occurring in the membership of the several committees during the interval between the annual meetings of the board of trustees may be filled by the executive committee.

IV.

All bequests or legacies not especially designated, shall hereafter be applied to the permanent endowment fund, the interest only of which shall be applied to the use of the Institute, as the board shall direct.

After an exhaustive discussion, Mr. McLean moved that the matter be referred to the secretary for elaboration, that type-written copies be submitted to the members of the executive committee for their special consideration at a meeting of the committee to be called by the president. Carried.

The motion of Mr. McLean, the appointment of a statistical clerk, was postponed to the next meeting.

On motion, Mr. A. J. Bettis was appointed the committee on standard form for street railway accounts.

W. J. RICHARDSON, Secretary.

SPECIAL REPORTS.

The subjects for special reports covering, as they do, a wide range of electrical knowledge and investigation were at once assigned to committees. We anticipate a valuable acquisition to our fund of information concerning electricity, that will help us to a fuller knowledge and better operation of our business, by reason of a greater and more intimate knowledge of electricity in actual as well as its possible future development. The same difficulty as heretofore, in getting the reports in time to have advance copies prepared and distributed before the meeting, was experienced this year.

MILWAUKEE EXPOSITION.

The committee has made ample provision for the exhibition of street railway supplies. Not only is the

accommodation greater than ever before, thus obviating the crowding that has been experienced at former meetings, but as the convention is held under the same roof, delegates will have a much better opportunity and more time for the examination of the goods and inventions displayed. But for the World's Fair at Chicago, the exposition would have filled every available foot of space in the building.

INDUSTRIAL INSTITUTE.

This year has not been one in which to float new enterprises, and hence while the committee has had under consideration, more or less, the subject of the formation of an industrial institute, we believe the time has not yet arrived to do more than commend to all the serious consideration of this important question. We therefore request that the subject be continued with the committee for another year. In this connection, we might refer to the exposition in this building as suggesting in a small way what a permanent Exposition would be, only in the display of the manufactured articles for the street railway business.

STREET RAILWAY LAW.

Judicial decisions and opinions have been issued during the year and constitute parts of volumes IX and X, of Street Railway Law, as follows:

1892.

November—Hudson River Telephone Company against Watervliet Turnpike & Railroad Company.

December—Mary Cremer, Administratrix, vs. West End Street Railway Company.

1893.

January—Timothy Mahoney vs. Detroit City Railway Company.

February—Robert Winler vs. Federal Street & P. V. Passenger Railway Company.

March—Martin Seymour vs. Citizens' Railway Company.

April—George Smith vs. Reading City Passenger Railway Company.

May—Martha C. Holmes vs. Allegheny Traction Company.

June—City of Cincinnati vs. Cincinnati Street Railway Company.

July—William H. Owens vs. Peoples' Passenger Railway Company.

August—Harry Benson vs. Baltimore Traction Company.

September—William Liddicoat vs. North Birmingham Street Railway Company.

October—Ernest V. Appleby vs. St. Paul City Railway Company.

THE WORLD'S FAIR.

We may well feel proud of the display of street railway appliances that has been made at the World's Columbian Exposition at Chicago. We congratulate the inventors, manufacturers and all others who contributed to the suc-

cess of the street railway part of the Exposition, in both the Transportation and Electricity buildings.

The World's Columbian Exposition committee of this association did all it could to make the exhibition, in so far as our industry is concerned, a creditable one. Finally, we congratulate the Exposition authorities on their success in having given to the world, and especially to these United States, the greatest fair the world has ever seen.

REDUCED FARES.

The nearness of Milwaukee to Chicago has precluded us from obtaining any other than World's Fair rates, with the exception of those living in the territory of the Western Passenger Association. As this is the first time the courtesy of a fare and a third has been extended to this association, by the Western Passenger Association, we desire to return our thanks for the consideration and bespeak for future meetings the extension of a similar favor.

Respectfully submitted,

D. F. LONGSTREET.
W. J. RICHARDSON,
T. J. MINARY,
JOEL HUNT.
W. W. BEAN.

MILWAUKEE, Wis., October 18, 1893.

The report also including suitable and touching reference of the death, during the past year of officers of members companies.

These officials were:—James W. Hyatt, of Norwalk, O.; Geo. D. Capen, of St. Louis; Edward D. Denniston, of St. Louis.

SUMMARY OF TREASURER'S REPORT.

RECEIPTS.	
Balance.....	\$1,524 77
Annual Dues, 163 Companies.....	4,075 00
Admission Fees.....	200 00
Banquet Tickets, Eleventh Banquet.....	725 00
Space in Exposition Building.....	1,015 00
American Street Railway Decisions, 4 Vols.....	20 00
Return Insurance Premium.....	4 00
Loan.....	1,200 00
Total,	\$8,763 77
EXPENSES.	
Secretary and Treasurer's Salary.....	\$1,749 96
Eleventh Annual Banquet.....	1,500 00
Steel Engravings of Presidents.....	571 65
Expenses, Eleventh and Twelfth Annual Meetings.....	358 47
Executive Committee Meeting, Traveling Expenses.....	356 25
Preparation of Special Reports.....	300 00
Rent of Office.....	300 00
Exposition Expenses.....	308 70
Advance Reports.....	289 00
Postage.....	249 00
Office Furniture.....	235 94
Printing Street Railway Law.....	96 00
Miscellaneous Printing.....	73 75
Miscellaneous Expenses.....	71 76
On Account of Publishing Report.....	55 00
Royalty on American Street Railway Decisions.....	26 00
Total,	\$6,541 48
Balance in Bank,	2,222 29
Total,	\$8,763 77

REPORT OF THE COMMITTEE ON POWER HOUSE ENGINES.

TO THE AMERICAN STREET RAILWAY ASSOCIATION.

GENTLEMEN:—Your Committee on Power House Engines respectfully report:

The subject of power house engines for electric railways embraces one of the most important and interesting subjects that street railway companies have to consider in the equipment of a power plant.



E. G. CONNETTE.

The subject represents the vital part of a street railway; as the heart forces the life current through the arteries of the body, and an impairment, or weakness of this vital organ, will produce impaired health, so also is the power house engine the vital part of the street railway, as it produces the power that creates and forces the electric current through the arteries (the trolley wire) of the electric railway, and, like the heart, if the engine regulates badly, it produces a bad circulation of varied potential, which impairs the service of the road.

The variety of opinion as to the best kind of an engine for street railway power, makes the subject a difficult one on which to reach a conclusion that would not be criticised, and your committee will therefore endeavor to treat the subject impartially, and in such a manner as will result beneficially to the association. The most essential points to be considered are as follows:

- First: Perfect regulation.
- Second: Highest economy.
- Third: Greatest durability.
- Fourth: Division of power into units.

PERFECT REGULATION.

Good service and uniform speed of cars can only be maintained by a constant, unvarying potential, and in order to do this the engine must regulate practically perfect, so that there will be no variation of speed as the load varies. The varying power required on an electric railway is unquestionably considerable, caused by cars constantly stopping and starting, going up and down grade, rounding curves, using resistance in order to run slow through crowded streets (which necessarily increases the load) and in order to have perfect service and uniform speed of cars, the engine must be constructed so as to maintain a constant and uniform speed under any variation of load. This variation of load amounts to a very considerable fraction of the whole maximum load; in small plants it may reach 95 per cent of the maximum, and in large plants is frequently 50 per cent.

If the speed of the engine decreases when a heavy load comes on, the potential is reduced, which consequently reduces the speed of the cars, heats the car armatures, and creates an extra strain upon the machinery, which of course means an increase in the consumption of fuel, and in various other ways produces imperfect and expensive service. If the speed of the engine increases when the load diminishes, it consequently increases the voltage or potential, which is liable to result disastrously to the generators and car motors. Moreover, if the engine regulates badly, and the load diminishes suddenly, the engine is liable to "race," which is nearly always attended with more or less disastrous results.

The governor, or regulator, to be mechanically perfect should be made of the best material and workmanship, and should be so constructed as to control the engine under any variation of load, with a variation of speed not to exceed two per cent. An engine that will regulate within two per cent is practically perfect for street railway work, though there are engines on the market that, on electric railroad service, can be held to one per cent deviation from the mean speed. The governor should be constructed so as to be easy of access to all of its parts, and capable of being oiled while the engine is running. Particular attention should be given to the construction of the governor to see that there are no weak parts, and it should be so constructed as to make it the least intricate and complicated. The range of cut off must also be larger than in engines for less variable load. This cut off should be easily regulated between the limits of $\frac{1}{6}$ and $\frac{1}{7}$ of the stroke.

The severe conditions of high speed and sudden and extreme variations of load, make it especially important that the engine have the best possible construction, with extra weight in the fly wheel and bed plate, and that the foundation be more than usually substantial.

One of the most important features to be observed, in order to maintain perfect regulation, is to place the engine in the hands of a compe-

tent engineer, who is capable of adjusting and keeping the engine in good running order; a good engine or piece of machinery, placed in the hands of an incompetent person, will never give good service or economical results, and, no doubt, a large number of cases where engines do not give good service, the expense of maintenance high, and perhaps a large number of the frequent casualties, are attributable to incompetence, careless or negligent engineers.

HIGHEST ECONOMY.

The matter of economy has been exhaustively discussed from a scientific standpoint in the various periodicals, as well as before the learned societies, and your committee feel inadequate to the task of presenting a report that will not be a repetition of the records on the subject. The committee will, therefore, not undertake to deal with the subject in an elaborate and scientific manner, but will endeavor to give a few practical hints that will be of interest to the association.

The economy of an engine is dependent, to a great extent, on the other parts of the power plant, and it will therefore be proper to discuss the matter in all of its phases, even though it may be a slight digression from the subject proper, as economy is the most important factor in the operation of a power plant.

In order to obtain the highest economy in the operation of an engine, it is necessary to have the engine properly adjusted to its load. It is a fixed principle that the highest engine efficiency results in working the engine constantly, at its maximum rated capacity; underloading and overloading are each, therefore, undesirable, though the compound condensing engines of the largest stations will stand underloading better than the simple high speed engine, and both classes of engine will stand underloading better than overloading; there should then be ample power both in boilers and engines to obviate excessive overloading as well as to provide for contingent break downs or needed repairs. Whatever the style, or type of engine adopted, it should be kept scrupulously in the best possible working condition. The packing should be kept intact, valves free of leaks, cylinder perfectly smooth and true in diameter, so that there will be no loss of live steam. The cylinders and bearings should be kept well lubricated, and one of the most important factors is to have the steam enter the engine at a steady pressure at all times, as good service cannot be obtained when a steady steam pressure is not maintained. Careful attention should be given to the setting of the valves, so that the cut off will be the same at both ends of the cylinder. The engines should be set in the closest proximity to the boiler so as to require the least amount of steam pipe, as the longer the steam pipe the greater is the loss by condensation. The steam pipe should be covered with one of the best non-conducting materials, of which there are several on the market, so as to reduce to the minimum the loss by conduction, radiation and consequent condensation. Flexible joints should be used to prevent leaks at the joints from expansion and contraction. It should be born in mind that wherever there is a leak of steam there is a loss of dollars and cents.

We are so accustomed to consider the reciprocating engine as the only steam motor within our reach that it is not surprising that a new form of steam motor should have quietly been developed without our notice. The Committee refers to the steam turbine, one form of which, the Parson's steam turbine, has recently been subjected to vigorous and searching trials and tests by Prof. A. D. Kennedy, of London, England, who has developed power at the rate of 29½ pounds of water per electrical horse power per hour, in a turbine using steam at 97 pounds per square inch, and making 4,600 revolutions per minute, the turbine having a capacity of about 165 horse power. The small size of this motor, absence of reciprocal motion and consequent independence of heavy foundation, high speed of rotation, and consequent availability for gearing direct to generator; simplicity of construction and consequent low cost, and its very high efficiency as a motor, all tend to make this a strong rival to the reciprocating engine as a steam motor for electric power and light stations.

The next point to consider is the boiler room, where the steam is generated. Engines may be of the very best type, and, together with the steam pipe, may be in perfect condition, but unless the boiler room receives the proper attention, there will be dollars lost where cents are saved in the engine room. The design and proper construction of the boiler plant is quite essential to economy as is the case with the engine. The boiler plant should have ample capacity, as there are few cases when the draft and setting are so excellent as to allow heavy forcing without a serious loss of economy. A raising of the evaporation from 6½ to 7 pounds of water, per pound of coal, represents the saving of about 7 per cent. of the coal bill, which would warrant the incurrence of an expenditure for improvements equal to one whole year's coal bill.

The boilers should be equipped with good boiler cleaners, and should be inspected regularly and kept free of scale; the flues should be kept clean and boiler walls intact; with the boilers in proper condition, and with proper draft, the very best results should be obtained, but in order to do this the boiler room must be in charge of a competent man.

Fuel is one of the largest items of expense attached to a power house, and the waste of fuel by incompetent firemen is one of the greatest leaks attached to the operating expenses; it is a safe proposition to state that an incompetent fireman will waste enough fuel in a year to assist very materially in paying a dividend. Simply the act of pitching a shovel of coal does not qualify a man as a fireman, it requires skill and intelligence; there is a natural disposition among the laboring classes to endeavor to do their work with the least amount of labor, and, as a rule, the fireman will fill his furnace half full of coal at one time, give it a stir with a poker, and then sit down to rest until time to fill it up again instead of firing frequently, maintaining a light fire, and scattering each shovel of coal evenly over the grate bars, by which the maximum amount of heat can be obtained from the least amount of coal. A good plan to encourage economy on the part of the fireman is to pay him a coal premium at the end of each month, basing the amount of the premium paid on the average number of bushels of coal consumed each day during the month for a certain number of cars run. This plan was adopted by the chairman of this committee about two years ago, with very satisfactory results. The limit on the average number of bushels consumed per day, to secure the premium, was placed at a point that required skill and economy on the part of the fireman to keep within the limit. During the past two years they have succeeded in obtaining the premium about one half of the time.

Careful firing is a good smoke preventative. No matter if the draft is good, and the best quality of bituminous coal is used, unless the coal enters the fire box in the proper manner, there will be more or less black smoke issue from the stack, representing a lack of combustion and waste of fuel. Careful firing preserves the boiler and saves coal, gives a steady steam pressure, which secures an economical point of cut off and steam economy, from a proper expansion in the cylinder. When the plant is of such size as to require more than two firemen, it will always be good economy to employ mechanical stokers; aside from their saving in labor account, they economize fuel, insure uniformity of steaming, prevent the chilling and straining of crown sheets by intrushes of cold air through the fire doors, and prevent smoke, that is, if properly chosen, constructed and operated.

The use of oil as fuel in place of coal is a live question with power and light station engineers and managers. Actual trial of oil, keeping accurate records of costs and results, will be the only absolute answer to the important question: "Does it pay?" But as an oil installation is somewhat costly as an experiment, it is best to secure as full outside evidence as possible on the question as to its probable economy. Fortunately, several accurate comparisons have been made with sufficient care and accuracy to make them valuable witnesses. Probably the most complete evidence of this kind comes from a recent and exhaustive test of the power plant of the Twin City Rapid Transit Company, of Minneapolis and St. Paul, Minnesota, made by Messrs. Wm. A. Pike, of Minneapolis, and T. W. Hugo of Duluth, Wisconsin. On the comparative value of the two fuels, coal and oil, this test showed that with ordinary Lima oil, weighing 61½ pounds per gallon, and costing 2¼ cents per gallon, and coal that gave an evaporation of 7½ pounds of water per pound of coal, the two fuels were equally economical when the price of coal was \$3.85 per ton of 2,000 pounds. With the same coal at \$2 per ton, the coal was 37 per cent more economical, and with the coal at \$4.85 per ton, the coal was 20 per cent more expensive than the oil. These results include the difference in the cost of handling the coal, ashes and oil. The oil used gave the following as the result of five chemical analyses:

Hydrogen, 13.03 per cent.

Carbon, 82.38 per cent.

Evaporation, 20.63 pounds water from and at 212 Fahr per pound of oil.

The average steam plant is not run at anything like a minimum expense. So long as the cars keep running little attention is paid to the efficiency and economy of the power plant. The obvious and intelligent way to get the most work out of a steam plant at the least expenditure, is to ascertain first how the total expenditure chargeable to power per unit of production compares with other street railroads; of course, in making a comparison of this kind, the difference between the surrounding conditions of each plant should be considered. After making the comparison, if the plant is not running as economically as other plants, then such tests and investigations should be made as will ascertain separately the

conditions of the boilers and engines. To do this it will be necessary to furnish the station engineer with full facilities for testing and maintaining records of each part of the station plant and operation, it being presumed that only an engineer competent to carry out such tests and records will be placed in charge of the plant. The keeping of any other is an unnecessary evil. If you find the plant is deficient in any part do not adopt hap-hazard the first idea that suggests itself for its improvement, but study out the cause of the trouble. If the boilers are inefficient it may be because the rate of combustion is too high or too low for the amount of heating surface, a faulty setting, a poor heater, or none at all, a wasteful fireman, or any one or more of a dozen different causes; the engine may be of inefficient type, underloaded, overloaded, badly set or leaking. Find the trouble and then go systematically to work and remedy it. The standard of maximum efficiency attainable should be ascertained with each portion of the plant and each part brought up to that standard. With modern appliances and fairly well constructed plants a total station efficiency of 70 per cent should be set as the standard.

Constant vigilance over a power plant will result in a great saving of expenses. In connection with this matter it will not be amiss to quote a portion of an editorial from *Power*, one of the leading journals, on this subject:

"When a man is losing money and don't know it, it don't worry him," sentimentally remarks a practical engineer of our acquaintance. The statement carries its own demonstrations with it, but the peace of mind which it infers is often expensive to its possessor. The average steam plant is not run at anything like the maximum efficiency obtainable under its conditions of environment and use, the owner or manager does not know whether his plant is running above or below the average, and a vast amount of money is burned up in coal, which need not and should not be burned; and nobody worries because nobody knows it."

The loss of power between the engine and switch board terminals is from 15 to 25 per cent, which is attributable to the inefficiency of dynamos, and also to the friction of countershafts, belts, idlers and attachments, which are simply power consumers, representing a waste of power without any resultant benefit. Besides the loss of power, the expense of maintaining the various arrangements for the transmission of power is quite considerable. This waste of power can be overcome by connecting the generator direct to the shaft of the engine. While machinery of this class is more expensive than the other, because it demands a slow speed for the generator, necessarily increasing its size, the saving in power and maintenance of the machinery of transmission will be sufficient to compensate for the slightly reduced dynamo efficiency due to slower rotation, and will warrant the recommendation of the direct driven equipment for moderate or large sized plants. This direct coupling of engine and generator gives also an important advantage, particularly in the large stations in crowded cities, by the considerable saving in floor space.

The committee look with favor upon compound engines for street railway work, especially so with engines having ranges of cut off wide enough to keep the low pressure cylinders ever from expanding below atmosphere. When this is the case, there is no doubt that the compound engine is very economical, as it carries the expansion of steam to a greater limit. Where it is possible to condense in connection with the compound engine, there is not the slightest question as to economy. In fact where condensing is possible, there is no reason why the expansion should not be carried to a further limit.

Ordinary considerations of economy in labor account will dictate the use of labor saving appliances and methods about the boiler house and engine room; a feature frequently omitted, owing to a lack of appreciation of its value as a labor saving and a safety appliance, is a light overhead traveling crane, with differential pulley blocks for handling armatures, cylinder heads and other parts of machinery.

The practice occasionally followed of placing the generators in the second story of the power house, is not to be recommended, even where floor space is difficult to secure. The difficulty of securing for the dynamos rigid foundations, and the resulting evils of increased frictional losses and heating, will generally render this disposal of plant inferior to placing the dynamos on rigid ground foundations, even if the problem of floor room has to be settled by direct coupling of generators to the engine or the incurring of considerable outlay for additional ground room. The plan adopted at the power station of the West End Company in Boston, of sinking the countershaft into a basement pit, keeping the generators on the same floor with the engines, is worthy of consideration for extraordinary large plants, as securing rigidity of foundations, necessary belt lengths, economy of floor space, without going to direct gearing of generators to engines.

GREATEST DURABILITY.

When electric traction was first introduced for street railways, engine builders were not cognizant of the actual requirements for this kind of service; they did not anticipate fully the extraordinary variation of load and the liability of a short circuit, which so severely tests the strength of an engine. They proceeded to build engines from theoretical plans and specifications which have proved by actual practice to be entirely inadequate for this class of work. Engine builders, however, are endeavoring to overcome mistakes which were made at the outset by strengthening and making all the parts more durable and to make such improvements as will meet all the demands for this extraordinary class of work.

DIVISION OF POWER INTO UNITS.

When electricity was first introduced as a motive power for street railway transportation, the largest type of generators were small units as compared with those manufactured at the present time, and, as a rule, high speed engines, from 100 to 200-horse-power, belted direct to the generator, were in most cases adopted, without regard to the size of the plant. In some instances, Corliss engines were installed, and the dynamos connected to a countershaft. In nearly every installation mistakes of more or less proportion were made, not due, however, to the fault of the street railway people, but the lack of knowledge on the part of the manufacturer as to what was actually necessary to properly fulfill the requirements of the new field of traction. The pioneers of electric traction have, as a rule, suffered from these mistakes by the expense of changing to modern improved and more economical machinery, or have been financially compelled to jog along with their obsolete outfit and consequent large power house expense. Local surroundings and conditions will, to some extent, govern the division of power into units, but, as a rule, the following principle will be safe to follow: The size of the proper unit of subdivision should be such as to give the required relay or reserve above the maximum power adopted. This will apply equally to boilers, engines and dynamos. The following table will serve to show approximately the proper proportion:

Maximum H. P. Required to Operate Road.	Number of Engines Required.	H. P. of each Engine.
200	2	200
400	3	200
600	3	300
1,000	3	500
1,500	4	500
2,000	4	750

It will be observed from the above table that enough engines are provided to furnish the maximum horse power required to operate a road and have a surplus of one engine. This is very essential, as it enables the engineer to keep his engines in perfect adjustment and repair, having at all times an extra engine to work on, or, in case of a breakdown, the extra engine is ready to take the place of the disabled one. The "Maximum horse power required to operate the road," referred to in the table, is not to be taken as the sum of the power needed by each car in service, except in case of small installations, since the maximum power required does not increase in proportion to the number of cars in use, since the line losses are not materially increased with increased traffic, and because as the number of cars increases, the fluctuations of load tend to balance themselves and to reduce the maximum load nearer to the average load. Thus in a ten car plant, cases will occasionally occur when all of the cars will require their full power at the same time, and the power plant must be planned accordingly, but there is no probability that all of the cars of a one hundred car plant will all require their full power at the same time; from 60 to 75 per cent of this power, depending upon local conditions, will be sufficient for this plant.

CONCLUSION.

The committee sent a list of questions to a number of street railways for such information as would be of service to the committee in formulating an intelligent report, by securing an idea of the construction and equipment of the various power plants, and the result of their operation and experience with the various types of engines in service. Only a small number made a reply, from which the committee would infer that a number of roads are not giving the question of the expense of their power house much consideration.

From the replies that were received, the committee find quite a variety of types and kinds of engines in use by street railroads, and no uniformity of opinion as to the best and most economical engine for power house work. Question No. 30 on the list was, "What kind and style of engine would you recommend for railway power use? (base your opinion on

regulation, efficiency and economy)." In nearly every instance the kind and style of engine which the particular railway had in service, was always recommended as the best, showing that the observations and investigations as regards their power was restricted to their own power plant, and the result of its operation was accepted as perfectly satisfactory, perhaps, without making comparison with other plants, or making such tests and investigations as are necessary to ascertain if they were obtaining a standard of efficiency from their plant. The committee therefore feel at liberty to express their own convictions as to the best engine for power house work, based upon the investigations which they have made, and in line with the progress of the present time.

Prof. Thurston says, in his recent work on the steam engine, that the principles that must govern the engineer in his attempt to select the most efficient type of an engine are as follows:

(1) The greatest practical range of commercially economical expansive working of steam. The fluid must enter the cylinder at the highest admissible pressure, and must be expanded down to the minimum economical pressure at exhaust. (2) The wastes of heat must be made a minimum. All loss of heat by conduction and radiation from the engine must be prevented if possible, and the usually much more serious waste, which occurs within the engine, by transfer of heat from the steam side to the exhaust, by 'cylinder condensation' and re-evaporation, without doing its proportion of work, must be checked as completely as is practicable. This latter condition, as well as commercial considerations, limit the degree of expansions allowable. It also dictates high speed of engine. (3) The largest amount of work must be done by the engine that it can perform with due regard to the preceding conditions. This condition compels us to drive the engine up to the highest safe speed, and to adopt the highest practical mean steam pressure."

In selecting a type of engine, the size of the installation must largely govern, as well as local conditions, such as water supply and price of fuel, though some consideration may be given to opportunities for station room and arrangement. For small plants, to run ten or fifteen cars, simple high speed engines, belted direct to generators, are unquestionably the proper choice. For twenty to fifty car plants, compound engines, with condensing apparatus where it is possible; with tandem compound engines for the smaller plants and cross compound engines for the larger ones, geared direct to generator, will probably be found most economical. While for the larger systems compound or triple expansion condensing engines, using steam at a high initial pressure and either driving a countershaft or coupled direct to generator, whichever the conditions of the case will warrant, will be found a proper selection. In every case, except for small plants, where engines are belted direct to generator, the vertical type of engine is recommended.

In conclusion, the committee desire to impress the importance of keeping the steam plant as near as possible to the conditions that exist when the engines are installed and being run under the supervision of the mechanical engineer who installed the plant. This, perhaps, is of as much or more economic importance as the design of the engine, as the plant is then run by the expert in charge with a view to attain the highest degree of efficiency and economy.

The committee have endeavored to treat the subject impartially, but to give such important practical points in the construction and management of an engine as are necessary to give perfect satisfaction for power house work, and to add in connection such practical hints in relation to other parts of the power plant upon which engines are dependent as will be beneficial to the association.

Respectfully submitted,

E. G. CONNETTE,

Chairman of Committee.

The president declared the paper open for discussion.

Mr. Richardson: I think the convention would be interested in hearing some remarks from the author of the report.

Mr. Connette, of Nashville: Mr. Chairman and Gentlemen.—The subject of power house engines is one that requires a great deal of study and careful make up. The committee, of course, did not treat of any particular engine. You will find, however, that in closing the report the vertical type of engine is recommended; the compound condensing engine is recommended for large size plants. This is based on an endeavor to get the

greatest amount of work out of the steam. In the simple engine, when the influence of the cylinder is cut off, say at four-fifths of the stroke, or one-half, or one-quarter, there is a great deal of steam wasted and a great deal of pressure lost. Where you have the compound engines, as you all know, you have the additional use of the steam in the low pressure cylinder, and therefore expand your steam to nothing. When it leaves the cylinder it has expanded its force. The vertical type of engine, with generators geared direct to the shaft, I consider the best engine for power house work. The vertical type takes less floor space than the horizontal. In the horizontal type you are also liable to have trouble with the piston, in the vertical type this is not so liable. The vertical engine at the Intramural railway at the Fair is referred to. I think it is a 1,500-horse-power compound condensing engine. It has a Thomson-Houston 1,200-horse-power dynamo coupled direct to the shaft of the engine. I understand that this engine has never been shut down one hour for repairs to the engine proper. It has done its work day after day. It has hauled thirteen trains, of four cars, heavily loaded, constantly, all day; while the other engines, those of the horizontal type, have required repairs. The committee appointed to examine the engines, in order to award premiums, sat for twenty-three hours watching the engine work. It constantly pulled the whole load for twenty-three hours with possibly not over one per cent variation in the speed. The engine makes about 100 revolutions per minute, and it is said it did not vary one revolution when the load was increased from, say, fifty per cent to full load. Our road was one of the pioneers in the business and we have had a great deal of trouble with our power house, being equipped with a large number of small-sized engines.

The question of fuel, as we know, is one of the largest expenses attached to the plant; and I strive to keep the coal bill down. Where you have competent men in charge of your machinery, and intelligent firemen, there is no doubt about attaining the results. You do not want to allow any slipping back. The plant should be kept up to the efficiency attained at the start. An expert in charge of the installation will run the plant with the greatest efficiency, in order that his engines may be accepted, and you should endeavor to maintain that efficiency, or find the reason why you do not. The expert will state that he will put in an engine that will use two and one-half pounds of coal per horse power per hour; and if he does that, you will get good results. You should endeavor to keep your plant at that standard. If a boiler will evaporate eight pounds of water per horse power per hour, that efficiency should be maintained. If you find that it does not evaporate more than six pounds, something is wrong, and you are losing a great deal in coal.

Mr. Arnold, of Chicago: I am familiar with the engines at the Fair, and have made a number of tests this summer. I can corroborate what the speaker said in most respects. The vertical engine installed in the Intramural power station has, on the whole, done excel-

lent work, and has required very little repair; in fact, none to amount to anything. I wish, however, out of justice to the other types of engines, to say that they have done almost as well. You are aware that the horizontal engine in time wears its cylinder elliptical, by the passing of the piston through and through. One of the engines of that type gave some trouble, because it was operated continuously for six weeks at the opening of the Fair, and we had no chance to get inside and adjust the piston rings and bring the piston up to place. With that one exception, I know of no reason why the horizontal engines have not done as good work as the vertical in the Intramural station. I say this with due regard for the vertical engine. I believe in the vertical engine, because it occupies less floor space, and gives an engineer who designs a station a chance to make a better looking and more compact plant, and which will require a smaller real estate investment. The greatest drawback to the adoption of these engines is their first cost. If an engineer is given full power to propose what style of engine is to be used, he will in most cases suggest the vertical; but this is generally found to be too expensive, and he is compelled to go back to the horizontal.

We have been in the habit of installing engines having a rated capacity of from twenty to twenty-five per cent more power than the rated power of the generator. In my judgment, that is a mistake. The records of the operation of the intramural road this summer, and observations of other plants which I have built, proves to me that when the engine is of about the same rated capacity as the generator, or exactly of the same rated capacity, we get the best economy for the following reasons: An electric railway engine, as we have heretofore installed them, is normally an under loaded engine, for we have believed that we should have the large engine behind the generator in order to respond promptly to the overload which is liable to occur at any moment. This overload which occurs at intervals is supposed to be no greater than the rated capacity of the generator, and if it exceeds this capacity the circuit breaker opens and releases the entire machine of its load. As these overloads are intermittent and of short duration, we run our engines below their normal capacity the most of the time in order to be ready for the short excessive loads; and as these overloads are of short duration, I believe it to be better engineering to allow the engine to work uneconomically during these periods by allowing the steam to follow the pistons a longer time, even to full stroke if necessary, for a few revolutions, until the overload ceases, then dropping back to its normal point of cut off and operating at this point during the long intervals between overloads. If the generator is properly designed it is capable of standing a short overload of forty per cent, and by strengthening the frames and main working parts of the engine it will easily give fifty per cent more than its rated capacity, thus being able to stand the shocks of short circuits and overloads without damage. I have never seen an engine regulated within one per cent, on the extraordinary fluctuations of load that railway work gives, although there are many well

regulated engines on the market. In a test made in the Intramural station, the vertical engine with its direct coupled generators pulled a load of twelve trains of four cars each, and ran four hundred amperes of current into a water rheostat, developing as high as 1,700-horse-power for a long period of time. I would like to see the day when power stations will be kept up to the average of the first thirty days, when the expert is in charge. The greatest difficulty is in getting competent men for the wages usually paid by railway companies for this class of work.

Mr. Browning, of Camden: Are the engines and generators of the Intramural station worked to their full capacity, or do they work below it?

Mr. Arnold: I will give you the sizes of these engines. First, there is the large Allis compound engine, rated at 2,000-horse-power, coupled direct to a General Electric 1,500 K. W. generator. This engine has never been loaded to anywhere near its economical load, except on a test, where water rheostat was used. There is a 300-horse-power McIntosh & Seymour engine and direct coupled generators, for running lights on the battle ship and other small work. There is one 600-horse-power Allis engine and one 750-horse-power Green engine; and these two together operate the road. These are the tandem engines, one in either end of the building. The Green engine drove the road alone, operating six trains for the first six weeks without a hitch, on account of the other engines not being ready, owing to some of the parts of the plant not having arrived. The reason that the vertical engine was operated so long on the road, was that it was the unit in the station nearest adapted to the road. That vertical engine and generator operated the road for six weeks without any relay, because it took less fuel to run it. The other engines were ready to go, but it was not necessary to start them, owing to the engine doing its work satisfactorily and not requiring any repairs. I do not attribute that to the fact that the engine is the best for railway work, but to the fact that it is of exactly the rated size to fit this particular load.

Mr. Browning: You do not exactly answer the point I want to get at. Have you such an abundance of power that you never allow an engine to get up to its straining point? As soon as you find it is becoming overloaded, you put more power on; in other words, you have engines and generators with plenty of excess power to fall back on. In ordinary power houses we work our engines up to the full capacity, and a little over.

Mr. Arnold: We have now an excess of power; but for the first six weeks we had only one engine, which was much overworked during this time. The tandem engines work with economy and without straining when both are running on the road. The vertical engine, however, has been strained to an extraordinary degree. It pulled the road on the 4th of July and developed at times as high as 1,700-horse-power for several minutes at a time, although its average load was much less than this. The engine slowed down until the governor was on the shaft, but it hung to it, and pulled the road very satisfactorily.

Mr. Connette: I would like to know if Mr. Arnold has made a comparative test between the engines there as to their relative economy. I trust it is not an impudent question.

Mr. Arnold: I do not wish to say much on that subject, because we do not wish to do injustice to anyone. The tests were made at the request of the General Electric Company, and it would be a breach of courtesy on my part to give the results until authorized by them. I do not, however, see any difference in economy between the horizontal and the vertical engines if both were working under equal conditions.

Mr. Connette: What difference do you find between the Corliss and the high speed type?

Mr. Arnold: The difference is very slight. The vertical engine runs 100 revolutions; one of the Corliss runs 90, and the Green 100; all nearly the same speed. I am of the opinion that we will come to a speed of about 100 to 125 turns in all of our engines, and will stay there. I do not believe in an extremely high speed reciprocating engine.

WEDNESDAY AFTERNOON.

At 12.30 the first session adjourned and at once boarded the ten special cars in waiting, being joined by the ladies, who were brought from the hotels also in special cars, and all proceeded to the immense works of

THE ALLIS COMPANY.

The ride was a pleasant one, extending through the business district and across the river, passing the district where the great fire did its work a year ago, but now largely rebuilt. On arriving at the Allis works the party, numbering about 500, was lunched and then conducted through all the various departments of the establishment. One of the special features was the lifting of a 62 ton piece of machinery, consisting of a shaft, two gears and generator skeleton, and carrying this immense load the length of the shop, some 200 feet, and depositing it on a railroad car for shipment. The feat was successfully accomplished in three minutes, by the Shaw Electric Crane Company's travelling crane, which, though nominally of 50 tons capacity, experienced no difficulty in handling the 12 tons additional.

From here the party again embarked in Mr. Payne's commodious cars and were soon at the attractive new Kinnickinnick car house. As usual, it was in apple pie order, and the excellence of its arrangement and large window space was specially complimented. The display of home made products in the repair shop reflected great credit on the thorough and complete system in force there. An exhibition run was given with the line repair wagon, which is one of the most handsome vehicles of the kind in the country. Leaving the car house a quick run was made to the great breweries of the Pabst Company, the largest in the world. Here Fred Pabst in person, with ample number of assistants, conducted the highly interested visitors through all the processes which mark the transition from barley to beer, and the inviting and

refreshing beverage, which awaited the party at the finish, was specially acceptable from having seen how it was made. It was not until after five o'clock that the party found its way back to the hotels, where a short rest was possible before dinner.

WEDNESDAY EVENING SESSION.

Mr. O. T. Crosby being called upon to give his opinion of the relative conditions of the power required in generator and the engine, said:

The question is in regard to the proper proportion to be established between the rated capacity of dynamos and engines. I have used the term rated capacity, because I know that the discussion, as far as it has gone, was based upon proportions between rated capacity. As a matter of fact, what we want to get at, I fancy, is the ratio between the real capacity of engines and dynamos. We certainly, in the earlier years of our experience, were met with this difficulty, aside from the one which will always be open as a matter of engineering discussion, namely, that we do not have a correct and understood system of rating as between different makes of generators even, and certainly not between generators and engines. The ratings of electrical machines for railway use in the earlier days of the business were less conservative than they are to-day. There has been, however, a gradual approach to conservatism in this matter, so that to-day it is not far out of the way, in speaking of a 500-horse-power engine and a 500-horse-power dynamo, to feel that we are talking about pretty nearly the same thing. I mean that a 500-horse-power dynamo should be, and ordinarily is, a machine which can do 500-horse-power work steadfastly for twenty-four hours a day, without, either in its bearings or in its electrical parts, attaining such a temperature as will permanently injure them in any way, loosen its parts, or do any permanent injury.

I have believed for some time that the best practice is that an engine should be at least no greater in capacity than the dynamo to which it is attached. The engine will certainly not do its work as economically if it be run ordinarily at a considerably lower output than the output for which it has been calculated as a normal output. The dynamo does not suffer by any means so badly in thus being brought below its rated work. If, therefore, an engine of 600-horse-power be attached to a dynamo of 500-horse-power, the man running the station will ordinarily, and very properly, limit the load which is thrown on the couple, since they now constitute a couple, below the capacity, as he understands it, of the dynamo, rather than of the engine. He will endeavor to keep within safe limits with respect to his dynamo. In thus keeping within safe limits with respect to his dynamo he is keeping too far under the limit with respect to the engine for economical work. The dynamo is not what you should have unless it can be run at its rated load without any injury. If at the same time you are running the engine at about its rated load, you are getting perfectly satisfactory results in both cases as to repair, and the best results in

both cases as to the efficiency of output, and that is, probably, the largest question involved in the whole matter. I have had some conversation with engineers, both in the field in which I am interested and those in charge of power stations, and I find that this opinion is becoming quite well fixed—that the generator and engine should be at least equal, with some in favor of having an engine slightly lower in rated capacity than the dynamo. I am told by the representative of a large firm of engine makers in this city, that most of the complaints that they receive from their customers are due to the fact that they were running the engines lower than their proper load.

There is another point, as between vertical and horizontal engines. I do not think the matter, as far as it went this morning, was presented just as it seems to me it should have been. There is no difference in the machines, intrinsically, as to their value. You can make a splendid vertical engine, and you can make a splendid horizontal engine. No doubt some of my hearers will think me a "mugwump" on this question. It is impossible to speak on these subjects with as much definiteness and emphasis as many would like; but you can take a particular case and work it out to a greater degree of accuracy than you suppose. A vertical engine, as compared with a horizontal engine, involves a difference in the space occupied; and space represents money, investment; and there, in my opinion, is the meat of the whole question. There is enough experience in the engineering practice to justify us in feeling that vertical engines and horizontal engines are almost equal in value as driving power. Speaking for the electric side, it is a matter of indifference to the generator how it is driven. You want to consider in the most careful way the cost of all these elements in your plant—the engine complete, with all its appurtenances, and the space occupied and the economy of its operation. If you approach the question in the broadest way, I believe you may be inevitably led to the use of a vertical engine on real estate considerations, more than any other. I believe that the real estate consideration, the price per square foot of your building, is the determining element in large plants, as to which of the two types it is best to use. It is largely the same question which usually determines as between the condensing and the non-condensing engine. It still remains that the condensing process saves just so much coal, but may cost just so much extra investment. I heard it stated the other day by a competent engineer, that the condensing process, when coal is in the neighborhood of \$3 a ton, may justify an investment of \$100 per horse power to bring it about. The analogy between the cases of condensing and non-condensing engines, and between vertical and horizontal engines is very close. You can get an excellent plant either way.

We are all very much interested in the large direct coupled work which we see about us, certainly none more so than those who have built the plants. At the same time I would not want any one to feel that a belted station is not entirely a satisfactory plant. I believe heartily

it is. I believe in that case, as in others, you want to consider your original cost of all the elements. It is simple arithmetic in all these matters throughout. It is quite impossible, in my opinion, to make any generalization, and say, once for all, this is better, a direct coupled generator; or this is better, a vertical engine; or this is better, a condensing engine. It is all a matter of first cost and investment. These things will adjust themselves, and in one city you will have one type and in another city another type. You will put in the plant, that style of equipment which is directed by the particular conditions of the plant. That is the true generalization.

The location of the station is always an important matter, especially as to cost of conductors and the question of condensing engines. In the case of a man who is in a city with a river running through it, in such shape that he can put his station near it, he will be at once led to the condensing engine. The manner of placing the conductors is also important; there is a big difference in the case when you have to put your conductors underground, as compared with the result you will get by putting your conductors overhead. There is an element which is new to a number of engineers, connected with street railway problems, namely, that it costs so much per running foot to lay the conduit itself, independent of the amount of copper.

I do not know that there are any others than the points I have mentioned which are large elements that come into the matter, but if there is anything that I have not mentioned—and it may well be—I will just say in closing that everything which goes into your original investment account must be taken into consideration before you decide what is the most economical system of engine with respect to form, etc.

A letter was read from the West Germany Street Railway Association, sending greetings to the American Street Railway Association, and requesting an exchange of annual reports.

The next paper read was the Report of the Committee on Heating and Lighting of Street Railway Cars. The report was read as follows:

BEST METHOD OF LIGHTING AND HEATING STREET RAILWAY CARS.

TO THE AMERICAN STREET RAILWAY ASSOCIATION:

GENTLEMEN: At the request of your president, I beg to submit a report on the best method of heating and lighting street railway cars. The matter of heating and lighting street railway cars is to-day one of some moment, and to find just what is needed and best is a problem confronting all street railway men.

In this paper I intend to give the results of some investigations, and my experience of heating and lighting cars; to simplify the paper, I will take up heating and lighting separately.

Street car heating is to-day in an experimental state, and the numerous methods and devices testify to the endeavor on the part of street railway men and manufacturers to obtain a simple, portable, and cheap heater. To arrive at some conclusion as to the best method of heating cars, the first matter to consider is, what are the requirements. Each railway has an individuality, and what suits one will not meet the requirements of another. The many elements that enter into the solution of the problem of arriving at the best methods, gives considerable latitude to street railway managers for forming their conclusions.

Considering street railway car heaters in the manner in which the fuel is converted into heat, we can divide them into three classes:

First—Primary heaters, or those in which the heat is obtained from fuel consumed on the car.

Second—Secondary heaters, or those in which the heat is generated beyond the car, and transmitted to some storing medium.

Third—Electric heaters, or those of three conversions.

In cable railway practice we are limited to the first two heaters. In electric railway systems we have the choice of one of the three classes, therefore we must consider the means employed to propel the cars, the type of cars, the physical conditions of the railway, and the cost of various kinds of fuel. The elements of climate, distance and system are considered only secondary in this paper, as these have but little effect in the decision as to which is the best heater.

In addition to the foregoing it will be necessary to consider the mechanical features of heating. What is necessary for the heater is to have minimum weight, to occupy as little space as possible, to be operated without skilled labor, to be constructed of ordinary material, be easily and cheaply removed from car, and to be of such a character that it does not impose additional risks from fire. We will also have to consider the element of pleasing those for whom we heat the cars, and this last will to a certain degree govern the adoption of one form or another, provided the difference in operating cost is not too great.

First Method.—I have included in this class all stoves, oil burners, and hot air heaters. There are many devices on the market for accomplishing a method of heating directly from coal or other fuel burnt on the cars. These can be divided into three classes as follows:

Heaters fired from inside the car above the floor.

Heaters fired from inside of car under the floor.

Heaters fired from outside of car.

If we decide on a heater of either of these classes, we would suggest using the one that is complete in itself, which occupies as little room as practicable, one that can be fired and operated from the inside of car, and that uses Anthracite coal for fuel.

The plan of operating these heaters on street railways is to have one man to fifty cars, who will clean the stoves, build the fires, and fill the receptacles which carry the supply of coal. The conductor on each car will care for the firing while the car is in transit. Whenever the car equipped with one of these heaters is ready to go into the car station, it is well to have the fire dumped and the hot ashes removed, so that no risk from fire in the station will be incurred.

Good heaters of this description can be purchased at from \$15.00 to \$24.00 per car, and can be installed at a cost of about \$1.50 per car.

The cost of operating heaters of this description per car, per day of eighteen, hours is given in the following table:

Fuel, anthracite coal, at \$4.75 per ton.

Labor, at \$1.50 per day.

Maintenance, 25 per cent of the cost of stoves, this makes cost per car per day:

Fuel,	8.7 cents,
Maintenance,	3.8 cents,
Labor,	3 cents,

Or 15.5 cents per car per day, as an

actual cost of operating stoves.

Second Method.—In this class there are two types, one using steam, and the other water. In the first type, steam is used to heat earthenware cylinders or tubes, placed in iron pipes, and in the others, heated water is forced into radiating tubes in the cars. These iron tubes, or radiators, are placed along under the seats, with pipes leading through the floors to the outside, where some form of steam or water coupling is provided. At the charging station a rubber hose, connected either with steam boiler or with hot water supply, is equipped with some form of valve. When a car reaches this station, it is necessary that a man be in attendance to connect the discharge and supply pipes, to open and close the valves, as the conductor's time will be more or less occupied at the terminus of the trip in accounting for his work.

This requires time, and from experience on our road with the first mentioned type would say, that it can be accomplished on the average in about three minutes.

In the water system of storing heat, it is well to have the water impregnated with salt to prevent it freezing in winter.

To operate this system of heating it is necessary to have at least two men at the charging station, providing the generating station is located near at hand, so that one can fire the boiler and charge the cars; this, however, will hardly be possible unless it is on a small road. On a road operating, say fifty cars, it will require at least four men if all the cars pass through the charging and generating station.

The type of heaters is at present in an embryonic state and I cannot give reliable figures as to cost of operating.

Third Method.—Electric heaters: These are constructed of wire or other electrical conductors placed in and around a non-combustible material, and the heat is generated by raising the temperature of wire by current taken from the power station of the road. The amount of heat produced in these heaters is proportional to the amount of current used. These heaters, usually four in number, are placed under the seats of cars in such a manner as will protect passengers' clothes from contact with them. It is necessary to install them with some form of regulating switch, and the cost per car varies from \$35 to \$45 installed.

To keep the temperature of car, say at 50 degrees Fahrenheit in moderately cold weather will require an expenditure of 2.66 horse-power, and in severe weather an expenditure of from 5.33 horse-power to 6.66 horse-power.

Estimating power to cost nine-tenths of 1 cent per kilowatt hour, we can arrive at the cost of heating a car per day of 18 hours, as follows:

In moderately cold weather, using 2.66 horse-power or 36 kilowatt hours, the cost will be 32.4 cents; using 5.33 horse-power or 72 kilowatt hours, the cost will be 64.8 cents; using 6.66 horse-power or 90 kilowatt hours, cost will be 81 cents. To this cost must be added the depreciation and repairs, and this we can take at 20 cents. This will add to the above cost of operating 5.1 cents per day.

It may seem to some of you that this is an excessive cost for an electric heater, but from the standpoint of expense incurred by heating of cars it must be considered an increment to the expense as a whole of operating the road, the consumption of so much more additional electrical energy. This means a certain pro rata outlay of money. If the road be at all large it means the outlay of a considerable amount of money, in operating expense, which simply because it is expended in electric heaters, cannot nevertheless be overlooked, and the heaters therefore should be charged with their pro rata cost of the expense of the whole. Some of you may say it will cost no more in labor to operate the heater, and the only additional expense incurred would be in the cost of coal. Well and good, but this is viewing the matter rather laxly. If you choose to look at the matter of expense in this light you may, but you at the same time admit, there and then, that the general expense of operating the larger and more important parts of your road is so great that it overshadows the smaller expenses of the road, and they can be lost sight of—in this case, that of heating the cars. Can you do this? Not if you mean to make every particular portion of the outlay of electrical energy on your road bear its corresponding portion of expense. We cannot aid the consumption of so much more energy to our road without a corresponding outlay of expense, be it readily appreciated or not, be it realized or not.

Therefore, considering all elements that enter into the problem of heating cars, I would say that I consider the best method that of using a primary heater, one fired with anthracite coal and operated from inside of car, that is, the first method before mentioned.

The reasons which, to my way of thinking, substantiate this conclusion, are:

That while a street car is an enclosed space it cannot be considered as a room, or capable of being heated as easily. It is one open constantly or, at least at very short intervals, to the weather, therefore a heater which can rapidly counteract any inflow of air is much more appreciated by the passenger than a method of heating which does not, or does not seem to give out the heat so rapidly. There is a certain attraction in the burning of coal which gives a quiet sense of satisfaction to the passenger. He certainly always feels grateful to enter a street car with a good warm stove in it. This method seems to suit better all temperaments and temperatures. It is a method easily understood by employes, simple in operation and maintenance, economical and efficient.

Taking up the second feature of this paper, that of lighting cars, I would say there are to day three feasible methods of lighting street railway cars.

First—Oil lamps.

Second—The electric system.

Third—The gas system.

The first method of lighting, I think, is thoroughly understood by street railway men, and I need only mention it here.

Second Method—Electric systems of lighting are those employed by the various street railway companies on their cars, and are on the whole very much duplicates of the first street car, wired with incandescent light.

However, I will describe a few changes I have made with considerable success and saving; in the first place, no oil lamps or oil headlights are used; in place of oil lights, I have placed an incandescent light in

each lamp box at the ends of the car, so that the colored signal light may be distinguished readily; also to illuminate the advertising rack over the windows. On the ceiling of car are two more incandescent lamps, located about four feet from each end; by having a divided circuit the fifth light to make up the circuit is used in headlights on the hoods of car. The result is, we use a minimum number of incandescent lights in a car, obtain the best lighting effect, remove the annoyance of oil headlights and the labor attending their use; at the same time it facilitates changing ends of car at a terminus. The cost of lighting by this method need not exceed one half a cent per hour, or four cents per car per day, estimating that a car will burn its lights eight hours on the average.

The third method, that of using gas, is to-day the most successful and agreeable method of lighting steam railways, and has been adopted by some of the cable railways; I cannot speak from experience on this manner of lighting, but would say it should cost no more to operate than by using oil lamps, the greatest difference being the interest on cost of equipping cars, and installing the plant at car station which supplies gas under pressure to the car.

The need of good light in cars is a question of considerable importance, not only to assist employes to better attend to the wants of passengers and their duties, but to make the cars prominent on the streets, and thus attract traffic, and to some extent enable the better lighted road to be operated with fewer accidents.

In conclusion, I would say that it is the opinion of your committee that the best system of heating and lighting street railway cars is:

For heating—The use of a primary heater, or stove.

For lighting—The use of such lights as can be secured in connection with the application of electricity as a motive power, or reliable gas system, for example, the Pintsch, on cable railways. This last, provided it can be operated economically.

Respectfully submitted,

G. F. GREENWOOD, Committee.

The report was received and ordered to be placed on the minutes.

The report of the Committee on Standards was called for. Mr. O. T. Crosby, chairman of the committee, reported that no written report had been prepared; that the committee regretted not having a report ready, but it was unavoidable.

On motion, the committee was continued another year.

"CAN THE T RAIL BE SATISFACTORILY USED IN PAVED STREETS?"

Was the subject of a paper to be read by C. Densmore Wyman, and the applause went round the room as his name was mentioned. This immediately changed to

regret when the secretary read a characteristic letter in Mr. Wyman's well-known, graceful style, explaining that the committee had done a large amount of preliminary work, but that, owing to the extreme demands upon his time as general manager of the Electric Launch Company at the World's Fair, it was impossible to complete the work and make the report.



C. D. WYMAN.

Mr. Wyman was greatly missed, but expects to be with the association next year.

It was then suggested that the subject be open to discussion, and several gentlemen took part in a series of questions and answers. It was participated in by Joel Hurt, of Atlanta; Mr. Hendrie, of Detroit; Mr. Burke, of Terre Haute; Mr. Armstrong, of Camden; Mr. Carr, of Roanoke, A. W. Wright, Chicago, and others. The

discussion occupied an hour, but was largely of a desultory nature, and altogether failed to introduce anything additional to what was reported at last meeting. The same ground was gone over with the same results.

SPECIAL PAPER ON "TRACTION AND STREET RAILWAY TRUCKS."

As street cars upon the thoroughfares of nearly all of the large cities in this country are rapidly being equipped with means for self-propulsion, becoming in fact locomotives of sufficient power to successfully handle, in addition to themselves, other cars as trailers; and, furthermore, inasmuch as these cars and trains are mobilized upon street surface tracks and subject to the peculiar conditions thereby entailed, data, tests or deductions throwing light upon the subject of traction in general, and especially under the conditions of street service, are considered timely and important. The installation of a motor upon a street railway or other track is really for the sole purpose of utilizing the tractive or adhesive effect of the wheel upon the rail. The writer has for some years made a special study of traction, having had opportunities for observation and test upon steam and electric surface roads and also under the peculiar and very severe conditions of mine haulage traction, which latter has proved a fruitful source of information.

In the popular mind the laws governing traction or adhesion are entirely divorced from those governing friction. This view is not correct. The adhesion between the wheel and rail is really friction of quiescence. In studying the laws governing both friction of quiescence and friction of motion one is struck with a peculiarity in the curves, notably so when metallic substances are undergoing examination. The characteristic relates especially to a remarkable drop consisting in the member constituting practically a vertical line between the readings taken before and after slipping commences between the metallic substances under test. The curve shown in Fig 1 is taken as between a rail and wheel supporting about 3,200 lbs. The most cursory examination of the curve will at once show that the characteristic is by no means one of gradual or proportionate transition from a state of quiescence to that of motion, but, on the contrary, a breaking away with a wonderful suddenness of drop from high values to those which are very low.

Without recounting other experiments which have forced me to the following deduction, I will state that, in my opinion, what we know as friction of quiescence or adhesion between a wheel and a rail consists essentially of molecular gearing, the teeth of which, though minute, are as positively in mesh as those of the regularly organized gear. Whether they be in fact the molecules of the chemist is a question, but they are certainly the interlocking of the minute irregularities of the substances. These I have found to be maximum when the substances are alike, under these conditions the aforementioned molecules or irregularities probably being very similar as to dimensions. By this statement is not meant that the highest values are necessarily attained under conditions of like materials, but that the lines connecting the higher and lower values are more nearly vertical, arguing more complete intermeshing, hence in shearing a more sudden giving away of the molecular teeth at the time of dropping from the high to the lower values or co-efficients. The curve in question is drawn to scale, and graphically portrays the extremely low values in terms of traction or drawbar pull, upon the dynamometer of the slipping wheel, as compared with the wheel rolling upon the track without slip. This curve was obtained in determining by trial the grade at which forwardly revolving slipping wheels would just balance the tendency of the weighted car to slide down the grade. Space does not permit multiplying the data and curves, all of which prove the importance of preventing the slipping of traction wheels. The insight afforded by these curves leads to revelations which are at first startling to the investigator, and in the judgment of the writer the present investigation should be followed by others in this most important field. The curve shows the instant of starting to slip to be the critical point, and the problem is pre-eminently one of preventing the wheels in question from starting to slip.

How can this be best accomplished?

The writer has made a number of tests which may be of interest in this connection, and which show that there is a possibility of improvement upon methods which we at present accept as standard. The oldest method of accomplishing this purpose has been to couple all the drivers for absolute harmony and uniformity of movement, so that the tendency to slip of one driver will be held back by all the others instead of by its mate only. The question being, do we find in practice the

coupling of the wheels in this way to accomplish the desired result? Does it in any way increase the traction?

Experiments have been made to determine this question, including a bi-axled equipment of the ordinary kind with an independent motor for each axle, and also equipment consisting of four, six, and as high as eight separate drivers locked together and compelled to revolve in unison, being supplied with a single motor or source of power. I have found the method employed in coupling the wheels to seriously affect the traction appearing as drawbar pull. For instance, if locomotive connecting rods are used, the necessary flexibility of truck as to parallelism of axles must be either entirely sacrificed, or if allowed to exist it produces a continually and constantly recurring tendency to slip, resulting in a change from compression to extension of all the strains in both the truck and connecting rods. This change occurs twice in each revolution of the system, and results in a slip alternately of the wheels upon each side in amount dependent upon the lost motion existing. I have seen experiments where this periodic slip amounted to as much as five-sixteenths of an inch, occurring twice each revolution, when working upon a grade without trailer.

This is avoided by steam locomotive engineers by holding the axles in absolute parallelism in plane normal to the roadbed, and until within the last few months English locomotive builders have maintained that the parallelism of driver axles should be absolute, that is, parallel to every plane.

As to the street car truck, the flexibility necessary argues the employment of belting or rope transmission, which easily and naturally permits of such flexibility. I am free to say that no one who has not tried this experiment can form an adequate conception of the tremendous strains which motor gearing is called upon at times to withstand. I have seen as high as fourteen parallel laps of rawhide rope under very heavy tension in forty-five degree grooves slip and burn in their efforts to do work under conditions where gears are ordinarily employed, the gearing doing its work with perfect ease. No form of friction drive or friction gearing is admissible for this work. The chain drive was the first to be employed in this country, but was early abandoned on account of noise, excessive wear and journal strains, together with the impossibility of keeping it anything like adequately lubricated.

As to gearing between the axles, the bevel gear presents by far the simplest solution. This form of gearing, however, has been looked upon as wasteful of the power transmitted. This criticism is probably just in some power transmissions employing this gearing. The question is, How much more power does a bevel gear and pinion absorb than a spur gear and pinion in transmitting the same amount of power, with the conditions identical? There seems to be almost no scientific or carefully made tests of merit as to the comparative losses in transmission of power by these two classes of gears. Fig. 2 shows a diagrammatic view of an apparatus designed by the writer for testing this feature, with which an exhaustive series of tests covering this point has been made. B is a car axle mounted in journals, D D. E is a hydraulic dynamometer, with lever arm, E, and weight, F. A is an electric motor delivering its power to a pinion co-operating with a gear mounted upon the car axle, B, C being a flexible connection as between the motor and the pinion shaft. The car axle was three and three-eighths inches in diameter, and two sets of gearing were employed as between the axle and the motor. First, the bevel gear and pinion (shown in the diagram) inclosed in an oil housing, G, which were alternated with the test of spur gear and pinion also mounted within an oil housing, when the spur gear was used, the motor being set around at right angles to its position as shown in the diagram, and parallel with the axle, B, and connected with the shaft of the spur pinion. The spur gears were four and a half inches face, cut in steel, finished on an Eberhardt machine with Brown & Sharp cutters, running in an oil-tight casing in which three quarters of a gallon of oil was placed. They were accurately placed on pitch line, and running very easily and smoothly. The bevel gears used were turned out by the Walker Manufacturing Company, the test in question being used to ascertain the best shape of teeth for the work. The bevel gear was five and a quarter inches face, the teeth were uncut, and of course pitch cast very smooth and double shrouded, the pinion being cast steel, uncut, and five inches face. The bevel gears and oil housing are illustrated in Fig. 3. It will readily be seen that the conditions under which these tests were made were as nearly alike as it was possible to make them, and at the same time the transmissions were worked under the same conditions that obtain when mounted on a street car truck. Numerous curves were plotted, showing the total losses from the electrical terminals of the motor to the dynamometer, showing gear losses, losses resulting from shoulder and journal strains produced by the gearing, and all the bearings in each test through the entire range from starting to

about sixty-horse power input. Submitted herewith, in Figs. 4 to 9 inclusive, are curves showing that under practical working conditions when the bevel gear is properly made, the losses are almost identical with spur gear; the small difference, viz: 1.74 per cent, in favor of the cut gear, probably being due to the fact that the surfaces were somewhat rougher in the cast as compared with the cut gear. The great care exercised in these tests, and the clearness of the results certainly speak volumes in favor of the bevel gear transmission, and constitute the first comparative tests of large transmissions under heavy strains which, to the knowledge of the writer have been made.

Another feature bearing directly upon the all important question of traction is that of axially mounted masses. Locomotive drivers and axles are as light in and of themselves as is consistent with required strength. The inertia of a large mass axially mounted does not allow the drivers to follow the surface irregularities of the track with anything like equal pressure, especially at high velocities. The wear and tear of roadbed is also due in large measure to the heavy masses attached directly to the axle. All weights of magnitude should be spring supported. In this connection it has not before been pointed out that it is largely immaterial whether the axle is compelled to carry much or little of the weight of the mass so long as such mass is solidly and unyieldingly attached thereto, inasmuch as the axle is compelled to follow the laws of falling bodies controlled by the weight and inertia of the mass as a whole.

Referring now to the tests, a grade was built consisting of forty-five pound T rails rising from a spur of level track, giving a mean grade of the two rails of 12.4 per cent. Upon this grade was run, first, a double motor equipment weighing 17,935 lbs. A dynamometer was attached to the drawbar and back to the track in such a line as not to either lift the car or drag the rear end downward in the test. Current was then applied through a variable resistance, gradually allowing the car to strain upon the dynamometer until finally the wheels slipped. Care was especially exercised on the point of gradual application of the strain so as to eliminate all elements of inertia or lunging forward upon the dynamometer; after slipping had commenced it was observed that the car would slide in each instance to the bottom of the grade. The following table gives the mean of four sets of readings:

INDEPENDENT AXLE, TWO MOTOR EQUIPMENT.

Drawbar pull on dynamometer. Car standing on 12.44 % grade.
Weight of equipment, 17,935 lbs.

Group of Tests.	Average Amperes.	Average Drawbar Pull.	Ratio Drawbar Pull to Weight.
1	1,625	200 lbs.	9 per cent.
2	2,250	280 lbs.	12.5 per cent.
3	2,150	240 lbs.	12 per cent.
4	2,075	230 lbs.	11 per cent.

This car was run off the grade and replaced with one in which all the wheels were compelled to revolve in unison, but of much lighter weight, viz: 12,685 lbs. The dynamometer was attached in the same way and the same rheostat and source of current was used as in the previous experiment, the axles in this equipment being coupled by the bevel gears shown and described in connection with the gear tests above referred to. The following table gives the means of five sets of readings taken from this car:

COUPLED AXLES, SINGLE MOTOR EQUIPMENT.

Drawbar pull on dynamometer. Car standing upon 12.44 % grade.
Weight of equipment, 12,685 lbs.

Group of Tests.	Average Amperes.	Average Drawbar Pull.	Ratio Drawbar Pull to Weight.
1	200	3,125 lbs.	24 per cent.
2	240	3,750 lbs.	30 per cent.
3	230	4,075 lbs.	32 per cent.
4	220	4,500 lbs.	35 per cent.
5	200	4,375 lbs.	34.4 per cent.

The same operator applied current to the car in both tests, and every condition of electrical pressure, track and water, remained identical

throughout. The accompanying photograph shows the car standing on the grade with dynamometer attached.

The car was then run off the track and the rails blocked, as is shown in Fig. 10, one rail being 12.2 inches rise in 10 feet, the other being 17.2 inches, making a mean of 14.92 inches rise in 10 feet, equaling a grade of 12.44 per cent, giving a warp of considerable magnitude to the road bed. The reason for this may be explained in a word, as follows: It has long been known that the successful railway truck must provide for great flexibility and lost motion in almost every plane. The axles must be afforded independence and freedom of movement endwise in a horizontal plane and also in a vertical plane. They must be able to divide the load almost equally upon any reasonable irregularity of track. The axle flow in a horizontal plane must be universal for the purpose of taking short radius curves with ease and certainty, and without strain to truck or roadbed. The problem has been to fulfil these conditions and still preserve absolute alignment of gears which are used in part as coupling for the axles, leaving the truck parts, in fact, just as free to take up any of their erratic positions as in the double motor equipment. The warping of the roadbed shown in Fig. 10 would at once develop any rigidity introduced into the truck by the coupling and show up materially in the ratio of drawbar pull to the current absorbed if the equipment or any part was bound, unduly strained, or working under any but perfectly normal conditions. The following table shows the readings taken and is conclusive as to the perfect freedom of the truck while working in this warped and highly distorted position.

COUPLED AXLES, SINGLE MOTOR EQUIPMENT.

Drawbar pull on dynamometer. Car standing upon warped track;
 Right rail 14.33 per cent. grade.
 Left rail 10.58 per cent. grade.
 Weight of equipment, 12 685 lbs.

Group of Tests.	Average Amperes.	Average Drawbar Pull.
1	230	4,425 lbs.
2	220	4,375 lbs.
3	200	4,150 lbs.
4	220	4,275 lbs.

It will be readily understood that when an equipment is working upon a grade, the center of gravity of the car falls more nearly over the rear wheels, allowing the front pair to slip when independently driven. After slipping commences the tractive value of the front motor becomes almost nil, as shown by the traction curve in Fig. 1, the work being undertaken almost entirely by the rear motor. Whereas with coupled drivers, and especially where a single large capacity motor is used, the additional weight upon the rear wheels gives additional tractive power to these wheels, and the motor is compelled to deliver all its power to this pair if the exigency requires. At the same time the front wheels, instead of slipping, are compelled to revolve in step with the back wheels and bite the rail in unison therewith, and in fact all the wheels are held down to the business of effective non-slipping adhesion, this being true in whichever way the car approaches the hill, and whichever pair of wheels are respectively forward and rear. This great difference in favor of coupled drivers shows a percentage of 35 as compared with 12.5 of the total weight appearing as actual pull at the drawbar under the conditions named. While working upon a level, and especially in damp weather with a slimy rail, almost the same advantage in traction will be found to exist as is here given for coupled wheels, provided always the mechanism used in coupling does not interfere in the least with the flexibility of the truck.

ELMER H. SPERRY.

NOMINATING COMMITTEE.

The president then announced the nominating committee as follows:—

A. E. Lang, Toledo; W. W. Bean, Benton Harbor, Mich.; G. W. Baumhoff, St. Louis; J. E. Rugg, Pittsburg; W. J. Stephenson, Washington; E. Lusher, Montreal; L. Perrine, Trenton, N. J.

The meeting then adjourned to inspect the exhibits.

THE AFTERNOON SESSION

was opened with the conclusion of Mr. Malliou's paper, that gentleman having arrived with balance of manuscript. The paper is as follows:—

THE USE OF STORAGE BATTERIES IN ELECTRIC GENERATING STATIONS FOR UTILIZING AND REGULATING POWER.

The diffidence with which I entered upon the task of preparing a report on the above subject for the Association is sufficiently proven by the fact that I made a couple of unsuccessful attempts to decline the honor. My excuses and objections, however, availed me little with Mr. Longstreet, your honored chairman, who soon had me enlisted. He doubtless did not realize at the time, and I myself did not realize till some time afterward, what a difficult task he had allotted me; and when I state, with full conviction, as the result of my investigation, that probably no American engineer is competent to do this subject full justice, unless he has been able to study it for several months in Europe, where alone the material for its study exists to any extent, Mr. Longstreet may agree with me that he should have selected for this report some European member of the Association, if any there be.

From its title, the present report may be construed to have for its object to discuss the question whether storage batteries are capable, and to what extent, of rendering practical service in electric generating stations, more especially those used for railway traction; and to bring before the Association any facts or data relating to this application of storage batteries that may be of possible utility or assistance to tramway managers or engineers who have already, or may have later, in consideration the said application as an adjunct to a generating plant.

The question is not without some importance at the present time, when power stations are multiplying and growing so fast as in this country, because this question is one that has an important bearing on the design of the station; since, if this use of storage batteries is really feasible and practicable, in the full commercial sense, its utilization with a view to securing the full measure of its benefits and advantages would, in many cases, involve somewhat radical changes in the arrangement of the power station, and possibly even in the details of its operation. In Europe the use of storage batteries in central stations has unquestionably made great progress during the last three years, and has actually succeeded in commanding the respect, if not in entirely overcoming the skepticism, of electrical engineers generally. The irregularities of load, on power circuits, especially for electric traction purposes, are the bane of the electric railway engineer; and they are too well known and understood to require further mention now, except to classify them; for, in reality there are two kinds which must be carefully distinguished from each other, almost as if they constituted distinct diseases, so to speak, requiring different treatment, even though they may appear together in the same case. We must, therefore, distinguish between "variations" and "fluctuations" of load. I would use the term variation to designate the effect caused on the station plant by putting on or taking off a certain number of cars; and the term fluctuation, to designate those incessant and erratic ebbs and flows of current which are so familiar to us all, due to the starting and stopping of cars, changes of speed, grades, etc. The variations of load are defined as changes in mean or average rate of production for a given period of time; the fluctuations of load are defined as changes in rate of production from one instant to another. The distinction between the two will be more readily understood by reference to the accompanying load diagrams.

Figures 1 and 2 show load diagrams from the Minneapolis Street Railway Company's station, which I have reproduced from the Transactions of the American Institute of Electrical Engineers, my reason for selecting them, in preference to others, being the care and precision of methods followed in preparing them by the authors.*

Figure 3 shows a load diagram reproduced from a paper on "Electric Railroad Construction and operation," by C. J. Field.†

These figures can be compared with figures 4 and 5, which show load diagrams of an incandescent lighting station.

Taking the lighting station diagram in figure 5, which more nearly

*Electric Railway Motor Tests, by Prof. Geo. D. Shepardson and Edw. P. Burch, Transactions of the American Institute of Electrical Engineers, Volume IX, p. 570. (1892.)

†Read before the National Electric Light Association, Montreal meeting, September, 1891.

USE IN LIGHTING STATIONS.

represents the usual condition of affairs in lighting stations, it is seen that the momentary irregularities (or fluctuations) are trivial in comparison with the changes (variations) of load from hour to hour, or from one part of the day to another. In the railway plant load-diagram we observe a series of ups and downs following each other more or less irregularly every few minutes along the whole day. These seem like fluctuations as compared with the irregularities in figure 5. Yet if we go into details and magnify (see figure 2) the diagram by plotting the readings for every few seconds, instead of minutes, for the whole load, and also for some of the feeders separately, we readily see that the irregularities in figure 1 are variations by comparison with those in figure 2. However, the term fluctuation should, in my opinion, include both the "waves" and the "subwaves," while the term variation should be restricted to the "billows." It is proper to note that the waves and subwaves above mentioned are relatively more numerous and marked in smaller than in larger railway power plants. The greater the number of motors supplied from a given source the less likelihood is there of the load being thrown on or off in such large proportions. The load then "averages itself," to use a current expression. Thus in figure 1, where the number of motor cars represented is large, about 140, the load from 7 a. m. to 9 p. m. oscillates most of the time between 1,000 and 1,400 horse power, or 20 per cent above and 15 per cent below 1,170, which is the mean power rate for the whole day's run, excepting about 6 p. m., where a "wave" begins, lasting a couple of hours, during which the load reaches higher points, in some cases up to 1,750 horse power, or about 50 per cent more than the mean power for the three days' run.

In figure 3, where the number of cars was less than fifteen, the load ranged at different times between 80 horse power, or about 50 per cent below, to 350 horse power, or over 200 per cent above the mean load (about 170 horse power). The cases are numerous where the load falls down to zero, or runs up to two or three times the average load, in the course of a few minutes. These fluctuations cost the railway companies money in three ways. First, because they involve the use of generating machinery of greater capacity than would be required if the machinery were operated at a constant uniform load; second, because the depreciation is greater; third, because the efficiency of the machinery is lower. The first two points are well understood. The third requires a slight analysis. The use of engines and dynamos greater than would be required for the mean load increases the percentage of energy spent in the engine and dynamo to overcome friction and also to energize the field magnets, as the friction load and magnetizing energy (neglecting hysteresis and Foucault currents) must of necessity increase with the size of engine and dynamo. By courtesy of Mr. W. S. Barstow, superintendent of the Brooklyn (N. Y.) Edison Illuminating Company, I am enabled to publish (figure 6) two curves (A. B.) showing the percentage of the total indicated horse power which can be obtained at the dynamo brushes under different loads. Curve A shows the performance of a vertical engine direct connected to a pair of multipolar (100 kilowatt) dynamos; while curve B shows the performance of a high speed engine belted to two (70 kilowatt) generators, both engines being compound and tested as nearly as possible under identical conditions. These curves show that by the time the load has fallen 40 per cent the efficiency drops very rapidly.

Now, considering a little more closely the engine itself, several authorities have called attention to the extreme variations in steam consumption per indicated horse power hour at various percentages of load, which is the real measure of the engine proper. Cases are not rare where the use of engines too large, but rendered necessary owing to the severe fluctuations to be compassed, have consumed from 10 to 15 per cent more steam than they would at normal constant load. The total loss, of course, includes the loss in the engine cylinder as well as that due to mere friction. If the steam consumption is, say, 20 per cent greater than it should be per average indicated horse power, and if the engine and dynamo utilize 15 per cent less of the indicated power than they would if of more suitable size and running under better conditions, the next efficiency will be the product of these two factors; or we might say, in that case, that only about seven-tenths of the steam is utilized. This means that if the same steam could be properly utilized it would do some 40 per cent more work.

It is for the purpose of better utilizing and economizing this power that the storage battery is proposed to be used, by taking advantage of its property of being able to "give and take" energy, and thus keep the load balanced and equalized at all times. The principle of its action is that it can be made to absorb energy from the circuit (or the dynamos) or give it back in any desired amount, so that absolute control may be had of the total load imposed on the generating machinery independently of the rate at which the energy is consumed.

The use which has already been made of the storage battery for regulating the load in the central stations for electric lighting service is quite extended. It is thought that a brief reference to some of them will be of interest and utility.

By courtesy of Mr. R. R. Bowker, vice-president and manager of the Edison Illuminating Company, of New York, and with the kind assistance of Mr. William L. Pakenham, of the Crompton-Howell Electric Storage Company, Limited (of London), your committee is enabled to reproduce two interesting curves, showing the performance of a Crompton-Howell storage battery (140 cells, 51 plate elements) which is in use at the Edison Illuminating Company's Fifty-third street station. This case is detailed first—although it might properly come last—because these very curves will serve to make the function of the storage battery more evident and intelligible. Some explanations should be made regarding the conditions of the case. This Fifty-third street station is one of the supplemental provisional stations, as it were, that the company has built in various parts of the city to help its larger stations (Thirty-ninth street, etc.), in supplying the rapidly increasing demand for current. These stations, at first comparatively small in capacity, gradually develop, and eventually become large stations, when the patronage justifies. Their chief function is to relieve the other stations at the hours of heavy load, by delivering into the mains a certain amount of current that would otherwise have to come, and at greater loss or "drop," from one or another of the stations connecting with the network of mains. Hence the load may be varied more or less arbitrarily, at these stations, according to the proportion of load that the larger stations are desired or able to carry. Telephonic or telegraphic connection serves to keep the various stations informed of the conditions at the others.

The storage battery, like the station itself, was installed provisionally and by way of experiment, as it were, without paying very strict attention to the size, capacity or other conditions necessary to obtain the best results.

The battery is installed on the second floor above the engine and dynamo room, and consists of 140 cells, each of about 1,000 ampere hour capacity, weighing some 750 pounds, and of about 48 inches in length, 21 inches in width and 15 inches in depth.

The battery has a normal discharge rate of about 200 amperes, but can be discharged, if necessary, at 500 amperes. The two curves show different applications of the battery. The first curve (Figure 4) shows the station record for April 22, 1893. The station was then running only twelve hours per day, or from noon to midnight. The total load of all the stations, being light in the afternoon, the larger stations could easily take care of it; hence, the only station load from 12 to 5:45 p. m. was that required to produce only the charging current for the batteries. The plant was running at perfectly constant load, as shown by the straight line, a b. The lightly shaded area below this line represents the current (ampere hours) put into the battery. By 6 p. m. both the station machinery and the battery were delivering current into the mains. The curve, b d e f g, shows the total current. The curve, c h j k g, shows the amount delivered by the dynamos direct; the rest, or the difference represented by the relative heights of the two curves at any two points, (say h and d) was supplied from the battery. The heavily shaded area between the two curves represents the amount of current put in by the battery. Calculation shows that the battery furnished about 23.2 per cent of the total energy delivered to the mains. The maximum rate of discharge attained by the battery was about 270 amperes. Thus, in this case, we have an example of a battery which is used for the purpose, first, of giving a load to station machinery that would otherwise be idle; second, utilizing the stored energy to increase the rate of output of the station at the time of heavy load, which would otherwise necessitate greater dynamo capacity. In the second curve, five months later, the conditions have been changed. In the first place, the station output has increased greatly, being now about 2.9 times greater, and it is also continuous; i. e., instead of delivering current into the mains only from 6 to 11:45 p. m., as in the first case, the current is now delivered continuously, at varying rates, represented by the curve, a b c c' c'' e f g. The station now runs from 8 a. m. one day to about 2 a. m. the next day, or eighteen hours. When it starts at 8 a. m. it carries a two-fold load; first, the regular load allotted to this station, shown by the curve, c c' c'' e; and second, in addition, the load represented by the curve, d d' d'' e, which is the current absorbed by the batteries in charging. It is to be noted that the total load is much more uniform than if the station were feeding into the mains alone, for the extremes of current fluctuations shown by the curve, d d' d'' e, represent a total variation of only 80 amperes on an average load of 850, or less than 9½ per cent.

I have been informed within the last few days, by Mr. Parkenham,

that the battery is now being made to play an additional part of some interest. The maximum load (f) has increased to such a point that the station plant is no longer adequate; and consequently the battery is put on to "cap" the summit of the load, and supply the excess of current required above the capacity of the dynamos. When the load begins to fall off (about midnight) a part of the plant is shut down; but since the load is still too heavy for the other dynamos, the batteries again serve to supply the excess (from g to h).

There is only one other case in this country, namely, the Edison station at Germantown, Pa., where storage batteries are used as load equalizers. The total capacity there is of about 1,000 ampere hours, made up of several series of small cells connected in multiple. The battery is charged during the six or seven early morning hours when the outside load is very light. It stands idle during the heavy load in the evening and is discharged to carry the load after the plant shuts down. In this case the battery saves the expense of running the plant during the period of small load. Additional capacity is contemplated by the company and will probably be put in this winter.

A large battery is being installed at the central Edison station in Boston. This battery, of German manufacture (Tudor), will be by far the largest in this country, the cells being over twice the size and capacity of the battery of those in the Fifty-third street (New York) station referred to above. Its adoption was decided upon after a special study made of the use of storage batteries in European central stations, by Mr. C. L. Edgar, the superintendent of the company. The Brooklyn, N. Y., Edison station has also in contemplation the use of a similar battery.

It is in Europe, however, that the use of the storage battery in central stations has made the most headway.

In the city of London alone there are no less than eight stations supplying current for lighting, in which storage batteries are depended upon for part or the whole of the load carried. The aggregate actual capacity of these stations is some 200,000 lights (sixteen candle power). In many cases the batteries are not located in the generating station, but at sub-stations suitably located with reference to the consumers. The charging current is sent to the batteries at high potential, several sub-stations being joined in series for the purpose of charging.

In Paris there are some twenty or thirty such sub-stations located in various parts of one section of the city, and all charged from the same central station.

In the "Edison section" of the city an interesting application is made of a large (2,800 ampere hours) battery which is located at a point somewhat distant from the central station, and connected with the mains from which it is charged at those hours when the load is light, by taking current from the mains themselves; the potential being regulated by means of a continuous current transformer. In this way a considerable amount of energy can be sent at a low rate and, therefore, at small loss or drop of potential. This energy is used for maintaining the pressure in that portion of the mains and for delivering a certain amount of current which would otherwise have to come from the station over heavily loaded feeders (in the busy hours), and at greater loss of potential. Thus the battery, in this case, saves the cost of larger feeders, while it also furnishes a load for the hours of small load.

This plan suggests itself as of possible service in electric railway systems covering a large area of territory, all fed from a single central station. The batteries could be located at distant points, or at such points as would give the best distribution of current to the trolley lines with the least expensive line work. The station machinery would then virtually work at constant load to feed the batteries, which latter would supply the power needed for the car motors. In this way not only would an economy in the cost of conductors be effected, but there would be more uniformity of potential all over the system.

The city of Toulouse, France, affords another interesting case of the use of storage batteries at sub-stations, fed from a central station, operated by water power (320 horse power). In this case the feeders would not be sufficient in size to carry the whole current supplied direct from the station. At the hours of full load the batteries in the sub-stations discharge into the mains, thus obviating the transfer of current at the increased drop due to full load, and increasing the plant output. As soon as the load falls off and there is power to spare, one of the feeders is isolated from the system and used for feeding the charging current to the batteries.

The steadying influence exerted on the potential by the use of a storage battery is clearly shown by the record of a registering potential indicator shown in figure 7. This record was taken at the central station, Lyons, France, where a storage battery is used in connection with the generating plant.

The vertical distances indicate volts. It is seen that from a to b, or

from 3 to 7 p. m., when the battery was disconnected, the potential shows considerable irregularity. At 7 p. m., when the heavy loads come on the battery is put in use to supplement the dynamos, and it remains in circuit until 11:45 p. m. The station current, which is supplied to several concert halls, theatres, etc., varies anywhere from 1,200 to 1,400 amperes (of which the battery furnishes 100 to 200), and yet the pressure for this period of the run is absolutely constant, as indicated by the straight line from b to c, thus showing the equalizing influence which the battery exerts upon the circuit.

The following table gives some additional stations where storage batteries are used, with various data relating to them, the source of information being indicated by foot note in each case:

Location of Station.	Actual Capacity in Lamps.	Rate.		Quantity.		Station Load Factor.	Battery Factors.		Dynamo hours run per 24	Remarks.
		Delivery Capacity in Kilowatts.		Average Daily Output in Kilowatt hours.			Rate of Delivery.	Quantity of Output.		
		Dyna- mos.	Bat- tery.	Sta- tion.	Bat- tery.					
Bremen*	5000	360	Battery runs 18 hrs. with- out super- vision, In 3 sub-sta- tions, Gas Engine.	
Hamburg*	9000	737	165	6		
Barmen*	4000	188	193		
Duesseldorf*	6000	105	146	
Dessau*	2000	108	187	52		
Gabelsburg*	2400	80	33.5	10		
Gablouz*	1500	60	23		
Dundee†	438	22		
Hull‡	113	22	132	Battery runs 16 to 18 hours.	
Hanover§	14000	840	87	974	425	.479	.104	.436		6 to 8

* K Hedges Continental Electric Light Central Stations.

† Electrical Review, (London) April 21, 1893.

‡ Electrical Review, (London) May 12, 1893.

§ L'Industrie Elect., August 25, 1893, page 531.

The Hanover (Germany) station is the only one of which all the data under the various heads could be obtained. It is to be regretted that the corresponding data could not be obtained for all the others, as the information conveyed would be valuable to engineers. The Hanover station, to which reference will be made further, is an interesting case from the fact that it is comparatively large and has been in operation for several years.

Mr. Pakenham has kindly given me a list of some sixteen stations in England alone, using the Crompton-Howell battery with an aggregate capacity of some 900 kilowatt hours. There are also other stations in France, Italy, Austria and England, some of them large and of great interest, where storage batteries are used as regulators. No attempt was made by your committee to secure a comprehensive statistical list of them all, as it was thought that those cited would suffice to establish thoroughly the fact that the use of storage batteries is no longer an experiment confined to a few isolated central stations. These stations include cases where steam engines, gas engines, and water power are used

BATTERIES USED.

The data which your committee has been able to obtain regarding the storage batteries used in the applications just noted, are not as full and complete as could have been wished. Even some of those promised have not yet been received. However, enough information has been collected to demonstrate the fact that there is a wide difference and distinction between the storage batteries used for these applications, and the storage batteries with which the American street railway engineer and manager are familiar. The experience had in America with storage batteries would naturally lead one to expect that very radical improvements would be necessary to render these extended applications feasible and successful.

The close study and analysis of the evolution which the storage battery has undergone under European auspices indicates, however, no evidence of any great radical departure in principle or construction. The results attained seem rather to be the fruit of a thorough, comprehensive study and appreciation of the requirements of the cases, where they are to be used, of the limitations of the batteries themselves, and of the conditions requisite to make their employment successful. It must be admitted that the conditions are eminently more favorable in the case of stationary batteries than in the case of portable or of traction batteries, to be carried by the cars themselves; for the limitations of size and weight in relation to capacity are not serious or do not exist at all, to say nothing of the advantages realized in other respects. It is recognized, as a condition of success by the Europeans, that too much must not be expected in these respects, as too frequently has been the case,

and that the principal objects to attain are long life and high efficiency, even at the expense of increased first cost. Instead of attempting to obtain ten ampere hours per pound of battery element, the manufacturer limits himself to two, three, or at most, four. This makes a greater proportion of grid or frame to active material; but it also adds to the solidity and endurance of the battery.

The Planté process of formation and its modifications would seem to have proven themselves superior to the pasting or Faure process, if one can make a criterion of the fact that at least nine-tenths of the aggregate of the central station batteries used are of the Planté type, or some modification thereof. The Planté batteries are conceded to be, usually, of lower capacity per pound; but on the other hand they have the advantage of being able to carry heavier rates of charge or discharge. The battery plates are made of much larger size than usually made in this country, and only a few sizes (often only one) are made; the various capacities of cells being made up by adding the requisite number of plates. This simplifies the matter of extension. The cells, usually made of tarred wood lined with lead, may be provided larger than at first necessary; and, as required, more plates can be added to each element to increase its capacity. The practice of coupling separate groups in multiple is not much followed, and in fact is usually condemned, although there is no reason why it should not succeed when suitable means are provided to insure proportional action in all the groups at all times.

CAPACITY.

There is probably no storage battery cell on the market, of American manufacture, having as much capacity as 500 ampere hours. In Europe they can be procured up to five thousand ampere hours capacity. A cell of the latter capacity, weighing complete some 4,750 pounds, size about 36 x 39 inches, height about 40 inches, gives an idea of the scale on which the use of storage batteries in European central stations is carried on. It may be added that a further idea of the scale of operation is obtained by examining the plans of central stations, such as that of Hanover, where a separate building with four floors, about 70 x 35 feet is reserved for the storage batteries. The capacity of the batteries is rated on a more scientific and rational basis than has been the custom in this country. It being a well known fact that the capacity is lower when the discharge rate is increased, the practice is adopted of giving the capacities which the same cell will give under different rates.

To illustrate this a series of curves have been prepared, which are produced in Figure 8, showing the capacities of various sizes of the "Tudor" batteries (made at Hagen, Westphalia). Each curve refers to one size of battery. The upper end of each curve gives, on the horizontal scale, the capacity of the corresponding size when discharged at such a rate that its whole capacity is utilized in ten hours. The lower end gives the capacity for three hours' discharge. The intermediate points give the capacities at other rates (3, 4, 5, 6, etc., hours). The rate which is usually adopted as a general basis of comparison, estimates, etc., is that of the seven hour discharge, the corresponding capacities being obtained from the point where the curves cross the seven-hour line, which is shown thicker than the other lines. These batteries are all made from "unit plates" of like size and capacity and, as might be expected, the batteries have the same percentage of normal capacity for all sizes of cells.

The curve in Figure 9 shows these percentages for varying rates. In the diagram the seven-hour discharge is assumed to give full capacity (or 100 per cent). If the battery be discharged faster the capacity is less than usual (100 per cent); if slow it is more. The two curves, A, B, relate to the same values, from data obtained from distinct sources; the results being, as seen, fairly concordant. It will be found that the percentages calculated, for any size of cell, from the curves in Figure 8, will fall on or near the line A, in Figure 9. Hence, by bearing in mind the percentage for any rate of discharge the capacity of any size at this rate can be calculated.

In the diagram (Figure 9A) the same curve as A is plotted out (A) on smaller scale of percentages. Another curve is also added, showing the percentages of capacity of the Crompton-Howell battery. While either battery may be discharged at rates up to nearly full short circuit in emergency, the Tudor battery is not guaranteed for any discharge rate faster than three hours. The Crompton-Howell battery, however, may be discharged in an hour. The capacity of the latter, it is seen, falls to about 50 per cent on one hour discharge. Such extreme rates are not therefore to be recommended, and their use is limited to emergencies, where they are often of the greatest value. The ability to increase the rate of delivery 100 to 500 per cent in case of emergency, is indeed one of the qualities which recommends the storage battery for central stations, as there is no other generating outfit that can possibly approximate such extreme rates. In such cases the convenience is of far greater moment than the efficiency of the device.

The term capacity, as applied to a storage battery, really denotes the total quantity of energy which the battery can deliver, and must not be confounded with the term capacity as applied to a dynamo, which denotes the rate of delivery. The battery capacity, although designated usually in ampere hours, may also be designated in kilowatt hours, which is the product of the capacity (ampere hours) by the average voltage during the discharge, divided by 1,000.

EFFICIENCY.

This should not be confounded with the capacity.

If the values for ampere hours in figure 9 were replaced by the watt hours, the resulting curves would show the percentages of efficiency. The efficiency involves the loss in voltage as well as of current quantity, for it is well known that the voltage is reduced as the rate of discharge increases. Your committee could not procure sufficient data to prepare such efficiency curves from. However, as the variation in voltage is slight in comparison with that in ampere hours, at different rates, the efficiency percentage curve would resemble and approximate closely to the capacity percentage curves in figure 9. The curve for the Crompton-Howell battery would, however, show some improvement as compared with the Tudor curve, owing to its smaller loss of voltage at all rates of discharge.

Your committee, however, thinks that the most satisfactory report on this point is to refer to the results obtained in actual practice, covering long periods.

At Lyons, for a period of one month, the efficiency obtained by measuring, with a watt meter, the energy spent in charging, and the energy drawn out from the battery was over 85 per cent. In Hanover, the efficiency of the battery for one entire year, measured the same way, was 78.4 per cent. At Dresden, Germany, the efficiency for a year was 78 per cent. In the Fifty-third street station the watt hour efficiency has been over 85 per cent, the percentage which was guaranteed by the Crompton Howell Company.

It is conceded by all authorities that an efficiency of 75 per cent can be expected of such batteries, and that under normal conditions it may reach 80 per cent, or more.

It is proper to distinguish between the station efficiency and the battery efficiency, for a battery loss of 25 per cent does not necessarily mean a loss of 25 per cent of the whole power. If the battery, as in most cases, supplies only one-fourth, or less, of the whole output (in watt hours), it is that portion alone which the loss of the battery affects. Even in Hanover, where the proportion of the battery output is comparatively high (53.6 per cent of the whole), the total loss entailed by the battery is only 9.4 per cent of the whole energy produced by the plant.

INITIAL COST.

Your committee has found it very difficult to secure complete data as to the initial cost of central station batteries.

The cost is relatively greater for small cells than for larger ones, since the cost of the containing vessel and of setting up the cell does not decrease with the size.

In Figure 10, the curve, A, shows for the different sizes the list costs per kilowatt hour capacity of Tudor batteries, f. o. b., at the works, including packing. The discount allowed could not be ascertained with precision. The curve, B, shows the cost of Crompton-Howell batteries, erected, in London (the cost of erection being about 10 per cent). The curve, C, is the same cost, with 20 per cent added, which is estimated to be the approximate cost, delivered and erected, in New York. The dotted average curve, D, is added for convenience of comparison with A. The irregularities in the curves, B, C, are due to the transition from one type of plate, and also to the cost of containing vessels, which varies irregularly.

The Electric Storage Battery Company, of Philadelphia, which is about to put on the market some large central station cells (up to four kilowatt hours) of a type already in extensive use in France, informs me that it expects to reduce the cost to \$25, f. o. b., per kilowatt hour capacity. The total cost, erected, would be from \$30 to \$35, according to distance, etc. The cost of imported batteries, erected, would probably range, according to size, from \$40 to \$65 at the present time.

MAINTENANCE.

The maintenance is generally guaranteed by the manufacturer for a fixed annual percentage. At first this percentage was as high as 10 per cent. It was found, however, as the result of improvements that this percentage could be reduced safely. The present ruling cost of maintenance is about 5 per cent per annum for a ten year guarantee. In every case it is stipulated that the battery will be put in as good condition at the end of the ten years as when first installed.

Mr. W. S. Barstow, superintendent of the Brooklyn Edison station who visited several battery stations in Europe, has informed me that in some instances the lighting company has found that it could itself undertake the maintenance, and effect a saving, which fact he was allowed to verify by access to the accounts, the cost being in some cases as low as 4 per cent for a period of several years. The Tudor battery, installed in the Edison section already referred to, is stated to be under a ten year guarantee at 35 per cent per annum. Mr. Pakenham has given me figures for some Crompton-Howell installations, where the cost of maintenance was only about 4 per cent. There being no instance of a storage battery used in railway stations, the cost of maintenance under the conditions which obtain there, cannot be ascertained, and can only be conjectured. It would appear, from consideration of the new conditions involved, that the depreciation must necessarily be greater; and that not less than $12\frac{1}{2}$ per cent or even 15 per cent should be taken provisionally as the estimated cost of battery maintenance in railway power stations.

CONDITIONS OF USE.

Your committee has noted, in every case investigated, a scrupulous attention to details, large and small, of the installation of the batteries and of their care and treatment, which contrasts greatly with the way storage battery installations have been usually treated in this country. This may, and doubtless does, account in part for the difference in results obtained. Great care is taken to have the battery perfectly insulated, and to see that the plates are equally spaced, equally formed and equally active. The purity of the water and of the acid used is carefully watched, the strength and quantity of solution is carefully regulated, and, finally, care is taken that the battery is properly and fully charged. Some form of watt or coulomb meter is always used, as a means of determining the efficiency, and often as a means of controlling the amount of charge to be put in.

The information which your committee has gathered on this point, from all sources, seems to warrant the conclusion that storage batteries require attention, not necessarily extensive or expensive, but regulated or systematic attention.

SERVICE PERFORMED.

It has been shown by the above examples that storage batteries can be adapted to various purposes in central stations or sub-stations. The primary reason for their use is, of course, the possible gain to be obtained through them. This gain may consist in a saving of initial cost of labor or of power, or it may take the form of an increased revenue that could not be obtained otherwise.

The saving in initial cost is often the principal object aimed at. In places where the load comes on rapidly at certain hours, reaches a very high value for a short time, and again quickly drops down to a low point, (somewhat as in Figure 5) the dynamo capacity will be taxed to its utmost for a short period, and most of it will be idle the rest of the time, while even the portion kept running may be so underloaded as to impair its efficiency greatly. In the case of direct coupled dynamos, now being adopted extensively, the reduction of efficiency at light loads is much more serious. (Compare curves, A, B, Figure 6). In such cases, it often turns out cheaper to use a smaller generating capacity and introduce a storage battery, which serves the double purpose: first, of giving a load to the dynamos, when the consumption is light, thus keeping the machinery at its highest efficiency and earning capacity; second, of supplementing the machinery when the load begins to rise above the capacity of the machinery.

In the case of a lighting station using underground conductors, which are usually expensive, the saving in initial cost sometimes becomes a very important consideration. These sub-stations containing batteries then answer a useful purpose. If the energy is produced and sent to the distant point just as it is consumed, it is clear that the feeders must be proportioned for a given "drop" at the highest load, and every change of load will change the drop. On the contrary, if the energy can be produced and sent ahead and stored near the point of consumption, a much smaller feeder will answer the purpose, and the longer the time taken in sending the supply the smaller the rate is, and consequently the smaller the feeder may be. Incidentally, the battery serves just as before to give a load to the station during the hours of light load. It also serves to equalize the pressure of the mains in its neighborhood. The saving of labor is, in some cases, an important consideration. There are many cases, such as at Kensington Court sub station, in London, where the plant is shut down, the station locked up and the load taken care of entirely by the storage battery, for several hours. (about six in this case).

The gain from increased revenue, by the use of storage batteries, is effected in cases where the supply of power is continuous but limited,

usually water power, but also in the case of gas engines which, it may be said by the way, are coming into use in central stations in Europe, particularly in Germany. In the case of water power, the storage battery enables the power of the whole twenty-four hours to be prepared so as to be ready for delivery during the comparatively short period of full load, if desired.

In all of the above cases, the cost, efficiency, depreciation, etc., of the battery, on the one hand, and the value of the benefit to be derived, must be carefully weighed, in order to determine the relative size, etc., of battery that is best suited for the purpose, it being evident that where power costs little, the loss in the battery, for instance, is of less consequence than where power is expensive.

APPLICATION TO ELECTRIC RAILWAY POWER STATIONS.

The abundant evidence which your committee finds of the usefulness of storage batteries in central stations for electric lighting, makes it natural to presume that they can also render good service in electric railway power stations. Your committee had hoped to be able to present at this meeting, some practical results, tending to show whether or not this presumption be warranted, but no amount of argument or persuasion has availed with the street railway managers who were approached, so great is the disrepute into which the storage battery has fallen in this country.

The object aimed at is the same in this case as in lighting stations—economy, especially of initial cost and of power. The conditions which the storage battery must meet, however, are scarcely the same; they even vary considerably in different cases, especially according to the size of the plant. The problem is to determine what the power will cost with and without the use of a storage battery in any case. The initial cost of the storage battery will primarily depend upon two things: First, the total maximum quantity of energy it will ever be called upon to deliver, i. e., its storage capacity, say, in kilowatt hours; and second, the maximum rate taken in any convenient unit, say kilowatts, at which the energy will be put in or drawn out. Sometimes one of these factors, sometimes the other, alone, and sometimes both together, will influence the size of battery to be used for a given case. Your committee has found it convenient to designate these as the "battery factors," calling the first the battery "quantity factor," and the second the battery "rate factor," in which case they are expressed as ratios. Thus the quantity factor is defined as the ratio of the quantity of energy to be drawn from by the battery, to the total quantity to be furnished to the (trolley) circuits under maximum conditions, while the rate factor is defined as the ratio of the current to be furnished by the battery to the total current, also under maximum conditions.

There are also other "factors" to be considered, the station factors, a most important one among which is that to which an eminent English electrical engineer, Mr. R. E. Compton, (of the Compton Howell Company), has given the name of load factor. If, in Figure 1, we take the dotted line to represent the mean or average load at which the plant, when worked constantly for the total run, would develop the same total amount of energy that is represented by the load curve itself; and if we draw another line higher across the diagram, to represent the mean or average load which the station plant could carry, when worked for the whole run at its full normal capacity; then the ratio of the height of the first line to the height of the second line is the "load factor," or the relative proportion of the actual output to the possible output or earning capacity of the station.

If in Figure 1 we take 2,200-horse-power as the total capacity of the station (although it is in reality higher in Minneapolis), then, since the mean load (a b) is 1,168-horse power, we find for the load factor the value of 53.2 per cent, which translated into business language, means that the plant has only 53.2 per cent of the earning power it ought to have for its size and for the interest and depreciation which has to be paid for it per annum. The smaller the power station, as a rule, the smaller this load factor, and consequently the greater the proportion of "idle" capital investment. This is not the worst feature of the situation, however. The loss of economy entailed in running machinery at lower capacity, which is notable even when said light loads are constant, becomes serious when they are also fluctuating to the extent that obtains in railway plants. Under those conditions the engine is not quietly, but openly "knocking down" on the coal pile, so to speak.

Let us take for instance the load diagram in Figure 1, which shows by calculation a total output for the day of 23,260 horse-power hours. Actual tests made at this station* show a steam consumption of some

* "Performance of Street Railway Power Plants," an interesting paper by W. A. Pike and T. W. Hugo, read at International Engineering Congress at Chicago, August 3, 1893.

Street Railway Review

DIAGRAMS REFERRED TO IN PAPER ON STORAGE BATTERIES IN CONNECTION WITH CENTRAL STATIONS.

BY C. O. MAILLOUX.

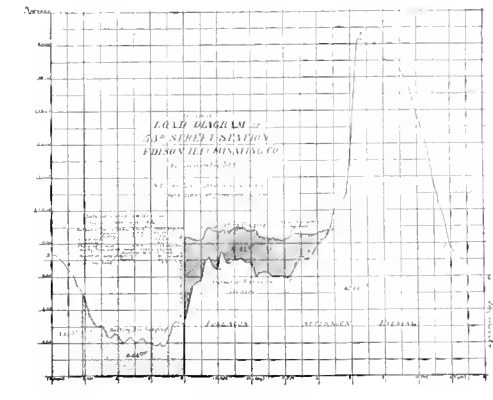
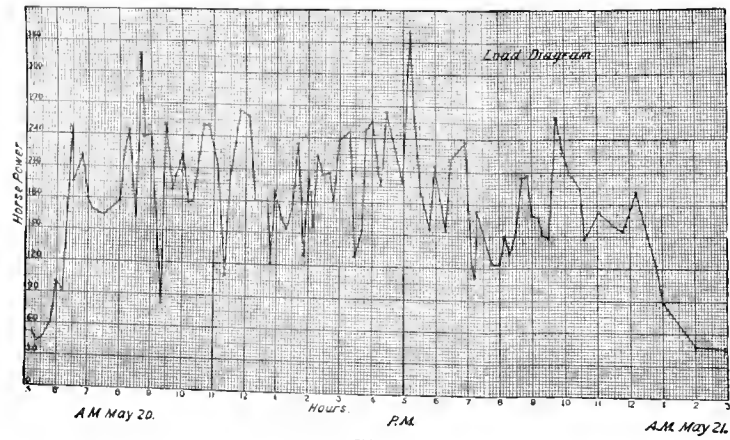
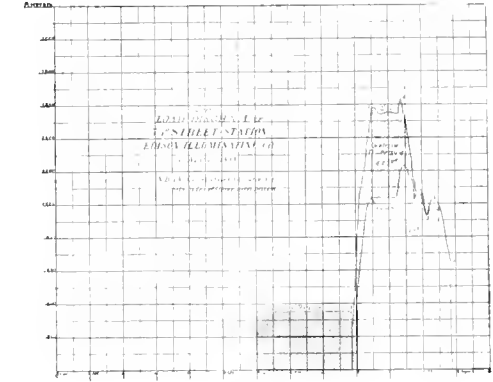
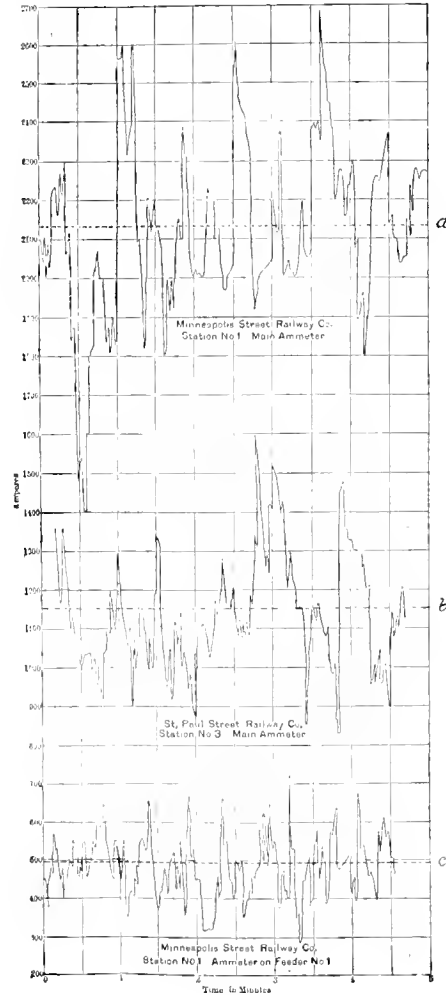
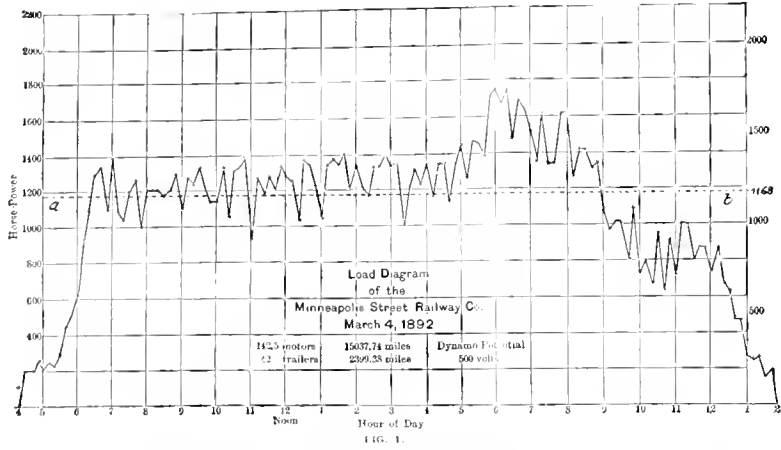

Street Railway Review

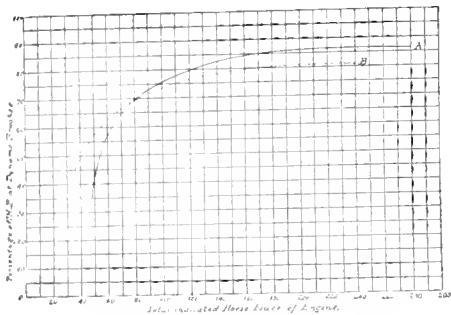

FIG. 6

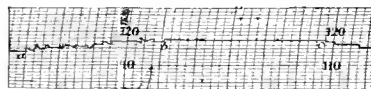

FIG. 7

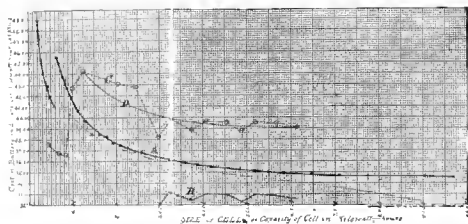

FIG. 10

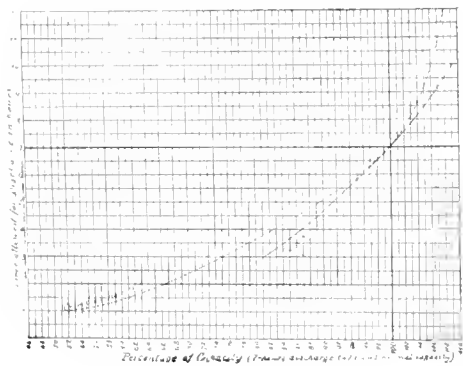

FIG. 9A

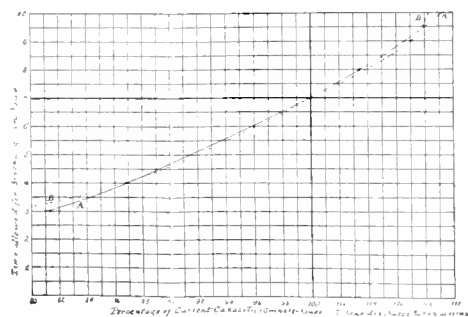

FIG. 9

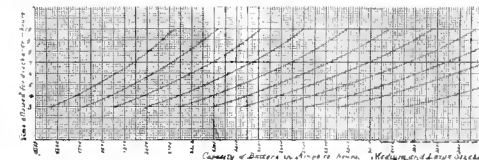
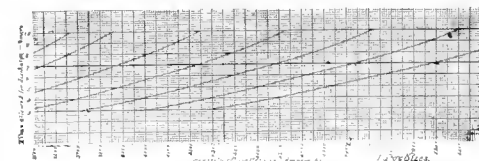
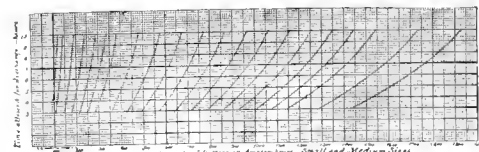

FIG. 8

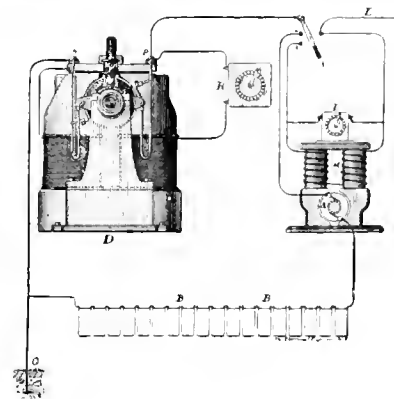

FIG. 11

21.5 pounds per horse power hour with engines (compound condensing) that would easily do the same work with 16½ pounds, or 5 pounds less, if doing this work at uniform steady rate. Here then is a case where the highest engineering skill and material have apparently been used, with a view to securing the highest economy; where in a word, the conditions are probably more favorable than in three-fourth of railway power stations, taken as they come; and yet the fuel consumption is still some 30 per cent greater than might be. This means, for the whole output of the day, 116,300 pounds more of water to be evaporated, equivalent, as the boiler tests indicate (9.8 pounds of steam per pound of coal) to 5.3 long tons (2,240 pounds) of coal.

Your committee finds in the same paper some valuable corroborated evidence of the great influence which the character of load has on the efficiency of the engine. In a station where the steam consumption was found to be 29.2 pounds per horse power hour under the conditions of the actual service, the authors found that it was only 22.5 pounds, when the same engines were run on a steady constant load which they specially provided and arranged for the test. The (compound) engines in this case are of a type which is claimed to be more efficient than most others, under the fluctuating loads. Yet the steam consumption on fluctuating loads is still about 30 per cent higher than it would be on steady loads. One might well shudder to think what the steam consumption must be in stations not having such efficient machinery.

Turning now to the storage battery as the proposed remedy for these evils, it is apparent on business principles that one wants to use as small a battery as will serve the purpose, for it is an expensive medicine, owing to its high initial cost and to its depreciation, which, though low enough in lighting stations, must be taken higher in this case for the present and until practical results in railway power stations have indicated the exact percentage.

We must first determine the battery factors. In railway power stations the rate factor will usually be much larger and the quantity factor much lower relatively than in lighting stations. Hence the size of a battery required is more apt to depend on the rate factor, while in case of lighting stations the reverse is usually the case.

It may happen, indeed, that although the actual capacity needed is quite small, a larger battery must be used, nevertheless, simply because the smaller one could not be charged or discharged at sufficiently high rates. In lighting stations, on the contrary, if the battery has the requisite capacity its rate factor is generally (not always) adequate for the case. As the extreme rates of charge and discharge would be either momentary, lasting from a second to a few minutes, in batteries used on railway circuits, a much greater latitude could doubtless be allowed in this respect. Taking the current rate for seven-hour discharge as normal, it is the opinion of your committee that these rates could be safely doubled for short periods. Provisionally, however, a rate corresponding to four-hour discharge may be taken. This establishes a relation between the rate factor and the quantity factor, for, in order to be able to count upon a certain rate of delivery we must provide a capacity sufficient, in every case, to maintain this rate for four hours. Hence, given the rate of delivery in kilowatts, the battery capacity in kilowatt hours must be four times that number, or given the capacity, the highest allowable rate will be one-fourth that number. In figure 1 the line A B represents the load which the engines would carry to do the same work at constant and uniform rate, working twenty hours per day instead of twenty-two. This mean load is 1,168-horse-power. For twenty-two hours it would be 1,057 horse-power. In order to be able to run the plant continually at either rate, the battery must be adequate in capacity and in rate to supply all the power necessary when the "waves" rise above the mean load, and it must be capable of absorbing all the energy required to keep the load up when the waves or "billows" fall below it, especially at the beginning and end of the run. It is easily shown that under such conditions the annual cost of the battery would be greater than the annual value of the gains derived by its use. Let us see, however, if the conditions can be varied slightly, so as to reduce the cost of battery and still retain its advantages as a load equalizer and compensator. We will assume that the plant is to be run twenty hours per day, two shifts of ten hours, starting from 5 a. m. with about 800-horse-power and running for an hour, then running from 7 a. m. until 10 p. m. at 1,300-horse-power, then running again at 700-horse-power until 1 a. m.—the end of the station run. The cars running after the plant stops, or during the night, and those running before the plant starts, would draw their current from the storage battery, a feature not without its merits. When the plant would start at 5 a. m. it would deliver some 500 horse-power into the batteries, the rest being sent out direct on the lines. By 6 a. m. the lines would absorb about the whole 800 horse-power and, consequently, the generating output would be raised to 1,300 horse-

power, which point the load soon reaches, so that by 6.30 the battery has not only stopped charging but has even discharged for several minutes, to take care of the excess of load above 1,300 horse-power. From that time until about 5.30 p. m., the battery is ebbing and flowing, the difference between the total amounts of charge and the total amounts of discharge being very small. About this time, however, the battery would begin to discharge, and by 6 p. m. it would be carrying the 450-horse-power load, that being the excess of total load (1,750-horse-power) above the engine load, which, as stated, is to be kept constant at 1,300-horse-power. At 9 p. m. the load falls under 1,300-horse-power and the battery begins to receive a charging current again. From 10 to 12 p. m., the output being reduced to 800-horse-power, the batteries will, as the curve indicates, charge and discharge in turns. From 12 to 1 the batteries will be mostly charging.

The quantity factor, by calculation, is some 6 per cent; or, if we selected a battery by this factor, it would have a capacity of 6 per cent of the total daily output (23,260 H. P. hours), which is about 1,400 H. P. hours. The rate factor is about 27.8 per cent of the maximum rate (taken at 1,800 H. P.) This is 500 H. P., and at the least capacity allowable will be four times that number, the resulting capacity required is 2,000 H. P. hours. Therefore, the battery factor compels us to take a capacity some 43 per cent greater than the quantity factor shows to be actually needed. This means in practice the battery will not be discharged fully at any time, except in emergencies, for which it has a reserve sufficient to carry a load of 500 H. P. for over an hour. A capacity of 2,000 H. P. hours is theoretically equivalent to 1,492 kilowatt hours, but as a H. P. hour, at the engine, would represent not over 0.85 electrical H. P. hours, it follows that the practical equivalent capacity of battery is 1,275 kilowatt hours. Taking the cost purposely at the highest figure, 65 cents per kilowatt hours, the initial cost of battery of 1,300 kilowatt hours erected, will be \$8,450. The depreciation at 15 per cent and interest at 6 per cent, or in all 21 per cent, will make the annual cost \$1,775, or \$4.86 per day for a year of 365 days. The estimated savings of this case, in consequence of making the load steady, was equivalent to 5.3 tons of coal. The battery, however, will add to the total energy produced, enough to cover the energy less which it introduces. The battery supplies 6 per cent of the energy at a loss of 75 per cent, which means 4.5 per cent of the whole energy produced. The plant will therefore have to generate some 24,350-horse-power hours instead of 23,260, representing 18,315 pounds more steam and 1,869 pounds more coal. The net saving would therefore be about 4.47 tons. In a station already built, such as this one, the only saving is that in coal. If coal cost less than \$1.10 per ton, the project would not pay; at \$2 a ton it would effect a saving of \$2.08 per day, and a corresponding amount at other prices. In the case of a new station, however, the saving would be materially greater, for it would include the interest on a certain capital that it economized in the equipment. Instead of a maximum capacity of 2,200-horse-power assumed here, the plant need not be built for more than 1,500-horse-power capacity to do the same work. We have a saving in the cost of 700-horse-power, amounting to probably at least \$7,700, the interest and depreciation on which taken at a low figure, 12½ per cent for the two, amounts to \$960 per year, or \$2.64 per day.

In many cases, the problem is slightly different. The road has developed and extended until the power station capacity is overtaxed. In many such instances calculation based on a full study of the conditions involved would probably show that the increased capacity could be obtained more cheaply by simply adding a storage battery to the station, the fact being that the station capacity is really large enough already when once the fluctuations are disposed of. In many such cases it will doubtless be found that, owing to the gain in efficiency, the cost of power would not be much increased, if at all; and in a few cases where the efficiency is now desperately low, it might even cost less for more cars.

Your committee has selected the example given for a detailed case, first because the data obtainable regarding it are more complete than for any other case; second, because it has been always considered that a road of 150 to 200 cars was a "limiting" case, where the storage battery was likely to be of little, if any, utility.

The smaller the station the more perceptible the effect on the efficiency will of necessity be. The quantity factor becomes smaller, but the rate factor is usually larger, until on small roads of 10 cars and less may amount to 60 per cent; the load itself sometimes running up to 2½ or 3 times average value.

In the case shown in Figure 3, of which the data are unfortunately incomplete, the battery rate factor would be about 55 per cent of the maximum (400-horse-power), representing a delivery rate of 220-horse-power, and the capacity would be 880 horse-power hours, or about 558 kil-

owatt hours. It would probably be better in this case, as there are only a few extreme jumps in the curve, to reduce the rate factor and depend on the engine to rise in capacity 10 to 15 per cent when such extreme loads occur. By doing this, the rate factor could be reduced to 25 per cent and the battery capacity to about 260 kilowatt hours. It may be in fact that experience will show that the rate factor should be constant, or nearly so for all cases, to obtain best economy (least annual cost). Under these conditions the battery would involve an expense of only 78 cents per day for interest and depreciation. The engine capacity need not exceed 180-horse-power; the load would be about 180 to 185-horse-power, except for the early and late hours of the run, when part of the plant would be shut down as in the first case considered. The daily output is about 4,000-horse-power hours, to which may be added about 5 per cent for loss due to the battery, making 4,020-horse-power hours. The saving effected by reason of steadier load would be in the neighborhood of a ton, according to the engine used. The hours of running could also be shortened to 20, as in the previous case.

WATER POWER.

The use of storage batteries is destined to important applications where water-power is used for railway power generation. In such cases, since the power costs relatively little, the gain in efficiency is not of so much moment as are the regulating quality and the ability to store energy. Where the supply of power is constant, but limited, the rate of consumption can never exceed the rate of production. The consequence is that in railway water-power stations, either the potential fluctuates seriously or else a sufficient margin of available power must be allowed, which means that the power cannot be worked to the limit. With the storage battery, not only the turbine can be loaded to the full limit, but the load may even be greater, if there is sufficient time in the intervals between heavy loads to accumulate a reserve power in the batteries.

REGULATION.

The process of making storage batteries absorb from or give back to a circuit, and desired rate of current, consists merely in varying the working potential of the battery in relation to that of the dynamo or circuit to which it is coupled, same as load can be divided up in any desired proportion between two dynamos in multiple by simply varying their E. M. F. relatively to each other. In the case of storage batteries, unfortunately, the working E. M. F. is not the same when charging as discharging, nor is it the same for different rates of current, or even for the same rate at various periods of the charge or discharge. Hence, constant adjustment is necessary. In lighting stations, the desired relation of working potential to control the charge or discharge is effected usually by putting more or less cells in circuit. This method would be inadequate for the fluctuations met with on railway-power circuits, by reason of its lack of quickness and of flexibility. The means provided must be such as to make the change of relation adapt itself to every change of load automatically, instantly, and to any desired degree. This can be accomplished by introducing in the battery circuit B B (Fig. 11, a variable source of potential, such as produced by a small dynamo A) to which the name "booster" has been given. In the figure, the working current sent over the line L passes through the field magnet coil M, being suitably proportioned by a shunt T, and thus enables the fluctuations of load themselves to control the working potential of the batteries so as to produce any desired relation.

For further details regarding this method, see the Street Railway Journal, November, 1890 and June, 1893; the Electric Engineer, December 3, 1890, August 30, 1892

The figure is intended merely to show the principle, the details admit of great modifications and improvements over those shown.

SUB-STATIONS.

It makes little or no difference in the compensating action of the batteries whether they be coupled to the circuit at the station or at sub-stations located at various points at a distance from the station. There would result from the use of sub-stations a greater uniformity of potential over the whole system and a saving in copper, but one must offset against this the extra cost of the space, the extra attendance and expense of such sub-stations. They may be warranted, for this reason, only in very large systems covering large and relatively distant territory, also in inter-urban lines.

CONCLUSIONS.

The investigation and study by your committee of the facts and data bearing on this subject, as outlined herein above, would seem to your committee to warrant the following conclusions:

1. Great progress has been made in Europe during the last two or three years in the manufacture and perfection of storage batteries suited for central station purposes.

2. Storage batteries have been introduced in a large number of electric lighting central stations on a large commercial working scale, as factors of reserve and regulation, with a view of securing economy of initial cost and cost of operation, with satisfactory financial results, as a general rule which has few, if any exceptions, so far as your committee could ascertain.

3. The benefits derived in lighting central stations from the judicious use of storage batteries are so valuable in individual cases, that the possibility of attaining like benefits, even in lower degree, in railway-power stations, would justify the investigation of their use by actual experiment, where this can be done under favorable conditions.

4. While the conditions differ and are essentially more severe in railway power stations, there is no reason apparent why storage batteries may not be used successfully and advantageously for the purpose of securing greater uniformity of potential at the station or on the line, or of promoting and improving the efficiency of the plant.

5. Even assuming the highest values for initial cost and depreciation of the storage batteries, the indications point to the possibility of realizing a gain in economy in all stations operating 200 cars and less, when coal is worth \$2.00 per ton and over, while the economy will be much greater should the initial cost and depreciation prove actually lower in practice. Advantages are also secured which, though not affecting the economy directly, do so indirectly by affording additional convenience in operation.

6. The indications are that in some cases a power plant could be built and operated at less cost by using storage batteries, than without.

7. The capacity of an existing plant can probably, in most cases, be increased more cheaply by adding storage batteries than by adding more generating machinery, while at the same time the cost of operation will be reduced.

8. The question whether storage batteries are expedient and practicable, and to what extent for any particular case, should be, and can only be, in the present state of our knowledge, determined for each case individually, by a careful analysis of the facts and conditions involved, by a competent engineer.

9. Practical experience in a certain number of stations alone can lead to definite rules or indications in regard to the best size of battery, the best methods of regulation, the most favorable conditions of use, and like questions.

10. Perfection in the details of the use of storage batteries in railway plants will be the result of a certain evolution or series of improvements, same as in other details of the equipment of a plant.

Respectfully submitted,

C. O. MAILLOUX,

Committee.

After reading his paper the author spoke at considerable length, his remarks, however, being largely a repetition of his manuscript. The imperative necessity of having such articles printed and in the hands of delegates was most apparent. Its great length and technicalities making it impossible for anyone to discuss it intelligently, without manuscript copy, even had they desired to do so.

The next was the

REPORT OF COMMITTEE ON "DIRECT-DRIVEN GENERATORS."

TO THE AMERICAN STREET RAILWAY ASSOCIATION.

Gentlemen.—I have been requested by the president to act as a committee on the preparation of a paper on the subject of "Direct-Driven Generators." I will try to present to you briefly a short sketch of the development of this type of apparatus. In taking up the subject I have taken a somewhat liberal interpretation of the title of my paper, feeling that in order to present the matter intelligently before you requires the consideration of the generator in connection with the power station.

I have tried, in taking up this subject, to obtain from manufacturers of apparatus, both generators and engines, also from the managers of power stations, all possible information relative to the subject and sent out a list of questions covering the following points:

Relative economy of direct-driven and belted apparatus; type of machine best adapted for direct driven; method of connecting generator

and engine; types of engine best adapted to the work; overhung armatures or outward bearings; comparative cost of the generators and engines; comparative cost of the generating station complete; general relative economy in operation, and many other general minor details.

I will try, in presenting this, to give a general summary of the subject as it presents itself to me, for your consideration and careful thought.

HISTORY OF THEIR INTRODUCTION.

I will not take up according to dates or chronological order the introduction of this type of generator, but will merely sketch in a general way their introduction.

Back in the early eighties the different manufacturers in Europe, including Brush, Siemens & Halske and others, commenced the building of direct-driven generators of small capacities connected to different types of engines, operating at a high rotative speed. Among these were a large number of Brush machines connected to Westinghouse engines. About the first apparatus for use in central power stations were those designed and built by Mr. Edison for the old Pearl street station in New York city. These machines were about 300-horse power capacity, directly connected to an Armington-Sims automatic, single cylinder engine, operating at about 250 revolutions. This apparatus is still in use at the present day, except a few of them which were destroyed in a fire in the station several years ago. One of these units is shown in the exhibit of the General Electric Company at the World's Fair. There is also a large power station operating in Milan, Italy, with the same type of apparatus. Although it is ten years since these particular units were built, it is only within the last two years that we have commenced their introduction to any general extent on large power station work. Although these units operated in general in a satisfactory manner, the type of generator and engine were not perfected generally to give the best of service, and therefore electric manufacturers abandoned their development after these first ones and returned to belt-driven generators, and they continued to be the standard type of power station generators until two years ago.

In Europe, though, we have a different history of the matter. The development of their electric apparatus has been slower, and they have therefore had more time to work up special designs and perfect different types of generators. The general commercial requirements were not so rushing, and when American manufacturers commenced to develop to a large extent direct-driven generators, they found their co-workers in this line in Europe far ahead of them, in that they had several years ago a number of large stations in Berlin, Paris, London and other parts of Europe, operating with units up to a thousand horse power, directly connected to different types of engines, principally vertical ones. The writer remembers in 1887 and 1888, when he was connected with one of the electric manufacturing companies, the difficulty he had to get the shops to build the first small direct-connected generator for naval service. This really commenced the development of this type of apparatus with American manufacturers, and the old Edison, Thompson-Houston and Westinghouse companies commenced building them in small units. All of the foregoing generators, although for different types of central station and power work, were not any of them used on electric railroad work. Commencing in 1890, the Thompson-Houston, Edison, Westinghouse, and later the Siemens-Halske Company, of America, commenced designing and building railway generators for direct connected work, and during the past year there have been quite a number of new stations operated and building, which are equipped entirely with direct-connected generators, running in size all the way from 100 K. W. to 1,500 K. W.

DIFFERENT TYPES OF DIRECT-CONNECTED GENERATORS.

The type of generator being built and furnished to-day for direct-connected work is far superior in every respect—almost beyond the question of comparison—to the early and antiquated small generators which many of our friends are using and struggling along with to the tune of the popping of the safety fuses and circuit breakers; the whirl of the revolving grease besmeared belts, and the squeak of the friction clutch pulley. The direct-driven generators built by the different manufacturers, in a large measure, are of the same general construction so far as general details go, differing in minor points only. I have taken as illustration the more permanent to give a fair and intelligent representation of this type of apparatus. I feel it is not necessary to do more than this on account of the fact that it would only be repeating the illustrations which many of you have seen, from time to time, in the technical press, and the practical illustration which most of us have seen of this type of apparatus at the Fair in Chicago.

In Figure I. we illustrate the Westinghouse generator coupled direct to the Westinghouse engine by their well known method of flexible

clutch coupling. This generator was one of the first of direct-connected machines to be introduced on railroad work, and is now built and operating in units up to 375 K. W. on railroad work and up to 1,000 K. W. for power, in a large number of stations throughout the country. The generator as is shown in the illustration is a multipole machine, with iron clad slotted armature, and is built entirely separate from the engine in all respects. The principal point of difference in this unit between that of other manufactures is in the method of the connection to the engine, which is by flexible coupling, the engine and generator having separate shafts. The generator in general appearance resembles the belted machine built by that company in its construction. The rotative speed of this direct-connected machine is somewhat higher than those of the other manufacturers of the same capacity, but operated as it has been generally with the Westinghouse engine, it has proved itself so far a well constructed and good operating machine.

In Figure II. we illustrate the type of machine built for railroad or power work by the Siemens-Halske Company. This company has the advantage of the development of this machine by their company in Europe, which development commenced, as previously stated in these large units, considerably before that of the American manufacturers. This machine, as is shown in the illustration, is mounted directly on the shaft of the engine, from which it operates, which shaft is supported at the outer end by an outboard bearing. In this type of machine the electro magnets are placed inside of the Gramme ring. By this arrangement the diameter of the armature is largely increased and the peripheral velocity is great even with a slow rate of speed, making the machine specially adapted for direct connection. The field magnets are bolted to the pillow block of the main shaft and the ring shaped armature keyed on outside the magnets to the main shaft like a flywheel and the outer end of this shaft is supported as stated by an outward bearing. This machine is not provided with any special commutator, armature winding is on solid copper bars, on which the brushes rest. Owing to this company only having within the past year completed their works in this country, their machines are not introduced here yet very extensively. But the record they have made in Europe proves them to be well designed and good operating apparatus.

In Figure III. we illustrate two 200 K. W. generators, directly connected to a 750-horse-power marine type of automatic cut-off engine, operating at a speed of 120 revolutions. This generator is of the type developed by the old Edison Company for central power station work, and is what is termed the smooth body type of armature. The armature bars consist of solid copper bars, U-shaped, and slipped over the core or body of the armature, the brushes bearing on the head or end of the same. These machines have proved good operating machines, and there are a number operating on railway work in Milwaukee.

In Figure IV. we illustrate one of the large units in operation in the Intramural power station at the World's Fair. This generator is an 800 K. W. machine, manufactured by the General Electric Company, and is what they term their iron clad body type of armature, which is the type they are specially developing for railway power work. This machine is self-supporting, in that the armature is not mounted on the engine shaft, but has its own separate shaft, and is coupled to a vertical type of compound marine type of automatic engine, manufactured by the Lake Erie Engineering Works. This unit is next to the largest which has been built for railroad work, and been in continual service in this power house since the day it started, the 4th of July, and has operated almost wholly the entire service of the electric elevated railroad at the Fair. The engine and generator have stood an overload as high as 80 per cent above their rated capacity, and seem to be specially adapted to stand severe strains of railway power work. While the generator is not quite so compact in floor space as those which are mounted directly on the engine shaft, it seems to possess in many respects desirable points as regards engine and generator connections for railroad power, based on practical experience and its operation on this severe work, and has already resulted in its adoption for several large plants.

In Figure V. we illustrate what may be termed the Jumbo generator for railway work; this machine is double the capacity of that in Figure IV.; is built by the General Electric Company, and is the same general type of machine shown in Figure IV. This generator was designed and built for operation in several large power plants which are now being built, among them being that of the Brooklyn City Railroad, where six of these units are being put in operation. The particular one herein illustrated is at present operating in the power house of the Intramural road at the World's Fair. This generator is operating in connection with a cross-compound Reynolds Corliss type of engine. On account of the general construction arrangement of the engine, the generator is shown mounted directly on the engine and alongside of the flywheel,

The field magnets on both this generator and the 800 K. W. machine shown in Figure IV are so arranged that by turning a crank the magnet frame can be moved to one side, leaving the armature entirely accessible for removal or repair. This generator has not as yet been extensively operated in regular service, but has been used sufficiently to demonstrate that it is a well designed machine, and has shown its ability to carry the same proportion of overload as the 800 K. W. machine.

The foregoing different illustrated types of generators, from which the railway owner may select for operating his station, show the remarkable development which the manufacturers have made in such a short time in the practical development of these generators. There have been no failures. It is shown that designing of this apparatus has now reached a practical, commercial development. The machines require very little attention and are easy of repair.

TYPE OF ENGINE TO USE.

The type of engine to use in connection with the operation of direct-driven generators is one of the serious factors to consider in this connection.

There are many points to be considered of economy, reliability, continuous service, good regulation, ability to stand the direct and severe shocks due to overloading generators, short circuits, economy in floor space, etc.

On the question whether vertical or horizontal is better adapted, common sense seems to indicate that as we are laying out a compact plant in every respect, a vertical engine is best adapted for this work. The question of regulation is a very serious one. The engine is undoubtedly called upon to stand a test which no belted machine has had to do on account of being directly connected to the generator, and some one of the different types of shaft governors in use on some of the standard machines seem to be best adapted thereto, and will govern within a range for this work of, say, two to three per cent.

On the question of economy so called high speed engines are in a measure out of date on this kind of work, as generators are reaching a size beyond the capacity of our old friend, the single valve automatic engine. This engine seems to have reached its limit in economy at about 200 to 300-horse-power, that is, where controlled by a single valve. We are confined, then, to one or two types of engine. The old standard of general commercial practice, the Corliss engine, which, on account of our large experience with it, has been called upon more largely for service on this kind of work than any other, in general, is meeting these requirements in most respects. There seems, though, to be some question of reasonable doubt as to whether it will regulate sufficiently close to meet the more exacting requirements of this class of work, where called upon to control very wide and sudden changes of load. On the question of economy they have shown in the past the highest economy obtainable, but that has been more especially on steady loads near their rated capacity. With loads which fluctuate as railroad work does, they cannot reach nearly their guaranteed economy. We also have the disadvantage of the controlling valve when cutting off over half stroke. In Europe, where their practice on direct connected work has extended over a much longer period than ours, they are using largely various modifications of the vertical marine type of engine, controlled by different types of governors. An engine of this class, well and substantially built, with double valves on the steam and exhaust, and controlled by shaft governor, controlling the valve up to three-quarters cut off, would seem to combine many points of superiority of an engine on this class of work, and give service in reliability, economy and durability, superior to any other type obtainable. Manufacturers and designers in this country are now rapidly developing this type of engine, which is shown in Figs. II, III and IV., and are being built by such manufacturers as the Lake Erie Engineering Works, Dickson Manufacturing Company, McIntosh & Seymour, Porter Allen and others.

RELATIVE ADVANTAGES, COST AND ECONOMY.

The electric railroad manager says this matter is very interesting, but where do I come out on the cost and as to economy? I will try to give him a few practical points in this regard. In general the generators are being sold to-day for about 20 per cent above the cost of belt-driven machines of the same capacity. As we reach the larger units, which are now being built, this difference will be considerably reduced. Allowing, though, for this difference in cost of the generator, we find, after carefully reviewing several cases in the writer's experience and that of others, that the cost of the power station complete, exclusive of real estate, but including the same electric plant and building, is not more on a direct-driven plant than the older type of belted apparatus. This should settle the question beyond doubt, especially where new stations

are being built. I feel that I cannot impress you too strongly with the fact that many of the railroads are going to find it to their advantage to scrap and sell at the best advantage they can their present apparatus, and build a new and modern station. The economy gain will be a large one in every respect; more reliable service; satisfaction to the public; reliance in the operation of their car service, which they have never been able to realize with their old type of small belted generators, and a reduction in station force, which will be appreciated by every dividend loving stockholder. I have tried to obtain the best and most reliable data in this question of relative economy. Most of the railroad stations of the direct-connected class have only been in operation a short time. We have a number of central power stations though, where questions of relative economy show up on a similar basis, where we have been able to obtain more reliable data. When we look around and see the present stations operating with all types of engines, connected to various sizes of generators, and giving as a result in economy on the horse power output of all the way from 4 pounds on the most reliable to 8 and 9 pounds of coal on the medium ones, we see that there is indeed room for improvement. We have beyond question doubled this economy through a better, larger, and more economical type of engines, operated under better and more favorable conditions, also more economical, direct-connected generators, saving in loss of belting, shafting, friction, etc. Also of a combined, direct and positive saving, bearing all the way from 10 per cent. to 50 per cent. These figures are not theory, but are results obtained from actual practice, as is shown by data in the hands of the writer. As to whether it is going to pay to overhaul your plant as herein proposed, I will give one specific instance of the careful review of the case of a power plant of about 5,000 horse power. The company have become convinced that they could build a new power plant and scrap their present apparatus; increase their fixed charges thereby \$15,000 a year, and still have a net gain over their increased charges of \$25,000 per annum, and in addition to this a far more reliable and better operating plant, and increased capacity. I could continue enumerating examples of this kind, but believe if you give the matter careful consideration, you will be fully convinced on the subject yourself.

SUMMARY.

I feel that if any railroad man, either from a practical or business standpoint, after carefully considering the matter, looks around and sees the relative advantages of these plants, he will, beyond question, become an advocate of direct-connection, and his only wonder will be that he could be satisfied with any other type. When we realize that electric railway work has all been developed from a practical commercial standpoint in the past five or six years, it is almost beyond comprehension to realize the progress that has been made in the development of all the different types of apparatus, and more especially in the generator, for if we look back at the 30 or 50 K. W. machine which we used in the early stages, and at the 80 K. W. which was the standard about three years ago, and then consider the 1,000 and 1,500 K. W. generators, we can but feel that we are in an age of rare development and progress, almost beyond our comprehension. I feel that we have now reached what may be termed a point of standard commercial perfection on generators for power service of all descriptions, and that the next ten years will see very little change other than the perfection of minor details thereon, and instead of having a station operating from twenty to forty varying types and kinds of small generators, we will have a compact and modern plant of a few large units.

Trusting this report will lead to further consideration of the matter by all interested, it is

Respectfully submitted,

C. J. FIELD,
Committee.

The meeting voted to permit the reading of a paper "Magnetic Cut Outs," by W. E. Harris, of Camden, N. J., the inventor of a device of that nature. Herbert Claude and M. D. Law, of Washington, D. C., were invited to describe their experience with a mile and a half of underground conduit system in that city.

ELECTION OF OFFICERS.

The report of the nominating committee was then called for, and offered by Chairman A. E. Lang. The report was accepted as read, and to J. E. Rugg, of Pittsburg, was delegated the honor of depositing the ballot of

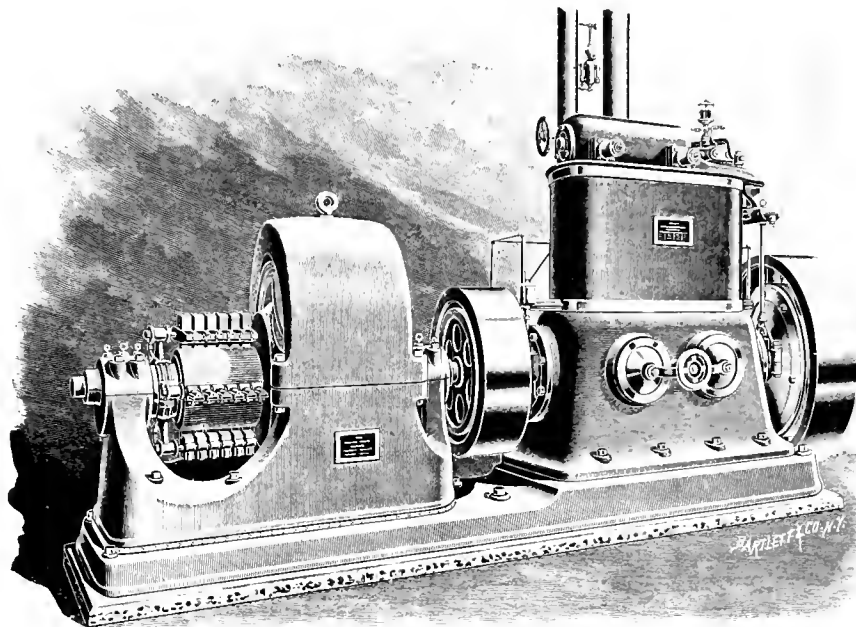

FIG. 1.

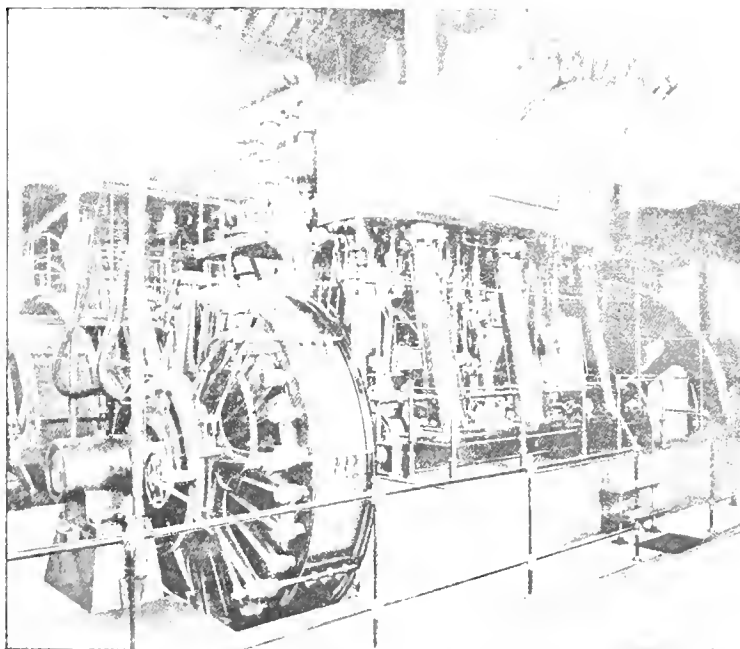

FIG. 2

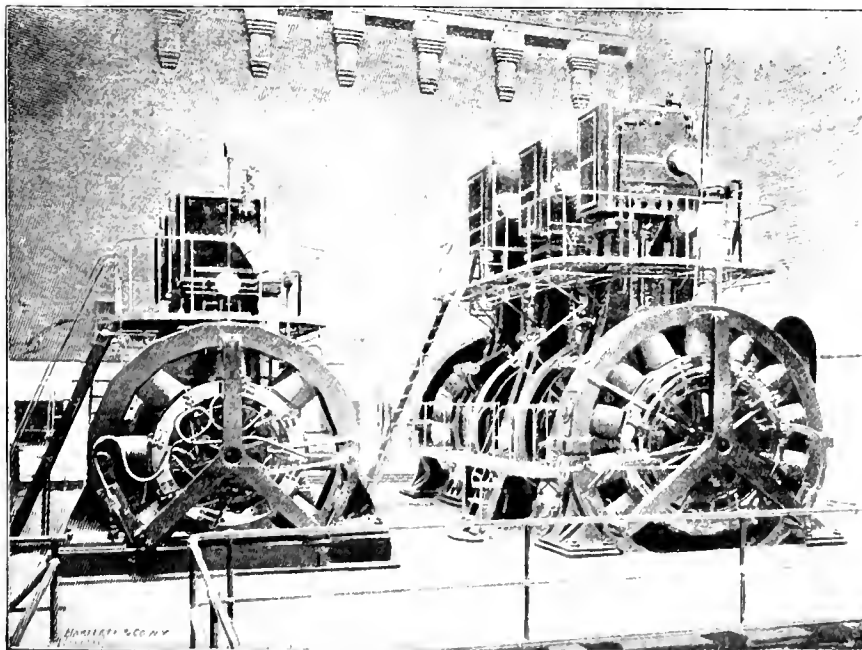

FIG. 3

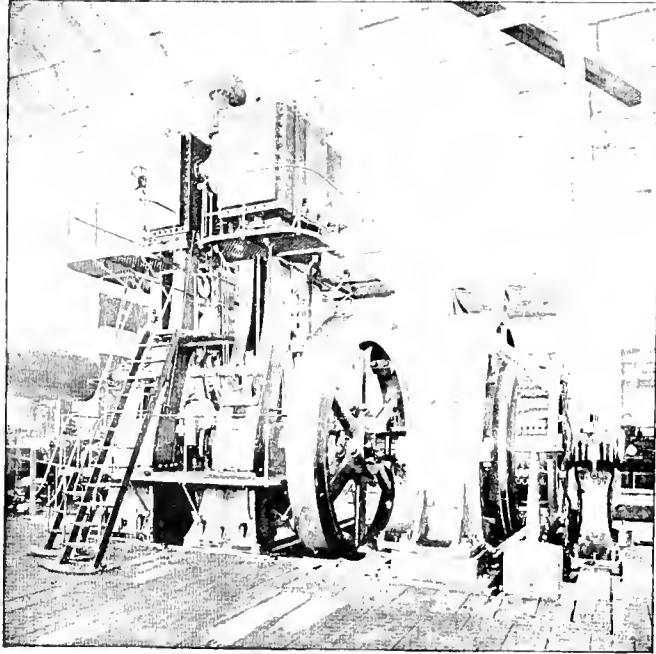

FIG. 4.

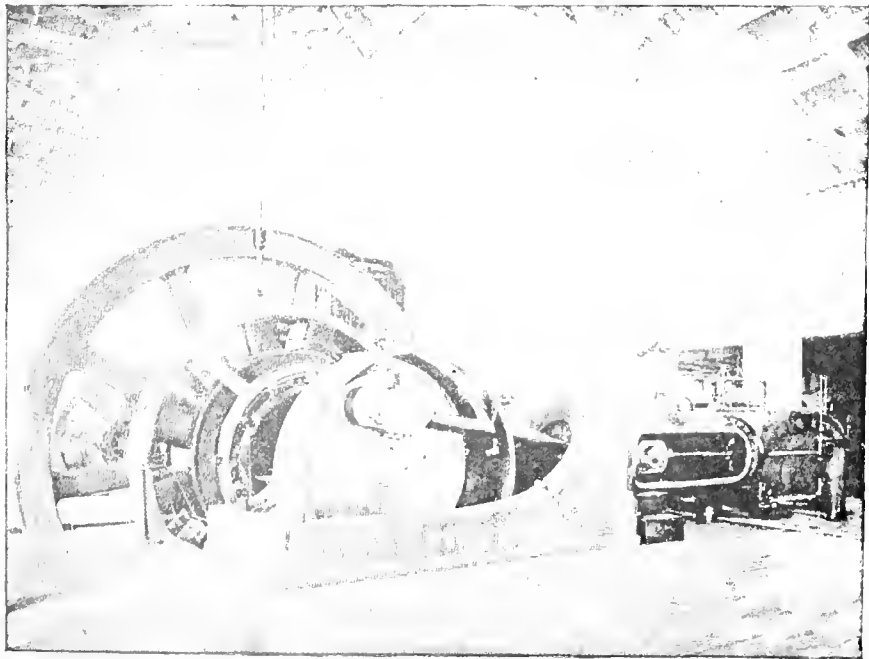

FIG. 5.

the association in the regulation silk hat. Joel Hurt, of Atlanta, was appointed teller, to insure a fair count, and Mr. Rugg's credentials proving gilt edged, the ballot was duly counted, and announced as follows:

- President, Henry C. Payne, Milwaukee.
- Secretary and treasurer, Wm. J. Richardson, Brooklyn.
- First vice-president, W. J. Stephenson, Washington.
- Second vice-president, J. R. Chapman, Grand Rapids.
- Third vice-president, Lewis Perrine, Trenton.
- Executive Committee: D. F. Longstreet, Denver; T. H. McLain, Indianapolis; Ed. Whittacre; W. Y. Soper, Ottawa, Ont.; and E. S. Goodrich, Hartford.
- Place of next meeting, Atlanta, Georgia.

Mr. Lang and Mr. Rugg were delegated to conduct the president-elect to the platform, which they did amidst great enthusiasm, cheers and applause. Mr. Payne said:



H. C. PAYNE, PRESIDENT ELECT.

"MR. PRESIDENT AND GENTLEMEN OF THE CONVENTION:—I sincerely thank you for the high honor conferred upon me by this election, and shall ever endeavor to maintain the high standard which has heretofore prevailed in this association. I will not now occupy your time with an effort at speech making, but once again express my thanks and appreciation of this demonstration of your confidence."

Mr. Hurt, of Atlanta, then thanked the association for having honored his city in its selection as a place for the next meeting; urged every member to be present next year, and assured the association of a fine Southern hospitality and welcome.

A communication was read from the editor of the Electrical Review, inclosing a recent editorial, urging the association to adopt a memorial and draught a law, making it a trespass for children to play in the streets occupied by street railway tracks. The suggestion was promptly and deservedly sat down on.

Mr. Lusher, of Montreal, expressed regret that the next convention was not to come to his city, but wanted to put in an early invitation for 1895. He facetiously

related the disappointment arising from the 1885 convention not being held in Montreal as intended, on account of the small pox epidemic there, but assured the gentlemen he had arranged not to let anything of the kind occur again, and said as there was but one company in his city the invitation was an unusually unanimous one.

Mr. Baumhoff, of St. Louis, offered a resolution instructing the executive committee to prepare a suitable ordinance to be sent each company, with a recommendation to secure its passage by city council, making it an offense for children to "hitch" on cars. This was directly in line with what has long been advocated in these columns.

Mr. Lang offered a resolution, gracefully and happily worded, tendering a vote of thanks to the street railway men of Milwaukee, and others, for the generous hospitality tendered the delegates. This was adopted in a way which left no doubt of the appreciation of the voters. Mr. Lang closed the throttle with a motion to adjourn, and as it passed the house the official sessions of the twelfth annual meeting came to an end. The members then hastened to their hotels to shake the wrinkles out of dress suits and get in readiness for the banquet.

THE BANQUET.

The spacious dining room of the Pfister hotel never wore more charming and rich adornments than were presented to the members as they entered at half past eight. Always elegant in its rich furnishing of marble and mahogany, the arrangement of the tables loaded with choice floral decorations, and with walls and windows banked with flowers and graceful palms, and brilliantly illuminated, made a picture long to be remembered. The attendance was the largest in the history of banquets, 265 guests sitting down to a splendid spread. There was an entire lack of formality, and managers of rival lines, and makers and sellers of competitive appliances all laid aside business interests and joined in the general feeling of good will and enjoyment. In front of President Longstreet, by whose side sat President-elect Payne, was a large and beautiful floral car, complete in all its parts and electrically lighted. The orchestra rendered its choicest selections and was frequently applauded.



The most unique and pleasing souvenir ever given the guests of the convention banquets was the tasteful souvenir silver spoon, which, daintily packed in cotton and enclosed in a neat box, was handed to every person as they sat down to the tables. The bowl of the spoon contains a picture in relief of the famous special car "200" of the Milwaukee road, and the words, "Milwaukee, Oct. 19, 1893." They were the personal gift of Mr. Payne and eminently characteristic of his thoughtful and generous nature, which was so apparent on every

hand during the entire convention. The execution of the spoon is very artistic, and old and young alike were delighted and surprised.

Toastmaster Longstreet gave each speaker a most happy introduction and the responses were excellent and listened to attentively throughout.

The first toast was "Transportation and Civilization," by Hon. J. G. Flanders, who vividly traced the intimate inter-dependence of the two.

Hon. Ogden H. Fethers responded to "The Street Railway Employes and the Public," in which he entertainingly pleaded for a better treatment of the street railway employes by the public.

It really seemed like the good old days of yore, as Winfield Smith's familiar, smiling face was seen as he rose to recall some extremely entertaining reminiscences of his management of the Milwaukee lines in the early seventies, responding to "The Earlier Days and Methods of Street Railways."

A pleasing feature at this point in the program was the singing of the National hymn, lead by the orchestra, with the audience standing.

Governor Peck, who was present, was called on, and in his usual happy vein well entertained his hearers. He was frequently interrupted by applause.

"My Electric Sweetheart," responded to by J. H. Stedman, varied the prose remarks incident to banquets by being expressed in verse. Electric technicalities were taken advantage of in the frequent use of puns, and the effort was generously applauded.

"The Press" was given by that veteran and successful Milwaukee publisher, Horace Rublee, of the Sentinel.

A fitting and graceful tribute was paid Wm. Richardson, who has, during the year, retired from active railway labor, to which that gentleman pleasantly responded.

Mr. Payne was also called for and made a few well-chosen remarks.

"The Street Railway Man of the Past, Present and Future," responded to by H. H. Windsor, editor of the STREET RAILWAY REVIEW, was the last toast of the evening, after which the time-honored singing of "Auld Lang Syne" brought everybody to their feet and the twelfth annual banquet to a close.

The local arrangements were the work of G. J. Melms, of the Milwaukee Electric, and were perfect. For the first time seats were assigned by number, avoiding all confusion and insuring the seating together of friends. In fact, the banquet arrangements, like all others, were so carefully planned and carried out that there was not a single slip anywhere.

FRIDAY.

The day was spent in trips of inspection to the power houses, an inspection of the line, and carriage rides about the city. Many of the visitors left at noon, and the balance that evening, for the World's Fair.

FOR THE first time the state of Louisiana was represented in convention. H. M. Littell, of New Orleans, having the honor to be the first.

THE LOCAL COMMITTEE.

The local committee, into whose hands fell the arrangements, may well be proud of their work. Nothing was left undone that could be done, and nothing was done which ought not to have been done. No money or pains were spared to make everything perfect. President H. C. Payne was chairman and the following were his efficient coadjutors: Superintendent G. W. Hommell, Assistant Geo. Kemmerlein, Superintendent Lynn, Superintendent Stikeman, Electrician Otto M. Rau, Treasurer Wheatcroft, Auditor W. L. Mason, Accountant Wm. Goltz, Assistant Purchasing Agent W. C. Vandenberg, and Purchasing Agent C. L. Jones, all of the Milwaukee Street Railway; G. J. Melms, the handsome manager of the Milwaukee Electric; Thos. J. Durnin, manager of the West Side, and A. McNaughton, superintendent; E. D. Hoyt, superintendent of the Wauwautosa Electric; and A. B. Myers, secretary of the Wauwautosa Dummy line.

THE LADIES.

The following were registered at the Pfister hotel:

Mrs. H. A. Everett, Cleveland; Mrs. F. A. Brownell, St. Louis; Mrs. Wm. Richardson, Miss Richardson, Miss Jenkins, Brooklyn; Mrs. J. Paul Baker, Baltimore; Mrs. F. Woodman, Haverhill, Mass.; Mrs. H. C. Higgins, Miss Henley, Marinette, Wis.; Mrs. J. G. Robinson, Boston; Mrs. E. B. Wyman, New York; Mrs. J. F. Reed, Mrs. S. W. Hoadley, Mrs. Seelye, Springfield; Mrs. M. F. Thompson, Carbondale, Pa.; Mrs. R. H. Beach, New York; Mrs. A. H. Allen, Philadelphia, Pa.; Mrs. Geo. Cutter, Miss Edith Kenfield, Mrs. H. H. Windsor, Chicago.

At the Plankinton were:

Mrs. W. J. Richardson, Brooklyn; Mrs. Stevenson, Miss White, Miss Clarke, Washington; Mrs. Hinds, Boston; Mrs. Shaffer, Baltimore; Mrs. Minary, Louisville; Mrs. Myers, Miss Morrison, New York; Mrs. J. R. Chapman, Grand Rapids, Mich.; Mrs. W. W. Bean, St. Joseph, Mich.; Mrs. Freyear, Gloversville, N. Y.; Mrs. N. H. Waller, Manchester, N. H.; Mrs. Poole, New York; Mrs. Taft, Columbus, O.; Mrs. McCleary, Birmingham, Ala.; Mrs. Sargeant, Mrs. M. Caster, Pittsburg; Miss Rogers, Albany; Miss Chase, New York; Mrs. Halsey, Mrs. Westlake, Mrs. Adams, Chicago; Mrs. Kelsey, New Haven; Mrs. Connette, Nashville; Mrs. Lawless, Miss Schenk, Pittsburg.

ENTERTAINING THE LADIES.

The preparations for entertaining the ladies were altogether the most complete of any convention yet held, and was most fully appreciated by the fair guests, who were made to feel at home from the moment of their arrival. A very thoughtful provision was in having, at both halls, a reception committee of ladies, consisting of the wives and daughters of the officers of the Milwaukee street railways, and included Miss Hommell, Miss Lynn, Miss Vose and Mrs. Hommell, Mrs. Bingham, Mrs. Sharp, Mrs. Wheatcroft and Mrs. Mason.

A special printed program gave the order for each of the three days, including street car rides, carriage drives, a visit to the Layton art gallery, and through the courtesy of Mrs. E. P. Allis and Mrs. William Metcalf, a visit to the superb private art collections at the elegant homes of these ladies. Everything which could possibly contribute to a delightful enjoyment of the city, had thoughtfully been provided, and was carried out in a thoroughly systematic and graceful manner. The ladies have occasion to long remember, with pleasure, their visit to the Cream City.

SOUVENIRS were numerous and unique. The Chas. Scott Spring Company gave out memorandum books; the Eureka Tempered Copper Company, a tempered copper medal; Railway Equipment Company, lead pencils; Jewel Belting Company, pocket books; E. S. Greely & Company, silver match safe; Munson Belting Company, Paige Iron Works and the Sterling Company, paper weights; the Peckham Company, pocket books.

EXHIBITS OF THE CONVENTION.**A Splendid Display—The Advantage of Plenty of Room was Very Noticeable and Appreciated
by Visitors and Exhibitors.**

THE HEINE BOILER was represented by some pointed pamphlets.

ALBERT HOPPIN, Chicago representative of E. P. Allis, was at the convention.

M. ROTHSCHILD, of the Genett Air Brake Company, was busy talking his specialty.

I. H. RANDALL, well known of Boston, was a REVIEW caller on his way from convention.

THE CHAPMAN VALVE COMPANY was ably represented by E. U. Buss, of the Chicago office.

THE SARGENT BRAKE SHOE COMPANY, of Chicago, had a nice exhibit of the Congdon brake shoe.

THE RELIABLE MANUFACTURING COMPANY, represented by F. C. Hinds, came in without exhibit.

A. R. COONRADT, maker of the Climax rail cleaner, at Rockford, Ill., was in attendance at the convention.

THE ILLINOIS STEEL COMPANY was represented by Mr. Brown, manager of the street railway department.

JOSEPH LEIDENGER, of the Dayton Manufacturing Company, of Dayton, Ohio, represented car furnishings and supplies.

A. G. WELLINGTON, of Chicago, and R. J. Mercer, of New York, represented the Griffin Wheel & Foundry Company.

JOSEPH E. LOCKWOOD, of Detroit, secretary of the Detroit Electrical Works, was present, meeting his many friends.

C. S. VAN NUIS, of Ajax specialties fame, was everywhere present among his large number of business and social friends.

THE POSITIVE LOCK WASHER COMPANY, of Newark N. J., was represented by Stephen D. Barnett, treasurer and manager.

GEORGE BAILEY, manager of the western department of the John A. Roebling's Sons Company, came early and stayed late.

C. D. MORSE, of the Morse Car Manufacturing Company, Millbury, Mass., made his first convention visit and was well pleased.

THE SHAWMUT FUSE WIRE COMPANY, of Boston, sent Sears B. Condit with the Shawmut trolley wheel and other brass specialties.

BENJAMIN TAFT, of the Industrial Mutual Insurance Company, of Boston, made himself very popular among the street railway men.

GENERAL MANAGER COX, of the Terre Haute Car Wheel Company, was kept busy with his many friends, assisted by D. B. Bean.

SECRETARY HATHAWAY constituted the exhibit, and a most popular one it was too, of the American Electrical Works, Providence, R. I.

THE STREET RAILWAY JOURNAL, New York, had a parlor at both hotels, with J. A. McGraw, H. W. Poole and H. W. Blake present.

GENERAL SUPERINTENDENT ROBINSON did the honors for the LaClede Car Company, St. Louis, and remained throughout the three days.

AARON C. WRIGHT, of the Hope Electrical Appliance Company, of Providence, R. I., was the convention representative of that concern.

FAIRBANKS, MORSE & COMPANY, of Chicago, showed a car and track jack of great strength and simple construction called the "Barrett."

E. M. TOUSLEY, of 139 Fifty-third street, Chicago, brought a model of his self-lubricating trolley, which promises to be a valuable device.

THE STEEL MOTOR, of Cleveland, was present and attracted considerable attention. The Short and the Sperry people were also represented.

M. E. STOCKWELL, manager of the Automatic Air Brake Company, of Grand Rapids, Mich., had no exhibit, but dropped into the hall for a few hours.

H. H. MINER, of the Verona Tool Works, of Pittsburg, was one of the well known supply visitors. He has many friends in the street railway circle.

C. KINTZ, of the Pittsburg Steel Hollowware Company, talked steel rolled gongs until his voice grew metallic and hoarse, unlike the Pittsburg gong.

J. H. ALLISON, inventor, of Elkhart, Ind., is the patentee of an electric railway trolley switch which is numbered 503,570. It is a device for an overhead switch.

THE PORTER TRAMWAY SWITCH COMPANY, of Cleveland, was represented by J. Y. Porter, with one of his patent switches, heretofore described in this magazine.

Street Railway Review

THE Q. & C. COMPANY, of Chicago, had a Bryant rail-saw in operation, and no railway man passing the exhibit could withstand the temptation to saw a little to see how it went.

GENERAL MANAGER HOADLEY, of the Bemis Car Box Company, Springfield, Mass., found plenty to keep himself busy, meeting old friends and customers from all parts of the country.

H. A. CROSSLEY, of the Crossley Brake Company, of Cleveland, was a convention visitor. His son, H. C. Crossley, was also present, and had a brake on the Milwaukee Street Railway, to the satisfaction of many interested inquirers.

THE RELIANCE GAUGE COMPANY, of Cleveland, was represented by George B. Clark, who told of the merits of the Reliance safety water columns and distributed missionary literature.

WM. A. HATHAWAY, of the American Electrical Works, Providence, met his numerous friends and customers in the street railway field, in which he finds some of his strongest admirers.

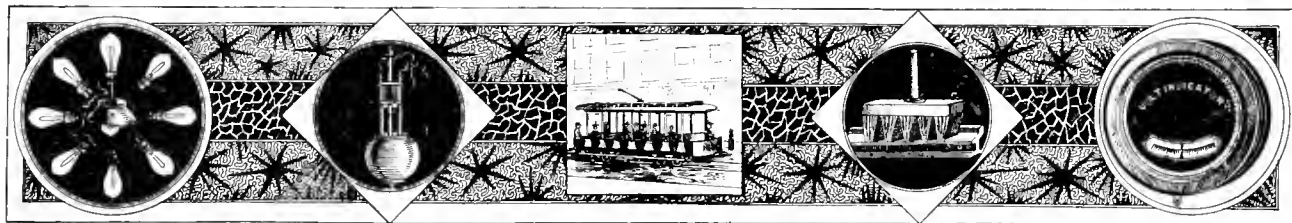

EDWARD BEADLE, of the Register Manufacturing Company, New York, of course was there, and three days was a pretty short time for him to meet and shake hands with his friends present.

THE PINKHAM CAR TRACK SANDER, of Boston, brought a neat sand box which had several points of excellence. It is claimed that eighteen prominent New England roads have been equipped with this box.

ADAMS & WESTLAKE, of 110 Ontario street, Chicago, brought two Bessemer sheet steel headlights, change slides, gong and bells, tornado central lamps and other goods. W. W. Willets in charge.

A. L. IDE & SON, of Springfield, Ill., came represented by Willis H. Post, of Detroit, who was particularly active in talking engines to those round about him. His card was everywhere present.

WILLIS L. ADAMS, of Willis L. Adams & Company, of 84 Adams street, Chicago, was a welcome visitor at the Exposition building. Mr. Adams has a host of friends in the street railway fraternity.

THE MARTYN TROLLEY, of Detroit, was represented by William Stevenson, agent, of 1650 Michigan avenue,

Detroit, and by the inventor. The trolley wheel is a self lubricating trolley and is a neat device.

C. H. BRAMPTON, of the Stever Rail Joint Company, found his nice exhibit missing on account of a railroad blunder. He had a girder rail joint on the floor, however, and did good work for his specialty.

THE R. BLISS MANUFACTURING COMPANY, of Pawtucket, R. I., manufacturer of Woods patent safety gate, was there, with Geo. S. Tingley. The device is meeting with great success, although but two montes old.

THE GIBBS ELECTRIC COMPANY, of Milwaukee, located in the Journal building, had a table full of specialties, among which was the Gibbs trolley, trolley hanger, the Gibbs overhead switches, and other specialties.

THE VIADUCT MANUFACTURING COMPANY, of Baltimore, showed their watchman system and told street railway men how to discover fires at street railway barns before it was too late. This display was operative.

THE CUTTER ELECTRIC & MANUFACTURING COMPANY

showed a fine operative exhibit of lamps and magnetic cut-outs, arranged on a temporary switch board. Mr. Cutter himself explained the beauties of the device.

HOLMES, BOOTH & HAYDENS, of New York, were represented by J. O. Crane who found himself much at home at the convention. His very many friends in the street railway and supply circles were glad to welcome him.

ALBERT TRUMPF, superintendent of the Exposition building, deserves and has the thanks of the entire association for his untiring efforts to make things go smoothly. He did not lose his temper or his head once during the trying ordeal.

THE PAWTUCKET BRASS FOUNDRY, of Pawtucket, R. I., had a table full of bearings, presided over by the genial Charles N. Wood. The Pawtucket article is made of the high grade brass "and," says Mr. Wood, "it's good goods."

THE MIAMISBURG ELECTRIC COMPANY, Miamisburg, O., represented by D. H. Allen, general manager, and A. L. Daniels, had on exhibition finished street railway commutators and segments of tempered copper in Section A, Exposition building.

THE ELECTRICAL INSPECTION DEPARTMENT.

IN the whole range of electric railway work there is probably no greater neglect shown than in the electrical inspection department. This department includes the inspection of the motors, trucks, and overhead work.

It is human nature to let a piece of machinery run until it will run no longer and the repairs on it are one-fourth, or more, of the original price of the machine. If this is a wise policy, from a financial standpoint, experience has failed to prove it. Inspection may be carried to two extremes. So much may be spent in wages for inspectors and repair-men that it would be cheaper to spend more for repairs and less for wages. On the other hand, as is generally the case, repairs may be so high that it would be cheaper to increase the pay roll, so as to diminish the bill for repair parts. As mentioned recently in an article on power house labor, "preventative cure" should be used around all electrical and mechanical apparatus. If only enough men are hired to take care of the serious troubles, so that the little ones have to be neglected, the company is on the road to big repair bills. Preventative cure is the cheapest even if it does increase the pay roll. Machinery is too costly to be allowed to go to ruin. The repairs on one motor after six months want of attention will pay the year's salary of an inspector.

One of the most remarkable records in the history of electric railroading is that made on the Chicago City Railway since they began operating their trolley lines last May. On this road there has been, at present writing, not a single burn-out, either of armature or fields, or an electrical trouble of any kind on any motor, since the start. The motors are Westinghouse single reduction, and the record is one to be proud of, both from the standpoint of the Westinghouse company and the City Railway. To make such a showing it was necessary to combine good motors with a good system of inspection. The latter we will proceed to investigate.

At one end of each of the three electrical lines is placed a trip inspector, who makes a hurried inspection of each car every round trip. He is in telephonic communication with the barn on his line. He carries a limited stock of repair parts and tools. These inspectors also take note of any repairs that may be needed when the car goes into the barn. At the barns are employed two experts, one for each barn, who are expected to go over each car carefully every night. Under both of these experts are eight mechanics to carry out his orders for repairs. This inspection department has charge of the motors, trucks, brakes, car wiring and trolleys, but not of the car bodies. Both trip and barn inspectors make reports to a purchasing agent, who orders supplies for this department. The total number of motors is 64. The time tables leave a reserve of ten per cent. The repair corps is rather large and the wages of these men must be figured in the repair account, but Superintendent

Bowen thought that it was best to err on the side of safety in view of the fact that the World's Fair traffic was extremely heavy and the men all new to the work. He states that the cost of repair parts on motors has not exceeded \$20 since the lines opened. In considering this record, it must be remembered, of course, that everything is new and repairs will be more frequently necessary after a while, but even with this consideration, it is a remarkable showing. It is also interesting to note that the nine-foot wheel base used on these motor cars was very unfavorably criticised at first, but has resulted in very few cracked flanges,—no more than would be expected with a six-foot base.

The overhead lines are gone over once every day by the head man in charge of them. A wreck wagon at each barn answers calls for electrical disablement as well as for the ordinary run of wrecks. Besides this, the line foreman has a construction wagon at his disposal.

Such is the system of electrical inspection now in use, and while it is not yet perfected, for the reason mentioned above, it at least shows by its results what systematic inspection can do.

ELECTRIC BELTS.

OUR good old friend, Doctor Quackenpills, says: "Electric belts, sir, I may state without reservation are totally inadequate as therapeutic agencies." However, Doctor Quackenpills may misapprehend the title of this article. All street railway men will instantly understand that electric belts are prime necessities of nine-tenths of the electrical plants of the country. In fact, the belting for electric power stations is required to be of the most perfect and special construction and design, in order to attain the great end of economy in the production of the power. It is with this in view that Charles A. Schieren & Company, of New York and Chicago, have exerted their efforts and produced their excellent belts. Particularly applied to this great and growing branch of commerce is the famous Schieren perforated leather belting, the popularity of which is increasing every day, and the best flattery of which is the numberless imitations against which the Schieren Company warns its friends. The perforation principle, which prevents formation of air cushions, and thus conduces to economy, is being practiced to advantage with small belts even, and all main driving belts of Schieren make are now perforated. Their new tannery at Bristol, Tenn., nearly completed, will give them the utmost facility for getting good stock, and plenty of it, so that future orders, no matter of what size, may be expeditiously executed. The special processes of tanning and the careful construction of the belts will speak for themselves when the pleased buyers are counting their dividends, gained through economy of the Schieren belts.

He hung upon the open car, he wildly fanned the air,
And shrieked as he paid his nickel, "Do you think this fare is fair?"

THE ELMIRA & HORSEHEADS ELECTRIC RAILWAY.

THE public gas, electric light, electric railway and water supply of Elmira, N. Y., are all under the ownership of the Elmira Municipal Improvement Company, although each of these branches is under a different corporate name. They are under the very efficient general management of Frederick A. Cheney, whose skill as an electrical and mechanical engineer, together with his business ability, have long since placed him in the front rank of station managers and constructing engineers. The Illuminating Company's station here described is of his design and construction and reflects great credit on its author. Mr. Cheney is blessed with a wife who takes a lively interest in her husband's work, and who has made a careful study of engineering and electrical problems. The following outline of the plant is from her pen.



F. A. CHENEY.

ELMIRA & HORSEHEADS LINE.

"A good illustration of a street railway hiring its current from a central station is that of the Elmira & Horse-

the United States, built for furnishing light and power, has a special power plant to drive railway and stationary motor generators. This consists of two McIntosh & Seymour compound condensing railway engines of 400-horse-power each, either one of which is ample to do the work, so that the generating plant is really a duplicate one; the engines being so arranged that a short shaft between them can be clutched on to either engine, and from this shaft are driven generators for furnishing current for stationary motors—an idea that might be copied by street railway companies to their advantage.

The Elmira & Horseheads Railway has twenty-three miles of track, with sixteen motor cars and eighteen trailers; double track through the city with single track to Horseheads, six miles. The track is of heavy girder rail. The overhead work is to be reconstructed when it will become one of the best equipped roads in the east."

THE MCINTOSH & SEYMOUR ENGINES.

The REVIEW has fully described the McIntosh & Seymour machinery at the World's Fair. The engines in this station form an exhibit of which they are no less proud. The engine most worthy of notice is the vertical triple expansion in the lighting service. It has four cylinders; one high pressure, one intermediate and two low pressure, the low pressure being tandem with the other two. The rear upright is made heavy enough to serve even though the steel columns were removed. There

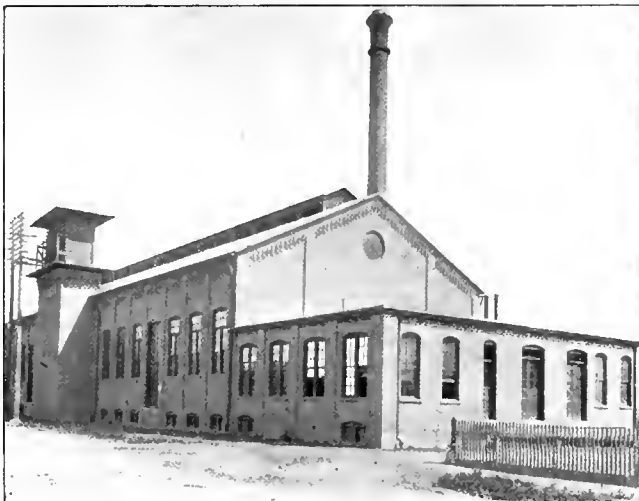

ELMIRA POWER HOUSE.

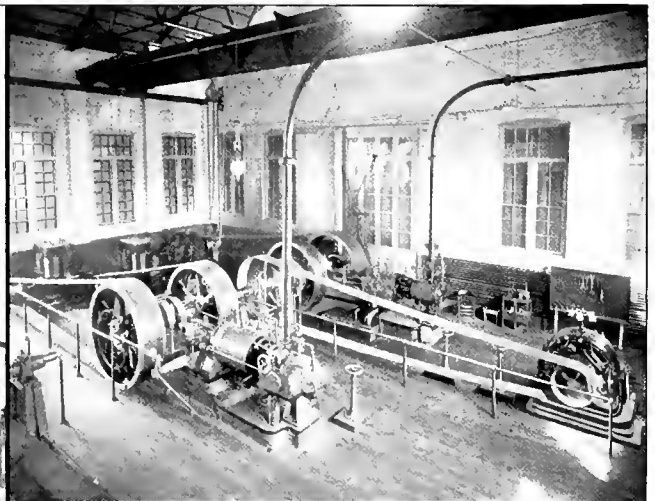

THE RAILWAY GENERATORS.

heads Railway, of Elmira, N. Y. This company a few years ago entered into a contract with the Elmira Illuminating Company, at a fixed price per car day of seventeen hours, to furnish current to operate its cars. This contract has proved advantageous to both companies; relieving the railway company from the expense of employing skilled labor and the petty annoyances attending the generating of railway current. The service in this case is certain and all that could be wished for.

The accompanying illustrations are of the new central station of the Elmira Illuminating Company just nearing completion. This plant, one of the finest in

are no stuffing boxes between cylinders, the packing sleeve consisting of a long tube babbitted to fit the piston rod. The cylinders are provided with the regular double valve arrangement whereby the opening and closing of the exhaust and the admission of the steam is regulated by fixed eccentrics driving the main valves, and the cut-off is regulated by an auxiliary valve driven by the governor, this valve being placed on all the cylinders. In fact the whole engine is a combination in a new form of the principles and devices, already so well known, that have characterized McIntosh & Seymour engines in the past and made their success so great.

LONDON'S METROPOLITAN HADES.

THE SANDUSKY RECEIVERSHIP.

THE London Financial Observer states that a recent spell of hot weather played havoc with the income of the District Railway Company (underground), and that with a temperature of over 80° in the shade, the

ALL things considered, the recent appointment of Captain J. C. Gilbert, as receiver for the Sandusky, Milan & Huron Electric Railway, was the best for all concerned.

The company was formed last autumn and began construction. It was capitalized at \$100,000, of which \$80,000 has been called in and the estimate of the cost of the line was \$155,000. The balance of the necessary amount was to be raised on the sale of \$75,000 in 6 per cent bonds, at par.

When the bonds were first issued, Cleveland capital agreed to place them, but the floating was deferred until August, when the stringency in the money market worked the failure of the scheme.

The men at the back of the enterprise are solvent and as the road is a valuable property, it is worth more than it failed for. The receivership simply extends the time for the sale of the bonds and the receiver has power to operate the road.

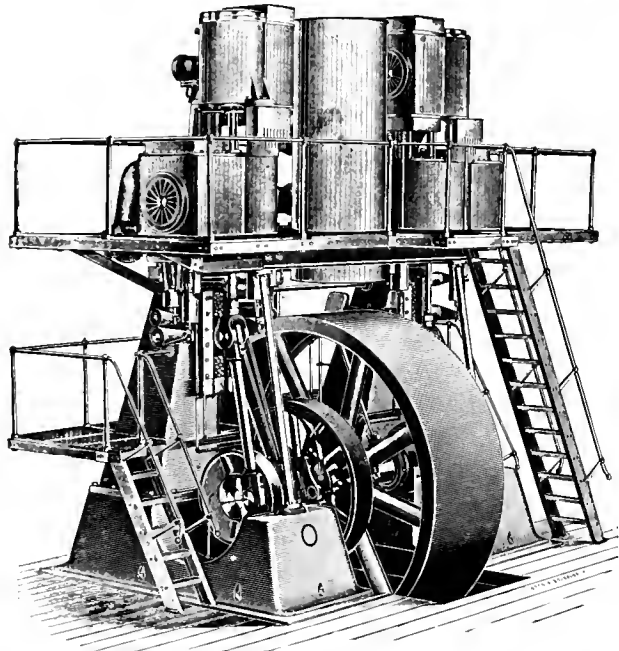

MCINTOSH-SEYMOUR TRIPLE EXPANSION.

SIEMENS, of Berlin, show in their scenic theatre in Midway Plaisance, some beautiful electric illusions and effects, illustrating the experiences of a day in the Alps from early dawn to sunset. The curtain rises on a star lit scene upon which the sun begins to glow, lighting first the mountain peak causing, it to glow in the red sunlight. Soon the mountain gorges, the chalets and the forests are in full light. Gradually the morning gives way to a midsummer day, glittering on the water falls and on the snowy summits of the distant mountains. Dark clouds then begin to gather and a mountain storm rushes through the valley. Thunder rolls and lightning flashes and the full effect is reached of an Alpine storm. Then sunset comes stealing over the mountain and the scene is

wayfarer has preferred to take the bus rather than brave the Metropolitan Hades, in spite of the loss of time involved.

If this is the way it seems to an Englishman at the mild temperature of 80°, what would an American public do in the higher temperatures common here.



ON THE LINE—ELMIRA & HORSEHEADS ELECTRIC.

AN agile darkey not long ago jumped from the top of the Eighty-ninth street station of the Third avenue Elevated in New York. He fell and rolled over in the mud two or three times but when an officer approached, he jumped to his feet and disappeared.

lighted by the opposite glow until gradually the stars appear. Moonrise next floods the scene in silvery light, then darkness spreads over the valley and the Tyrolese warblers sing their plaintive songs as the curtain falls. The scene is beautifully arranged, by Arthur Schwartz.

PARIS PUBLIC CARRIAGES OF THE PAST.

M. GUIZOT, in his interesting and highly trustworthy history of civilization, declares that no world-moving idea has ever been produced that has not received its beginning or its shaping in France. The beginning and shaping of intramural transit is no exception.

H. Meyer, of Paris, in part from that city of refuge, the "Dictionnaire Larbuse," and in main from other sources, has written a very interesting history of the Parisian public carriages. The illustrations are gathered from the originals, and treat the subject in a thoroughly

and other liveried people and the working folk should not be allowed to enter.

The first line was run from the gate Saint Antoine to the Luxembourg, from the street Saint Antoine (opposite the Place Royale) to the street Saint Honore (opposite the church Saint Roch.) Others made the tour of Paris. The gentility, however, mixed itself up, and soon the fashion was to have these carriages decked and painted with great elegance, driven by lace-trimmed coachmen and directed by lackeys in pompous livery. Great dudes were these seventeenth century conductors. As useful as these carriages were the fashion changed as fashions will, and they passed out of existence.



THE COUCOU.

THE 60-PASSENGER CARRIAGE.

THE BEARNAISE.

Parisian manner. No less a personage than the great Pascal is credited with the introduction of public conveyances in Paris. Pascal needing pecuniary aid, transmitted the idea to the Marquis of Roanne, who associated in the first Parisian street car company a number of his titled and wealthy friends. The first vehicles employed were carriages, because the coaches used in interurban transportation were too heavy for the then miserable, muddy, and generally disreputable streets of the metropolis. The price was five sols (sous), about five cents.

Thus it was two hundred and twenty-two years ago, or in 1672, that the first public conveyance was effected

Not until 1828 did the originators of the omnibus idea gain their point and silence the Parisian kicker whose voice was heard in the land. The prefect of police in 1819 went on record saying that the stoppage of omnibusses on the highway would so congest travel that the idea must be abandoned.

In 1827 Sieur Baudry obtained a charter for an omnibus line and put into execution in Paris his experience gained at Nantes and at Bordeaux, and in 1828 the first line was put in commission and baptized "omnibusses." The first two lines traversed the boulevards and ran at fifteen minutes headway, starting from the corner of the



THE TRICYCLE.

THE ECOSSAISE.

THE WHITE LADY.

at Paris. The carriages left at fixed hours. These accommodations were only semi-public, as the charter read that they were established "for the accommodation of a large number of persons little accommodated, such as pleasure seekers, infirm gentlemen, and others not having the means to travel in bath chairs (sedans), or in private carriages, because the latter costs them a pistole per diem."

The charter was granted with stipulations that are characteristic of the epoch, "that soldiers, pages, lackeys,

Rue de Lancry, one going to the Bastille and the other to the Madeleine. Instead of gong or whistle, the signal for departure was given in a highly aesthetic manner, from a species of concertina, operated by a pedal at the driver's discretion. No conductors were employed at first, and entrance was provided at the rear. A strap, operated by the driver, closed the door, and warning to stop was made by a cord within reach of the passenger.

A guide book for the city, dated 1835, mentions the following styles of vehicles: Dames blanches, the tri-

cycle, the favorites, the ecossaises and the batignollaises, the hirondelles (swallows), the gazelles, the excellentes and the constantines appeared later. The dame blanches were named from a successful opera and the ecossaise from an African expedition. The others are self-explanatory. The various names betokened the routes of the busses, and each line differed from the other in color of the vehicle, horses and livery of the attendants. All decorations and liveries were suggestive of the names carried. A weather cock projected above the conductor showed the destination of the vehicle. All these carriages carried fifteen persons without roof seats. The fifteenth sat back to back with the conductor. About 1835 all Paris was astonished by the appearance of an omnibus capable of holding sixty persons and drawn by eight horses.

The tricycles, see illustration, were curious affairs, built to outwit a "wheel tax" levied on all four-wheeled vehicles. But the law was changed to suit the conditions and the enterprising contractor went again on all fours. The coucous, see engraving, were short-lived vehicles, disappearing about the time of Balzac's death. The

SAN FRANCISCO'S GIGANTIC COMBINATION.

FULLY alive to the advantages of union, the San Francisco cable lines have, like the Irishman's goats, swallowed each other and are now one. The Market Street Cable Company, controlled by the Southern Pacific and managed by J. L. Wilcutt, and the Omnibus Cable Company are the parties to the merger.

A combination of this kind must needs be brought about by a man of finesse and ability and H. E. Huntington was the man.

The capital of the new corporation is fixed at \$16,000,000, and divided into 160,000 shares. This will reduce administration expenses at a rate of 6 to 1, executive offices to the number of six having been previously maintained.

The following lines are to be under this one executive head:—

Calencia, Castro, Haight, Hayes, McAllister and Fifth streets lines, operated now as the Market Street Cable Railway System; Park & Ocean Steam Railway; Turk



THE CAROLINE.

THE PARISIENNE

THE MODERN OMNIBUS.

modern tilt cart is its successor. A rapid increase of lines and cutting of fares, nearly drove the omnibus lines to destruction, until French wit devised the transfer ticket in 1836. By means of transfer, one may almost make the tour of the city for 30 centimes. The roof-seat omnibusses at 15 centimes date from 1853, and in 1855 the different lines were combined into the Compagnie Generale des Omnibus, or the Consolidated Omnibus Company, which now controls the system of Paris.

SIoux CITY'S CABLE CHANGES HANDS.

BY special order of the court, Assignee Hubbard has secured a court order by which John Peirce becomes owner of all stocks and bonds of the Sioux City Cable Street Railway Company.

D. T. Hedges and John Pierce owned the road in common, the former holding 1,720½ shares of stock and \$150,000 in bonds, which were never sold. These holdings were used as collateral in securing a \$75,000 loan, and Mr. Pierce made a proposition to cancel this debt against Hedge's estate if the stock should be transferred to him.

Street Line, and Sixth Street (Central Railway); Mission Street Line (City Railway); Howard street, Third and Montgomery street lines, and Post, Ellis and Grove, etc., cable lines of the Omnibus System; Folsom, Fourth and Kearney street, and Market street horse cars of the North Beach & Mission. The new company will thus reach every part of the city and extend from North Point almost to the San Mateo county line and from the bay to the ocean.

The Geary Street Railway was invited to come into the fold but regarded it as better policy to remain out. The pro rata for the different component companies will be on the basis of the earnings for the past five years. The Market Street Company will predominate, eight out of ten.

Extensions will be made on the entire system. Fewer cars will be run on parallel lines, but the time will be so arranged that the headway will be three minutes.

The officers of the San Francisco Cable Companies Consolidated are: H. E. Huntington, president; J. L. Wilcutt, secretary, and M. Haley, superintendent.

OLD PARTY.—What d'ye blow that dinged whistle for, CONDUCTOR.—To start the car, sir. OLD PARTY.—Ah, I see, have to scare them horses to make 'em go.—Puck.

A MANIAC on an alley L train became dangerous and required three guards to hold him until the police arrived.

CABLE ROAD SWITCH.

THE accompanying illustration shows a patent of W. N. Colam, of London, on a cable tramway switch, arranged to make it impossible to turn the slot and

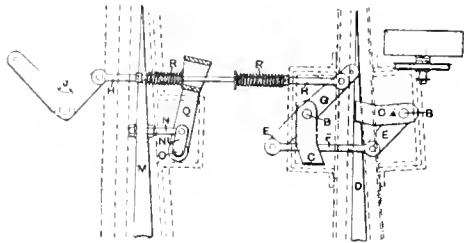

the track switch in opposite directions. An inspection of the drawing will fully explain the working.

THE FUNNY STAR.

IF Kansas City is more proud of one thing than another, this self-gratulation centers on its fine rapid transit facilities. One day lately, the Kansas City Star editor saw the accompanying pretty picture perpetrated, after a bad night, by the New York Herald's obituary editor. The Star man unwound as follows:—

“This monster, shown in the accompanying illustration, reproduced from the New York Herald, is a picture of a Broadway cable car in use in that city. There seems to be criminal ignorance or carelessness in permitting such a ferocious variety of a cable car to be used in a civilized city. How can Americans

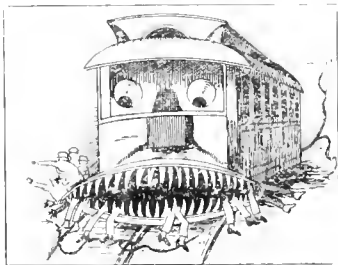

consent to allow their wives and children to be exposed to the necessity of meeting and even employing such an untamed steed?

“There are tame cable cars which New York might procure, handsome, useful conveyances, pleasant to ride in, easily controlled, and perfectly harmless. Why their city council should have selected this malignant type, with its flat nose, cruel eyes, and deadly teeth, is an inexplicable mystery. It seems that any corporation, however unintelligent, might know from one look at this creature, that he was not the sort of a cable car that it should have given a franchise to. In the face of the reign of terror which seems to have settled over that city in consequence of the blunder made in selecting wicked cable cars, it might be no more than merciful for the west to send a few enlightened missionaries to that suffering metropolis, to carry tidings of the good cable cars which have for years been domesticated here, and have been found so eminently satisfactory on Kansas City's hills and Chicago's flat expanse, on San Francisco's small mountains and over the streets of Saint Louis.”

Why is this thus, Father Knickerbocker?

SUNDAY TRANSPORTATION IMPROVING IN TORONTO.

THE recent defeat of the Sunday street car at Toronto seems to have only stimulated its champions to renewed effort, and has resulted in the formation of a Citizens' Sunday Car Association. One of the immediate results of this association has been the establishment of several lines of busses, which run only on Sundays, passing over the prominent street car routes, and from present indications it is expected a complete Sunday service will be given to and from all parts of the city.

No fares are collected, but a box is placed in a conspicuous place inside the buss, and proceeds, which are entirely voluntary, are given to some charitable institution. So far the service is good, and will improve as it becomes better organized. The method of evading the Sunday law is as unique as it is successful, and there can be little doubt that another election will win over those 1,003, with some to spare.

WESTERN AGENCY OF THE BALL ENGINE.

WHEN the REVIEW man took his assignment to go to 506 Rookery, to interview the western representative of the Ball Engine Company, of Erie, Pa., he expected to find a young man. In fact, in railway circles he has been so used to find young men that it has become the expected to find them. In James H. McBrier, however, who commands the important position of Chicago representative of a firm so well known as the Ball Engine Company, the REVIEW was surprised to learn that the gentleman was but twenty-seven years of age.

“I haven't a very eventful history,” said Mr. McBrier. “I was born twenty-seven years ago at Allegheny, Pa., which is probably the most important event in my life. My early school days were spent at that city. My later education acquired at Phillips Andover Academy. I was about to enter Yale when circumstances forbade.

“I went into the Ball Engine Company's employ, that was my first business experience, and became cashier at the home office at Erie. Last year I came to Chicago, and have been here since, taking the western management in September. So you see my life, so far, hasn't been very romantic, not even romantic enough to be married.”

Mr. McBrier is an affable young man, thoroughly acquainted with his business and full of enterprise and pluck.

MARSEILLES has an electric railway in successful operation. The line is the most important installation of the kind in France and is about four miles long. Eight cars on week days and twelve on Sunday is the equipment, and each car carries from forty to fifty passengers. The speed varies from six to twelve miles an hour. The line is on the overhead system with rail return.

A STREET RAILWAY MAN TO THE RESCUE.



OLD TIMERS in Kansas City tell a good story of T. J. Kelley, once secretary and treasurer of the Corrigan Street Railway Company. The treasurer kept his funds in the Kansas City Savings Bank. That is, as much of the funds as his pride would allow, because then, before 1871, pennies were considered rather small and useless coins, and people were actually ashamed to use them for ordinary petty business transactions. So Kelley put them in sacks and stored them like records in the company's vaults. The street railway fare boxes became a regular dumping ground for pennies, and the pile of sacks grew incredibly. The panic of '71 brought among other things a run on the Kansas City savings banks. Several other like institutions had suspended, and fears were entertained for the Kansas City, also. Finally the run came, and depositors were lined up for blocks, waiting their turns with the tellers. The situation was alarming, and baskets full of gold were going out, when a happy thought struck Kelley. Without delay he went to the police station and borrowed eight officers. Then loading eight sacks of coppers, with the other coppers as guards, on a wheelbarrow, he took the procession to the bank. The sacks had originally held gold, and each was plainly labeled \$5,000, in big, black letters.

Arriving at the bank, an old darkey who had come to withdraw his "dollah and sebenty-two cents," remarked, "Why, Mistah Kelley, wh' foh yo' put all dat money in when de bank's gwine bust?" Kelley replied, "That's all right. The bank won't bust. I can put more money in here in one day than you people can draw out in six months." This settled it. The display of Kelley's confidence quieted the crowd.

The sacks contained just \$40 each.

no means, be an uncommon sight in our power stations. Taking readings at intervals means a good deal of trouble and uncertainty, whereas the record of a reliable recording instrument shows the actual variations as they occur.

ENGINES IN THE TORONTO, CANADA, POWER HOUSE.

THE Toronto electric railway power house contains six 600-horse-power engines of the high speed type. Four of these were built especially for this plant. The fly wheels are 9 feet diameter by 25-inch face. The engines are cross compound, the low pressure cylinder being fitted with Corliss valves. Independent condensers are used, together with automatic relief valves to provide for the exhaust in case the vacuum fails in the condensers. The condensers can also be thrown in while the load is on the engines.

A thirty-inch steel pipe brings water from the lake for the condensers and the discharge is into a 30-inch brick sewer. The supply pipe is below the water level all the way.

DISTRESSES THE HORSES.

SOME of Henry Berg's followers in England have prepared a resolution which they are endeavoring to have adopted and published by the directors of the London Omnibus Companies, "in the hope of producing a good effect on thoughtless and unfeeling passengers." It reads thus:

"KINDNESS TO ANIMALS -- It is respectfully requested that passengers will abstain as much as possible from stopping the omnibus on hilly parts of the road, as doing so distresses the horses."

The only improvement which extreme humane suggestion could imagine would be for the passengers not to ride at all, in which case the "distress" would certainly be

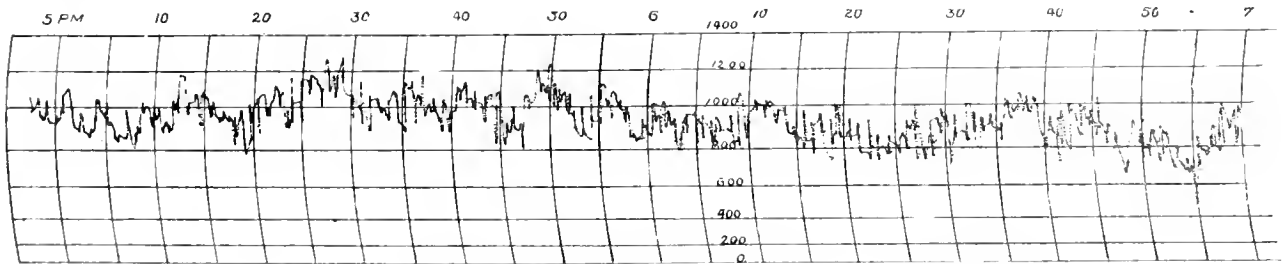

DIAGRAM FROM RECORDING AMMETER, CLEVELAND.

RECORDING AMMETER ON THE CLEVELAND CITY RAILWAY.

THE accompanying diagram is a recording ammeter record, taken at the west side power house of the Cleveland City Railway. The ammeter is the invention of Joseph Wills, the assistant engineer. The record is noticeable as not showing as extreme a variation as is usually expected in a plant of this size. The convenience of recording ammeters and watt-meters is coming to be recognized, and in a few years they will, by

reduced to a minimum. What our good but slow English friends need is an electric or cable line, in which the element of distress is wholly wanting.

JOHN E. NELSON, town councillor of Glasgow, and **John Morrison**, a large contractor of the same city, spent some time in Chicago investigating the street railway systems. They were properly accredited representatives of the Glasgow council and, as such, were entertained by the municipality. Both enthusiastically praise electric traction.

STREET RAILWAY LAW.

EDITED BY MR. FRANK HUMBOLDT CLARK, ATTORNEY AT LAW, CHICAGO.

Franchise to Occupy Entire Street with Tracks.

Where a street is occupied by two street railway tracks and numerous poles and wires, injunction will issue at suit of abutting property owners, against the construction of a third track and additional poles, which would create unnecessary interference with the ordinary uses of the street, although such construction has been authorized by the city council.

The court said: According to the evidence, as appears from the record of this case, Second South street is one of the principal business streets running east and west, and at the date of the granting of the franchise to the defendant, and of the trial of the cause, there were in operation upon that street two railroad tracks, which were located in the center of the street with a line of poles between them. There were also many electric light, telegraph and telephone poles placed in line on each side of the street about four feet from the sidewalk, and on these poles were stretched numerous electric wires. The two tracks in operation were constructed with T-rails, which project several inches above the surface of the street, and render the crossing of the tracks with vehicles difficult and dangerous, the street not being paved. The appellant proposed to construct its track in a similar way on the north side of the present track, and to erect additional poles, which would still further obstruct the ordinary travel and render the respondent's property less accessible for business purposes. The tracks already upon said street afford ample facilities to run all the cars necessary for public convenience, and the construction of the third track would be a serious impediment to the ordinary mode of travel, as it would not leave sufficient space between the outside rails and the gutter for vehicles to pass each other with safety. Where the track privileges of one company on a city street are sufficient for the business of two or more companies, they should all be required to use them in common. The construction of an additional track, under the circumstances of this case, would be an unnecessary obstruction to and interference with the ordinary use of the street, and a special injury to the property rights of the abutters, and on proper application a Court of Chancery may grant injunctive relief. In such a case an abutting owner need not stand by and see his property injured without having any means of redress. (Supreme Court of Utah. *Dooley Block vs. Salt Lake Rapid Transit Company*. 8 Notes of Cases, 60.)

Passenger Carried Beyond Destination—Negligence of Street Car Company—Injury by Being Pushed from Car by Other Passengers.

The argument for appellee proceeds upon the assumption that the wrongful act of appellant, in carrying the appellee beyond his place of destination, was the efficient cause of the injury, without which it could not have happened; that appellant had knowledge of the danger into which appellee was being carried by being taken beyond

Emerald avenue, and was liable, no matter what other causes operated to produce the injury. Undoubtedly, if appellant knew that if it carried appellee past Emerald avenue, he would be thrown off and injured, and had such knowledge in time to have prevented it, its liability would not be questioned. The failure to stop the car at Emerald avenue had in itself no tendency to throw appellee off the car; the accident was the direct result of the sudden pressure by some of the passengers to get off of the car as it approached Halsted street, and not because the car had passed Emerald avenue without stopping, or because of any other negligence, if it be negligence, by the appellant, than that it permitted the car to become crowded with passengers. And whatever fault appellant was guilty of in permitting the crowd, appellee, knowing the crowd was there, shared in it, and the fault being mutual, he cannot complain if injury resulted because of a sudden movement of one or more of the passengers, for no cause for which the appellant was directly responsible.

(Illinois Appellate Court. *Chicago City Railway Company vs. Considine*. 33 Legal Adviser 249).

Injury to Child—Driver Starting Car—Notice of Intention to Become Passenger.

A street railway company is not liable for injuries to a boy of seven years, by the starting of its car while he was attempting to get upon the front platform as a passenger, where no notice was given to the employes in charge of the car, and they had no knowledge of his intention and attempt to become a passenger; the driver is under no duty to look for passengers while engaged in attending to his horses.

(Supreme Court of Pennsylvania. *Pitcher vs. Peoples Street Railway Company*. 154 Pennsylvania Reports 560).

Person Thrown from Car Rounding Curve—Standing on Platform—Crowded Condition of Car.

A street railway company is liable for injuries to a passenger, who remains standing upon the platform with the knowledge of the conductor, because the car is so crowded that he cannot find a seat inside, and is thrown off while the car is rounding a curve, by the negligence of the persons in charge of the car in failing to check or slacken speed in approaching the curve.

(Supreme Court of Minnesota. *Brusch vs. St. Paul City Railroad Company*. 55 Northwestern Reporter 57). *City Employee working in Street—Injury by passing Car—Failure to give Warning.*

An employe of the city engaged in laying water pipes under the tracks of a street railway is lawfully in the trench dug for that purpose, since the consent of the city to the occupancy of a portion of the street by a railway company does not destroy its right to repair or construct public works.

A street railway company is liable for injuries to a laborer engaged in laying city water pipes under its tracks by the moving of a car across the ditch without notice to the men at work in it, where on all previous occasions notice has been given and such notice was a reasonable and prudent act under the circumstances.

(Supreme Court of Pennsylvania. *Owens vs. People's Passenger Railroad Company*. 26 Atlantic Reporter, 748.)

Defective Appliances—Injury by giving way of Handle on Car—Complaint failing to show Relation of Carrier and Passenger.

In an action against a railroad company for injuries to the plaintiff by the giving way of a handle on a car, which plaintiff took hold of while entering it, a complaint which fails to allege that it was at a station provided for passengers, or at a place where it was usual or customary to receive passengers, or that plaintiff was invited or knowingly permitted to attempt to board the car, or that he was in any way accepted as a passenger, fails to show any relation existing between the parties devolving on defendant the duty towards plaintiff of maintaining its car in repair.

(Supreme Court of Alabama. *North Birmingham Street Railroad Company vs. Liddicoat*. 13 Southern Reporter, 18.)

Street Railway as Common Carrier—Care required—Burden of Proof as to Negligence in case of Personal Injury.

Street railway companies are common carriers of passengers and are liable, as other common carriers, upon common law principles. Common carriers, for the protection of their passengers, are bound to the exercise of more than ordinary care; they are bound to exercise extraordinary care and the utmost skill, diligence and human foresight, and are liable for the slightest negligence.

Where a passenger, without negligence on his part, is injured by the derailment of the car in which he is traveling, the carrier, to overcome the presumption of negligence caused by such derailment, must show that the accident was produced by causes wholly beyond its control and that it has not been guilty of the slightest negligence contributing thereto, and that by the exercise of the utmost human care, diligence and foresight the casualty could not have been prevented.

(Supreme Court of Nebraska. *Spellman vs. Lincoln Rapid Transit Company*. 20 Lawyers' Reports Annotated, 316.)

Grading Street—Petition by Property Owners—Action against Street Railway.

Petitioning a street railway company to grade the street through which its tracks run, to "established grade" will deprive abutting property owners of the right to recover for injuries to their property by being left below the street grade if the established grade is followed.

(Missouri Court of Appeals. *Pratt vs. Home Street Railway Company*. 49 Missouri App. Reports 63.)

Driving on Track in Front of Car—Care Required of Persons in Control of Car.

Persons getting in their carriage upon coming out of a place of amusement, knowing that there is a large crowd, many of whom will go upon street cars which are in position waiting to receive them, are recklessly careless in leaving a safe unobstructed way and crossing over onto a track which they know is about to be used by the cars, without looking back or taking any precaution for their safety.

A street railway is liable for injuries to persons in a carriage who have, by their negligence, placed themselves in a perilous position on the track, where the employes in control of the car could have avoided the collision with the means at their command, after they saw or could by the exercise of ordinary care have seen the peril.

(Kentucky Superior Court. *Central Passenger Railroad Co. vs. Chatterton*. 14 Kentucky Law Reporter 663.)

Injury by Starting of Car—Signal Given by Unauthorized Person—Liability of Company.

The fact that the signal for starting a street railway train, causing one who is attempting to get on to be thrown down and injured, was given by an unauthorized person, will not relieve the company from liability, if the conductor by due diligence could have prevented the moving of the car and avoided the injury by countermanding the signal, or otherwise, although he did not know that anyone was attempting to get on the car.

(Supreme Court of Illinois. *North Chicago Street Railway Company vs. Cook*. 33 Northeastern Reporter 758.)

Car Injuring Person who has Fallen in Street—Verdict Contrary to Evidence—Contributory Negligence.

In an action against a street car company for personal injuries, plaintiff alone testified that while riding on horseback his horse fell, throwing him to the ground some 150 feet ahead of the car, and while lying there the wheel of the car ran over his arm. Four disinterested witnesses who were riding on the car in a position to see the accident, testified that the horse fell by the side of the car. *Held*, that it was an abuse of discretion not to grant a motion to set aside the verdict as being contrary to the evidence.

In such case, the defendant having alleged contributory negligence, that question should have been submitted to the jury, even on plaintiff's theory of the facts; and it was error to charge the jury to the effect that there was no claim on the part of defendant that plaintiff was guilty of negligence, and that if plaintiff's version was correct, the only question to determine was whether defendant's driver was guilty of negligence.

(Supreme Court of Wisconsin. *McCoy vs. Milwaukee Street Railway Company*. 52 Northwestern Reporter 92.)

*Reasonable Regulations—Passenger Refusing to Comply
—Payment of Fare on Entering Car.*

In an action against a street car company for ejecting a passenger, it appeared that defendant's rules required passengers to pay their fare on entering the car; that after plaintiff had ridden about one and one-half blocks without paying fare, his attention was called to the rule, and he was requested by the driver to pay; that plaintiff answered that the driver was in "too much of a hurry;" and that he (plaintiff) would "take a little time on that"; that plaintiff was then ordered to get off the car; that the driver undertook to eject plaintiff, and was himself put out by plaintiff; that the driver then seized an iron bar, and again ordered plaintiff to leave the car, which he did without being struck or injured in any way. *Held*, That plaintiff could not recover, as his conduct amounted to a refusal to comply with a reasonable rule of defendant, and justified his removal.

(Supreme Court of California. *Nye vs. Marysville & Y. C. St. R. Co.* 32 Pacific Reporter 530).

THE NEWARK & CENTERVILLE RAIL-ROAD.

THE above named road is of rather doubtful pedigree, it being a serious question whether it should or should not be classed as a street railway. It is nominally a branch of the Great Southern Pacific Railroad system, and runs from Newark, California, on

The freight cars are those regularly in use on the railroad, it being the custom to haul two of these, loaded, up the grade towards Centerville, together with the small passenger car which is kept on the road. Down the grade nine empty cars have been hauled without unduly heating the motors. The operation of the road is under the sole charge of H. H. Burdick, who appears in our illustration.

BRAKES FOR ELECTRIC CARS.

ALTHOUGH this subject has furnished material for a good many editorials during the last two years, the recurrence of accidents caused by failure or weakness of electric car brakes, show that not only were such editorials written with good cause, but that there is reason for still more agitation of the subject. The Engineering News, in a recent article, brings out many points, some of which are not commonly thought of.

In the first place, electric lines are now operating over much steeper grades than were ever dreamed of with horse cars, and formerly only possible with cable traction. The limiting electric road grade is at present that on which the wheels will not slip. The brake gear, therefore, ought to be proportionately stronger than that for horse cars. The grades are steeper than any found on steam roads, for the electric follows the surface, and goes wherever the traffic demands. Added to this, there are often curves at the foot of the grades, these curves being as sharp as any on horse lines. Roads can not choose

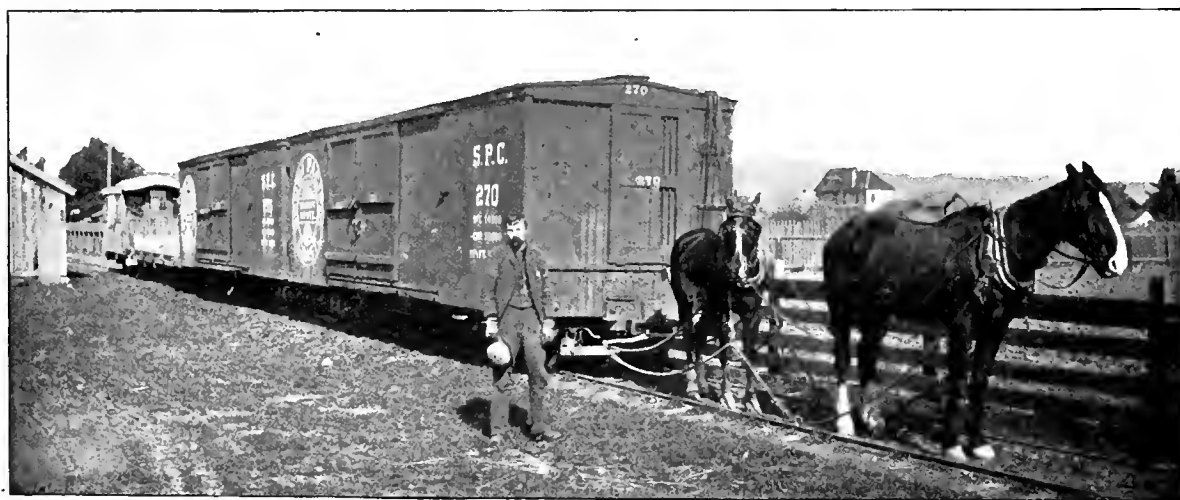

"THE MOTIVE POWER CONSISTS OF TWO EQUINE MOTORS."

the main line of the above system, to Centerville, a distance of three miles, traversing in its course a beautiful valley. The entire equipment is shown in the engraving. The motive power, which occupies a prominent position in the foreground, consists of two equine motors encased in rawhide to make them water and dust proof and connected up in series. This series arrangement is not varied by the controller, because the narrow gauge of the track does not permit parallel coupling and the fact that powerful starting torque is desired rather than high speed.

their locations in this regard; they must follow the traffic. On a grade of 1 per cent one mile long the total fall is about 50 feet, and a car starting down at a five miles an hour gait will attain a speed of 27.1 miles an hour. On a 7 per cent grade the fall of 50 feet will be made in a run of only 714 feet, and the acquired speed will be 36.5 miles an hour. The time is 3¾ minutes in the first car and 24 seconds in the latter. The important difference between the grades is the time required to attain a given speed. There is plenty of time for action on the moderate grade,

but very little on the steep. Reversing the motor when gaining speed on grades is liable to disable it or blow a fuse.

The holding power of brake shoes is small at high speeds. Engineers handling air brakes in mountainous countries know this. If the speed gets high enough, the retarding power of the brakes may not be equal to the accelerating power of the grade. Air brakes will probably replace hand brakes some day, and one or two seconds saved in the time of application, but after all, certainty of application with full power is more important than quickness on steep grades. The brake rigging should be designed with a large factor of safety. The maximum pressure on the brake shoes should equal the weight of the car.

The News very pertinently asks the question whether the interests of safety do not demand that the limiting grade on electric car lines should be that at which the car

ought to be much less than those customary at present.

As an alternative, some auxiliary method may be used to help both the brakes and the motors, such as is in use at Portland and Seattle. These, of course, mean additional expense, but safety is the paramount consideration on street as on steam roads.

GENETT AIR BRAKE EXHIBIT.

READERS of the REVIEW will remember a description of the Genett Air Brake Company's exhibit at the World's Fair, which appeared in the June issue. We present in this number an engraving of the space in the Transportation Building containing this interesting display.

The air brake in the last six months has had wonderful success and its introduction has been as rapid as the

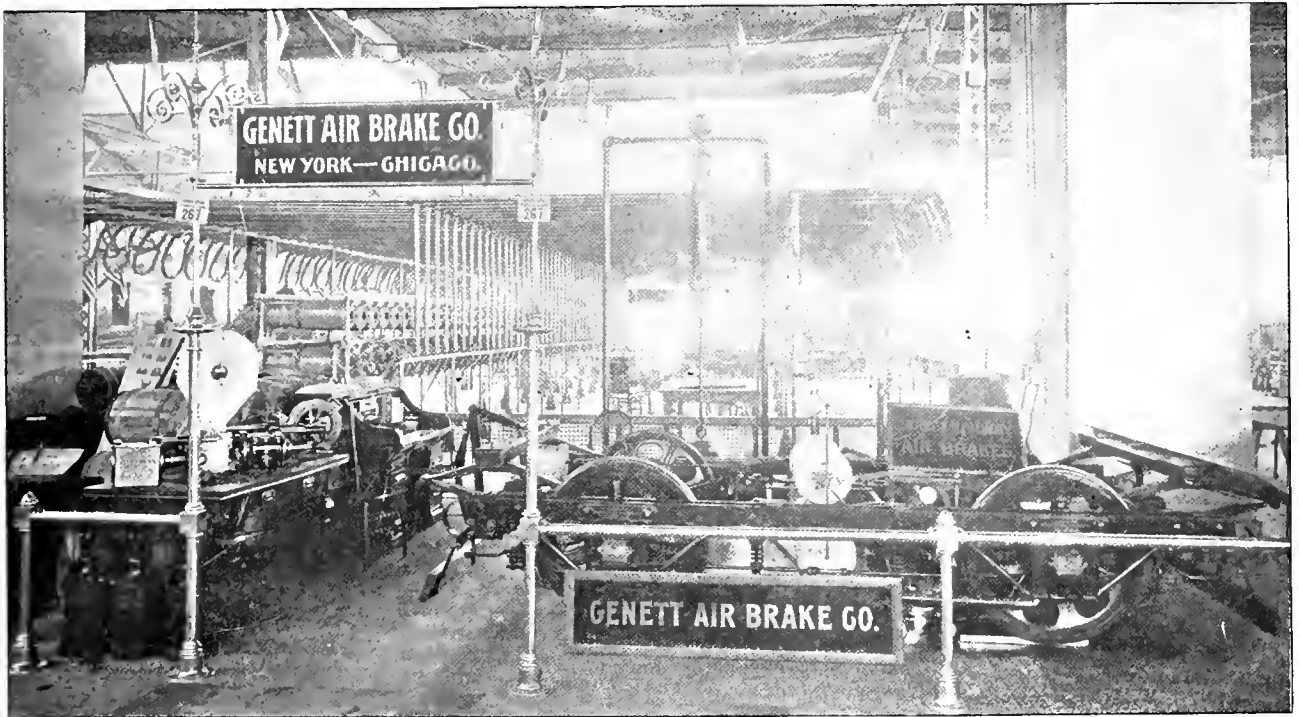

THE GENETT AIR BRAKE, WORLD'S FAIR EXHIBIT.

will stop, supposing the wheels to be locked and the wheels sliding on a greasy rail. If only wheel brakes are used it would. If a car cannot be stopped with its wheels locked, it is not likely to be stopped at all as long as it is on the track. Frequent sweeping of the rails and sanding will, of course, improve the bite of the wheel on the rail, and to that extent increase the brake efficiency.

Experiments are cited on the Paris, Lyons & Mediterranean Railway, showing a coefficient of friction of .11 between the wheel and rail for a railway car with wheels locked, and sliding on a damp rail at from 18 to 20 miles per hour. According to this, an 11 per cent grade is that at which the accelerating force would balance the friction of the wheels on the rails at 18 to 20 miles an hour. Street railway rails are, moreover, liable to be coated with slimy mud, so that possibly the limiting grades

most sanguine could ask. They are now in full operation on the Broadway & Seventh Avenue line and Third Avenue line, New York City; Atlantic Avenue, Brooklyn; Lynn & Boston Railroad, Lynn, Mass.; Hayward & San Leandro Railroad, Oakland, Cal., and on the Buffalo & Rochester Street Railway lines, New York. The company also has its brakes in operation in South America and Australia.

Increased facilities to execute orders gives a capacity of 300 brakes a month, and so keen is the demand even during the late depression that the entire output is absorbed as fast as manufactured.

The exhibit represented has been running constantly for five months, requiring no attention beyond oiling once a day. The car wheels represent 20 miles an hour, or double the speed ordinarily required on street railways.

ELEVENTH ANNUAL MEETING OF THE STREET RAILWAY ASSOCIATION OF NEW YORK STATE.

IN the pleasant rooms of the Chamber of Commerce, Rochester, the eleventh annual gathering of the association occurred September 19. President C. Densmore Wyman was unable to be present, owing to his duties as manager of the electric launch system at the World's Fair, and Vice President Hasbrouck, of New York, presided. The president's address abounded in the most interesting personal reminiscences of early days in New York City.



D. B. HASBROUCK,
President Elect.

The report of the executive committee showed the membership to be 27, of which five companies had joined during the year, as follows:—

Binghampton Street Railway, Binghampton; Elmira & Horseheads Railroad, Elmira; Cuyadutta Electric Railroad, Gloversville; Ithaca Street Railway, Ithaca; Niagara Falls Suspension Bridge Railway, Niagara Falls.

The report further stated no adverse legislation had become law; and that the financial and business outlook was greatly improved. Reference was also made to the death of John Stephenson.

The treasurer's report was: Receipts, \$902; expenses, \$678; cash on hand, \$223. Geo. W. McNulty was granted another year in which to present his paper on "Improvements in Cable Traction." A paper by T. J. McTighe was read on the "Return Circuit for Electric Railways," printed elsewhere in this issue. The nominating committee, consisting of Messrs. Watson, Richardson, Sr., and Williams, reported the following ticket, which was unanimously elected:—

President.—D. B. Hasbrouck, New York City.
First Vice President.—G. Tracy Rogers, Binghampton.
Second Vice President.—James H. Moffitt, Syracuse.
Secretary and Treasurer.—W. J. Richardson, Brooklyn.
Executive Committee.—John N. Beckley, Rochester; Daniel F. Lewis, Brooklyn; Charles Cleminshaw, Troy.

Syracuse was selected as place of next meeting, which will occur the third Tuesday in September, 1894. The Rochester Railway Company then entertained the visitors with special cars to the Bartholomay Brewing Company, where lunch was served, and afterwards a trip to Charlotte, Lake Ontario beach, where dinner was given at the Cottage Hotel, accompanied by orchestral music, singing by the Tremont quartette and recitations by Lafa. Heidell; general speech making completed the evening.

The delegates present were: G. Tracey Rogers, president, Binghamton Railroad Company, Binghamton; Wm. Richardson, ex-president, and Wm. J. Richardson, secretary, Atlantic Avenue Railroad Company, Brooklyn; Henry M. Watson, president, Buffalo Railroad Company, Buffalo; W. W. Cole, general manager, West Side Railroad Company, Elmira; H. Bergholz, secretary and treasurer, Ithaca Street Railway Company, Ithaca; D. B. Hasbrouck, secretary, Houston, West Street & Pavonia Ferry Railroad Company, New York; C. A. Williams, secretary, William Rosborough, superintendent, and Albert Green, elec-

trician, Rochester Railway Company, Rochester; C. A. Derr, general superintendent, Rochester Electric Railway.

The following gentlemen were also present: H. W. Blake, Street Railway Journal; F. R. Colvin, electrical engineer; B. E. Green, electricity; W. J. Clark, General Electric Company, New York; J. S. Crider, Washington Carbon Company, Pittsburgh, Pa.; H. C. Evans, Johnson Company, New York; D. T. Evarts, general manager, Simplex Electric Company, Chicago; Thomas A. Fearey, General Electric Company, Buffalo; Arthur W. Field, Peckham Motor Truck & Wheel Company, Kingston; R. Gerry, American Iron & Steel Company, New York; H. J. McCormick, Schaffer Manufacturing Company, Rochester; Elmer P. Morris, General Electric Company, Indianapolis, Ind.; A. D. Newton, Eddy Manufacturing Company, Windsor, Conn.; J. F. Ostrom, Pennsylvania Steel Company, Philadelphia, Pa.; D. W. Pugh, John Stephenson Company, New York; John S. Pugh, Baltimore Car Wheel Works, Baltimore; F. C. Randall, J. G. Brill Company, Philadelphia, Pa.; F. D. Russell, Rochester Car Wheel Works, Rochester; John Taylor, Taylor Electric Truck Company, Troy; A. C. Vosburg, secretary, New Process Rawhide Company, Syracuse; H. W. Weller, General Electric Company, New York; C. B. Wyman, manager, Central Electric Heating Company, New York; Charles J. Bissell, counsel, Rochester, and C. C. Woodworth, Rochester.

TRAMWAY AFFAIRS AT MELBOURNE.

OWING to the hard times prevailing at Melbourne for some months past, the Tramway & Omnibus Company has not proved the dividend paying property it once was, but the stockholders expect that better times will come soon and induce more riding. At the annual meeting Chairman T. B. Clapp gave some account of the economy that had been accomplished over last year, which in office expense and stationery was \$2,600; in fuel, \$10,300; in cable renewals, \$48,000. Besides this, there was a large saving from reduction of salaries and wages. This includes sixteen cable lines, and the saving in cables was partly from alteration of the lines and partly from improvements in cable manufacture. The gross receipts were \$2,000,463 and the expenses \$1,890,535. Two dividends, at the rate of 2½ per cent, were paid during the year, absorbing \$115,000 of the profits. The system has long held a record as a well-conducted property, and all things considered, the showing is an excellent one and reflects credit on the management.



STATUE OF LIET ERICKSON, MILWAUKEE.

THE RETURN CIRCUIT OF ELECTRIC RAILWAYS.

THE most important feature of the New York State Street Railway meeting was a paper on the return current of electric railway, prepared by T. J. McTighe, electrical engineer, of Brooklyn, and who has been prominently connected with electric installation of the Atlantic Avenue road in that city. Mr. McTighe writes of his own personal experience, and presents his argument in a strikingly forceful manner. Of such moment is this question with street railways at the present time, we publish the paper in full, as follows:

I had the honor of being appointed a special committee to make a report upon "The Return Circuit of Electric Railways." To show you that the magnitude of the honor has been appreciated, and the gravity of its duties well weighed, I may say that during the whole interval the committee has been in session every day and night, including Sundays. I may also add that a committee so continuously controlled by the pernicious one-man power has hard work reaching sound and impartial conclusions upon the questions forming the subjects of deliberations at the sittings. One leading difficulty has been to obtain some crumbs of certainty from the confusing experience's of others. At

one sally of the committee, after deciding that iron rail bonds were only worthy of execration (and rust,) we were told that nothing but iron is trustworthy. Another opinion, obtained the same day, and also based upon alleged long experience, was that the bonds should be copper and the ends or rivets soft iron. The heathen who gave this opinion, I am glad to say, has since come into the fold. Still another, also a man of experience, announced that rail bonds were all wrong, that the only thing to do was, lay a No. 6 supplementary copper wire, and connect each rail to this by a soldered branch terminating in a cop-



T. J. MCTIGHE.

per rivet, soldered to it and simply driven into the rail at any convenient point. That made harvest enough for one day. The committee went home and entered into executive session, and decided to remain in executive session indefinitely, and try to get at the question in its own way, since at the outset it got a knockdown blow for attempting to believe the doctrine *experientia docet* to be infallible.

The progress of the trolley system of electric railways has been so rapid as to become almost bewildering. A multitude of improvements had been added, the necessary result of careful thought and ingenuity of the electrical engineer, and the critical study of the practical railway manager and his assistants. But this has been mostly true of the track and overhead construction and the cars and power equipment. The return circuit has been rather neglected, being largely a case of "out of sight, out of mind." Originally installed on a basis evidencing immature study, and necessarily without experience, it has been left to shift for itself, or rely upon Mother Earth to open a frictionless path for the nearly exhausted pressure to get back to the power house. Few practical investigations of efficiency have been made, and data are meagre. Yet the return circuit is in some respects quite as important a factor of the system as the overhead circuit, and a moment's thought will show this to be true. The efficiency of an electric circuit depends upon the resistance of all the parts. We carefully figure out the amount and size of overhead wire so as to bring down the waste of energy in transmitting current to the motors, and we should be logically bound just as carefully to plan out the return circuit. There is this important difference, too, in our favor in the latter case, that, while we must have all copper overhead, and consequently must struggle with the spectre of cost, when we get in the ground we have a veritable tower of refuge present in the rails, if we but choose to take proper steps to avail ourselves of their valuable help. Track rails are necessary, and they are getting better and bigger for our circuit purposes, and I believe it will not be long before the absurd and costly supplementary wire will have joined the vast army of discarded "expedients," and with it the earth as a permanent part of the return circuit, except in some special cases.

On a wet day in moderate weather, the earth is available, and to a

very large extent, I believe, considering that with a seventy pound girder rail and double track we have something like 30,000 sq. ft. of earth contact per mile of track. But we cannot rely upon this doing us the same service in long spells of dry weather. Still more, we cannot rely upon it doing any good whatever in severe winter weather. It is not uncommon in this state for frost to penetrate three feet in the ground, and to stay there for a whole winter. Under such circumstances, the earth return must go out of our calculation. It is during severe winter weather that we want to realize our very last watt in the hard pulls we must contend with almost daily.

We are told in mechanics that the strength of a structure is measured by that of its weakest part under the most unfavorable conditions it is to meet. Similarly, in a compound electric circuit, the total resistance must depend upon the condition of highest resistance to be met with in any of its component parts. We must plan so as to have our return circuit efficient in the most prolonged summer drought, and in the most severe frosts of winter. Ground plates and pipes laid below permanent water level are a refuge in a few favored localities, but the same can hardly be said of plates and pipes laid in the ground whose moisture depends upon the wayward elements.

I have made a large number of calculations as to what should be the total resistance per mile of the return circuit under different methods of the construction of the circuit. In making these calculations I have eliminated the conductivity of the earth, because in average winter weather the earth turns a very cold shoulder to the track. I have eliminated the conductivity of the fishplates, because I believe that under average conditions the comparatively small areas of contact surface are too much oxidized to be of much benefit. The most approved form of fishplates bears only at its upper and lower edges against the rail. The rail and plates are merely special forms of structural steel, rolled while hot, heavily oxidized at best, and usually rusted still more before being applied. Two such rolled surfaces never come into good contact throughout, and it cannot be expected. A straight edge laid along the bearing surface of the ordinary fishplate will convince any one who takes the trouble. Even on our magnificently constructed and continuously maintained steam trunk lines I have, on examination with my knife blade, rarely found a fit so perfect that I could not enter the blade at one or more points.

I have eliminated all the refinements upon which exact scientific analysis of the subject would insist, such as changes of temperature, moisture and other conditions which are more or less insignificant in the practical work. I have based the figures on the ratio of 6 to 1 in comparing the resistance of the ordinary soft steel rails with that of our usual commercial copper, and for the latter I have followed the ordinary tables adopted by the wire manufacturers.

I have not discriminated between the different assignable values for resistance in the various forms of rail bonds, and have calculated only for the specific metal used in the comparisons, leaving the merits and demerits of the form out of the question. I will refer to the last later on.

In studying the general situation prior to constructing, in the spring of 1891, the railway system of Lincoln, Neb. (of which my firm were supervising engineers), I investigated the subject somewhat closely. Though, at the time and under the local conditions, an advocate of iron rail bonds, I was and am yet convinced that supplementary ground wires are an unwise extravagance. I will try to give you the reasons for this belief.

In steel rails we usually say that every ten pounds weight per yard means one square inch of cross sectional area. And every square inch of such area can be brought to terms of copper by dividing by six. The resistance is easily determined, and we thus readily arrive at some important results for comparison. For example, take the average city railway rail as being a seventy pound girder. Its area is substantially seven square inches, and the four rails of a double track make twenty-eight square inches, equal to a single steel bar four inches inches by seven inches wide. This is electrically equal to a bar of copper having 4.66 square inches area, or, in other words, a copper conductor one inch thick and almost five inches wide. With such a magnificent path for our returning current, does it not seem absurd to supplement it with a No. 6 wire, whose area is that of a rod a little over a quarter of an inch square? But when we find the above rail resistance per mile to be but .0086 ohm, while that of the No. 6 wire is just sixty times greater, the absurdity seems to grow, and it becomes a case of sending a very small boy to do a very big man's work, with the man standing idle on the spot.

Calculating in like manner for some usual weights of rails, I obtain the following:

TABLE I.—DOUBLE TRACK.

Size of Rails.	Total Sectional Area.	Equivalent in Copper.			Resistance per Mile.
		Area.	Thick.	Wide.	
50 lb.	20 sq. in.	3.33 sq. in.	1 in.	3.33 in.	0.0121 Ohm.
60 "	24 "	4.00 "	1 "	4.00 "	0.0101 "
70 "	28 "	4.66 "	1 "	4.66 "	0.0086 "
80 "	32 "	5.33 "	1 "	5.33 "	0.0075 "
90 "	36 "	6.00 "	1 "	6.00 "	0.0067 "

As it would be tedious to carry all these into further comparisons, I will carry the analysis out mainly on the seventy pound rail, with one reference to the big ninety pound rail now being extensively used in large cities.

TABLE II.—70 LB. RAIL DOUBLE TRACK

Case.	DESCRIPTION.
1	No. 4 cop. bonds, connectors and two No. 0 cop. supplementaries.
2	No. 4 cop. connectors to rail ends, two No. 0 cop. supplementaries.
3	36 inch No. 0 iron bonds single. No supplementary.
4	36 " " 0 " double.
5	36 " " 0 copper bonds, single. No supplementary.
6	12 " " 0 " " " " " " " " " "
7	36 " " 00 " " " " " " " " " "
8	12 " " 00 " " " " " " " " " "
9	36 " " 000 " " " " " " " " " "
10	12 " " 000 " " " " " " " " " "

90 LB. RAIL, DOUBLE TRACK.	
11	No. 4 cop. connectors to rail ends, four No. 0 supplementaries.
12	12 inch No. 0000 copper bonds, double. No supplementary.

Cases 1, 2 and 11 are given as representing the system on which probably a large majority of electric railways have been constructed. A few roads have the supplementary doubled along both tracks and a few have used slightly larger connecting wires than No. 4 B & S. But I am trying to give the average of what has been accepted as first-class work, and will try to show it can be vastly improved. The West End and the Brooklyn City Railroad Companies laid their tracks with double supplementary copper wires (No. 0 B & S), but found them totally inadequate, and now have put up many miles of huge return feeders or mains at great cost. Even these are inadequate. In Brooklyn these return mains (500,000 circular mils) are, when possible, suspended on the elevated railroad structure. I am informed that occasionally the insulation scrapes off and the return main makes contact with the iron work. Heat enough is developed at this leak to soften the insulation for many feet, thus showing that the resistance of the main return is still too high.

Taking the various cases set forth in Table II, I have constructed another table, and for the sake of fair comparison I have made the calculations on the same basis of elimination as previously noted. I am not aware that the subject has heretofore been followed up to this extent, and I think it will be found interesting and perhaps important.

TABLE III.—CHARACTERISTICS PER MILE, DOUBLE TRACK.

Case Number.	Total R. of Rails.	Total R. of Rail Bonds.	Total R. of Track Circuit.	Fall of Potential for 500 Amp.	Total Energy Expended (Joules in Track Circuit).	Cost of such per 100 per Kilowatt.	Approximate Cost of Track Circuit Material.
	Ohms.	Ohms.	Ohms.	Volts.	Watts.	Dols.	Dols.
1	.0086	.0335	.0362	7.24	1,418	144.80	700.00
2	.0086	.0671	.0586	11.72	2,344	234.40	700.00
3	.0086	.0796	.0882	17.64	3,528	352.80	90.00
4	.0086	.0398	.0484	9.68	1,936	193.60	180.00
5	.0086	.0133	.0218	4.36	872	87.20	180.00
6	.0086	.0044	.0130	2.60	520	52.00	115.00
7	.0086	.0105	.0191	3.82	764	76.40	200.00
8	.0086	.0035	.0121	2.42	484	48.40	130.00
9	.0086	.0083	.0169	3.38	676	67.60	231.00
10	.0086	.0027	.0113	2.26	452	45.20	150.00
11	.0067	.0335	.0306	6.12	1,224	122.40	1,250.00
12	.0067	.0011	.0078	1.56	312	31.20	432.00

Of course, in localities favored all the year round with wet ground, the above table would be seriously astray; but, as I have said, the table is based upon the most unfavorable condition, namely, earth frozen hard for two or three feet deep, and earth conductivity practically nil.

I must not take up your time with any extensive analysis of Table III., but I cannot forbear pointing out a few striking features. Take cases Nos. 2 and 6. The former is, no doubt, used by many members of this Association. No. 6 is the system of track circuit of the Atlantic Avenue Railroad, in Brooklyn, N. Y. No. 2 has a total track resistance of .0586 ohm, and costs, for material, about \$700 per mile, while No. 6 has a total track resistance of but .0130 ohm, and costs, for material, only \$144 per mile. In other words, No. 6, in point of efficiency, is four and a half times a better electric circuit than No. 2, while costing just about one-fifth as much. In roads likely to have extreme heavy traffic, case No. 11 has been adopted, there being four No. 0 supplementary copper wires and the ordinary copper rail bonds or connectors; being thus merely an enlargement of No. 2, and used in connection with ninety-pound rails. In case No. 12, the ninety-pound rails are also used, but there are no supplementary wires, and each joint of the rails is supplied with two rail bonds of No. 0000 copper wire, each only twelve inches long. Comparing results, it is evident that case No. 12 is, electrically, about four times a better circuit than No. 11, while costing only about one third as much.

Now let us compare case No. 12, as it stands, with case No. 11, but adding to the latter two 500,000 circular mils overhead returns connected heavily to the track circuit at frequent intervals. In case No. 11 the total track circuit resistance is .0305 ohm; that of the two 500,000 circular mils feeders about .0545 ohm; and the combination circuit measures about 0.096 ohm. The cost of the two feeders (insulated) per mile of double track roads would be approximately \$2,800, to which we add the \$1,250, cost of track circuit in case 11, making \$4,050.

In short, though our case No. 12 gives us almost three times as efficient an electric circuit as the new case No. 11, the latter costs almost ten times more than No. 12. And yet the West End and Brooklyn City railroad companies pin their faith in a circuit like case No. 11.

A glance at the sixth and seventh columns of Table III. is rather instructive. If we take a medium city system, operating twenty miles of double track, the company which uses case No. 2 will pay several thousand dollars per year for the energy wasted in the return circuit while the company using No. 6, or No. 8 or No. 10, will pay but a trifle in comparison, and save nickels by the quart. I am of the opinion that it would, to-day, well repay any company using copper supplementary wires to rebond its tracks on a basis of perennial low resistance, because on the average it would save the cost of such change in one year. And I say the same to those using iron rail bonds.

There is still another phase to this whole question of the return circuit to which I will briefly refer. I mean the *electrolytic decomposition of the rails*, when earth is relied upon as the major part of the return circuit. That there is such decomposition must be true. The soil under our paving has for many years been plentifully soaked with ammonia from animal refuse, with ordinary salt in the winters of by-gone horse car days, and to these have been added the leakage from the underground gas pipes. Certainly such soil, when wet and in contact with the rails, presents all the requisite features of an active depositing bath, there being no dearth of cathodes below. Hence, so long as a considerable flow of current takes place from rails to earth, there must necessarily be a good deal of direct electrolytic decomposition of the rails. Let me take an extreme case. It would scarcely be exaggeration to assume that on Tremont street, Boston, or Fulton street, Brooklyn, there is a massing of slowly moving cars, amounting to, say, 100 for one mile of double track. Let the rails used be seventy pound girder, and for the current I would say twenty amperes per car for fifteen hours per day would be a fair average. $100 \times 20 \times 15 \times 365 = 10,950,000$ ampere hours per year. If all this went back to the generator by way of the earth, the decomposition of the rails every year would be 7,665,000 grammes, or about 17,000 pounds of iron. Nearly eight tons lost from the mile of double track in one year. As the mile of seventy pound rails would only aggregate 220 tons, it would not be many years, at that rate, till the rails would be qualified for a pension for loss of both feet incurred in the service, and in time we might have an illustration of the proverbial "two streaks of rust and a right of way."

I have assumed an extreme case, but I have no doubt that there is a considerable amount of direct electrolysis of the rails. Nothing can be done to entirely avoid it, but it can be reduced to a minimum by overhauling the track circuit and giving it as great an electrical value as possible, and it might be retarded by dipping the rails before laying, similarly to gas and water mains. In abandoning as much as possible the

rather uncertain supposed advantages of the earth return, we would to a corresponding degree rid ourselves of troubles with gas and water pipes and telephone circuits, and yet would be as safe from lightning as we are at present.

If it be admitted, then, that it is desirable to obtain from the track structure as great a conducting power as possible, the question arises, How shall it be done? This at once brings us to the subject of rail bonds, and a criticism of the various types used, with a view of arriving at the best from all points of view.

There have not been many types brought out by the manufacturers. Probably the earliest was made of a piece of wire having its ends coiled around two rivets and dipped in solder. This form is still much used, but it is objectionable. By its use four contacts exist at every rail joint, *i. e.*, rail to rivet, rivet to wire, wire to rivet and rivet to rail. To ensure its position in the rail the rivet must be upset, and this in a great number of cases either starts or completely loosens the contact between the rivet and wire. If it escapes this, the constant vibration of the rail sooner or later causes loosening of the wire on the rivet. Once looseness occurs, the bond is of little use. Again, the essential nature of such a rail bond precludes the use of any large wire in its construction. Still, many roads have used them and are still doing so. The wire generally used is No. 4 B. & S., sometimes iron and sometimes copper.

Another type, which has met with much favor, consists of two soft iron pins with enlarged heads, which are drilled transversely to receive the connecting wire, which is upset after passing through the heads. This form is open to the same objections as the previous one, being in three pieces, the integrity of whose contact is almost sure sooner or later to be destroyed, whether the intermediate wire is iron or copper.

Later on appeared the ingenious, and, from a purely constructive aspect, very economical "channel pin." It met an enormous sale, and it is to-day in extensive use. The form is familiar to you, and I need not describe it. It requires three pieces, is not capable of riveting in the rail, and its form prevents the pin and wire from completely filling the hole in the rail, and rapid corrosion of contact is inevitable. Being merely driven wedge-like into the rail hole, its stay is not reliable, and by corrosion and continual vibration it becomes loose and almost valueless. There is, too, a tendency for the workman to force the wire against the sharp edge of the hole while driving the pin, thus weakening the wire very materially. It, too, like the rivet-and-wire bond, has a limitation as to the size of the connecting wire. No matter how carefully the mechanics of the job are attended to, we have a mere plug driven in a hole, and so between the rail and channel pin and the car wheels is a very good illustration of a cask, a bung, and a bung starter, with the odds against the bung.

Another type of a rail bond is that composed of a piece of copper wire with cast copper rivets electrically welded thereto, on projecting stems the size of the wire. This is an attempt in the right direction, but does not work out in practice. The electric weld is apparently uncertain, the union in many cases under my inspection being so imperfect that it could be broken by hand. The small copper castings exhibit radial crystallization, making welding difficult. Many also break in applying to the rails, and such happenings destroy confidence.

I now come to what is known as the "solid one-piece bond," which has sprung into great favor. It would be disingenuous, were I not to announce right here, that this rail bond is a patented invention of my own, but I hope that you will admit that I am trying to view this question from a broad and disinterested standpoint.

This solid one-piece rail bond is simplicity itself. It is merely a wire with expansion curves at its ends, on each of which a heavy shoulder is swaged from the wire itself, so that both the rivet ends thus formed and the intermediate wire are all one solid integral piece. From rivet to rivet there can be no failure of contact, except by forcible rupture or total corrosion, and there can be no failure of contact between bond and rail, because when the rivet end is properly headed up, the connection made is perfectly water-tight and air-tight, and it is proof against pounding and vibration. There is no solder required, no parts to shake loose, and there is no restriction in size of wire, as the bond can be made of No. 4 wire and it can be made of No. 0000, and larger if desired.

I suppose the great majority of rail bonds used span around the fish-plates, which nowadays are quite long. My belief is this is a mistake. Table III. will show what a difference there is in resistance in the track circuit as between thirty six inch and twelve inch bonds. The twelve inch bond has the advantage in the total track resistance of from 40 per cent to 50 per cent. A twelve inch solid bond, with its expansion curves, makes a distance between rivet centers of about eight inches. Electric-

ally considered, it does not matter what part of the rail end is used for bonding. The holes can be drilled through the flat "tram" or through the floor of the rail, four inches from the end, just as readily as through the web or stem. There is no difficulty whatever, and I can imagine no type of track construction forbidding the use of short bonds. I have bonded many miles of track in this manner, and used the twelve inch bonds, and had no trouble. In girder rail I prefer to drill the holes through the flat tram, taper ream the holes from above, and deeply countersink; then pass the rail bond up from beneath, and head up the ends till the taper and countersink are completely filled. This method has one great advantage, in allowing every rail bond to be inspected at any time without disturbing the paving. The tracks of the Atlantic Avenue Railroad, in Brooklyn, were bonded in this way with No. 000 copper bonds, eight inches long between rivet centers, and they have given entire satisfaction.

Rail bonds should, after being applied, be either heavily coated with shellac and asphaltum, as practiced by Mr. Wason in Cleveland, or have a grooved strip of wood filled with asphaltum slipped around while the compound is soft. This will prevent corrosion.

Another important element of the return circuit, in such roads as do not pass the power house, is the main return. Whether earth circuit is used or not, there should be a heavy connection from the generator or switchboard by the shortest route to the rails. Such a course is generally adopted, but the size of the conductor is apt to be too small. I have seen several cases of serious inadequacy in this direction, so much, indeed, as to heat the main return. I had occasion once to discuss the question with a gentleman who called himself an electrical engineer, and who had engineered several railways of considerable size. The problem was to return a possible maximum of 5,000 amperes about half a mile from tracks to generator. I gave my views, which embodied rather heavy work, and also my calculations for loss of energy, etc. "Nonsense," said he, "four No. 0000 wires would be abundance, because you can lay them in the ground, and the heat will be carried off before harm can be done." It was no use arguing against that; and I utterly failed to persuade him that his four wires would require 320 volts to drive the 5,000 amperes through them, *i. e.*, a loss of over 2,100 E. H. P. Fortunately, that engineer has generally had some check on him, and thus the construction of several monstrosities has been avoided.

The old rails can be advantageously used for the main return in many cases. When it comes to using a large number of heavy copper wires overhead or underground on the one hand, and on the other hand an equivalent capacity of old rails laid underground, the latter is much cheaper, and can be made entirely durable. The rails can be connected by heavy copper plates by riveting, the number of rivets being equal in carrying capacity to that of the rail and plate. The whole structure can be laid in a wooden trough filled with pitch and will remain intact for an indefinite period. A one-rail line of this kind, composed of old sixty pound flat or center bearing rail, is as good as a copper bar one inch square, or six No. 0000 copper wires.

I am, therefore, led to the conclusion that the best return circuit is that which complies with the following requirements:

1. Intrinsic resistance low enough to need no help from earth.
2. Utilization, to the utmost practical extent, of the rails as the return conductors.
3. Rail bonds of the heaviest practicable size.
4. Rail bonds of the shortest possible length, consistent with due allowance for expansion and vibration.
5. Rail bonds made of a single piece of wire with integral rivets.
6. Rail bonds tightly riveted to the rails through holes freshly reamed immediately before bonding.
7. Rail bonds so placed as to permit convenient inspection.
8. Rail bonds protected against corrosion.
9. A very liberal use of heavy cross bonds from rail to rail direct, and, in double track, extra heavy cross bonds connecting the two inside rails.
10. An underground main or trunk return from power house to track, and there connected to each line of rails, and low enough in resistance to carry the maximum current with but a nominal drop of potential.

Not one of these requirements is an extravagance, but, on the contrary, their proper application to almost any electric railway in the country would be of immediate and lasting benefit. In new constructions they would be a positive economy in first cost. There is not one of them which cannot be adopted in practice, and it seems obvious that their complete embodiment in any existing road would be immediately noticeable in the power house, and eventually in the dividend.

DISCUSSION.

Mr. Rogers, of Binghamton: Can any one present say when copper wire should be used and when iron wire should be used. We have used iron in some places on our road, and found that it rusted.

Mr. Richardson, of Brooklyn: I am sorry that Mr. McTighe is not present, as he could answer these questions. He was one of the engineers for the Atlantic Avenue Railroad Company in the construction of its track, electric bonding, etc. I believe he has modified some of the ideas which he then advanced: one of which was, to make the connection to the power house underground, it would be desirable to have eight center bearing sixty pound rails laid; in other words, a weight of four hundred and eighty pounds to the yard—the weight of iron being a necessary feature. If I understand him rightly, he now speaks of one rail of sixty pounds, which he thinks will be equally effective, and if so, would be a very great saving in labor and expense.

Mr. Cole, of Elmira: I should say, as to using center bearing rails under your track, you have got to use a certain amount of wire to bond them, and as you get nine or ten dollars a ton for the old rails, the question arises how much wire can you buy by selling your old rail; also how much loss there is going to be in the joints in your old rails, by using bonds to connect the old rails together. You have got to bond the old rails with new wire, and you might purchase wire enough to use for a supplementary wire, which will be far better than bonding old rails. I understand that the rail is to be buried beneath the ties, and the joints of the old rail to be bonded; but unless you put in two or three bonds at each joint, as the report states, the highest resistance is just equal to the smallest potential you carry in your wire.

Mr. Fearey, of Buffalo: Mr. Green, the electrician of the Rochester Railway Company, says that they had from three to five old rails for the return circuit, bonding them with both iron and copper wire, and that contraction in the winter and trouble from frost, caused them to take up these old rails and substitute a copper supplementary wire.

Mr. Richardson: How deep did they put those rails in the ground?

Mr. Fearey: I could not say:

Mr. Richardson: It could not have been below the frost line. Mr. McTighe's idea was to have them at least three feet.

Mr. Fearey: Your experience is that the frost goes, how deep?

Mr. Richardson: I do not know of any case in Brooklyn where it has exceeded three feet.

Mr. Fearey: How about Albany?

Mr. Richardson: I should expect you would find it about three feet six inches.

Mr. Fearey: Yes, four feet; and that is a long way to go down to find our troubles.

Mr. Rogers: I would like some one to inform me when to use copper and when to use iron, and what kind of soil is best adapted to each.

Mr. Cole: We have had a series of experiments with copper and iron, and I have so far found that copper is better to use in gravelly soil, while the iron is better in clayey soil and quicksand. I suppose the elements contained in the soil are different in different localities; but I have tried the experiment in three different cities, and the results are invariably the same.

Mr. McTighe, who was not present at the meeting, and hence had no opportunity to engage in the discussion, avails himself of our offer to do so in these columns, and replies to three of the gentlemen as follows:

MR. M'TIGHE THUS REPLIES.

To Mr. Rogers:—I think the trouble has been mostly due to the low conductivity of the iron rather than to the nature of the soil. The high resistance encountered in ordinary iron rail-bonding causes the current to take every opportunity to find an easier path back to the generator, and the flow in wet weather would be great enough to disintegrate the iron by electrolysis. With good copper bonds, the current has a better path back to the rails, and hence less electrolysis takes place. It is thus not a question of the specific metals used for bonding, but rather the specific resistance, and copper happens to be our best friend from this standpoint. I favor copper bonds in all cases. To avoid damage from the soil, asphalt the bonds.

To Mr. Cole:—Old steel rails are, under favorable circumstances, worth \$12 per ton, and soft steel being about one-sixth the conductivity of copper, six tons of rail, worth \$72, would carry current with the same efficiency as one ton of copper, worth about \$300. The six tons of 60-pound rail would stretch 600 feet, requiring twenty joints, and if properly joined will be just as good a circuit electrically as six No. 0000 copper wires would be. The joint should be a copper plate five inches wide, eight inches long, curved at center for expansion, and riveted to each rail with four $\frac{5}{8}$ -inch copper rivets, and the whole line laid in a rough board trough filled with pitch. The cost of the rails, plates, rivets, lumber, pitch, and labor (except trenching) should not exceed \$150 for the 600 feet. The equivalent in copper would cost not less than \$300.

To Mr. Fearey:—I should think the trouble at Rochester came from failure to allow for expansion, and an insufficient connection from rail to rail, as also from a failure to exclude the moisture and air from the joints.

My lady own was passing fare and passing fare was she,

While to the bold conductor it seemed eternity.

Her purse was in her pocket, her pocket hard to find.

She grasped the skirt in front of her, and then she grasped behind.

'Twas then the man grew restive and said alack-a-day,*

I'll come again Fair Lady when you have found your pay.

* This is poetic license. What he *did* say doesn't look well in print.

THE San Francisco Street Railway Company contribute \$13,500 in cash to the fund for the Midwinter Fair. The Omnibus and the Ferries & Cliff House contributed \$5,000 each.

THE ELECTRIC RAILWAY ON THE GETTYSBURG BATTLEFIELD.

CONOCLASTS are divided into two distinct classes. One breaks the idols of superstition and prejudice with a hammer and stands guard with a sword to keep quondam worshippers from their knees. The other class destroys superstition as effectually by showing a better way.

This latter class includes the Gettysburg Electric, Railway, and gives cheaper and rapid transit over the scene of the bloodiest struggle of the fiercest war of modern times.



When the world first heard that an electric railway was to cross the field of Gettysburg

a prolonged howl arose from half the papers in the land. It was heralded far and wide as wanton desecration. The promoters, however, knew better than to hesitate, and proceeded on their way, not exactly rejoicing, but fully determined. The secretary of war was appealed to, but the attorney general, to whom the matter was referred, refused to interfere, and now the poorest veteran of the late war may see more of the battle field for a small price than the hackman would allow him to see for twenty times the amount.

The revulsion came, and is expressed best by the following extract from a veteran's letter to the Grand Army Journal:

The correspondent says:

"Much ado about nothing," had many illustrations before the "Immortal William's" day, and each return of the year projects some new scene. So the electric road at Gettysburg comes in as the most recent. From the denouncing circular issued to the vets, I had supposed that real defacement had transpired. So my eyes were alert as were thousands more. I did not ask a question or search for an argument from either side, but just walked the whole length of the line to scan the critical points and the details of the line. Defacement of the battle line? Nowhere. Disturbance of a single particular thing or monument? Not any. I had heard some howls about blasting rocks in Devil's Den. The road passes this weird, wild place, where almost dragons fought for the mastery, and the Unionists won. The road passes along the shallow stream which runs between Round Top and the Den, but on the side opposite the Den; and for the life of me I could not see where a single pebble of the Den had been moved. The road is not within ten rods of the far-famed rocks. And from my point of outlook, even the top of the 44th New York Volunteers monument, I could catch no sight where the electric road will deface the battle field any more than, or as much, as the avenues which the cemetery commission has already laid out for the traveling public, and especially the coaches, carryalls, carriages, delivery wagons, carts and vehicles, all of which demanded the plump price of a dollar to tote any one around the ground for an hour or two, or a half-a-day, and then cannot decently fill the demand of a great crowd."

Of the eight and-a-half miles of road, five and-a-half run on the public highway.

Another veteran says:

"Why, a plumber isn't a circumstance to the Gettysburg hackman, and a bank cashier don't begin to have the opportunities to accumulate currency that has the owner of a team and vehicle in Gettysburg. But

they killed the goose that laid the golden egg. The public wouldn't stand the extortion. The hackman had to go and the trolley came in. The cry that the railroad encroaches on monuments is all the suggestion and inspiration of the hack drivers. It is humiliating to think that their brazen clamor in defense of their extortion has found sympathetic ears among any veteran organizations. Demetrius, the silversmith, set men shouting, 'Great is Diana of the Ephesians,' to keep up his sale of silver statues of the Goddesses; but he could not make any stand against the new faith, and Demetrius, Diana and the silver statues all had to go. The Gettysburg hackman have levied their last forced contributions of the Gettysburg visitors."

The Gettysburg Electric Railway, as a mechanical effort, is not remarkable further than it is a first class, business-like and handsome piece of electric railway

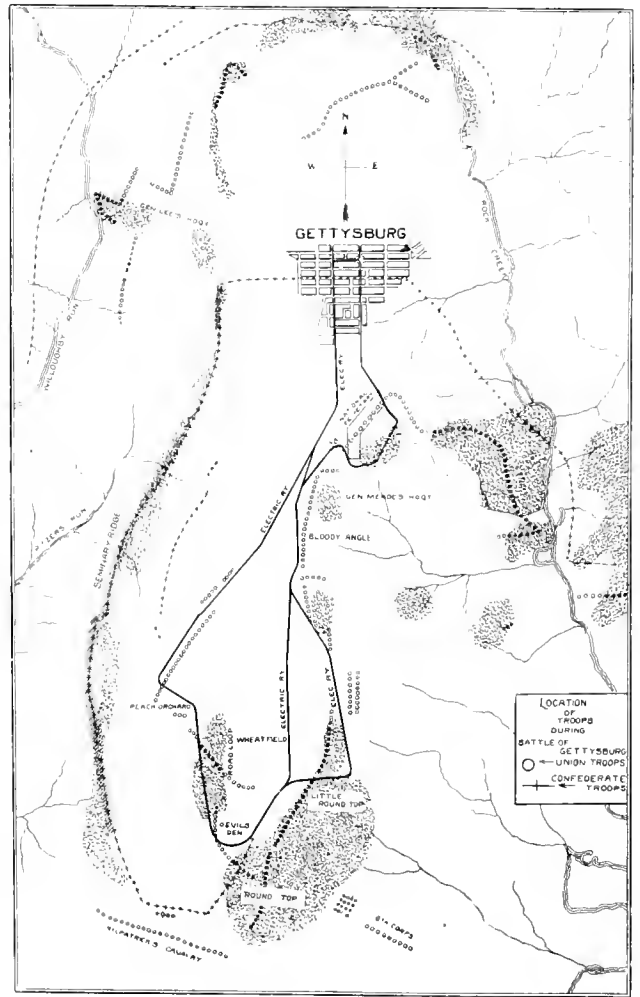

ELECTRIC RAILWAY IN THE BATTLEFIELD.

building. The company was organized by local capitalists in 1892, with a management composed of the following gentlemen: E. M. Hoffer, president and superintendent; George P. Hoffer, secretary and treasurer, and to them is due the honor of providing a cheap, expeditious and modern method of viewing the salient points of interest on America's greatest battlefield, and protecting the public against the extortion of other methods of transit.

The battle for the electric franchise was longer, if not so bloody, as the original conflict, and the Hoffers deserve the greatest credit for their zeal and patience in the face of difficulties.

The track is standard gauge of 58 pound tee. The

maximum grade is 7 per cent. There are six cars in operation, three motor and three trailers, each 34 feet long. Two 30-horse-power Westinghouse motors are under each car and Lobdell Car Company wheels are in use. The Westinghouse generators of 150-horse-power are two in number and the line is fed in two sections.

ennially patriotic pilgrims, extends three miles east and west and two and-a-half miles north and south. The electric road, as may be seen from our map, traverses the most interesting part of the field, redolent with the memories of the three awful days of July 1, 2 and 3, 1863. A description of the battle would be necessarily incomplete,



VIEW FROM THE LINE SHOWING SCENE OF THE SLAUGHTER OF THE THIRD CORPS, THROUGH SICHEL'S BLUNDER, JULY 2, 1863.

The power house is 80 by 180 in dimensions and covers two 150-horse-power engines and the same boiler power, all made by the Frick Company, of Waynesboro, Pa. The company runs an electric light plant, of the

but every American citizen knows that here the confederate General Robert E. Lee met his defeat in trying to lead his desperate army into the north to capture Washington and to bring to the confederacy munitions of war.

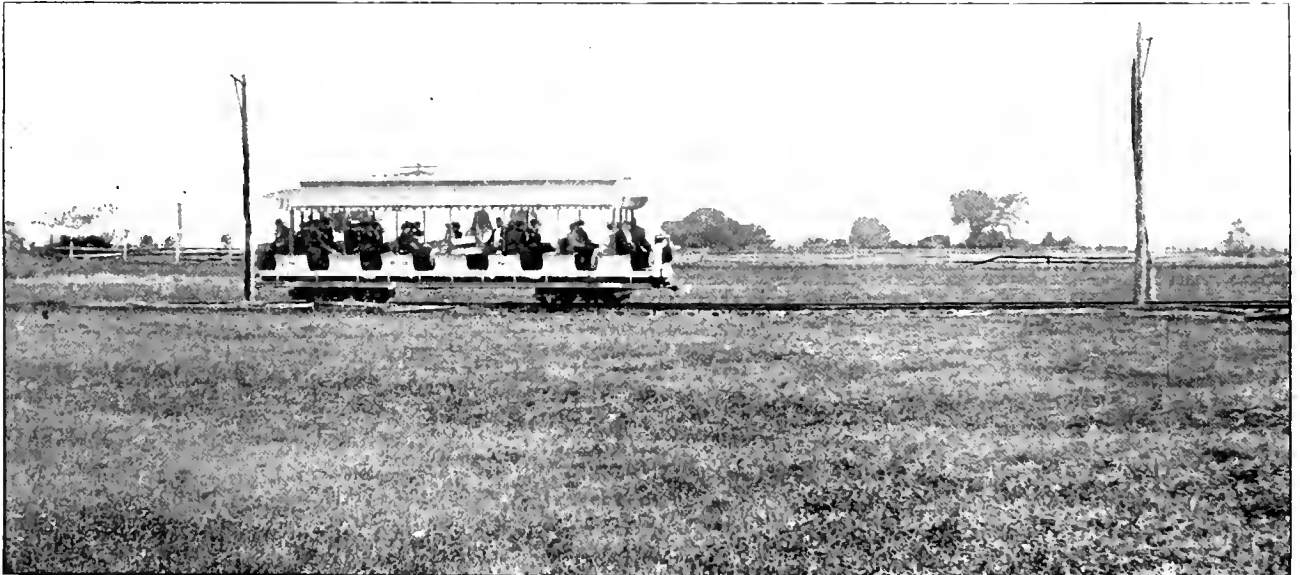

PASSING THE BLOODY ANGLE. THE COPSE IMMEDIATELY IN FRONT OF CAR IS THE FAMOUS HIGH WATER MARK — BOUND TOP IN DISTANCE.

Westinghouse persuasion, in connection with the railway plant. The roadway is well built and the overhead work carefully, strongly and neatly done.

The field of Gettysburg, around which so much sentiment clusters, and which is the Mecca of thousands of per-

Here Hancock made his reputation, and Fighting Joe Hooker's army of the Potomac lost the flower of its chivalry.

Here is the Seminary Ridge, famed for theology until '63, and taking its place as the scene of the awful strug-

gle of the second day. There is Little Round Top, upon whose rocky summit the unknown and unrecognizable confederate dead were found.

Along the route of the railway, under the peaceful sun, thousands now look upon this beautiful park, the relic of the past viewed from the standpoint of the present.

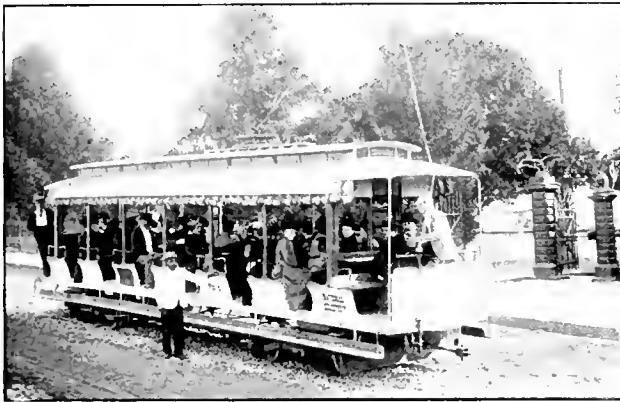

ENTRANCE TO NATIONAL CEMETERY.

Our engravings, obtained through the kindness of Photographer Tipton, the famous Gettysburg artist, himself a sturdy advocate of the electric railway, show better than words can the points passed by the line.

Here we whirl past the Bloody Angle, where the struggle was a hand-to-hand, bayonet to bayonet fight. There in front is the High-Water mark where the invaders fell

Wheat Field where Hancock led his troops. So, all around the circle of the road, the eye can see the ground once drenched in blood and death, now clothed with the brilliant hues of autumn. The place is holy ground, sacred to the memory of the men who willingly shed their blood for their country and their faith. Here and there are fane to their memory. There is the Excelsior Brigade monument, raised to those who died with the Third corps. There a shaft proclaims that the Seventh New Jersey infantry fought and died. Now marble marks the last stand of battery B, of the First New Jersey light artillery. Here the Fifteenth New York battery has a stone raised to its heroic memory.

Now we stop at the National Cemetery, where the thousands named and unnamed lie waiting the reveille.

Into the great school of patriotism the electric railway has come to bless and not to curse, to lighten and not to darken, to give to all freely the privilege of seeing the field of Gettysburg.

OHIO STATE TRAMWAY ASSOCIATION.

IT is altogether useless to remark that the 1893 meeting of the Ohio State Tramway Association was an enjoyable, profitable and successful occasion.

That goes without saying.

The annual meeting was called to order by vice-president, W. J. Kelly, of Columbus, at the Gibson House, Cincinnati, September 27.

On counting up the members present, the following

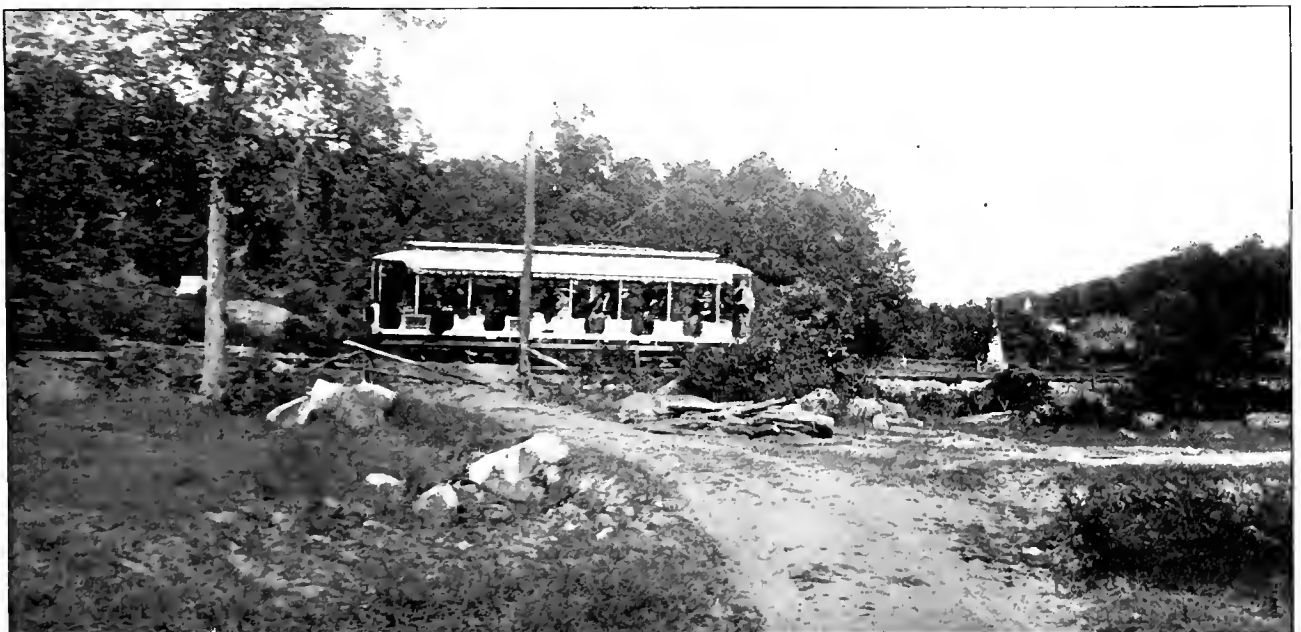

PASSING THE LOOP AND WHEAT FIELD EN ROUTE TO DEVIL'S DEN.

back. Up between the trees, in the distance, is Round Top. Here is the scene of the slaughter of the Third corps of the Federal troops under General Sickles on the second day of the fight at Seminary Ridge.

There is the Devil's Den, where the confederates fought so bitterly and well. There is the Loop and there the

were found: J. B. Hanna, Cleveland, secretary and treasurer; Judge W. A. Lynch, of Canton, executive committeeman; S. L. Nelson, of Springfield; Reid Carpenter, of Mansfield; Albion G. Clark, of Dayton; F. A. Kelly, Columbus; John Kilgour, Jas. A. Collins, Capt. G. N. Stone, Nat H. Davis, Matthew Ryan and Chas.

Kilgour, of the Consolidated Street Railway of Cincinnati; H. P. Bradford, of the Mt. Auburn electric road; Henry Martin, of the Mt. Auburn cable road; T. M. Jenkins of the Covington electric road.

With commendable good taste the officers who so well guided the association last year were retained for 1894, and the association went into a discussion of safety appliances and other matters of state interest. In the afternoon the visitors were driven to the Zoo, when a light luncheon was served, and a trip to the various power plants completed the day. In the evening a banquet was served for twenty at the Gibson, the Cincinnati Street Railway Company being hosts, and President John Kilgour acting as toast master with his usual efficiency and grace. Judge Lynch, and others, distinguished themselves by witty speeches.

Judge Lynch said, in part:

"Street railways are the common prey of the public, the press and the municipality, and the only consolation in our occupation is, that we are engaged in pushing forward a great public enterprise and convenience—the greatest advance of our age. We are at the same time, like virtue, our own reward.

I think that a thoughtful public, if it will only stop to consider, will see that street railroads are not only useful, desirable and indispensable, but are entitled to the good will of the people."

The banquet board was not left until midnight, when the association meeting, like all good things, came to an end. The next meeting will be held at Toledo.

THE LORD BALTIMORE No. 2.

WE illustrate herewith the latest type of truck for electric cars, manufactured by the Baltimore Car Wheel Company, and which has been christened "The Lord Baltimore No. 2." This

the top of them. The jaws of these yokes fit the boxes, which are insulated on all sides by rubber, while the brake-beams are supported by, and slide in, slots on the inner side of the yokes, insuring always an even pressure between the entire face of the brake-shoes and the tread and flange of the wheels; and giving maximum friction when brakes are applied. All the brake-rods and connections are above the axles, and do not have to be disturbed to remove wheels for renewals, which can be done by taking out a single bolt under each axle box. The

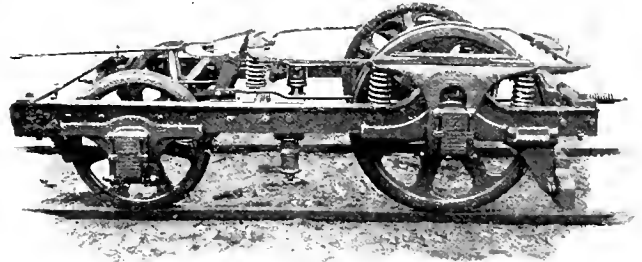

BALTIMORE NEW PIVOTAL TRUCK.

brakes are very simple and powerful, and have a convenient method of adjustment to compensate for wear of wheels and brake shoes. The truck is fitted with half elliptic springs, to which the car body is flexibly connected, preventing all jars at curves and crossings, and compensating readily for varying loads. They also give a very long spring base, (8 feet more than wheel base), entirely preventing oscillation.

The "Lord Baltimore No. 2" formed a part of this company's exhibit at the Milwaukee convention, and not only attracted special attention, but elicited very favorable comment from railway men generally.

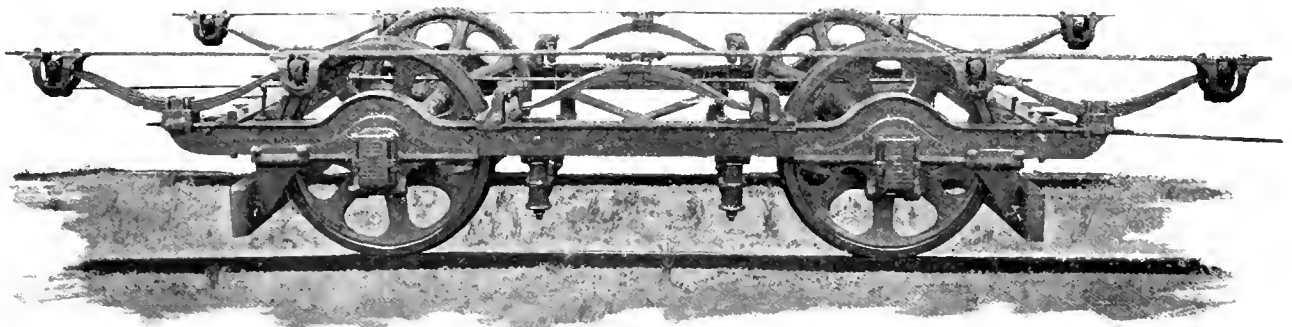

THE "LORD BALTIMORE NO. 2."

truck is the result of the long experience of the above company in the manufacture of trucks, and they claim for it many special points of merit. The side frames are steel tee beams pressed to required shape by hydraulic pressure, and 5 inches deep, by 4 inches wide on top, and are supplemented from a point 15 inches inside of center of axles, to the ends by cast steel yokes which fit the tees neatly, taking a bearing both at the bottom and under

The Baltimore Car Wheel Company are also building a pivotal truck, which has the pivotal bearings or rotating plates, carried directly above the journal boxes of the main or driving axle, supplemented by another bearing resting on springs supported by a bolster or cross frame near the center, between driving and pilot or steering wheels. Upon these bearings the car body swivels when curving. All the space occupied by the motor is open.

and 80 per cent of the entire load is utilized on the driving wheels for traction.

These trucks are so constructed as to carry a car mounted on two of them, no higher from the rail than a single truck car. They are strong and simple, with all parts of steel and easily accessible for repairs, and have the brake mechanism also above the axles. As many of our readers will recall, this company was the first builder of trucks for electric cars, having furnished the first road ever built. President Baker, who has made a lifelong study of mechanics, devised the original truck and has kept close watch of the needs of electric roads under all conditions, specially in the matter of trucks. Hence there will be little wonder that his latest productions in this line so highly commend themselves to the user.

TUG OF WAR RAILROAD DAY.

THE result of the tug of war between the steam and electric locomotives on railroad day at the World's Fair, has been the cause of much surprise and comment. From a common sense standpoint there is no reason whatever for surprise, unless it be because two locomotives of such unequal weight should be pitted against each other in a supposedly equal contest. As will be seen in the abstract of a report made to the General Electric Company, by C. E. Collins and A. Peterson, who had charge of the electric locomotive, the steam locomotive pulled the electric by virtue of its greater weight. This is conclusively proven by the fact that the wheels of the electric were continually slipping on the rails during the trial. This completely knocks the props out from under the idea that electric locomotives have not the horizontal effort which they should have in proportion to their weight, or in other words that they are too heavy for the loads they can pull. The fact is the electric locomotive is not materially different from the steam as regards pulling capacity. Either can be designed with enough weight so that they will never slip their drivers, and, on the other hand, as is usually the case, both can be designed so that their horizontal effort is greater than their tractive grip on the rails. In this latter case it is simply a question of weight as to which can pull the most, and this is the way it was at the tug of war. Had the electric locomotive been designed with motors enough heavier to make up the difference in weight between it and its competitor, there is no reason for thinking that the contest would not have been exactly even, their grip on the rails being the same. The following are the salient points in the report.

The measurements of the electric locomotive are as follows: Wheel base 5½ feet; height of draw bar from top of rail, 30½ inches; distance from motor cross suspension bar to top of truck frame, 12¼ inches; diameter of electric locomotive wheels, 44 inches; width of tire, 4 inches. When sent to the Exposition the electric was all arranged for the struggle except as to the starting resistance, which was subsequently fixed to pass 984 amperes when cold, before the motors were brought into

series. The power was delivered from the Intramural circuit, through one No. 0000 and one No. 000 cable, with a No. 0000 return cable direct from the motor frame, besides having the usual track return.

The steam engine was a Baltimore & Ohio switch engine that had been in use some time. The builders' memoranda show her to have 16 by 24 inch cylinders, with 65,800 pounds weight on drivers. The draw bar pull was rated as double that of the electric.

On account of previous use the drivers of the steam engine were old and much worn, so that they had practically an arc of contact, while the electric's wheels were nearly new and had but a ½ inch bearing on the rail. The steamer besides used plenty of sand. The power was provided by carrying extra steam, in fact instead of carrying 125 pounds, they screwed down the pop valve so that it opened at 140 pounds. Then, too, the cylinders had been so often re-bored as to gain perhaps half an inch over reported diameter.

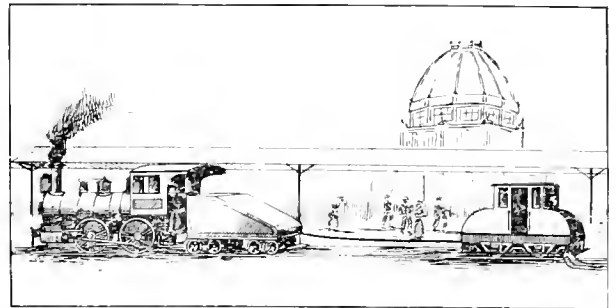

STEAM VS. ELECTRICITY.

The two locomotives were coupled by means of a one-inch wire rope, 30 feet long, with a 1¼ inch iron hook in the link of the electric. This link was fractured on the first pull. On all except the first pull the start was equal, but in every case the steam engine was victor, although the wheels of the plucky electric kept moving in the right direction, and were not reversed. On a trial push the results were exactly the same as the pulls, except when pulling the wheel of the electric farthest from the steam engine would always slip, and when pushing the one nearest the engine slipped.

Pulls one and two were made with the electric's motors in series. On pull three an attempt was made to reach the multiple point, but the distance was covered too quickly. On the push the motors were brought into multiple. Throughout the contest the controller was handled by hand and did its work perfectly. Although it is difficult to obtain very accurate data as to amperage, it is calculated that 1,000 amperes were taken on all pulls before the wheels slipped, but of course in the slipping the amperage fell back. The voltage varied from 400 to 510, with a probable average of 450 volts.

AS SEEN FROM THE DARK SIDE.

Trolley an' de bullgine g'wine fur to fight;
Trolley gibs the bullgine turrrible fright,
Bullgine gets mad, gibs a mighty tug
An' walks den off wiv de lightnin' bug.

INCREASING REVENUE AT AURORA, ILL.

How an Average Sized Plant Makes the Most of Its Advantages.

WHILE it is true that in small cities the street railways are operating at a disadvantage as regards traffic, there are other ways in which they have opportunities for increasing income that are not offered to larger roads. These advantages consist in a practical monopoly of the business of heating and furnishing stationary power. These are monopolies gained, not by any franchise, but by the fact that a large power plant is in existence, which can furnish heat and power at reasonable rates, whereas a plant built expressly for either purpose could not.

The well managed company at Aurora, Ill., has a neat revenue from the two sources named above. The heating system in use at that place deserves some attention, because of the fact that it furnishes an example of a plant suitable for exhaust steam heating over short distances without the use of expensive patented apparatus, and, in fact, nothing more than can be found in an ordinary steam plant. It was at first intended to put in the American District system, and heat the entire business part of the town, but as money for the project was not immediately forthcoming, the company began in a small way to heat neighboring buildings, the plan of piping being devised by A. L. Hadin, the chief engineer and master mechanic of the company. The system has proved very satisfactory, and is undoubtedly the best for use under the circumstances.

The power station is located on an alley, the district to which heat is supplied is the half block adjoining on the other side of the alley. The greatest distance to which steam is carried is about 200 feet from the power house. The exhaust from three 125-horse-power high speed simple engines is led into a main exhaust pipe. This pipe has two possible outlets. One directly into the heating mains, and the other through an automatic safety

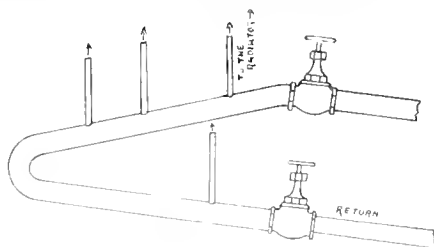

FIG. 1.

valve to the exhaust steam feed water heater, and thence to the atmosphere. The automatic valve in the main exhaust pipe is set at whatever pressure is desired on the heating mains. When the pressure in the mains rises to the amount for which the valve is set, the surplus is discharged through the heater into the air. As a matter of fact, with the 15,000 square feet of radiating surface attached at present, the greater portion of the exhaust from the three 125-horse-power engines is discharged into the air. The above radiating surface also includes the car barns and offices. The system of distribution in

the buildings is what is commonly known as the one-pipe system. The principle on which the piping is done is illustrated by Fig. 1. The supply pipe rises continually from the power house to a point in the basement of the building to be heated. From that point the slope is down. The pipe is led around the basement, and at various points pipes are led off to the one-pipe radiators.

Of course, whatever water condenses in the radiator or coils, immediately runs down the return. This return, instead of being led to a trap and the water emptied into a sewer as is common with long distance heating, is brought back to a hot well in the power house and the water used again, thus giving the advantage of hot, pure water, and in a measure getting ahead of the boiler compound men. The great secret of the success of this piping and the freedom from trouble from condensed water, lies in the fact of good drainage for both supply and return. Each is given a definite slope, so that there are no traps or places for water to collect where steam will have difficulty in passing. If this were remembered, many heating plants would have been piped differently. A 6-inch pipe leaves the power house for the supply, and a 2-inch is laid beside it for a return. They are laid in a plank trough, as shown in Fig-

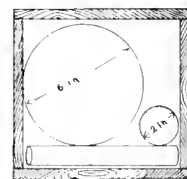

FIG. 2.

ure 2, about three feet below the surface. To allow free movement for contraction and expansion these pipes are laid on rollers, the rollers consisting simply of short lengths of iron pipe. Instead of expensive expansion joints the movement of a system of elbow joints is taken advantage of to furnish the desired freedom. As it was necessary to make a right angle turn in order to get out of the power house this method had no disadvantages, and it will be found available in a great many similar cases. The expansion of over 200 feet is taken care of at one point, the maximum increase in length being about 3 inches. Figure 3 shows the system of elbow joints used for expansion. The nine foot section is allowed to have some motion at its ends. As the pipe leading out to the buildings expands, the threads at the ends of the 16-inch sections give a swivel motion, and as the 9-foot section is allowed to swing around, the expansion is perfectly taken up. The turning of the pipe in the threads of the 16-inch sections has not, in practice, proved detrimental. At the point "D," a half-inch, by-pass or drain pipe, is run from the supply pipe to the return, to drain the moisture from this, the lowest point.

The rate paid for steam heat is twenty-five cents a year per square foot of "radiating surface of all uncovered pipe" inside the consumer's premises. The usual plumber's estimate is one square foot of radiating surface to 75 cubic feet of space. The buildings are piped by the consumers under the direction of Mr. Hadin. The contracts provide for a pressure of five pounds at the point of entrance of the supply pipe, and this is the pressure usually kept. Sometimes it is increased a pound or two, but only in the coldest weather. Although arrangement

is made to supply live steam during the shut down hours in the early morning, it is hardly ever found necessary except in the coldest weather.

The company are not liable for damages for shutting off of steam on account of accident, nor are they required by the contract to furnish steam, except on days when necessary, between the first of May and the first of October.

Contrary to the general rule, the Aurora Street Railway Company is in exceedingly friendly relations both with public and press; this friendliness, however, being nothing more than a just acknowledgment of the progressive policy of its manager, D. A. Belden.

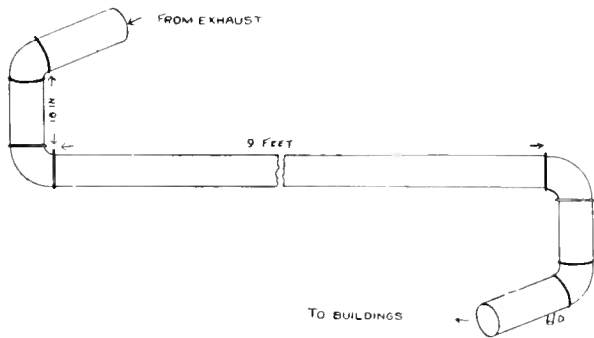

FIG. 3

Mr. Belden has not only an uncommon amount of technical knowledge pertaining to the business, but an appreciative sense of the public needs and desires, qualities which are invaluable to street railway management in small cities. One of the first things to be taken up by him was the supplying of stationary power, and it is safe to say that there are few cities where so large a proportion of the power used is derived from the street railway circuit, or where the service is so eminently satisfactory to all concerned. About 150 rated horse-power of stationary motors are connected at present, not including numerous fan motors in use during the summer. The consumers are loud in their praises of electric power. Twenty-four concerns are supplied the year round. The rates per month are approximately as follows:—

1/8 horse power.....	\$2 00	2 horse power.....	\$14 00
1/4 " "	3 00	3 " "	20 00
1/2 " "	4 00	5 " "	30 00
3/4 " "	5 00	10 " "	50 00
1 " "	6 00	15 " "	60 00
1 1/2 " "	7 00	20 " "	70 00

These are based on the rated horse power of the motor installed. The rates are varied either way from those above, according to the number of hours the motor is likely to be running. In case a man wishes to put in a larger motor than the work at present calls for, an ammeter is put on and his maximum load noted, the contract being based on these figures. Consumers furnish their own motors, but they are inspected by the company's men once a month. In order to help those who may contemplate taking up this class of business, we publish in full the form of contract used. It contains some excellent provisions, that would probably not be

thought of at first by one sitting down to draw up a form of contract off hand.

AGREEMENT, made this.....day of.....189...between the Aurora Street Railway Company, first party, andof Aurora, Illinois, second party.....

Witnesseth, That in consideration of.....dollars, payable as follows, to wit,said first party hereby gives to said second party, on the terms herein set forth, the right to use the electric current, to be taken from the wires of said first party during such times of the day and night as its said wires may be charged therewith, in the usual operation of its electric railway; such electric current to be used for the purpose of propelling the ...horse power electric motor of said second party, while the same is located at.....in the city of Aurora, Kane County, Illinois, from theday of.....A. D., 189...to and until theday ofA. D., 189... said first party agreeing to furnish the wire and conduct the current of electricity to the edge of the street upon which the said premises are situate, and said second party to furnish the wire and pay all other expenses of conducting said electric current from said point into the premises and to the motor above mentioned.

It is further agreed between said parties, that nothing herein contained shall be construed as binding said first party to furnish a current of electricity to said second party at any other times than when said first party shall have its lines charged therewith, in the usual operating of its cars; and if, in case of accident at the power house, or elsewhere along the electric system of said first party, or in case of repair, or for any other cause whatsoever, said second party shall not be supplied with said electric current during the regular running time of the cars of said first party, it is expressly agreed that no liability for damages of any kind shall accrue to said second party because thereof, but said second party, for such time as it may be deprived of the use of said electric current, shall be entitled to a pro rata rebate for the current so lost, as the time lost is to the regular running time of the cars of said first party, which reserves the right to regulate or change such running time. Said second party agrees to take said electric current, and to pay for the use thereof, on the terms herein set forth, and further agrees that the power furnished hereunder shall not be used for lighting purposes.

It is further agreed between said parties, that the motor of said second party, and all wires and electric and other apparatus pertaining thereto, together with the said premises upon which the same are situate, shall at all reasonable hours, during the existence of this contract, be open to the free access and inspection of said first party, its agents or representatives.

It is further agreed between said parties, that in case of the non-payment of any of the sums aforesaid, when payable, said first party, at its option, may cut off the supply of electricity and power, upon giving said second party three days notice of its intention to do so.

This contract is a personal contract with said second party, and not subject to assignment, and is for the benefit of the second party only, at the place aforesaid.

Dated at Aurora, Illinois, this.....day of189...

The reason for the clause in regard to lighting is that the Street Railway Company furnishes power to run the lighting company's dynamos, and under the terms of their contract the street railway agrees to sell no current for lighting purposes and the lighting company no current for power.

The prices are satisfactory to both company and consumer, and it is safe to say that very few would go back to steam or water power. One patron declares that it gives him more pleasure to pay his electric power bill than any other, the motor is such a convenience. This is the state of affairs in every city. Once a few motors are installed, it is only a question of time until nearly all power users will come to electricity.

FOR this year, ending June 30, the Rochester Railway Company gross earnings of \$798,701.74, with operating expenses at \$430,082.61, leaving \$368,678.83 to the net, from operation. The net profit from all sources was \$150,000.

NEW METHOD OF MOTOR SUSPENSION.

THE General Electric Company exhibited at the convention its new method of motor suspension, brought out for use with its new G. E. 800 motor. It is called the cradle system of suspension, the weight being supported at a point immediately below the center of gravity of the motor. By this means the greater part of the dead weight is taken off the axle. Trunions on each side of the motor, just below the armature bearings,

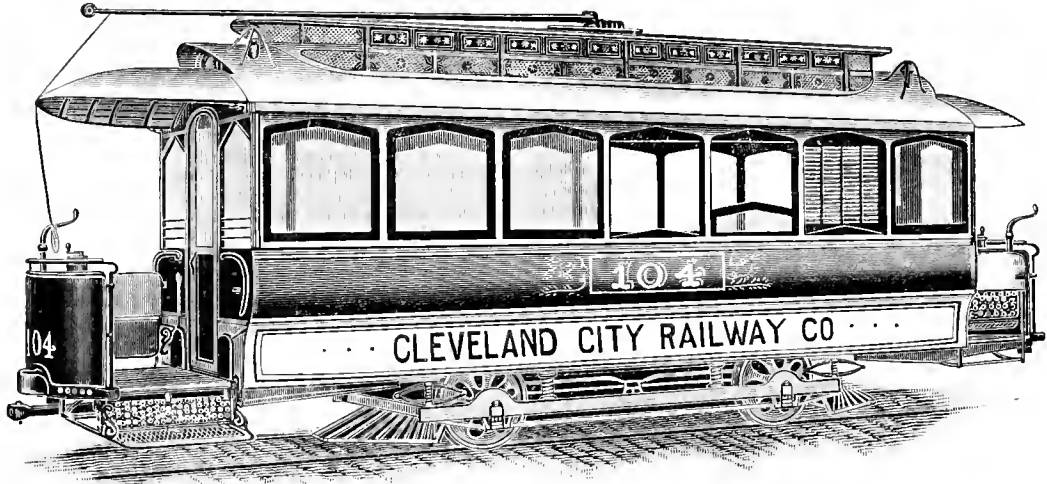

LUDLOW CAR STEP AND GATE.

are set in side bars, pivoted at the front to a special casting. This improvement is not at present part of the regular outfit sent with an equipment, but it is expected that the truck makers will take the matter up, so that the cradle frame can be fitted specially to each make of truck when desired by purchasers

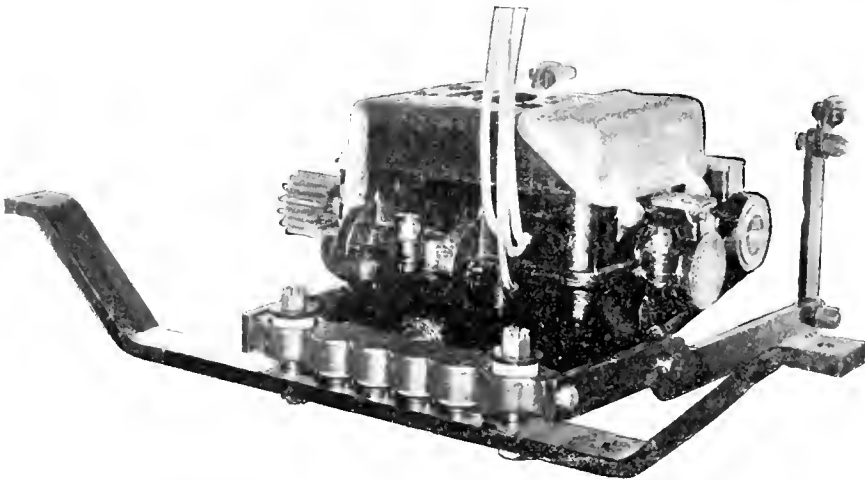

NEW METHOD OF MOTOR SUSPENSION

This is certainly a step in the right direction. The hanging of a great part of the uncushioned weight of electric motors on the axles, has given rise to very many of the troubles which beset the modern electric railway superintendent. The efficiency of the above device not being generally known as yet, the company thought better to give their customers the choice between it and the old style of suspension.

THE LUDLOW COMBINED CAR STEP AND GATE.

THERE is a constantly increasing tendency on the part of managers to restrict entrance to and exit from cars running on double track, to one side only. It is seldom practical to build cars with steps on one side only, and the shifting every trip of movable gates from one side to the other involves time and a danger from careless fastening. Our illustration shows a

solution of the problem, in the combined step and gate, which was patented November 10, 1891, by W. E. Ludlow, of Cleveland, O., and which is now being manufactured by the Fulton Foundry Company, of that city. The step can be instantly changed to a gate, and vice versa, and each step-gate can be worked independent of its opposite mate on the same platform, or can be coupled so that the motorman or conductor, by pressing his foot on the gate, forces it down to a step, while the opposite step is simultaneously and automatically changed to a gate. This is a specially desirable feature of the device, as it absolutely insures steps on one side only and gates on the other, while the step is guaranteed to be as rigid as any other step, and the gate as firm and strong as the dash. When the gate is up there is no step on that side for persons to attempt to use. The height from ground to top of gate is 56 inches. The single gate is operated by a short lever, as shown in the illustration, and both single and double gates catch automatically when raised. This device formed an interesting feature of the Fulton Foundry exhibit at the Milwaukee convention.

THE directors of the Hallesche Strassenbahn Actiengesellschaft, of Halle, Germany, have recommended the adoption of electricity on their lines, and if the stockholders decide favorably the Allgemeine Company will probably receive the contract.

CAUGHT ON THE RUSH TRIP.

Massachusetts Street Railway Association.

President, CHARLES B. PRATT, Salem; Vice-presidents, H. M. WHITNEY, Boston, AMOS F. BREED, LYNN, FRANK S. STEVENS; Secretary and Treasurer, J. H. EATON, Lawrence.

Meets first Wednesday of each month.

Maine Street Railway Association.

President, WILLIAM R. WOOD, Portland.
Secretary and treasurer, E. A. NEWMAN, Portland.
Next meeting will be held the first Wednesday in February, 1894.

Ohio State Tramway Association.

President A. E. LANG, Toledo; Vice-president, W. J. KELLY, Columbus; Secretary and Treasurer, J. B. HANNA, Cleveland; Chairman Executive Committee, W. A. LYNCH, Canton, O.
Meets at Toledo on the fourth Wednesday in September, 1894.

The Street Railway Association of the State of New Jersey.

President, JOHN H. BONN, Hoboken; Vice-president, THOS. C. BARR, Newark, Secretary and Treasurer, CHARLES Y. BAMFORD, Trenton; Executive Committee, OFFICERS and C. B. THURSTON, Jersey City; H. ROMAINE, Paterson; LEWIS PERBINE, JR., Trenton.

The Street Railway Association of the State of New York.

D. B. HASBROUCK, PRESIDENT, New York City.
G. TRACY ROGERS, FIRST VICE-PRESIDENT, Binghamton.
JAS. H. MOFFATT, SECOND VICE-PRESIDENT, Syracuse.
WILLIAM J. RICHARDSON, SECRETARY AND TREASURER, Brooklyn.
The next meeting will be held at Syracuse on the third Tuesday in September, 1894.

Pennsylvania Street Railway Association.

H. R. RHOADS, PRESIDENT, Williamsport.
R. L. JONES, FIRST VICE-PRESIDENT, Reading.
S. P. LIGHT, SECRETARY, Lebanon.
WM. H. LANIOUS, TREASURER, York.
Next meeting at Reading first Wednesday in September, 1894.

Alabama.

MOBILE, ALA.—Ordinance has been drafted for the Spring Hill Electric Railway.

Arizona.

PHOENIX, ARIZ.—Phoenix electric railway soon to be completed. B. N. Pratt is made general manager.

British Columbia.

VANCOUVER, B. C.—The Vancouver & Westminster Electric Tramways & Light Company is organized at \$2,500,000 to take up the business of the Vancouver Electric Railway & Light Company and of the Vancouver & Westminster Traction Company. The incorporators are: David Oppenheimer, Benjamin Douglass and Percy N. Smith.

California.

LOS ANGELES, CAL.—It is altogether probable that the Consolidated Company, of Los Angeles, will resume active control of several Pasadena street railway lines. Franchises are proposed for new lines which will be granted. A. J. Painter is chief owner of the North Pasadena lines in question.

LOS ANGELES, CAL.—Work on the new electric railway bridge is now finished.

OAKLAND, CAL.—Directors file certificate of bonded indebtedness of the Oakland & Piedmont Railway Company; amount, \$350,000. Directors, W. M. Rank, W. H. Bailey, et al.

OAKLAND, CAL.—W. E. Meek, et al., apply for franchise and same will be advertised according to law. Bids must be in at 2 p. m., October 30, 1893.

SAN DIEGO, CAL.—San Diego electric railway's yearly report shows good business and eight cars in operation. Extension resolved on for next year. A. B. Spreckels, president; E. S. Babcock, vice; Jos. A. Flint, general manager and superintendent.

SAN FRANCISCO, CAL.—The new cable consolidation says that all future extensions will be electric. New lines will be built next season. The present cable plants will all be continued in operation.

SAN FRANCISCO, CAL.—Sheriff has levied on the engine of the Oakland Consolidated on an execution for \$7,500 damages. The loss is borne by the American Accident & Casualty Company.

SAN FRANCISCO, CAL.—The first of the fourteen wire cables for the St. Louis Cable Railway has been shipped from the California Wire Works shops.

Canada

OTTAWA, CAN.—Ottawa Car Company has been organized.

OTTAWA, ONT.—Ottawa City Passenger Railway will apply for ratification of amalgamation with the Ottawa Electric Street Railway Company, Limited, and change name to Ottawa Electric Railway Company.

Chicago.

CHICAGO.—Organized: Bipower Car Motor Company, of Chicago; capital stock, \$1,000,000, to build street car motors. Incorporators, Harvey S. Parks, Oscar W. Bond, 225 Dearborn street, and Samuel E. Hibben, 225 Dearborn street.

CHICAGO.—Organized: The C. C. Warren Electric Company, at \$200,000, by Halbert Warren, (not in directory), W. W. Wheelock, 1341 Unity building, and Geo. B. Shattuck, the same address.

CHICAGO, ILL.—By special order of the court the Ansonia Electric Company is permitted to resume business in care of J. B. Waller, assignee.

CHICAGO.—The Metropolitan L has bought land near Harrison and Forty-eighth street for repair shops.

Connecticut.

BRISTOL, CONN.—The Bristol & Plainville Tramway Company organizes by electing Noble E. Pierce, president; C. N. Treadway, secretary and treasurer; both are of Bristol. C. H. Calor, of Plainville, and E. N. Pierce, of the same place, are directors.

HARTFORD, CONN.—The Hartford & Wethersfield Horse Railway is offered some flattering terms by the New York Storage Battery people. President Goodrich says that the Garden Street Line will probably not be built this season.

NEW HAVEN, CONN.—The State Street, the Whitney Avenue and the Morris Cove Street Railway lines are merged into the New Haven Street Railway Company. By December 16, 40 miles of track will be reconstructed, electrically equipped and in running order.

NEW HAVEN, CONN.—The officers of the combined railway are: President, David Corey, of New Haven; vice-president, Chas. A. Warren, of New Haven; secretary, treasurer and general manager, G. A. W. Dodge, of New Haven.

SOUTH NORWALK, CONN.—The late J. W. Hyatt's 1,040 shares in the Norwalk Horse Railway, sold at auction to E. J. Hill. When the new men take control, improvements and changes of motive power will be made.

Colorado.

PUEBLO, COL.—The General Electric Company offered for sale October 13, \$450,000 in first mortgage bonds of the Pueblo City Railway.

District of Columbia.

WASHINGTON, D. C.—Senator Cullom introduces bill for a new street railway in the District, to be called the Washington Central. The incorporators are: M. I. Weiler, Theodore H. N. McPherson, S. S. Yoder, Nathaniel McKay, John H. Knight, H. H. Rand, T. M. Ferrell, and Geo. W. Boyd. The line contemplated is a long one. Line allowed to use any motive power but steam.

WASHINGTON, D. C.—Bill introduced to incorporate the Washington & Benning Street Railway Company; electric. The incorporators named in the bill are: Wm. B. Thompson, Horace J. Gray, Wm. E. Clark, Levi Woodbury, Caleb C. Williard, Andrew J. Curtis, J. Walter Hodges, Geo. R. Sheriff, and Robert Downing.

WASHINGTON, D. C.—R. M. Batchelder, E. W. Rollins, E. O. McNeir, S. W. Curriden, J. R. Baldwin, et al., ask for incorporation of a new road, to be known as the Washington Traction Company. It will be a conduit system.

WASHINGTON, D. C.—Liens filed upon the central power house of the Washington & Georgetown Railroad Company do not seem to disturb that corporation.

Egypt.

CAIRO, EGYPT.—Offers will be received up to February 1, 1894, by the Minister of Public Works, Cairo, Egypt, for the construction, working and maintenance of a system of tramways in the city of Cairo, and its environs, according to Article 1, in the Act of Concession. All particulars of equipment and fare rate (maximum) must be stated in the offer. Full particulars may be had from the Minister of Public Works.

Georgia.

ATLANTA, GA.—The new Atlanta City Street Railway Company has been bought out by the Traction Company and the Chattahoochee River Electric will follow. Several connecting lines will be built; waiting rooms built. New cars will be bought for the spring traffic. The board of directors now consist of T. B. Felder, president; E. T. Shubrick, vice-president; Judge J. K. Hines, E. B. Rosser, W. H. Rosser, G. V. Gress, W. M. Scott and two others to be added.

Idaho.

BOISE CITY, IDAHO.—Boise City Railway is becoming a paying concern. New directors are elected as follows: John Lemp, D. Arnold, Geo. Ainslie, George D. Ellis, Wm. Jauman, G. W. Russell, Mrs. M. E. McCarty, Peter Sonna, and Judson Spofford.

Illinois.

ALTON, ILL.—The Alton Electric Railway Company will soon offer \$100,000 of its bonds in this place. It is claimed all will be taken.

ALTON, ILL.—The Alton Electric Railway Company files mortgage to the St. Louis Trust Company for \$250,000.

AURORA, ILL.—The Aurora Street Railway wishes to exchange its present vestibuled car bodies for lighter equipment. Correspondence invited from car manufacturers and other roads.

BELLEVILLE, ILL.—General Electric Company accepts ordinances granted for construction of a street railway here.

CANTON, ILL.—Canton Street Railway incorporated and books opened. C. H. Martin is elected president, and J. M. Snyder secretary and superintendent. Will build in six months.

ROCKFORD, ILL.—The West End Street Railway Company has begun dispensing with conductors to lower expenses.

ROCK ISLAND, ILL.—The following changes have been recorded: The Union Street Railway Company, at Chicago, selling stock and franchise to the Davenport & Rock Island Railroad Company, and dissolution and surrender of charter.

Moline & Rock Island Horse Railroad Company, at Chicago, selling stock and franchise to Davenport & Rock Island Railroad Company, surrender charter and dissolution of corporation.

Indiana.

EVANSVILLE, IND.—The street railway strike is settled. Both sides conceded, but the company is in the lead.

GOSHEN, IND.—The Indiana Light & Power Company goes into receiver's hands. Said to be in had shape financially. The company is building the Goshen-Elkhart Electric Road.

HAMMOND, IND.—Hammond, Whiting & East Chicago tied up by men stopping work on account of no salaries. No money in the treasury.

INDIANAPOLIS, IND.—H. B. Niles, of the General Electric Company, Lynn, Mass., succeeds W. S. Jewell as electrician of the Citizens' line. Mr. Jewell resigns on account of ill health.

INDIANAPOLIS, IND.—Tom Lewis is made roadmaster of the Citizens Street Railway Company, Vice Michael Burns resigned.

INDIANAPOLIS, IND.—Symptoms are that the Citizens Street Railway will build in Houghtonville and Mt. Jackson.

LOGANSPORT, IND.—S. Spencer, of New York City, president of the Logansport Electric Railway, says that the new loop of the Logansport Electric Railway to the west side will not be built. Citizens now wish to annul the franchise of the company.

Iowa.

BURLINGTON, IA.—George O. Ray and W. E. Blake, trustees, ask for an exclusive franchise on best routes to West Burlington for twenty years' time. No motive power designated, but Patton motors suggested.

DUBUQUE, IA.—Light & Traction Company offers J. A. Rhomberg stock in a consolidation for his interests in the Dubuque Street Railway. Offer refused.

FORT MADISON, IA.—The Democrat advocates an electric railway from Fort Madison to Nauvoo, and says a five-cent fare will pay handsomely.

SIoux CITY, IOWA.—Assignee Hubbard, of the D. T. Hedges estate, has secured an order by which John Pierce becomes owner of all stock and bonds of the Sioux City Cable Railway Company. Mr. Pierce will now put in electric equipment, and is in the market for all supplies.

Kansas.

ATCHISON, KAN.—The Great Western Manufacturing Company has contract to build and equip the railway and light plants for \$225,000. Ten miles of railway is to be ready in six months.

ATCHISON, KAN.—Atchison Electric Light & Power Company, organized at Chicago by Edward T. Norton, of New York, at \$500,000. Immediate preparations to change to electricity.

JUNCTION CITY, KAN.—Incorporated: Electric railway to run from Junction City to Ft. Riley, the capital stock being \$100,000. The directors are ex-Senator John K. Wright and A. L. Barnes, of Junction City; J. S. Gibson, E. S. McAnany, and D. H. Erwin, of Kansas City, Kan. The same parties filed another charter for the Junction City Electric Light, Power & Milling Company.

LEAVENWORTH, KAN.—Newman Erb, of New York has been appointed receiver for the Leavenworth Street Railway Companies on demand of the trustees.

Kentucky.

FRANKFORT, KY.—Road changing to electricity. Will have five and one-third miles when done. Will carry freight.

HARRODSBURG, KY.—A line of electrics from Harrodsburg to Mitchellsburg, 15 miles, will pay. Population of district, 15,000. Write to the editor of the Harrodsburg Democrat.

Louisiana.

NEW ORLEANS, LA.—The New Orleans City & Lake Company gives notice that on October 30 a meeting will be held to ratify or reject the contract with the New Orleans Traction Company, Ltd., and to increase the capital stock to \$2,000,000.

NEW ORLEANS, LA.—Henry Bier files petition of intervention on behalf the syndicate purchasers of the New Orleans City & Lake Railway franchises, affirming that the purchase price of \$700,000 is full and just value.

Maryland.

BALTIMORE, MD.—Henry Brauns, architect, is making plan for a new car house for the Baltimore Traction Company. The City Passenger Railway has declared a quarterly dividend of \$1 per share, equal to 4 per cent for three months.

BALTIMORE, MD.—Baltimore Traction, it is said, will build an electric railway from Pimlico to Lake Roland. A park will be instituted to draw traffic.

FREDERICK, MD.—Two electric railway schemes have been incorporated. One is the Catoctin Valley Passenger Railway & Power Company, organized by G. W. Jacobs, Jr., of Philadelphia, president; D. V. Harp, Myersville, vice-president; C. F. Flook, Myersville, treasurer; and G. W. Watchel, New York, general manager. The other is the South Mountain Electric Light & Power Company, which will build from Boonsboro to Keedysville. This company has elected Geo. W. Jacobs, Jr., of Philadelphia, president; Chas. J. Young, of Boonsboro, vice president and general manager; Geo. A. Davis, secretary; Clarence E. Shaffer, treasurer. These, with T. E. Brown, E. J. Smith and E. L. Miller, constitute the board of directors. The contracts for the construction of the roads have been awarded to the Hughs & Rigby Engine Company, of Baltimore.

SPARROW POINT, MD.—Incorporated: The Canton, Sparrow Point & North Point Electric Railway at \$500,000. Principal offices with the Maryland Steel Company at Sparrow Point. Incorporators: F. W. Wood, president of the Maryland Steel Company of Sparrow Point; Joseph B. Foard, T. Wallis Blakistone, Walter B. Brooks, Jr., Major Luther S. Bent, president of the Pennsylvania Steel Company. Line will be twelve miles long.

Massachusetts.

BOSTON, MASS.—The Rockland & Abingdon Electric Railway Company has decided to double its capital to \$120,000 and to extend to South Weymouth. There are many applications for the new stock.

BOSTON, MASS.—Col. A. A. Pope laughs at the idea that he will succeed President Whitney as head of the West End system.

FITCHBURG, MASS.—President Willis and C. F. Baker, of the Fitchburg Street Railway Company, are now treating with the Clinton selectmen about extension of the Clinton line.

HAVERTHILL, MASS.—All the electric railway systems of New England will be united into one system. Senator Shaw is authority for the statement. Heavy opposition is being made by the steam roads.

HAVERTHILL, MASS.—Things are tending toward a consolidation of local street railways, and the Haverhill, Merrimac & Amesbury is asked to build an extension.

LEOMINSTER, MASS.—Marcus Coolidge, of Ashburnham, examines the Leominster Electric Light & Power Company plant preliminary to opening a street railway line between Gardner and South Gardner.

Michigan.

ADRIAN, MICH.—Samuel D. Nesmith, promoter of the proposed electric line to Ypsilanti, says that his company of Philadelphia capitalists has bought the Adrian Street Railway and will take immediate possession, and also control the Ypsi & Ann Arbor line, and will build new lines connecting Tecumseh, Clinton, Macon, Saline, and the towns named. Sixty miles of new track will be laid.

DETROIT, MICH.—The Electric Railway Company, which wishes to put in a line between Detroit and Toledo, choose as directors: J. H. Ainsworth, J. Ellery Eaton, J. A. Dawson, L. K. Park, Toledo; J. H. Seitz, Detroit; H. J. Warner and H. H. Johnson, New York. Officers are J. H. Ainsworth, president; H. J. Warner, secretary; H. H. Johnson, general manager.

OWOSSO, MICH.—Owosso & Corunna Electric Railway has been put into the hands of Richard Watters as receiver. Mr. Watters has been superintendent since the road has been in operation.

SAGINAW, MICH.—Saginaw Union Street Railway, by L. T. Durand, attorney, and W. J. Hart, general manager, has acquired a thirty-year franchise under fair conditions.

SAULT STE MARIE, MICH.—Soo Street Railway Company damaged by lightning. Power plant burned and dynamos totally destroyed.

TRAVERSE CITY, MICH.—The Boardman river is to be dammed to furnish power for a street railway, light and power plant. The gentlemen interested in this venture are: L. K. Gibbs, of Mayfield; Jas. Hodges, of Fife Lake; J. L. Gibbs, Frank Freidrich, Wm. Bauld and C. L. Hall, of Traverse City. Soon to incorporate.

Minnesota.

STILLWATER, MINN.—Court holds that the receiver must pay employes salaries of the Stillwater road.

Missouri.

AURORA, Mo.—Organized: The Aurora Electric Light & Power Company, of Aurora; capital, \$20,000. Incorporators: E. L. Foster, M. T. Davis, W. T. Branham and J. J. Rehm.

CARTHAGE, Mo.—The Carthage Street Railway franchise passed some time ago, it is claimed that it is not lived up to by the company. The road was continued in operation and now is temporarily enjoined. Unless overruled the streets will return to their natural condition.

CLAYTON, Mo.—The St. Louis & Kirkwood Electric Railway means business, and is making surveys for the line. St. Louis men head the project. The following are officers: Dr. John Pitman, president; Geo. L. Edwards, vice president; Geo. W. Tausig, secretary and treasurer; Jeremiah Fruin and J. D. Houseman, directors.

KANSAS CITY, Mo.—Negotiations are on foot to effect the consolidation of the Grand Avenue Street Railway Company and the Metropolitan Company, to operate them as one system. This will give the consolidation thirty miles of track. The Grand Avenue is capitalized at \$1,200,000, and the Metropolitan at \$2,800,000.

KANSAS CITY, Mo.—Robt. Gillam, who has recently taken charge of the Northeast Electric Railway, representing the bond-holders, will make extensive repairs. F. J. Phillips will continue as temporary superintendent. Street will be paved.

KANSAS CITY, Mo.—The Jarvis-Conklin syndicate, trustee, files suit asking for a receiver for the Northeast Electric Street Railway, and demanding foreclosure of \$260,000 mortgage. Robert Gillam is appointed.

KANSAS CITY, Mo.—The Metropolitan Street Railway Company has adopted the Grinnell automatic dry pipe fire extinguisher for its barns and shops. The cost will be \$25,000.

ST. LOUIS, Mo.—The Midland Street Railway Company, George Kinsland president and purchasing agent, says his road is to be extended from its present terminus to Creu Cœur Lake, a distance of eleven miles. Work to begin as soon as money is easier.

ST. LOUIS, Mo.—The St. Louis Car Company has submitted plans and specifications for an ambulance car, as noted in the August REVIEW. Length of car, 36 feet.

ST. LOUIS, Mo.—J. D. Houseman, Jr., the promoter of the new Kirkwood & Des Peres line, is said to be liberally backed by St. Louis capital.

Montana.

HELENA, MONT.—The Rapid Transit Street Railway have reorganized. It was owned by the Northwestern Guaranty & Loan Company, of Minneapolis, and is now in the hands of the Minneapolis Trust Company, receivers of the former. W. H. Clarke was president but retires in favor of Richard Loeky.

Nebraska.

BEATRICE, NEB.—Paul Horbach, of Omaha, is appointed receiver for the Rapid Transit Company. He will improve the line.

New Jersey.

JERSEY CITY, N. J.—Consolidated Traction Company has applied to the Union county free holders for permission to extend trolley from Newark to Elizabeth.

PLAINFIELD, N. J.—William Spencer, of Washington Valley, is obtaining signatures for petition to extend the Plainfield line of electric to Washingtonville.

WOODBURY, N. J.—The council grants a franchise for the Camden electric. It is so hard in its conditions that it will probably not be accepted.

New York.

BROOKLYN, N. Y.—Organized and incorporated: The Brooklyn Mapleton, Van Pelt Manor & Bath Beach Railway Company to construct a street railroad in Brooklyn, from Thirty-ninth street and Second avenue to Nineteenth street and the water's edge of Gravesend Bay in New Utrecht. Capital \$100,000. Directors: William P. Rae, William Selleck, Daniel Kelly, Edward L. Harriott, Joseph P. Puels and Andrew W. Baird, of Brooklyn; James W. Murphy, of New York City; Michael McCormack, of Mapleton; and James A. Townsend, of Bay Ridge.

BUFFALO, N. Y.—Buffalo, Kenmore & Tonawanda Electric Railway elected the following directors: Daniel F. Callahan, John L. Donovan, Jeremiah F. Sheehan, Alexander Martin, George H. Frost, Frank S. Oakes, Jas. B. Zimmerman, Louis P. A. Eberhardt, James W. McDonald, Martin McDonough, Edward Lee, Norman E. Mack, Samuel B. Hulbert, James J. Byrne, and Frank G. Mitchell.

BUFFALO, N. Y.—The Buffalo & Sanborn Electric Railway scheme is being prosecuted with vigor. The distance is 6½ miles, and the officers are: L. F. W. Arend, president; Lewis T. Payne, of Tonawanda, vice-president; Lee R. Sanborn, of Sanborn, secretary; Edward G. Reisterer of Tonawanda, treasurer, and John H. Pardee, of Buffalo, attorney.

GLOVERSVILLE, N. Y.—At the annual meeting of the Cuyadutta Electric Railway the following directors were elected: Robert Wemple, Harwood Dudley, T. C. Frenyear, E. Smith, John E. Ashe, Daniel Dockstader, Wm. Argensinger, John Dewey, J. H. Decker, J. B. Judson, C. W. Judson, H. Lebenheim, Nelson Dutcher, H. L. Burr and James Radford.

NEW YORK CITY.—By November 1, horses will be superseded by cable on the Third Avenue Road. Superintendent J. H. Robertson is authority for the statement.

SYRACUSE, N. Y.—The street railway company files mortgage to State Trust Company, of New York City, to secure issue of bonds of July 1. Amount is for \$2,500,000.

TROY, N. Y.—The Troy City Railway in its annual report shows gross earnings of \$479,847 from operation, with expenses of \$228,584, leaving a net of \$251,263; dividends declared and paid \$40,000.

WATERTOWN, N. Y.—E. S. Goodale resigns from the Watertown Street Railway management and is succeeded by Geo. O. Adams Watertown.

WEST BRIGHTON, N. Y.—It is likely that the \$10,000 bonus will be raised and the P. R. & P. P. electric road extended to Castleton Corners. The Richmond County Horse Railway, which runs between the Corners and West Brighton will change to electricity.

Ohio.

CINCINNATI, O.—The Cincinnati, West Covington & Ludlow Street Railway is incorporated to build, as noted, and to be completed before October 2, 1894. Capital stock, \$75,000. The men are John J. Shipperd, Howard Ellis, Oscar Baker, Sam Bigstaff, C. B. Simrall, T. M. Jenkins, G. M. Abbott. The money comes from Cleveland, O.

CINCINNATI, OHIO.—Cincinnati Street Railway has gained its extensions on several routes. Four-cent fares will be replaced by five-cent fares. The extensions are very valuable.

■ **CINCINNATI, O.**—The South Covington & Cincinnati Street Railway Company will try to get the contract for carrying mail, and wishes a car for the purpose.

CINCINNATI, O.—The committee of council on street railways orders safety brakes on Cincinnati Street Railway Company's cars.

CLEVELAND, O.—Trust deed is filed by the Cleveland Electric Railway Company in favor of the Central Trust Company, of New York. Amount is \$1,900,000; \$1,000,000 to secure mortgage and remainder for liabilities due. Deed signed by President H. A. Everett.

CLEVELAND, O.—The Russell-Schofield franchises have been downed by the council on a third reading.

DAYTON, O.—Judge Dwyer and O. B. Brown have sold considerable stock for the Dayton Traction Company and claim road will be built in due time.

NORWALK, O.—The Sandusky, Milan & Huron Electric will ask to change its name to the Sandusky, Milan & Norwalk, and will also ask for discharge of J. C. Gilchrist as receiver. The sale of bonds has saved the road.

PIQUA, O.—As the steam roads will not undertake a branch road to Minster the Miami Valley Electric will probably do so. A line to Minster will undoubtedly pay.

YOUNGSTOWN, O.—The Youngstown, Falls & Park Electric Railway elect officers as follows: President, John I. Williams, Youngstown; vice-president, S. C. Grier, of Allegheny; treasurer, J. Harris McEwen, and secretary, Harry G. Hamilton, both of Youngstown.

■ **YOUNGSTOWN, O.**—The Youngstown Park & Falls Street Railway has applied for franchise and will begin work the day after franchise is granted.

Oregon.

OREGON CITY, OREGON.—The East Side Railway Company will build extensive additions, and a network of suburban lines is planned. Supplementary incorporation for the preliminary lines is already entered.

SALEM, ORE.—Salem Motor railway has begun work on a new car house at Morningside, 24x50 feet, with capacity for power at future date.

Pennsylvania.

ALLEGHENY, PA.—The finance committee of the council revokes the franchise of the Millvale, Etna & Sharpsburg Railway Company, alleging failure to keep agreement.

ALTOONA, PA.—The Cumberland Valley Electric Passenger Railway organized at \$300,000, by Oliver H. Ormsby, S. Ritter Ickes, W. J. Ickes, and S. S. Wigton, all of Altoona.

CHESTER, PA.—The Media, Middletown, Aston & Chester Electric Railway has been granted rights here and promises to begin building soon. Hon. W. M. Ward, Hon. John B. Robinson, E. H. Price, Edmund Jones, et al., all well known Delaware county capitalists, are in the company.

ERIE, PA.—Incorporated: The Edinboro & Erie Electric Railway, for thirty years, at \$200,000 to build sixteen and one-half miles electric railway. The incorporators are, Messrs. G. E. Rickman, of Brockton, a wealthy wine cellar man, well known in Erie; E. A. Fay and G. W. Fuller, of Portland, N. Y.; Chas. C. Curtice, of Rochester, and H. O. VanDusen, of New York. As soon as the councils in Erie grant the company the privilege of entering the city work will be commenced on the road.

PHILADELPHIA, PA.—Philadelphia Traction Company orders an issue of 56,000 additional shares of stock at par, giving stockholders pro rata privileges. In financial circles the new stock is considered a point in favor of the company.

PITTSBURG, PA.—The Coraopolis & Neville Island Electric line will erect bridge across Ohio and compete with the Ft. Wayne Railway Company. Contracts for power house will be let soon. Ten to fifteen cars will be bought.

POTTSTOWN, PA.—Ringling Rock Electric Railway Company, organized at \$100,000 to construct an electric railway from Pottstown to Ringling Hill, three miles north of this place, on which the famous ringling rocks are located, and where a fine park is to be made, for which 250 acres of ground have already been purchased. The officers of the company are: President, C. A. Guldin; vice-president, Samuel Fronheiser; secretary, R. E. Shaner; treasurer, A. K. Shaner; directors, Frank S. Brant, Jacob S. Bahr, George C. Hollenbach, M. R. Davidheiser, H. M. Boone.

PITTSBURGH, PA.—Pittston and Scranton franchise has been acquired by the Scranton Traction Company, by General Manager Archer. It is also announced that the Pittston Suburban franchise has been sold to the Wyoming Valley Company. The Wyoming will push things to completion.

SCRANTON, PA.—Mayor Connell signs three ordinances giving right of way to the Scranton Traction Company. Condition strict.

SHENANDOAH, PA.—B. Elwood Jones resigns as superintendent of the Schuylkill Traction Company, and will be succeeded by Edward W. Ash, now in New England.

TARENTUM, PA.—A new street railway company asks rights from the city council for the expired franchises of the Tarentum Passenger Railway Company. The new company wants to build to New Kensington, Parnassus and other places. The company will give bonds.

WASHINGTON, PA.—Brit. Hart, receiver of the Washington Street Railway, applies to court for order to sell the road, as its receipts will not warrant its remaining in receiver's hands. Taken under advisement

Rhode Island.

NEWPORT, R. I.—Newport Street Railway Company is without a superintendent, A. C. Ralph having resigned.

Tennessee.

NASHVILLE, TENN.—The Nashville capitalists who sold the Savannah Electric Railway Company are T. W. Wronite, J. H. Fall and G. M. Fogg.

WINCHESTER, TENN.—F. A. Pattie is elected treasurer of the Winchester, Paint Rock & Tennessee River Electric Railway.

Texas.

FT. WORTH, TEX.—In case of Thomas Worthington vs. the North Side Street Railway Company, court decides that the bonds worth \$150,000 are valid. Bonds are secured by liens.

Washington.

SEATTLE, WASH.—Guy C. Phinney, one of the wealthiest men in Seattle, and a street railway builder of prominence, died Sept. 12. He was worth \$500,000.

SEATTLE, WASH.—Guy C. Phinney, president and general manager of the Woodland Park Electric Railway, died suddenly last evening of heart disease.

TACOMA, WASH.—Joe T. Mitchell is appointed receiver for a part of the Point Defiance & Edison Railway.

West Virginia.

DENWOOD, W. VA.—An electric railway is reported to be about to be organized by local capitalists, to run from Oakland to Deer Park, a distance of eighteen miles. No names are yet announced.

WHEELING, W. VA.—Reymann's Hill is to be tunneled at a cost of \$400,000, and a doubled track electric railway built to Edgington by real estate owners interested in the land there.

Wisconsin.

MILWAUKEE, WIS.—The Wauwautosa Motor Line was to have been equipped with electricity, but the stringency in the money market forbids immediate action.

THE TROLLEY IN EGYPT.

The municipality of Cairo, Egypt, advertises for bids on an electric railway.—Press dispatch.

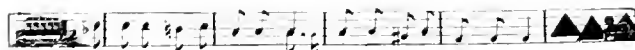

A trolley car went to Egypt land,
It played in the desert, and dug up the sand;
But it ran into a pyramid,
And then, I believe, that's all it did.
'Frol, lol, ley, boom de ay.

A LONDON FIRE.

IRON Gate wharf, Paddington, London, was the scene of a destructive fire, Saturday, September 16, when the forage stores of the London General Omnibus Company were totally destroyed by fire. The fire originated in some highly mysterious way, after the custom of fires, and at half past six in the morning the whole great building was a mass of smoke and flames. As the material was highly inflammable the firemen had a tremendous task.



BURNING OF THE LONDON OMNIBUS BARNS.

Every engine in the district was ordered to the scene, and finally, all the London department was ordered to stand in readiness. The flames were, however, finally subdued, but the structure was completely gutted. The loss was \$150,000.

Perfection in Traveling.

At 6:00 p. m., daily, one of the handsomest trains in the United States and known as the North-Western Limited, leaves the passenger station of the North-Western Line, in Chicago, on its journey to St. Paul and Minneapolis, the twin cities of the Northwest. Vestibuled throughout, and equipped with buffet, smoking, and library cars, private compartment sleeping cars, drawing-room sleepers, and superb dining cars, it furnishes its occupants with every comfort and convenience which could be desired by the most fastidious.

While in its entirety it undoubtedly takes rank with the finest trains in the world, there are two features of its equipment which deserve especial mention, for they are new departures in the western railway world:

The buffet, smoking and library car is furnished in the most luxurious manner, with comfortable arm chairs, writing desks, book-cases, and a well stocked buffet, from which light refreshments are served. The private compartment sleeping car is designed especially for the accommodation of family parties and ladies traveling without escort. It is composed of ten separate compartments, each complete in itself, and containing washstand, hot and cold running water, and all necessary toilet arrangements.

Aside from these two features, it is in keeping with the rest of the service to say that the supper served in the dining car, after the train leaves Chicago, is a meal calculated to please the epicure.

In a word, if you desire to travel in the most comfortable manner, and make the trip to St. Paul, Minneapolis, or any other point in the Northwest, in the quickest time, be sure that your ticket reads via the North-Western Line. Maps, time tables, and full information can be obtained upon application to any ticket agent, or by addressing W. A. Thrall, General Passenger and Ticket Agent, Chicago & North-Western Railway, Chicago.

PICTORIAL EVENTS OF THE MONTH.

MID AIR PERIL.—Sixty passengers in a North Hudson County Railroad car, running from Hoboken to Jersey City, found themselves in a rather precarious place, on the night of September 14. It was about

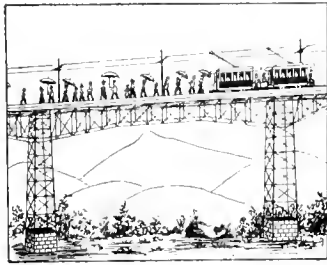

seven o'clock, and the night was dark and rainy, when the car wound its way on to the trestle leading to the Heights. Here, while at the highest point, the armature burned out and the car was left as helpless as a baby. A slight grade was sending the car backward, but the brakes did their duty until a car coming from behind tried to push the disabled common carrier up the hill. The load was too heavy, however, and

sixty disconsolate passengers found themselves one hundred feet above the ground on a trestle. The passengers of the disabled car, together with those from the blocked trains behind, began to be restive, and finally two hundred of them dismounted and walked the narrow path between the tracks to terra firma, dodging poles at intervals. All were safely landed, damp, miserable and curseful.

A NEW YORK sufferer of ingenious mind and a love for humanity, has suggested, through the columns of the New York Herald, a simple and effective remedy for the long-legged and sharp-kneed swine who persist in stretching their legs across three-fourths of a street car aisle. The mechanism proposed is simple, cheap, and will be effective. Reference to the drawing shows it to be a double circular buzz saw, running in grooves under the car and projecting into the vehicle. They travel up and down the length of the car, amputating any razor back knees or Number 10 feet. It may be geared to the rear axles.



AN electric car ran amuck recently in Duluth, ending its career at the bottom of the steep canal. A defective brake is alleged as the immediate cause of the misdemeanor. Only two passengers were at that time upon the car, and they, together with the crew, not having amphibious habits, jumped in time to avoid a cold bath.

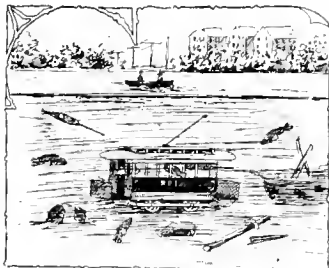

NEW YORK papers are making as much as possible out of their new cable road. When the paragrapher gets done saying bitter things, and the "old man" editorializes a little, the modest reporter writes a half column on "Rolling a 39-ton spool." The spool in question, was for the Third avenue cable, and which is 18,430 feet of 1½ inch steel. It was moved on rollers from Sixty-fourth street and the East River, to the power house. It began to move at 10:30 a. m. of one day and was landed the next night. A sharp grade was overcome, and considering the block and tackle method used, the trip was made in good time. The foreman of the moving gang, expressed, publicly, his thanks to his fellow-citizens who volunteered suggestions en route.

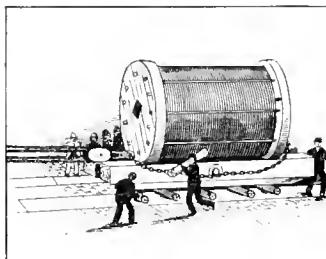

Joost, of San Francisco, has "joost" had more trouble with his San Francisco & San Mateo electric railway than most men have with a family of children. First with his franchise, then with the stockholders,



then with his creditors, and now the Mayor of San Francisco conspires to make life a ghastly dream. It seems that the mayor discovered that Mr. Joost was taking liberties with grades and streets, which he, the mayor, did not approve, so, without delay, the superintendent of streets was sent forth with a gang of laborers, and in a short time the track was rendered useless for rapid transit. Mr.

Joost says the mayor shall suffer, as the track was on Joost's private property.

PERSONALS.

A. C. SMITH, of Norwich, Conn., called at the REVIEW office recently.

J. B. M. HIROUS, general manager of the Lamokin Car Company, was a World's Fair visitor of September.

J. HENRY CARSON, of the Sterling Supply Company, of New York, was a recent caller at the REVIEW office.

MAJOR BORDEN and Mr. Purnell, leading citizens of Deadwood, S. D., were visitors at the REVIEW office this month.

W. W. HESS, Philadelphia, editor of The Car, has been doing the Fair and favored the REVIEW with a brotherly call.

W. P. LOVETT, head bookkeeper of the Lamokin Car Company, called on the STREET RAILWAY REVIEW last week.

S. V. PICKENS, superintendent of the Hendersonville, N. C., Street Railway Company, called on the REVIEW during the month.

SUPERINTENDENT ED CAMPBELL, of the Ottumwa, Ia., Street Railway Company, was a World's Fair visitor of the past month.

FRANK DUNDORE, of Philadelphia, well known in stock exchange circles, was a REVIEW visitor during his late Chicago and Exposition trip.

PRESIDENT HOLTON WOOD, of the Derby, Birmingham & Ansonia Railroad is in Chicago with the governor's staff. He will be at the Convention.

C. P. YOUNG, who, as superintendent of the electric railway system at Chattanooga, Tenn., has brought that road to a degree of excellence scarcely equalled, was a frequent REVIEW visitor during his visit to the World's Fair.

CHARLES E. PAYNE, superintendent of the San Bernardino, Cal., Street Railway Company, sustained severe injuries from a runaway horse recently.

H. J. SOMERSET, electrician of the Electric Street Railway, Winnipeg, Manitoba, put in two weeks at the Fair this month, and called at the REVIEW office.

F. H. SHEPARD, of the Milwaukee Street Railway electrical force, has left the company's service to take a course in the Massachusetts Institute of Technology at Boston.

THOMAS H. MCLEAN, the well known superintendent and general manager of the Citizens' Street Railway Company, of Indianapolis, called at the REVIEW office a few days ago.

WM. TURTON, of Leeds, England, is one of the most prominent street railway men in the United Kingdom. He is chairman of the Leeds, Bradford, Newcastle & Gasforth, and South Shields tramway companies, and director in three more such enterprises.

G. MESTRE, representing the well known French commercial establishment of G. Floquet, Paris, was a REVIEW caller. He will make an inspection of American street railways before returning to France.

W. S. G. BAKER, president and treasurer of the Baltimore Car Wheel Company, Baltimore, was a World's Fair visitor this month, and was warmly welcomed by his numerous friends in this city, where he formerly resided.

CHAS. G. SMITH, who as the "Smith, of New York," is known far and wide, and who has made an exceptional record as a successful manufacturer of street railway supplies, spent ten days, accompanied by his family, at the Fair, the early part of this month.

A. R. WALCOTT, superintendent of the Quincy, Mass., system of the Quincy & Boston, was the recipient lately of an office outfit from the directors and employes of the company. Mr. Walcott's services are highly appreciated by both his principals and subordinates.

MR. SPENCER, of the firm of Spencer & Waters, importers of foreign goods, with offices at Valparaiso and Santiago, Chili, was an Exposition visitor at the REVIEW office. The Spencer & Waters house is one of oldest and best known in the South American trade. Mr. Spencer goes back about the first of November.

GEORGE CRADOCK, of the firm of George Cradock & Company, whose extensive wire works are at Wakefield, England, is visiting the cable roads of this country, and spent several days in Chicago. He also attended the street railway convention. His company have now, and for a year or more past had, ropes running in the tunnel loop of the North Chicago Street Railroad, where they are giving a remarkable service. Among other cities which his company furnish is the Melbourne, Australia, cable lines, where for some time past they have supplied nearly all the ropes for the entire system of ninety miles, being the first English ropes used there. Mr. Cradock is a handsome type of the successful young English manufacturer, and an experienced and extensive traveler.

CANADIAN VOLTS.

From Our Special Correspondent.

THE Montreal Park & Island Railway Company is making great progress in its extension work, which will be completed by November 1. Mr. Roy, the company's engineer, has been a vigorous worker. By his advice, broken stone has been used as a top dressing for the road bed. Twenty-three foot American pattern cars are to be used. The company's office is at the Place d'Armes' hill, where in a late meeting the following management was elected: Hon. Louis Beaubien, president; Hon. J. R. Thibaudeau, vice-president; Robt. L. Gault, treasurer; Maurice Perrault, secretary and assistant treasurer; David Morrice, Henry Hogan and M. S. Loneragan, directors.

THE Montreal Street Railway Company is pushing its construction work as rapidly as possible, to be ready for winter.

THE London, Ontario, Street Railway Company was recently, by press dispatches, said to have in view a street railway ambulance service. In reply to a query of the REVIEW, S. R. Break, general manager, says: "We have not had in contemplation anything of the kind. Ours is a horse road, with the exception of one mile suburban line, which we are equipping with electricity now, and which will be running by October 25."

THE employes of the Toronto, Ont., Railway Company have organized a union and benefit society, and already have a membership of 626. The society is an oath bound one.

APPLICATION has been made for the incorporation of the Preston & Berlin Street Railway Company Limited, to operate a line from Preston to Berlin, capital \$100,000. Provisional directors are: Thos. Todd, Daniel Spiers, Wm. H. Sutz, of Galt; R. Gregory Cox, St. Catharines; T. M. Burt, Waterloo; Fred Clare, Preston; John Fennell, Berlin; and R. G. Dickson, Niagara. This road will connect at Preston with the Galt & Preston, and at Berlin with the Berlin & Waterloo Street Railways.

CANADIAN street railways are attracting considerable capital. The Galt & Preston Street Railway Company Limited, which comes to our notice by circular, is one of the latest. It is capitalized at \$50,000 by local capitalists of Galt and Preston, Ontario, and is officered by Thomas Todd, president, Galt; R. Gregory Cox, St. Catharines, vice-president; and W. H. Lutz, secretary and treasurer, Galt. It will carry mail and express.

THE Canadian Electrical Association held its annual meeting, September 12, at Toronto. Fifty members were present, and an interesting series of papers were read and discussed. The association is in the best of conditions and has promise of long life and increased usefulness. Among the papers, the one by A. C. McCallum on "Turbine Water Wheels," one by E. Carl Breithaupt on "Electric Street Railways," and one by John Langton on "Direct Connected Dynamos," were of most interest to street railway men.

An interesting exhibit of various electrical specialties and an enjoyable excursion to Niagara Falls were incidents thoroughly appreciated.

J. J. WRIGHT, of the Toronto Electric Light Company, is president of the association, and C. H. Mortimer, publisher of the Canadian Electrical News, is secretary-treasurer. His publication is the official organ of the association.

THE BERLIN IRON BRIDGE COMPANY, of East Berlin, Conn., has received the contract for the new power station for the Atlantic Improvement Company, Astoria, L. I. There will be two buildings, a boiler house 62 feet wide and 85 feet long, with a dynamo room 70 feet wide and 130 feet long. They will also build a new station for the Lynn Gas & Electric Company.

California in Three and One-Half Days.

If you are going to California and desire to make the journey in the most economical, quick and comfortable manner, purchase your ticket via the Chicago & Northwestern, Union Pacific and Southern Pacific Ry's. Pullman drawing-room sleeping cars are run from Chicago to San Francisco without change in three and one-half days. Completely furnished tourist sleeping cars are also run in which accommodations can be procured by passengers holding either first or second-class tickets at a cost of only \$4.00 per berth from Chicago to San Francisco and other California points. The hour of departure of trains from Chicago affords prompt connections with all trains from the east and south. Variable route excursion tickets, allowing nine month's stay in the health-giving climate of California, second-class tickets of low rates, sleeping car reservations and full information can be procured of any ticket agent, or by addressing W. A. Thrall, General Passenger and Ticket Agent, Chicago & Northwestern R'y., Chicago.

ECHOES FROM THE TRADE.

THE OREGON ELECTRICAL WORKS, Portland, Oregon, are making a specialty of model and experimental work.

THE RAILWAY EQUIPMENT COMPANY, Chicago, report business as good, and have taken a number of large orders within the past two weeks.

THE STERLING SUPPLY COMPANY, 47 Cedar street, New York, closed a contract with the Citizens, of Indianapolis, for 100 of their Sterling fare registers.

THE PECKHAM MOTOR, TRUCK & WHEEL COMPANY, of New York, has closed the contract for trucks for the Lancaster, Pa., and the Atchison, Kas., street railways.

EDWIN A. SMITH, general agent of the Consolidated Car Heating Company, Albany, has come to Chicago to look after the western business, and opened an office in the Phoenix building.

THE PORTLAND ELECTRIC COMPANY, of Portland, Oregon, which has for ten years been established in business at Portland, are doing a good business in light, experimental and special work.

OKONITE insulation is one of the watchwords of progress in efficiency. Feed wires and cables thus insulated will be found contributing to the highest economy. The valuable properties of this insulation are forcibly demonstrated in street railway service, and the large quantity used in wiring the Ferris wheel has caused universal comment.

GILBERT WILKES, for two years assistant naval inspector of electric lighting for the United States Government, and later chief inspector of the Edison Company, offers his services as consulting electrical engineer, and will advise on all questions of construction, conversion of horse lines, or on reduction of expenses. His address is 149 Griswold street, Detroit, Mich.

THE ANSONIA ELECTRIC COMPANY, of Chicago, is allowed by special order of the court to continue business, and orders entrusted to it will receive careful attention as formerly. Their overhead railway material will be given special attention. We are glad to know that the company will be still in the field, and congratulate Assignee J. B. Waller upon this fact.

THE M. C. BULLOCK MANUFACTURING COMPANY have recently begun the manufacture of the Willans vertical high speed engine, which has made so good a reputation in England for dynamo driving, where space is limited. They have issued a handsome "Columbian Circular," descriptive of this engine, giving information about some famous English plants using it.

THE SAFETY BRAKE SHOE COMPANY, of 620 Atlantic avenue, Boston, have a letter from an Ohio road, stating that their experience shows a pair of safety brake shoes will outlast four or five of gray iron and that they consider it economy to pay the additional price and save the trouble of frequent renewals. The Toledo Consolidated has given a second order for 200 shoes and the Detroit Citizens a second order for 300.

ALBERT & J. M. ANDERSON, of Boston, are now established, both offices and factory, at their new quarters, 289 to 293 A street, near Congress street, Boston, where all business is now transacted. The new plant consists of a well appointed, modern machine shop, thoroughly equipped with improved machinery and appliances for the manufacture of special machinery and electric railway supplies. With improved facilities and enlarged capacity for production, they will be enabled to largely increase their product, and give prompt attention to all orders.

WESTINGHOUSE, CHURCH, KERR & CO. have a contract for the 1,100-horse-power light and power plant for the terminal station of the Boston & Maine Railroad at Boston. In accordance with the well known policy of the company, mechanical draft, furnished by large Sturtevant fans will be used, bringing the draft under the control of the fireman instead of the weather. Westinghouse compound engines will drive direct and alternating current incandescent dynamos, and also those supplying power for drawbridges, elevators, turn tables, coal handlers, etc.

SMITH, of New York, whose excellent lamps enlighten the world, or at least a goodly portion of it, has a phenomenal business, considering the times, and has been running his factory at its full capacity all summer and is still doing so. It seems almost unnecessary to call attention to the testimony which this fact bears to the established excellence and high standard which has been so marked a characteristic of all the supplies made and sold by this successful establishment. One of his most recent appliances is a new oil burning headlight, which has met with special favor by users.

AMONG orders received by A. L. Ide & Son, Springfield, Ill., lately, are the following: One 100-horse-power Ideal engine, for the Ludington building, Chicago, second order; one 125-horse-power engine, for the Hoopston, Ill., Canning Company; three 175-horse-power Ideal tandem compound engines for the new Stock Exchange building, Chicago; two 125-horse-power and one 100-horse-power Ideal engines, for the Southern hotel, St. Louis. The Stock Exchange and Southern hotel engines all are to have General Electric multipolar armatures directly attached to their crank shafts.

THE OTTAWA CAR COMPANY, Limited, of Ottawa, Ontario, has elected Messrs. W. W. Wylie, Wm. Scott, T. Ahearn, J. W. McRae and W. Y. Soper as directors in the company.

THE J. M. JONES' SONS, West Troy, N. Y., are doing a splendid business. They are working 250 hands and have a fine line of new orders booked which will necessitate running the works full time for several months.

THE SCHUTTLER MANUFACTURING COMPANY, Chicago, received the award at the World's Columbian Exposition for their excellent ratchet drills, which have long been awarded highest endorsement by street railway track masters.

DR. KOHLMAN, president of the Tramway Association, of Germany, and owner of a road at Frankfurt, Germany, during his recent visit to Chicago, carefully examined the Standard street car stove, made by the Standard Railway Supply Company, Monadnock building. So well pleased was he that on his return he immediately organized a company for the manufacture and sale of these stoves, the company here having granted him the right to do so in Europe. He writes that the foreign tramway managers are greatly pleased with the stove and have already a large number ordered for immediate use.

THE good words of the New Orleans Picayune, in its book review column, of October 8, are appreciated. The Picayune says: "THE STREET RAILWAY REVIEW for September is a portly imperial quarto of 100 pages, crammed with all sorts of information of interest to the owners, managers and employes of street railways, brilliantly illuminated with a great many finely executed pictures and portraits. It well repays perusal." Coming from the most classical publication in the south or west, and in a column that knows not fear or favor, the STREET RAILWAY REVIEW receives it as a great compliment from the lay press.

L. B. LEVAKE, secretary of the School of Applied Electricity, at Cleveland, of which Professor E. P. Roberts is president, says that the school has the best of prospects for usefulness and long life. Mr. Roberts is a man of undoubted ability, both theoretical study and practical training fitting him for this work. He was graduated from Steven's Institute in '77, worked as draughtsman and taught night school, has been superintendent and general manager of several large light plants, was associate professor at Cornell University and has had for the past year a consulting office. The engineers of Cleveland are in hearty cooperation with Mr. Roberts and his school will undoubtedly be a great success.

ALBERT FISHER, western agent for the Altoona Manufacturing Company, and contracting engineer, with offices at 1025 Monadnock building, this city, made a brilliant record recently. In a single day, and in the face of strong competition, he closed a contract with the Farm-

ington, Ill., Light & Power Company, for a 150-horse-power, high speed, non-condensing M. A. Greene engine, built by the Altoona Manufacturing Company; two 125-horse-power boilers; one 175-horse-power heater, and all fixtures, and will install the plant. Mr. Fisher is also in receipt of the following strong letter, dated September 6, at the Intramural power house, World's Fair, of which Mr. McCloskie is chief engineer:—

"DEAR SIR:—I have had some experience with the engines you represent, especially at Altoona, in the street railway plant, and testify that in my opinion this engine is exceptionally well designed for electrical work, particularly for electric railway work. This is due largely to the perfect regulation under widely varying loads, and to the fact that all detail parts are very strong and heavy, enabling them to easily withstand the shocks incidental to sudden changes of load. A heavy flywheel is used, which, of course, aids in the regulation, and also gives a greater economy under frequent changes in output, a point which, I believe, was first made by Mr. Green, and one which is now admitted by all builders. This engine will give as good economy as any engine of its type, and in my estimation is as good as any high speed engine built in this country. YOURS truly, CHAS. H. MCCLOSKE, electrical engineer."

THE STANDARD RAILWAY SUPPLY COMPANY, Monadnock building, Chicago, manufacturers of the Standard street car stove, report a change in personnel, by which Ogden Balton purchases the interest in the business formerly held by T. C. Roberts, who is no longer connected with the company. Mr. Balton was for many years a manufacturer of steel at Canton, O., having been sent to this country from England by Dr. Siemens, in the early history of the open hearth steel process, to introduce it here. Engaging in steel manufacture at Canton for himself he amassed a fortune and retired from business, intending to divide his time between the east and his extensive interests at Los Angeles, California. Being an active man he was unable to remain out of business and now enters the company, to which he will devote a considerable portion of his time, and for which his long experience as a large manufacturer specially fits him. Garson Myers continues as genial manager of the company.

AMONG the recent changes that have been made in the cable plants of Chicago is the introduction of the well known Walker differential drums, made by the Walker Manufacturing Company, of Cleveland. In all of the three stations of the West Chicago Street Railroad the Walker differential drums have been put in. The Milwaukee avenue and West Madison street plants of this road were in no way delayed by the change. The old machinery weighing from thirty to fifty tons was taken out and the new put in during the five hours available between the regular time of stopping and starting the plant. The same drums will be used on the Van Buren street and Blue Island avenue stations now under construction. In these two stations two twenty-five ton traveling cranes are installed by the Walker people. The two differential drums at the North Clark street cable plant of the North Chicago Street Railroad Company, and the four at the Fifty-second street station of the City Railway, are giving good results and lengthening the life of the cables.

THE CHICAGO CITY RAILWAY FIRE.

Four Hundred and Sixty-One Horses Roasted—30 Cars Burned—
Loss, \$108,000.

THE most disastrous fire which has visited Chicago street railways in years, and one of the most fatal in the country, was the burning of the Wallace and Thirty-ninth street barns of the Chicago City Railway. Fire started in the feed grinding machinery about 6 p. m., October 12.

The barn was one large brick building, two stories in height and extending 400 feet on Wallace street and 190 on Thirty-ninth. In the second story was a quantity of feed, 200 tons of hay and 500 bushels of mixed grain, besides thirty winter cars. It was this necessarily inflammable material that made the destruction. A 4-11 alarm was turned in at six o'clock and fifteen engines were soon on the spot. The flames by this time were spreading rapidly and attention was immediately directed

LOS ANGELES CABLE ROAD SOLD.

AFTER many trials and much trying the Los Angeles Cable Road has finally been sold under foreclosure of judgment and passed into the hands of the Electric people October 4. The normal buyer was E. P. Clark and the price in full was \$1,344,320.48.

Mr. Clark was accompanied by Alvord & Brown, of San Francisco; B. Smith, of Chicago; Judge Silent, Judge Pope, General Sherman, Thos. McKee, of San Francisco; and J. M. C. Marble and Superintendent Aikin of the cable. The party went the rounds of the property and returning to the court house, Mr. Clark bid \$195,600 for the various stocks and shares of the properties and real estate appurtenant. This was accepted and then the franchises and other property put on the block. Mr. Clark was the only bidder and the price total was \$1,131,244.18. The feelings of the principal actors in the tragedy is not expressible in small pica type.

General Sherman, the president of the electric road

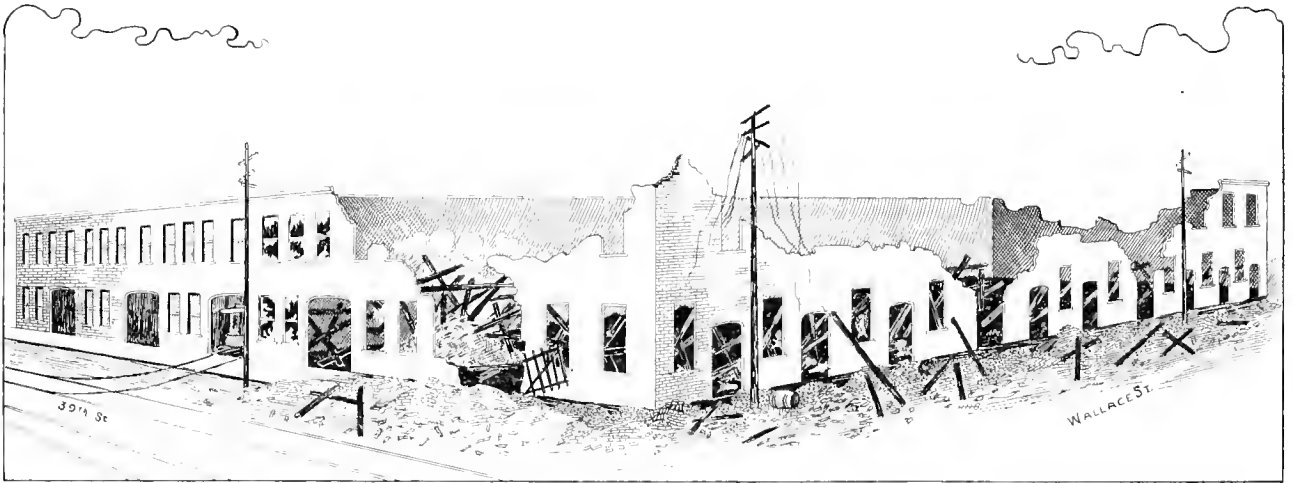

RUINS OF CHICAGO CITY RAILWAY HORSE BARN.

to the nearly 500 horses whose quarters were in the lower story. They could be heard plunging about in their narrow quarters. The hostlers, stable men and volunteers made heroic efforts to free the maddened animals and succeeded in saving twenty-one. These were driven over the dead bodies of their comrades. The scene was too sickening for description.

The cries of the hundreds of burning horses were audible for blocks, though only for a short time, as the fire burned rapidly. As usual, they refused to be saved when turned loose and huddled in great crowds. The work of removing the 461 dead bodies was a big job. The carcasses were sold to a rendering company. Loss on building was \$25,000; on horses, \$46,100; on cars, \$36,000. A big car barn adjoined the burned building but was saved by the heavy fire wall which separated the two. Our illustration is a sketch by the REVIEW artist the morning after the fire. The time of day was such that much of the equipment was out or the loss would have been even more serious.

was asked concerning his plans for the future of the cable and replied that the sale was made in the interests of a consolidation, but further than that nothing was certain. After the sale the gentlemen took a ride on Professor T. S. C. Lowe's mountain road and were entertained by that genial gentleman.

CONSOLIDATION IN KANSAS CITY.

NEGOTIATIONS are pending for the union of the Metropolitan and Grand avenue cable systems in Kansas City. Stockholders in both companies started the movement, chief among whom are Nathaniel Thayer, Francis Bartlett, H. H. Hunnewell and Chas. E. Cotting, of Boston. The Grand avenue has not paid a dividend since 1890 and it is thought that consolidation on an equitable basis will improve affairs. The Metropolitan is capitalized at \$2,800,000 and operates 23 miles of double track, while the Grand avenue capital stock is \$1,200,000 and its trackage nine miles.

FLUSH TRANSFER TABLE.

WHAT is said to be the only flush transfer table on the market is the one manufactured by the White Manufacturing Company of 556 West Thirty-fourth street, New York. It is intended to be operated either by hand power or by an electric motor. The rails of the table are necessarily higher than the surrounding tracks, so that inclined planes are carried on the table and extend out both ways over the standing tracks. These inclines are strips of iron 2 feet, 7 inches long and beveled down to give a gradual rise from the

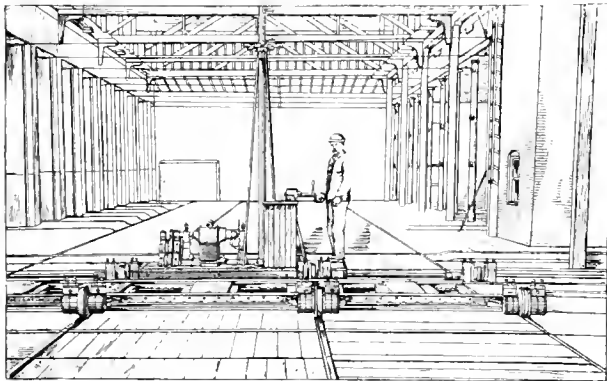

FLUSH TRANSFER TABLE

incoming rail to the table rail. These strips spring up and clear the rail by a quarter of an inch when the table is in motion. As soon as the wheels strike this incline the incline rails are sprung down. The table is 28 feet over all and 22½ feet long, not including the inclines. It is thoroughly cross braced, so that it is not liable to get out of square. There are many places where it is extremely inconvenient to have other than a level barn floor and for such the flush table will be found just the thing. Our illustration shows the table equipped to run with electric motor, or it may be easily pushed by one man. It is light, yet extremely firm and strong and built to stand the hardest possible wear.

THE CANTON CAR BARN CONFLAGRATION.

JUST launched on a successful career towards good dividends, the Canton-Massillon has suffered a severe back-set in the burning of its large car barns at Canton, O., October 3.

The fire began at 1:15 a. m., and is supposed to have originated in a car which was carelessly housed without inspection after a run, and in fact, now believed to have been burning when housed.

The car barn was a big frame structure, and the floor was saturated in various spots with oil and grease from the gearing and motors. The repair shops and the car building shops were immediately abutting the burned barns and the offices were in front, making the barn proper a regular fire trap. So quickly did the flames gain headway and so powerless was the fire corps, that

shortly after the alarm it was seen that all efforts must be addressed to saving the adjacent structures. The officials of the road were soon at the scene, but could do nothing more than direct the firemen and citizens. Not a car was saved. The superintendent states that there were twenty-seven cars in the barn. This list includes three closed cars of the Interurban line, four large open cars of the same line, six new closed cars of the city line and fourteen open motor cars. Thirty-six motors were destroyed, four 30-horse-power, twenty-eight 15-horse-power and four 20-horse-power. Much material, tools and parts were also lost. The company will replace the destroyed stock immediately. Ad interim, the Interurban is making half hour trips with such equipment as can be found, and the city line is doing without trips. The total loss, fully insured, was \$44,250, of which \$2,600 was on the car barn.

MODEL MEN.

Employees of the Orange, N. J., Suburban Ask for a Reduction in Wages Until the Road's Earnings Increase.

ONE of the most unusual communications ever addressed to a street railway manager by his men was received by Superintendent Cotton, of the Orange, N. J., Suburban. The line, which connects several small towns, has been greatly crippled in its earnings, owing to numerous factories shutting down, whose employes furnished a large share of its business. Although the road was running at a loss, the manager was endeavoring to pull through without cutting wages, although all other expenses had been reduced, and while nothing had been said to the men they could not help but know the road was losing. Imagine Mr. Cotton's surprise to receive the following letter:

SIR: We, the employes of your company, in meeting assembled, have come to the conclusion that, owing to the dullness in trade circles, thereby causing a falling off in the daily receipt of the cars of your company, we will, during the dull season, agree to a reduction in our wages as follows: Day men, \$1.75; night men, \$1.10; and the other employes correspondingly. The understanding to be that as soon as times become better our wages will be restored.

MICHAEL COFFEY, Chairman.
MARTIN HEALEY, Secretary.

Heretofore the day men have received \$2 a day and the night men \$1.25 for six hours work. The reduction proposed affects drivers, conductors, book-keepers and stablemen.

The reply made by the company to the above extraordinary proposition was as follows:

To the Employes of the Suburban Traction Company, Michael Coffey, Esq., Chairman.

GENTLEMEN: Your favor in regard to reduction of wages is received and your kind offer is accepted.

The company wishes to present to you its appreciation of the consideration shown by its employes, and it is a pleasure to its officers to have their employes appreciate the difficulties and losses against which the company is now contending. Very truly yours,

SUBURBAN TRACTION COMPANY,
(By F. W. Child, President.)

The company had no intimation of what was coming, and that President Child will not allow his men to be the

losers in the end by this manly act is not to be questioned, while a strong bond of sympathy has been cemented which offers a striking picture of what such harmony would mean if only it could prevail throughout the country. These men have earned the respect of the public and the lasting good will of their employers, and we sincerely trust that the days may be few and short until the time when their old wages or better may be possible.

A HOT PRESSED PINION.

THE steel pinion offered to the trade by the United States Projectile Company, of Brooklyn, N. Y., is radically different in its construction from any others in use. The old methods are cutting from the solid and casting. With cut pinions there is a temptation to reduce the wear on the tools by using soft metal. Cast steel pinions with the teeth recut are liable to be



STEEL BILLET.

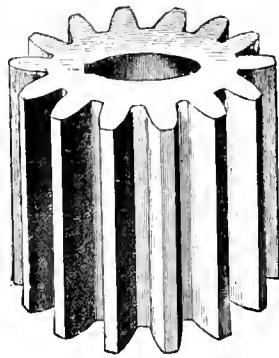

PRESSED GEAR.

brittle. To obviate some of these difficulties the above mentioned company has experimented with a method of hot pressing and, after running them on the Brooklyn City Railway for over a year with excellent results, they are placed on the market with the confidence that they are a superior article. To make a pinion, a round billet of steel is prepared, longer and of less diameter than the pinion to be pressed. For a W. P. 30 pinion this billet is $7\frac{1}{2}$ inches long by $3\frac{7}{8}$ inches diameter. This is heated white hot, put in a die and subjected to a 1,250,000 pound pressure. The metal is pressed into the teeth of the die and solidified more than by any other process. The pressure applied is equivalent to 80,000 pounds per square inch of surface. The teeth do not have to be cut or trimmed, as they are pressed accurately to size. The only machine work to be done after they are forced out of the dies is the boring, facing off the ends and the cutting of the key seat, which in no way robs the teeth of their best qualities. The hundreds of purposes in which pressed steel has demonstrated its superiority will be readily recognized by all.

THE South African tramways at Johannesburg has sufficient funds to admit the declaration of a 5 per cent dividend.

STREET RAILWAY PATENTS.

COMPILED BY THE STREET RAILWAY REVIEW.

ISSUED AUGUST 22, 1893.

Electric railway trolley switch, John H. Allison, Elkhart, Ind., assignor one half to John G. Rich, Auburn, N. Y., and Daniel G. Reed, Richmond, Ind.	503,570
Contact for conduit electric railways, Adolph Womer, Budapest, Austria Hungary, assignor to Siemens & Halske, Berlin, Germany	503,710

ISSUED AUGUST 29, 1893.

Fender and life guard for street cars, Samuel du Moulin, Boston, Mass.	504,081
Electric conduit for railways, Joseph I. Conklin, Brooklyn, N. Y.	504,104
Electric railway trolley, Alexander Palmros, Lynn, Mass., assignor one half to Varna J. Pierce, Hudson, Me.	504,113
Motor truck, John A. Brill and Walter S. Adams, said Adams assignor to said Brill.	504,149
Stringer plate, Edward Samuel, Philadelphia, Pa., assignor to William Wharton, Jr. & Company, same place.	504,176
Electric railway trolley, Frank J. Sprague and Patrick F. O'Shaughnessy, New York, N. Y., assignor to the Sprague Electric Railway & Motor Company, same place.	504,255
Crossing for electric railways, Jay Nelson, St. Louis, Mo., assignor one half to Thomas C. White, same place.	504,276

ISSUED SEPTEMBER 5, 1893.

Gear casing, William H. Forbes and Geo. B. Shepley, Brooklyn, N. Y.	504,338
Trolley wire cleaner, Mahlon Shaaber, Reading, Pa., assignor one half to Jacob S. Ammon, same place.	504,405
Life guard for street cars, Thomas Barnes, Lowell, Mass.	504,485
Tramway locomotive, Chas. D. Scott, Corry, Pa.	504,541
Conduit electric railway, Benson Bidwell, Philadelphia, Pa., assignor by mesne assignments of one half to Benson Bidwell, trustee.	504,549
Hydropneumatic motor, William Cooper, Minneapolis, Minn.	504,670
Conduit for electric railways, Samuel H. Plagg, Providence, R. I.	504,676

ISSUED SEPTEMBER 12, 1893.

Fare register, Chas. S. Lewis, Waterbury, Conn., assignor one half to William E. Fulton, same place.	504,731
Safety attachment for cars, Ingham W. Bisbing and John E. Gerhart, Philadelphia, Pa.	504,798
Motor truck, John A. Brill, Philadelphia, Pa.	504,800
Railroad rail chair, Francis P. Reilly, New York, N. Y., assignor by mesne assignments to the Johnson Company, of Pennsylvania.	504,818
Conduit electric railway, Henry D. Oler, Paterson, N. J.	504,847
Supply system for electric railways, George F. Green, Kalamazoo, Mich., assignor one half to Oliver S. Kelly, Springfield, O., Martha L. Green, executrix of said George F. Green, deceased.	504,977
Street railway switch, Pierre J. Boris, Boston, Mass.	505,077
Conduit electric railway, Charles O. Elbert, New York, N. Y.	505,081

ISSUED SEPTEMBER 19, 1893.

Rail heating device, Charles S. Smith and Elmer E. Knowles, Spokane, Wash.	505,135
Street car register, Onesime E. Michaud, St. Louis, Mo.	505,167
Current conveyor for electric railways, William Lawrence, New York, N. Y., assignor to the Lawrence Electric Company, same place.	505,204
Electric railway trolley, Elbert R. Robinson, Nashville, Tenn.	505,370

A SPOKANE inventor has patented a scheme for heating the track rails. Whether this is intended to melt the snow and ice which makes trouble in winter, or to scare off the small barefoot boy, who is the motorman's trial in summer, we do not know. It may be intended as a remote means of car heating, or perhaps as a method for tempering the climate of northwestern cities in forty below zero weather. It would seem equally practical in either case.

THE NEW TAYLOR TRUCK.

SAFETY BRAKE SHOE.

TWO months ago the REVIEW promised its readers the details of a new type of truck to be manufactured by the Taylor Electric Truck Company of Troy, New York, as soon as the particulars could be made public. It is the object of this article to keep that promise and to introduce to the REVIEW constituency the merits of the new Taylor Empire State Radial Truck and to assist the explanation by presenting the accompanying engraving. The Empire State is essentially a radial type, combining the advantages of supporting the car-body on elliptic springs. The principal points of the Empire State briefly reviewed are these: It is constructed with a continuous steel frame on both sides of which and underneath is a steel arch bar riveted to the frame. In the center and resting on the arch bar is a cross-tie bar on which the elliptic springs are secured and binding the frame together, preventing the pedestals from spreading when rounding curves at high speed. The pedestals that

QUITE a novelty in brake shoe construction, being introduced by the Safety Brake Shoe Company, of 620 Atlantic avenue, Boston, is here illustrated as made for both steam and street railways.



STEAM RAILWAY.



ELECTRIC RAILWAY.

Their peculiarity consists in having wooden plugs embedded in their wearing face and securely fastened

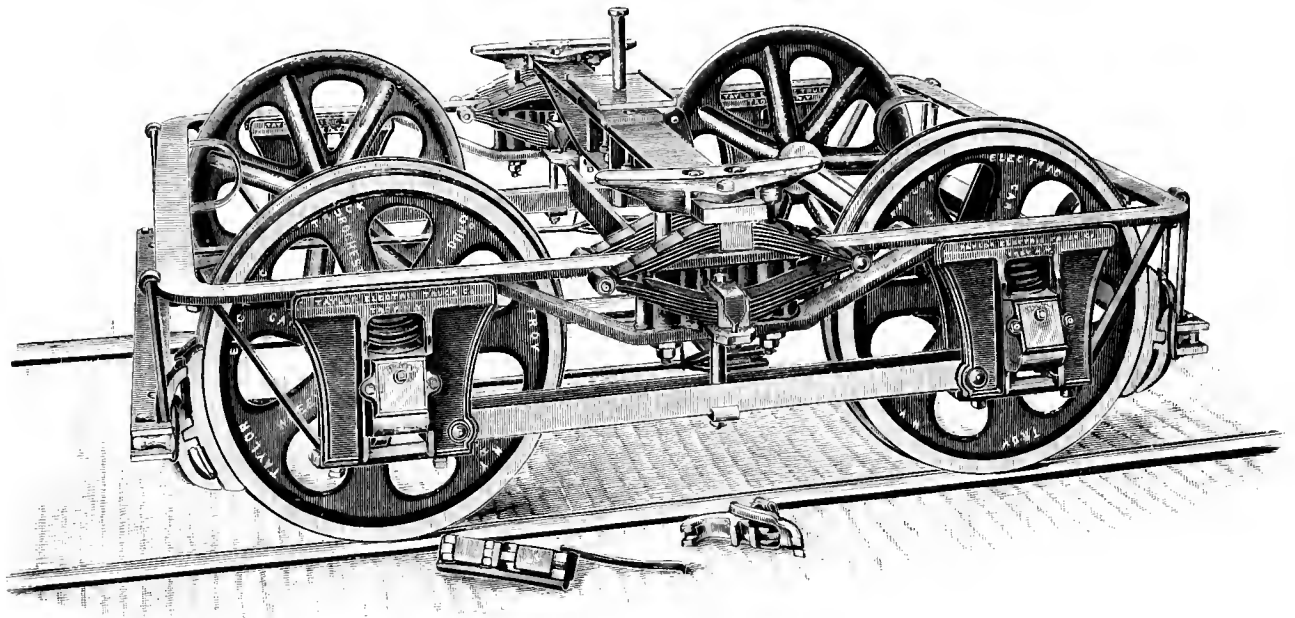

TAYLOR EMPIRE STATE.

receive the axle boxes are bolted to the continuous frame. The axle boxes slide freely between the guides of the pedestal. Above and resting on the axle boxes are springs that give the free and elastic motion for which Taylor trucks are noted. Upon the elliptic springs but not fastened to them is the truck bolster. All the details of the workmanship and the brake and brake shoe accessories are of the best, and special construction. The new truck promises excellent results.

upon a locking device to prevent their working loose. The advantages are absence of noise and shrieking, an important consideration especially on elevated roads and a more even hold on the wheels, making smoother stops. They are in use on over a hundred roads and are said to be specially effective in wet weather and suited to heavy grades. Those using them find that it pays to give the slightly higher price for these brake shoes rather than buy so many sets of common ones.

SUPERINTENDENT YOUNG, of Chattanooga, finds time from running his cars to invent a burglar proof safe, for express messengers and valuables, to be built of steel and close automatically when the express messenger steps inside. The same movement also raises thunder with desperadoes, who are struck by several thousand loose volts when they toy with the door knobs and grab handles.

THE Delaware, Lackawana & Western Railroad at Newark, attempted to vent its spite against one of the Consolidated Traction Company's lines by ordering the gateman at a grade crossing not to let the electric cars cross. The electric demonstrated that crossing gates are but a slight obstruction and the railroad had a new set of gates to buy. The electric has met no more opposition.

AWARDS IN THE STREET RAILWAY INDUSTRIES AT THE WORLD'S FAIR.

AWARDS in the departments of electricity and transportation have been made, and give general satisfaction, and we publish below the names of those winners whose exhibits touch street railway practice, in each department.

The method has been to require each exhibitor to make claims of excellence and superiority. These claims were examined, and to each claim substantiated to the satisfaction of the judges, notice has been given. Certificates of award are issued for such as have made satisfactory claims to the examining judges.

In the railway group, No. 80, the following manufacturers, whose products touch the street railway field, have been given awards:

Schuttler Manufacturing Co., Chicago, ratchet drills; Griffin Wheel & Foundry Company, Chicago, chilled iron car wheels; Jones Car Construction Company, Chicago, nut locks; General Electric Company, electric locomotive; New York Air Brake Company, air brake; Consolidated Car Heating Company, Albany, N. Y., improved commingler system, direct steam heating; Sheffield Car Company, Three Rivers, Mich., light cars, velocipedes and standpipe; Hale & Kilburn Manufacturing Company, car seats, etc.

In the Electricity building the full list of awards is a very catalog. Those manufacturers in whom the street railway interests are represented are:

A. & J. M. Anderson, Boston; Eddy Electric Manufacturing Company; General Electric Company; Nutting Electric Company; John A. Roebling; Sperry Railway Company; Short Electric Railway Company; Westinghouse Electric Manufacturing Company; Siemens & Halske; Walworth Manufacturing Company.

The most important group is No. 81, which includes all distinctly street railway specialties. The points of excellence are too numerous to mention, and the REVIEW is forced to be content with the mere mention of the awarded specialties. They are, in brief, and classified, as follows:

CARS.—Pullman Palace Car Company, single and double deck street cars; J. M. Jones' Sons, West Troy, New York, body, open electric car, body, closed electric car; John Stephenson Company, Limited, New York, "Broadway" cable car, electric motor car; E. H. Wilson, Philadelphia, open and closed vestibuled street cars; Carris Urbana Company, Rio de Janeiro, tramway street horse car.

RAILS.—Wm. Wharton, Jr. & Company, rails, fittings and special work for street railways; Johnson Company, Johnstown, street railway appliances; Hoerde Mining & Steel Company, Hoerde, Germany, street railroad switches, grooved rails, wheel tires, axles, etc.; Phoenix Aktiengesellschaft fur Bergbau und Huttenbetrieb, Laar, Germany, construction of street rail road tracks, sections, profiles, etc.

TRUCKS.—McGuire Manufacturing Company, Chicago, trucks; Peckham Motor Wheel & Truck Company, Kingston, N. Y., electric motor trucks; Bemis Car Box Company, Springfield, Mass., electrical motor truck; Robinson Electric Truck and Supply Company, Boston, electric radial truck; Robinson Machine Company, Altoona, Pa., electric car truck.

ELECTRIC CAR EQUIPMENTS.—Westinghouse Electric & Manufacturing Company, Pittsburg, Pa., street railway electric car equipments.

MISCELLANEOUS.—Street Railway Review; International Register Company, conductor's portable register; Genett Air Brake Company, air brake equipment for electric and cable railway cars; Jas. H. Steadman, Rochester, N. Y., detective transfers; Columbian Intramural Railway, Jackson Park, electric elevated railway; Lambeth Cotton Rope Company, New Bedford, Mass., Lambeth cotton rope; Washburn & Moen, cables for street railways; A. S. Hallide, San Francisco, passenger and grip car, ropeway and grip, historical collection of cable systems; California Wire Works, wire ropes and cables; Trenton Iron Com-

pany, Trenton, N. J., interlocked wire ropes and cables, aerial tramways and rolling stock; Daimler Motor Company, Cannstadt, Germany, street car motor; J. Poklig, Cologne, photographs and plans of cable roads; Felton & Guillaume, Muhlheim, Germany, ropes for cable roads; Street Railway Review, Chicago.

The last interesting group is, special railways. Multiple Speed & Traction Company, Chicago, double moving sidewalk.

The method of awarding is unique, but, we believe, generally satisfactory. The judges were all men of experience, except in the street railway group, and the absence of street railway men there, is entirely due to the indifference of the exhibitors, to whom notice was duly given both by Mr. Young and through the STREET RAILWAY REVIEW Daily Bulletin.

NEW PUBLICATIONS.

THE Rice Machinery Company have just issued their Machinery Bulletin No. 7, a copy of which all users of power are entitled to

ELECTRIC TRUCKS AND SPRING SUSPENSION is the subject of a neat little eight page book distributed at the Milwaukee convention by the Graham Equipment Company

LIPPINCOTT'S MAGAZINE FOR OCTOBER contains a pleasing tale of Kentucky family life, by Mary J. Holmes, entitled "The Hepburn Line." Other short stories are "Poor Yorick," by Robert N. Stephens, and the "Pass'n's Grip," by Rosewell Page, both illustrated.

THE catalogue of the Chas. Munson Belting Company for this year is not only a thing of beauty, but of educational value. It teaches the lay reader something about the way first class belts are constructed, and indirectly is a drawing card for Munson belting, by making him satisfied with nothing but the best.

AERONAUTICS is the title of a new comer in the technical field. The publication of the papers of the International conference on Aerial Navigation was entrusted to the American Engineer and Railroad Journal, which paper publishes Aeronautics as a supplement. It will continue the report of the congress, for some months.

Luxury on Wheels.

The C. H. & D. have purchased from the Pullman Company some new compartment sleepers, claimed to be the finest cars in the world.

They are lighted by Pintsch gas, and have ten complete drawing rooms in each car. Cars are arranged to have an aisle through the center as well as on the side, except when the occupant of one of the compartments desires to retire, when, by closing the doors, a private drawing room is provided. All the rooms contain double lower and upper berths, gas chandelier, and lavatory. A description of one, with slight modifications as to color of decorations, will apply to all. The first room in the series is square, and contains, besides upper and lower double berths, a good sized upholstered square wicker chair, and a lavatory, with white marble bowl, supplied with hot and cold water. Mahogany wainscoting reaches to the height of the sills, and is followed to the ceiling by painted woodwork, of pea green, stippled with gold. Beveled glass mirrors, in beautiful green and gold frame-work, supplant the plush panel in places convenient for the toilet. A sliding door connects this room with the next, and so on in turn. Certainly, even the Alhambra of the Moors in its day, was not more beautiful or more harmoniously decorated than one of these cars.

They will be placed on the C. H. & D. and the Monon, the "Electric" route between Cincinnati and Chicago, the only line running vestibuled leepers and diners between these points. For rates, etc., address E. O. McCormick, general passenger and ticket agent, "World's Fair Route," 200 West Fourth street, Cincinnati, Ohio.

THE Madras, India, tramway is to be pushed forward as fast as possible. It is to be worked on the conduit system devised by T. Parker, of the Electric Construction Company, of Wolverhampton, England. J. J. Robbins, of the same company, has charge of the construction of the line.

THE BAKER HEATER.

HOW to heat a car so that a positive circulation of air may be obtained and yet economize room is the subject of this article and the object of the inventive genius of William C. Baker, New York, successor to the Baker Heater Company.

The first premise of the Baker heater is that it shall occupy the place of but one person, when placed through the seat. This fulfills the economic idea. The constant circulation of the heated air is attained in the manner illustrated by the engraving. The cold air is drawn in at the bottom of the cylindrical outer covering and discharged heated at the top, warming the car quickly and

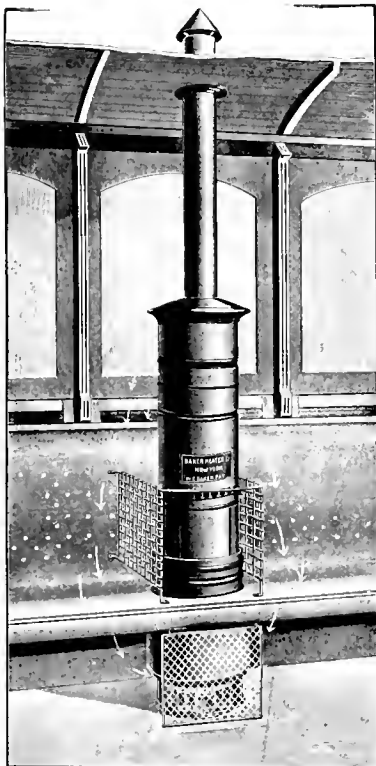

THE BAKER HEATER.

thoroughly by the most approved and scientific method. This treatment maintains a cool surface for the outside of the heater, heating the entire interior of the car and not the unfortunate passenger next to the heater. The device is but nine inches in diameter and weighs complete only 120 pounds. The fire pot is cast iron and the outer casing Russian iron. No bricks are used. A safe grate and removable ash pan are features. The economy of the heater is its strongest claim to attention as the manufacturer avers that it saves one-third the fuel used by other methods.

The Second avenue road in New York has used it for three years on 170 cars at, it is said, the expense of only five cents per 24 hours for fuel.

GAS motors are being thoroughly tried at various places in Switzerland, where small capital and poor facilities for central stations require such methods.

A BELT OF STEEL AND COTTON.

LEATHER has long been the orthodox material for belts used in heavy power transmission. Now, however, the bovine epidermis has a competitor, in the form of iron and cotton. The Maddox wire belt, recently put on the market by H. N. Green, of 254 Fulton street, New York, is shown in the accompanying engraving. The strength of this belt is derived from cabled soft steel woven wires, on which the bearing surface of cotton is placed. The cables are laid lengthwise of the belt, about one-eighth of an inch apart. Over these is woven the strong, tough cotton yarn, spun especially for this belting, which completely covers the cables and forms the bearing surface on the pulley. The process of weaving causes the cables to become corrugated in form.

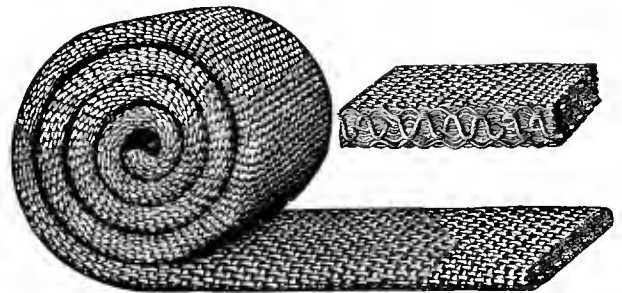

The cotton is woven so tightly around the cables that it makes the belt very strong, while being flexible. It is cheaper in first cost than leather, and considering the materials from which it is made, ought not to be affected by oil and moisture as badly as leather. The cotton is impregnated with a waterproof material. Of course it is easy to make this belt as heavy and heavier than double leather belting, and its strength, durability and cheapness would seem to promise a ready sale. Another advantage which is difficult to attain with leather is an absolute uniformity regardless of length, as it is possible to make a belt of this kind a mile long, and have every foot exactly the same as every other. It can be laced as well as leather, an awl being used instead of a punch.

Custer's Last Battlefield.

A visit to this spot, which is now a National Cemetery, is extremely interesting. Here, seventeen years ago, General Custer and five companies of the Seventh U. S. Cavalry, numbering over 200 officers and men, were cut to pieces by the Sioux Indians and allied tribes under Sitting Bull. The battlefield, the valley of the Little Big Horn, located some forty odd miles south of Custer, Montana, a station on the Northern Pacific Railroad, can be easily reached by stage. If you will write Chas. F. Fee, St. Paul, Minnesota, inclosing four cents in postage, he will send you a handsomely illustrated 100 page book, free of charge, in which you will find a graphic account of the sad catastrophe which overtook the brave Custer and his followers in the valley of the Little Big Horn, in June, '76.



THE MORSE CAR MANUFACTURING COMPANY.

THE C. D. Morse Car Manufacturing Company is the new name of C. D. Morse & Company, of Millbury, Mass. The concern was established in 1842 and has since grown to a car manufacturing plant of considerable size and excellent facilities for turning out work. They also give attention to snow plows, transfer tables, sweepers and car wood work. The open car here illustrated was built for the Worcester & Millbury Electric Railway Company. They call special attention to the method of bracing the foot board at the ends. This company is building cars for the Worcester, Leicester & Spencer Railway Company of Worcester and the Norfolk Suburban Railway. They have also built a large number of transfer tables of which seven are in the service of the Union Railway Company of Providence, R. I. President Morse, after whom the company is named is a widely known and highly respected citizen and has for

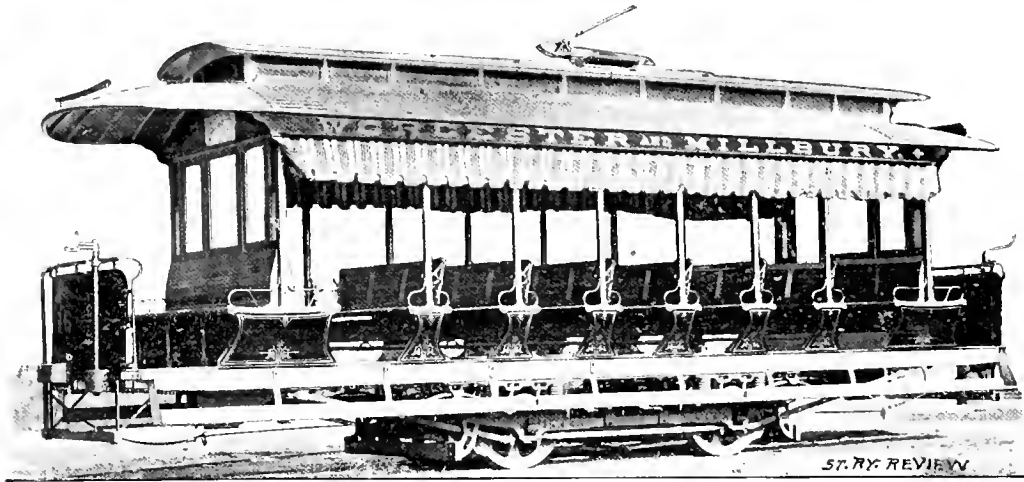

A MORSE CAR COMPANY' CAR.

many years been president of the First National Bank of his city, where his financial and executive ability are fully recognized.

CHAS. A. SCHIEREN, of the Schieren Company, has accepted the nomination for mayor on the republican ticket for Brooklyn. He will take up the glove against the present incumbent, Mayor Boody, and make a gallant, and, we hope, successful fight.

GEO. S. WHIPP, member of the firm of Hartshone & Whipp, with offices in the Havemeyer building, New York city, is making a fine reputation as a street railway builder. He has finished the Jersey City and Bayonne Railway, eighteen miles in length. The line is laid with Pennsylvania girder, 90 pounds to the yard, on a substantially constructed road bed. Besides this business, Mr. Whipp is selling agent for the J. W. Fowler Car Company, in which line of work his large street railway acquaintance, affability and knowledge of affairs, will make him particularly successful.

MARRIED.

ON October 4, R. W. Rippetoe, president of the Terre Haute, Ind., Street Railway Company, and Mrs. Laura E. Smith, of Frankfort, Ind., were married at the latter's residence, by the Rev. Mr. Kessler, of the Lutheran church. J. W. Landrum and Michael Burke, of the Terre Haute company, were present at the wedding. The REVIEW extends its congratulations, and wishes the couple a long and pleasant life-trip.

LYNDS-PARTRIDGE.

The enterprising and successful young dealer in street railway supplies, St. Louis, was married on Wednesday evening, Oct. 11, at the Second Baptist Church, to Miss Emma M. Lynds, of that city. The reception which followed at the residence of the bride's parents, 3645 Finney avenue, was one of the notable society events of the month. Mr. and Mrs. Partridge will be at home, Thurs-

days in December, at 514 North Spring avenue, and have the very best wishes of an unusually large circle of friends, with whom the REVIEW joins in congratulations.

HUME-NORTHUP.

On September 20, Sumner Waldo Hume, western manager and vice-president of our esteemed contemporary, Power, and Miss Millie M. Northup, of Brooklyn, N. Y., were united in marriage at the Janes Methodist Episcopal church at Brooklyn. A large company of friends witnessed the ceremony, and a still larger circle of business and social acquaintances of the groom wish the pair all the happiness life is capable of bestowing. The REVIEW extends its congratulations.

SHE was an exceptionally stout woman and when she loomed up in the door of the street car the men looked out of the window as if they had not the remotest idea that she was about. But a lank youth in the corner was equal to the occasion and piped up shrilly, "I will be one of four to get up and give that lady a seat."

EXHIBITS OF THE CONVENTION.

Continued from Page 618.

WM. SUTTON, hardly thought it necessary to send special exhibit cars, as those of his make already in the city made a permanent exhibit in themselves. Mr. Sutton has attended so many conventions he is entitled to membership in the old settler's club.

THE JOHN STEPHENSON COMPANY, New York, made no other exhibit than cars in daily service on Milwaukee roads, and their veteran representative, D. W. Pugh, without whom no convention would be complete. President Tackaberry was also present.

THE STREET RAILWAY REVIEW had a good-sized space, and acknowledges the calls of several hundred friends. It was represented by H. H. Windsor and C. L. Snowden, of the editorial department, and F. S. Kenfield and H. J. Kenfield, of the business department.

J. C. BOYD, the genial superintendent of the Jewett Car Company, of Jewett, O., came to Milwaukee alone to meet the brethren. He represents the Jewett business as flourishing, with several big orders notably from the recently burned out Canton-Masselon, O., line.

which they sell to many street railway companies. Its claims are that it is positively strong, will not work off, and needs no washers. C. H. Hoffman was in charge.

ROBERTS WOVEN WIRE CAR SEAT COMPANY had a small space devoted to the sanitary and comfortable woven wire seat made by the Hartford Woven Wire Mattress Company, of Hartford, Conn., and superintended by H. F. Evans, of St. Louis, the western agent.

THE LAMOKIN CAR COMPANY, Philadelphia, made no exhibit, on account of the nearness of their exhibit at the World's Fair, and also having cars on the streets of Milwaukee. G. E. Pratt, general sales agent, was everywhere, and Superintendent Cochran was also in attendance.

THE W. T. C. MACALLEN COMPANY was represented by P. H. Carey, of Harrison & Carey, who was more present than the Milwaukee small boy. His sermons were principally on sheet mica circuit breakers and insulated crossings, illustrated by practical examples in a neat booth.

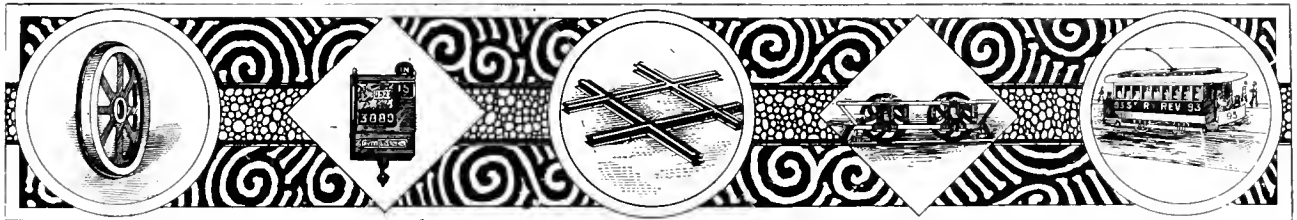

THE KENNELLY patent standard electrostatic voltmeter was represented by J. W. Gladstone, manager of the company, the Edison Manufacturing Company, of New York. The price of the voltmeter is but \$40. Its durability and sensitiveness are its principal claims.

THE COLUMBIA STREET CAR HEATER was exhibited by A. Colliander, of 122 North Sangamon street, Chicago. It attracted the undivided attention of a large number of practical street railway men. The stove shown was neat in construction and general make-up.

THE ROCHESTER CAR WHEEL COMPANY, of Rochester, N. Y., had a full collection of motor and car wheels in a centrally placed space. Eldridge Baker, of Rochester, was accompanist and well preached the gospel of good wheels. Manager F. D. Russell was also present.

THE JOHNSON COMPANY, Johnstown, Pa., had a display of some of their universally known crossing, frog and switch work. Messrs. Littlefield and Evans, of the Chicago office, and Major Evans, of the New York office, and Vice-President Coolidge, of Johnstown, were present.

THE NATIONAL ELASTIC NUT COMPANY, of Milwaukee, had a complete exhibit of bolts and elastic steel nuts

THE CUMMINGS & ENGLEMAN CONDUIT COMPANY, of Detroit, showed their underground conduits for long distance transmission of power. The company owns the United States rights of the Cummings patents. E. M. Engleman, secretary and treasurer, accompanied the exhibit.

THE STREET RAILWAY TUBULAR JOURNAL & AXLE COMPANY, of Cedar Rapids, Ia., represented by J. M. May, had a device for lessening the severe blows and concussion of wheels against rails on curves. It is highly recommended by the Cedar Rapids Street Railway superintendent.

THE JONES CAR COMPANY, Troy, was represented by J. M. Jones, Sr., and J. M. Jones, Jr., both of whom are well known to a large contingent of street railway men found their time fully occupied in meeting old friends and making new ones. Their exhibit was cars in regular service in the city.

THE CUDAHY LUBRICATING COMPANY had a full line of grease for trucks, bearings and curves, in charge of which was H. W. Kent, general manager, who is a splendid man, and an authority on grease. They have been doing a big business, and will work more and more into street railway work.

Street Railway Review

THE UNITED STATES PROJECTILE COMPANY, of Brooklyn, N. Y., in charge of A. T. Porter, manager, showed their patent hot pressed motor pinions, claiming toughness and durability, wearing qualities and cheapness. Mr. Porter was highly successful in interesting manufacturers and railway men in his specialties.

THE BARNEY & SMITH CAR COMPANY, of Dayton, O., whose latest venture is in the building of cable, electric and horse cars, was represented at the convention by A. M. Kittredge, the superintendent. The B. & S. Company is so well known in their railway business that further remarks on their prospects are needless.

THE R. D. NUTTALL COMPANY, of Allegheny, had a fine exhibit and a neat booth. They were represented by Manager Davidson, of the Chicago office, who found his hands full with the admirers of the Nuttall goods, and of enquirers. All the Nuttall specialties were shown, and comment elicited was of the most favorable character.

THE WADHAMS OIL & GREASE COMPANY, of Milwaukee, had a fine showing of their various lubricants for use in street railway plants. Their graphite curve

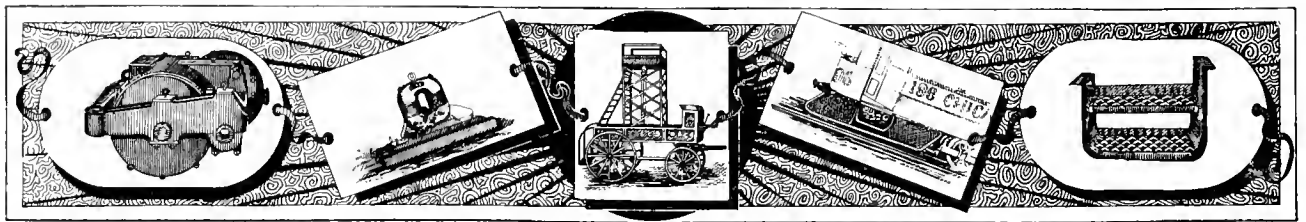

grease was particularly borne upon. A colored youth in uniform dealt out interesting reading matter to visitors, and members of the firm were always present and pleasant.

EVEN THE STANDARD OIL COMPANY was there with a full line of lubricants made from petroleum and in charge of A. J. Capron, of the Milwaukee office. Twenty samples were shown, particularly the Capital cylinder and the Renown engine oil. A big chunk of paraffine gave everybody a chance to chew real natural chewing gum.

THE PAIGE IRON WORKS, of Chicago, brought a full line of girders and T street rail and specimens of special crossing, switch and curve work. The exhibit was one of the largest in the building and ably represented by Edgar D. Nethercut, consulting engineer, A. W. Paige, president, and G. F. Starkweather, manager of the company.

THE BASS FOUNDRY & MACHINE COMPANY, of Fort Wayne, Ind., by some blunder of the railroads, failed to receive a large exhibit of cushioned car wheels and chilled cast iron wheels. J. L. White, the secretary of the company, was present, however, and circulated freely among the visitors. He was one of the most popular supply men present. P. F. Leach of Chicago arrived Thursday.

THE LINK BELT MACHINERY COMPANY, of Chicago, sent their S. B. Peck, consulting engineer, and a big Ewart clutch, showing the rope transmission ideas of the link belt people. The Ewart clutch was the subject of much favorable comment and the consulting engineer had his time pretty well taken up with the numerous questions asked by the visitors.

THE WESTERN ELECTRIC COMPANY was well represented by H. C. Eddy, of Chicago. Mr. Eddy had gathered a good representation of weather proof magnet wire, lamp cord and samples of Patterson cable. All these are of the Western Electric Company. The display, although not large, was well remarked by visitors and Mr. Eddy did the company credit as host.

THE ST. LOUIS REGISTER COMPANY had a stand devoted to that specialty, over which Secretary Wickham presided. If anyone wished to see more registers of the St. Louis type all that was required was to jump on a Hinsey line or Pfister line car. The fares rang up by the visitors, although numerous, did not exhaust the St. Louis register nor the temper of Mr. Wickham.

CHAS. L. BOWLER, of Sawyer, Manning & Company, New York, had a fine line of samples of their woollens, manufactured expressly for street car uniforms. They attracted much attention, and several managers who contemplate uniforming their men, availed themselves of Mr. Bowler's long years of experience in manufacturing uniforms to become fully posted on the subject.

GARON MEYERS showed thirty standard car heaters, neatly arranged en banque, to illustrate their popularity, their elegance of finish and that peculiar property of "not cutting the car seat." The Standard Railway Supply Company's exhibit was one of the neatest shown. Mr. Myers' agreeable presence and the fine catalog distributed, helped proclaim the excellence of Standard stoves.

THE BROWNELL CAR COMPANY, St. Louis, did not bring cars to Milwaukee to exhibit, although they have on previous occasions brought cars there, which have remained and are in daily service. They gave out invitations to all to visit their splendidly decorated car at the World's Fair, the most elaborate ever made, and President Brownell and W. B. Allen spent the time in meeting acquaintances.

THE KEYSTONE CHEMICAL COMPANY, of No. 11 West Lake street, Chicago, showed in a number of bottles

awful examples of feed water, together with some very hard looking specimens of boiler scale. The Keystone people have a resolvent for these ills in the sodium triphosphate, a simple chemical which purifies the water and obviates scale and boiler deterioration. Prices and methods were quoted.

THE MEAKER MANUFACTURING COMPANY, of Chicago, came, of course, and as it wouldn't seem like convention otherwise. John W. Meaker came with the full line of registers which proclaimed with their bells, bells, bells, that the Meaker Company could not stay away from a gathering of men that would miss both man and manufacture. Nothing would be more conspicuous than its absence, and the register is just as good as ever.

THE INTERNATIONAL ELECTRIC COMPANY, of No. 279 Fourth avenue, Detroit, has an electric heater that is a promising affair. It is a horizontal, open coil type, built for 500 volts. A. S. Hatch, secretary, was in charge and said of a large number made not one was burnt out. The heater is 1½ amperes capacity, but for regular use is made for 1 ampere, using 4 in the car. Mr. Hatch is in the general supply business and is a practical man.

Electric, having his duties in the Chicago supply department.

THE TAYLOR ELECTRIC TRUCK COMPANY, of Troy, was on the floor with two elegantly constructed trucks of the Taylor types, both the Taylor improved steel truck and the new Empire State were represented. The Taylor improved is too well known to require description and the Empire State is described upon another page of this issue. John Taylor, the designer of the trucks, was in charge, and ably showed the advantages of his goods to many newly acquired friends.

THE MOSHER ELECTRIC COMPANY, of Chicago, gave light to all people under the gallery, having a ten-lamp circuit of their arc lights, taking current from the railway feeders. The REVIEW was lighted by one of these lamps, and can testify that the brilliancy, steadiness and quietness of action of the Mosher lamp makes it a most efficient and pleasant lamp. The candle power varied but slightly and the brilliance of the light was unexcelled. J. A. Sheriffs accompanied the exhibit.

JONES & LAUGHLINS, LIMITED, of Pittsburg, had an

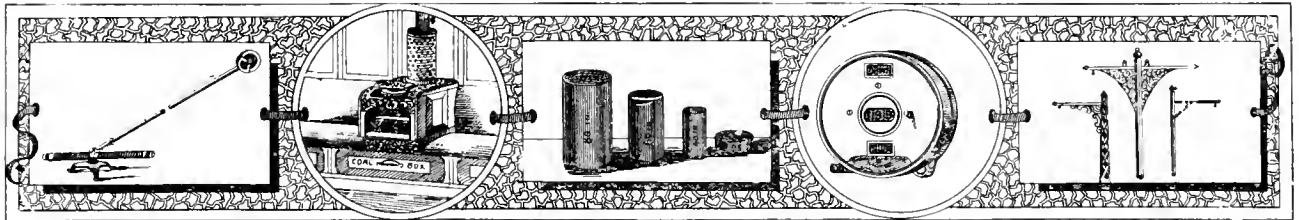

THE DAVIS CAR SHADE COMPANY, of Portland, Me., is well represented by C. M. Fuller, a salesman for the company. The concern shows six patterns of shades, one a curtain for open cars. All are elegantly made and finished with improved holding devices. All goods are made with or without the patent attachment for holding at any desired position. Signal flags are manufactured by the Davis people also. A neat circular was distributed.

exhibit that even the Milwaukee small boy could not run off with. It consisted of a dozen highly polished cold rolled steel axles of special strength. They were handsome specimens of the rolling mill product and base their claims of excellence on their special strength and stiffness. R. Gerry was their gentlemanly representative and distributor of their handy little multum in parvo for engineers and mechanics—a most acceptable souvenir.

THE BALTIMORE CAR WHEEL COMPANY, of Baltimore, Md., brought the elegant truck, Lord Baltimore, No. 2, gaining for it a prominent place and many compliments. This truck was one of the handsomest pieces of work ever exhibited at any convention and was the cynosure of all eyes. J. Paul Baker and John S. Pugh represented the company's interest, each in his own happy manner. We illustrate the truck elsewhere in this issue.

THE SUPERIOR MACHINE COMPANY, of Cleveland, O., makes a specialty of gears and pinions, and to prove this assertion sent a fine line to the convention, comprising gears for Edison No. 6, Westinghouse No. 3, together with step tooth gear and pinion for Edison No. 6, and a special clamp gear. The devices are beautifully finished and claim the best of results for wear and cheapness. The president and treasurer of the company, F. H. Bultman, accompanied the exhibit and made many friends.

H. W. WELLER, general manager of the United Columbian Electric Company, of New York City was a convention visitor. The company will soon market the Winkler twin motor, which will attract considerable attention. Mr. Weller was one of the first electricians in the railway field, being an early Sprague expert, then with the old Edison General, and finally with the General

THE JEWEL BELTING COMPANY did not have a large space, but what was there was weighty. A 48-inch belt, capable of transmitting 600-horse-power, for railway purposes, flanked by a pile of smaller belts, completed the display, excepting Chas. E. Newton, the affable secretary of the company, from Hartford, Conn., and E. P. Ben-

nett, Milwaukee agent. These two made a strong team, and did good missionary work. A beautiful little Russia-calf bill-folder pocket book was the acceptable Jewell souvenir.

THE AMERICAN ARCHITECTURAL IRON & BRASS WORKS, of Chicago, displayed a newly patented trolley wheel, called the Robinson. J. W. Scott was in charge. The Robinson wheel is in three independent parts on one axle, of which only the center wears. "This can be replaced at a small cost," said Mr. Scott, "and the whole wheel is strongly and durably made." They are now used on the South Chicago City Railway, Grand Rapids Street Railway and on the St. Louis electric roads.

THE INTERNATIONAL FARE REGISTER COMPANY, of Chicago, had a nice exhibit of the two registers of the International type and the Pratt portable. They were the center of an interested crowd, and the sharp and clear ring of the bell was kept up all day, ringing up fares enough to make most street railways independently rich. The representatives present were A. H. Englund, the capable secretary and manager, and O. Gronquist, sales-

space in the south of the exhibit room. The Wall gongs sweet tones were heard constantly throughout the day, and the portly form of Mr. Wall was seen wherever the bell was not heard. It was one of the most attractive exhibits on the floor, and deserved the universal attention accorded it. A collection of oil cans was also shown, but the beautiful gongs were the lions of the occasion.

THE CHARLES A. SCHIEREN COMPANY, of New York, Boston, Providence and Chicago, had a nice little space devoted to the perforated electric belts for street railway and electric light stations. Although not a large display, the Schieren exhibit was comprehensive. A stock of round belt street railway bell cord was also shown, and attracted no little attention. R. W. Grant was the able representative, and his close attention to business enabled him to meet many street railway men to whom he introduced the merits of the Schieren belt, if introduction was necessary.

FOLDING GATES. Firmly fastened to a post, the William R. Pitt, Composite Iron Works, of New York City, had a showing of their patent folding gates for street rail-

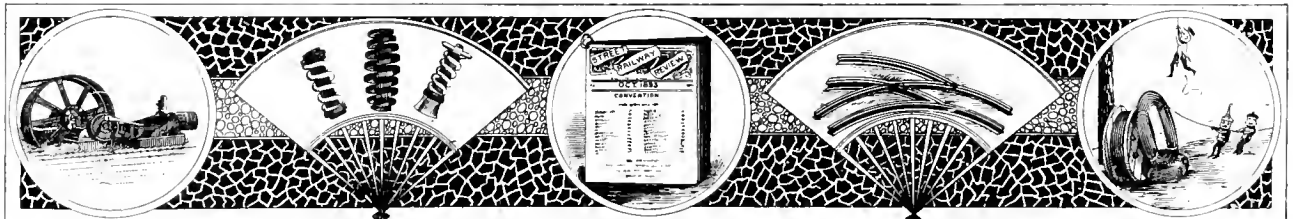

man of the company. The registers made a most favorable impression.

THE EUREKA TEMPERED COPPER COMPANY, of North East, Pa., came northwest with John R. Coffman. Mr. Coffman had a neat booth in which were commutator bars, soldering coppers, brush holders and copper for all purposes of the street railway electrician. The new Eureka water-proof wire, made its debut and was well received. It is a special process and well made. No further details are necessary as to the fact that every street railway man knew Eureka was present. They all "found it" and the genial Mr. Coffman.

AMERICAN ROLLER STREET RAIL COMPANY, of Des Moines, Iowa, came in the person of J. G. Jordan, who installed a roller street rail for curves. By this device a short radius curve may be passed with ease, and Mr. Jordan says: "We will save enough on curve grease and labor to put in the system on most of the roads. Its principle is that of a roller on the inside edge of a girder rail curve on to which the car wheels run, saving the punch, wrench, grind and squeak." Mr. Jordan has received high testimonials from practical men.

THE P. WALL MANUFACTURING & SUPPLY COMPANY, of Allegheny, Pa., was there, in charge of P. Wall, whose hundreds of friends thronged the prettily arranged

way car platforms. They are made for every variety of cable, electric and horse cars, as well as for railroad cars, banks, depots, elevators and store entrances. They are light strung and easily managed, as well as sightly and elegant. They are made in all sizes, and of various materials. Those shown are of iron and steel. The company also makes feeding guards and railings for all kinds of street cars.

PECKHAM'S PEOPLE peregrinated perpetually, preaching Peckham's particular productions; passing parties into parlor C of the Pfister and doing the honors generally. Six trucks that should have been present did not arrive, so that a single specimen of the well known 6 A, which is sold to the Milwaukee Street Railway, did duty on the exhibit floor. The space was appropriately decorated with flowers. Edward Peckham, Philadelphia, E. P. Vogle, A. W. Field and P. S. Bemis did the missionary work, while President Peckham conducted the campaign in person.

THE MCGUIRE MANUFACTURING COMPANY, without which no convention would be complete, was there in force. President Wm. McGuire graced the occasion, accompanied by Vice-president W. J. Cooke, M. G. Hubbard, engineer, and J. A. Hanna, the genial salesman. The exhibit in the hall consisted of a new adjustable traction truck, with General Electric 800 motors in the

G. E. exhibit. On the Milwaukee roads, however, the principal exhibit was shown, as 200 McGuires are used there, and properly ticketed in big letters. The headquarters were at the Plankinton.

THE FITZGERALD & VAN DORN COMPANY, of Lincoln Neb., in charge of W. T. Van Dorn, general manager. Here was shown the new Van Dorn car coupler for street railway and elevated cars. The coupler is a simple, durable and effective arrangement, and has met with great success in the short time it has been upon the market. Three types of couplers were shown, two for street railways and one for elevated cars as used upon the Intramural Railway at the World's Columbian Exposition. Three hundred of the couplers are in use on the Milwaukee Street Railway, besides a number in Baltimore.

HALE & KILBURN brought out a line of car seats, both in rattan and plush. The patented seats of rattan, cemented to canvass, made quite a hit. They are such as have been used for so many years in the Manhattan Elevated Railway, of New York. Any cover may be used and the seat is equally comfortable, cleanly and

rounded by an interested crowd of street railway men who had a thousand complimentary remarks to pass and as many questions to ask. The company was represented by Manager P. M. Kling, of St. Louis, whose hearty manner and good cars have gained him a firm place in the affections of so many street railway men.

THE KELLER PRINTING COMPANY, of New York City, prints tickets, transfer tickets and ferry tickets, and makes special dating machines. The railway department is presided over by J. F. Bushe, an ex-newspaper man and a royally good fellow. The Keller Company prints tickets for the Atlantic avenue and Second avenue railroad companies of Brooklyn and New York. Consecutive numbering and perfect perforating are specialties of the Keller print. The dating machine is sent on thirty day's trial and enables each manager to number and date his own tickets. Mr. Bushe made many friends, and the Keller Printing Company was thoroughly advertised.

THE BURROWS CAR SHADE COMPANY, of Portland, Me., was represented by John W. Baker, who explained the merits of the Burrows shade with good effect and

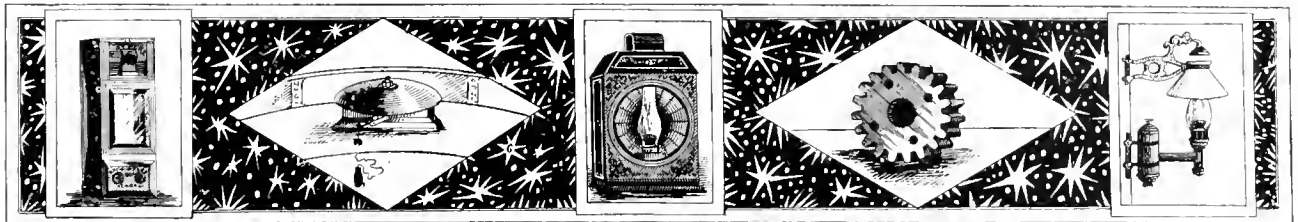

efficient. John S. Lindsey was in charge for the Philadelphia office. Circulars were distributed giving a short list of the varieties of seats and the salient features of each kind. As the Chicago office was busy at the World's Fair, Mr. Canman was not present, except in spirit.

THE RAILWAY EQUIPMENT COMPANY, of Chicago, as usual, had a fine parlor at the Plankinton, and an interesting exhibit of the well known Type G material. Samples were also shown of the new rail bond spring bushing, and this latest device proved a great attraction to all delegates. Electrical engineers and other practical men in the business pronounced it the most perfect electrical connection possible, and large orders were taken. General Manager Mason, C. M. Corpening, and G. H. Van Voorhis were in attendance. Apollinaris water flowed like champagne, and many toasts were drunk to the continued success of this popular company.

THE ST. LOUIS CAR COMPANY had besides "those cars on the Milwaukee track," two elegant cars in front of the Exposition building, furnished and decorated, and even then en route for Wilmington and eastern roads. The cars were magnificent specimens of the car builder's art and equipped complete. They were constantly sur-

patience. The claims made by the Burrows shade are that it is easy to operate, never sticks, cannot rattle, no delicate points are used and that there are no balances. It always hangs straight. A new open car curtain of the Burrows make is lined with pantasote, which is perfectly water proof and cannot stick or become clammy. The mechanism must be seen to be appreciated. It is in use on a number of street and steam railways. Mr. Baker made a very favorable impression on the trade, to which he sells it at retail.

R. A. CRAWFORD MANUFACTURING COMPANY, of Pittsburg, Pa., had an attractive showing of the automatic wheel guard and pick-up fender, adapted to all street traction cars. Two patent automatic wheel guards were shown, in two positions, viz., normal, and passing an immovable obstruction. Two designs of the patent automatic pick-up fenders were also displayed. The Crawford Company is now equipping 1,800 cars of the Philadelphia Traction Company, with the wheel guard, and the entire equipment of the Pittsburg roads will probably be with the Crawford guard. Both President R. A. Crawford and Treasurer S. D. Warncastle, of this company, were in attendance.

THE CURTIS ELECTRIC COMPANY, of Jersey City, New

Jersey, was represented by Charles G. Curtis, D. D. Book and J. A. McIntyre. Their exhibit, consisting of two 25-horse-power "box" motors mounted on a truck, was constantly surrounded by an interested crowd of street railway men, and the gentlemen in charge were kept busy answering questions and showing advantages. The weight of the motor was but 2,200 pounds, and the controlling apparatus efficient and strong. Platform controllers, both of the plain multiple arc and of series multiple type were shown, together with the ordinary rheostat and switch combined. It is stated in the matter mildly to say, that the Curtis made a favorable impression on the visitors.

THE CHARLES MUNSON BELTING COMPANY, of Chicago, had a fine exhibit near the STREET RAILWAY REVIEW headquarters. It was ably attended by Harvey E. Skinner, of Chicago, who also did the honors for the Groetzinger gears. A big 80 inch driving belt, surrounded by a happy family of smaller belts, ranging from 10 to 30 inches. A roll of the new Munson round leather bell cord attracted much attention and favorable comment. The gears of Groetzinger, for all systems, received much attention. The whole exhibit was neatly arranged, and many hundreds of visitors carried away mementoes of the occasion, a leather medal or a neat little gear of dermaglutine. Col. J. H. Shay and Will Groetzinger were also present.

THE NEW HAVEN REGISTER COMPANY, of New Haven, Conn., had a full line of their fare registers in a prominent position and well represented by F. Coleman Boyd, vice president and general manager, well known to the trade, and by A. N. Loper, salesagent. The registers were in the bronze and nickel finish and were pronounced excellent by the visiting delegates. Four registers were shown, and the constant, sharp and positive jingle of the bells was heard all over the hall. The trip numbering service was commented upon in terms of highest praise by everyone, including a few visiting conductors, who decided that "the darn thing couldn't be beat." New Haven may be proud of its safe and compact fare accountant.

THE DE WITT COMMON SENSE SAND BOX, of Lansingburgh, N. Y., was found in charge of the general manager, E. F. De Witt. The box was shown in two styles, both operative. It is a reliable method and has commended itself to the extent of large orders to the Broadway Cable, of New York; the West End, of Boston; the Jersey City & Bergen; the Steinway Electric, of Long Island; and the Troy City, New York. Both dry and damp sand were used, and latter was also filled with gravel and hard packed. The box, however, by use of its knives delivered it in a perfect flow to the track beneath. The hopper holds a bushel of sand and the flow is positively regulated by means of simple locks. It is worthy of careful investigation.

THE NEW PROCESS RAWHIDE COMPANY, of Syracuse N. Y., was represented by the genial, original and hearty

A. C. Vosburg, secretary of the company, and a display of rawhide pinions for the various types of motors. Mr. Vosburg is the author of a full collection of funny stories and a poem of much poetic merit concerning the new process. This latter we hope to produce at some future date; ad interim, we are compelled to refer the anxious reader to John Meaker who holds the original and who guards it with jealous care. Mr. Meaker and Mr. Vosburg were school boys together, otherwise Mr. Meaker would not have been entrusted with the treasure. T. W. Meachem, the president of the New Process Company, was also at the convention, meeting many old and making many new friends.

WASHBURN & MOEN, of all over the United States, and especially of New York and Chicago, had a magnificent exhibit of wires for street railway work. Among the goods displayed was a case of insulated and bare wires, of all sizes and degrees of insulation and nakedness. These general samples were flanked by a section of cable and a portion of track, bonded with the Chicago rail bond; a spool of soft drawn tinned magnet wire; a galvanized strand for suspending trolley wires; a 37-strand 0000 B. & S. gage cable; weather proof 00 feed-wire; solid 0 trolley, of extra high conductivity, and a spool of 1 1/4 inch railway cable. Salamander wire was displayed, and literature on the subject distributed. Geo. S. Whyte, of the Chicago office, and F. W. Pullen, of the company were the representatives.

LEWIS & FOWLER, of Brooklyn and the L. & F. Rail Company, had representatives in the persons of Messrs. L. E. Roberts, H. C. Simpson, T. A. Morrell, C. S. Mead, T. Driscoll and G. W. Meyers. A fine exhibit of small specialties failed to arrive, and the delegation depended upon the big exhibit afforded by the Milwaukee Street Railway of the Lewis & Fowler goods. A big Lewis & Fowler snow sweeper in front of the Exposition building was the center of much interest, which, together with a section of Lewis & Fowler girder, track and switch work on the Exposition floor, completed the showing. The Lewis & Fowler lamps, head lights, snow sweepers, gongs, grab handles, car furnishings, track and switch specialties scattered all over Milwaukee and the West, formed as complete and worthy exhibit as any man could wish to see. The time-honored and royal entertainment of Lewis & Fowler was fully maintained.

WM. WHARTON JR. & COMPANY, of Philadelphia, came also. A. W. Slee, of St. Louis, brought their latest specialty, the automatic derailing switch, for danger points. This is simply a check on conductors, at grade crossings and elsewhere, compelling the employe to dismount from his car and turn a rod, before crossing a steam road or any other dangerous point. It is an absolutely certain factor, and in view of the late alarming proportion of grade accidents, ought to find favor in the eyes of the careful manager. The operating mechanism is very simple and durable, no changes of weather affecting its action, and the switch may be operated either on a single or double

track road, and is not disturbed by other crossways, frogs or switches. Mr. Slee was particularly zealous, and in displaying his life saver, set many managers to thinking on the subject.

THE J. G. BRILL COMPANY, of Philadelphia, had one of the most extensive exhibits of the occasion, and was well represented by J. A. Brill, Samuel M. Curwen, Payson K. Andrews, F. C. Randall, W. H. Heulings and Walter S. Adams. A double decked 18-foot car, Westinghouse, mounted on a Brill truck, No. 21, was a running exhibit on the Milwaukee track. Besides this, in the building was a double, 22-foot car body truck, a Eureka maximum traction truck, specimens of Nos. 21 and 22 trucks, a display of solid forged frames, of both single and double; a vestibuled car end, showing new ratchet brake handle; a snow sweeper for three motors, two to drive and one to sweep; and various other smaller details of the well built and well known trucks of the Brill persuasion. The Brill headquarters were at the Pfister and the Plankinton. The double truck was sold to the Milwaukee Street Railway.

THE TIME TRANSFER PRINTER, of Pittsburg, Pa., had a fine specimen of the time transfer printer, which takes its principal claim for its saving of time; it also economizes in dispensing with a transfer man, where such official is required. The printer is positive in action, simple in use and construction, and cheap in price. Although but lately put upon the market, it has been adopted by several roads notably, the Pittsburg & Duquesne Traction Company, of Pittsburg, who says that it obviates the two evils of stopping to deliver transfers and of allowing employes to handle transfers. The printer was constantly surrounded by an admiring crowd of street railway men. The printing on the transfer tickets is plain and legible, and the time limit is marked within five minutes. The conductor has little to do with the printer, and with the exception of moving a lever or two the entire work may be done at the car barn. The printer is entirely automatic.

THE MICA INSULATOR COMPANY, of 218 Water street, New York, had an elegantly arranged and handsomely executed exhibit of their new micanite insulation. Above the exhibit, a headlight made of micanite, perfectly translucent, showed three incandescent lights. Upon the micanite plate was displayed the sign and superscription of the company. The exhibit was complete throughout, and the lightness, elegance and strength of the insulation was highly praised. The plates of micanite, three feet square, shown, and the hardness of the material was astonishing. The plates rang like metal when struck. The display consisted of commutator segments, armature trough tubes, taper rings, insulation for armatures, micanite cloth, spools and paint, in fact, insulation for everything that should be insulated. C. W. Jefferson, the manager and originator of the material was present and courteously received his many visitors. A neat souvenir was dispensed, consisting of a micanite segment and card.

GARTON-DANIELS EXHIBIT. Posted on a gallery support, and supported on all sides by W. R. Garton, the Garton Lightning Arrester had a large crowd, from the beginning until the end of the session. The arrester has been too often described to need any very lengthy explanation, but sufficient to say that everyone knew about it beforehand, and awaited patiently for its regular trial, which occurred at intervals. The arrester was connected up to the circuit, and after introducing a little foil to make the connection, a switch was opened, and a blinding flash showed how the station was saved, and the arrester ready for a new discharge. A pretty folder, accurately illustrated in every detail, was distributed by the Garton-Daniels Electric Company, of Keokuk, Iowa, showing the advantage of the station protection afforded by the arrester, which, like a revolver, is "not needed very often, but when needed, needed pretty badly." The visiting street railway men were highly interested in the device.

THE GRAHAM EQUIPMENT COMPANY, of Boston, was there also, with a "Dividend Earner," showing the manner of trussing up a 30-foot car body on one end. The truck was tastily painted in black, with white tires, and lettered on the pedestals in white. The pretty little booklet on "Electric Trucks and Spring Suspension," was in great demand. It was one of the neatest pieces of circular advertising given in the building. Economic research in the line of saving tracks, rail joints, and switches was thoroughly expounded, both by J. H. Graham and the distributed literature. G. S. A. Graham, being the father of J. H. Graham, is consequently grandfather of the truck, and a healthier child, with prospects of a longer life and larger fields of usefulness, would be hard to find. Mr. Graham, senior, is representing the well-known Lappin brake shoe, the durability and reliability of which is assured by the connection of Mr. Graham with it. Both the Messrs. Graham are pleasant and intelligent gentlemen, to meet whom is a pleasure and profit. They made many supporters and friends during the few days of the convention.

THE TAUNTON LOCOMOTIVE & MANUFACTURING COMPANY, of Taunton, Mass., had a street railway specialty that attracted no little attention. It is a model of the Round's flush transfer table, nicely executed and showing the salient features, namely, that the table is carried low, being suspended from the axles of the table truck; that no slots or pits are necessary and that the car is run onto the table on skids, which automatically rise after the car has passed onto the table, thus preventing an engagement with the cross tracks. There are but five inches of space from the floor to the top of the table. This table does not interfere with the running of cars out of the barn on ordinary track, as no pits or slots are necessary, and its lowness and strength admits of its use for snow plows or other large equipment. Dust proof roller bearings, running in oil, give ease of management which, together with a patent propelling device, enables one man to move any equipment. The whole affair is

strongly built and serviceable. The company also makes a snow plow, run by gear, which has several important claims for excellence. The plow requires but three men to operate it and the Union Railway Company, of Providence, R. I., has had it in successful operation through several severe tests.

THE CENTRAL ELECTRIC HEATING COMPANY, of Nos. 26 and 28 Courtlandt street, New York, had a large space devoted to a practical illustration of their method of car heating. The Central Company is represented in the western and middle States by George Cutter, he well known of the Rookery, under the caption of the Western Electric Heating Company. The system advocated is the American system, and is the consolidation of several important heating systems. The company is a strong one, and the heater is a neat device, 26 inches long, 2 inches wide, made of cast iron, and weighing but 25 pounds. A regulating switch is in use. Three sets of car heaters are shown in circuit, with volt meters and ammeters attached. The ammeters showed from three to four amperes and the circuit was of 500 volts. "One hundred roads are now equipped with this heater," said Edward B. Wyman, the manager of the railway department, who is in charge. "Among the list may be mentioned the Cincinnati, Newport and Covington Street Railways, the Atlantic Avenue Street Railway, of Boston, the Newtown & Brooklyn City, and others. We expect to make a vigorous canvass and have a first-class article to introduce. We think our western manager, Mr. Cutter, is the best man in the west in electrical circles."

THE FULTON FOUNDRY COMPANY, of Cleveland, Ohio, had perhaps the most varied display in the building, bringing a full line of their specialties under charge of W. E. Haycox, manager of the railway department from Cleveland. The new truck "Imperial," using the Robinson radial draw bar, provided with a safety fender and equipped with the Lyons patent brush holder, had a prominent place in the space. The Troy sand box was also shown, and its claims of reliability and quick action. The Imperial has a steel casting for the main frame and equipped with patent double tread wheels. A steady pin prevents oscillation. It was designed by W. E. Haycock. The Cleveland motor-lift, capable of raising a load of 4,000 pounds, operates by one man. One of the neatest devices shown was the combined car-step and gate, which must be seen to be appreciated. It is automatic, easy and perfectly safe. The Cleveland ticket destroying machine is a new device for which there has been long and imperative call. The office stove is not safe, and the office boy, unfortunately, not always honest. The destroyer is absolutely safe, honest and effective. It can destroy 2,000 tickets a minute, reducing them to an unrecognizable pulp. No more stolen tickets find circulation where this machine is used. A neat display of pressed steel overhead switches, turnouts and crossovers complete the list. The exhibit was constantly surrounded by an interested crowd.

THE CONSOLIDATED CAR HEATING COMPANY came from its Albany, N. Y., home, bringing an interesting display, located in the west half of the main floor to the rear of the Curtis Manufacturing Company. The exhibit was comprehensive, showing the section of a car with seats and heater in position, wired and giving out caloric comfort when the building was cold and chilly. On a table in front of the car seat was laid a set of heaters intended for car No. 200, the elegant special car of the Milwaukee Street Railway, to which we have previously referred. Here also were shown sections of the heater, giving to the uninitiated an idea of the transference of power into heat. Beside the heater display was another table containing the new regulating switch, the office of which is to regulate the amount of current determined upon by the conductor of the car as sufficient for the heating of the car. It is simple and effective. Near the car heating display was also an office heater, looking very much like an oil stove and about two feet high. This latter requires $3\frac{1}{2}$ amperes, can be run from a railway circuit, and is capable of heating comfortably a room 15 feet square with a 12 foot ceiling. Among late orders of the Consolidated heater may be mentioned a number for the Chicago & North Shore Electric and the Calumet Electric of Chicago. J. F. McElroy, consulting engineer of Albany, H. H. Ransom, of Albany, and H. M. Perry, general western manager of Chicago, were in attendance.

THE H. W. JOHNS COMPANY, of New York, Philadelphia, Chicago, Boston and Atlanta, had one of the most attractive booths, prominently located at the north end. Within the hunting covered space was found a full exhibit of trolley line insulating material in moulded mica, of the H. W. Johns' Company design. A particular stress was laid upon the giant strain insulator, of which the company is justly proud. It stood the stress too, and as for physical strain, its breaking is recorded at 6,500 pounds. This, it is needless to observe, leaves ample margin for any possible contingency. This was the first complete exhibition of the perfected giant, which is insulated with sheet and moulded mica. It attracts great attention and favorable comment, and will find a ready demand, being specially suited for span wires and anchors. Samples of asbestos mill board and sheathing, for fireproofing and sheathing electrical apparatus, was shown. Seven pieces of moulded vulcabeston insulators were shown, adapted for parts of electric car controllers, brush holders, brushing spools for field magnets, and other smaller specialties were abundantly present. Upon this the H. W. Johns Company received awards at the World's Fair. The exhibit was well attended by W. F. D. Crane, of New York; H. O. Reeves, of Chicago; and J. W. Perry, of the Philadelphia office, with E. B. Hatch, of the Johns-Pratt Company, of Hartford, Conn.

THE CHARLES SCOTT SPRING COMPANY, of Philadelphia, had one of the prettiest exhibits in the building. Its prominent position, and the original and unique decor-

ations made it the objective point of every visitor. It is needless to say, that on the display tables were shown the fine products that give the Scott goods the reputation they have always borne. Brush holders, springs for all types and makes of motors, trolley springs and elliptics for the Dorner & Dutton, Robinson, Brill, Fulton Foundry, and other elliptic spring using trucks were found tastefully grouped. The whole space was a general "spring opening." Blue prints of the larger goods and of those shown were displayed, giving dimensions and general information on the subject of the springs, the resilience, strength, and graceful figure of which have given them a reputation second to none. A beautiful souvenir, in the form of a Russia-calf covered note book, a gilt edged and elegantly made affair, was given to visitors, containing no printing except the simple last page announcement, that the Charles Scott Spring Company stands ready to make any special spring from sample or sketch, and that their unusually large facilities enable them to produce the largest or heaviest articles, both for extension and compression. Harry C. Johnson, of the Philadelphia office, accompanied Charles Scott, Jr., to the convention.

THE GENERAL ELECTRIC COMPANY, as usual, had a magnificent display, and did the honors of the great corporation gracefully and efficiently. Besides the entire first floor of the Pfister, occupied by the representatives of the company, a fine display occupied the most prominent part of the Exposition floor. Here were placed a McGuire truck, mounted with two G. E. 800 motors, the famous type K controller, with interlocking features, and a fine line of overhead wire material, of the General Electric type. A magnificent 500-kilowatt black slate switch board panel, fully equipped, finished the list. In operation, there were all the cars in Milwaukee, equipped with Edison and Thomson-Houston apparatus, and the plant of the system, described last month. A Lewis & Fowler snow sweeper, with General Electric motors and controlling apparatus, was in the list of operative exhibits. Of course, the literature dispensed was of the most elegant typographical neatness, a joy to a printer man's heart, with engravings and tinted pages. The "Spin with the G. E. 800," was particularly good. An acceptable feature of the banquet evening was the dispensing of immense quantities of lovely pinks and roses, by Mr. Wheeler, of the company. The representatives present were: O. T. Crosby, J. B. Blood, A. K. Baylor, C. K. Stearns, W. J. Clark, W. H. Knight, Theo. Stebbins, G. W. Wheeler, Ben Williard, H. T. Crowley, and W. B. Porter, with Theo. P. Bailey and Geo. K. Wheeler, of the Chicago office, in general charge. The whole affair was a great credit to the company it represents.

THE WESTINGHOUSE ELECTRIC & MANUFACTURING COMPANY had no exhibit at the Exposition building, but at the Pfister, fronting on Wisconsin street, spread an entire sample room with the Westinghouse goods. There were there, to be inspected, two No. 14 controllers complete, a type E diverter, a railway generator rheostat, the tank lightning arrester, an all iron pinion, a No. 3 motor B. H., complete with yoke, a No. 10 armature bearing a No. 10 axle, set of mica insulators for No. 3 motor commutator, together with other motor parts; a 100 ampere and a 200 ampere 2-inch brake switch, a 1,000 ampere circuit breaker, with a set of carbons for same. The literature distributed was finely gotten up, elegantly printed and to the point. Mr. Heinrichs has every cause to be proud of the production. The Pfister was headquarters and the rooms were always well filled with visitors. The Westinghouse men present were: L. Bannister, vice president and general manager, W. C. Clark, general agent and assistant treasurer, Albert Schmidt, general superintendent, Pittsburg; B. F. Stewart, of Chicago; C. A. Bragg, Philadelphia; W. F. Zimmerman, assistant general manager, New York; J. S. Tebbetts, Chicago; W. S. Brown, Boston; A. H. Allen, Philadelphia; J. C. Sanderson, New York; Thomas McCarthy, Toledo; Guido Pantaleoni, St. Louis; J. A. Rutherford, E. W. T. Gray, W. J. Longmore, E. H. Heinrichs and M. Coster, Pittsburg; and T. W. Burrows, of Chicago. The team was a strong one and made a number of good plays. Running on the tracks of the Milwaukee Street Railway was a Brill car, double decker, mounted with two Westinghouse 25-horse-power motors. It attracted much attention and favorable comment.

THE NATIONAL TIME RECORDER COMPANY, of Milwaukee, showed a Bolte time keeper.

THE SAFETY BRAKE SHOE COMPANY, of Boston, showed their brake shoe, with G. C. Ewing in charge.

THE WALKER MARSHALL AUTOMATIC COMPANY switch, represented by Samuel Walker and L. J. Marshall, showed a promising automatic switch device.

THE STANWOOD MANUFACTURING COMPANY had a prominent place on the exhibition floor. President Stanwood was present, and the exhibit consisted of a large number of single tread steel steps, the kind that save accidents and delight the public, together with one or two specimens of the double tread variety, and a few special shapes. The Stanwood step has a reputation for strength and structure accorded to but few specialties. There is nothing "cheap" about it.

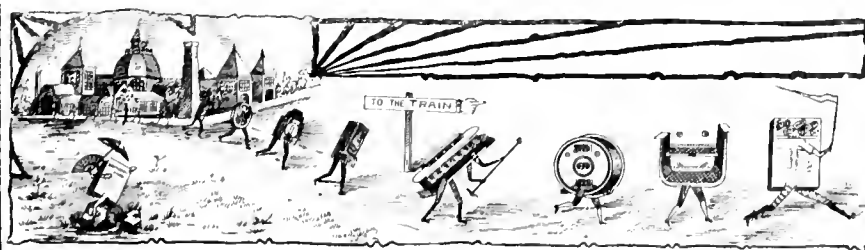

THE BUCKEYE AT THE CONVENTION.

At the northwest corner of the big lot occupied by the Milwaukee Exposition building is a nice place, intended, "since the beginning," for what was probably the biggest single advertisement ever put in a corresponding space for so short a length of time. That was the Buckeye 650-horse-power engine, and Siemens-Halske direct coupled generator, temporarily placed for the delectation of the street railway men visiting at Milwaukee. More than being the biggest advertisement ever placed under such conditions, it is, perhaps, the biggest engine ever put on a temporary foundation. This brings us to the foundation.

The earth, a sandy loam, was excavated to the depth of twelve feet, and to the full dimensions of the engine. Into this excavation were then laid foundation timbers, of 18 by 20 inches dimensions. These were then layed with 6 by 6 inch timbers, close contact, eight feet long. This was decked over under dynamos and flywheels, and where the heavier parts of the machine rest. Twelve-inch timbers were laid over this, thickly on top, and where ever bolts came, 12 by 12 inch stuff was placed, braced and bolted. Upon this foundation rested seventy tons of engine and dynamo, under cover of a big tent.

The engine is of the standard Buckeye non-condensing type, of 650-horse-power. The high pressure cylinder is 20 inches, the low pressure is 32, and the stroke

The dynamo is of 490 kilowatts, direct coupled to the shaft, and known to the Siemens-Halske catalogue as I type, 136 C, and was built at the Chicago factory. It is beautifully executed, and, with the engine, was a big drawing card. Steam was secured from the Exposition boilers. The exhibit attracted universal attention, and the engineers in charge explained the fine points.

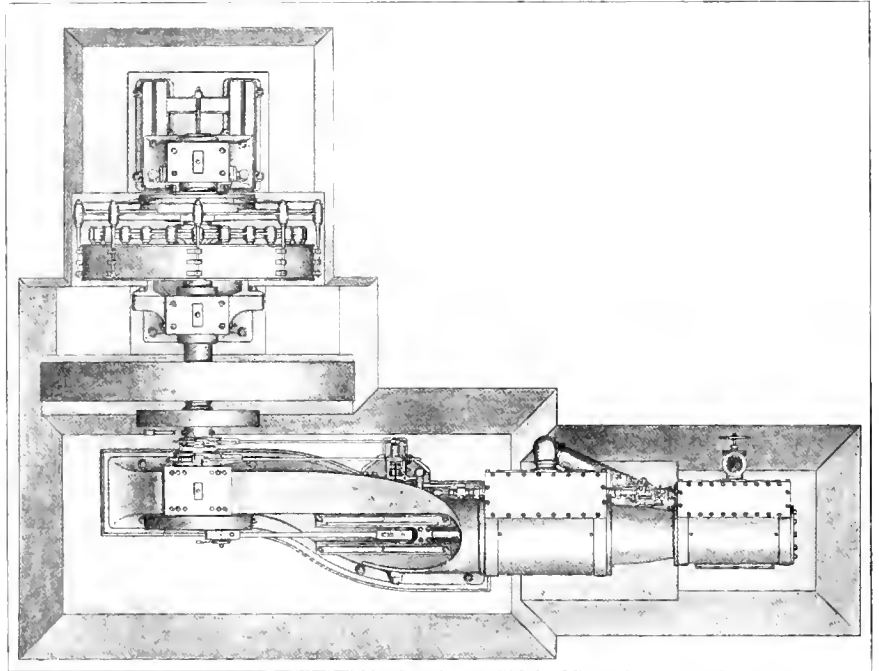

PLAN VIEW OF BUCKEYE ENGINE DIRECT COUPLED TO SIEMENS-HALSKE DYNAMOS.

THE International Tramway Congress, held at Buda Pesth, the first week in September, resolved that "electric motive-power for street railways, where a continuous current is used, has proved well worthy of recommendation. But its applicability in the case of either new lines or old must, however, for the present depend

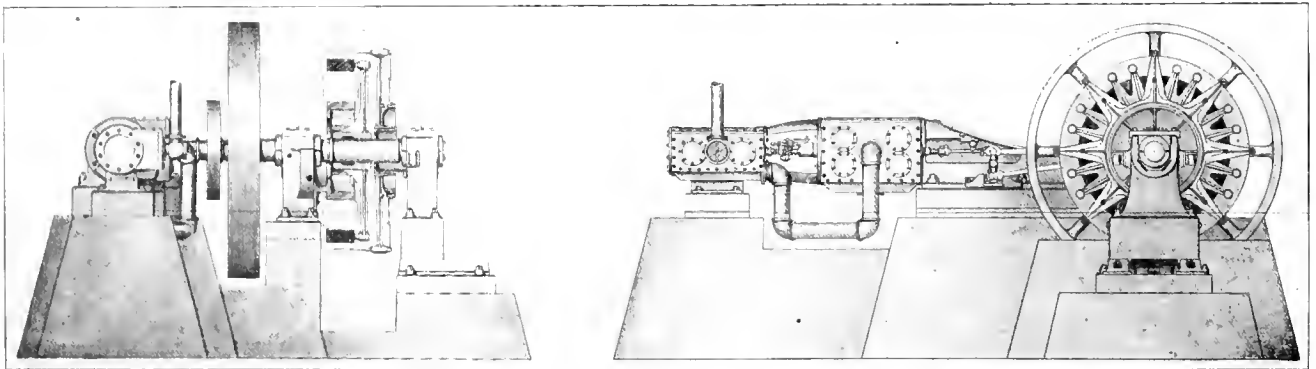

END VIEW.

SIDE VIEW.

36 inches. The steam pressure is to be from 135 to 140 pounds, and she will turn, when at business in the new power house of the Cincinnati Street Railway Company, at 110 revolutions. On the temporary foundation, the machine simply turned over without load.

largely on the facilities offered by municipal or state authorities, as the financial results of electric street railways have not always been satisfactory." The next congress will assemble in August or September, 1894, at Cologne.

FLY WHEEL BURSTS AT BROOKLYN.

ON the evening of October 11, the fly wheel of one of the 700-horse-power Corliss engines in the Atlantic Avenue Railway power station burst, wrecking engine, generator and building, besides all piping in the vicinity, as shown in our engravings. The testimony of those in charge of the station at the time has been collected in a verbatim report, which forms a very valuable contribution to the accounts of fly wheel accidents. This report contains the testimony of John Caplis, assistant engineer; Richard Caplis, attendant to switchboard and generators; James Crowley, engineer's helper; Joseph A. Mitchell, attending condensing engine; Fred Carlison, oiler at the power house; and Richard Nevins, assistant electrical engineer, all of whom were at the power house and saw more or less of the accident and its attendant circumstances. The best account of the affair is that given by John Caplis, who was in charge

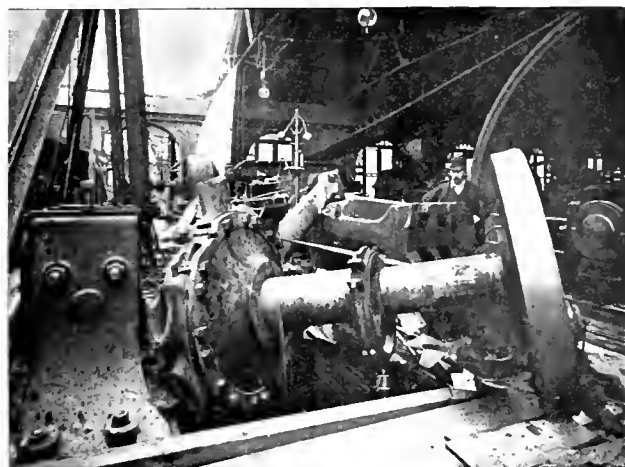

NO. 1.—LOOKING NORTH.

of the station at the time and was in the most favorable position to observe the circumstances. He says:

“My attention was first attracted by the engine, No. 2, slowing up in speed. The automatic attachment to the governor was in perfect working order and in position. The speed of the engine was so slow that I saw that it was only a matter of a few moments until the automatic attachment would shut off the steam. In order to keep the engine in service and carry its proportion of the heavy load, I put in the stop to raise the automatic attachment to catch the governor should it come down and thereby prevent the engine from running. Immediately following this there was a loud report, not as loud as a cannon, but very sharp, something exceedingly unusual. Immediately following this report the commutator seemed to be a circle of fire, and looked as though it was red hot. I immediately pulled out the negative circuit breaker on the generator, and had my assistant throw out the circuit breaker on the switchboard. The engine then speeded up, and I immediately commenced to shut off the throttle; and while shutting off the throttle there was another dull report on the generator.

It seemed to me as though the pulley on the generator had broken, and the belts seemed to slack up. At the time of shutting off the throttle the engine was moving rapidly, in fact racing. After shutting off the throttle tightly, I motioned to my assistant to get out of the road,



NO. 2.—LOOKING SOUTH.

as I had a sense of impending danger. Feeling that it was only a matter of moments until iron would fly, I got out of the road of the engine as quickly as possible.

When I became conscious of the after surroundings my hand was in water, and there was a bright light over-

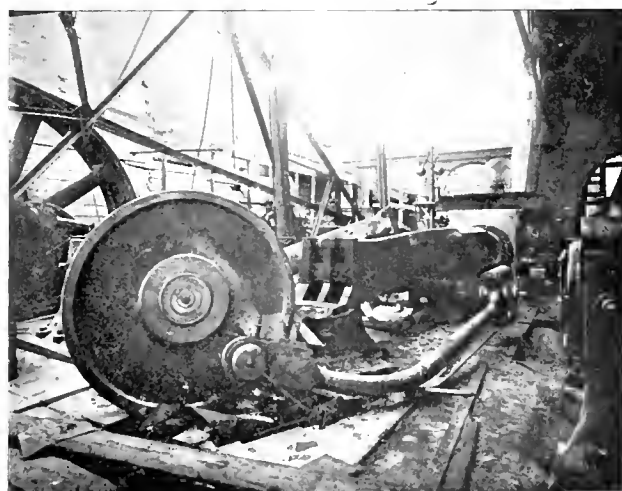

NO. 3.—VIEW DIRECTLY OPPOSITE NO. 2.

head, and knowing that I could only be in the cellar, I followed the light and came up stairs.

In my opinion the entire accident occurred in a space of time not greater than one minute to one minute and a half, from the time I first noticed the engine slowing in

Street Railway Review

speed. I was standing between engines No. 1 and 2 when I first noticed engine No. 2 slowing down in speed."

The testimony of the others bears out this story. Joseph A. Mitchell, in charge of condensing engines, says that the engine No. 2 made a peculiar noise and the vacuum dropped from 27 to 24 inches. He went up to the engine floor and saw the belt sagging and flapping. In a minute the belt broke, flying like a whipcord through the air and the lights went out at the same instant.

The accident disabled the station for three hours, by injury to piping. The fly wheels were 18 feet in diameter and 40 inch face, weighing 20 tons. The engines were C. & G. Cooper make. After an examination into the accident the railway company relieved the makers of all blame in the matter. The burst was undoubtedly caused by excessive speed.

Steamers.....	100,000
Baltimore & Ohio.....	25,000
South Chicago City Railway.....	60,000
Calumet Electric Railway.....	78,000

Total.....2,535,915

These are all figures never before approached by any of the lines included, with the exception that the day before the North Chicago Street Railroad carried 328,219, consisting largely of strangers in the city, who took the opportunity to visit Lincoln Park. Dedication Day, one year ago, and July 4, this year, were looked upon as red letter transportation days, but they are too small to be compared with October 9. Its equal was never seen before, and will probably not soon be seen again.

Early in the morning, between five and six o'clock, great armies began to pour into the down town districts

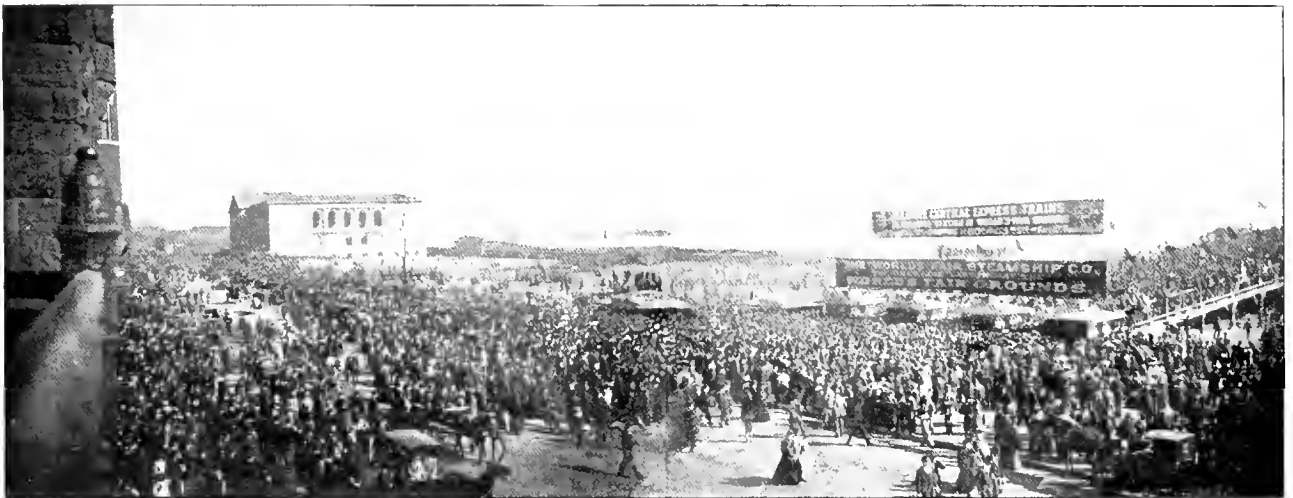

CHICAGO DAY.—LOOKING NORTH ON MICHIGAN AVENUE AT VAN BUREN STREET.—ART PALACE IN DISTANCE.—VIADUCT AT RIGHT.

LARGEST CROWD IN THE WORLD.

The City Transportation Lines of Chicago Successfully Carry
2,535,915 Passengers in a Single Day—A Record
Without Parallel.

THE transportation, by means of city railways, in a single day of a crowd larger than the entire population of one of our great cities is a feat never attempted in the history of the world, until the occasion of the great Chicago Day at the World's Fair, October 9, when the city transportation lines collected fares from over two million people. How many were actually carried will never be known, as the immense crowd made it impossible to collect from a large per cent of those who rode.

The fares collected, as given by the different transportation companies, are as follows:—

Illinois Central.....	459,799
South Side Elevated.....	294,800
City Railway.....	757,660
North Chicago Street Railroad.....	265,656
West " " ".....	495,000

from the north and west sides, and soon began to congregate faster than they could be hauled away. The Illinois Central ran World's Fair trains on a headway of from one to two minutes, carrying at least 1,500 people in a train, but in spite of this the Van Buren street viaduct approach to trains and steamboats quickly assumed the appearance shown in our engraving. It was simply impossible to get people through the turnstiles fast enough to keep the crowd from gathering. The crowd on the train platforms was never very large. Probably 75,000 people were on the viaduct and surroundings at one time. It was not until after noon that it began to noticeably subside.

The suburban service of the Illinois Central furnished transportation for 206,900. Those living at suburban stations south took north bound trains in order to get to the Fair, as there was not "clinging on" room on those south bound.

Finding out the crowded condition of the viaduct, people began to turn to the two south side cable lines. Although not built for double deckers, the cable cars soon began to be used as such, in spite of the protesta-

tions of conductors and gripmen. Cars became so loaded that those living as far south as Forth-seventh street took north bound cars, or in other words, rode twelve miles to get seven. Fenders dragged on the pavement, and paving had to be taken up in some places. Our engraving of a Cottage Grove avenue car shows the condition or things for miles down Wabash and Cottage Grove avenues. State street was but little better. Trains ran on forty seconds headway, the majority consisting of four cars, and carrying not less than 400 passengers apiece. This would be at the rate of 36,000 an hour on each of the two cable lines. The electric lines handled a traffic heretofore thought possible only with the cable. The photograph here shown is of a motor car which was hauling two trailers on the Sixty-third street line. It was taken at 2 p. m. By three o'clock the crowd had subsided so that cars were comfortably filled with people

THE VESTIBULED PLATFORM LAW IN OHIO.



OUR readers will recall our comments last winter on the law which passed the Ohio legislature, requiring companies to vestibule the front platforms of winter cars. That law goes into effect on November 1, and requires an inclosed platform with front and sides of glass or other suitable material.

It was an easy matter for the Ohio Solons to pass the bill, but as they knew nothing of the construction of street cars, and, as was evidenced by their treatment of street railway managers at the time, cared less, and no allowance was made for the difficulty of so reconstructing many cars now in use. Regarding the matter, Albion E. Lang, general manager of the Toledo Consolidated, says:

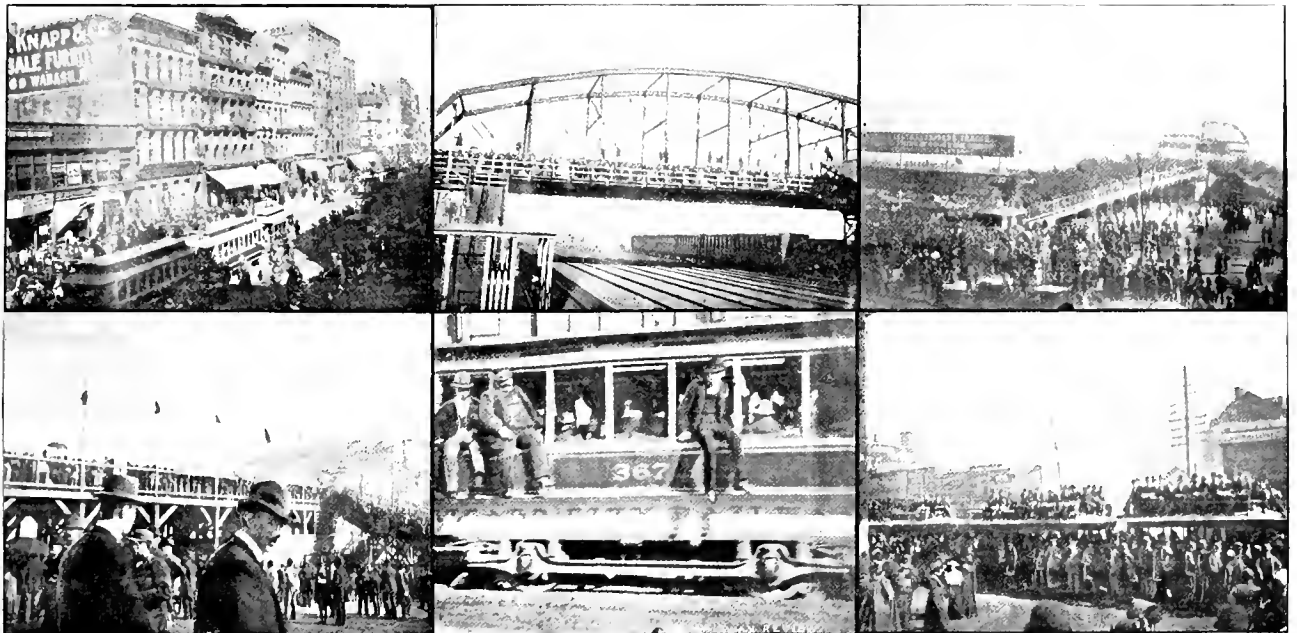

GLIMPSES OF TRANSPORTATION—CHICAGO DAY.

going to and returning from the Fair. The scenes around the elevated railroad stations were fac-similes on a small scale of that at the Van Buren street viaduct.

It was only by overloading a system of transportation such as was never before provided in the world that it was made possible to reach the above astounding figures. The City Railway carried 500,000 people on Dedication Day, in 1892, and there was then only one other way of getting to Jackson park. Chicago Day it raised this figure by three-fifths, with four other faster lines paralleling it.

THE Crossley brake, of Cleveland, has been adopted by the Chicago City Railway, on its electric lines.

JOS. A. CORBY, having found that other business interests require his attention, has resigned the presidency of the Railway Equipment Company, Chicago, and W. R. Mason has again been elected as president.

“The last legislature did pass a law requiring street railways of the state to protect the motormen by glass or some other kind of screen on the front ends of the cars. None of the cars in this city were built with reference to having the same vestibuled, hence, the platforms are too shallow to permit it. We are preparing to comply with the law, but up to this time find it very difficult to devise anything practicable to attach to our cars. We are experimenting, and hope to work out the problem. We would be glad if some one would present us with a simple, practical way of providing such a screen, and will live in hopes that such a person will soon present himself. It looks to us to be a very difficult thing to successfully attach any device to the cars we have, but will not give up the effort until we are satisfied that it cannot be done.”

A well known manager in another city writes:
“We protested against the passage of the law before

Street Railway Review

the legislative committees on the ground that vestibules increased the danger of collisions between cars and vehicles and persons upon the streets. We believed these objections to be well founded; and that especially in the



FRONT VIEW—COLUMBUS VESTIBULE.

crowded streets of large cities, the use of vestibules will result in destruction of life and property. The principal danger is at night, more especially when raining, sleeting or snowing, but we believed it our duty to abide by the law, and we are accordingly preparing to comply with it.

"The rule of liability for accidents must certainly be modified where it can be shown that injury resulted through the use of a device absolutely required by law."

It seems strange that the legislature so entirely ignored the experience of companies in its own state, as the protected vestibule has been in use on the Mt. Auburn cable road, Cincinnati, several years. President Henry Martin, of this company, says:

"Our grip cars have always been enclosed on both ends with three glass sash which, when not in use, drop from the top and slide down into the panel. Our experience has been that in severe storms and foggy weather the gripman cannot see with the sash up and has to keep them down. In cold, freezing weather also he has to keep them down on account of the ice forming on the glass and obstructing his view of the track. We have had many complaints from passengers on our grip cars because of the gripman having to keep the sash down at such times. I am clearly of the opinion that the enforcement of the law will tend to increase accidents."

Still another manager writes: "We are taking steps to comply with the law, not from choice but because there is perhaps a public sentiment in favor of some sort of protection to the employes, and because we do not care to go to the expense of testing the law. We look

upon it as a law which will increase the casualties of street railroads to an alarming extent, as under conditions when protection of that character is needed, it will be an utter impossibility for the motorman to have a clear view of the street in front of him; and it will be much more difficult for drivers to see passengers who hail the car from some distance, especially in stormy weather. That 'the best way to secure the repeal of a bad law is to enforce it vigorously' will undoubtedly prove itself in this case, and I believe the public will demand its repeal after a fair trial."

Henry A. Everett, president of the Cleveland Electric says: "We are making sample vestibules to see how they will work and expect to equip each one of our motor cars in Cleveland with vestibules by the time required by the law. I am personally converted to the vestibule idea, and do not think that it is a bad idea at all."

General Manager Nelson, of the Springfield Railway, says his cars were not built for carrying vestibules but will endeavor to comply with the law by using canvas or sheet iron.

W. J. Kelly, general superintendent of the Columbus Street Railway, one of the best managed roads in the state, believes the law an unjust and unwise one, and that to carry out its requirements is likely to increase danger of operation. The reflection from the interior of the car at night will render it difficult for motor men to readily discern anything outside the vestibule; and that

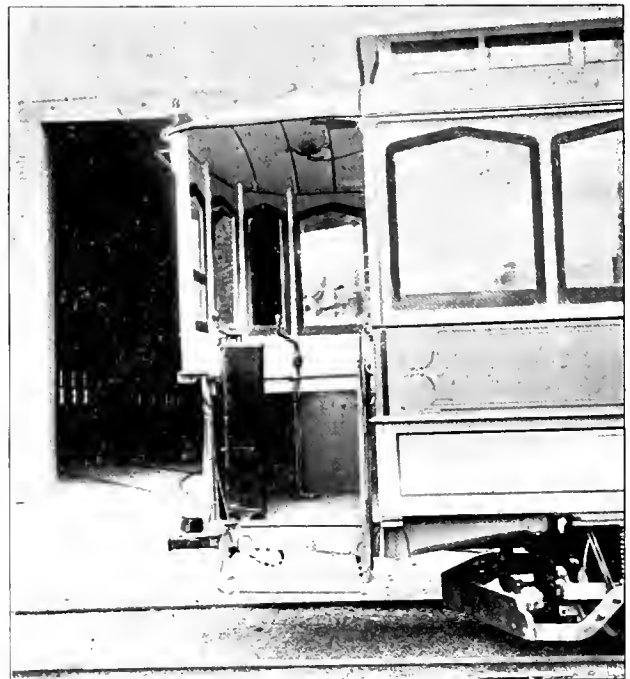

SIDE VIEW—COLUMBUS VESTIBULE.

in times of sleet, snow or rain, the occasions when the protection is most needed, it will probably be necessary to lower the windows. However, he believes in obeying the law, and has worked the problem out in such a way

that he has reason to be proud of the exterior appearance of his car, even if the windows cannot be used. Our three illustrations are in themselves a description of how he has accomplished this and certainly present a very creditable appearance.

Mr. Kelly has already thirty of his cars thus equipped and running, and the public compliment them highly.

Some of the roads in the state will probably allow the

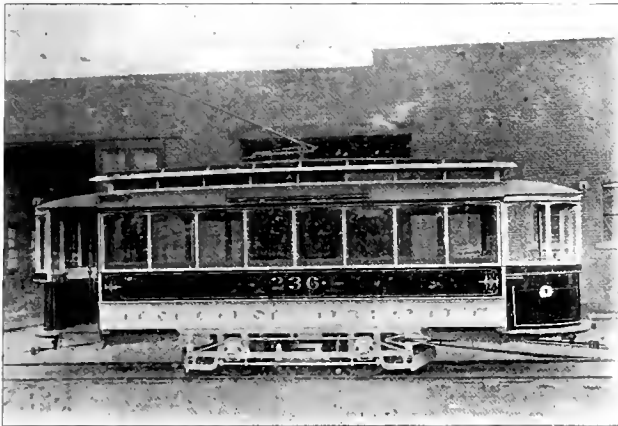

COLUMBUS CAR-DOUBLE VESTIBULED.

date to pass without complying with the law, believing it to be unconstitutional. What action will be taken to secure its enforcement remains to be seen.

The plan proposed by the Laclede Car Company is simple, and in some respects novel. It does not necessitate the changing of the brake handle or controlling stand. Two uprights are erected from brackets on the inside of the dash, near its outer edges, to the hood or

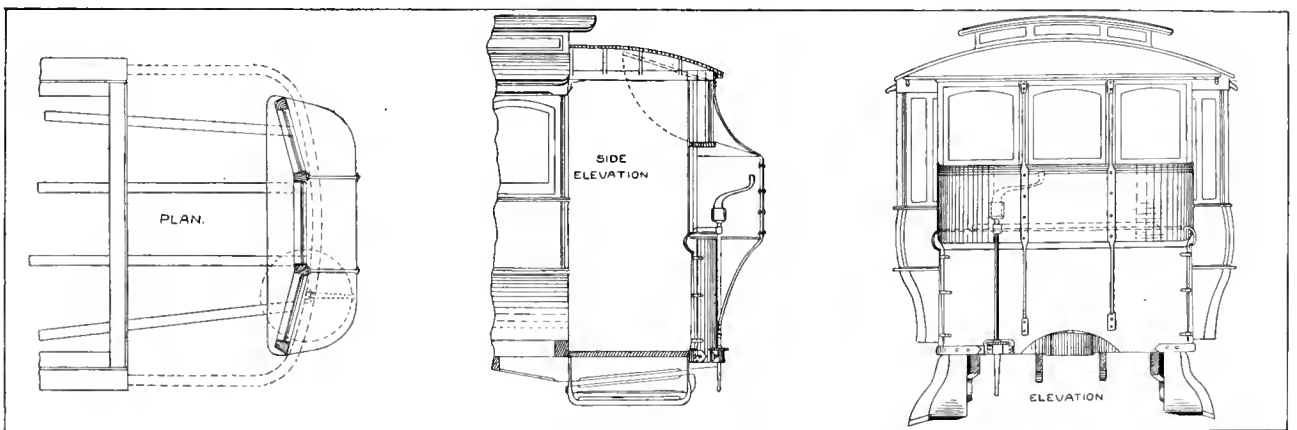

THE LACLEDE CAR COMPANY'S PLAN.

bonnet bow. Between these a crossbar of ash is run at a sufficient height to clear the brake and controller handles, and from this crossbar two more uprights are run to the hood. Above the crossbar are three sashes which extend up to the hood. The center sash may be swung on hinges to the top sash rail and hung up to the hood ceiling as shown. In order to get sufficient room to allow the brake and controller handle to revolve, they propose to use an "extension front," if it may be called such, of No. 14 sheet steel, and applied as shown. At the bottom is fastened to the dash by stove bolts, and at the top it is

fastened to the crossbars with screws and in the same way to the corner posts. It is braced with 5/8 inch round iron braces. This form of vestibule would seem a very excellent one for its intended purpose.

OBITUARY.

JUDGE ADOLPHUS REINOEHL.

A self made man, of the sturdiest Pennsylvania German stock, was Judge Reinoehl, and perhaps the most widely interested man in Lebanon, Pa., and the surrounding country. He was born in 1830 and, at the age of sixteen, became a blacksmith's apprentice, afterwards doing large iron contracts and general manufacturing. In 1852 he went to the Pacific coast with the gold seekers and remained two years. After his return to Pennsylvania he associated himself with his father in the lumber business, and finally succeeded him.



A. REINOEHL.

Besides holding many minor offices of trust, both in church and state, Mr. Reinoehl gained the title of judge, being elected to the honorable position of associate judge of the several county courts for five years.

He was connected in official capacity with a dozen or more large corporations centering their business at Lebanon, besides being president of the Lebanon & Annville Street Railway Company.

Judge Reinoehl died September 29, respected by all

who knew him and lamented by a large circle of friends in every enterprise in which he was concerned.

ERASTUS WELLS.

The first street railway builder of St. Louis died October 4, at his home in Wellstown, at the age of seventy. The Hon. Erastus Wells on July 4, 1859, drove the first street car in St. Louis over the Olive street line. He came to St. Louis in 1843 with \$150 and went to driving an omnibus. With this humble beginning he lived to be honored politically and died wealthy.

PERSECUTION IN DETROIT.

THE opposition of Mayor Pringree, of Detroit, to the Citizens Company, of that city, has already been referred to in these columns. Why Mr. Pringree should so pointedly wage this unjust and unreasonable warfare against home capital, which has already spent nearly one million dollars in giving his city what outside capitalists had never succeeded in doing, is hard to understand. His attitude is certainly very peculiar and can hardly be explained, except on grounds of some personal interest unknown to us. That his policy has in any measure been in the line of benefitting the city or protecting any fancied jeopardy of its rights is simply ridiculous.

Mayor Pringree is trying to force a 3-cent fare for all hours of the day. This very fact alone is sufficient to convict him in the eyes of any street railway man, as either manifestly unjust or purposely ignorant of what it costs to haul a passenger. The company already labors under the burden of a 3-cent workingman's ticket, during the morning and evening rush; but have placed themselves on record as willing to continue this, with a 5-cent fare the balance of the day, and even give transfers from one of its lines to its others at all hours. There are few managers in other cities who would like to undertake the responsibility of satisfactorily and safely operating a road even on this basis. Our readers will recall the result of a 3-cent fare on the East Cleveland road a few months ago, in its effort to pull all the business, which was being divided with a competitive parallel line. They got the business and held it for several weeks, but like the drowning man with the sack of gold, the more he had the worse his condition, and the company were glad to replace the old rate, divide the business, and stop losing money. At present cost of operation it is simply out of the question to carry at any such figures.

Mayor Pringree sprung a scheme the other day which shows how personal he is making this fight. On his own authority he quietly imported a Mr. McTighe, of New York, to bolster up his case.

As in expert testimony of all kinds, it is nothing against Mr. McTighe that he should do his best to make out a case for his client.

One of his main points was that operation in Detroit would not cost to exceed 11.02 cents per car mile. On cross-examination he admitted that while he had done some building he had never operated a road, and that his figures of 11.02 cents were taken from an old prospectus of the Edison Company published in 1891. These figures were based on the average cost of operating several roads in Massachusetts, the names and location of which are carefully concealed, and were evidently selected to make the most favorable showing possible for the company which desired to sell its apparatus. Even were the figures correct, there are many factors which make operation in the west much higher.

The same table from which McTighe takes his 11.02 cents places the average total investment per mile of

track, including buildings and real estate, at \$27.780, while McTighe's estimate for Detroit, exclusive of buildings and real estate, is \$35.815 per mile, and even to secure these low figures he avails himself of the present low prices of material and labor, while the Massachusetts figures of \$27.780 were on 1891 prices, which were fully 25 per cent higher than now, nor does he allow any value for the 250 old cars now in the company's possession and which at small expense can be made suitable for use as trailers, nor for its horse barns and tracks.

With a 3-cent morning and evening, and a 5-cent fare balance of the day with transfers, and served with a first-class equipment and rapid transit, the people of Detroit would have what few cities in the country can obtain, or their local roads give without going into bankruptcy. What is good service and fair charges in other cities of corresponding size ought to be good service and fair charges in Detroit. A comparison of what is alleged to be the cost of running a few unknown lines in small towns of Massachusetts is no sort of comparison for city wages, insurance, taxes, paving, repairs and a long line of expenses incident to doing business in a city. Mayor Pringree has made an unbroken record for himself of stubborn and persistently blind opposition to the real interests of his citizens, and all the expert testimony in the world will not enable the Detroit company to buy materials, hire men, make repairs and furnish a decent rapid transit service for three cents per passenger. It is not and cannot be done in other large cities, and certainly cannot be in Detroit. The construction of an extensive system of electric railways in Detroit, such as the Citizens is striving to do, would increase the value of real estate in an amount which would represent the difference between a three and a five-cent fare for twenty-five years. Some people hold two cents before their eyes and so shut out a vision of two dollars just beyond. Mayor Pringree exhibits all the symptoms of this malady. It would seem as though it was about time for the business men in Detroit to put a stop to such outrageous proceedings.

A BIG DELEGATION.

THE biggest delegation ever attending a convention might naturally be expected to be a Chicago undertaking. The West Chicago Street Railroad, of which Mr. Parsons is general manager, concluded to come, and so Secretary and General Superintendent R. C. Crawford called in all his division men and foremen, and selecting nineteen, told them to get in marching trim. The balance are to go next year, if their record remains as good as in the past. And the boys didn't walk, either, nor did they go in a coach. Nothing short of a special drawing room car was good enough. Arriving at Milwaukee, he boys were elegantly quartered, visiting the convention in a body, and, inspecting every exhibit. They didn't care so much for the papers, but could be found giving some of the younger crop a quiz that wasn't easy to answer. Then they made a trip over the lines, and there wasn't a feature of the road or barns that escaped attention. "Have just as good a time as you want, boys, and bring the bill to me," said Mr. Crawford. When the banquet was opened, there was Mr. Crawford, with his "faithful 19," and the boys enjoyed it, too. Friday they all did the city in a tally-ho coach, with one of the boys holding eight strings, and the way they drove was fit for a World's Fair exhibit. Then they had their pictures taken in a group.

Perhaps when there's a hlockade in the middle of the night; or a big snow storm getting in its forty-eight hours' work next winter, the boys

will forget all about the banquet and things—and then again perhaps they won't! It was a graceful act on the part of the manager, which may well teach its own lesson to others.

Following is the list of "the boys": Peter Needham and Wm. Bolger, division superintendents; T. C. Bridges, superintendent of car shops; John Fitzgerald, Jos. Steabeck, John Hawkins, John Stevenson, Fred Altpeter, D. F. Smith, John L. Blessing, Jos. Lainger, Ben Phillips, Wm. Moeller, Wm. Halskett, Wm. Cookbets, Harry Brand, R. R. Hertzog, John Stanley.

AN ATTRACTIVE EXHIBIT.

WE are enabled to illustrate, this month, the handsome display of the Standard Railway Supply Company which appears in "Street Car Row" at the Transportation annex, Jackson park. The artist has fittingly shown the drapery and the design of the display in all its attractiveness.

The exhibit shows three of the Standard car heaters, the efficiency of which has been tried and not found wanting in many a long winter's cold. The excellence of its

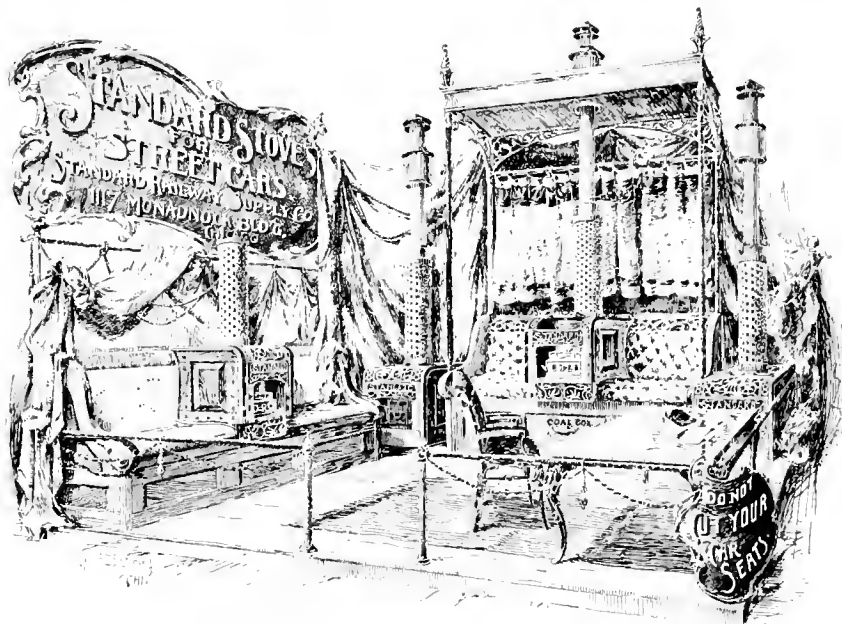

disposition in the car, not cutting the seat, is well shown by the artist and can be well appreciated by the manager who has seen the display or the stove in actual service.

Mr. Garson Meyers has had the designing of the space, and to him the credit of the arrangement is due, to say nothing of the vigor with which he has pushed the sale of the specialty.

Mrs. SHARP, of Waukesha, Wis., an aunt of Mrs. W. J. Richardson, was the guest of the latter during the convention.

HOWARD WHEELER, of the Sterling Supply Company, New York, was a REVIEW visitor, on his return from convention.

NEW MEMBERS joining at this meeting are: Calumet Electric Street Railway, Chicago; Marinette Electric Light & Power Company, Marinette, Wis.; and the New Orleans Traction Company, New Orleans.

EXHIBITORS showed their good sense again this year, by not having the old time malady of wagon loads of printed matter. Small circulars and cards, which managers could carry away in their pocket, are vastly better for all concerned, and has fulfilled the recommendation urged by the REVIEW two years ago.

SECRETARY CRAWFORD, of the West Chicago road, was sitting in convention, with his nineteen division superintendents and foremen. Their faces bore the scars of all-night battles with snow and storm, and probably not one of them could have told what an ohm was. An old time manager noticing them, pointed at a beardless youth, who was talking very profoundly, and then at the veterans, and remarked: "There's the difference between theory and practice."

THE R. A. CRAWFORD MANUFACTURING COMPANY, of Pittsburg, Pa., has immense success with its specialties—

the automatic wheel guard and pick-up. The former has been adopted by the Philadelphia Traction Company and gives the best of satisfaction. The adoption of such a device by so large and conservative a road as the Philadelphia Traction Company, assures its importance and usefulness. The R. A. Crawford Company at the convention made a most favorable impression on the visiting brethren.

FOREIGN FACTS.

TRAMWAY mail boxes on the Donnybrook line, Dublin, Ireland, are pronounced a great success. The boxes are painted vermilion and placed below the stairs at the rear of the cars.

KIOTO, Japan, will celebrate its 1,100 anniversary by the opening of a five-mile electric railway. When a world's fair will be held in Japan we may expect to see electric railways in abundance.

DELEGATES ATTEND A NEW CONVENTION.

Armstrong, E. A. Camden, N. J.
 Adkins, Jas. St. Louis, Mo.
 Ashton, S. K. Jr. Milwaukee, Wis.
 Ahearn, T. Ottawa, Can.
 Atkinson, I. M. Burlington, Ia.
 Badley, E. A. Waterbury, Conn.
 Bamphoff, C. W. St. Louis, Mo.
 Brenner, W. H. Montreal, Can.
 Berkford, J. H. Scranton and Reading, Pa.
 Baker, N. F. Washington, D. C.
 Brown, F. Wayland Youngstown, O.
 Burt, T. M. Berlin, Ont.
 Binner, E. Dayton, O.
 Bartlett, A. Los Angeles, Cal.
 Birninger, Julius Milwaukee, Wis.
 Becker, Danforth Milwaukee, Wis.
 Bailey, T. P. Kalamazoo, Mich.
 Bowen, M. K. Chicago, Ill.
 Belden, D. A. Aurora, Ill.
 Bradford, H. P. Cincinnati, O.
 Blinn, Isaac, Philadelphia, Pa.
 Brown, R. S. Gloucester, Mass.
 Burke, M. F. Terre Haute, Ind.
 Breed, A. F. Boston, Mass.
 Browning, G. C. Camden, N. J.
 Ballard, W. J. Dubuque, Ia.
 Bickford, J. H. Reading, Pa.
 Connette, E. C. Nashville, Tenn.
 Carpenter, Ried, Mansfield, O.
 Charlton, B. E. Hamilton, Ont.
 Canvee, John C. Bangor, Me.
 Crosby, O. T. Wilmington, N. C.
 Collinder, A. Chicago, Ill.
 Christopher, J. M. Baltimore, Md.
 Carr, W. P. Roanoke, Va.
 Convers, C. C. Hot Springs, Ark.
 Cameron, W. S. Jamestown, N. Y.
 Clegg, C. B. Dayton, O.
 Corwin, D. B. Dayton, O.
 Crawford, B. C. Chicago, Ill.
 Camdee, Leverett, New Haven, Conn.
 Crossin, T. E. Brooklyn, N. Y.
 Clarke, E. P. Los Angeles, Cal.
 Crowley, R. J. Atlanta, Ga.
 Colby, F. J. Rockford, Ill.
 Dixon, H. A. Port Huron, Mich.
 Degen, N. E. Maumee, Mich.
 Durnin, T. J. Milwaukee, Wis.
 Doremus, H. B. Bridgeport, Conn.
 Delaney, W. H. New York.
 Dunning, Robert Buffalo, N. Y.
 Durbin, C. K. Denver, Col.
 Dean, W. W. Hamilton, Can.
 Dickson, W. D. Great Falls, Minn.
 Dixon, A. Port Huron, Mich.
 Dorr, C. A. Charlotte, N. Y.
 Duncan, D. Dubuque, Ia.
 Dean, J. Hamilton, Ont.
 Downs, E. E. Kalamazoo, Mich.
 Davis, N. A. Cincinnati, Ohio.
 Everett, H. A. Cleveland, Ohio.
 Edwards, Frank Lincoln, Neb.
 Ellis, C. E. Philadelphia, Pa.
 Elliott, Miller Pittsburg, Pa.
 Fenimore, Francis Phoenixville, Pa.
 Freyyear, T. C. Gloversville, N. Y.
 Flynn, C. E. Peoria, Ill.
 Foster, E. C. Boston, Mass.
 Ferguson, W. B. Haverhill, Mass.
 Flish, L. M. Proja, O.
 Frederick, C. R. Davenport, Iowa.
 Fraser, J. D. Ottawa, Can.
 Fritz, John Bridgeport, Conn.
 Frv, J. H. Detroit, Mich.
 Foster, W. H. Pittsburg, Pa.
 Gotshall, W. C. Munroe, Ind.
 Glass, Andrew Washington, D. C.
 Goodwin, W. W. Detroit, Mich.
 Goodrich, E. S. Hartford, Conn.
 Greenwood, G. F. Pittsburg, Pa.
 Grover, F. F. Milwaukee, Wis.
 Guyer, E. H. Moline, Ill.
 Green, Alfred Rochester, N. Y.
 Gorman, John B. Worcester, Mass.
 Greene, Frank R. Chicago, Ill.
 Greer, J. W. San Antonio, Tex.
 Griffin, W. H. Galveston, Tex.
 Goodrich, C. E. St. Paul, Minn.
 Grant, John Detroit, Mich.
 Gunn, James Toronto, Can.

Kolbe, J. W. Baltimore, Md.
 Kelly, W. J. Columbus, O.
 Kelsey, J. A. New Haven, Conn.
 Knowles, Perot, L. Phoenixville, Pa.
 Kingston, W. W. Montgomery, Ala.
 Lea, Preston, Wilmington, Del.
 Lang, Albion E. Toledo, O.
 Law, M. D. Washington, D. C.
 Luther, Chas. F. Pawtucket, R. I.
 Lynn, A. W. Milwaukee, Wis.
 Lusher, E. Montreal, Can.
 Luckey, Richard, Helen, Mont.
 Lattell, H. M. New Orleans, La.
 Lewis, D. F. Brooklyn, N. Y.
 Lippert, M. W. Philadelphia, Pa.
 Littell, H. H. Buffalo, N. Y.
 Longstreet, D. F. Denver, Col.
 Liggett, J. C. Detroit, Mich.
 McLean, T. H. Indianapolis, Ind.
 McNamara, J. W. New York City.
 Morse, G. C. Taunton, Mass.
 McLaughlin, Chas. Paterson, N. J.
 Melms, G. J. Milwaukee, Wis.
 McNaughton, A. Milwaukee, Wis.
 Macloskie, C. H. Chicago, Ill.
 May, J. H. Ia.
 Mashin, G. W. Brooklyn, N. Y.
 Minary, C. K. Springfield, Ill.
 Minary, J. S. St. Louis, Mo.
 Macfarren, L. J. Philadelphia, Pa.
 Marks, Ferdinand, Philadelphia, Pa.
 Macartney, J. I. Norfolk, Va.
 McCloy, Birmingham, Ala.
 Morris, H. W. Milwaukee, Wis.
 McKinney, C. A. Houston, Tex.
 Markle, A. Hazleton, Pa.
 Morton, H. T. Ann Arbor, Mich.
 McQuaide, J. P. Norristown, Pa.
 Mailloux, C. O. Washington, D. C.
 W. Gilbert, J. B. New Britain, Conn.
 Macartney, J. E. Norfolk, Va.
 Mendell, C. S. New Bedford, Mass.
 Mock, H. A. Brooklyn, N. Y.
 Morrison, W. N. Brooklyn, N. Y.
 MacDonald, G. F. Ottawa, Can.
 Martin, Edward, Hamilton, Ont.
 Merson, W. L. Milwaukee, Wis.
 Ostrom, J. F. Steelton, Pa.
 Odell, Chas. Newburyport, Mass.
 Pierson, C. H. St. Louis, Mo.
 Patterson, W. H. Bloomington, Ill.
 Partridge, John Brooklyn, N. Y.
 Phillips, Geo. A. Milwaukee, Wis.
 Penington, F. C. Chicago, Ill.
 Pidd, Thomas, Milwaukee, Wis.
 Perrine, Lewis Jr. Trenton, N. J.
 Pratt, Mason D. Steelton, Pa.
 Perrine, H. P. Trenton, N. J.
 Potts, H. T. Philadelphia, Pa.
 Payne, H. C. Milwaukee, Wis.
 Peck, Frank C. Kansas City, Mo.
 Richardson, Wm. Brooklyn, N. Y.
 Bonnell, W. B. Pittsburg, Pa.
 Rontzolin, N. N. Dayton, O.
 Rusling, F. O. Chicago, Ill.
 Richardson, W. J. Brooklyn, N. Y.
 Rogers, H. B. Brockton, Mass.
 Reed, W. P. Salt Lake City, Utah.
 Rigg, J. A. Reading, Pa.
 Rugg, J. E. Pittsburg, Pa.
 Redel, Andrew Newark, N. J.
 Rogers, Lewis H. Cleveland, O.
 Reed, C. F. Springfield, Mass.
 Shepardon, A. O. Waterbury, Conn.
 Smith, Walter C. Milwaukee, Wis.
 Smith, Clement C. La Crosse, Wis.
 Sullivan, D. W. Brooklyn, N. Y.
 Scullin, Harry St. Louis, Mo.
 Schloss, S. Detroit, Mich.
 Smith, A. P. New Bedford, Mass.
 Sinclair, H. B. Galveston, Tex.
 Sullivan, P. T. Lowry, Mass.
 Sterling, J. R. Detroit, Mich.
 Stephenson, W. J. Washington, D. C.
 Stone, A. L. Oakland, Cal.
 Sperry, E. A. Cleveland, O.
 Seull, W. S. Camden, N. J.
 Swift, C. M. Detroit, Mich.
 Shewman, Allen, Racine, Wis.
 Shaw, E. P. Jr. Norwich, Conn.

Haynes, Geo. D. Newark, N. J.
 Hurl, Joel Atlanta, Ga.
 Haynes, J. E. Newark, N. J.
 Holbrook, R. H. Cedar Rapids, Ia.
 Hilgard, F. T. Milwaukee, Wis.
 Hahn, C. W. Milwaukee, Wis.
 Hubbard, F. G. Milwaukee, Wis.
 Howell, I. E. Dayton, O.
 Hayward, A. H. Allentown, Lehigh Co.
 Hatcher, W. S. Detroit, Mich.
 Hendrie, S. Detroit, Mich.
 Hoffman, J. F. Milwaukee, Wis.
 Heft, N. H. Bridgeport, Conn.
 Henry, D. F. Pittsburg, Pa.
 Heger, W. S. Wilmington, Del.
 Havi, A. E. Chambersburg, Pa.
 Hulsizer, John Joliet, Ill.
 Haven, W. E. Fishkill-Hudson, N. Y.
 Harrison, Russell B. Terre Haute, Ind.
 Hayes, Henry New Britain, Conn.
 Hawks, J. D. Detroit, Mich.
 Hurlec, P. E. Trenton, N. J.
 Ives, E. B. Philadelphia, Pa.
 Jenkins, T. M. Covington, Ky.
 Jevell, W. S. Anderson, Ind.
 Jones, F. G. Memphis, Tenn.
 Johnson, J. W. Kalamazoo, Mich.
 Jones, W. E. St. Louis, Mo.
 Keithley, H. R. Chicago, Ill.
 Kilgour, B. L. Cincinnati, O.
 Klinkerfus, H. Milwaukee, Wis.
 Klan, G. W. Milwaukee, Wis.
 Schoerer, W. Newark, N. J.
 Smith, W. H. Omaha, Neb.
 Sullivan, J. J. Philadelphia, Pa.
 Shumodine, W. H. Philadelphia, Pa.
 Smith, W. C. Pittsburg, Pa.
 Stern, W. Philadelphia, Pa.
 Shaffer, W. Shury Park, N. J.
 Shaw, E. P. New Haven, Conn.
 Sargent, W. W. Fitchburg, Mass.
 Traggard, J. G. Newburyport, Mass.
 Tindolph, E. P. Vincennes, Ind.
 Tourley, E. M.
 Ticknor, F. A. Rockford, Ill.
 Thompson, A. C. St. Louis, Mo.
 Upham, C. C. Lincoln, Neb.
 Valentine, John Portland, Ore.
 Winsor, Paul Boston, Mass.
 Williams, Gen. Chas. Manchester, N. H.
 Williams, Chas. I. Rochester, N. Y.
 Wright, L. R. Denver, Col.
 Woodman, Franklin Haverhill, Mass.
 Ward, Elias S. Newark, N. J.
 Wood, H. H. Birmingham, Conn.
 Whitehead, H. C. Norfolk, Va.
 Woods, Henry P. Boston, Mass.
 Wrightman, M. J. Middletown, N. Y.
 Woodruff, R. S. Trenton, N. J.
 Wheeler, G. K. Kalamazoo, Mich.
 Whitney, F. H. Milwaukee, Wis.
 Yeales, R. H. Chicago, Ill.
 Young, A. M. New Britain, Conn.

Others present were: W. J. Dutton, Dornier & Dutton, Cleveland; W. W. Willetts, of Adams & Westlake, Chicago; A. E. Hay, Robinson Machine Company, Philadelphia; F. McGee, of E. S. Greeley & Company, New York; S. H. Short and T. A. Rogers, of the Short Electric Railway Company, Cleveland, O.; William Taylor and John Dea, of Taylor, Goodhue & Ames, Chicago; C. E. Stump, J. W. Dickerson, E. Caldwell, of the Street Railway Gazette, Chicago; J. H. McGraw and T. W. Taylor, of the Street Railway Journal, New York; F. R. Colvin, electrical engineer, New York; W. F. Collins and W. E. Keily, of the Western Electrician, Chicago; M. J. Sullivan, of the Electrical World, New York; C. Hess, of the Can. Philadelphia; Geo. Cradock, Wakefield, England.

A TIME TRANSFER PRINTER.

THE waste of money and paper incident to the ordinary system of printing transfers for each day, is well known. It is always necessary to print too many in order to be sure to have enough. The time transfer printer here illustrated, is a machine to print transfers on the car as they are wanted by the conductor. By simply turning the crank, transfers are turned out, giving the hour and day of the month and year. The names of the transfer stations are changed by a lever projecting through the casing and communicating with the type rings, as are also the A. M. and P. M. type rings. The number of the month and date are changed by the watchman or inspector who has charge of the key unlocking the machine. The crank lever operating the type cylinders, is removable, and is in charge of the conductor, so that tampering with the printer is impossible. The minutes are represented by spaces representing ten minutes each. The inking arrangement is so perfected as not to need re-inking for a month. It has been in use for some time on the Pittsburg Traction Company's lines, and has been a source of saving, not only on account of the obviating of waste transfers, but because it prevents trading of transfers between conductors.

It is made by the Time Transfer Printer Manufacturing Company, room 69, Schmidt building, Pittsburg, Pa., and was shown at the Milwaukee convention.

ITALIAN electric railway enterprise is slowly gathering force. A line has just been opened at Milan, which runs ten miles to Monza.



WINDSOR & KENFIELD,
PUBLISHERS AND PROPRIETORS.

269 DEARBORN ST., - - - CHICAGO.

Published on the 15th of each month.

SUBSCRIPTION, - - - TWO DOLLARS.

FOREIGN SUBSCRIPTION, - - - 20 SHILLINGS.

Address all Communications and Remittances to THE STREET RAILWAY REVIEW,
269 Dearborn Street, Chicago.

H. H. WINDSOR,
Editor.

F. S. KENFIELD,
Business Manager.

CORRESPONDENCE.

We cordially invite correspondence on all subjects of interest to those engaged in any branch of Street Railway work, and will gratefully appreciate any marked copies of papers or news items our street railway friends may send us, pertaining either to companies or officers. Address:

THE STREET RAILWAY REVIEW
269 Dearborn Street, Chicago

Entered at the Post Office at Chicago as Second Class Matter.

This paper member Chicago Publishers' Association.

VOL. 3. NOVEMBER 15, 1893. NO. 11

The only publication devoted to street railway interests receiving a Medal at the World's Columbian Exposition, was the **STREET RAILWAY REVIEW.**

ONE of the largest European orders for street cars in several years, has been let by the city of Glasgow. It is for 200 cars, to cost \$150,000, and has been divided among English builders.

THE Nebraska Supreme Court holds that street railways are common carriers, and as such are required to exercise extraordinary care to prevent accident, and to overcome the presumption of negligence must show the accident to have been produced by causes wholly beyond its control, and exercise of utmost human care.

IT would seem that the very successful and satisfactory use of crude oil as fuel during all the months of the World's Fair, cannot fail to call general attention to this clean and, in many localities, economical fuel. At the Exposition only one-fourth as many men were required in the boiler room as had coal been used, while the uniform steaming qualities were specially marked.

A SOMEWHAT peculiar ruling has been made in the supreme court of Pennsylvania, in holding that a driver is under no legal duty to look for passengers while engaged in attending to his horses. The decision arose from a damage suit for injuries to a boy seven years of age, who attempted as a passenger to get on the front

platform of a horse car which was starting, but without conveying such intention to the driver. Company was held not liable. The same court also ruled that companies are liable for damage to workmen working for the city in trenches, in running its cars over the ditch without giving notice, which on all previous occasions had been given.

THOSE conditions which are favorable to steam road construction are in many respects favorable to street railway work. Our esteemed contemporary, the Railway Review, states that on what is deemed good authority, the estimate of steel rail which will be needed for steam road work in 1894, places the probable demand at two million tons. A continued and increased improvement in the money market of course will determine this. But there can be little doubt that a much larger number of enterprises than have been made public are hoping to take definite shape for next year, and that the re-action from the sluggish condition of construction work which has characterized 1893, will be marked.

LIABILITY for damage caused by a "bucking motor" has, we believe for the first time, become a matter of court decision, and hence precedent. The Supreme Court, of Minnesota, as reported in our law department for this month, holds that failure to properly test a motor, which was known to have bucked, before sending it out in service, together with use of a low dash on driver's platform, combine to make the company liable for damages for death of motorman who was killed by being thrown over the dash when the motor bucked. It is practically the same interpretation of law which has long prevailed in the use of animals in car service known to be ferocious and dangerous, and emphasizes the admonition so constantly urged in these columns, of the prime necessity of competent and responsible men in the inspection department.

AMONG the many other valuable conclusions to be deduced from the report of the electric plant performance on the Chicago City Railway, published this month, not the least valuable are those in regard to running trailers. As pointed out in a previous editorial on this subject, the cost of power per car mile of a trail car added, is not as much as that of a motor car added. Besides this, of course, must be considered the saving of one motorman, and the saving in inspection and repairs on the extra motor car. Against this the decrease in headway resultant on the substitution of trailers for motors must be considered, but where the headway is as short as it is on large roads, there is no reason why a more liberal use of trailers should not materially reduce expenses, without driving away traffic on account of the longer headway.

WHILE the distinctly visible exhibits of electricity at the World's Fair occasioned constant remark and praise, its greatest work and wonder was unnoticed by the rushing multitudes. The electric fountains, the illu-

minations of the court of Honor, the Administration dome and the great search lights brought cries of admiration to the lips of gathered hundreds of thousands, but few paused to think that the hundreds of electric motors scattered over all the grounds were drawing their power from a common source; and that as they strolled about from one building to another, the very ground on which they walked was honeycombed with passages filled with wires conducting the power wherever needed, in any desired quantity. Strike out the noble part which electric light and power worked in the greatest show on earth and a large part of the advance shown in contrast with the Centennial would be wanting.

THERE is nothing in the line of electric railway progress more pleasant to contemplate than the quickness with which the problem of securing an efficient and durable ground return has been solved. It is now only about a year and a half since the first trouble from electrolytic action was publicly announced. Then followed the Cleveland convention, where the matter was talked of at length, and which was followed by an extensive discussion in the technical press, the subject being approached from all sides. Gradually, however, the consensus of opinion began to point toward heavy bonding, and that alone as the best remedy for troubles in all localities; the only remaining requirement being for a water-tight bond connection. This was not immediately forthcoming, but the Milwaukee convention saw on exhibition two types, which are described in this issue, and which meet the requirement. The year elapsing between conventions saw not only a change in common opinion on the question, but its satisfactory solution.

THERE should be some penalty which street railways can invoke upon unauthorized persons who give the "go ahead" signal on the cars. This is frequently done, and recently in this city was the direct cause of an accident which resulted in a big suit for damages. The court held the company was liable even under such circumstances, unless it could positively be proved the conductor could not have countermanded the signal. The speed which cable and electric cars attain in a few feet of space and a few seconds of time, often permit of accident before the car can be stopped, even were the signal to stop given as quick as possible. Where two trailers are used and in the business street of a large city, the distance from the driver and noise of passing vehicles usually precludes the conductor from signaling with his voice to the driver, or even to the head conductor who may be on the front platform of the first car. If then the rear conductor is on the street assisting ladies or infirm people, as is frequently the case, the company would seem to be placed in an eminently unfair position. What is needed is some sort of penalty which will deter over zealous people from being smart and trying to play conductor. Such persons should not only be ejected from the car, but be liable to arrest and heavy fine.

THE Interstate Commerce Commission has issued an advance sheet of its annual report for the year ending June 30, 1892, from which we make the following interesting abstract. The figures make an instructive basis of comparison for street railway companies. The state of North Carolina led in railway construction, showing an increase of 212.92 miles. The total number of railway corporations at the end of the year was 1,822, a gain of 37 during the year. The total number of locomotives was 33,136, of which 8,848 were passenger. The increase during the year was 810. The number of cars for all purposes was 1,215,092. The average number of locomotives per 100 miles was twenty, and the average number of passenger cars per 100 miles, eighteen. The average number of freight cars per 100 miles was 708. Employes in railroad service numbered 821,415 on June 30, 1892. Passengers carried during the year amounted to 560,958,211. The number of tons freight carried is reported as 706,555,471. The gross earnings were \$1,171,407,343, and the operating expenses \$780,997,996. Fatal accidents to employes, 2,554, a decrease over the previous year, but the number injured was increased, being 28,267. The number of passengers killed was 376, against 293 the year previous. This is at the rate of one passenger killed for every 1,491,910 carried, or one for 35,542,282 passenger miles.

MAKING death-bed bequests to libraries, both public and educational, has become a favorite form of benevolence, but so far as we are able to learn it has remained for a wealthy Californian to generously remember "the boys" of one of the cable lines in San Francisco, which was the city of his residence. By the recent death of Edward Hull, who was worth upwards of a quarter million, the sum of \$10,000 is bequeathed in trust to the Omnibus Cable Company, to be invested in good interest bearing securities and the income to be devoted to the purchase of such books and magazines as the directors may approve, for the reading room of the employes of that company. This bequest will in a very few years accumulate quite a large collection of books, which will be selected with a special view to interest and benefit this particular class of readers. And they will be read and studied, and the far reaching influence for good will doubtless never be fully known. The suggestion to other wealthy men in other cities is self-emphatic, and action thereon need not be delayed until the giver has been honored with a tombstone, but can be attended to now. There is not a railway of any size in the land but will furnish, light and warm a comfortable room for the purpose, and it would not be a bad idea for the manager to cast about in his own community where certainly there are one or more wealthy, benevolent men, who when they are once made acquainted with this opportunity for good, will be glad to share in the doing of it. The particular need for a special reading room for street railway men, lies in the fact that so large a number are always compelled to be in waiting at the depots, ready to go out any minute.

UNION labor has again made itself conspicuous, this time at St. Paul and Minneapolis. All through the summer and early fall months, when the earnings of the Twin City Railway were falling below the average, on account of the closing of mills and other industries incident to the business depression, the company stood by its men and did not reduce wages as did many other roads, but maintained the same good pay, which had been voluntarily increased in the early spring, as when it was making dividends. This was rewarded by a dissention which culminated early this month. And what was the grievance? It was not hours. It was not wages. It was not unfair treatment at the hands of even the most inferior officer or foreman. It was no rule which required any employe to do an act which was not becoming in a true man. It was nothing more nor less than a demand that thirteen men be peremptorily and finally discharged. Were these thirteen men guilty of dishonesty from which the others would save the company? Were they drunken, ill tempered, uncivil employes, who were hurting the corporation in the eyes of the public, or men whose personal lives brought discredit on their fellows? Not one of these disqualifications were urged against the obnoxious thirteen. Their crime consisted solely and wholly in the fact that as free men, living in a so-called free country, they had not chosen to unite themselves to an organization called the union, to which the other employes belonged. And so the union men assumed to run the road, to dictate to its officers representing the owners of the property, who and who not should be employed in its service. Three hours was given Manager Goodrich in which to cast out these men, against whom no charge stood. To have done so would have been both cowardly, unjust and unbusinesslike. He did, however, promptly discharge the entire force in St. Paul, and immediately began enlisting new employes. He could have hired in a few hours six times as many men as could be used, from the army of the honest and capable unemployed, and at one-half the wages he had been paying. Instead he maintained the wage scale, and first of all hired the before mentioned thirteen. Then he accepted such other of the former employes as suited him and who cared to enter his employ as non-union men, and finally enough outsiders to make the required complement. It is by such senseless acts as characterized the last Indianapolis strike, and this one at St. Paul, that will eventually compel managers to confine themselves exclusively to the use of non-union men. Other things being equal, a union man is no better than a non-union man. In the cases mentioned they certainly proved themselves not so good. We have yet to learn, however, of a single instance where non-union men have threatened a strike if union men were employed. They are willing, also, to allow the right of an employer to hire men of his own selection. Is there any wonder, then, the union is in disfavor with employers. To use plain English, the St. Paul strikers made consummate fools of themselves, and deserved and received no sympathy; not even in a brother union. The Minneapolis men refused to go out, or assist in the strike.

THE Chicago City Railway is before the city council with a petition to be allowed to convert its horse lines to electric. The company has about 100 miles now operated by the time honored, and as slow as time, method of animal power. None of these lines can be cabled for many years to come. On some the volume of business will not warrant the investment, and those where traffic is heaviest, such as Thirty-first street and Archer avenue, cannot be cabled for the same reasons which have prevented their being so equipped for years past. Archer avenue would have been cabled nearly ten years ago, but for the danger and expense of building a conduit across the networks of steam tracks which in several places number a dozen or more tracks. While a few tracks can be crossed in safety, it is not considered safe to operate a cable car across ten or more at one place, where all are constantly used as live tracks. The only chance for the cable in such places is to construct viaducts, and while grade crossings are no advantage to street car operation of any kind, the expense involved to viaduct all the steam crossings which the City Railway passes over would cost many millions. Hence, for several hundred thousand population served on the South Side, it is now electricity, and that means the overhead trolley system, or to continue with animal power. Had there been no demonstration in every other large city in the country, extending over a period of from one to five years, the operation of the few cross town lines put in commission by the City Railway last spring, would remove any possible objection which the most cautious could suggest. All through the rush and crowding of two lines leading to the very gates of the World's Fair, the electric cars did their work regularly, swiftly and safely. What greater test can there be from the public standpoint than this—sure, safe, swift? The people certainly demand it; the company stands ready to install. What, then, blocks the wheels of commerce? As usual, it is that intelligent and zealous body of aldermen, who are "protecting" the public from the realization of what they want and demand. Probably there is less objection from this august body to the far out lines than to those which would lead nearest the business district, notably Clark street. If anything can make Clark street, south of Van Buren, any more worthy of its favorite title of "hell's highway," it certainly is not the inoffensive overhead wire. The fact that all other wires are buried simply makes the use of the railway wire absolutely safe, and as for looks—well, the lovers of art are not accustomed to use it as a boulevard, and the majority of the habitues of the street are in a state of perpetual coma, which prevents their seeing much at any time. As a matter of fact, the introduction of rapid transit would do more to purge the street and make it tenable than any other possible influence. There should be no hair splitting and red tape delays in promptly granting the needful authority. Several months must necessarily intervene after consent is granted, in which to build machinery, equipment, and erect power houses, and with the daily monument of successful operation of trolley cars

in the business district of every city in the country, there would seem no occasion for delay. The objections raised on account of possible electrolytic action might have had some weight ten months ago, but with the recent solution of this problem, it no longer stands as a valid barrier.

TWO very unusual and fatal accidents are to be chronicled this month. One was the bursting of an old boiler, used to generate power for operating the feed cutting and similar machinery, at the East Fourteenth street barn of the Dry Dock, East Broadway & Battery, in New York City. A portion of the boiler was hurled across the street, and five persons were killed and several injured. As the boiler had been in constant use for fifteen years, and was of the early day type, the inference is it had become dangerous through long use and should have been replaced by a new one long since. The other and even more terrible disaster was at the extreme western border of the land, where an electric car, with twenty or more passengers, plunged from the Madison street bridge, through an open draw, and into the deep waters of the Willamette river, at Portland, Oregon. The extremely heavy fog prevented the motorman from seeing the danger until within a few feet of the brink. Seven bodies were recovered by divers. One of the unfortunates had succeeded in escaping from the car after it sank only to be crushed by the wheels of the steamer for which the bridge was open. While an excuse is claimed for a wet rail, there can be little excuse for a disaster of this kind. From all accounts the car was evidently running at a high rate of speed, although four miles an hour would have been too fast to cross a bridge in an impenetrable fog, without knowing whether or not the draw was open or closed. While blame attaches to the motorman, the company are even more to be censured. It was the company and not the driver which undertook, for a consideration, to furnish a safe transportation; and it was the company, not the driver, which has the authority as to how the cars are to be operated, and whose obligation it is to prevent accident, by anticipating and so guarding against it. But it does not appear that any strict regulations were in force requiring conductor or driver to make sure of absolute safety before reaching the draw, which is liable to be open at any moment. If the danger light, displayed at the end of the span next the draw, cannot be seen in fog there should be a series of red lights extending back to the bridge approach if necessary, supplemented by electric gongs. These can be made to operate automatically whenever the bridge opens, thus affording both light and sound signals. An approaching car should then not be permitted to cross a dead line, removed at least one or two span lengths from the draw, until the draw has again fully closed. Then, if it was ever impossible to control the car, occupants would at least have a chance to choose between the dangers of broken limbs in jumping from the moving car, and the certain death of going into the river. It would also seem that safety gates of iron or heavy timber, made to close like the lock gates of a canal,

could be made sufficiently strong to withstand even collision by a car. In addition to all this, a draw span or a railroad track should never be crossed without the car first coming to a full stop at a safe distance, and the conductor going ahead and giving a signal to his driver when it is safe to proceed. The Portland company are experiencing all the regret that any humane management can, but, unfortunately, that cannot restore the seven lives which went out so awfully in the fog and darkness of those cold waters. The company, and every other company operating under conditions more or less similar where such an accident has even the remotest likelihood of possibility, owe it to their patrons and themselves to provide every possible safeguard. Then, having exercised all the provision and foresight possible, if death follows, the officers of the road will be entitled to pity, rather than censure.

MANHATTAN'S MILLIONS.

AT the annual meeting of the Manhattan Railway Company, on November 8, Howard Gould and Joseph Easton were elected directors in place of Jay Gould and T. C. Earلمان, deceased. The report for the year ending September 30, says that 214,459,217 passengers were carried, an increase of 6,000,000. Financially this report reads:—

Gross earnings	\$11,137,050
Operating expenses	6,210,160
Net earnings.....	4,926,075
Charges.....	2,015,075
Balance	2,917,816
Dividend	1,800,000
Surplus	1,111,816

INSURANCE AND THE TROLLEY.

THE fire insurance men of Chicago, who profess fears of increased risk if the council permit overhead trolley wires in the business district of the city, are respectfully referred to the following letter, in reply to our inquiry addressed to W. E. J. Deming, city inspector of electric wires in the city of Minneapolis. Under date of September 6, 1893, he writes:

“DEAR SIR.—Yours of September 4th to hand, and noted. My instructions from the committee on railroads was to report all accidents resulting from wires falling across trolleys, in order to determine the advisability of enforcing the ordinance requiring guard wires to be placed over all trolleys. This list of accidents I can assure you is very short and of little consequence. The total results from wires falling across trolleys, since January 1, 1891, are: Three fires, damage practically nothing; four horses killed; and one man's leg broken, having received a shock while on a pole, which caused him to fall.”

It is proposed to supply the Dundee police force with portable electric lamps. If this is done, they should be able to “light out” in time of danger.

WHERE MADRAS "IS AT."

THE undertaking of the construction of an electric railway in Madras has occasioned considerable interest among the technical press, which is strengthened by the widely separated locations to which the city is ascribed. One paper places it in Spain, and another in Italy.

Madras is a flourishing city of nearly one million inhabitants, and the capital of the presidency of the same name, which is one of the three of British India. This presidency contains 21 districts and a population of 25,000,000. The city of Madras is 870 miles southwest of Calcutta, and the introduction of the electric road will be one of the greatest innovations ever attempted in that East India metropolis.

of the Manchester Carriage and Tramways Company, on Tuesday, said that, with regard to the motive power, the directors had seen no reason to make any change. He stated that Manchester did not want the unsightly steam cars of Bradford and Leeds, and as to electric power, they had no evidence yet it was likely to pay. The directors would, however, seek to pursue a policy which, while safe, was progressive."

A lamentable ignorance of electric railway practice is noticeable in all English technical papers, so that it is no wonder that the lay brethren are so far away from the fold.

MAYOR PINGREE, of Detroit, is re-elected for a third term. He has become well known, principally as a kicker.



SOUTH END OF BOILER WHICH BLEW ACROSS THE STREET.



VIEW OF WRECK SHOWING LOCATION OF BOILER.

The Madras Electric Railway has acquired a site for the erection of a power house and car barns. The latter will hold 30 cars and be fitted as a light repair shop. Four sets of Tangye compound, non-condensing engines of 180 nominal horse-power will drive four Elwell-Parker dynamos, with an output of 240 amperes at 500 volts. Six Babcock & Wilcox boilers will grace the boiler room and Berryman heaters, pumps, filters, purifiers, and all smaller adjuncts will add to the modernness of the plant.

OUR British cousins do not really grasp the electric railway ideas, as the following from the Electrical Engineer will show: "Mr. Ald. King, addressing the shareholders

DEATH FROM A BURSTING BOILER.

ANOTHER fatal accident to be recorded this month, occurred in New York City, November 2, the boiler in the stables of the Dry Dock, East Broadway & Battery barn, at Fourteenth street and Avenue B, exploding, with fatal results to five persons and injury to a dozen others.

The boiler was a small affair of 50-horse-power, and said to have been tested to 90 pounds pressure. Those employed at the stable testified that never more than 60 pounds pressure had been employed. The engine driven from the boiler was used to grind feed for the horses.

The most remarkable incident of the occurrence was the dislocation of the boiler. It was lifted by the force of the explosion clear of its bed and, parting in the middle, one-half flew across the street. It struck a tenement house with a force that was felt throughout the block. It was here that the most injury was done. A fire alarm was immediately turned in but no fire resulted.

Our engravings show very clearly the destruction occasioned, as the scene was photographed by the REVIEW



VIEW FROM SIDE OF STREET OPPOSITE CAR BARN, TO WHICH HALF OF BOILER WAS THROWN.

special artist while yet the police guarded the ruins to await the arrival of the coroner.

The boiler bed is definitely marked and the deceased equines in the foreground show plainly. At least twelve horses were killed and the stable suffered to the extent of \$5,000.

The hospital ambulances and the red cross nurses took good care of the injured, and before the day was spent,—the accident occurred at 10 a. m.,—much of the debris was removed. The boiler was an old one, having been in service fifteen years, and the only wonder is that such an accident could occur in that portion of the city with no greater loss of life.

SAN FRANCISCO CONSOLIDATION COMPLETED.

THE great consolidation in San Francisco, of which mention was made last month, has been perfected. The new company is called the Market Street Railway Company and is capitalized at \$18,750,000. It is a consolidation of the following companies:

- Market Street Cable Railway Company.
- Market Street and Fairmount Railway Company.
- City Railroad Company.
- Potrero and Bay View Railroad Company.
- Southern Heights and Visitacion Railway Company.
- Park and Ocean Railroad Company.
- Ocean Beach Railway Company.
- Central Railroad Company.
- The Omnibus Cable Company.
- The North Beach and Mission Railway Company.
- Ferries and Cliff House Railway Company.

The officers now are: Chas. F. Crocker, president; H. E. Huntington, vice-president; M. D. Stein, second vice-president; N. T. Smith, treasurer; and J. L. Willcutt, secretary and controller.

The consolidation embraces five of the oldest street railroad properties in the city, notably the Market street, Omnibus, North Beach and Mission, Central and City Railroads—the last three never having emerged from their primitive conditions as horse roads, though the City Railroad is about to be converted into an electric road. The Omnibus and Market Street roads have been operated as cable roads for several years, and are well known for the thoroughness of their construction.

The total length of constructed and projected roads is 175 miles, of which 69½ miles (single track) are now operated by cable; 18½ miles by steam motors and 67½ miles by horses. It is expected that 15 miles or more of the present horse lines will be operated by electricity early next year, with possible extensions to some of the cable lines.

In his new and larger office as secretary and controller, Mr. Willcutt will be relieved of many matters of detail which will be handled by Mr. Stein, who will give his entire time to the duties of acting manager. This will leave Mr. Willcutt more time to direct important matters of policy for which his long connection with the Market Street and other roads marks him pre-eminently the most experienced man for these large responsibilities, and for his duties as secretary of the Southern Pacific Rail Road Company, which office he still holds.

BEATS GEORGE WASHINGTON'S LITTLE HATCHET.

NOW if the trolley kills birds and little boys, and brings on paralysis and deafness, and strikes people with lightning, and is conducive to locomotor ataxia, why should not it kill trees?

M. E. Healy, of 364 Gates avenue, Brooklyn, N. Y., writes to Park Commissioner Brower, complaining of the fact that "trolley wires in front of our residence are killing the trees."

This letter was promptly referred to Professor L. Collins, the noted botanical specialist, who says: "I examined carefully the trees referred to and find that a small Norway maple stands between two silver maples (*acer dasycarpum*). The silver maples are large and meet over the small tree. Some of the leaves on the small tree are fading. The same state of things exists in many other places and far remote from trolley wires. I doubt that the trolley wire has had any effect on the foliage. It would be better to remove the small tree."

The general public reasons much on the plan of a southern planter, who thrashed a darkey for stealing a ham. The planter said, "A man stole that ham. Sambo is a man. Therefore, Sambo stole the ham."

THE use of funeral cars on the Minneapolis lines is still a possibility of the not immediate future.

THE LAKE STREET ELEVATED, OF CHICAGO.

SATURDAY, the fourth day of November, 1893, was celebrated by the owners of the Lake Street Elevated railroad, of Chicago, as the formal opening of the road, and closing the five years' struggle for its completion.

At three o'clock, in response to the beautifully engraved cards, at least one thousand persons gathered at the terminal, to inaugurate elevated transit on the west side. Five trains, of four coaches each, were provided for the guests, among which were numbered judges of the various courts, city officials, rapid transit authorities, and newspaper men.

was due largely to the efforts of Underwood & Green, of New York City, who negotiated with M. C. McDonald and his associates for the construction of the road, and in the midst of the recent financial stress the enterprise was carried through by them to completion.

The recent reorganization of the company, placed ex-mayor John A. Roche in the presidential chair, and Col. M. H. Alberger in the managerial position. H. B. Thompson is vice-president, C. H. Deere, G. B. Shaw, D. W. Campbell, C. H. Knight, Samuel Baker, William Ziegler and John H. Witbeck, are directors. The capitalization is \$10,000,000, and the bonded indebtedness is \$6,500,000. Four miles of double track are nearly completed, and the construction, at present decided on, will include $7\frac{3}{4}$ miles double track, or with storage tracks

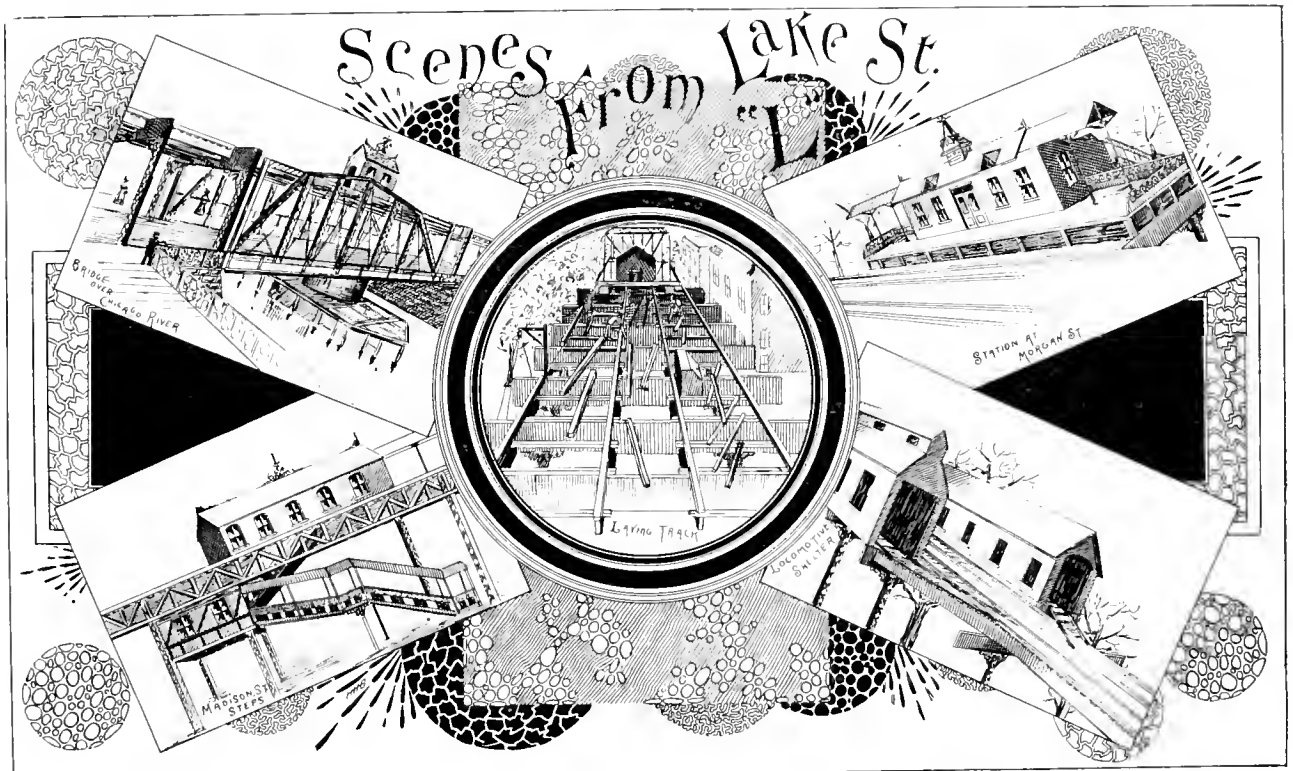

The inaugural trip extended over four and-a-half miles, or as far as Homan avenue. On the return, an elegant champagne luncheon was spread for the guests at the Canal street station, and presided over by Col. Alberger.

The Lake Street L Company was incorporated in April, 1888, and nearly \$1,000,000 in stock subscribed by Col. M. H. Alberger. The rest was taken by a half-dozen others, and the ordinance passed the same year. On December 18, 1889, the first of the heavy iron sections was put in position at the corner of Lake and Clinton streets. In quick succession, five rival companies sprang into existence, four of them, well backed by capital. These all were bitterly opposed to the Lake street franchise, but the rights, in full, were finally obtained for the length of Lake street and a down town terminal at the corner of Madison and Market streets, with the right to cross the Lake street bridge. At this point is the only curve in the entire road. The financing of the road

and siding, 17 miles of single track, running from the corner of Madison and Market streets to the western city limits.

The contractors for the structure, were F. L. Underwood and Willard R. Green, to whom great credit is due.

CROSSING THE RIVER.

The most unusual feature in connection with the road, and what for a long time threatened its possibilities of getting over into the business district, was the problem of crossing the Chicago river. By working jointly with the city officials, the foundation supports were strengthened and a new draw table installed, at which time electricity was adopted in place of steam for turning the draw. The draw span was also rebuilt and greatly strengthened, to admit of an upper deck for carrying the track, and safety interlocking devices added which effectually act to block the line when the draw is to open.

THE STRUCTURE

is not especially graceful or airy, but is said to be the heaviest yet erected. It is of plate girder, except at the bridge. The columns, which are of two channels placed face to face, with lattice connections, are set at the curb, and support a heavy cross girder, which spans the street at a height of 20 feet above the roadway.

The outer channel of the column overlaps the end of the cross girder and extends to the top chord. The columns contain approximately one ton of iron each, including the cast foundation capping. Each cross girder is 48 feet long by 6 feet deep and weighs 13 tons. The spans average 117 to the mile. On these cross girders rest four lines of longitudinal girders, each 45 feet long and 5½ feet deep, and weighing approximately 7000 pounds each. These are placed over the middle of the street and carry the two tracks, with room left for an extra track on either side, affording facilities for four tracks should they ever be required. The factor of safety is seven. The longitudinal girders are riveted through the web of the transverse girders, expansion pockets being provided at every fourth span. The longitudinal girders are sustained by cross lacing, and the track system acts as a further tie, each sleeper being attached transversely to the two longitudinal girders by a hook bolt engaging under the outer flange of the top chord of each longitudinal girder, and also extending through a 6 by 8-inch guard rail. A 6-inch guard rail on the inside is fastened by lag screws to each alternate tie. The track rail is 76 and 80-pound T, made by the Illinois Steel Company. It is laid a little inside the longitudinal girder, thus allowing for elasticity in the ties.

The structure is forty-eight feet wide, stretching from curb to curb of Lake street, and is underrun its entire length by the Lake street horse cars.

STATIONS.

The stations are not all yet entirely completed, but are sufficiently advanced for use. They are located at Madison, Randolph, Canal, Halsted, Morgan, Sheldon, Ashland, Wood, Robey, Campbell and California. As the extension proceeds additional stations will be established. The depots are ornamental structures, with the usual arrangements for ticket selling and handling of passengers, and all lighted with electricity.

THE ROLLING STOCK

at present on the ground, or rather above the ground, includes 25 two-cylinder compound locomotives, built by the Rhode Island Locomotive Works, Providence, and 125 passenger cars from the Gilbert Car Company, Troy, N. Y. The selection of the compound type of locomotive was a direct change from the original plan, and would seem to settle the question hereafter where steam is to be used for elevated work. It is a matter of regret, however, that electricity was not chosen, since the successful operation at Jackson Park so fully demonstrated the ability of that agent for the work. The engine complete weighs 60,000 pounds; length over all 24 feet;

diameter of drivers, 44 inches; cylinders, high pressure 13, and low 21 inches by 18 inches; diameter of boiler, 44 inches; steam pressure, 180 pounds; and tank capacity, 700 gallons. The engine may be run simple or compound at the will of the engineer. Hard coal is used.

The coaches are of the standard type, and are finished in mahogany, with light colored veneered ceilings. The windows are extra wide, and the Pintsch gas system is supplemented by four oil lamps on each side, for emergency use. Cars weigh 14 tons each and are steam heated by the Morton system; trains run on three and five minute headway. Cars run at short intervals from 4:30 until 1 a. m., and less frequently during the balance of the night. The storage yards will be in the vicinity of Forty-fourth street and the Belt line.



J. A. ROCHE.

The safety of the public is assured by a complete set of signal devices, and from the fact that R. I. Sloan, formerly of the Alley L, has been engaged as chief engineer of the line. On the first day the line was open for traffic 50,000 passengers were carried, which however, naturally included a large number of curiosity riders.

THE CHICAGO RAIL BOND.

AMONG the great variety of worthless trash known as rail bonds the "Chicago" rail bond, invented by H. R. Keithley, of the Chicago City Railway, stands out as one of the few types which can be thoroughly depended upon. It has been clearly pointed out many times recently that the rails are good enough conductors to make a good return, and that the real need

is for a heavy bond and more than all for a good bond connection with the rail. This is accomplished in a very substantial manner in the "Chicago" bond. From one piece of copper a bond is rolled with thimble or tube shaped ends. These ends being inserted in the holes, the edges of the tubes are bent back to temporarily hold the bond in place and an iron plug is riven in the tube. This plug manifestly expands the soft copper tube so that it makes a moisture proof contact, and at the same time

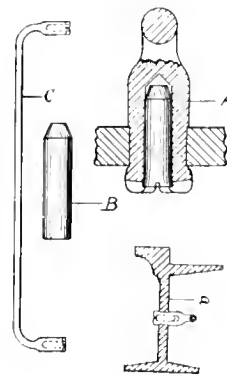

one of large area. The principle of expanding a tube to fit a hole is the same as that used in putting in boiler flues, and if it is possible to expand an iron flue to a water tight fit it is evident that a soft copper tube can be so expanded. This bond has been adopted by the Chicago City Railway. Letters of inquiry to the inventor should be addressed to H. R. Keithley, care Washburn & Moen, 107 Lake street, Chicago.

PERFORMANCE OF THE CHICAGO CITY RAILWAY'S ELECTRIC PLANT AND EQUIPMENT.

THE figures published from time to time on the performance of both large and small electric railway plants, have been in a measure unsatisfactory both to the manufacturer and prospective builder, for the reason that the plants under test have nearly always been equipped with some pieces of apparatus that are not up to date. The figures here published on the performance of the electric plant of the Chicago City Railway, can not fail to be of great interest, as the entire plant from boilers to motors is equipped with the latest and most improved apparatus. The figures on the performance of the motors were obtained under the supervision of Electrician

BOILERS OPERATED.

Five 72x20 tubular boilers, equipped with the Murphy smokeless furnace. Average steam pressure, 95 pounds. Boilers evaporating 7½ pounds of water per one pound of screenings, costing \$1.50 per ton, delivered at the power house.

ENGINES OPERATED.

One pair 24x48 high pressure, improved Wheelock engines, equipped with the Hill valve, running 100 revolutions per minute. The average consumption of water per horse-power hour was 28 pounds, and thereby developing a horse-power with 3¼ pounds of screenings.

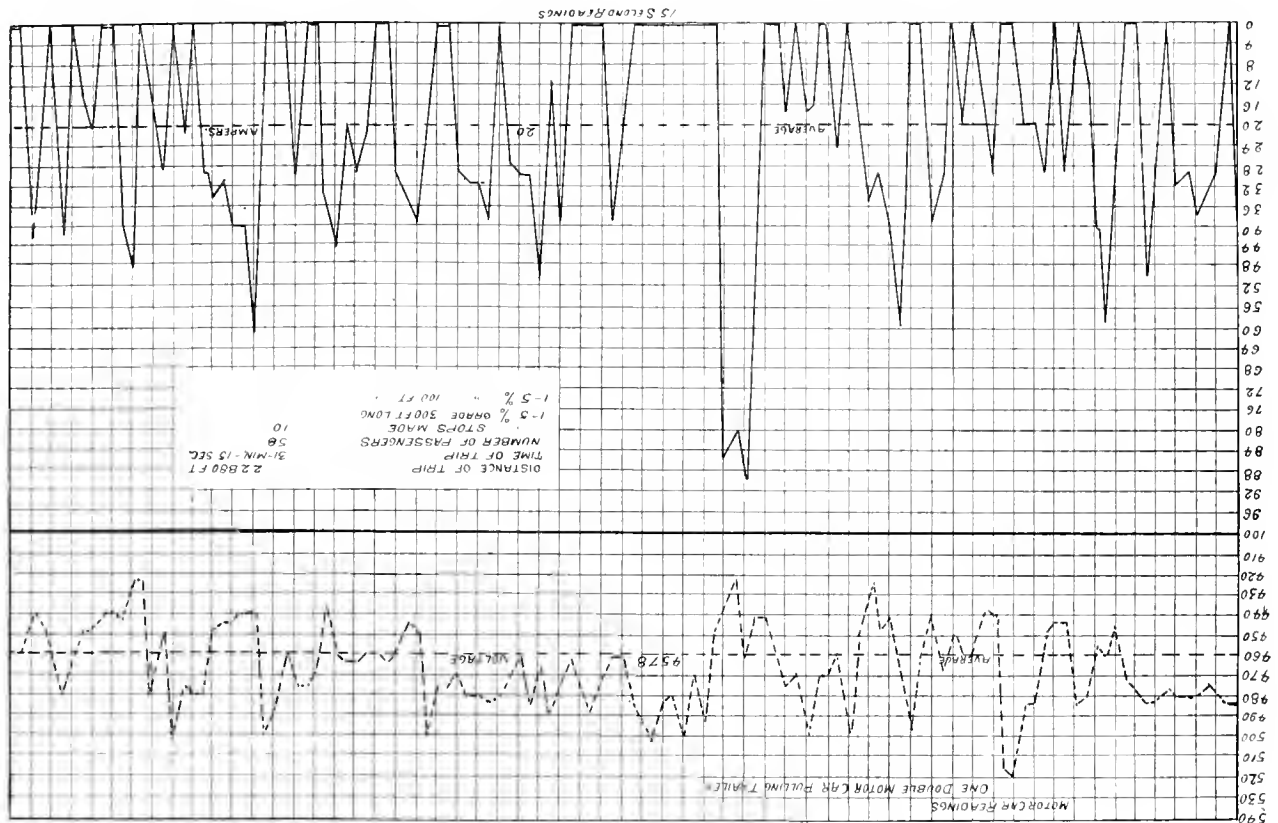

FIGURE 1.

G. W. Knox. The data on power plant work are furnished by Chief-engineer Robert J. Hill.

The conditions under which the electric lines have been operating the past summer are very similar to those on the City Railway's cable lines, viz.: heavy traffic and smooth road-bed, with but few grades. Motor cars were run with one, two and sometimes three trailers. As might be expected, the results show that the greater part of the difference between the cost of operating cable and electric lines is due to the widely different conditions of traffic. The more nearly the environment of the electric road corresponds to the cable, the more nearly do the costs of operation correspond.

The following is the report of Chief-engineer Hill, on the performance of the plant "Chicago Day," October 9, 1893:

GENERATORS.

Two, No. 6, Westinghouse multipolar generators, each of 1,000 ampere and 550 volt capacity, running 300 revolutions per minute, operated with the Hoadley Brothers' compound wind system of rope transmission, using 1¼ inch manilla rope.

CARS IN SERVICE.

Fifty-one double equipped Westinghouse single reduction motor cars. Each motor, 25-horse-power capacity. Ten single equipped Westinghouse single reduction motor cars. Each motor, 25-horse-power capacity. Forty-nine trains with single trailers, and twelve trains with double trailers, making a total of 134 cars.

The reading of the instruments, taken at regular intervals of thirty minutes, from 7 a. m. until 12 p. m., show the following results:

Average voltage at station	549
Minimum amperes	600
Maximum amperes	1,700
Average	1,035
Minimum horse-power developed at station	548
Maximum horse-power developed at station	1,403
Average horse-power developed at station	888

The following is a comparative table illustrating the difference between September 9, an ordinary World's Fair day, and October 9, "Chicago Day" at the World's Fair.

	SEPT. 9	OCT. 9.
Number passengers hauled	124,604	208,575
" motor cars in service	61	61
" trailer cars in service	45	73
" motor car miles	5,812.5	5,812.5
" trailer car miles	3,740.6	5,458.5
Total number car miles	9,553	11,271.0
Average car miles per car	90.1	84.1
Rated horse-power per pair engines, maximum ..	1,000	1,000
" " generators, maximum ..	1,400	1,400
Duration of test at power house (hours).....	21	17

\$1.50 per ton is \$.003 per car mile and \$.0059 per motor car mile. These we believe are the lowest figures ever published on this item, and they do not compare unfavorably with cable roads. The efficiency is due to a combination of favoring circumstances—large plant, good track, small line drop, good ground return, and last, but not least, to the large number of trailers. The increase of car mileage "Chicago Day" of 16 per cent, due simply to the increase of trailer mileage, decreased the electrical horse-power per car by about 6 per cent.

Proceeding now to the data on motor car performance, worked out by Electrician Knox in the face of extra duty called for by the World's Fair travel, we find first a most interesting development in regard to double, as against single motor equipment. The following table gives the average of readings taken on two cars working under the same conditions, viz.: pulling a seven ton dead motor car over Thirty-fifth street.

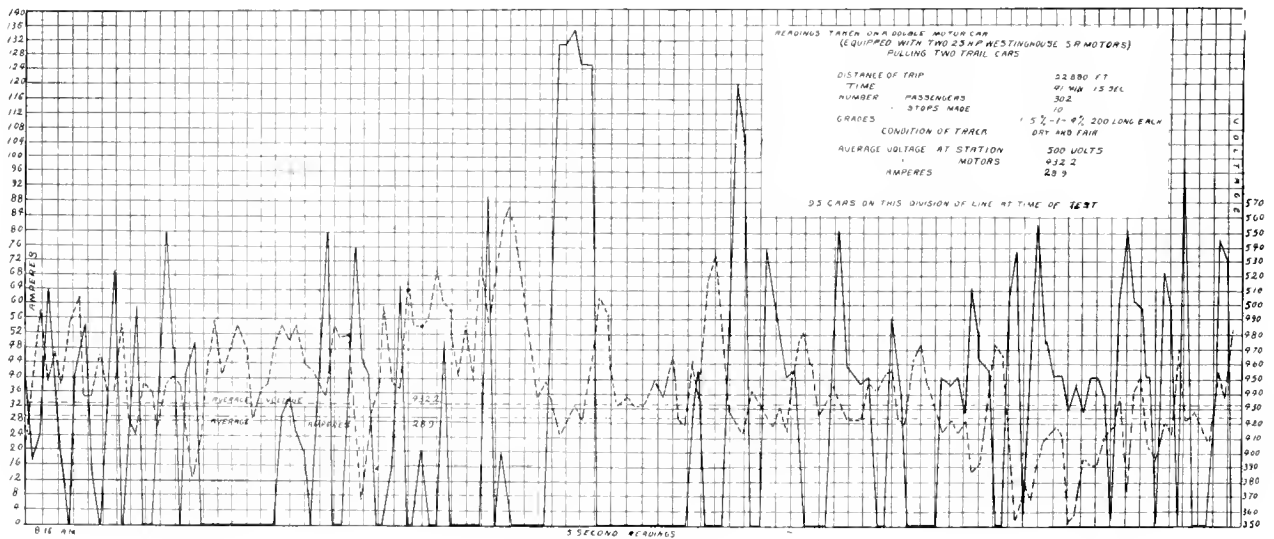

FIGURE 2.

Average amperes at station	875.7	1,035.0
" voltage "	524.9	540.0
" electrical horse-power out-put at station ..	616.1	749.1
" horse-power developed by engines	740.0	888.0
" amperes per car	8.2	7.7
" electric horse power per car	5.8	5.5

NOTE. Tracks in excellent condition. Four grades of about 5 per cent on lines, each 750 feet long. Length of single track road operated, 28.52 miles.

This report demonstrates the fact that has already been recognized in but an indefinite way, that increasing the carrying capacity by adding trailers does not increase the power required in proportion. In other words, adding trailers to every motor doubles the capacity, but does not double the power taken. This in itself is a potent argument against the proposed practice of running elevated trains with a motor on each car, even were there no other considerations.

Under the head "engines operated," the report states that the coal consumed per horse-power hour was 3.75 pounds. The "Chicago Day" average indicated horse-power is given as 888. According to this the coal consumed for the 17-hour run would be 23.1 tons, which at

SINGLE VS. DOUBLE MOTOR EQUIPMENT.

	DOUBLE.	SINGLE.
GOING WEST.		
Average amperes	21.8	25.2
Average car voltage.....	470.1	474.8
Average electrical horse-power	13.7	16.0
Time of trips (minutes)	20.5	20.5
Distance (miles)	3.0	3.0
Voltage at station	500.9	501.7
Stops made.....	2	2
GOING EAST.		
Average amperes	22.2	23.0
Average volts	467.6	471.8
Average electrical horse-power	13.9	14.5
Time of trips (minutes)	17.25	17.25
Distance (miles).....	3.0	3.0
Voltage at station.....	500.0	501.5
Stops made	2	2

These results will be a great surprise to many, as it has always been supposed that the single equipment was the more economical on light loads. It may be argued that the single equipments were never intended to pull trailers, but the current consumed in both cases was rather small, and on the whole the showing for the single

equipment is rather poor. If the single equipment fails to show its economy under favorable conditions, what will be the case under unfavorable ones?

Figure 1 is a curve plotted from readings on a double motor car pulling one trailer in regular service. Figure

the motors under different conditions. The current taken will be found to average higher than with the old style double reduction motors.

The line drop of the system is very small. Readings taken simultaneously at station and centers of distribution

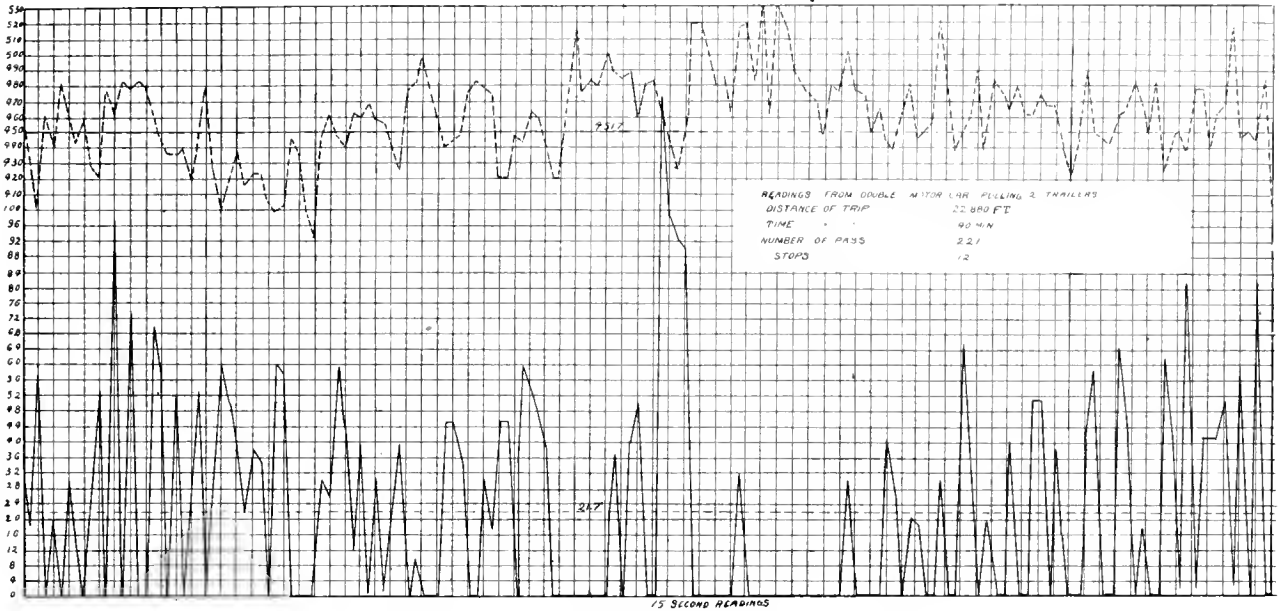

FIGURE 3.

2 is from a similar car pulling two trailers in regular service. Figure 3 is from a motor car pulling two trailers and carrying 221 passengers. Figure 4 is from a double motor car pulling a dead motor car. Figure 5, which illustrates the way in which the motors on a double motor

every fifteen seconds for a period of fifteen minutes, when the traffic on the system was medium, show an average drop at the different section centers as follows: On Forty-seventh street, 4,400 feet from the power house, 150 amperes flowing, 8 single motor cars on section, 33.4

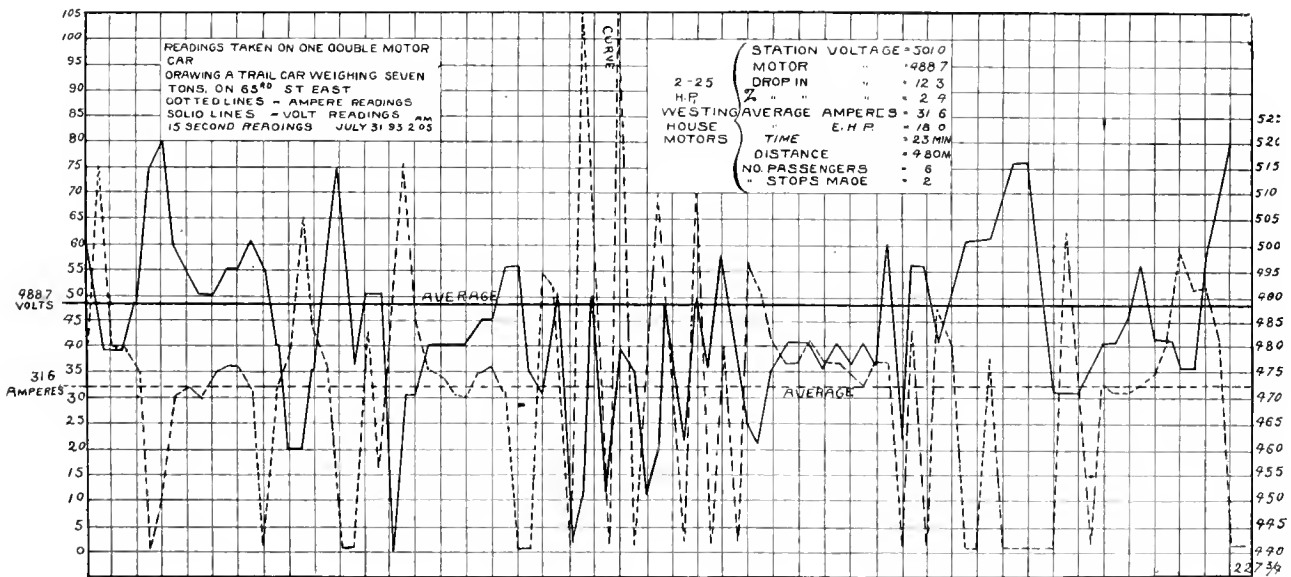

FIGURE 4

car equalize, will be a surprise to many a railway electrician who has had experience with double motor cars in which one motor tried to act as a dynamo.

These curves are taken at random from a large number and are fairly representative of the performance of

volts drop. On Thirty-fifth and Wood streets, 22,000 feet from power house, 100 amperes flowing, 4 double motor cars on section, 38.7 volts drop. On Thirty-fifth street and Wentworth avenue, 12,760 feet from power house, 250 amperes flowing, 1 double motor cars on sec-

tion, 33.8 volts drop. On Sixty-third street and Sherman avenue, 12,320 feet from power house, 250 amperes flowing, 8 double motor cars and 8 trailers on section, 41.8 volts drop. On Sixty-first street and Cottage Grove avenue, 11,440 feet from power house, 350 amperes flowing,

LONG DISTANCE TRANSMISSION AT NIAGARA.

THE Cataract Construction Company, which is constructing the great water power plant for utilizing a part of the power of Niagara, and whose movements have been watched with interest by all those engaged in electrical pursuits, awarded the contract for electrical generating apparatus to the Westinghouse Electric & Manufacturing Company on October 28. The system used will be the two-phase alternating system, which has been advocated by the company for some time for use in general light and power transmission. That the two-phase system would be adopted was to be expected from the remarks of the Cataract Construction Company's consulting engineer, Professor George Forbes, at the electrical congress last August. The great electrical manufacturing companies of America sent in plans and proposals advocating the method they preferred, all of which received very careful attention at the hands of the company's engineers, with the above result.

The two-phase or Tesla system of alternating current transmission is that exhibited by the Westinghouse Company at the World's Fair. At Niagara the three 5,000-horse-power 2,000 volt alternators, called for by the contract, are to be mounted to revolve in a horizontal plane directly on the turbine shafts. The field coils will revolve and the armatures be stationary. In the two-phase system each dynamo generates two separate alternating currents. These currents differ in phase 90 degrees, that is, at the time one of them is maximum the other is zero. For lighting purposes each of these currents is utilized separately by running the ordinary two wire alternating mains. Where it is desired to run motors, the four wires carrying the two dynamo currents are connected to a two-phase motor of the Tesla type, where the two currents produce a rotating field, which drags the motor armature around after it. These motors are self starting, in contradistinction to the synchronous single-phase alternating motors, which are the only large single-phase alternating motors on the market to-day, and which must be run up to speed before the current is turned on. By using a two-phase current, rotating transformers can be run, giving out continuous current for electric railway or other purposes. These rotating transformers are of about the size of generators of the same capacity. The voltage of the Niagara Falls dynamo being 2,000 to 2,400, it will be necessary to use step up transformers to raise the current to a pressure more economical for transmission. What this pressure will be has not yet been announced, but will probably not be under 15,000 volts, and may be very much higher. It would not be surprising if street railways near Niagara would be among the first large power users to patronize the Cataract Construction Company's power. The change would mean simply the abandonment of the steam plant and the substitution of rotary transformers for the generators.

13 double motor cars and 13 trailers on section, 35.5 volts drop. On Sixty-third street and Sheridan avenue, 15,840 feet from power house, 180 amperes flowing, 7 double motor cars and 7 trail cars on section, 40.8 volts drop.

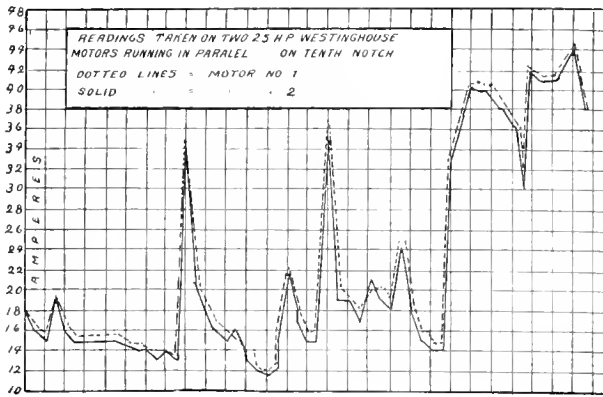

FIGURE 5.

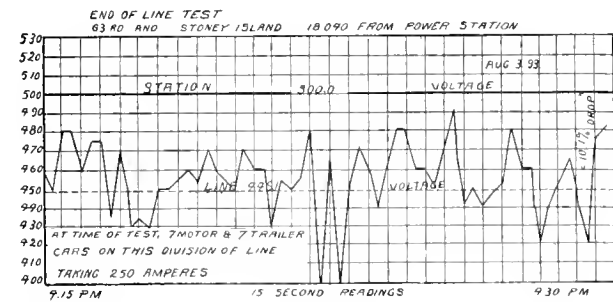

FIGURE 6.

On Sixty-third street and Stony Island avenue, 18,040 feet from power house, 200 amperes flowing, 7 double motor cars and 7 trail cars on section, 50.9 volts drop. On Sixty-first street and Washington avenue, 16,380 feet

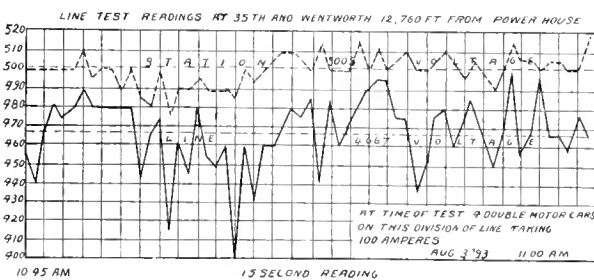

FIGURE 7.

from power house, 400 amperes flowing, 13 double motor cars and 13 trailers on section, 53.7 volts drop. Average drop at centers of distribution of sections, 7.4 per cent. Figures 6 and 7 are curves plotted from voltage readings on the lines.

NIAGARA FALLS PARK & RIVER RAILWAY.

THE opening to traffic of the Niagara Falls Park & River Railway last June, marked a distinct advance in electric railway practice and a new era for sightseers around Niagara Falls. The road is a Canadian enterprise and is built entirely on Canadian soil, following closely the Niagara river for a distance of 11½ miles between Queenstown and Chippewa, affording a view of falls and river that can be obtained in

the road, aside from the electrical features, is very similar to that of a steam road. It follows the edge of the bluff so closely that nowhere is it more than sixty feet from the edge. To do this it was necessary to go over government land, and about \$10,000 per annum is paid for this privilege. A good idea of the scenery along the line can be obtained from our engravings.

The road is ballasted with broken stone, quarried

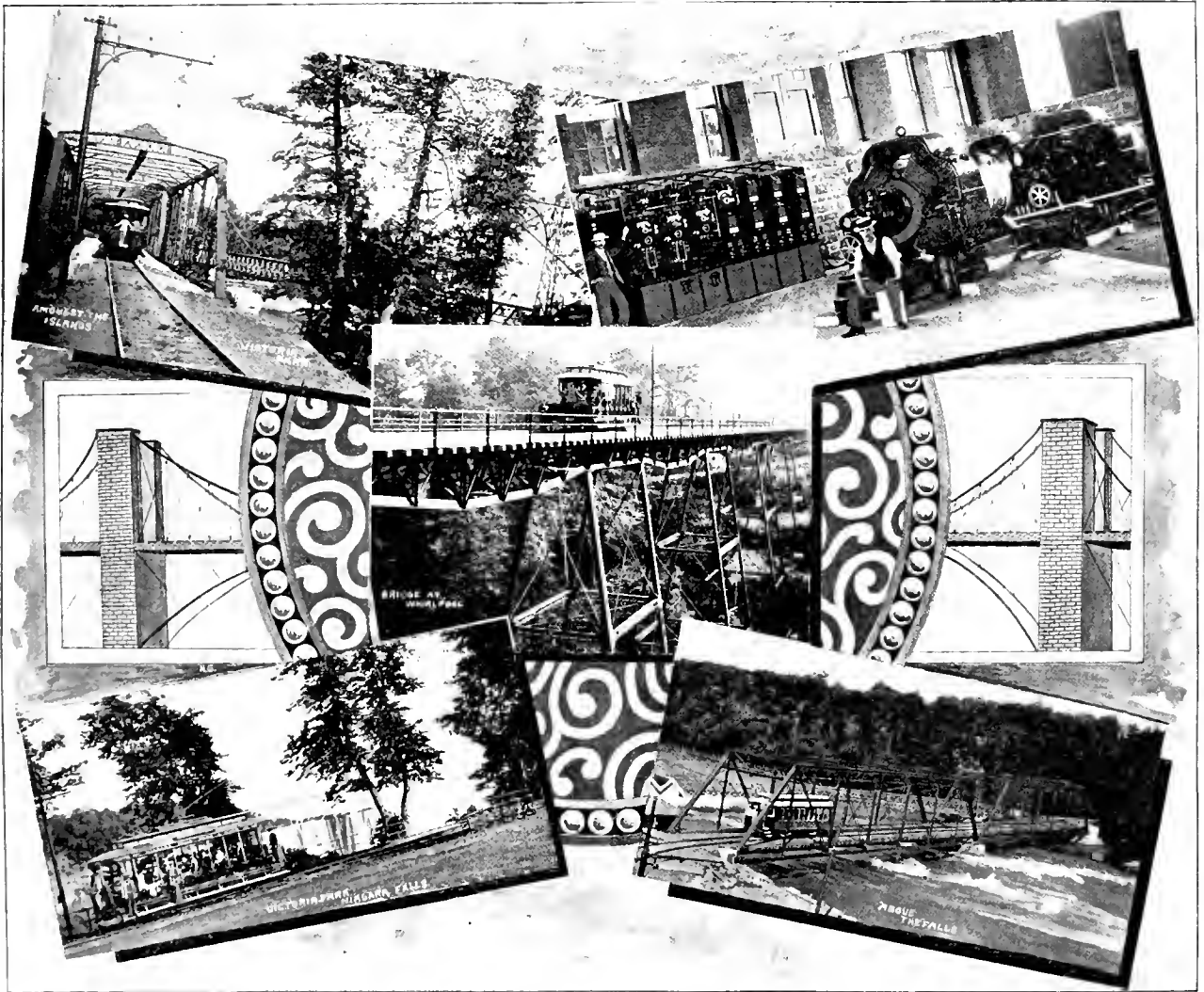

SCENES ALONG THE NIAGARA FALLS PARK AND RIVER RAILWAY.

no other way, not even by patronizing the exorbitant hackman, who has so long held sway in this vicinity. The promoters of the enterprise are all well known Canadian business men, the officers being president, E. B. Osler, Toronto; vice president, William Hendrie, Hamilton; secretary, R. A. Smith, Toronto; general manager, W. A. Grant, the latter being formerly with the Grand Trunk Railroad. The mechanical and electrical engineer is W. Phillips. The road and water power plant are built according to the plans of W. T. Jennings, civil engineer of Toronto. The general description of

along the way. Fifty-six pound T rails are spiked to cedar ties 2 to 2½ feet centers. Curves are somewhat sharper than those permitted on steam roads. Guard rails and braces are provided at curves. The heaviest grade is near the northern terminus at Queenstown, being 1½ miles long, varying from 3 to 5½ per cent, and ascending 346 feet.

The trolley lines and feeders are supported on side bracket poles, iron in the park and wood the balance of the way. The trolley wire is No. 00 hard drawn copper. It is sectioned, each section being fed in the

middle, and several sections being fed from one feeder. The iron poles in the park are surmounted by a cluster of five 32-candle-power lamps. It has been decided to thoroughly ground these iron poles, because leakage through the insulators creates a difference of potential

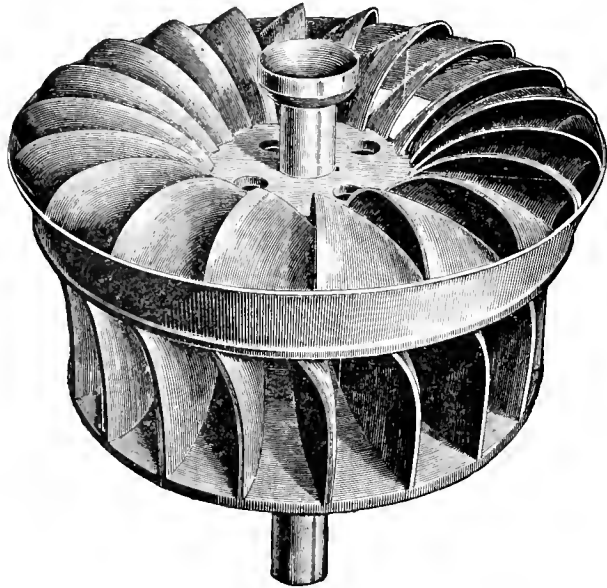

INTERIOR VIEW OF TURBINE.

between the cement-set pole and the ground, which has a stimulating effect on people leaning against the poles. Twenty turnouts were installed originally, but owing to

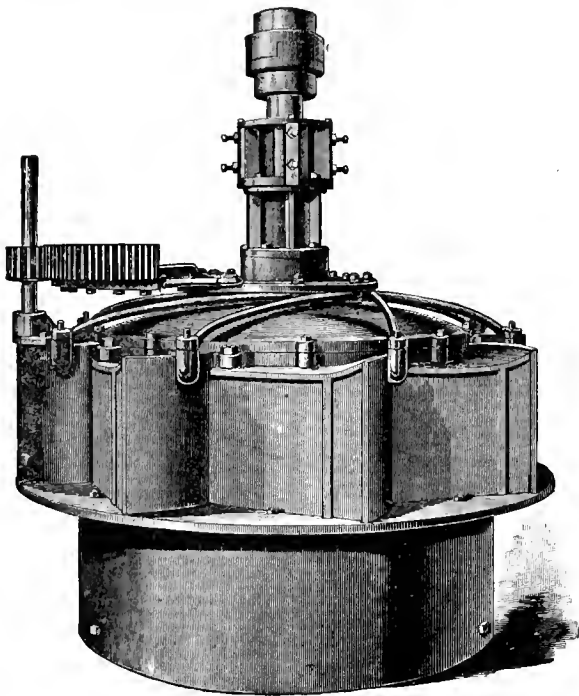

EXTERIOR VIEW OF TURBINE.

the enormous traffic that came to the road the past summer, it has been decided to double track it the entire length.

The average schedule time is eight miles an hour, to give opportunity for sight seeing. The distance has been covered, however, at the rate of twenty-four miles

an hour. The motor car equipment consists of ten double truck observation cars, ten 28-foot open cars, three box cars, one parlor car and one baggage car. These are all mounted on McGuire trucks and furnished with two W. P. 50 motors, made by the Canadian General Electric Company, at Peterboro, who supplied all of the electrical apparatus. In addition there are eighteen trail cars. Bodies were all built by Patterson & Corbin, of St. Catherines. The wheels have the unusual flange of 1 1/2 inches, with 3 1/2 inch tread. They are 33 inches in diameter.

There are two power houses. The one at Queens-town is intended merely as a relay, to help, if necessary, on the heavy grade at that point. It is a steam plant. The greatest interest centers around the main station, which derives its power from the Niagara river. The

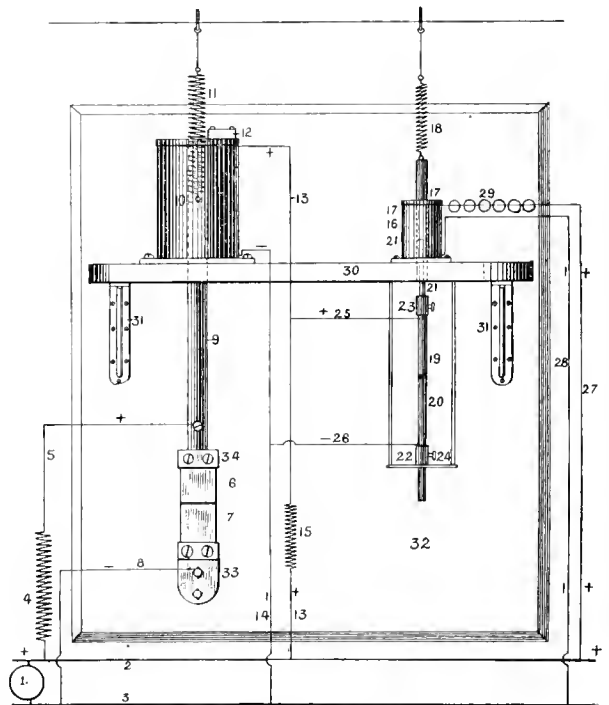

THE SPEED REGULATOR.

head of water is fifty-seven feet. The vertical turbines made by W. Kennedy & Sons, of Owens Sound, Ont., are known as the "New American." They run at 221 revolutions per minute, and are geared to the line shaft by mortise wheels and pinions. Only one is used at a time, the capacity of each being 1,000-horse-power. Three multipolar 200-kilowatt generators are in place at present, and are shown in our engraving. The whole plant has been build with an eye to extension.

SPEED AND VOLTAGE REGULATION.

Every engineer of a water power plant who reads this article will inquire, "What is the method of speed regulation?" that being the great problem in all water power electric railway plants. The device now being used has, according to the testimony of the consulting engineer, Mr. Jennings, proved itself very useful. It is the invention of E. A. Barber, electrician of the Watertown, N.

Y., Street Railway, at which place it has been in use six months, where it has worked perfectly, requiring almost no attention. In this method the speed is kept constant by automatically throwing in a dead resistance, when the the load is small, and throwing this resistance out when the load is large. In the engraving, 1 is the generator, and 2 and 3 the mains. The regulating resistance, 4, is thrown in and out by the contacts, 6 and 7. A solenoid, 16, is connected across between the mains, and hence its pull will vary with the voltage. When the voltage rises above a certain point, the iron core, 17 (which is normally held by the spring, 18), is drawn down, so that contact is made between 19 and 20. These contacts short circuit the coil 10, which is in parallel with the mains through a high resistance. 15. The coil, 10, being short circuited, the iron plunger, 9, is let down, the contacts 6 and 7 come together, and the load of dead resistance is thrown in.

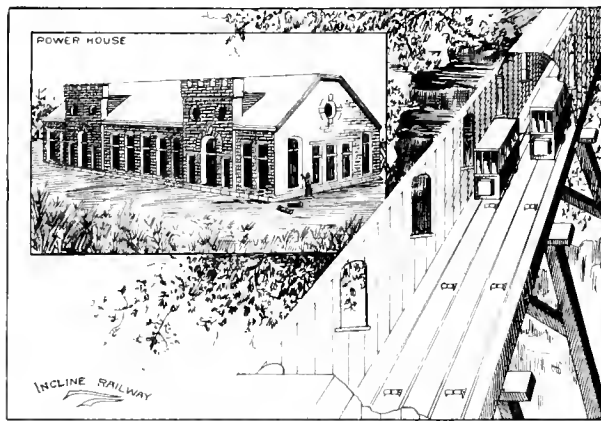

POWER HOUSE AND INCLINE RAILWAY

A piece of iron, 12, is put on top of 10 to assist in lifting the iron core, 9, and also to act as a stop when it is lifted. It is manifest that a number of these regulators can be used and adjusted to different voltages, so that more resistance can be cut in with each rise of voltage.

It has been found necessary to make the contacts of carbon, to prevent injurious arcing. The many unsuccessful attempts that have been made to regulate successfully with water power make the results attained by this device especially gratifying.

INCLINE RAILWAY.

The incline railway run by the company at the whirlpool rapids is operated by hydraulic power, but it is applied in a rather peculiar way. The cars, which hold twenty people, have large tanks under the seats. One car goes up while the other goes down. The difference in weight is compensated for by running water into the tank. Two cables, one three-fourths and the other seven-eighths of an inch in diameter, run over a drum at the top, the controlling being done by a friction brake on this drum. As there is plenty of water at hand, this is probably the best method for the place. The length of the incline is 270 feet and the grade is 40 per cent. The ascent occupies a minute.

The effect of opening the road has been to very largely

divert the tourist travel from the American to the Canadian side, which condition bids fair to continue unless the steam road to Lewistown,—which will be remembered by delegates to the Buffalo convention—adopts electricity in place of steam. This it can easily do and at comparatively small expense.

RAIL BONDING.

BY H. R. KEITHLEY.

THE problem of rail bonding is not a question of first cost, it is a question of efficiency and permanent maintenance, for the expense of labor alone for rebonding the track is three or four times the first cost of copper. That is making the liberal allowance of \$200 per mile of single track as first cost of copper for bonding a railway line with No. 0000 copper bonds. If the track is properly bonded with No. 0000 bonds the bonds will last as long as the rails. But if No. 0 bonds are used, costing \$100 per mile of track, and required to do the work of No. 0000 bonds, the No. 0 bonds having only half the conductivity, will carry only half the current carried by No. 0000 bonds, and will furnish sufficient resistance to force the other half of the current into the earth. This leakage of current into the earth from the No. 0 rail bonds will cause their rapid destruction by electrolytic action, whereas the No. 0000 bonds would carry the current without leakage and they would not be destroyed by electrolytic action, and if properly connected into the rail, so that there would be no resistance at the joint, the No. 0000 bond would certainly last as long as the rails. But the No. 0 bonds would be destroyed in from three to five years and the cost of labor alone, for rebonding the track, taking up pavement and replacing it, would be from \$600 to \$800 per mile of single track, which is from three to four times the first cost of No. 0000 copper bonds, which is \$200 per mile. Experience has fully demonstrated the correctness of this statement, for it is well known that all electric railways which bonded with No. 4 wire two or three years ago, are now obliged to take up the paving and rebond their track, at a cost of from \$600 to \$800 per mile of single track for labor alone. The system of grounding the track at intervals is not here considered, for the reason that electrical engineers and street railway managers are convinced by experience that the earth return must be abandoned and the return circuit must be confined to the rails entirely, if possible, by use of heavy copper rail bonds, in order to prevent destruction of gas and water pipes by electrolysis, which is the direct result of using the earth for a return, and in order to prevent the destruction of their rail bonds by electrolytic action, resulting from the use of small bonds, capable of carrying only a small proportion of heavy electric railway currents.

THE Chicago City Railway magnificently helps out the Columbian museum project by subscribing \$50,000 cash and 10,000 shares of Exposition stock.

VERTICAL CROSS COMPOUND ENGINE.

THE accompanying illustration represents a vertical engine, designed by the Ball Engine Company, Erie, Pa., and adapted especially for electric lighting and electric railway service. It will be built in various combinations, viz.: cross compound, triple and quadruple expansion. The view shows a cross compound vertical engine, the high pressure cylinder of which is 16 inches, low pressure cylinder 28 inches, stroke 16 inches, revolutions 240.

In the design of this engine, the builders have retained all the features of strength and solidity possessed by their well known horizontal engines, with the same degree of accessibility.

The engine being of the enclosed form, has not only the advantage of cleanliness, but by its manner of construction, all parts are readily reached. For instance the shaft boxes may be removed and the shaft taken out without the disturbance of any other part of the engine, and with the greatest facility and ease. The valves are simple and durable. As originally fitted up they are absolutely steam tight, and owing to their construction continue to follow up their wear without any outside attention. The valve driving mechanism is very simple and designed so that all necessary adjustments may be speedily and safely accomplished by attendants of average ability. Internal condensation is reduced to a minimum and compression used to its greatest point of economy. The crank shaft is a solid steel forging, from end to end, of ample proportions, and the crank shaft bearings are adjustable for wear. It is claimed for the governor, that it will give practically perfect regulation, with almost entire freedom from wear and unequalled quickness of action. It is economical and cleanly in the use of oil, simple and durable, and noiseless in operation.

The engine, from a mechanical standpoint, is well designed as to distribution of materials, and is thoroughly

well built. The use of large and accurate tools in its construction allows the operation on each part to be originally perfect in itself: is adapted for hard and constant service in the most trying situations, and is claimed that for an equal transmission of power, either as a steady or a widely intermittent quantity, it has no superior.

CARRIED STOLEN REGISTERS.

A CINCINNATI conductor will soon have as wide and as varied a reputation as a Philadelphia lawyer. No less than three times within the last six months has it been chronicled that Cincinnati conductors have been "called short" in the day of reckoning.

One day last month Superintendent John Harris and a squad of inspectors found that a nice new scheme had been hatched up to beat the company. The registers are of the portable type, and the very simple method taken was to quietly steal a few of them for use on the line on certain trips. One of the suspected conductors was approached and ordered to deliver up the missing machine. This he reluctantly did, and displayed an exact mate of the legal fare counter. A more thorough investigation showed that a number of the registers had been appropriated. The conductors on whom the missing registers

were found were arrested for larceny of the registers.

THE change boys of the Louisiana street stables of the Indianapolis street railway company, took a sudden notion to dictate terms to the barn boss. The barn boss took a notion to dictate to the boys, and five change boys are looking for jobs.

ONCE more the Keeley motor threatens to mote. Another assessment of the stockholders is the only thing that will obviate the great danger. Like compressed air and compressed nerve, the Keeley motor seems to have no cure, not even old Time.

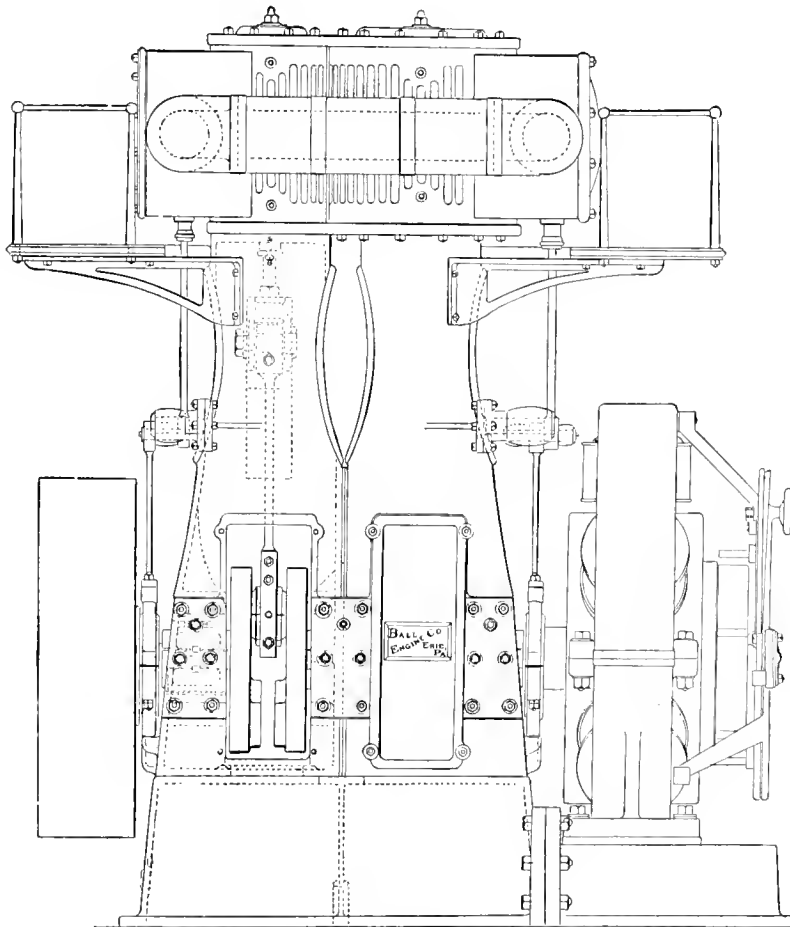

BALL VERTICAL CROSS COMPOUND ENGINE.

PHILADELPHIA'S BAD BOYS.

A RIVER ROAD.

BAD boys and good electric cars are two things that Philadelphia has on the most progressive and metropolitan order. The cars are of the Westinghouse brand, but the boys are just boys.

Not long ago a car was bowling along a street recently excavated and torn up, preparatory to that mysterious process known to the street commissioners as "repairing the street." The car held a number of Philadelphian

JUST across the Ohio river from Wheeling, W. Va., are three or four of the liveliest little towns in the great commonwealth of Ohio. They are by name, Bellaire, Bridgeport, Aetnaville, West Wheeling and Martin's Ferry. They are no more three little towns, but rather one large interdependent and intercommunicated municipality, by the grace of the Bellaire, Bridgeport & Martin's Ferry Electric Railway.



SCENES ON THE RIVER ROAD.

shop maidens and shoppers. As the car stopped at a corner to deposit a woman and three bundles, a most distressing shriek came from under the cars. "Oh, me legs, me legs! Take dat car off'n me," came the yell. The women cried, some fainted, and one or two men showed signs of getting pale. The passengers bounced off, one and all. Then four boys crawled out from a temporary culvert beneath the tracks. "Hully ge!" puffed one of the rascals; "we gub dem de shivers dat time." And then they acquired a Chicago move and got ahead of Philadelphia policemen by four laps and a furlong, while the passengers tried to force their hearts back into their accustomed places.

The franchise for the road was obtained by J. K. Jolly, of Beaver Falls, Pa., who has, through his energy and ability, consummated his labors by opening to the public, August 29, eleven miles of road through a densely populated county centering at Wheeling. The franchise was granted March 22, 1893, and the road built in the following five months, in spite of the depression of business and gloomy prospects.

On the opening day the two young sons of Mr. Jolly, Eugene and Erskine, aged respectively eleven and five years, acted as motorman and conductor for the first car. Both were attired in uniform and we introduce them to our readers as future street railway men of prominence.

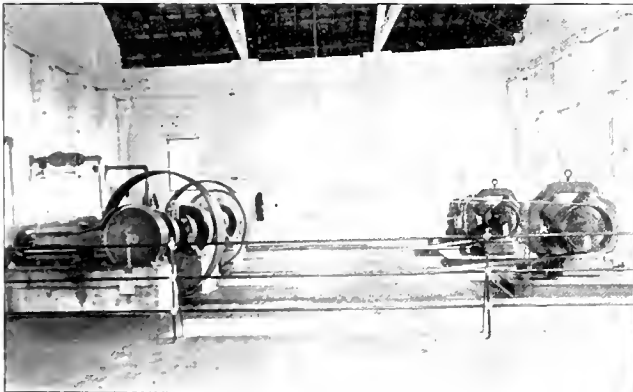

A RIVER ROAD POWER HOUSE.

In Boston, "sacred Boston," Joseph Cook calls it, charitable people dispense street car tickets to poor invalids, so that in lieu of carriage rides the afflicted may ride about the suburbs free. The privilege is abused shamefully, however, and many able bodied rascals, who probably rob the weak, present the tickets.

The eleven miles of railway owned by the company are laid with Johnson girder, 3½ miles of 83-pound and 7½ miles of 63-pound rail. The gauge is 5 feet 2 inches. The maximum grade is 4½ per cent.

The rolling stock is built by the New Castle Car & Manufacturing Company and consists of twelve cars, 18

foot body each, and 26 feet over all. These are equipped with two Thomson-Houston 15-horse-power motors each, and run on 33 inch wheels. The power station represented in our engraving is a brick structure with stone trimmings, with dimensions 85 by 60 feet. Here are enclosed three engines of the well-known Buckeye type. Two of them are of 175-horse-power, and one is 125. The engines are giving the best of service, smooth running and efficient. The three 150-horse-power boilers were built by R. Munroe & Son, of Pittsburg. The generators are three in number, two 150-horse-power and one 80, belt driven from the Buckeye. The generators are of the Thomson-Houston pattern.

Besides the number of towns connected by the river

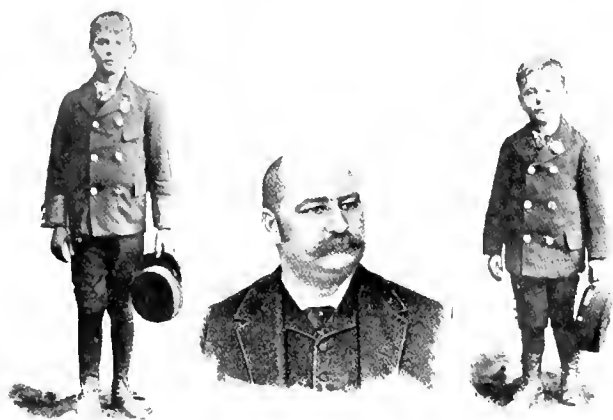

EUGENE.

J. K. JOLLY.

ERSKINE.

road there is a traffic arrangement with the Wheeling road which makes it possible to transfer passengers across the Ohio to Wheeling. The country through which the line passes has a large manufacturing population, besides a goodly agricultural foundation to keep up the sinews of war.

The signs of the times, rightly read, say that the River Road, the Scranton & Carbondale and the half dozen other inter-connecting lines, will at no late date, solve the problem of city life that so much troubles our latter day philanthropists; and prove the greatest and truest servants of mankind to be those who build electric railways making the city the country, and the country the city.

ENGLISH FARE RAISING.

OUR British brethren, when they have a hard time and people refuse to patronize the omnibus system, don't cut expenses; they simply raise the fares. On September 18, the London General posted a schedule of fares and the public simply had to grin and bear it. The "pirate" busses, those run by private parties, are reaping great benefit from the advance, as they continue to carry for one penny.

THE Levant Herald, published at Constantinople is authority for the news that a line of street railway will be run along the right bank of the Tigris, from Bagdad to several villages. Too bad that Noah and Job didn't live to see progress in this region and make something off of town lots!

WHERE CONDUCTORS COME FROM.

VICISSITUDES of wealth, power and pride are nowhere more apparent than on the back platforms of the larger eastern street railways. Every trade, profession and calling is represented. Doctors and bakers, merchants, lawyers and undertakers are plentiful.

Colonel Fletcher, of New York, who appoints the conductors, gripmen and drivers, has a number of amusing incidents to tell of the ups and downs of his appointees.

"I once had a conductor on the Broadway line," said he, "who was formerly of Governor Hill's staff. He was a wealthy lumberman of Albany, but became engrossed in politics to the detriment of his business, his reputation and his health. He was ruined and came to New York to recoup. He drifted into Wall street and lost all he had left and then went onto the rear platform. He worked all winter but finally secured a position more to his taste and is now prospering.

"A man who was once a wealthy South Carolina planter came into the office and asked for a place one day. He had lost his property in a legal fight and had to begin the world over again. I know another ex-conductor who is now a county treasurer, and still another who is proprietor of a Saratoga hotel."

PHILADELPHIA TRACTION COMPANIES' PLANS.

ABOUT as revolutionizing changes in street railway matters are going on at present in Philadelphia as in any large city in the Union. Both the People's Traction Company and the Philadelphia Traction Company are prosecuting plans for electric systems on a large scale. The Philadelphia Traction Company will use Westinghouse apparatus throughout and will build a number of power houses to supply its various lines. The Peoples Traction, in contrast to this, will use General Electric equipments and build one large central power station for the whole road. At this station it is intended to use three 2,000-horse-power Allis engines, with armature directly on the shafts, patterned after the big unit which attracted so much attention at the Intramural power house, Jackson park. The greater part of the feed wire will be put underground; the conduits being terra-cotta, set in Portland cement. The ground return will be assisted by insulated feeders run to points along the track. The construction is under the supervision of T. H. McIntire, the chief engineer of the Peoples Traction Company.

THE Evansville, Ind., electric, has an officer by the name of Cash. Must be mighty handy to have him circulating round the office these days.

A MIRACLE was performed at the terminus of the Poddunk & Pigville Horse Railroad, the other day, when the superintendent turned his horse into a barn.

MAC ADAM A SCOTCHMAN.

MAC ADAM, whose name is immortalized in the Mac Adam pavement, was born in Scotland, spending a part of his youth in the United States, and afterwards returning to Scotland. The success of the macadam pavement is due to two principles insisted on by the inventor. The first was that paving should be made as flat as possible, the center being very little above the sides. This was done because the tendency is to drive in the middle of a road on which the crown is high. The other principle was that a road should be made of angular blocks, which would interlock and make a smooth surface, instead of round pebbles, which are constantly in motion.

The total cost of constructing a 16-foot macadam roadway in America is in the neighborhood of \$3,000 per mile.

A LADDER ON WHEELS.

AN English firm must be given credit for putting on the market the ladder here illustrated, which ought to prove a very valuable appliance to the majority of American electric plants. It may be said to occupy a

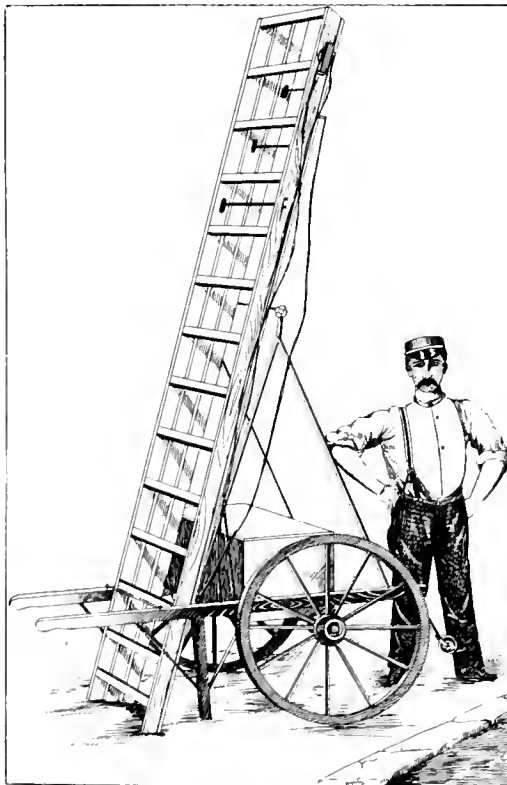

position between the tower wagon and the step ladder. It is simply a ladder on wheels. Its height can be varied from 10½ to 27½ feet, according to the lineman's desire. It can be detached from its carriage, or passed under a 6½ foot door. The cart has a box for tools, and taken altogether, the combination ought to save much labor and profanity.

Much of the work which now requires two men and a horse and wagon, can be done by one man with this as assistant. J. H. Heathman & Company, of 2 Endell street, London, W. C., are the makers.

PLUGGING TIES.

SOME of the French railroads have followed the practice of plugging the old spike holes in ties. We fear that many such holes would be hard to find on American roads, because when a tie is once put in it stays until it rots out. The plugs used in France



are cut from the best part of old ties, to the shape of the spike hole, by a special machine, the invention of Albert Collet. The cost is \$1.80 per thousand. Our cuts, reproduced from the Railroad Gazette, show the difference in the rotting of plugged and non-plugged ties. Plugging lengthens the life of the tie several years.

A NEW KIND OF ACCIDENT INVENTED.

MR. Clark, of St. Paul, has a leg case against the St. Paul City Railway that is, to say the least, worthy of record. Mr. Clark was presented by a gracious and discriminating Providence with a pair of very extensive legs.

Mr. Clark's parents did not apprehend that the infant's legs were long while he slumbered and slept and waxed larger. These legs grew, however, as time passed on, and Mr. Clark found himself many times and oft at a loss just how to dispose of those fine, elegant walkers. This was a particular trial to Mr. Clark in the social world, in proportion to the square of their diameter.

One day while traveling on a common carrier of the grip variety, Mr. Clark experienced one of those uncomfortable sensations of being cramped, so he projected both knees close against the back of an adjacent seat. Suddenly, to save the vertebrae of a reckless small boy, the grip brought to carry with a sudden stop, nearly jerking the heads off of the small necked people in the car, and Mr. Clark avers that then and there, by reason of that jerk, one of his (Clark's) knee caps exploded with a congealed obtuse concussion of the atmosphere, and he wants damages.

SPEAKING in parables, an eastern exchange, says: "All this talk about cities giving away franchises is nonsense," remarked the street railway magnate, with emphasis; "I never ran across a franchise yet that didn't have a fixed value." Then he put on his coat and started out to attend to a little matter of 'fixing' with a couple of Aldermen."

STREET CARS IN SOUTH AFRICA.



ULUS, diamonds and ostrich feathers are generally supposed to be the salient points of interest in the South African country. This is to an extent true, but is rapidly becoming a part of the past. Kimberly, the great mining center of the South African diamond fields, is a progressive town, and is rapidly acquiring metropolitan ways to bless itself withal.

When, in 1869, a South African Boer was given a particularly heavy pebble and claimed it was a diamond, his neighbors laughed him to scorn. Nobody believed it. Nobody thought that he would be able to turn it to any account, until a learned professor in Edinburgh pronounced it pure carbon crystal, and the Kimberly mines soon became famous the world over. In ten years, when that "spouting geyser of English," Anthony Trollop, visited the town of Kimberly, he found a population of 15,000. The buildings were all of corrugated iron, and the heat intense. Anthony avers that the thermometer stood 167° Fahrenheit in the sun, and 97° to 100° in the shade! Water is an expensive luxury when the rains do not come promptly on time, and as 600 miles intervene between the town and the nearest coast, the expenses of living are enormous. Socially, politically and financially the same conditions obtain as at the time of the gold stampede in California, with the exception

ently progressive population to demand a street railway. The undertaking is known as the Victoria Tramway Company, which obtained a concession from the borough council six years ago for a 25-year franchise. The line

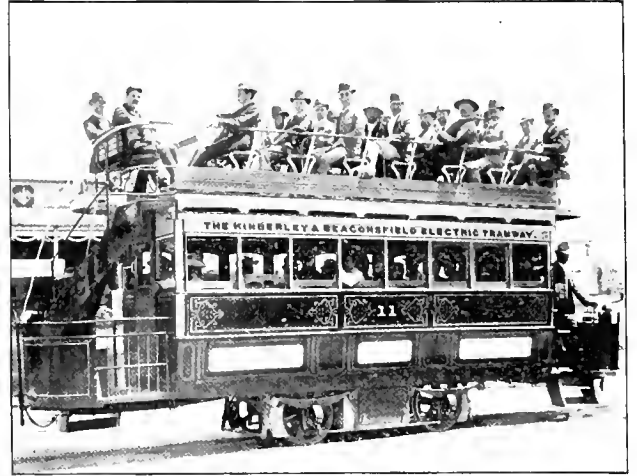

STORAGE CAR AT KIMBERLY, S. A.

is three miles in length, laid with English steel rails. The main line is one and one-half miles in length, and the branch the same.

There are four cars on the main line, variously built, some with roof seats and some without, but all from American shops. Horse power is used, excepting one



STREET SCENES—KIMBERLY, SOUTH AFRICA.

that at Kimberly the Kaffir (native) workmen are to be found to do the hard work of digging, drilling and cradling.

The few acres of diamond field, made into one large hole, 600 feet deep, is a wierd and remarkable place, since from it alone is the town of Kimberly supported. In the diamond digging, 1,300 Europeans, of Dutch, English, Scotch, Irish and American extraction are employed, besides 5,700 native workers. Six and a half tons of diamonds have been taken from the fields here, and scattered over the civilized world, whenever luxury asks for them.

Hence, at Kimberly, in Griqualand West, is a suffi-

car, which is, or rather was, a storage battery attempt, and a thorough failure, from three causes: First, a heavy grade; second, lack of fuel, wood and coal being very expensive; and third, want of a competent electrician. The traffic would not warrant a trolley line.

The employes are both natives, called cape-men, and Europeans who are waiting a chance to find a big diamond and retire. Both classes receive a mere pittance for wages. The fares are 6 pence for the entire distance, or a ticket which costs 2½ pence for half the distance to those only who hold a book of tickets. Cash fares are 6 pence for any distance. A fare box is used. The branch line runs to Gladstone, a mining suburb.

The rolling stock and horses are kept in first-class condition, and the line, considering its antipodal environment, is a credit to the company. Our illustrations show views along the route, and the white glare of the African sunlight.

THE SCRANTON & CARBONDALE ELECTRIC RAILWAY.

THE first run over the tracks of the Scranton & Carbondale Electric Railway Company's line, from Scranton to Archbald, Pa., was made September 29 and signalized the consummation of the completion of five month's work, the linking of the most com-

ville and Archbald, affording direct communication with the city for all these outlying towns.

The Carbondale Traction Company, which runs from Carbondale to Archbald, was organized by A. H. Chadbourne two years ago, and no sooner was this road in operation than he organized a company to procure the franchises for the rest of the towns along the valley. With this in view, the Blakely & Dickson Street Railway Company was organized by local parties in these outlying towns, with William Walker, of Mayfield, as president. As soon as this had been done and the franchises granted to this company, Mr. Chadbourne interested A. N. Chandler, the Philadelphia banker, with associates. These formed the Scranton & Carbondale Company, at a

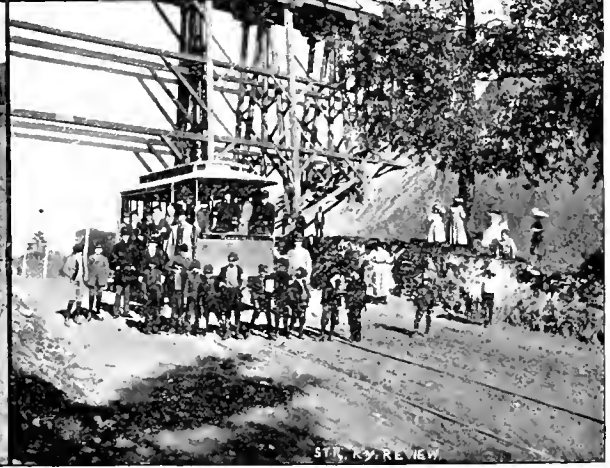
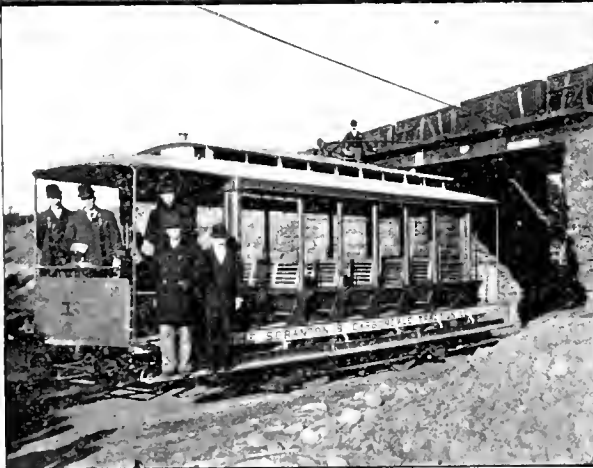

LACKAWANNA COAL BREAKER AT BLAKELY.
CAR PASSING UNDER BRIDGE OF GRAVITY ROAD.

A PASSING POINT.
PASSING UNDER TRESTLE OF CULM DUMP.

plete interurban connections in the state and the joy of the manager.

The Scranton & Carbondale Traction Company is the connecting link between the Carbondale Traction Company on the north, the Scranton Traction Company in the middle and the Wilkesbarre & Wyoming on the south.

By a very favorable operating agreement with the Scranton Traction Company, the cars of this company will run from the center of Scranton, with a population of over a hundred thousand, up through the valley, through Providence, Dickson, Olyphant, Blakely, Peck-

capital stock of \$2,000,000 with the following officers: President, George A. Fletcher, of Mitchell, Fletcher & Company, Philadelphia; treasurer, Alfred N. Chandler; secretary, J. N. Noblit, of Philadelphia. These, with J. N. Noblit, Philadelphia, and S. D. Pettit, of Scranton, are the directors.

The company acquired the Blakely & Dickson road and began construction, putting it in the hands of Mr. Chadbourne, and finished during the past summer in spite of the depression.

The Johnson Company, of Johnstown, Pa., furnished all the material, rails and special work for the roadbed,

and as it is laid along the old Providence and Carbondale turnpike, it gives practically a gravel ballasted road over its entire length. It is laid with fifty-six pound T rails, with six hole angle joints and unusually broad and heavy ties laid two feet between centers.

The cars are sixteen in number and mounted with General Electric's G. E. 800 motors.

The overhead line work and track bonding was done by J. G. White & Company, of New York City, under the superintendence of V. H. Yarnall, and the work is first-class and substantial in every respect.

The Berlin Iron Bridge Company, of East Berlin, Conn., has the contract for the car house, which is being built in Dickson, planned for twenty cars, and entirely fireproof. Until this is completed temporary accommodations will be had in the new car house of the Scranton Traction Company.

In accordance with the operating agreement made with the Scranton Traction Company, they will supply the power for this line from their new 3,000-horse-power station, and, as soon as the line is finished in every detail, will take complete charge of its operating, under the management of H. H. Archer, the general manager of the Scranton Traction Company.

The country through which the road runs is surpassingly rich in coal, and the consequent population is, moreover, thickly settled about each mining center. These miners go hither and thither in search of work or pleasure, and as wages are good, most of them can afford to patronize the road freely. The population of the entire valley is 20,000, scattered among these mining villages, thus giving ideal conditions for interurban electric connections. All the smaller towns depend upon Scranton as a depot of supplies and amusement.

Running through the valley also is the famous gravity road of the Delaware & Hudson Canal Company. This is one of the oldest roads in the country, operating fifty-six miles of road by gravity, sending thousands of tons of coal away from their mines every month. The cars are drawn up the inclined planes by large steam engines, and then run for miles by gravity down the side of the mountains. One of our engravings shows the car coming out from under a low bridge where the gravity road crosses the pike. At this point it was necessary to excavate over three feet below the natural roadbed, and large beds of quicksand were encountered. To overcome this, a solid floor of concrete, one foot in depth, was laid over the entire section. One hundred and fifty cubic yards of concrete were put in here, and half as much broken stone. This effectually stops the flow of quicksand, and assures solid and dry foundations for the track at all seasons of the year.

It is a point worthy of note that railroad properties can be operated in this section of the country very much more cheaply than in points where fuel is more expensive. For example, a road which under normal conditions would use fifteen tons of coal, say in New England, or where coal is five dollars a ton, would have a daily fixed charge of seventy-five dollars for fuel. In this section it

is customary to locate the power house near a culm pile and by the use of blowers they are able to burn this culm, or waste, to such good advantage that twenty tons of it will make as much steam as fifteen tons of ordinary coal. Those twenty tons would not exceed over forty cents per ton in cost, delivered to the boilers, or possibly not more than twenty cents per ton, if it can be delivered without handling. This, then, would make the total cost of

fuel eight dollars per day to operate a road here; whereas, the same road would have to pay seventy-five dollars per day where fuel is more expensive. This would be a net saving of sixty-seven dollars per day, or about \$25,000 per year, in one item.



A. H. CHADBourNE.

The division of the towns is such that there will be three fares charged, namely, five,

ten and fifteen cents, for a single ride; the longest ride being from Archbald, where the fare will be fifteen cents.

Nearly all of the bonds, of which there are \$150,000 issued, have been disposed of, all of them at par, and the stockholders expect to realize a very handsome dividend on the capital stock. There are several extensions expected to be built in the spring in this section.

The initial run was a fete participated in by fifty of the stockholders, city officials, and officers, who expressed themselves as more than pleased by the magnificent prospect of traffic, and the convenience and equipment of the road.

ST. LOUIS QUARTERLY REPORT.

PEOPLE have begun to expect the quarterly report from St. Louis, especially since electricity has become the important factor. The third quarter for 1893 gives the following totals:

	TRIPS.	PASSENGERS.
Baden and St. Louis	5,720	127,940
Cass avenue and Fair grounds	150,890	2,121,410
Citizens'	185,246	2,213,793
Jefferson avenue.....	23,116	505,413
Lindell	323,242	3,845,946
People's.....	58,004	1,260,678
Missouri	297,600	3,712,257
St. Louis	211,400	3,067,721
St. Louis and Suburban.....	33,863	2,057,175
Southern Electric	88,560	1,520,307
Union Depot	158,367	4,612,404
Totals.....	1,536,008	25,045,044

The Union Depot line includes the Mound City and the Bellefontaine railroads.

Looking backward, the third quarter of 1892 showed 1,414,168 trips and 24,692,195 passengers; the fourth quarter of 1892, 1,376,319 trips and 24,339,499 passengers; the first quarter of 1893, 1,469,513 trips and 21,485,054 passengers; the second quarter of 1893, 1,625,799 trips and 26,186,745 people carried.

TRAMWAY EXPENSES IN ENGLAND.

WE publish herewith a table taken from the eleventh half yearly analysis of the principal tramway companies in the United Kingdom. It is interesting for comparison and also as giving a knowledge of what would be the requirements were the road to be changed to electric traction. The price of horses is in the neighborhood of \$150. The analysis was compiled by R. S. Tresilian, assistant secretary of the Dublin United Tramways Company, and is very complete:—

COMPANY.	Capital Stock.	Capital per Mile of Street.	Miles of Street.	Miles Single Lane.	Cars per Mile of Street.	Cars per Mile of Single Lane.	Average Number of Cars Run per Day.	Receipts per Car Mile Run.	Average Receipts per Passenger.	Passengers per Car Mile Run.	Per cent of Receipts Spent on Track Maintenance.	Per cent of Receipts Spent on Interest, Rent, etc.	Provisioner per Horse per Week.	Per cent of Receipts Spent on Traffic, Stables, Law Rates, etc.	Miles Run per Horse per Day.	Miles Run per Car per Day.	Horses per Car per Day.	Horses per Mile of Street.	Horse Renewals per Horse per Day.	Per cent Dividend Paid.
Belfast	\$1,433,700.	\$ 61,665	23. 5	36.5	4.2	2.6	70.	\$.225	\$.022	9.49	7.72	2.10	\$2.59.	69.49	6.60.	77.89	11.80	35.14.	\$.045.	7½
Dublin	3,090,522.	93,705	32. 9	56.9	4.7	2.7	120.	. 958	.032	7.89	4.02	3.74	2.03	66.50	5.68	54.46	9.78	35.90.	.048.	4½
Edinburgh.....	1,635,633	89,968	18. 1	32.5	4.6	2.5	63..	.297	.021	9.53	1.30	8.59	2.82	60.39	1.91.	67.23	13.68	52.69.	.057.	5
Glasgow	1,539,900.	48,891	31. 3	61.8	8.1	4.1	15.26	79.14	104.91.	.091	5
Liverpool.....	2,255,040.	54,331	11. 5	70.2	6.3	3.7	259.	.228	.036	6.16	.03	15.06	2.20	75.66	4.85.	60.32	12.43	77.68.	.047.	5
London	4,179,600.	179,766	23. 2	151.	14.9	7.7	325.	.212	.022	9.51	4.11	6.10	2.07	73.80	7.11.	64.27	9.00	126.23	.058.	7
London Street.....	1,858,950.	137,698	13.50	22.2	10..	6....	110.	.266	.025	10.29	3.55	2.77	2.40	58.14	5.66.	60.41	10.67	86.96.	.048.	4
North Metropolitan	6,657,799.	125,523	51. 6	90.6	7.9	4.5	314..	.267.	.026	10.05	5.28	2.45	2.10	73.59	5.86.	69.96	11.93	72.65.	.071.	8
South London.....	1,784,577.	136,857	12. 9	21.1	6.7	4.1	59..	.222.	.023.	9.66	13.69	7.70	2.33.	66.41	6.32.	62.46	9.87	34.57.	.050.

ROCHESTER'S RAILWAY REPORT.

A STATEMENT of the business of the Rochester, N. Y., Street Railway Company from July 1, 1892 to July 1, 1893, shows a gratifying increase in gross earnings and a correspondingly fair decrease in expenses of operation.

The gross earnings from operation for the past year were \$798,761, an increase of \$115,403 over 1892. The operating expenses were \$430,082, a decrease of \$12,943. Thus the net earnings from operation were \$368,678, an increase of \$102,460 over last year. Advertising privileges paid \$5,087 and rents \$1,490, which with dividends on stocks owned by the company amounting to \$10,487, gives a gross income from all sources of \$385,744, an increase of \$114,324 over 1892. The net income was from all sources \$150,000, an increase of \$68,364. The per cent of operating expenses to earnings was 61 in 1892 and 54 in 1893.

There are now 75 miles of city track, all laid in the past four years. One hundred and fifty motor cars and eighty trailers are now in use, and 450 men are on the pay roll of the company.

CHICAGO is waking up to the advantages of electric lines and will soon come to the front.

THE CABLE THREATENS THE BOWERY.

THE cable car has indeed begun its deadly work in New York. A lament comes up from the New York Journal after this wise: "It is sad to note the decline of the Bowery dime museum. That precious refuge and consolation of the Jersey jay has been done to decay—if rumor may be believed—by the panic. Here and there one survives, and displays the wonted gallery of bearded ladies, female polo players, wild men of Hindostan, learned pigs and ring-tailed apes, but it is the exception which makes the melancholy rule. Verily,

with the advent of the cable car and the explorations of the jay uptown consequent on new facilities for travel, the old picturesqueness of the Bowery is passing away."

If the cable car can transform the Bowery into a respectable neighborhood, Dr. Parkhurst and his men should immediately invest in traction stock, and put in a good big generous extension.

FARES PER CAPITA IN CANADIAN CITIES.

A VERY interesting feature of the published reports of the Canadian street railways is made evident in the following little table, taking the population according to the last census and the patronage for one year, as per the September reports:

	POPULATION.	ST. RY. RECEIPTS.	FARES PER CAPITA.
Toronto,	181,220	\$815,212	\$4.49
Montreal,	216,650	750,754	3.47
Ottawa,	44,154	130,000	2.94

The average was \$3.63 per capita for the three cities. Toronto is the largest city as regards area, hence the apparent discrepancy in fares per head.

This year's receipts for Montreal show \$186,357 in excess of previous years, which were under horse regime.

THE WEST END'S NEW PRESIDENT.

TO fill the executive vacancy occasioned by the resignation of Henry M. Whitney, some months since, the directorate of the West End Railway Company, of Boston, has chosen Hon. Samuel Little. The wise daily papers, in their canvass for a man to fill this important position, did not think of Mr. Little's candidacy, but the wiser directory knew the capabilities and requirements of the man who was to sit in President Whitney's chair.

Mr. Little has had a life long identification with the interests of Boston and its vicinity. He was born at Hingham, August 15, 1827, and received his education at Derby academy. Like many other street railway presidents, his early business career was in the dry goods business. This he left, however, in 1850, when he was made receiving teller of the Bank of Commerce, organized that year. He afterwards became president of the Rockland National Bank.

His activity in street railway lines dates back to 1872, when he organized and became treasurer of the Highland Street Railway Company, and upon its consolidation with the Middlesex, and finally with the West End, remained as a director.

Mr. Little is, besides, prominently interested in half a dozen different commercial enterprises, and has had a most honorable career in politics. He has successively served upon the common council, in the legislature, on the boards of a number of public institutions, and is identified with all public spirited enterprises requiring careful business thought and strict integrity.

In fact, the new president of the West End is all that is called for, a man of honor, acquainted with Boston and its needs, and a thoroughly active business man.

THE ELECTRICAL INSPECTION DEPARTMENT II.

WE described last month the system of car inspection in use on the Chicago City Railway. What will be said this month descriptive of the system used at Aurora, Ill., will probably be of immediate interest to a greater number of readers because it is a smaller road, and hence the conditions correspond more closely with those on the majority of American street railways. In the Aurora plant the positions of chief engineer, master mechanic and barn foreman are combined in one. This is an excellent arrangement for a small road, as it enables the company to employ a man of more ability than would be possible if the departments were under different heads. In other words, it is better in a small plant to have one responsible and skilled man at the head than have several men of ordinary ability, each controlling a department. The chief engineer is held responsible for the performance of the motors, and so has general supervision of all the men employed in the barn. Six men are kept at work on cars, trucks and motors. This does not include the chief

engineer. The night force consists of one inspector, one inspector's helper, and one wiper and cleaner. The day force is made up of one machinist, one electrician and winder, and one general helper. Every motorman before going off duty for the day is required to fill out a card for each car he has handled during the day, giving the line, car number, date, times of going out and coming in, minutes delayed and by what, condition of motor, and condition of brakes. These cards are left in the night inspector's box. The inspector, on arriving at the barn, looks over the motormen's reports and learns if anything noticeably wrong has developed during the day. He then goes to work, and with his helper's assistance inspects every car from the trolley head to the trucks, making light repairs and leaving the more important ones for the day shift. He then makes out a report stating the condition of every part. These reports act as a check on the inspector's work, as he is not liable to put himself on record as saying that a part is all right, unless he has inspected it. The chief engineer makes out a daily report sheet, giving the repairs made on each car, the number of cars in service and the number on each line. It is safe to say that there few roads in the country where the inspection is as systematic and work so carefully checked as here, where it has been proved by actual demonstration that a good inspection system is absolutely necessary to the most economical operation of the road.

GROWTH OF THE TROLLEY IN GERMANY.

GERMANY is leading Europe by several car-lengths as to electric traction. According to the most recent estimates it is averred that she intends to keep up the reputation of the Fatherland, too. This states that the Allgemeine Electricitats Gesellschaft, of Berlin, has acquired the five existing horse lines in the Danzig and will convert them into electric roads under one management. Siemens-Halske are said to be in negotiation with Hildesheim and Schuckert & Co.,—want to put an electric railway into Potsdam. Municipal authorities generally demand underground conduits in the city and allow overhead wires in the suburbs.

A LONDON LAUGH.

CORONER'S juries have been responsible for many English funny stories. Recently, however, a North Metropolitan conductor was summoned for crowding his car. The defendant said that the car was "full" when two policemen boarded it, but thought that the policemen should not be counted.

"Why?" asked the learned council.

"Because they don't pay," replied the conductor.

Whereat the court laughed and remarked: "Seven shillings five."

With the relaxing condition of the money market, plans for new work are fast reviving.

Street Railway Review



HON. SAMUEL LITTLE,

President

West End Street Railroad, Boston.

STREET RAILWAY LAW.

EDITED BY MR. FRANK HUMBOLDT CLARK, ATTORNEY AT LAW, CHICAGO.

Liability of Street Railway Company for Negligence of Lessee.

Where a street railway company, organized under general laws, leases its road to an individual, without legislative authority, it remains liable to a passenger for injuries caused by the negligence of the lessee.

Mayham, P. J.—This action was prosecuted for an injury claimed to have been suffered by the plaintiff by reason of defendant's negligence in the management of its cars. The complaint alleges that the defendant was a domestic corporation, owning and operating a horse railroad for the carriage of passengers and freight between the villages of Johnstown and Gloversville; that the plaintiff, at the time of the alleged injury, was a passenger on the cars of defendant, and had paid the usual charges for transportation; and that by the carelessness and negligence of the defendant, its servants and agents, without any negligence on her part, she was severely injured. The answer alleges that the horse railroad owned by the defendant was, at the time of the commencement of the action, and for more than three years prior thereto had been, operated, managed and controlled solely by Henry Stoller and Michael R. Van Sickler as lessees, and that said lessees were solely and exclusively liable for damages by their own negligence or that of their servants or agents in operating said horse railroad. * * * We think the evidence supported the verdict.

The remaining question is whether the defendant, by its lease to Stoller and Van Sickler, can relieve itself from obligation to the traveling public for injuries inflicted by the negligent management of its road. The case does not disclose that this road was leased with the consent of, or by any authority conferred upon it by the legislature; and the lease was not executed to a railroad company. A railroad cannot lease its road and franchise to an individual, without the consent of the legislature, so as to relieve it from its obligation to the public. And where a lease is effected to an individual, the law seems to treat the lessee as the agent of the railroad company for the purpose of determining controversies between the public and said company. *Abbott vs. Railroad Company*, 80 N. Y., 27; *Fisher vs. Railroad Company*, 34 Hun. 433; *Woodruff vs. Railway Company*, 25 Hun. 246. From the authorities, it would seem to follow that if the plaintiff was injured by the operation of railroad cars, or by the negligence of the person managing the same, although such person was employed by a lessee, such negligence would, in law, be the negligence of the railroad company. The railroad company, a corporation organized under general laws, having leased its road without legislative authority, remained liable for injuries caused by negligence of those operating the road. This doctrine is not in conflict with the doctrine laid down in *Woodruff vs. Railway Company*; in that case the controversy did not arise between the public and the railway

company, but was a dispute between the railway company and the lessee, and the Court held that the parties to the lease were estopped, as against each other, from denying the validity of their contract. In *Beveridge vs. Railroad Company*, 112 N. Y. 1, the question did not arise between the public and the railroad company on a lease between it and an individual, but in that case one railroad company leased to another, as under the statute it might lawfully do.

(Supreme Court of New York. *Durfee vs. Johnstown, Gloversville & Kingsboro Horse Railroad Company*, 24 New York Supplement 1016.)

Master and Servant—Injury to Conductor—Sudden Slipping of Defective Brake—Notice of Defect.

Plaintiff was in the service of defendant as a conductor on its street cable line, and prosecutes this action to recover for an injury which he claims to have received in applying a defective brake on a passenger coach. For the purpose of switching the train, consisting of a motor car and a passenger coach, the coach had been detached from the motor car and was running down a grade towards the end of the track. It became the plaintiff's duty to stop the car, and it was for that purpose that he applied the brake; the usual exertion being ineffectual, he put both hands on the handle, pressing also against the same with his breast, exerting his full strength; the handle suddenly yielded to the pressure, so that he was thrown forward with his breast against the brake handle. * * * The evidence was sufficient to support the conclusion that there was a defect in the brake, of which the defendant had such notice that it should have been remedied before the car was sent out again. Even though the precise nature of the defect was not clearly shown and may be somewhat conjectural, that does not forbid a recovery.

It is to be conceded that the plaintiff knew that there was some defect in the brake, and that it was not in proper condition to be used on the steep hill where the lives of passengers would depend on its efficiency; but that he had any reason to suppose that any risk would be incurred by a person in the act of using the brake, cannot be taken as clearly established. It was for the jury to say whether in view of what knowledge he had, he should have anticipated that harm would result from using the brake.

(Supreme Court of Minnesota. *Newhart vs. St. Paul City Railway Company*, 52 Northwestern Reporter 983.)

Collision with Vehicle at Crossing—Negligent Speed of Car—Contributory Negligence in Failing to Look for Approaching Car.

Where a person driving a wagon, with curtains closed, attempts to cross a street railroad track without looking for a car at a point nearer than seventy-five yards from the crossing, and is struck by a car approaching him

from behind he is guilty of such contributory negligence as will defeat his recovery, in the absence of wanton negligence on the part of the railroad company. The fact that defendant, at a point outside of the city limits, was running its car at the rate of fifteen miles an hour, and did not give the signal of approach, is not such wanton negligence as will entitle plaintiff to recover.

(Supreme Court of Alabama. Highland Avenue & B. R. Company vs. Maddox. 13 Southern Reporter 615.)

Street Railway—Steam Motive Power—Frightening Horse.

The grounds of negligence charged to the transit company by plaintiff were that it operated its street railway by running a steam engine on its track, through streets on which there was constant travel, and that on the day of the accident the transit company, negligently and carelessly and without warning, ran the engine in the immediate vicinity of herself and horse, and so frightened the latter that he became unmanageable and upset the buggy and injured plaintiff. An examination of the charter of the transit company does not disclose any authority for propelling its street cars by steam, and it is doubtful whether any such authority was conferred by that instrument; and, if it was, the company's franchise would not excuse it from liability for injuries caused by its negligence, whether such negligence consisted in the mismanagement of its road and cars, or in the character of motive power employed.

When one is placed, by the negligence of another, in a situation of peril, his attempt to escape danger, even by an act which is also dangerous, and from which injury results, is not contributory negligence such as will prevent him from recovering for any injury, if the attempt was one such as a person acting with ordinary prudence might make under the circumstances.

(Supreme Court of Nebraska. Lincoln Rapid Transit Company vs. Nichols. 55 Northwestern Reporter 872.)

Elevated Railroad—Action Against, for Injunction—Waiver of Right of Eminent Domain.

Action was brought by plaintiff to enjoin the operation of defendant's road in the street on which plaintiff's lot abuts, whereby plaintiff was deprived of his easements in such street. In this action defendant answered, noticed the case for trial, and appeared on the call of the calendar. Defendant afterward instituted a proceeding to condemn plaintiff's easements, and plaintiff moves for an injunction against the condemnation proceeding on the ground that defendant had waived its right to maintain such proceeding. The scope of this action does not impose upon the Court the duty to the plaintiff of fixing a sum as compensation, which the defendant may pay and avoid the operation of an injunction. The condemnation proceeding is not an act by defendant in violation of plaintiff's rights. The motion is denied.

(Superior Court of New York City. Mead vs. New York Elevated R. Co. 24 New York Supplement 908.)

Electric Railroad—Motorman Killed by "Bucking" of Car.

Deceased was employed by defendant as a motoneer on one of its electric cars, and the accident was occasioned by the "bucking" of the car, (suddenly coming to a halt and as suddenly starting up), which threw him over the dashboard, and the car quickly ran over and killed him. On the merits we are satisfied that the evidence abundantly justified the jury in finding that defendant corporation was guilty of negligence in causing this car to be used. It had frequently bucked before, a fact well known to those to whom it had intrusted its primary duty of seeing to the condition of its cars. There was also ample evidence to warrant the jury in finding that this bucking was caused by the old and worn out condition of one of the electrical fields, and that no proper tests had been applied to ascertain the condition of these fields, and no proper care had been exercised in renewing and replacing such as had been worn out. The defendant was also bound to know that with a low dasher in front, the almost inevitable result of bucking would be to suddenly hurl the motoneer upon the ground in front of the car, and thus to greatly imperil his life.

(Supreme Court of Minnesota. Beardsley vs. Minneapolis Street R. Co. 56 Northwestern Reporter 176.)

Passenger Standing Against Car Door—Injury by Falling from Car.

A street railway passenger who, upon entering a "transfer" car used for a waiting room for passengers who are to be transferred from one line to another, carelessly takes a position close to or against a plainly discernible door, which is liable to be opened at any time, is guilty of contributory negligence and cannot recover for injuries sustained by falling out of the car because the door is suddenly opened, although the employe who opens it is also negligent in not observing her position and warning her of it and waiting for her to move.

However, the company is liable for such injury if the passenger would not have been in that position had not the employe in charge of the car directed her to move from a safe place where she stood without warning her of the danger, and such danger was not apparent or known to her.

(Supreme Court of Indiana. Prothero vs. Citizens' Street Railway Company. 33 Northeastern Reporter 765.)

NEXT May the tramways of Glasgow come into the hands of the municipality. The authorities are making preparations to start the new era with largely increased facilities for travel. Tenders have been invited for the laying down of new lines in several parts of the city, including one from Gorbals' Cross to St. Enoch-square.

THE largest man in the employ of the Cincinnati Street Railway is Joe Hamilton. Joe is 6 feet 3, and has been a motorman several years. He is a little round shouldered from dodging the car roof, but aspires to be a policeman at some not very late date.

RAIL JOINTS.

BY JOSEPH ANTHONY.

THE sleepers under the rails of a street railroad, in contradistinction from the like in distinctive steam motor roads, do not, as far as I am aware, pump the ballast from under their ends by bending under their loads and straightening again when the loads have passed off. A device that would be remedial under locomotives and their trains, seems therefore not to be called for in the lighter loaded and paved roads of a city's streets. There is, however, the joint feature of street railways, and especially noticeable in cable roads, that needs to be, and

again. From the permissible wide spacing of the sleepers under street car tracks, a joint made by using a piece of old rail of like or larger cross sectional area, as shown in principle, by the engraving, will be effectual in maintaining a like plane at all points of the wheels' path. The fastenings in the engraving shown, were made for especial experimental purposes, and may be much simplified for actual use.

That an idea of the path, in street as well as steam roads, of a car wheel passing over a low joint, and some comprehension of the resulting loss may be reached without waiting to audit bills for new rails and other needlessly worn plant, I refer the reader to the diagram showing the average condition of eight consecutive joints

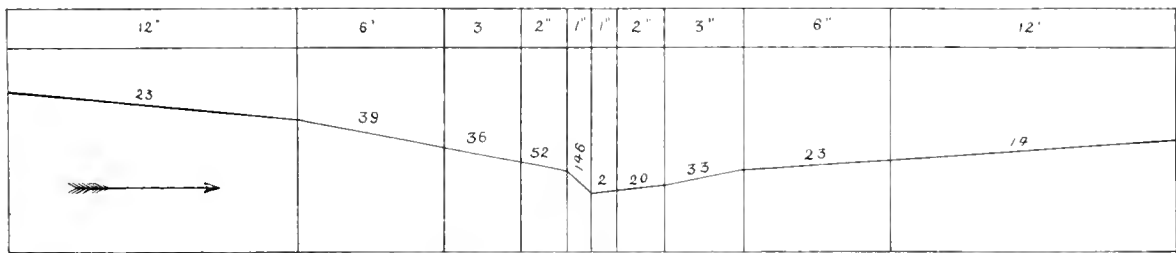

AVERAGE OF EIGHT CONSECUTIVE JOINTS ON A LEADING STEAM ROAD.

may be much improved. While I have made no instrumental measurement of these joints, a personal inspection, particularly the State street line, shows them defective in the same manner and to an equal extent as are the joints in the average double track steam road. It is this way: Along the middle of a rail, by its stiffness, there is furnished for the wheel path, a comparatively perfect plane. At the joining ends of the two rails there is no stiffness, but an attempt is made to provide for this lack

in the track of one of the leading double track roads entering Chicago from the west.

In explanation, I will say that the length of track here shown, is 4 feet, being 2 each way from the rail's ends. The arrow indicates the direction of the passing trains. The figures at the vertical spaces represent inches in each rail's length. The inclined lines below, exaggerated to make a graphic showing, show the wheels' path. The figures just above these lines and in the several vertical spaces, are, however, not exaggerated, and show the actual grades in feet per mile of such portions of the wheels' path as the rails along them, in a state of rest, furnish for every passing load. Much greater depressions, of course, would be shown, could the measurements have been taken while under passing trains. Comment on such unmechanical construction and consequent ill results is unnecessary.

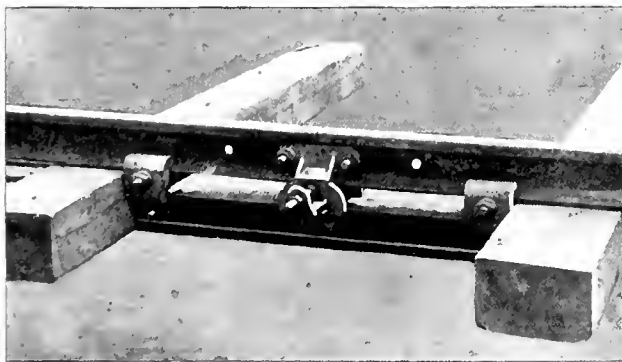

JOINT SUGGESTED BY MR. ANTHONY.

by bolting "fish plates," filling the vertical spaces between the rail's head and its foot, and embracing a portion of each rail's end. While a pair of these fishes may be stiff enough not to bend, and thus to let the joint down, by the narrowness of contact area under the head of the rail and the compression and wear of that limited area, and in the fish itself as well, a marked and injurious depression soon becomes, not only possible, but probable and permanent. It becomes permanent because where the fish should be highest on its top edge, it has become lowest, and no tightening of its bolts can make it good

By making the joints of the rails, in cable roads, come midway between the yokes, there is abundant room for a long splice under the joint; and when such is secured by strong clamps, with wide areas of contact, and the rails shall have been cut with mitered ends, the mechanically disgraceful and financially ruinous cable rail joints will be things of the past. Neither the joint nor any of its parts, which the engraving shows, is patented, and it is therefore free to all who may choose to use it.

FARMERS living at a distance from steam roads in Western Pennsylvania are beginning to regret that they did not make a fight for the bill allowing electric railways to carry freight. They find it hard work to make both ends meet, having to haul their produce over ten or more miles of bad country road. An electric railroad from Pittsburg to Steubenville is wanted.

BAGGAGE CAR ON THE CHATTANOOGA ELECTRIC RAILWAY.

THE Chattanooga Electric Railway operates a line running between the Central Depot of that place and the hotel on Lookout mountain,—one of the famous pleasure resorts of the country. As the tourist traffic is large, it became expedient to have means for carrying baggage. Accordingly, Superintendent C. P. Young made over an old open Stephenson car into a very economical baggage car. The door sills on each side are covered with one-fourth inch steel, curved over

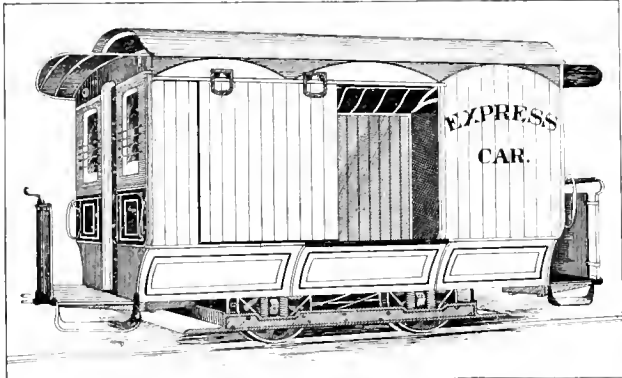

"THE CAR IS NINETEEN FEET OVER ALL."

the beam. From the sills the trunks slide down 45° inclined planes of steel plate. The floor is covered with one-eighth inch iron, so that altogether the baggage smasher has plenty of opportunity to ply his trade without hurting the car. A desk is placed at one end for books, receipts, etc., and provided with lock and key. One end door can only be opened from the inside. The other end door opens by key from the outside. The sliding doors at the sides are fastened on the inside. The car is nineteen feet over all, with 3-foot platforms. Wheels are 30-inch and the trucks made in the company's shops. Brakes and drawbars are strong. It will be run as a trailer to a motor car, running once an hour.

BROOKLYN CITY RAILWAY REPORT.

THE report of the Brooklyn City Railroad Company to the State Railroad Commission has finally been published. The report is for the year ending June 30, and the comparisons for 1892 are thus hardly a just showing. Particular attention should be accorded the last two items with reference to the number of people carried.

	1893.	1892
Gross earnings.....	\$3,760,744	\$3,787,295
Operating expenses	2,741,865	2,915,509
Other income	75,464	50,724
Fixed charges.....	303,614	398,534
Net income.....	720,723	523,975
Dividends declared.....	660,000	480,000
Surplus for year.....	60,728	43,075
Total surplus June 30.....	719,913	160,235
Betterments.....	3,756,996	1,080,927
Passengers carried	\$3,196,302	78,500,000
Passengers injured.....	41	21
Passengers killed	8	7

The headlines of the Brooklyn papers would lead one to imagine a falling off in the population of the city of churches, but the proportion seems to remain the same, one to every ten millions of passengers carried.

FINANCIAL papers generally discountenance the raising of fares by the London 'buss companies, saying that 8 per cent ought to be a satisfactory dividend, and aver that over reaching will be followed by a loss of patronage and more competition.

ANOTHER VESTIBULE PLAN.

IN addition to the plans for enclosing platforms, given in the October REVIEW, in the article "Vestibule Platform Law in Ohio," another plan has come to our notice, in the form of an invention of G. S. Powell, W. B. Williamson and R. A. Havner, of Asheville, N. C. It is somewhat similar in form to the plan of the LaCledde Car Company. The accompanying cuts need but very little explanation. The dash is extended

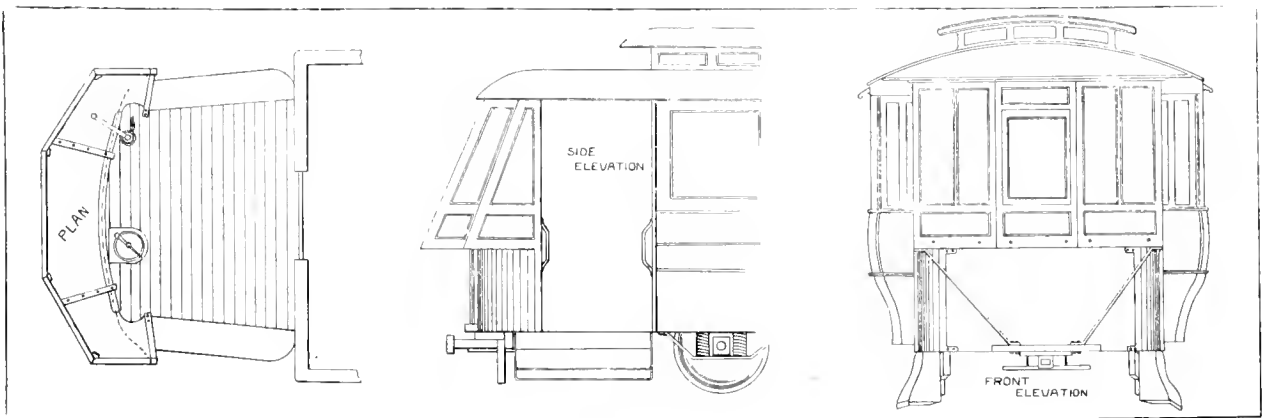

ANOTHER VESTIBULE PLAN.

NEW ZEALAND electric railways don't have half a chance. The projected line at Dunedin City is to be abandoned, if the city insist on the payment of \$40,000 to indemnify the telephone service.

at each side as indicated by the dotted line in the plan view. The center sash is removable, the others fixed and the whole outfit can be removed without disfiguring the car.

THE MT. AUBURN TROLLEY WHEEL.

THE want of repair parts has caused to spring up a number of equipment companies, the object of which is to afford repairs, parts, and equipments for the various systems of traction in use by the numerous roads in their territory.

Among the best, the Electric Railway Equipment Company, at 81 and 83 East Front street, Cincinnati, is becoming widely known to the railways of the central states and the east central roads, as well as to the lines in the great west. This company is engaged in the manufacture of steel and iron tubular poles, line material, motor parts for all systems, gears, pinions and bearings, trolleys, commutators and armatures. Their latest specialty is the Mt. Auburn trolley wheel, to which we devote the accompanying engraving and the following brief description.

By reference to the engraving, the reader will note the cut, as numbered to parts: Number 1 is a hardened steel axle, 2 the bronze wheel, 3 the bronze harp, 4 the harp covers, with oil chamber, 5 the hardened steel plate, 6 hardened steel rollers, 7 hard steel ring, 8 ring with eye for rope attachment, 9 guard to prevent span wire from

steel axle being attached to the wheel revolves in a roller, bearing on each side. The rollers are of the best tool steel, and run in oil, contained in cover, number 4. The claim for long life of this wheel is thus dependent on the fact of no contact springs, and upon the use of roller



MT. AUBURN TROLLEY WHEEL.

bearings—these two advantages preventing the sliding of the wheel on the wire.

The new wheel is meeting with excellent results from its introduction, promising a wide use.

BALTIMORE'S CITY AND SUBURBAN EARNINGS.

THE Baltimore, Md., City & Suburban Railway reports of the net earnings for the last six months, show an encouraging increase over last year. The report is from April to September, inclusive. April showed \$12,940, increase \$2,285; May, \$14,718, decrease \$1,846; June, \$15,882, increase \$3,327; July, \$15,164, increase \$3,431; August, \$14,234, increase \$1,845; September, \$16,732, increase \$4,884. Total for the six months, \$89,770, against \$75,844 last year.

Playing Cards.

You can obtain a pack of best quality playing cards by sending fifteen cents in postage to P. S. Eustis, Gen'l Pass. Agent, C. B. & Q. R. R., Chicago, Ill.

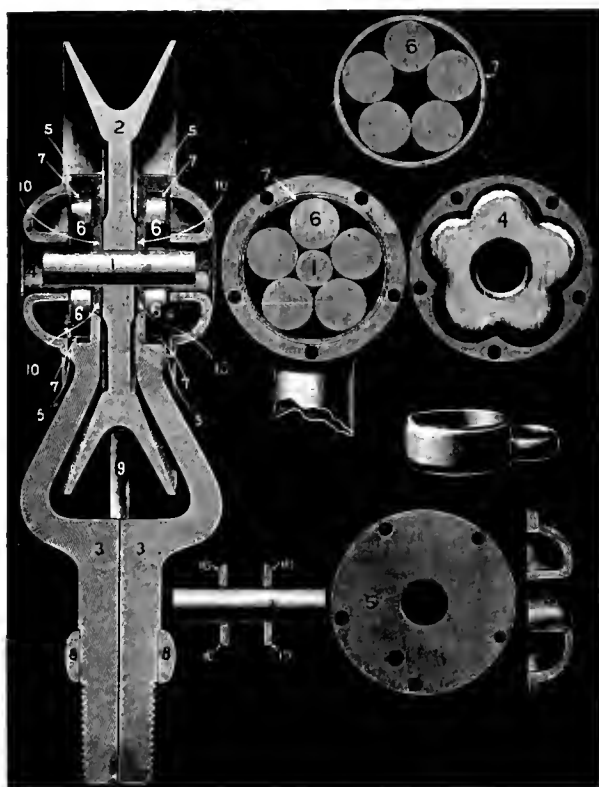

PARTS FORMING THE MT. AUBURN TROLLEY.

being caught by the wheel, 10 hard steel washer for inside roller bearing. It will be noticed that all wearing parts are made of hard steel, while the wheel and harp are made of bronze. The harp can be made to fit any pole. The principal claims of the Mt. Auburn wheel, for excellence, are these: It requires no contact springs as it has a contact through its rollers. The hardened

MAGNETIC PULLEYS.

BY W. E. HARRINGTON.

POWER transmission is a subject of great interest to every engineer. When we look over the various devices now in almost universal use to transmit power, we do not see any real advance in the number or character of the devices themselves, since the mechanic arts first began to assume their present proportions. When we state that every known form of power transmission can be reduced to three fundamental forms, it surprises us, yet pulleys, gearing, and connecting rods cover the entire field, and it has been from this limited field that the engineer has been compelled to draw from to design his machinery. We can briefly examine into the above general forms, and describe wherein they lack certain mechanical features which are essential, which have been urgently desired, and which are fulfilled in the form of device which is the title of this article.

Smooth face pulleys and belting transmit by virtue of the mechanical friction existing between the belt and the face of the pulley, therefore two conditions are demanded for their successful operation, to-wit: tension of belt, and an exceedingly flexible belting—practice dictates substances which are relatively perishable, such as leather and rubber.

Gearing is the generic term for a multitude of forms—spurs and pinions, bevel and mitre, racks and worms, sun and planet, sprocket, and conveyors. One might almost say “ad infinitum.”

In all gear forms, one feature distinguishes them, and that is the use of engaging teeth in one form or another. Gear transmission means: Absoluteness, no yield, no resiliency, motion versus destruction; the train of mechanism must go, break or stop. A form of transmission exceedingly valuable for many classes of machinery.

Connecting rods, links, eccentrics and rods are the means, usually, of converting from reciprocating to rotary motion, and with that their whole story is told. We might state that synonymous with the word connecting rod, is dead center and variable moment.

We can deduce from the survey of the above forms that if a form of transmission were available embodying the following points, it would be of value for certain classes of machinery:

- 1st. Smooth face pulleys, with belting held thereto by other means not dependent upon mechanical friction.
- 2nd. Belting of iron, made up in some link flexible form, to stand hard usage, dirt and moisture.
- 3rd. Tension of belting not an essential condition.
- 4th. Amount of adherence or traction of belting to

face of pulley, if so desired, a matter of automatic or hand control.

5th. Lubrication of face of pulley and belting, if so desired, and if the conditions of the work require slip-page.

6th. Simplicity, inexpensiveness, and requiring but a slight outlay of energy to obtain the above results.

All the points as described above are some of the features in the magnetic pulley method of transmission. An illustration of an application of this device is in electric street railway work. It has been the subject of careful thought and investigation on the part of railway men for years, to devise some method whereby one motor could be utilized to drive a car and still have the two axles driven simultaneously. The object being, as is of course understood, to obtain the traction of what would otherwise be dead wheels. An illustration of the necessity of connecting axles to one source of power for traction purposes is represented in locomotive practice, where the several axles are connected by means of connecting rods. The most persistent experimentation has not resulted in the development of any successfully commercial form. While it is known that connecting rods have been tried for electric street railway work, still the great expense, dead centers and crank pin bearings, were too serious obstacles in the way of its successful realization.

Bevel gearing has been the Mecca of many, but its absoluteness, expense, and excessive wear, has condemned in its turn every system developed.

Sprocket chain and gearing are the devices which are now exciting probably as much attention as any form. The General Electric Company is working carefully, trying to improve upon and devise some method whereby this system may be employed. The absoluteness of the transmission is the factor which, for street railway work, will forever bar it out as a commercially successful form. Anyone who is conversant with street car practice knows that with a pair of axles and their wheels, that absolute duplication and uniformity is not attainable, and with the curves and other inequalities present in the running of cars, there must be a freedom on the part of the transmitting device at times to slip, otherwise unusual stresses are thrown upon the device, resulting usually in the breaking of parts, the whole source of trouble in all these systems. Not only in sprocket gearing, but in bevel gearing, this factor of slip is not allowed for, and if the transmitting medium is not unusually strong, trouble will and does inevitably result.

The magnetic pulley method of transmission is peculiarly applicable to electric railway work, as it can be energized from the motor circuit direct. Since the amount of energy required is practically negligible, it can be introduced in series with the motor circuit upon the “ground” side. Owing to the property of a series motor taking current in proportion to the work done, the magnetic pulleys will develop traction in the same proportion. The cost of equipment required to go on a car is only about 18 per cent of the cost of the additional motor equipment which otherwise would be required.

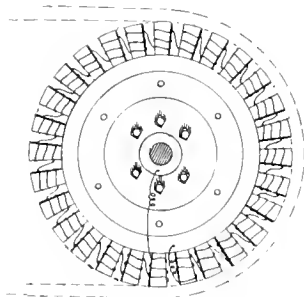

THE MAGNETIC PULLEY.

The belt, owing to its running on the smooth face of its pulley, can slip before it reaches a dangerous point, and can thus compensate for the occasional differences in the number of revolutions each axle makes. The method of electrical connection is quite simple. Only one rubbing contact is employed, and is located upon the dead axle. The current is led to it, thence to magnetizing coils, to rim of pulley, to metallic belt, across belt to rim of other pulley, through magnetizing coils to "ground."

The rims of both pulleys are insulated with mica, from the hub. The pulleys are flanged, 18 inches in diameter, 4 inches in width. The belting is flexible iron, which runs quietly and with but little wear, this wear being only at the joints, whereas, in sprocket gearing the wear in the belting is in the recess of the link, where the link bears in contact with the teeth of the gear. Tests demonstrated that the circumferential torque or magnetic adherence of the iron belting to the face of the pulley was one pound per square inch of contact, iron to iron, per ampere, which, with fifty amperes, the initial starting current of motor meant a pull of 2,000 pounds, giving an available horizontal effort at the periphery of a 33-inch car wheel of 1,033 pounds. The maximum voltage across terminals of the magnetic pulley circuit at no time exceeded ten volts, and gradually dropped off less and less, as the current dropped off with increase of speed of car.

Average voltage was five volts. In the tests as conducted in Camden, N. J., on the lines of the Camden Horse Rail Road Company, every precaution was adopted to make conditions even more severe than would occur in practice. A test made recently was very severe.

A motor car with its brakes set was attached to the magnetic pulley motor car. The rails immediately under the motor wheels of the magnetic pulley motor car were thoroughly greased, also the motor wheels. Upon applying the current, with the magnetic pulleys out of circuit, the cars stood still, while the motor wheels simply skidded on the greasy rail. Motor was then stopped, and the magnetic pulleys were thrown into circuit. Again the current was applied, and the cars moved off, although not before the controlling switch was thrown on the fourth notch of the No. 3 Westinghouse motor equipment.

It might be interesting before closing to refer to the results of a series of very elaborate tests carried on, on the lines of the Minneapolis Street Railway Company, by Professor G. D. Shepardson, as recorded in the transactions of the American Institute of Electrical Engineers, in the July and August, 1892, number. An average of twelve tests on the road showed that with two motors on a car, it required twenty-seven per cent less current if only one was working.

A YOUNG woman named Spence has been writing to the English journals decrying the awful effects of private monopolies in the United States. The English papers regard her as a true prophet and worthy of all acceptance, because, forsooth, she says what she is hired to say.

THE HEALY STEAM MOTORS.

THE Healy steam motors are too well known to need much description to street railway men. Their performance on street railway lines has been very satisfactory. A new application of the smokeless motor has recently been made, viz., that of propelling a small yacht. As steam yachts may prove a valuable adjunct to many street railway pleasure resorts, we here publish an engraving of the yacht "Ellen M." built

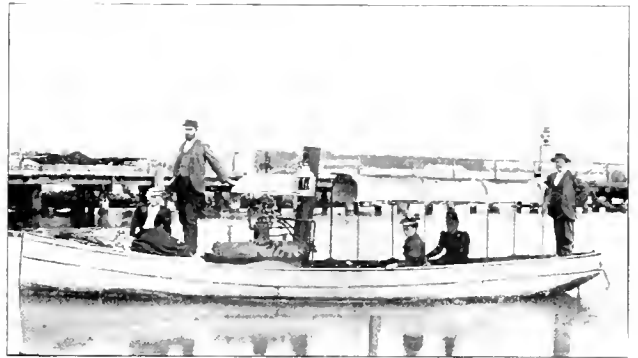

THE HEALY YACHT ENGINE.

by Mr. Healy recently. She is 25 feet long, with 2-foot draft and 5-foot beam. The boiler is 19 inches in diameter and 40 inches long, having 76 square feet of fire surface. The Healy double engine, with which it is fitted, is very durable and reliable, weighing 125 pounds. Its rating is 15-horse-power. The yacht is claimed to be the fastest boat for its size on the Detroit river.

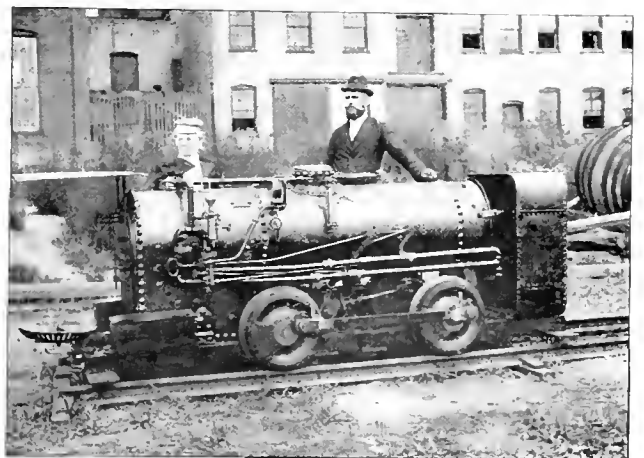

THE HEALY MINE LOCOMOTIVE.

The mine locomotive also illustrated here is noted as a puller. Its weight is 7,000 pounds, length 11 feet, gauge 2 feet 10 inches.

As is well known the Healy motors are nearly noiseless and smokeless, the construction of the fire box consuming the smoke. It is these qualities, together with the lightness of these motors, that make them so popular.

EXCURSION cars are late departures on the London, Canada, Street Railway.

WILL DO HIS OWN REVIEWING.

IT is not often a REVIEW reader goes wrong, and it is our firm belief that had he subscribed a little earlier in the game he would have been all right yet. The following letter is self-explanatory:—

“Editor,—Dear sir: Hereafter pleas sent your REVIEW to me as Mr. ——— is not in it any more as He is in st. Prison for the next four years to come. if you Have a nothur copeny of your october Number i would like to have you to sent it to me and oblige.”

THE STANDARD DIVIDER.

A NOVEL drawing instrument, which will be found useful in many of the draftsman's daily operations, is illustrated in the accompanying engravings. It can be used for dividing a line into any number of equal parts, (the length of each part being read from the vernier), marking off a number of equal spaces of a

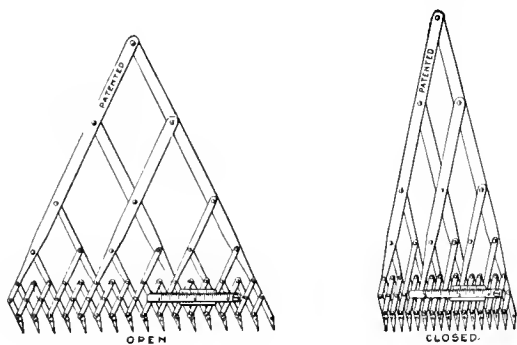

given size, using as a scale, and in many instances in place of proportional dividers. It is made of steel, nicked plated. Careful workmanship makes it accurate for all positions. The draftsman will recognize it as a labor and error saving device and it is endorsed by several eminent professors of civil engineering. It is handled by the Standard Divider Company, of 359 Dearborn street, Chicago, and by leading instrument dealers.

THE QUICK AND THE DEAD.

THE rapidity with which needed improvements are installed in American cities, especially in the line of city transportation, affords as strong a contrast as any, of the difference between the enterprise of the new world and the red-tape process of the old. Hon. Lorin A. Lathrop, a San Franciscan, who in 1880, at the age of but twenty-two years, was appointed consular representative to Bristol, England, and which office he still holds, is now making his first visit to San Francisco since he left, thirteen years ago. The progress made during those years is naturally marked. He says: “The most striking and interesting thing to me is the marvelous enterprise and energy exhibited in the growth of your transportation system. San Francisco's street railway system is a marvel. There is nothing like it in the world. In no other city can you go so far and so fast for so little money.

“London has two cable lines. One is the Highgate hill, near the home of the Baroness Burdett-Countts; the other runs two or three miles on the Surrey side of London. Only one is running now.

“Several months ago a gripman lost control of his car on Highgate hill. It dashed to the bottom. Nobody was hurt. The papers set up a clamor, though, because somebody might have been injured. The result was that the Board of Trade, which is there a government department, ordered the company to cease running its cars till certain changes were made in the system.

“The changes would have required an enormous outlay of capital, and the cars are not running yet. The cable cars of this city would fill the conventional Briton with horror. They would demand that the cars should be run so that the oldest woman could get out of the way, not with such speed as to tax the spryness of the most agile young man.”

RAILWAY EQUIPMENT RAIL BOND.

A VERY simple solution of the question of making a good electrical and moisture proof contact between bond and rail is offered by the new spring bushing, brought out by the Railway Equipment Company, of Chicago. Everyone who has has experience with rail bonding knows that channel pins cannot give good contact, their only strong point being that they are cheap and quickly applied. This bushing is as easily applied as the channel pin, while making a practically perfect contact. A perfect bond connection is one of the crying needs of the times, as has been frequently pointed out in the REVIEW, and we are glad to welcome this device to the list of standard appliances for electric railways. It has already been adopted by several large roads. The bushing is a slightly tapered ring, with a $\frac{3}{16}$ -inch split down one side. It is slipped over the end of the bond and driven in a manner similar to a channel pin. In driving, the slit springs shut and there is a continuous contact the entire circumference of the bond.

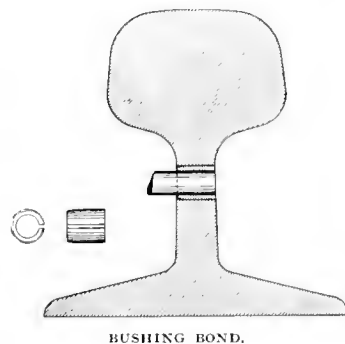

Map of the United States.

A large handsome map of the United States, mounted and suitable for office or home use, is issued by the Burlington Route. Copies will be mailed to any address on receipt of fifteen cents in postage, by P. S. Eustis, Gen'l Pass. Agent, C. B. & Q. R. R., Chicago, Ill.

JOHN W. TAYLOR, of Essex county, N. J., an ex-state senator and corporation counsel for the South Orange Street Railway, committed suicide.

A NOBLE WORK AMONG STREET RAILWAY EMPLOYEES IN ST. LOUIS.

MENTION was made in the REVIEW some months ago, of the establishing of a free reading room for the employes of one of the great street car lines in St. Louis. The undertaking, which has proved a great success, is maintained under the auspices of the Church of the Holy Communion, the rector of which, the Rev. P. G. Robert, has given it his personal time and attention, not only since its opening, but in its inception, and has been very successful in enlisting interest and aid in the work. In response to our request he has kindly given a brief account of its history, though modesty has prevented him from a proper mention of his own untiring efforts in its behalf. Dr. Robert writes:—

“My son has handed me your letter, and I gladly respond to your request to give some account of the Holy Communion Church House and Free Reading Room.”

“An earnest churchwoman, a communicant of my parish, who was then living near the Olive street power house, was one day applied to on behalf of a sick and suffering woman, wife of one of the street railway employes, to visit her and see if her distress could be relieved. To make such a request of this lady was to have it at once granted; and to her surprise she found the power house—which was then occupied in the upper story by the men and their families—and that whole neighborhood, seething with a population for which no religious privileges were provided. Nor did the residents have any desire to seek them, living as they did in a little world of their own, and believing that ‘no man cared for their souls.’

“While the majority of the residents of this locality were railway men and their families, there were others who had moved there for traffic of a questionable character. This lady came to her rector and reported her discovery. We made the rounds of the neighborhood together, and finally rented a room in a back alley in which to hold religious services. Not many of the men could be present, though a relatively late hour was chosen for their convenience; but the runs kept them so closely occupied, that when the day’s work was done they had but little desire to attend religious or any other sort of services, but only to rest. But their wives and children came, the women bringing their little babies with them, of course, or they could not have been present. To relieve them of their embarrassment, when the babies began to be restless, I made them put the children on the floor, and they crawled all around while I was preaching, two or three of them sometimes clinging to each foot. This was our beginning. We moved three times to larger rooms before taking the house now occupied. Railway men rent the rooms on the upper floors, but those on the first floor were opened for a chapel, and a meeting place for the men. If they could not come to service at night, we arranged for them to have a place when they were waiting for their cars to which they

could resort; and so we ran opposition to the saloons and poker shops, and we found our friends glad indeed of a respectable place in which they could be at home.

“Then the lady of whom I have before written, who is still at the head of the Church House, suggested the idea of a free reading room, and the daily papers were given us, and a library of choice books purchased on monthly payments, and this not only attracted the men in greater numbers, but gave them the opportunity of increasing their stock of useful knowledge. They also asked, and readily received, permission to hold the meetings of their social club in the chapel, and we often have entertainments, which not only give the neighbors a pleasant evening together, but refreshments are served at reasonable rates, which help to defray the expenses of the establishment.

“I give them religious service every Wednesday evening, and on the other evenings during the winter, and on Sunday afternoon; there are bible classes, instruction in stenography for young girls, a school for young men and women, taught by a public school teacher, who gives her service gladly to the work. Of course the poor attached to the House are relieved, and a history of the lives of many that have come under our influence, and the change that has come over them, would make a volume of thrilling interest.

“In this time of financial distress we find ourselves dragging bottom right often; and we pray constantly for the restoration of that ‘confidence’ which congress tells is wanting, and for more money.”

P. G. ROBERT.

“St. Louis, October, 1893.”

IT WASN'T DYNAMITE.

FOR several weeks the employes of the Topeka, Kas., Electric Railway have looked with suspicion upon a certain curious box that has been attached to one of the piers of the company’s bridge by a small rope. It was a strong and carefully made box, about 30 inches square, and finally was brought to the notice of the superintendent, who made inquiries. No one knew about it. Some thought it might be dynamite. Others surmised it was the attempt of some murderer to cover up his misdeeds. A few thought of buried treasures. Everybody was afraid of it. Finally, it was taken out of the river with extreme care and landed where it would not kill any one, and opened. Inside, some dirty water and a little catfish met the expectant gaze of the bold men. The catfish was nearly white from deprivation of light. Now everybody wants to know why anybody should bury a box of dirty water and a little catfish.

TO RENEW tarnished brass buttons, clean with a strong caustic soda water to remove all traces of lacquer and dirt. Wash in hot water and dip in strong nitric acid for from three to six seconds, and dip immediately in boiling water. Dry and lacquer while hot with thin shellac varnish.

HALF FARES.

Interesting Facts from All Parts of the Country Boiled Down
for Busy Readers.

W. MUSHRUSH, a lineman at Cleveland, O., recently received the full benefit of the 500-volt circuit but went to work the same day.

MARTIN CATT had his pocket picked on a Chicago street car. If it had been his brother Tom we imagine he would have howled and made the fur fly.

THE gondola came to the World's Fair to compete with the electric launch, and now the electric launch is going to Venice to compete with the gondola.

THE medal won by the Chicago City Railway, for World's Fair transportation, is in the form of an extra dividend of 10 per cent, which will be paid November 30.

THE Minneapolis-St. Paul strike was of short duration—a faint hearted effort. The great majority of the men, especially in the first named city, stood by the company all through.

OF 664,000,000 railway passengers carried by British railroads in 1892, 129 were killed and 2,000 injured. Railroad servants were killed to the number of 500, and 3,000 were injured.

THE prize for a design of a Sheridan monument, to be presented to Chicago and placed in some West Side park, by Chas. T. Yerkes, has been awarded to George Wagner, of Chicago.

NEWARK'S discarded street car horses, recently sold at auction, brought from \$3 to \$22, for the better ones, while a number of seconds went at \$1. Doesn't somebody want to start a horse railroad?

A CUT of 10 per cent in wages was made by the Des Moines Street Railway Company. The company will restore the rate April 1. The employes, seeing the necessity of the matter, have accepted the reduction.

THE old yacht Pilgrim has been bought by the Quincy Street Railway Company, of Boston, and it is understood that it will be used as a ferryboat. James McIntyre, of South Boston, will make the necessary changes on it.

TWENTY-ONE rapid transit lines are now in operation in Baltimore, the first one started being the North Avenue Electric Railway on August 16, 1890, and the last the Huntington Avenue Electric, on October 3, 1893.

GRANT PROUDFOOT, superintendent of the Des Moines Street Railway, is a staunch democrat, and bet several bets on Horace Boies' re-election. Consequently Mr. Proudfoot spent several hours the day following election in carrying a banner inscribed with republican emblems and yelling for the republican ticket.

COMMISSIONER RICKARD, of the New York railroad commission, says that body will collect evidence and statistics for data from which to deduce a number of rules governing the speed of electric cars in New York state.

A CABLE weighing 40 tons was recently made and shipped by the California Wire Works, San Francisco, to the St. Louis cable railway. Forty horses, in teams of two abreast, were required to draw the load to the depot.

THE communication between Superior and Duluth, this winter, will probably be facilitated by a pontoon bridge. The proposition will be submitted before the ice forms. The street railway tracks may thus be run across with ease and safety.

CRABS tied up the Hudson County Electric Railway recently. The engines of the power plant are fed from the Broux river and a million or so adventurous crabs explored the engine piping to such an extent that an hour's shut down resulted.

THE Citizens' Street Railway Company, of Kalamazoo, Mich., has contracted for twenty-five keel boats and two steam launches. These will be placed at Lake View Park and used to induce traffic. The company will sell privileges at the docks.

THE Sandusky, Milan & Huron road, after a gallant fight, finds itself out of the financial woods, and the indebtedness is being settled as fast as possible. The treasurer gave a 500-mile ticket to each bond subscriber on making payment, November 1.

THE Saratoga, N. Y. Electric Railway Company, is casting about for winter uses. If the spring companies at the geysers will use the road for freight transportation, and adopt electric power for the bottling business, the plant will be operated during the next six months.

J. C. DUNCAN, the receiver of the Knoxville Electric Railway Company, is also superintendent of the electric light plant. Mr. Duncan has made a splendid record in the management of both interests, and is, besides being a thorough business man, an electrician of attainments.

SOME bright man in New York has had the patience to figure out the problem of how much it costs a man to ride six hours on the intramural facilities of the metropolis. He finds that for fifty cents, coin of the realm, any person so disposed may travel six hours and walk only half a dozen blocks in changing cars.

KANSAS CITY burglars successfully "burgled" the safe of the Kansas City Elevated Railroad, obtaining \$1,600 in cash and some valuable city records. The work was done in a quiet, expeditious and workmanlike manner, and did not awaken some twenty people who slept in the building. A watchman's salary for the past year would have been a good investment for the Elevated.

THE wildest scheme of the month comes from the far west. The exchange says that a party of eastern capitalists are about to put "trolley boats" in the Black Canon portion of the Colorado river. The power is to be generated by the river itself. Surplus power will be used to pump water over the arid districts for irrigating purposes.

THE deadly horse car, in Cincinnati, made a record, recently, by seriously injuring a passenger in a most peculiar manner. It seems that the horses' tail tangled up the reins, and in the beast's frantic efforts to kick his tail loose succeeded in kicking a section of dashboard through a front window and into the head of the passenger.

EVEN on so small a road as the Liverpool & Wellsville Electric they do have hoodoos. So thoroughly was the idea imbued into the employes' intellects that when the winter cars were repainted the hoodoos No. 5 and No. 10 were changed to 29 and 30 respectively. The public also had an idea that the cars were possessed and often refused to ride in them.

THE Twin Cities Rapid Transit Company and the St. Paul Park board, have arranged for the erection of a handsome pavilion at Lake Como. This will be opened to the public in June, 1894. The estimated cost is \$8,000, and it will extend out into the lake two hundred feet, built on piles. Concerts and similar attractions will be furnished by the company.

THE story comes from Philadelphia of a barn foreman whose strength was such that the use of electric cranes and other modern lifting apparatus was unnecessary. On one occasion with a single assistant he lifted a 4,000 pound car from one track of the barn to another. It should be stated, in order to adhere strictly to the truth, that this was during a fire and the excitement probably slightly increased his strength.

JOHN SLINGLUFF is the great man of Norristown, Pa. He is bank president, and of course, president of the street railway, called the Citizens' Passenger. Mr. Slingluff is interested in electric traction from all standpoints, including the front platform. He, therefore, spends a day, at intervals, twisting the controller and manipulating the brake. This gives him an opportunity to learn lots of things that railway presidents are not supposed to know.

THE cruiser New York has another claim for distinction in being the first navy vessel equipped with an electric launch. Secretary Tracy ordered the launch last February, of the General Electric Launch Company, of New York. The craft will be the captain's gig, and will be 30 feet in length, 6 feet 10 inches beam, and draw 22 inches. She will hold sixty-four storage cells and carry twenty persons. The weight of the craft is 3,900 pounds and she will cost \$3,200.

THE Taunton, Mass., Street Railway Company asks for rights to extend, to equip with electricity, and relay part of the road. Estimates are for the proposed new track and roadbed, \$159,369.89; overhead work, \$19,555.48; miscellaneous, \$22,675; additional rolling stock, \$48,750; addition to power plant, \$17,000; tools, etc., \$1,750; total, \$269,200.37.

THE Youngstown, O., street railway employes subscribed a generous amount to the relief fund recently raised to help those out of work in the city. Every employe participated and the money was sent, says the resolution, "as a thank offering on our part for uninterrupted employment." It was a graceful act and, as usual, the company helped out liberally.

THE Philadelphia Record, in a learned editorial on railroad speeds, says that a 100 mile an hour express train would fly off the track at the first sharp curve. The whereforeness of this expenditure of good newspaper talent on a technical subject is found at the end, where it is learned that the editor has unearthed a single rail system, which will revolutionize transit.

THE Eau Claire, Wis., council passed, under protest, a resolution permitting the street railway company to construct a car barn of frame. The company immediately set a large force of men to work, and by the time the usual petition came around to rescind the ordinance the barn had been built. It takes quick action to circumvent a street railway company.

DENNY MURPHY, who drove the first mule car in Milwaukee, was watching the big Brill double decker as it moved up East Water street, during the convention. "Whist, now," said Denny, "its meself that druv a two-story car in Milwaukee 30 years agone. It tuk eight mules to pull it, and it carried 200 passengers a trip." Then Denny took another "chaw" from the man next in line, and remarked, "Things ain't loike they wance wus."

B. J. ARNOLD, well known to the street railway men of the country as designer of several of the most complete and economic power plants for street railway work in the country, notably at Little Rock, Ark., Saint Jo, Mich., Chicago & North Shore, Chicago, and the Intramural power house at the World's Fair grounds, has severed his connection with the General Electric Company, and embarked for himself at 565 Rookery, Chicago. Mr. Arnold's abilities as a consulting engineer require no particular introduction, as "his works do follow him." He is an accomplished mechanical engineer, electrical expert and has no mean knowledge of the architect's methods.

JOHN M. JONES, of J. M. Jones' Sons, departed for Troy, N. Y., after a six months' sojourn at the Columbian Exposition. Mr. Jones did gallant work in spreading reliable information about the Jones car, and made many firm friends.

THE BROWN ELECTRIC COMPANY.

YOUTH is a crime which, with the younger Pitt, the electrical supply business can neither palliate or deny. Among the younger of the supply houses now doing a flourishing business may be mentioned the Brown Electric Company, of Boston. At the corner of Summer and Federal streets, in the Hub, they have installed their offices and ware rooms for the sale of telegraph, telephone, electric light and railway supplies. Of the latter industry its necessities and accessories the Brown Company has made a special study. They have introduced to this branch of the trade a complete line of overhead equipment, which has met with the greatest success and is being adopted by many leading street railways. During the past year

this company has furnished the equipment for the Lancaster & Columbia Street Railway Company, of Pennsylvania; the South Jersey Traction Company, which is doing a large amount of building in that state; the Hartford & Weathersfield Street Railway, and the Glastonburg Street Railway, of Connecticut; the North End



BROWN ELECTRIC COMPANY SUPPLY HOUSE.

Street Railway and the Quinsigimond Street Railway, of Worcester, and numerous other roads, besides orders to a considerable amount from various lines.

The company does, besides, a large lighting business, and have put on the market several new specialties, particularly a new push switch, which is meeting with phenomenal success.

We are pleased to present to our readers the portraits of the two principals of the company.

Maybin W. Brown, is well known to the trade as a successful street railway man, with an extended knowledge of the requirements of the business. He has a large acquaintance among street railway men.



P. M. REYNOLDS.

Philip M. Reynolds, the treasurer of the company, is also thoroughly versed in the details of the supply business. He was for some time connected with the Thomson-Houston and the General Electric companies, where his apprenticeship was served. He has financial charge of the company and by his caution and sagacity has brought it through the late unpleasantness with flying colors.

CHAS. A. SCHIEREN ELECTED MAYOR OF BROOKLYN.

THE name of the mayor-elect of Brooklyn is one so familiar to our readers, we take pleasure in extending congratulations, and present below a few words historical of his life. Although the nominee of the republican party, Mr. Schieren received a very strong support from the other side.

Mr. Schieren, the head and front of the great belting house, which was organized in 1868, of Chas. A. Schieren & Co., Brooklyn's new mayor, was born in Germany, in 1851, and has been a resident of Brooklyn since 1856, and since his majority a worker in political causes. He has been connected with the Brooklyn Young Republican Club for a number of years, and two years ago succeeded Chas. A. Moore as its president. His practical experience in politics, his large business interests, and the thorough respect in which he is held by both factions, made him a desirable candidate for the highest honors of Brooklyn. Mr. Schieren is an earnest and effective public speaker, and gained great credit for his management of the Henry A. Meyer campaign for the same office two years ago.

We congratulate Brooklyn and Mr. Schieren.

A **FREMONT**, Neb., ex-car horse ran away the other day, and they say that the animal followed the track 'round and 'round until he got tired and then went to the barn where he belonged.

A **MOTORMAN** on the Pittsburg & Birmingham Traction line has been notified that he has fallen heir to one-twentieth of an English estate valued at \$1,500,000, and which has been in chancery since 1812. His name is Charles A. Benley.



CHAS. A. SCHIEREN,
Mayor Elect of Brooklyn.

AN ELECTRIC CAR ELEVATOR.

COMPANIES which have occasion to store or repair cars above the first floor, and which are using electricity as motive power on their lines, will be interested in a description of the electric elevator recently installed in the new car house of the Worcester, Mass., Consolidated road. It was built by the Frisbie

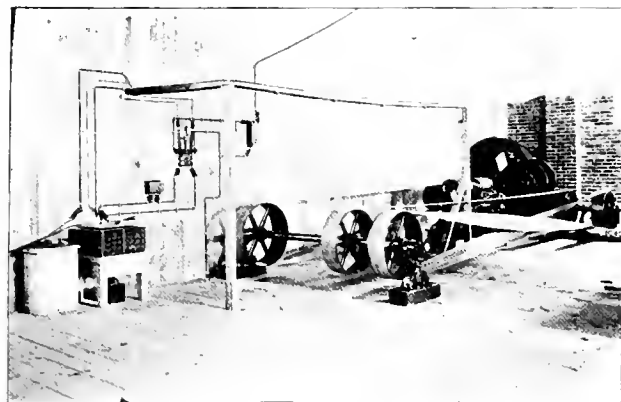

HOISTING MACHINERY.

Elevator and Manufacturing Company, of New Haven, Conn., and since its installation several weeks ago has been in constant use, furnishing an entirely satisfactory service. The problems involved in the installation of this elevator were many of them quite novel. The



ELEVATOR STARTING.

machine is very heavily built, and is operated through friction pulleys attached to a worm shaft, which in turn meshes into a very heavy spur gear, the same being fastened to the drum. These pulleys are of the Frisbie type, which have been so prominent in the country for

more than a dozen years. The machine runs quietly and is geared so heavily that the platform has a speed of thirty feet per minute, while the drum travels very slowly. The elevator machine weighs four and a half tons alone. The power is transmitted to this machine from a 20-horsepower Westinghouse motor, through a countershaft as shown in the engraving.

The platform is thirty-four feet long, fifteen and a half feet high, and ten feet wide. This is built entirely of iron and weighs six and a quarter tons. It is guided at four points on 10-inch channel iron beams, with maple guides fastened thereto. The platform is raised a distance of twenty-five feet, and has a lifting capacity of nine tons. Our engraving shows the platform with the

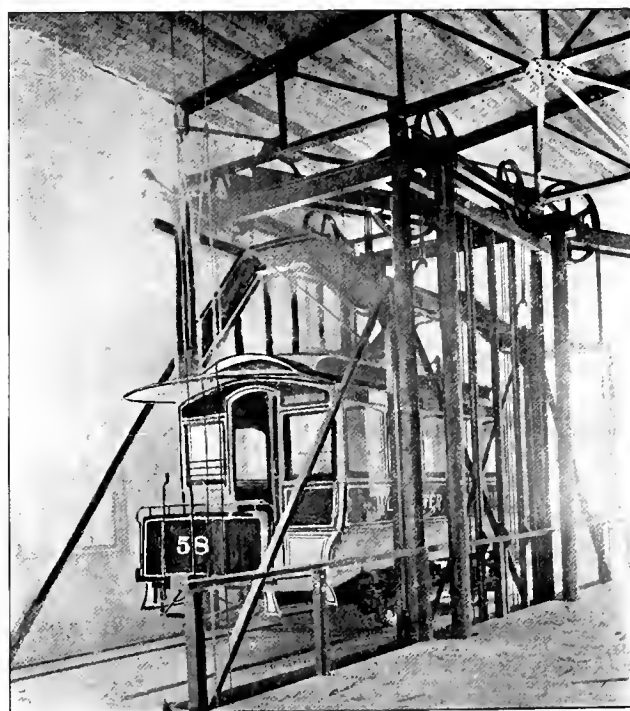

ELEVATOR AT TOP.

car on it, in the act of being raised. Attached to the platform are four counterweights, run within separate guides, each weighing one and a quarter tons. These are suspended by two cables each, while the platform is suspended by four heavy iron cables.

It was in the overhead work, where most planning was necessary. The beams are very heavy steel ones, and are supported either by the heavy brick walls, or by 8-inch iron columns bolted to very heavy iron girders. This beam work is all securely tied together. The main sheaves are four feet in diameter and made very heavy, weighing nearly one-half a ton each, properly scored to receive the four lifting cables. This overhead beam work was made more difficult to erect, from the fact that there is only one-half inch clearance between the main cross beams that carry the large sheaves, and the truss work of the roof. The elevator in question is handled very readily, indeed as much so as the ordinary small freight elevator is, the machine being very respon-

sive to the motion of the operator, and for such large work runs very quietly and smoothly. Everything about the construction of this elevator is of iron, except the floor of the platform, and over twenty tons of material entered into its construction, exclusive of the motor and foundations.

THE BIGGEST BOILER IN THE WORLD.

TO the west of the big boiler plant at the World's Fair, described several months ago in the REVIEW, is another array of power producers hardly less interesting. This subsidiary plant was necessitated by the amount of power used.

Chief of interest in this above mentioned subsidiary plant, was a pair of gigantic vertical water tube boilers, made by the Clonbrock Steam Boiler Works, of Brooklyn, N. Y., on the Morrin Climax system. A faint idea of the immensity of these generators may be gleaned from the engraving presented, but they must be seen to be realized.

This Climax display represented 2,000 horse-power. One boiler was of 1,000 horse-power capacity, and two were of 500. The whole battery contained 20,000 square feet of heating surface. The two five-hundreds have 500 tubes each, of 3 inches diameter, 11½ feet long. The large generator holds 1,000 tubes, of 3 inches diameter, 12 feet long, which, if placed in a continuous line, would reach two and a half miles.

The three boilers installed by the Climax people are guaranteed to evaporate 60,000 pounds of water into dry steam under actual, not ideal, conditions. The 1,000-horse-power boiler weighs, when ready for service, 181,000, and the smaller 131,000 pounds each. The large boiler occupies 198 square feet of floor space, while the smaller ones require 130 feet each. This type of boiler has been in service night and day for eight years, and on the general market for five years.

In street railway fields it has been particularly adaptable to trying conditions, and the number now in use in street railway power stations may be taken as representative of the future prospects of this generator.

Col. Jones, who has been in constant attendance and in charge of the exhibit, is a mechanical engineer of many years experience, and has been untiring in his attention to visiting brethren, with all of whom he is very popular.

AN INTERESTING CASE AT STREATOR.

THE electric railway at Streator, Ill., of which Walker Miller is manager, has just been victorious in a damage suit, for the value of a horse, which was killed by a shock from a fallen wire which crossed the trolley wire. The facts in the case are substantially as follows: On February 9, 1891, there was a

great sleet storm, so that the wires of the Central Union Telephone Company were nearly all broken down in the city of Streator. The wires of the Electric Street Railway Company withstood the storm and remained in perfect condition. It was claimed by the plaintiff that the wires of the Union Telephone Company fell of the Union Central across the trolley wire of the electric railroad and suspended to the ground. About eight o'clock on the morning of February 20, the plaintiff, Godfrey, was driving his team along the street and came in contact with the wire, which he claimed was suspended from the trolley wire to the ground. His horse was instantly killed. The further evidence showed that the telephone company was using their best endeavors to clear up the wreck,

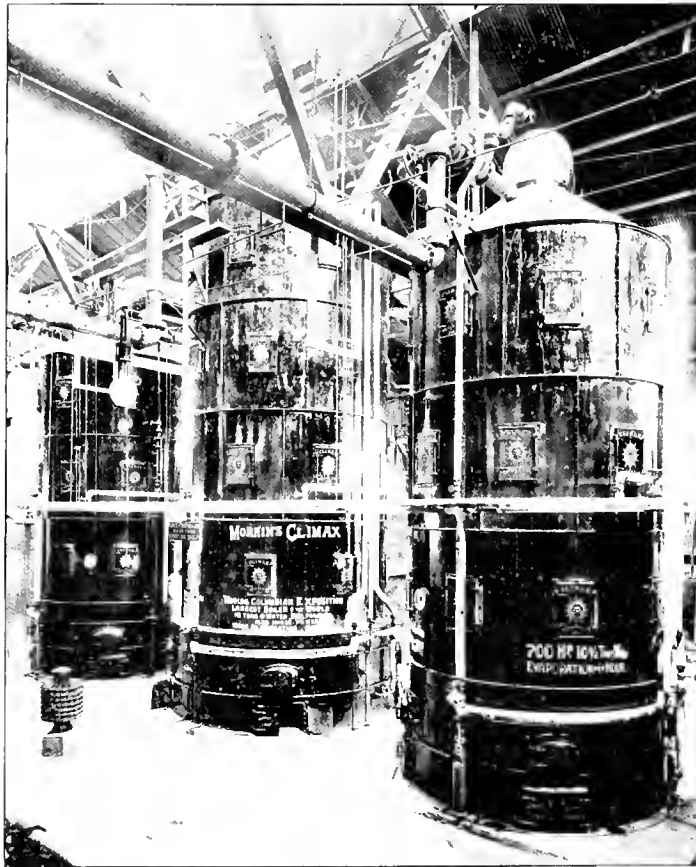

BIGGEST BOILER IN THE WORLD.

and the superintendent of the street railway directed the conductors and motormen on their line to be careful to remove any and all wires that were down, and the men claimed that they did as directed.

Under this state of facts the plaintiff dismissed as to the Union Central Telephone Company and asked a verdict against the Electric Railroad Company.

In the circuit court Judge Blanchard ruled that under the testimony a verdict could not be sustained against the railroad, and as the plaintiff had, on his own account, voluntarily relinquished claim against the telephone people, there was no alternative but to dismiss the case, which was done on motion of Reeves & Boys, attorneys for the street railway. The case is one of very few of similar nature which have been carried into court.

THE WILLANS ENGINE AND ITS WESTERN HOME.

FOR many years the Willans & Robinson patents on central valve high speed engines have been well known to British and continental power users, through the manufactured product of Willans & Robinson, Ltd., of Surrey, England.

The time has come, however, when the English manufacturer, if he has aught of merit, must come into the great and growing West with his product. Some first class American manufacturer, who knows the people, the wants, and the field, must become the western builder.

With no hesitation and without mistake, the fate of the Willans engine for the western hemisphere was put in the hands of the M. C. Bullock Manufacturing Company, the well known engine and mining machinery builders, at 1170 West Lake street, Chicago.

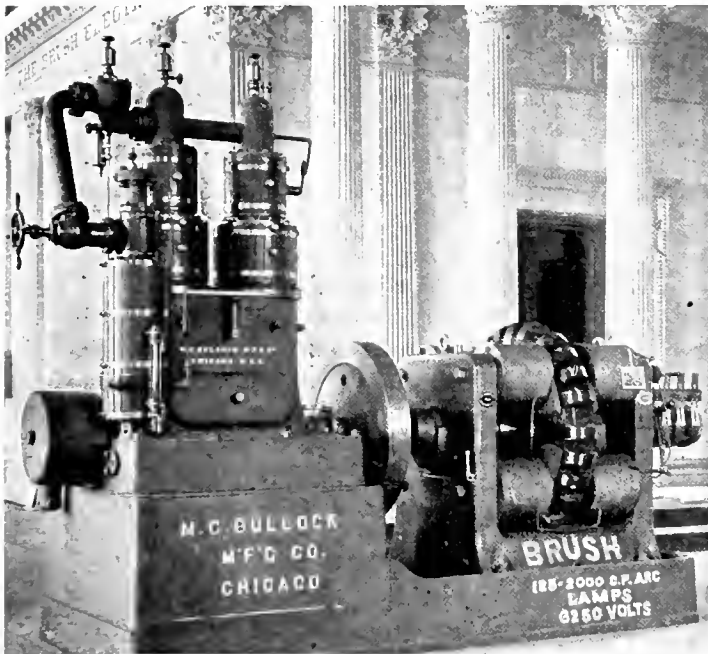

THE WILLANS DIRECT COUPLED ENGINE.

The Willans engine is particularly adapted to the uses of electric light and traction stations, and direct coupling with dynamos. As it is a vertical, the prominent factor of floor space economy is attained, and in addition the Willans engine claims maximum economy of fuel, labor and repair.

The Willans central valve is a single acting engine, of low piston speed, for a high speed engine, with consequent economy of wear in cylinders and piston rings. The valves, of the piston type, work inside the piston rods, with excellent distribution of steam and opportunity for water drainage. They are made in five standard sizes, having two to three cranks, and with low pressure cylinders, of twelve, fourteen, seventeen, and twenty inches, with strokes of six, eight, and nine inches. The standard revolutions per minute are quoted as 470, 460, 380, 350, 350, according to the sizes. They are run condensing and non-condensing, compound and triple expansion.

Each line of pistons in the Willans type is connected to its corresponding crank by two connecting rods, with a space between, within which works an eccentric, forged solid upon the crank pin. The piston valves, as noted, move inside a hollow piston rod, which passes completely through the line of pistons and through the ends of the cylinders. The valve faces, i. e., the inside surface of the hollow piston rod, move with the piston, and the valve motion thus required is a motion relative to the piston.

All parts of the engine are in compression, and all the moving parts are designed to be in constant thrust. The connecting rods are thus intended to work always in compression, and the eccentric likewise, the compression in the latter case being formulated by the pressure of the steam in the steam chest. Steam distribution in the compound engine is effectual, cutting off at .6 stroke when the gland rings are as low as can be fitted, but the height of the latter determines the cut off.

Air cushioning in the guide cylinder is provided without the addition of any moving part to the engine by the guide pistons, these compressing the air on the up stroke. Internal relief valves are provided for all engines in the low pressure cylinder, and, when practicable, in the high pressure. In cases where they cannot be applied, external valves are fixed. The drainage and lubrication of the Willans is special, and deserves consideration.

These types of engines attracted considerable attention at the World's Fair. In both Machinery Hall and the Electricity building exhibits were made, the most interesting, to our mind, being that of the latter, of which we show an engraving.

The Bullock Company is now making ready for a vigorous canvass of the power field, with reference to the American introduction of the Willan's engine, and will take pleasure in further explaining or elucidating the strong points of this type of power producer.

PAVING IN EUROPE.

IN Paving and Municipal Engineering, Louis H. Gibson says that brick pavements in Holland are first class, but where expense figures in the character of the foundation, there is a departure from the best results, though a brick pavement will stand much better than any other kind on a poor foundation. Some of the streets having tracks are paved with brick on a concrete foundation, with a filling of Portland cement. The result is a very rigid, durable surface. London has done a great deal of experimenting, but has now passed that stage, and has settled down to granite, wood or asphalt on concrete foundation. On such foundation the covering can be renewed whenever necessary. Most American cities are weak in the matter of repairs. In Europe there is a constant patrol of the pavements, with a view of finding and caring for imperfections while they are yet slight. Block paving is made to wear down thin without ruts, simply by the prompt renewal of bad blocks.

COST OF STORAGE BATTERY OPERATION ON SECOND AVENUE, NEW YORK.

OFFICIAL figures have been given out on the performance of the Waddell-Entz storage batteries on the Second avenue line in New York. It is certainly to the credit of the Waddell-Entz people that they are not afraid to publish figures, (as are the majority of storage battery companies,) even though those figures are not exceedingly low. The road was started June 1, 1893, and has been in continuous operation ever since, between Ninety-fourth and One Hundred and Twenty-ninth streets. Ten cars were run, but lately the number has been increased to eighteen. The battery depreciation has been 1.54 cents a car mile. The total cost of operation is given as 9.32 cents, which it is claimed can be reduced to 5.29 cents, with the eighteen cars now running. The depreciation is the main item of interest, however, as the cost of power and attendance in a well designed station ought not to exceed that on a trolley road.

The Waddell-Entz batteries are known as the zinc-copper alkaline type, and are radically different from the more common lead cells, that have been so extensively tried for traction. The positive plates are of woven copper wire, insulated with cotton. The negative plates are the steel partitions of the iron case, which case serves the double purpose of being one electrode and holding the solution. The copper positive plates are slipped in between the steel partitions in the case, the cotton insulation preventing a short circuit. The solution is zinc dissolved in potash. In charging, the copper is oxidized and zinc deposited on the iron sides and partitions of the cell, this action being reversed, of course, in the discharge. In practice it has been found that the main weak point in the cell and the one which causes the chief expense of battery maintenance, is the cotton insulation on the positive mat. We presume that some bright inventor on learning this will suggest the use of a water and acid proof insulating compound. The electro-motive-force of these cells is less than half that of a lead cell, being from .82 to .89 volt, as against 1.8 to 2.2 volts. The amperage is, however, enough greater to make up the difference.

The car controlling is done without the use of a brake. The field magnets are excited by a separate set of cells, and the speed in the main is varied by different combinations, in series or parallel, of the cells connected to the armature. At the highest speed all the cells are in series. In shutting off the current it is plain that the voltage of the motor is higher than the combination of cells to which it is attached and it acts as a dynamo, giving current to the cells and stopping the car. This dynamo action continues till the motor slows down enough to make its voltage the same as that of the cells, when the motorman puts the controller on the next lowest notch and so on until on the lowest notch the cells are cut out and the motor armature short circuited. A queer feeling comes over the average motorman when he sees these cars both

started and stopped by means of the controller. It is certainly a beautiful method of car control when not abused by careless men. The arrangements for the handling of cells are very complete. As is natural with a storage battery plant, being experimented with in a city like New York, the visitors have been numerous and the road has been the center of much interest.

If the results of the trial of the equipment of eighteen cars now running are as favorable, as regards cost per car mile, as there is reason to believe, they will be adopted for the whole road. Batteries for ten cars were recently shipped by the Waddell-Entz Company for use on a surface road in Berlin. Two sets of batteries, of 144 cells each, are provided for each car. The weight of a set is about 4,100 pounds. Cars have been regularly run twenty miles with one charge.

The work has every appearance of being an honest trial and the results are by no means discouraging.

THE TORONTO TRANSFER TICKET.

A NEW form of transfer ticket has during the month been put in service on the Toronto railway lines. Our reproduction, which is a little more than one-half actual size, shows the plan which enables a very

close time limit, the great desideratum of a transfer. The date is printed in for each day, and the further limits are punched by issuing conductor. Four cancellations are made, one for a. m., or for p. m.; one for direction; one for the hour and another for the minute, which is brought down to within five minutes. Passengers are very properly required to use the first car, and are also obligated to examine the ticket, to see if it is correct, before leaving the car. Our readers will recall the St. Paul decision, where the court held

the company had a perfect right to insist on this rule if printed on the ticket.

The reverse side of the Toronto ticket, reads as follows:

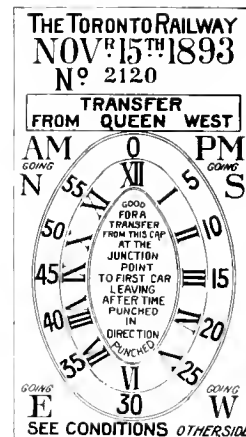

CONDITIONS OF TRANSFER TICKET.

This is not a stop over and is not transferable, and only good if passenger takes first car leaving junction where transfer is made.

The date and time punched must be verified and accepted by passenger when he receives this ticket, and in case of difference between passenger and conductor on transfer car the passenger must, if conductor demands it, pay fare and present this ticket with application for redress, to the superintendent's office.

JAMES GUNN, Sup't.

The ticket has been in use about two weeks and is working nicely, giving good satisfaction.

THOMAS C. BARR, president, and John I. Waterbury, vice-president, of the New Jersey Traction Company, have resigned, and David Young of Newark elected president and general manager. The \$8,000,000 of stock has all been subscribed.

A SERMON ON SWITCHBOARDS.

A few Plain Remarks on a Simple Subject.

BY JAMES RALEY.

A FULLY equipped modern electric railway switchboard is a very simple collection of apparatus. Nevertheless, very few fully equipped boards are to be found, even among the newer roads. It is in the hope that it may bring about a realization of the advantages of more completely furnished boards, that this article is written. Switchboards may be things of beauty, but they will not be joys forever until they are more fully equipped than are the majority to be found in use to-day. It is no uncommon sight to see a very fine switchboard on which a great deal of money has been spent, yet lacking some one piece of apparatus that is necessary to the most reliable and satisfactory operation of the road. The switchboard controls the entire electric system, and therefore its good or bad operation affects the whole system.

It is not necessary that a large sum of money be spent in making an imposing display of switches and instruments for the edification and astonishment of the rural visitor to the station, but it is important to have enough instruments so that the attendant will not be in the dark as to the performance of the plant.

To proceed to more definite details; no plant has any right to remark on its fine switchboard unless it will answer the following general description. The dynamo end of the board has a panel for each generator, on which is found the generator field rheostat, a three pole switch for connecting the machine with the bus and equalizing bars, an ammeter, a circuit breaker and a voltmeter plug or connection to a voltmeter switch. From the dynamo board, or more properly boards, (for each panel is a unit by itself) one of the bus bars is led through the main ammeter to the feeder board. Each feeder is supplied with a single pole switch ammeter and circuit breaker. Against the majority of dynamo boards now in use there is nothing serious to be said. It is on the feeder board that the great sins of omission are found, and right here the question of the proper sectioning of the trolley lines comes in. There are some straight and single lines running through country districts where sectioning is not advisable, but a greater majority of roads ought to have sectioned lines than now have them. All sorts of ridiculous combinations are met with on feeder boards. Sometimes a trolley line is sectioned and then the section feeders are brought in to a feeder board that has no circuit breakers, a proceeding paralleled by the man who bought a postal card on which to put his communication and then invested in a stamped envelope in which to enclose his card. In other words, omission of the circuit breakers is throwing away the main advantages of a sectioned line. These advantages are as follows:—

1. An accident or short circuit on one section does not interfere with traffic on other sections.
2. A short circuit does not overload the entire station and consequently the strain on machinery is lessened.

3. As the current, sufficient to throw a feeder circuit breaker is but a fraction of the total station load, the danger of fire and destructive fusion from short circuits is very much decreased.

4. The voltage throughout the system can be kept more even.

When there are no circuit breakers on the feeder board, the last advantage is the only one fully realized. The first is realized to a certain extent, in that after much vexatious delay the short circuited section can be cut out by hand. This cutting out by hand can only be done, however, after a few time-costly experiments to determine which section the trouble is on. Everything considered, the omission of circuit breakers on sectioned trolley feeder boards, is entirely inexcusable and absurd. Fuses are not considered in this connection, because they are out of date. Fuses have such an inconsiderate habit of blowing when they ought not to and making an unwarrantable fuss when they do go, that the majority of railway electricians have seen fit to quietly discontinue their use.

Another peculiar omission is that of putting no ammeters in the feeder circuits. This is not as serious an omission as that of the circuit breakers, because a portable ammeter can be cut into each feeder from time to time, and the average load on each can be determined. Nevertheless, they are a great convenience, and help to intelligent operation of the circuits and adjustment of circuit breakers.

The statements made in this article will probably seem elementary, as they are well known to every electrical engineer, but the condition of switchboards in power plants over the country is such, that there is evidently need that some one should be waked up on the matter.

FENDERS IN BALTIMORE.

THE Baltimore City Council has passed a fender ordinance, requiring the use of some sort of protection or life saving device. In an interview on the subject, President Blackstone, of the Central Railway Company, said:

"The public cannot be more eager to adopt appliances calculated to save life than we are. A single suit for damages that is decided against us may involve a greater amount of money than is necessary to equip all of our cars with fenders. I shall certainly put on fenders."

President Jas. L. McLane, of the Lake Roland Elevated, said:

"Money is no consideration. The companies would not hesitate to spend any amount to secure a thoroughly good fender, but in my opinion such a one is not to be had. I have seen a number of them, and none will prevent people from being maimed or killed."

President Bowie, of the City Passenger Railway Company, still regards his fender as the best he has seen, and will place them on the cars until a better one appears.

MARCUS LANIOUS, brother of President Lanious, of the York Street Railway, died lately.

LIFE ON THE MOVING SIDEWALK.

TO the thousands of persons who enjoyed, during the hot summer months at the Columbian Exposition, the cool breezes of Lake Michigan, from the point of vantage on the Casino Pier, known as the Moving Sidewalk, the accompanying illustrations will seem like a renewing of old friendships.

The great crowds carried without a single serious accident have, with one acclaim, voted the moving sidewalk the most satisfying enjoyment of the Exposition. The cheap fare and long ride, the comfortable seats, the safety, and the ease of mounting and dismounting, conspired to make it the Mecca of tired humanity at all hours of the day.

About noon, lunch parties came trooping down to the walk, carrying boxes, babies, lunch baskets, and cigars, for an hour's enjoyment before again facing the weary miles of Manufactures building and the glare of the White

THE STREET CAR AS A GEOLOGIST.

STREET cars can do anything, from solving the city problem to solving geological enigmas. As to the latter, Professor Sollas, of Nottingham, England, says: "Triassic pebbles are found indented, and many theories have been advanced for it. The best theory being their slight pressure on each other and the earth tremors of that early period." As further and more convincing evidence, the professor exhibited samples of pebbles taken from an ancient beach over which the tram line passed at Sandymount, a suburb beside Dublin Bay. They were covered with impressions essentially similar to those on the trias pebbles. This result was due to the perpetual jarring produced by the passing trams. Under the great pressure to which the trias pebble beds had been exposed, the slightest trembling at points of contact would, of course, produce similar or even more marked effects.

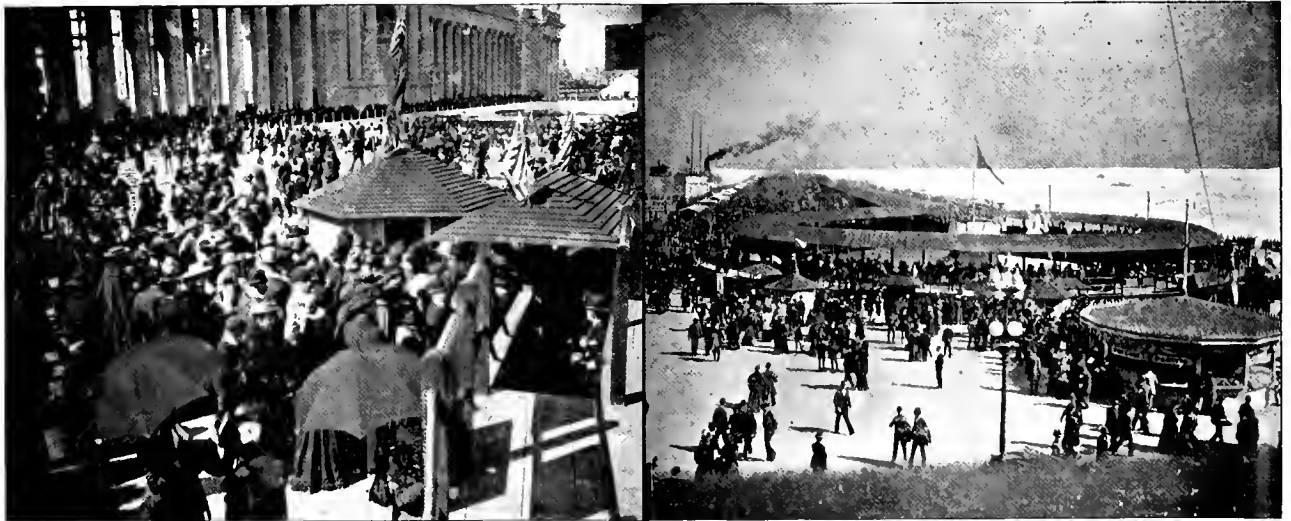

LIFE ON THE MOVING SIDEWALK

City. The old ladies and infirm individuals, who fear ordinary methods of traction, stepped on to the moving platform without a tremor. Its absolute safety was its greatest recommendation.

As an exhibition of the carrying capacity of this remarkable device, we are confident that no heavier stress could have been placed on any method of transportation than was put upon the small length of the moving sidewalk on Illinois day, Chicago day, Swedish day, and the last heavy crowds of October. The fact that on less than a mile of sidewalk 150,000 people could be carried every day, without crowding, and seating every one, illustrates the capacity of the sidewalk and its applicability to the sudden gorge of humanity at any one point, such as bridges, viaducts, down town districts, and the like.

The Chicago company which built the Casino pier construction is highly pleased with its venture, and have other plans in view, which will be made public at a later date.

STANDARD FORM FOR STREET RAILWAY ACCOUNTS.

MANY delegates to convention were greatly disappointed not to have had the pleasure of listening to H. I. Bettis, of Atlanta, Ga., who, it was expected, would have a paper on this subject. Mr. Bettis writes us he has no recollection of any appointment for committee work for this year, consequently made no report, and adds:—

"At the time of the last meeting I had urged upon members of the executive committee the appointment of a statistical clerk or secretary, as it is very difficult to get work of this class done by a committee of gentlemen whose time is wholly taken up with the affairs of their own roads.

"I, for one, have had very little time to devote to a subject of such magnitude and importance, and believe the only way in which we can arrive at any satisfactory

result is to secure a competent person who will devote a large portion of his time to the work.

“With the present varied methods of accounting and classification, it is very nearly impossible to get any accurate statistics for comparison.

“This suggestion was presented to the executive committee, but I do not think any action was taken, and in consequence we are to-day at precisely the same point in the discussion where we were one year ago.

“If the Street Railway Association cannot afford the luxury of a statistical secretary, let some action be taken toward securing such an appointment by the government, and at once.”

CURIOUS IDEA IN MOTOR TRUCKS.

IN the recently patented invention of J. T. Wilson, of Tyrone, Pa., the motors communicate reciprocating motion to the axles, as in a steam engine. The motors are reciprocated on ball bearing ways fastened to

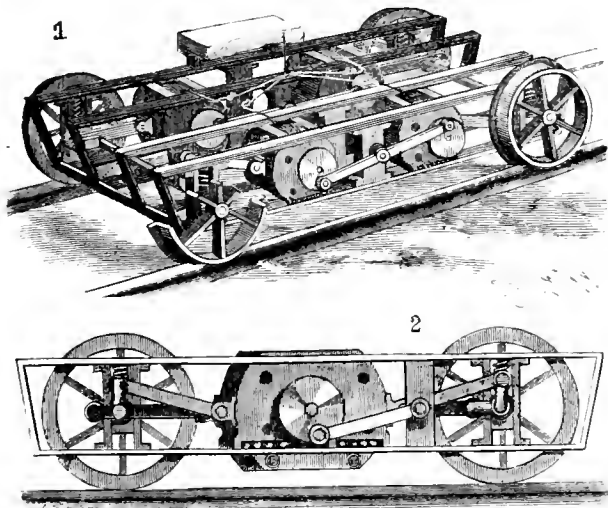

the truck frame. Our illustrations show trucks provided with two and four motors. This motion is such that the reciprocations counteract each other.

ST. LOUIS MILEAGE.

THERE are, to be exact, 235.39 miles of street railway in operation in St. Louis, and 43.8 miles building. They are divided among the lines thus: St. Louis & Suburban, electric, 19.5; Citizens', horse, 3.1; cable, 9.75; electric, 2.47; Cass Avenue & Fair Ground, electric, 27.17; St. Louis Railroad Company, cable, 14.69; electric, 4.95; Baden & St. Louis, horse, 5; Southern Electric, 15.67; Peoples', cable, 10.10; Fourth Street & Arsenal, 3.50; Missouri Railroad Company, cable, 9.06; electric, 15.66; Union Depot Railway Company, horse, 5.70; electric, 49; Lindell, electric, 41.6. The total of horse railway is 15.3; cable, 43.58; electric, 176.51.

THE Scullin system, of St. Louis, will introduce a new transfer arrangement.

ELECTRICITY ON THE CANAL.

THE long awaited experiment of applying electricity to canal boat propulsion will be made in a few days. The test will be made on the Erie canal, immediately east of Rochester, by the Westinghouse Electric & Manufacturing Company, using a trolley wire system. An ordinary canal scow has been rented and there can be little doubt as to the success of the scheme. Electrically and mechanically there is already no question, and it now only remains to determine the relative economy of mules and motors.

DENVER CITY CABLE RAILWAY COMPANY IN RECEIVER'S HANDS.

THE Denver City Cable Railway Company was passed into the hands of a receiver, November 10 by Judge Hallet, of the United States circuit court. at the instance of creditors and stockholders, represented by William Binney, of Providence, R. I. Mr. Binney recited in his petition that the Denver City Cable Railway Company had been organized in May, 1888, at \$1,000,000. This capital stock was increased, July 1, of the same year to \$3,000,000. Franchise was gained in 1888 and in the same year delivered to the Central Trust Company, of New York, a mortgage, secured by a series of bonds amounting to \$90,000 for each mile of double track, and that of these outstanding obligations there were \$3,581,000. The company was indebted \$5,000 to the plaintiff, on a demand note due, and he also owns 40 shares of stock. In the building and equipping of the road the company expended \$500,000 more than the amount permitted to be raised by bonds, and that now the floating indebtedness amounts to \$800,000, mainly in notes. To meet these obligations the company made another mortgage, secured by bonds, and placed them in the hands of the Central Trust Company. The business depression prohibited the sale of these. The petition also recites that supplies are owed for, and that the line and equipment are the sole assets; that business has fallen off and that there is no money to pay interest or pay for supplies. Wherefore, he prays for a receiver.

George E. Randolph makes affidavit that this company owns 30 miles of track in the city and a half mile of cable outside; that it operates the West End Electric Railway of 10 miles, single track, and 2½ miles of the Argo horse car line.

Judge Hallett appoints Cornelius S. Sweetland, of Providence, R. I., and Col. George E. Randolph, of Denver, as receivers. By virtue of a joint traffic agreement, the West End road goes into the hands of the receivers and vice-president D. F. Longstreet will retire. Traffic will not be interrupted. The road will probably be reorganized.

Colonel Randolph has been general manager of the Denver City for several years.

MANAGER M'LEAN, OF INDIANAPOLIS, THREATENED WITH ASSASSINATION.

WHILE the life of the street railway manager is understood to contain more than its share of hard work, anxieties, and annoyances, it is not often that his life is threatened as a result of doing his duty to his company. That not a few employes of the Citizens road, at Indianapolis, were very careless in accounting for their collections was fully demonstrated during the meeting of the Grand Army, at that city, two months ago. T. H. McLean, the new manager, and one whose reputation in the American Street Railway Association is second to none as an intelligent, just, and discreet manager, has found it necessary to dispense with certain



T. H. M'LEAN.

employes, who had been so long unmolested in their own ways as to resent any interference. That these discharges were well founded is fully indicated in a press dispatch from Indianapolis, under date of November 13, and which reads as follows:—

"The frequent discharges of street car employes by the managers of the Citizen's Company have led to a number of threatening letters to Manager McLean. These have become so vindictive in their spirit in the last few days, that he is apprehensive that some of the writers may attempt to carry their threats into execution. The men who have been discharged were regarded as agitators, and as standing in the way of an efficient service, and McLean has been fearless in making discharges, and unknown persons are now bombarding him with letters in which his life is threatened. One writer gives him but a few hours to live. Mr. McLean says that he will give the letters attention. 'Mayor Harrison,' he said, 'would be alive now if he had taken reasonable precautions, and while I do not apprehend any particular danger, there is no telling what cranks will do at a time like this.' He says there is no danger of a strike, as the efficient men in the brotherhood are satisfied with his action."

All who are acquainted with Mr. McLean know him to be one of the fairest minded of men, and while insisting on a strict discipline, is withal a most considerate employer, which fact is fully attested by the regard and esteem in which he is held by the hundreds of former employes in New York City.

CASH BELTS FOR CONDUCTORS.

A CONDUCTOR writes us to ask where he can purchase a cash belt. We were obliged to reply that there was none in the market designed for street railway use. On some accounts such a belt, if neatly made and worn beneath the coat and vest, might prove a help, though in winter it would have to be worn outside the overcoat. The weight of coin, when any considerable amount is gathered in coat pockets, is very wearing on the garment, although the leading uniform maker in this city has a special support which prevents the pockets from tearing out. Probably the only way to surely determine the value of the cash belt is for some road to make the experiment on several men.

PERSONAL.

A. U. JAASTAD, electrical engineer, of Boston, was a recent REVIEW visitor.

HENRY HURT, president of the Washington & Georgetown road, is abroad.

GEO. C. TOWLE, superintendent of the Biddeford & Saco Electric Railway, has resigned.

S. M. DELAMATER, secretary of the John Stephenson Company, New York, was a Chicago and REVIEW visitor during the month.

P. M. BRANN, of the Waterville & Fairfield, Me., Street Railway, has returned to the duties of superintendent, after a sickness of nearly a month.

PRESIDENT ALBERT E. HAY and William Harold Hay, of Robinson Machine Company, of Philadelphia, were post convention visitors at the REVIEW office.

CAPTAIN ROBERT McCULLOCH, St. Louis, who has had a long illness, lasting nearly two months, is again on duty, much to the gratification of his many friends.

JOSEPH E. WIDENER, son of P. A. B. Widener, president of the Philadelphia Traction Company, was married last month. The lady of his choice was Mrs. Heberton, one of the most beautiful women in Philadelphia.

FRANK S. DERONDE, whose title of general sales agent falls short of expressing his manifold duties with the Standard Paint Company, of New York, was a Chicago visitor this month. Mr. DeRonde entered its service at the early age of eighteen and by his own deserving methods has built a reputation for both himself and his company, of which he has a reason to be proud.

W. H. SMITH, the electrician and superintendent of machinery of the Ogden, Utah, City Street Railway Company, was a REVIEW caller during his visit to the east this month. The Ogden City is one of the best maintained and managed roads, not only in the west, but in the country, as we know from personal observation; and much credit is due Mr. Smith for his thorough and systematic methods of inspection.

J. W. HENNING, of New York, who was recently elected president of the New Orleans Traction Company, to fill the vacancy caused by the death of Mr. Denniston, belongs to that remarkable class of young men which has so largely to do with modern street railway enterprise. Mr. Henning is but 30 years old, but wields an executive ability far in advance of his years. He is interested in street railway properties in Buffalo, Louisville, Brooklyn, Columbus and Boston, and acted as the promoter in the purchase of the New Orleans lines, where his far-sighted policy and progressive ideas will now have full opportunity of accomplishment.

PAUL H. PAGES left Chicago this week for New York City. Mr. Pages ably represented the John Stephenson Company during the Exposition, and made many friends by his courteous treatment of the enquirers after street car knowledge.

OUR readers will learn with deep regret of the sudden death of Andrew J. Porter, superintendent of the Buffalo Railway Company. On Sunday, October 22, while driving, accompanied by his wife, in crossing the New York Central tracks, the buggy was struck by an engine, instantly killing Mr. Porter and seriously injuring his wife. He came to Buffalo from Louisville with Mr. Littell and had held his position since June 30 last. He was very popular both with the company and employes.

THE cable running the Washington street tunnel and down town loop of the West Chicago Street Railroad, got out from under the depression pulleys in the tunnel lately and, forcing its way up through the slot, appeared above ground for a distance of several hundred feet. The accident occurred on the north side of the tunnel, that being the one in which the great tension is on the cable.

the remaining passengers saved themselves only by the most dangerous leaps from the doomed vehicle a few seconds before the plunge.

The few eye witnesses of the catastrophe all testify as to the density of the fog, and the inability of an ordinary person to see more than a car length ahead on the bridge. The motorman claims that his speed was not beyond the regular pace, and that he used the brake in time, but that the wheels skidded, also reversing the current when within one span of the draw. He saved himself by jumping at the last moment. A diver was sent down to the car soon after the accident, and by 11 o'clock a derrick and pile driver were in position, and located the car lying on its side in a badly smashed condition.

The car contained eighteen or twenty people when it went on to the bridge, and it is little less than miraculous that so many escaped death. Of those going over into the river, two men who were swimming for their lives were struck and killed by the passing steamer.

SUPERINTENDENT A. McNAUGHTON, of the West Side Street Railway, Milwaukee, is recovering from a severe attack of bronchitis.



THE PORTLAND DISASTER.

A PORTLAND STREET CAR PLUNGES INTO AN OPEN DRAW.

THE second sensational accident for this year occurred in Portland, Oregon, November 1, on the East Side Railway, of that city. At 6:45 on the morning named, the Milwaukie & Portland electric car "Inez," which runs between the city and the suburb of Milwaukie, plunged off of the Madison street bridge, at the east end of the draw, which is at the middle, and was hurled into the Willamette river. The morning was densely foggy, and a sharp frost the preceding night had covered the rails and trolley line with a thin coating of ice. The draw span had been swung open to allow a steamer to pass, and the gates were closed at both ends of the bridge, and the red signal lights hoisted. The steamer was within a few feet of the draw when the car crashed through the frail gates, and ran headlong through the open draw into thirty-five feet of water.

Six men and one boy lost their lives in the disaster, and

AND now a call has been made for a meeting of managers to organize the Texas Street Railway Association. Singularly the initials of the organization spell "star," which is eminently proper as belonging to the "Lone Star State." State and municipal legislation in Texas has been about as severe and unjust on street railway enterprise as anywhere in the country, and the proposed association should prove of great service in a united defense of common rights. Success to it. A. Zintgraff, of Denison, is the prime motor in the matter, and the meeting for organization will occur early in December.

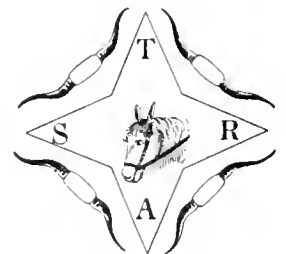

THE Southern Electric Railway, of St. Louis, has asked to build a loop on Broadway. The Cass avenue line opposes the move.

AND THE CAR CAME BACK.

AN electric car at Norwalk, O., played a queer game of tag all by itself one day recently. It had been left on the siding near the power house at night by a careless motorman, without having the trolley pulled from the line, and evidently without the switch being turned or the power shut off, except at the power house. When the engineer turned on power in the morning the car was just feeling strong enough to take a little before-breakfast stroll. So it started out bravely without motor-man or conductor. It ran safely across a river to the brow of a hill opposite, when the engineer discovered the truant and shut down the engines. Then it came back down grade, slowly at first but accelerating to a high speed, which carried it across the bridge to the power house again—so “the car came back.”

MAKING A STREET CAR IN SPAIN.

IBERIAN street railways, in common with all other street railways, have depended upon American builders for their street car types, and, in the main, for the vehicles themselves.

There is, however, in Spain, considerable activity in this line of work, coupled with the building of steam cars. The chief car works of the Peninsula are at Pueblo-Nuevo, a suburb of Barcelona. The shops have a front-



LOADING STATION FOR FREIGHT TRAM CARS.

age of 800 meters (270 feet). The area occupied by the manufactory is 77,000 square meters, of which 41,600 meters are built upon. The shops are divided into two groups, one for iron work and blacksmithing, and the other for wood work, carriage making, and wagon construction. Four hundred horse-power is found sufficient to operate the former department, with 100 horse-power additional for the wood working shops. The best of English tools are supplied to the workmen, and the shops are well lighted and convenient.

The pious Spanish founders of these very secular establishments gave them very holy names, and the subject of this sketch was called “Iron Works & Workshops of Construction of Our Lady of the Remedy,” or in the vernacular, “Herreria & Talleres de Construcción de Nuestra Señora del Remedio.” This was twelve

years ago. In 1881, however, there was a change in the firm name, and the holy appellation gave place to the plain statement, “Sociedad de Material para Ferrocarriles,” (literally, Society for Railroad Material). The capital was ten million pesetas, \$2,000,000. The manager then, as now, was the aged citizen, Girona, whose piety and public spirit has become historic.

The car shops proper of this plant are surrounded by minor departments of work, such as upholstering rooms, paint shops, steaming rooms for bending wood, tool rooms, and supplies of every sort. The shop system is not radically different from American practice. The shops have easy access to railroads, and have all the work they can do, turning out the various styles shown in the accompanying engraving.

The rather crude vehicle numbered 1 in the engraving is a third class coach for the street railway line from Manresa to Berga, province of Barcelona. It has transverse compartments. No. 2 is a horse car of Valencia. It has roof seats and a fair capacity. No. 3 is a steam car on the Barcelona & Badalona line. It is a fairly modern vehicle, but of light construction. The box affair numbered 4 is a luggage van (American, baggage car) of the Valencia & Betera Railroad. Number 5 is a street car of Zaragoza, as it stands on a turn table. It is a horse-car, as may be readily determined, and not a bad looking vehicle. Number 6 is another steam car of the first class, plying between Barcelona and San Gervasio. Its carrying capacity would shame an American bobtail car, but is sufficient for the Spanish idea of comfort and speed.

The Spanish railroad station shown is of Barcelona, and known in the Spanish as Tingladd de cuchillos de Armadura de forma inglesa con Tirante Horizontal. The small open car shown separately is from Zaragoza and intended for horses.

The profits of Spanish car building are said to be small, although it is difficulty to obtain reliable data. An American gentleman in attempting to gain a clear idea, expressed the wish to see an itemized cost-bill of a Spanish car, but he naively observes, “I was in every case disappointed. Each builder circumventing the question. So that I am forced to believe that profits are small and competition needlessly severe.”

In the workshops in the metal working department 300 men are employed, with 200 more in the various car building shops.

The salaries of skilful workmen vary from 5 to 6½ pesos (from \$1.00 to \$1.30 a day). Living expenses are not proportionately cheap, and existence is as expensive as in New York or Chicago.

The material for street railways in Spain is certainly of the same standard as that of many European countries, and the Spaniard is certainly indolent enough to use such articles. Electricity has not yet made its advent, but when it does a grand stirring up of the dead past may be expected and Spain will once more find herself a modern nation. To do this the governmental abuses must be abolished and the laborer taught to work while he works

and play when he plays. The hours of labor now are from 6 a. m to 6 p. m, week in and week out, with two hours, from 11 a. m. to 1 p. m., for breakfast and intervals to smoke. The Spanish laborer may forget to work or to eat, or to breathe, but never forgets to smoke.

American manufacturers would find it difficult to build

AS AN illustration of the contortion which American news undergoes in trans-Atlantic cabling, note the following from an English exchange, regarding the recent disaster at Portland, Oregon, where a car went into the Willamette river, drowning seven persons: "An electric car on the Oregon City Tramway line, containing thirty



TYPES OF SPANISH STREET CARS.

cars in Spain, and perhaps as difficult to ship them thither but the time may come when some enterprising American, concern will open up in England or France and supply all Europe, Spain included, with modern street car. Street car interests abroad are on the verge of immense improvement and extensions.

passengers, went through an open drawbridge in Madison-street last Wednesday and was plunged into Carpen river. So far as can at present be ascertained, twenty-five of the occupants of the vehicle were drowned." Now the question is: Do cables from the other side come as truthfully to us?

FARES OF THE FAIR.

DURING the Columbian period proper, May 1 to November 1, 1893, all the local transportation lines did an abnormally large business. The expenses of course were increased, but not in proportion to the heavy traffic, except perhaps in the case of the Illinois Central. The extra expense incident to whose World's Fair arrangements was unusual and necessitated not only new rolling stock, but new road bed and new safety equipment of the most expensive nature.

While it is true that the number of passengers recorded for the South side facilities does not represent alone the World's Fair traffic, it is equally true that the North and West sides, as well as suburban traffic was greatly augmented by the extra trips each week taken by resident visitors to the Fair and their visiting friends.

The local lines doing the heaviest business were of course those well known avenues of traffic enumerated below, with the total traffic from May 1 to November 1.

Chicago City Railway system, - - -	78,000,000
North Chicago Railroad Company, - - -	36,595,546
West Chicago Railroad Company, - - -	60,000,000
Chicago & South Side Elevated, - - -	22,371,799
World's Fair Steamships, - - -	3,000,000
Total, - - - - -	199,967,345

Besides this, the number handled by the Calumet road and by the South Chicago City Railway were not inconsiderable, although the modesty of these latter roads prohibits a full accounting.

The Suburban traffic was divided as follows:

Illinois Central, - - - - -	18,178,893
Wisconsin Central, - - - - -	1,145,744
Baltimore & Ohio, - - - - -	500,000
Chicago, Burlington & Quincy, - - - - -	2,760,000
Northwestern, - - - - -	1,800,000
Rock Island, - - - - -	600,000
Lake Shore, - - - - -	540,000
Total, - - - - -	25,524,637

The Wabash, the Chicago, Milwaukee & St. Paul both did a heavy suburban service, but were not able to give their accounting at the time this article was written. The Milwaukee did a particularly large business, however, and with its splendid double track facilities ran a continual express service to Milwaukee and return.

ARRIVALS FROM ABROAD.

Railroad companies after they had come to their senses did yeoman service for the Fair. The total arrivals in Chicago are enumerated at 9,916,295. The C. B. & Q. carried 2,300,000 passengers into Chicago; the Northwestern, 2,700,000, which two systems carry also the over-a-million banner. The others scattered all the way from half a million to three-quarters for the season. But for the short-sighted action of the railroads, the Fair might have had at least three and perhaps four or five times this number of visitors from the more remote States.

The "World's Fair Express" service on the Illinois Central paid \$882,410.20 in 10-cent fares. For the last eleven days of October, 1,110,000 were estimated.

For the tremendous mass of humanity carried, the deaths from accident were remarkably few, and in nearly every case terminating fatally the victim had himself to thank. Compared to the awful record of the steam roads of the country at large under much better conditions, the surface roads of Chicago have every reason to congratulate themselves, their employes and their managements.

A NOVEL TRANSFER.

A RESIDENT of Toronto, Canada, suggests a quite unique form of transfer, to be operated by a method still more so. Our illustration will fully describe the scheme, which in brief is a ticket perforated as shown in the diagram. It is torn down half an inch at points indicating respectively the hour, and almost the minute, of the transfer, and the route to which the passenger is to be transferred, it being understood that such routes would be numbered. The day of the week is supplied by a hole in the center, the conductor severing the space of card between the two holes. This may of

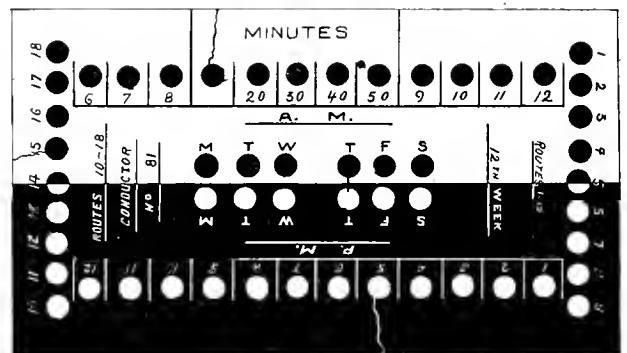

course be done in bulk. The card is half white and half red, representing a. m. and p. m., respectively. The diagram printed shows a ticket given to be used about ten minutes past 5, on the afternoon of Thursday, on route 15. The number of the week in the year is printed on the card. The ticket is certainly one of the simplest, yet most ingenious yet produced. No provision is made for Sunday, as cars do not run in Toronto on that day. While the tearing process does away with the necessity for a punch, the difficulty which a conductor would experience in "reading" the indications will doubtless prevent its general use. The inventor is Andrew McFarland, who is connected with the establishment of Elias Rogers & Company, of Toronto.

IN THE CLOSED CAR.—Conductor: "You shouldn't smoke, sir!" Gent: "That's what my friends say." Conductor: "You must not smoke." Gent: "That's what my doctor says." Conductor, (pointing to notice and looking wicked): "You shan't smoke here, sir." Gent: "Ah, just what my wife says. Well, here's my street."

Street Railway Review

CAUGHT ON THE RUSH TRIP.

American Street Railway Association.

HENRY C. PAYNE, PRESIDENT, Milwaukee, Wis.
 WM. J. RICHARDSON, SECRETARY AND TREASURER, Brooklyn, N. Y.
 W. J. STEPHENSON, FIRST VICE-PRESIDENT, Washington, D. C.
 J. R. CHAPMAN, SECOND VICE-PRESIDENT, Grand Rapids, Mich.
 LEWIS PERRINE, THIRD VICE-PRESIDENT, Trenton, N. J.
 EXECUTIVE COMMITTEE: D. F. LONGSTREET, Denver, Col.; T. H. McLAIN, Indianapolis, Ind.; ED. WHITTAKER, W. Y. SOPER, Ottawa, Ont.; and E. S. GOODRICH, Hartford, Conn.
 Place of next meeting, Atlanta, Georgia, third Wednesday in October, 1894.

Massachusetts Street Railway Association.

President, CHARLES B. PRATT, Salem; Vice-presidents, H. M. WHITNEY, Boston, AMOS F. BREED, Lydd, FRANK S. STEVENS; Secretary and Treasurer, J. H. EATON, Lawrence.
 Meets first Wednesday of each month.

Maine Street Railway Association.

President, WILLIAM R. WOOD, Portland.
 Secretary and treasurer, E. A. NEWMAN, Portland.
 Next meeting will be held the first Wednesday in February, 1894.

Ohio State Tramway Association.

President A. E. LANG, Toledo; Vice-president, W. J. KELLY, Columbus; Secretary and Treasurer, J. B. HANNA, Cleveland; Chairman Executive Committee, W. A. LYNCH, Canton, O.
 Meets at Toledo on the fourth Wednesday in September, 1894.

The Street Railway Association of the State of New Jersey.

President, JOHN H. BONN, Hoboken; Vice-president, THOS. C. BARR, Newark, Secretary and Treasurer, CHARLES Y. BAMFORD, Trenton; Executive Committee, OFFICERS and C. B. THURSTON, Jersey City; H. ROMAINE, Paterson; LEWIS PERRINE, JR., Trenton.

The Street Railway Association of the State of New York.

D. B. HASBROUCK, PRESIDENT, New York City.
 O. TRACY ROGERS, FIRST VICE-PRESIDENT, Binghamton.
 JAS. H. MOFFATT, SECOND VICE-PRESIDENT, Syracuse.
 WILLIAM J. RICHARDSON, SECRETARY AND TREASURER, Brooklyn.
 The next meeting will be held at Syracuse on the third Tuesday in September, 1894.

Pennsylvania Street Railway Association.

H. R. RHOADS, PRESIDENT, Williamsport.
 R. L. JONES, FIRST VICE-PRESIDENT, Reading.
 S. P. LIGHT, SECRETARY, Lebanon.
 WM. H. LANIOUS, TREASURER, York.
 Next meeting at Reading first Wednesday in September, 1894.

California.

RIVERSIDE, CAL.—G. Q. Newman asks city trustees for franchise for city. Petition is laid on the table.

SAN DIEGO, CAL.—Herbert Dabney asks franchise to extend the Pacific Beach Motor Company to La Jolla and beyond.

LOS ANGELES, CAL.—Bellevue avenue residents appoint committee to secure electric railway extension into that territory.

SAN FRANCISCO, CAL.—Behrend Joost applies for franchise for railway line to the Golden Gate Park. A temporary grant will probably be made.

OAKLAND, CAL.—It is stated that a new survey has been made for a new electric line from the terminus of the Piedmont Cable to the Moraga grant. The line will go through valuable land.

OAKLAND, CAL.—The Consolidated Piedmont Cable has gone into hands of receiver. Ira Bishop is appointed in that capacity by request of directors, to the California Title & Trust Company, trustee.

SAN DIEGO, CAL.—California, Title, Insurance & Trust Company brought suit against C. W. Pauly, assignee of the San Diego Cable Railway to determine validity of bonds. Court holds that bonds are good.

LOS ANGELES, CAL.—Ex-Mayor Workman and T. D. Hoskins ask franchise for a short line on First street, to be operated with the Hoskins motor.

LOS ANGELES, CAL.—The board of supervisors give W. D. Larrabee the right to build an electric from the north boundary of Los Angeles to the south boundary of Pasadena. Larrabee was highest bidder, to the amount of \$100,000.

SAN FRANCISCO, CAL.—General Manager M. D. Stein has appointed his superintendents. H. H. Lynch is made superintendent of construction for the Amalgamated Company. A. W. Barron, J. C. Skinner, J. F. Clark, H. O. Rogers, are division superintendents.

PASADENA, CAL.—It is reported that the capitalists interested in the construction of the electric road from Los Angeles to Santa Monica, are looking towards Pasadena with a view of building a similar enterprise. Pasadena is willing to help if business is meant.

SACRAMENTO, CAL.—L. T. Hatfield, of the Sacramento Electric Light & Power Company, applies to supervisors for right of way, and privileges to operate one or more systems of generation and transmission of heat, light and power between Folsom and Sacramento.

PASADENA, CAL.—Knight & Simpson, lawyers of this city, are agents of purchasers of the Highland Street Railway Line. Buyers are from Los Angeles. The new purchasers, it is said, will build a long line of extensions and equip with electricity. They will interconnect a number of other lines.

LOS ANGELES, CAL.—The sale of the Pacific Railway Company's cable road was consummated October 4, and, as was expected, the Consolidated Electric was the only bidder. The price was \$1,344,320 48. E. P. Clarke and Gen. M. H. Sherman, of Los Angeles, did the bidding. The sale includes all properties, rights, privileges and plants. Mr. Clarke was at convention in Milwaukee.

SAN BERNARDINO, CAL.—The San Bernardino Street Railway Company has disposed of its E street line to W. H. Burkhart, of Los Angeles, who took possession on the first of November. Mr. Burkhart says that it is his intention to personally operate the road and at an early date extend the line to Arrowhead Springs, some seven miles to the north. The motive power to be used has not yet been decided on, but electricity is promised at no late date.

Canada

TORONTO, CAN.—Secretary I. B. Blacklock, of the Toronto & Richmond Hill Street Railway Company, says contracts are to be let for five and one-half miles of road.

Chicago.

CHICAGO.—B. E. Sunny denies the shortage of \$100,000 in the account of the Omaha branch. He claims that the report comes from a disgruntled employee.

CHICAGO.—West Chicago Street Railway directors vote to issue \$1,089,000 new stock. New stock will be purchasable to November 20, at par by stockholders.

CHICAGO.—E. B. Kettle, formerly of the General Electric, at Portland, Ore., is now associated with J. Holt Gates in the western management of the Waddell-Entz interest.

CHICAGO.—H. M. Godfrey, of Hammond, receiver, advertises sale of the Whiting, Hammond & East Chicago Railway for November 20. Will receive bids up to that date.

CHICAGO.—An ordinance is before the council allowing the North Chicago Street Railroad to construct a double track on Fullerton avenue, from Lincoln to Milwaukee avenues. It is rumored that the same company will put electricity on all horse lines if an ordinance can be got through.

CHICAGO.—The Northwestern Elevated Railroad Company has incorporated at a capital stock of \$15,000,000, to build an elevated road, presumably electric, northwesterly from Congress street. Men named are, Edward W. Russell, 85 Rush street, Chicago; Walter M. Anthony, 1021 Grove street, Evanston; B. J. Arnold, 4128 Prairie avenue, Chicago; Harold Surges, 44 Sidney court, Chicago; Frederick Sargent, La Grange, Ill.

Colorado.

DENVER, COL.—Denver Consolidated files deed of trust for \$4,000,000 to the Mercantile Trust Company, of New York. Deed is to run forty years at 5 per cent per annum. Money is to be used to retire old bonds and to be used in extension, of the present lines.

Connecticut.

MERIDEN, CONN.—Walter Pierce Douglass has given contract for road bed to Keena, of Philadelphia. Geo. Thompson, of New York, will put up the overhead line.

NEW BRITAIN, CONN.—New Britain Central Railway & Electric Company will build large extensions within the year. Both power and light are sold from trolley circuit.

WATERBURY, CONN.—E. A. Bradley, general manager of the Waterbury Traction Company, says that 3½ miles of extension and the whole line will be equipped with electricity next spring.

HARTFORD, CONN.—The Hartford & Wethersfield Street Railway Company will change its name to the Hartford Street Railway Company. The company accepts franchise of branch line in Glastonburg.

MERIDEN, CONN.—The street railway company decides to put in electrical equipment, and will probably buy General Electric. Majority of stock is now owned in Philadelphia and represented by W. P. Douglass.

HARTFORD, CONN.—The Central Electric & Railway Company has under consideration a proposition to assume control of the Bristol Street Railway Company, the latter exchanging its franchises for a part of Central stock.

District of Columbia.

WASHINGTON, D. C.—Representative Cooper, of Indiana, introduces a bill requiring street railway companies to heat their cars, and that within sixty days after passage of bill.

WASHINGTON, D. C.—The commissioners attitude towards a conduit system is unmistakably favorable. They ask power to condemn land for conduit purposes.

Delaware.

WILMINGTON, DEL.—Attorney Peter L. Cooper, of the road, says that the New Castle & Wilmington road will be ready for travel by spring.

WILMINGTON, DEL.—The Wilmington & Chester Railway elects the following officers to serve until the annual meeting in January: James C. McComb, president; E. T. Cooper, secretary; J. Clayton Erb, treasurer. A. Langstaff Johnson was appointed surveying engineer. Work on new road will probably begin in March.

Georgia.

ATLANTA, GA.—Atlanta Traction Company and the Atlanta City are now formally joined. New officers are: T. B. Felder, president; vice-president, E. T. Shubrick; directors are E. B. Rosser, G. V. Gress, et al. Extensions to be made.

COLUMBUS, GA.—The North Highlands Electric Railroad, superintendent F. E. Knapp, has applied for franchise to extend road five miles. Begin work early in spring.

Illinois.

ELGIN, ILL.—The city council grants the Dundee Rapid Transit Company an extension of time.

URBANA, ILL.—Urbana City ordinance for street railway is under way. B. F. Harris, Jr., president of company.

KEITHSBURG, ILL.—The Electric Light & Power Company suffered by fire, and the town is in total darkness.

GALESBURG, ILL.—Cy. Blackburn, a former employ, is new superintendent of the Street Railway, vice H. F. Hawley resigned.

OTTAWA, ILL.—Denis O'Brien is appointed superintendent of the La Salle & Peru Street Railway, to succeed Howard Johnson.

AURORA, ILL.—Dundee Rapid Transit Company, of which E. C. Hawley, of Dundee, is the head, and which will connect Aurora, Dundee, Elgin and other places, it is claimed is now on a building basis.

SPRINGFIELD, ILL.—Incorporated: the Peoples' Power Company, at Rock Island; capital stock, \$300,000; to manufacture and furnish light, heat and power to citizens of Moline and Rock Island; incorporators, Thomas B. Davis, Samuel S. Davis and Chas. V. Nason.

ELGIN, ILL.—The Elgin city council grants franchise to the Dundee Rapid Transit Company to build and equip an electric light plant at Elgin for twenty years. Also to build and equip electric railway line. Power and heat privileges are included in both franchises.

ELGIN, ILL.—The Lake Shore, Riverview & Elgin Railway Company incorporated at Chicago by D. W. Wood, of Park Ridge; Geo. M. Sterne of Englewood; Thos. H. Coleman, of Akron, O. The road will run from some point on lake Michigan, between Rogers Park and Evanston, to Riverview, thence to Elgin.

SPRINGFIELD, ILL.—Incorporated: The Carpenter Electric Power & Light Company, at East St. Louis; capital stock, \$2,000,000; to manufacture and deal in electric batteries, calls, generators, motors, etc.; construct, equip and operate electric light, heat and power plants, railways, machinery, etc. Incorporators, Hiram H. Carpenter, Ephraim C. Dawes and Jas. C. Brush.

Indiana.

INDIANAPOLIS, IND.—The Citizens' has decided to extend the stock-yards line on a bonus of \$800.

ROCHESTER, IND.—"Rochester can support a horse railway," says the editor of the Rochester Republican.

INDIANAPOLIS, IND.—R. M. Clay, Philadelphia, Dr. R. C. Light, of this city, and R. McDonald, of Fort Wayne, say that a road to Broad Ripple shall be built.

MICHIGAN CITY, IND.—F. H. Root, superintendent of the Lake Cities Street Railway Company, has bought some World's Fair equipment to equip the new electric plant here.

TERRE HAUTE, IND.—Russell Harrison has closed the option on the Terre Haute Street Railway, obtained last spring, for \$750,000. Rippetoe & Kidder, of Terre Haute, and Leslie Thomas, of Chicago, selling out. Extensions will be made next spring.

Iowa.

OSKALOOSA, IA.—C. Winter says that a mile extension will be built this fall.

SIoux CITY, IA.—Sioux City Electric loses \$2,000 in overhead line equipment by an accident.

WATERLOO, IA.—The Eickelberg Company, manufacturers of street cars, busses and wagons, assigns to C. F. Wichman.

SIoux CITY, IA.—Creditors of the Sioux City Street Railway Company met to reorganize the Company. The outlook is very discouraging, and it is doubtful if it can be done.

Kansas.

ATCHISON, KAN.—Atchison Railway & Electric Light Company increases capital from \$250,000 to \$300,000.

JUNCTION CITY, KAN.—The proposed line from Junction City to Fort Riley is being outlined and surveyed. It is reported that a storage battery company is about to test its product here.

DODGE CITY, KAN.—Organized: The Dodge City Light, Water & Power Company; capital stock, \$250,000. Directors, H. McGarry, W. H. Pearce, G. G. Gilbert, J. W. Gilbert, and A. J. Bixby, all of Dodge City.

Louisiana.

NEW ORLEANS, LA.—W. J. Hennings, new president of the New Orleans Traction Company, says that the line will be greatly improved.

Maine.

BATH, ME.—The Bath Street Railway Company buys the charter secured some years ago by a Brunswick syndicate to build in Brunswick and Topsham. These extensions will make it the longest road in the state.

BANGOR, ME.—The past year's operations of the Bangor Street Railway Company are thus reported to the state commissioners: Gross earnings, \$47,567; operating expenses, \$38,339; income, \$9,227; interest on funded debt, \$11,580; deficit, \$2,353; maintenance way and structures, \$2,009; maintenance equipment, \$6,143.

Massachusetts.

NORTHAMPTON, MASS.—The street railway has elected John Olmstead, of Springfield, president; N. D. Winter, treasurer; and F. C. Clark, Jr., superintendent.

WORCESTER, MASS.—E. W. Clarke and E. J. Moore, Philadelphia, and B. Peck, New York, inspect the Worcester Street Railway. They are heavily interested in it.

CLINTON, MASS.—The Clinton Street Railway Company has elected this board of officers: President, Harold Parker, Lancaser; vice-president, H. A. Willis, Fitchburg; treasurer, A. J. Witherell, Clinton; clerk, Walter R. Dane. Chas. F. Jeffs, late assistant superintendent of the Fitchburg & Leominster road, has been appointed superintendent of the Clinton road.

QUINCY, MASS.—Quincy & Boston Street Railway Company shows a gross income for 1893 of \$50,774, an increase of \$6,213. A dividend of 6 per cent was declared. The following named officers were elected: President, John R. Graham; clerk and treasurer, Fred H. Smith; directors, John R. Graham, Winthrop Coffin, Arthur A. Burnham, Wm. A. Hodges, John A. Duggan, Josiah Quincy, John F. Merrill, Thos. H. McDonnell, Roger H. Wilde; superintendent, Benjamin J. Weeks.

Maryland.

MARTINSBURG, MD.—Martinsburg Electric Railway franchise declared forfeited by city council. Operations suspended by J. B. Wilson, president.

BALTIMORE, MD.—Randolph Barton, receiver for the Wenstrom Consolidated Electric Company, begins action at law to compel payment of so-called treasury stock.

BALTIMORE, MD.—Hampton and Woodberry extension of the City & Suburban is finished as far as track laying. D. E. Evans & Co. will supply the overhead equipment.

BEL AIR, MD.—The Hughes & Rigby Engineering Company, who have the contract for lighting Bel Air and Havre de Grace, are looking up a route for an electric railway between these places.

BALTIMORE, MD.—West Baltimore Passenger Railway Company will build a suburban line to Ellicott city, improving intervening land. The directors of the proposed road are Wallace Stebbins and Harry O. Stebbins, of Relay; W. H. O'Connell and Henry W. Bennet, of Baltimore, and Barton W. Fenton, of Findlay, O. The capital stock is \$100,000, in shares of \$100 each.

Michigan.

OWASSO, MICH.—Receiver Richard Watters has qualified. The opposition will try to have his appointment set aside.

DETROIT, MICH.—The council of Walkerville grants the Sandwich, Windsor & Amherstburg Electric Railway rights in the town under burdensome conditions.

PORT HURON, MICH.—St. Clair River Railroad organizes, to build an electric from Port Huron to Marysville, St. Clair and Marine City. Capitalized at \$300,000.

Minnesota.

MINNEAPOLIS, MINN.—Colonel Goodrich says that the Twin City cars will be equipped with fenders and vestibules.

DULUTH, MINN.—To the regret of all F. S. Wardwell, manager for three years of the Duluth Street Railway, has resigned. Mr. Wardwell has not been in good health. He will return to street railway work in the future.

Missouri.

ST. LOUIS, MO.—Madison Car Company elects C. D. McClure, E. S. Rowse and L. M. Rumsey directors.

KANSAS CITY, MO.—The L. has decided to continue use of the electric heater used last winter on its lines.

CARTHAGE, MO.—Frank Harrison, of this city, says that Chicago capitalists will build a street railway here. An electric line is promised.

JOPLIN, MO.—It is reported that the Joplin Electric Street Railway & Motor Company will sell its Joplin property and extend the line from Blendeville to Galena.

SPRINGFIELD, MO.—Non resident stockholders apply for and get appointment of Chas. M. Parker as receiver for the Metropolitan Street Railway. Cause: Too heavy capitalization.

ST. JOSEPH, MO.—M. M. Crandall, special master in Chancery to sell the People's Railway property, files report, showing \$118,532 collected from purchaser and credit of \$465,000 by bonds.

CARTHAGE, MO.—Superintendent Sexton is working in the interest of the bayers of the interests of J. Guinney, and to save the franchise of the road. He is working in St. Louis, Chicago, and elsewhere.

ST. LOUIS, MO.—The Compton Heights, Union Depot & Merchant's Terminal R. R. Company begins to run cars over its line. New rolling stock is used and power rented from the Lindell Railway power house. Extensions will be made as soon as possible.

HAGERSTOWN, MO.—The South Mountain Railway & Power Company is organized by Geo. W. Jacobs, Jr., of Philadelphia; Theodore E. Bowne, of New York; Edgar L. Miller, Elmer J. Smith, of Frederick; Charles J. Young, C. E. Shaler and Geo. A. Davis, of Boonsboro. To construct and operate twelve miles of electric railway in Washington

New Brunswick.

ST. JOHN, N. B.—The Street Railway Company has been placed in the hands of a receiver.

Montana.

GREAT FALLS, MONT.—Mrs. Josephine Hamilton attaches property of the Great Falls Street Railway Company, on judgment for \$20,000.

Nebraska.

LINCOLN, NEB.—Wm. L. Clark is appointed temporary receiver of the Home Street Railway Company, on petition of the Fidelity Loan & Trust Company, of Sioux City, who asked judgment for \$80,000, due them on bonds.

New Hampshire.

DOVER, N. H.—Geo. W. Rounds, of Malden, Mass., succeeds Jas. Houston as superintendent of the Union Street Railway Company. The system is being overhauled to reduce running expenses.

New Jersey.

ELIZABETH, N. J.—The Union county freeholders grant franchise to the Consolidated Traction Company.

ASBURY PARK, N. J.—The Seashore Electric Railway, of Asbury Park, and the Asbury Park & Belmar road, ask rights to run through Ocean Grove.

ORANGE, N. J.—The trustees of South Orange have passed the ordinance giving the Newark & South Orange Railway Company right to use electricity.

TRENTON, N. J.—Col. Lewis Perrine says, in an interview, that the Street Railway Company will spend \$500,000 in improvements incident to change to electric traction.

HADDONFIELD, N. J.—The West Jersey Traction Company wishes to enter the city and eighty per cent of the taxpayers vote for it. The borough council, of which Wm. H. Snowden is president, is working for the permit.

New York.

LOCKPORT, N. Y.—The Lock City Electric Railway holds a meeting to decide on power house site.

PORT JARVIS, N. Y.—The new president of the Middletown Electric Railway Company is J. C. Hincheliffe, of Paterson, N. J.

SYRACUSE, N. Y.—The Consolidated Street Railway files mortgage for \$2,500,000 with the State Trust Company, of New York.

PORT JARVIS, N. Y.—The Middleton Electric will begin building asks for injunction against the Bath Beach & West End Railway to restrain from changing motive power.

BROOKLYN, N. Y.—The railroad commissioners decide to allow Brooklyn City Railway to use a number of streets upon which no cars run now.

BUFFALO, N. Y.—W. B. Cutter is prime mover in another street railway line between Buffalo and Depew, suburb. It will be electric and has plenty of money.

NEW YORK CITY.—The Prospect Park & Coney Island Railway asks for injunction against the Bath Beach & West End Railway to restrain from changing motive power.

NIAGARA FALLS, N. Y.—The Cataract Construction Company awards contract for power house to Stewart & Company, of St. Louis. Edward B. Adams and the principal officers were present.

JAMESTOWN, N. Y.—Jamestown Street Railway elects officers. President, A. N. Broadhead; vice-president, L. B. Warner; secretary, W. S. Cameron; treasurer, S. B. Broadhead; superintendent, G. E. Maltby.

NIAGARA FALLS, N. Y.—The Niagara Falls Park & River Railway will probably absorb the horse line from Clifton to Drummondville and change it to electric power. It is probable that the line will be extended through Victoria Park.

NEW YORK, N. Y.—The Houston, West Street & Pavonia Ferry Railroad has filed a certificate of an increase of stock from \$1,050,000 to \$7,050,000, the \$6,000,000 increase to be exchanged for \$600,000 of the second mortgage bonds issued October 1, 1890.

North Carolina.

RALEIGH, N. C.—Judge H. L. Bond, at suit of the Mercantile Trust & Deposit Company, of Baltimore, appoints John C. George, of Baltimore, temporary receiver for the Raleigh Street Railway Company. Permanent receiver will be sued for November 17. Road will be operated by S. W. Huff, agent for the receiver.

Ohio.

CINCINNATI, O.—Judge Hunt grants temporary injunction against Route No. 5, to Sedamville.

COLUMBUS, O.—The street railway employes struck for two hours, but returned to work.

FINDLAY, O.—The County Fair Association sues the Findlay Street Railway for damages and asks for 1,000 feet of extension.

MARION, O.—Dan Babst, Jr., who has a franchise for electric line here, asks city council for an extension of time. Nothing definite done.

PIQUA, O.—Extensions on local lines of the Miami Valley Street Railway, both here and at Troy, are being made and contemplated.

CINCINNATI, O.—Judge Smith refuses to enjoin the Mt Adams & Eden Park Street Railway Company from extending its Eden Park line.

CINCINNATI, O.—Judge Saylor appoints A. B. Hill temporary receiver of the Mt. Auburn Cable Railway Company on petition of E. E. Kinsey, for relief due as creditor for \$276.07.

CANTON, O.—The Street Railway Company has let contract to the Wrought Iron Bridge Company for the construction of a new car barn. It is a home firm and the barn will be very fine.

PAINSVILLE, O.—The Painsville, Fairport & Richmond Street Railway, I. K. Pierson, manager, asks for franchise for extension of line. It will probably be granted. Work to be finished this fall.

CINCINNATI, O.—The Main Street Electric Railway is decided by Judge Smith to be a trespasser, and is given six months to get a new charter. All car licenses since 1877 must be paid at once.

CHILLICOTHE, O.—A new boiler and a number of smaller supplies are needed by the street railway. The court authorizes issuance of \$4,000 certificates for that purpose. Sale will be argued November 20.

PIQUA, O.—The Piqua Street Railway Company has been succeeded by the Miami Valley Street Railway Company. This brings the roads in the two cities, and the interurban between them, under one management.

CLEVELAND, O.—The Amalgamated Association of Street Railway Employes elect W. D. Mahon, of Columbus, O., president; S. M. Massey, of St. Paul, secretary and treasurer, and the Street Railway Employes' Gazette as official organ. The next convention will be held at Milwaukee.

Oklahoma.

ENID, OKLA.—The Enid & Perry Electric Railway Company is organized, in Kansas, at \$500,000, to build between Enid and Perry, in the Oklahoma Territory. The incorporators are E. L. Dunn, R. W. Patterson, Chas. O. Wood, J. W. Thompson, all of Enid, and James A. Pierce, of Denver, Colo. The men claim that work will begin at once. The line will be a long one.

Oregon.

OREGON CITY, ORE.—East Side Electric makes its first trip as a freight and express route.

PORTLAND, ORE.—Negotiations looking toward the consolidation of the three Portland railway systems are in progress. The scheme includes extensions, among them a mountain road.

Pennsylvania.

PHILADELPHIA, PA.—The building of the electric lines is progressing nicely without any particular opposition.

MAUCK CHUNK, PA.—J. H. Bonnell, of Allentown, has been appointed manager and superintendent of the Carbon County Electric Railway.

MANAYUNK, PA.—P. P. Liebert, general manager of the Wissackickon Electric Railway, says his line will be increased by two miles, electric.

ERIE, PA.—Major Hoyt, engineer of the Erie & Edinboro Electric Railway, says that building of the line will proceed at once. Contracts for roadbed have been let.

SCRANTON, PA.—General Manager Archer, of the Scranton Traction Company, says that increased car service is to be given to South Scranton, and that several other improvements will soon be made.

PITTSBURG, PA.—The Pittsburg, Beltzhoover & Knoxville Street Railway ordinance has been affirmatively recommended by the council committee on corporations. This line will build a bridge and dig a tunnel.

HARRISBURG, PA.—The Carbondale & Dundaff has as president, John J. Fahey, of Scranton; John P. Kelly, August Robinson and Joseph O'Brien, of Scranton, and Michael Moran, Carbondale, are directors.

McKEESPORT, PA.—White Electric Traction Company makes voluntary assignment to Robert R. Hammond and W. E. Tustin, who are the heaviest owners of the line. The road operates between Riverton and Duquesne.

MEDIA, PA.—The Chester, Media & Glen Riddle Electric Railway hold a meeting in the office of E. A. Price, of this city. L. D. Riddle, W. Burnley, Edmund Jones, et al., were appointed as a committee to consult council concerning franchise.

CHESTER, PA.—The Chester & Wilmerding Street Railway elects officers: President, Jas. C. McComb; secretary, E. T. Cooper; treasurer, J. Clayton Erb; directors, Wm. G. Hill, of Philadelphia; Congressman John D. Robinson, of Media, et al.

PITTSBURG, PA.—Public works committee recommend ordinance granting right of way to the Pittsburg & Mansfield Elevated Electric line. Those interested in the line are: E. Holbrook, president; Wm. Roseburg, treasurer; E. K. Morse, engineer; C. T. McDonald, secretary.

Tennessee.

MEMPHIS, TENN.—Calvary cemetery extension will be made this fall. It is probable that this line will be the beginning of several larger extensions.

Texas.

FORT WORTH, TEX.—L. R. Taylor appointed receiver for City Street Railway Company, on application of A. M. Carter.

DALLAS, TEX.—The district court issues restraining order against the city, from selling the track and franchises of the Dallas Consolidated on a tax sale.

WACO, TEX.—The street railway men of Texas met recently to organize the Texas State Street Railway Association. A. Zintgraff was temporary chairman. J. K. Urie, superintendent of the Austin Rapid Transit Company, was the originator of the idea.

Utah.

PROVO CITY, UTAH.—Marshall Norrell, on suit of A. A. Noon and D. P. Kellogg, sold these same men the Provo City Railway for \$2,800, subject to bonded debt. No plans so far made public.

SALT LAKE CITY, UTAH.—Popperton & Ft. Douglas Rapid Transit Company places property in hands of G. M. Downey, trustee, to secure issue of \$10,000 bonds to complete the road. E. F. Colburn and C. B. Jack sign mortgage.

Washington.

SEATTLE, WASH.—W. A. Underwood, agent of Central Trust Company, of New York, is appointed receiver for the Seattle City Railway Company, on petition of the Central Trust Company. Bill represents \$13,230 deferred payment of interest.

Wisconsin.

RACINE, WIS.—Belle City, manager, Allen Schewmon, is trying the Western Electric Heating Company's heaters. All lines now in operation will be continued.

EAU CLAIRE, WIS.—Peter Truax, local capitalist, buys the National Electric Manufacturing Company plant for \$7,500. Mr. Truax will operate plant if court confirms the sale.

MILWAUKEE, WIS.—A. W. Lynn, superintendent, has moved his office from the Colby & Abbott building to the Kinnickinnick barn. The auditing department goes to the new Insurance building.

Custer's Last Battlefield.

A visit to this spot, which is now a National Cemetery, is extremely interesting. Here, seventeen years ago, General Custer and five companies of the Seventh U. S. Cavalry, numbering over 200 officers and men, were cut to pieces by the Sioux Indians and allied tribes under Sitting Bull. The battlefield, the valley of the Little Big Horn, located some forty odd miles south of Custer, Montana, a station on the Northern Pacific Railroad, can be easily reached by stage. If you will write Chas. F. Fee, St. Paul, Minnesota, inclosing four cents in postage, he will send you a handsomely illustrated 100 page book, free of charge, in which you will find a graphic account of the sad catastrophe which overtook the brave Custer and his followers in the valley of the Little Big Horn, in June, '76.



INTERLOCKING GRADE CROSSINGS ON THE CHICAGO NORTH SHORE ELECTRIC RAILWAY.

THE first interlocking signals at a grade crossing of a steam and electric road, in which the trolley circuit is included in the interlocking mechanism, was put in operation November 5, on the two crossings of the Chicago North Shore Electric Railway and the Chicago, Milwaukee & St. Paul. It makes a collision nearly impossible. The general plan of the crossings is shown in our drawing. A section of trolley wire on the approaching track is separated from the rest of the line by section insulators. The feeder for these sections is lead through the signal tower, where it is connected with the interlocking mechanism. When the signals are at safety on the electric railway (that is, when the gates are up), the circuit is closed to this trolley section, and the electric cars are free to cross. At the same time, a

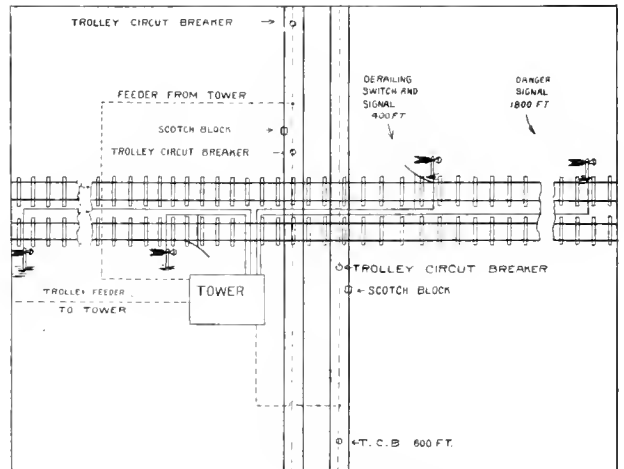

INTERLOCKING SYSTEM ON THE NORTH SHORE ROAD.

derailing switch is open on the steam road, about 400 feet from the crossing. Opposite this derailing switch is a danger signal, and at the distance of 1,800 feet is another semaphore signal, indicating whether the switch is open or closed. When the towerman wishes to close the derailing switch, the interlocking mechanism compels him to first open the trolley circuit, close the gates, and raise a scotch block on the street railway track. The trolley section cut out by the signalman was not made to extend across the tracks, because it was important that should a careless man change the signals when an electric car was on the crossing, it should have power to get off. There are thus three safety precautions on both roads. The gates, the scotch block, and the dead trolley section on the electric; the distant signal, the home signal, and the derailing switch on the steam. The only possible way to cause a collision would be for the towerman to throw the steam road signals to safety while a disabled electric car was on the crossing, and even in that case the engineer would probably have his train under control enough to stop. The idea of cutting out the trolley current is due, we believe, to Geo. Gibbs, the

mechanical engineer of the Chicago, Milwaukee & St. Paul. The switch and signals of the steam road are of the Union Switch & Signal Company's design.

It is useless to enlarge on the advantages of such interlocking crossing apparatus. That gatemen are exceedingly unreliable has been demonstrated time and again in this city, and anything of this kind that will take all responsibility from the gateman's hands cannot help being a financial benefit to both companies in the long run.

NEW PUBLICATIONS.

THE Peckham Motor, Truck & Wheel Company have issued a handsome catalogue, illustrating their different styles of trucks, both alone and under cars on various street railway lines.

IN THE CONSULAR REPORTS, for November, J. C. Monaghan, of Chemnitz, Saxony, says that power transmitted from waterfalls in Switzerland is more expensive than steam power, even with the high price of coal common there, and publishes extensive figures proving this statement.

ALTERNATING CURRENTS, by F. Beddell and A. C. Crehore, second edition, W. J. Johnson Company, New York. Price, \$2.50. The first edition of this well known mathematical treatise met with such a sale that the second is now extant. The changes from the first edition have been slight.

CONTINUOUS CURRENT DYNAMOS AND MOTORS, by F. P. Cox, W. J. Johnson Company, Limited, 41 Park Row, New York. Price, \$2. This is a book for students, giving the methods of designing and testing, as practiced

MOBILE'S NEW RAPID TRANSIT.

THE property of the Mobile Street Railway Company was turned over, on January 10, 1893, to the purchasers, under the foreclosure sale ordered by the United States District Court for the Southern District of Alabama. The property consisted of a lot of fairly passable mules, dilapidated cars, and worse track, together with a franchise from the city, conferring the right to change from animal power to electricity. One can form some idea of the condition of the tracks, when it is stated that some of the rails in use showed signs of having been used for armor on gunboats during the war. After some delay, caused by litigation and securing a new charter, the purchasers organized the Mobile Street Railroad Company, on April 8, 1893.

At this meeting the following officers were elected: James Stillman, president; F. J. Gasquet, vice-president; Wm. Bogert, secretary, and R. Semmes, treasurer and general manager.

On May 1 the work of tearing up the old tracks and replacing them with new was begun, and pushed until August 1. During this time nineteen miles of an old rickety horse road had been transformed into an electric. In rebuilding the roadway, 58½-pound girder and 45-pound T-rails were used.

The equipment of the road consists of twenty 16-foot closed cars, made by John Stephenson Company, mounted



R. SEMMES,
General Manager.

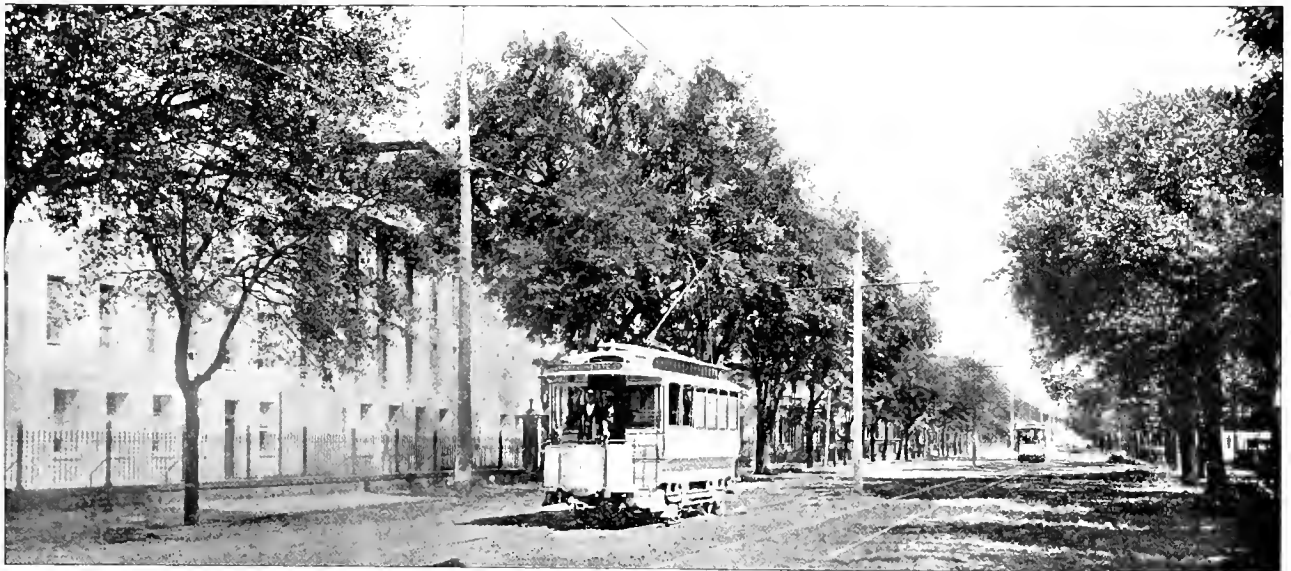

VIEW ON GOVERNMENT STREET, MOBILE, ALA.

in the factory. After a brief review of the electrical units and general principles of continuous current machines, the different points to be considered in designing such machines are taken up, chapter by chapter. The last two chapters are on steam engine testing,

on Baltimore Car Wheel Company's trucks, and twenty open 22-foot trail cars. Each closed car has one 25-horse-power General Electric waterproof motor. The station equipment consists of three 100-kilowatt General Electric generators, three 150-horse-power McIntosh &

Seymour compound condensing engines; three 100-horse-power Rantom's water tube boilers.

The steam plant was erected complete by Pierce & Miller Engineering Company, of New York. The car barn, power house, and work shops combined, is a brick building of ample size, not only to answer the needs of the present, but for several years to come.

for the past few years has been coming rapidly to the front as a port for exporting coal, lumber, etc. Last year it became a formidable rival to New Orleans as an importer of fruit.

The climate is delightful the year round, for while the summers are very long, still the heat is not intense, and in the evenings is tempered by delightful breezes from

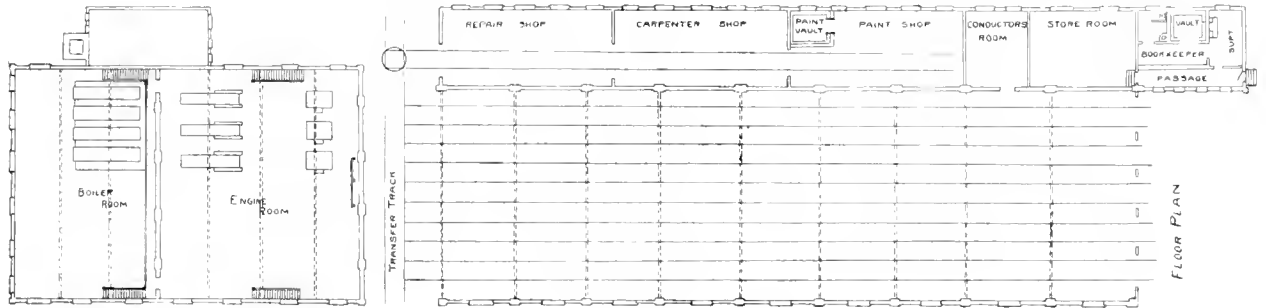

PLAN OF POWER AND CAR HOUSE, MOBILE.

The rebuilding of tracks and equipping the road and station was done by and under the supervision of the general manager, R. Semmes. The building of overhead lines and installing the electrical plant and starting same was done under the direction of J. F. McAviney, electrician and engineer for the road. Nearly all of the

the bay. The winters are simply charming, and are like far advanced spring in climates less favored. In fact, at this season of the year Mobile is a veritable "flower garden," and to the weary traveler from beyond Mason and Dixon's line, who have been chilled to the marrow by the wintry blasts of the north, it is a Garden of Eden.

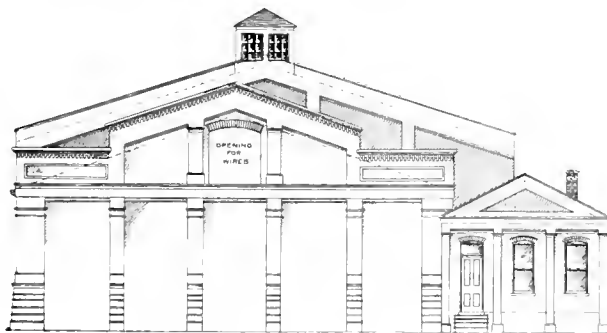

FRONT ELEVATION.

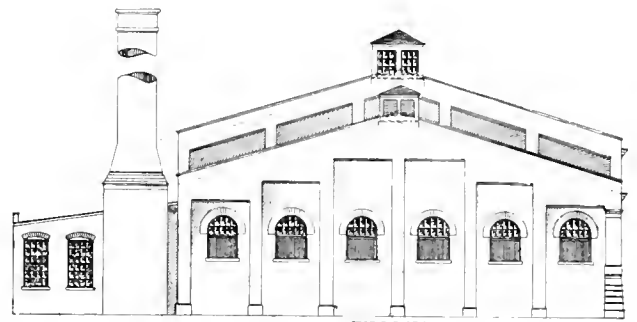

REAR ELEVATION.

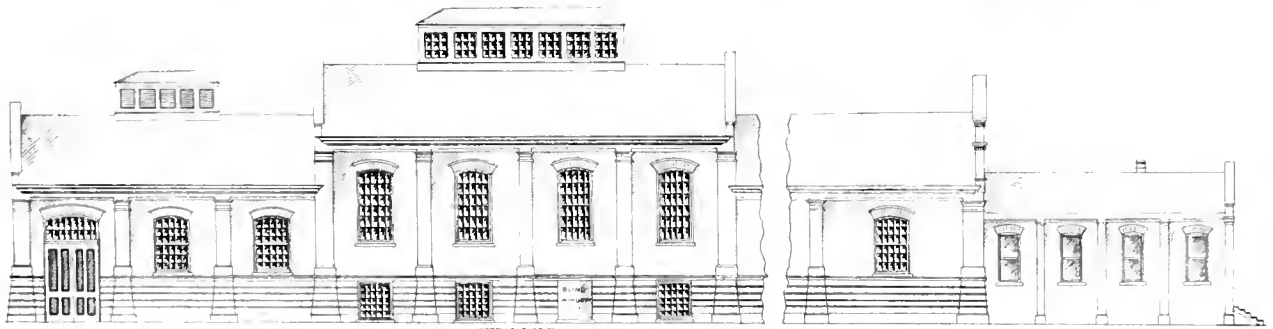

SIDE ELEVATION—POWER AND CAR HOUSE.

work of changing the road was done during the financial stringency now passing away, thus showing the faith the owners have in the outcome of Mobile.

Mobile is an ideal city, of forty thousand inhabitants, situated at the head of Mobile Bay. While in years gone by it was considered as one of the places to be shunned, on account of frequent visitations of yellow fever, it is now as healthy a place as can be found anywhere, and

A few of the architect's plans for the plant are here shown, not because they present anything radically new or wonderful in construction, but because they are excellently arranged for a moderate sized road, such as this. The barns are 192 feet long, and wide enough for five tracks. These five tracks each have a switch directly from the street tracks in front; and at the rear, in the space between the power house and car barn, is a trans-

fer table for moving cars to the repair shop track, or from one track to another at that end of the barn. The space between the barn and power house is roofed over. Ranged alongside of the car barn and separated by a fire

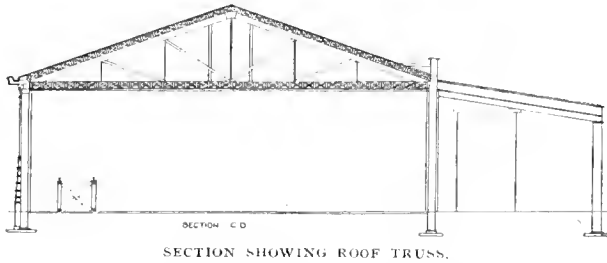

wall are the repair shop, carpenter shop, paint shop, conductors' room, store room, and offices, in the order named. In the barn one of the five tracks is raised, for facilitating ordinary inspection and repair, as the ground was so wet that pits were liable to be flooded. A siding of the L. & N. Railway runs in front of the boilers. The architects are McDonald Brothers, of Louisville, Ky.

The operation of the road has started out most auspiciously, and has every promise of a bright future. The company is fortunate in securing as manager one so well and favorably known to the members



J. F. MCAVINEY,
Electrician.



THE LINE CREW—MOBILE, ALA.

of the American Street Railway Association as Mr. Semmes, whose many friends in the fraternity will wish him unbounded success.

THE DRESSSEL DASH LIGHT.

AN attractive headlight for cable and electric cars is being manufactured by Geo. C. Dressel & Company, New York, which we illustrate herewith. The cut plainly shows the ease with which the lamp can be attached to either dash of the car. Its qualities of appearance and compactness are self evident, and users declare as to its effectiveness.

The success of the company has been such, in both its

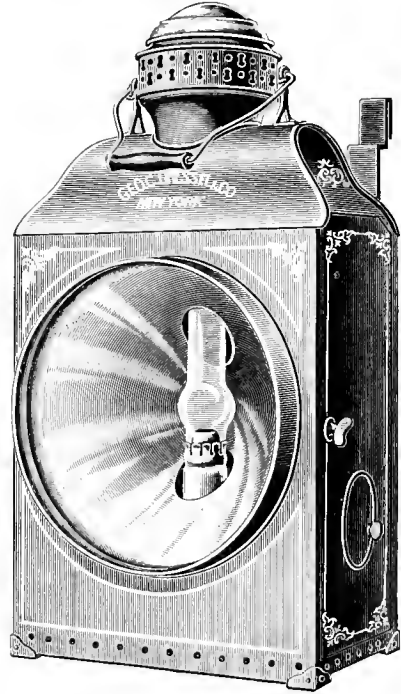

THE DRESSSEL HEADLIGHT

railroad signal lamps and street railway lighting, that additional manufacturing quarters have become an absolute necessity, and plans are now nearly completed for a new brick factory, which will afford over 50,000 square feet of working room. Their lamps are in use on a large number of street railways.

ALL HE WANTED.

ACITIZEN of Axtell, Ky., writes to the Louisville Street Railway, thus:—

"Mr. Street Car Agent. If you want a hand to Run a Street Car Let me know soon and Tell Me wether you will take Me or not if you will Take me let me know and Send the Prices of running your Street Car—Give me 18 ct an our and board me and Wash for me and Do all this right Soon."

In Boston, sacred Boston. Joseph Cooke calls it, charitable people dispense street car tickets to poor invalids, so that in lieu of carriage rides, the afflicted may ride about the suburbs free. The privilege is abused shamefully, however, and many able bodied rascals present the tickets. It is probable that they are obtained by highway robbery from the weak.

STREET RAILWAY PATENTS.

COMPILED BY THE STREET RAILWAY REVIEW.

ISSUED SEPTEMBER 26, 1893.

Trolley wire support, Lucius T. Gibbs, Milwaukee, Wis.....	505,457
Closed conduit for electric railways, Geo. W. McNear, Oakland, Cal.	505,605
Controller roller for electric cars, Ernest P. Warner, Chicago, Ill., assignor to the Western Electric Company, same place.....	505,687
Curve or crossing for cable railways, Edward W. Wallis, Philadelphia, Pa.	505,737
Car brake, William H. Hansell, Philadelphia, Pa.	505,763
Protector for pipes from powerful electric currents, Frederick Egner, St. Louis, Mo.	505,822
Conduit electric railway, Lawrence A. McCarthy, Brooklyn, N. Y.	505,841
Sanding device for railway cars, Millard Field, Taunton, Mass., assignor by direct and mesne assignments to the Automatic Railway Track Sander Company, of Maine.....	505,976
Railroad joint and support, etc., Hamilton E. Ford, Johnson, Pa., assignor by direct and mesne assignments to the Johnson Company, of Pennsylvania.....	505,978
Means for and method of securing metal objects together, Arthur J. Moxham, Johnstown, Pa.	505,988
Railroad rail support, Arthur J. Moxham, Johnstown, Pa.	505,989
Rail joint, Arthur J. Moxham, Johnstown, Pa.	505,990
Electric conducting bearing for trolley or other wheels, Elmer A. Sperry, Chicago, Ill., assignor to Frank R. Greene, same place.....	505,994
Controlling device for electric railway cars, William P. Coldren, Lebanon, Pa., assignor of two-thirds to Jacob M. Shenk, same place, and William H. Conrad, Reading, Pa.	506,001
Cable grip, Joseph S. Peden, Jersey City, N. J.	506,014
Trolley wire support, Maurice Hoopes and Oscar S. Hertzog, Lynn, Mass.	506,043
Electric railway system, Harry A. Lewis, Norristown, Pa., assignor of three-fifths to John T. Dyer, same place.....	506,124
Electric trolley wire crossing, Edgar P. Binford, Cincinnati, O.	506,149

ISSUED OCT. 10, 1893.

Means for supporting trolley wires, Samuel Harris, Cleveland, O.	506,317
Electric locomotive, Johan F. S. Branth, New York, N. Y., assignor of two-thirds to Edward H. Johnson, same place.....	506,358
Electric railway trolley, George H. Benjamin, New York, N. Y., assignor to Siemens & Halske, Berlin, Germany.....	506,463
Trolley, George F. Green, Kalamazoo, Mich., assignor one-half to Oliver S. Kelly, Springfield, Ohio, Martha F. Green, executrix of said George F. Green, deceased.....	506,492
Method of clearing streets or railroad tracks from snow, Richard A. Healy and Edward C. Cundell, Paterson, N. J., assignor one-third to John Hinchliffe, same place.....	506,497
Pilot shoe for snow melting machines, Richard A. Healy and Edward D. Cundell, Paterson, N. J., assignors one-third to John Hinchliffe, same place.....	506,499
Gas heated rotary brush for street cleaning machines, Richard A. Healy and Edward D. Cundell, Paterson, N. J., assignors one-third to J. Hinchliffe, same place.....	506,501
Trolley support for electric railways, Johan M. Anderson, Boston, Mass., assignor one-half to Albert Anderson, same place.....	506,617

ISSUED OCTOBER 17, 1893.

Fare register for street cars, Dennis J. Daly, Philadelphia, Pa.	506,845
Device for lifting traction cables, James B. Brown, Washington, D. C.	506,972
Grip for cable roads, William C. Coddington, Washington, D. C., assignor one-half to William W. Burdette, same place.....	506,979
Electric railway conduit, Henry H. Franklin, Brooklyn, N. Y.	506,933
Car truck, William H. Hansell, Philadelphia, Pa.	507,001
Combined petroleum and compressed air engine for tramways, Friedrich Neukirch, Bremen, Germany.....	507,032
Trolley wire hanger, Benjamin B. Betts, St. Louis, Mo., assignor of one-third to Emil A. Kolbe, same place.....	507,064

ISSUED OCTOBER 24, 1893.

Folding gate for car platforms, Walter S. Adams, Philadelphia, Pa., assignor to John A. Brill, same place.....	507,092
--	---------

Safety device for street cars, John M. Kelley, Rochester, N. Y.	507,138
Apparatus for controlling the application of electric currents, Robert Lundell, Brooklyn, assignor of two-thirds to Edward H. Johnson, New York, N. Y.	507,144
Safety fender for tram cars, Henry S. Robins, Philadelphia, Pa.	507,167
Motor truck, John A. Brill, Philadelphia, Pa.	507,207
Motor truck, John A. Brill, Philadelphia, Pa.	507,208
Trolley wire cleaner, Charles H. Thompson, Detroit, Mich., assignor one-half to George A. Sheley, same place.....	507,247
Switch clearing, salting and operating device, Charles H. Crosey, Brooklyn, N. Y., assignor one-half to Thomas T. Hayden, same place.....	507,261
Trolley wire insulator, Mowry S. Williams, Syracuse, N. Y., assignor one-half to Stewart Worden, same place.....	507,299
Closed conduit, electric railway, Robert Weir, Montclair, N. J.	507,339
Slot brake for conduit railways, William M. Hood, San Francisco, Cal., assignor to the Pacific Cable Railway Company, same place.....	507,366
Electric locomotive, James T. Wilson, Tyrone, Pa.	507,396
Conduit for electric railways, Geo. F. Green, Kalamazoo, Mich., assignor one-half to Oliver S. Kelly, Martha L. Green, Springfield, O., executrix of said Geo. F. Green, deceased.....	507,493
Guard for cable crossings, James W. Hintz, Baltimore, Md.	507,497

ISSUED OCTOBER 31, 1893.

Ice scraper for trolley wires, William Heston, Alliance, O.	507,539
Series-multiple electric controller, Arthur P. Knight, Boston, Mass., assignor to the Thompson-Houston Electric Company, of Conn.	507,547
Electric car brake, Joseph H. McEvoy, Waterbury, Conn.	507,589
Trolley wheel guard, John N. Akarman and Frederick LeNoir, Worcester, Mass.	507,641
Car fender, George Hipwood, Horatio C. Barrett and Stephen Porter, Boston, Mass.	507,654
Switch for trolley wires, Gustavus A. Huben, Springfield, O.	507,732
Motor, William J. Walker and Alexander L. Bedford, St. Louis, Mo.	507,769
Conduit railway conductor, John W. Grantland, Philadelphia, Pa., assignor to Gilbert L. Parker, same place.....	507,806
Car truck, John Taylor, Troy, N. Y.	507,855
Cable grip, John C. Dean, Millsborough, Pa.	507,887

A. MERTES MANUFACTURING COMPANY.

TO keep pace with the necessities of electric traction, no department has been more thoroughly awake than the manufacturers of motor repair parts. The result has been a successive improvement of all repairs, both as regards quality of material and workmanship. Roughly finished goods made of scrap material and put together by a blacksmith might once have served a purpose.

One of the most prominent features of modern repair facilities is that of motor pinions, and one of the prominent manufacturers of pinions is the A. Mertes Manufacturing Company, corner Isabella and Sandusky streets, Allegheny, Pennsylvania.

A. Mertes, the president of the company, as well as the inventor, is a mechanic of more than ordinary ability, and has directed his genius to the end of supplying the managers of electric railways, railway motor manufacturers and dealers in supplies, with an improved pinion, whose claims of excellence are the three enumerated necessities of such devices, strength, durability, finish.

The company has a complete system of machinery, made on a radically new basis, which enables the manufacturers of these goods to sell them at prices that are essentially correct.

One of the machines in the Mertes factory is capable of cutting and planing six gears at once.

PATENT OFFICE GOSSIP.

NUMBER 507,299, covers a trolley hanger, in which the insulating material is a stick of mineral rock in its natural state. This stick is represented by B in the illustration.

NUMBER 505,994, covers a trolley wheel bearing bushed with commutator brush carbon, with collars of plated carbon at the ends. See illustration.

NUMBER 505,457 is a trolley wire hanger, by a well known inventor. It is evidently intended to cushion the blows given the hanger and prevent the cracking of insulators so common now. See illustration.

PATENTS 506,497, 506,500 and 506,501, cover the process of removing snow from street railway track, by

construction. The trolley hanger is on a wire supported between the pole and the edge of the bracket, thus giving the spring of the span wire, with the strength and other advantages of the center pole. See illustration.

NUMBER 505,976 is a track sander, for use on trucks where only one pair of wheels are the drivers. The sand is automatically turned on when one pair travels faster than the other. This is done by having a band or belt running over drums on the two axles. The drum on the driving axle being free to turn, actuates the sander when the drivers slip.

THE METHOD of cleaning trolley wires, described in 507,247, is rather startling at first sight, but might prove a very efficient way of getting the ice off in extreme cases. It consists in a spring arm in advance of the

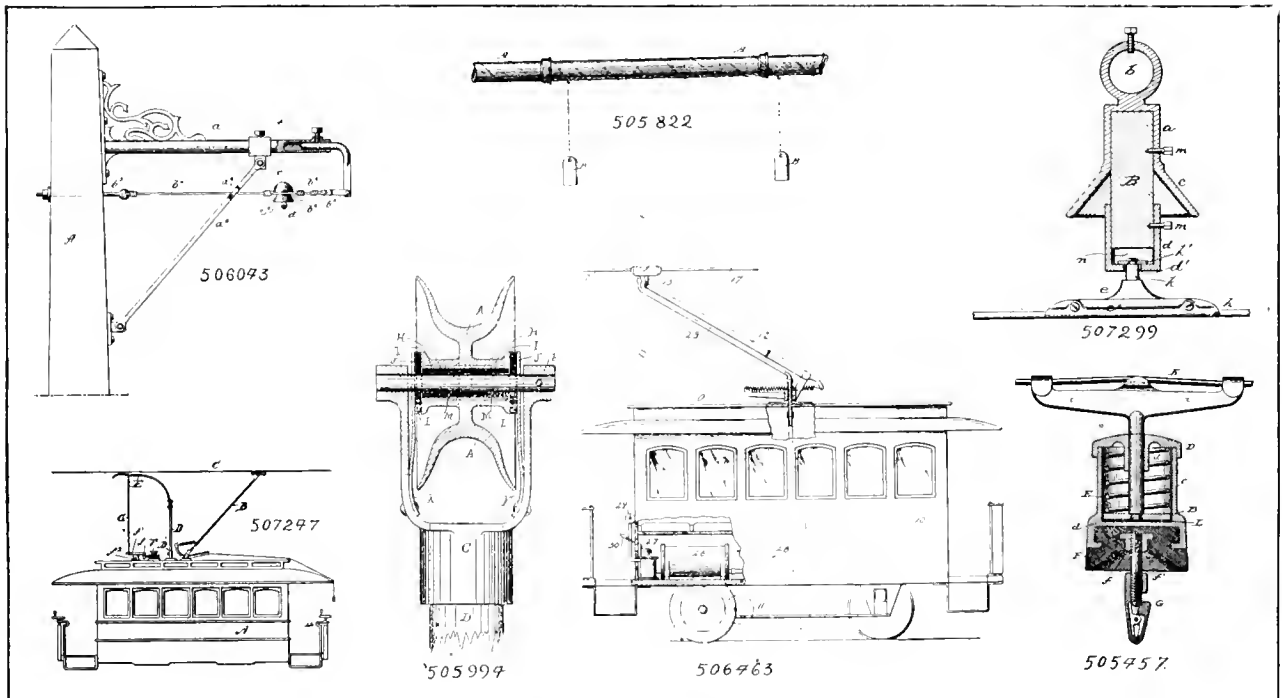

melting it with gas heated air or by gas heated brushes. It is to be feared that that the inventors have undertaken a rather large contract.

THE CAR controller, No. 506,001, was described in the REVIEW, of May, 1893. The brake and controller are operated by the same handle. Turning the handle one way from a central position puts on the brake and turning the other way starts motors.

NUMBER 506,463 would provoke a smile, were it not for the distinguished character of the assignees. The idea of a "liquid contact trolley," with a hose connection from the car for keeping it wet and lubricated, is rather ludicrous, to present ideas, but it possibly may not be so with high speed work that the future has in store.

NUMBER 506,043 is a trolley wire support, combining some of the advantages of both bracket and span wire

trolley pole, which is made to continually hammer the trolley wire. The reciprocating motion is furnished by a small electric motor.

NUMBER 505,822 is intended to protect underground pipes from electrolytic action, by winding them with a wire of better conducting material than the pipe and connecting this wire to earth-plates. See illustration. We fear that this would have the opposite of the effect intended, as the fact that the pipes were connected to ground plates would bring more current to them.

THE LACLEDE CAR COMPANY, of St. Louis, are busily at work on 200 closed cars for the Philadelphia Traction Company, and a recent visit of General Manager Robinson to the Quaker city resulted in an additional order of 50 open cars for early spring delivery. All of which is highly complimentary to the management and workmanship of the Laclede company.

ECHOES FROM THE TRADE.

THE GENERAL ELECTRIC passed its November dividend.

SARGENT & LUNDY, Chicago, have taken the agency for the Climax steam generator, made by the Clonbrook Steam Boiler Works, of Brooklyn.

THE HOPPE'S MANUFACTURING COMPANY, Springfield, O., has just sold a 1,000-horse-power feed water heater and purifier to the Calumet Electric Railway, of Chicago. W. S. Love, of the "Rookery," captured the order.

THE R. D. NUTTALL COMPANY has taken up new quarters at suite 911 Monadnock building, Chicago, where, in finely furnished rooms, they will receive their friends through J. M. Denniston, western representative.

HARRISON & CAREY are now at 1137 and 1138 Monadnock building, where the friends of the great triumvirate of Harrison & Carey and Bemis may find them ready to equip a road or sell a trolley wheel or a truck.

ARTHUR E. GEORGI, selling agent for the Cincinnati Novelty Manufacturing Company, spent several days in Chicago, this month, meeting street railway men, and having good success with the specialties manufactured by his enterprising house.

THE OTTAWA CAR COMPANY, of Ottawa, Canada, has been manufacturing cars now for some time, and is at present filling large orders for Montreal, Toronto, Winnipeg, and Ottawa. Ahearn & Soper, the well known electrical dealers, are interested in the company.

GEO. O. FAIRBANKS, long and favorably known as western manager for the Westinghouse Electric & Manufacturing Company, has connected himself with the Railway Equipment Company, to take charge of the Holmes, Booth & Haydens wire agency, lately given to that company.

THE SHIFFLER BRIDGE COMPANY, of Pittsburg, has received the contract for a large plate girder viaduct, to be erected at South Omaha, Nebraska, for the Chicago, Burlington & Quincy Railroad; also for a lot of iron columns and girders for the Havelock boiler shop, of the same company.

THE NEW HAVEN CAR REGISTER COMPANY, of New Haven, Conn., are proud of the award made to the New Haven Fare Register by the World's Columbian Exposition, receiving the only medal awarded stationary registers. They report a very active interest in both this and foreign countries since the Exposition.

THE GENETT AIR BRAKE COMPANY has received additional orders for air brake equipment for 104 cars from the Third Avenue Railroad Company, New York City; also for thirty cars from the Buffalo City Railway Company. These orders are in addition to the brakes already delivered and now in use upon these lines.

WILLIAM GOLTZ, manufacturer's agent, Milwaukee, is doing a thriving business even in these hard times, and has bright prospects in several lines of steam and electrical equipment. Mr. Goltz was formerly a general electric expert, and is well versed in various lines.

THE COMBINATION CAR COMPANY, of Boston, which has been organizing for some time to push the sale of their combination summer and winter car, has now given the exclusive right to make and sell, to the Laconia Car Company, of Laconia, N. H., which will at once begin active operations for its introduction to the trade.

HORSBURGH & SCOTT, manufacturers of gears, pinions, and pressed steel trolley switches, of Cleveland, O., report great success with their specialties. Their shop is running full time on gears and pinions, and the prospect is flattering for an excellent trade. Great success has attended the introduction of their pressed steel trolley switch.

THE MORIN CLIMAX WATER TUBE BOILERS, at the Exposition, are being tested by George H. Barruss, to determine the relative economy of fuel oil and the various coals commonly used in steam making. The builders of the boilers are making the test at their own expense, and are, we are informed, the only boilers being so tested.

THE GRIFFIN WHEEL & FOUNDRY COMPANY, Chicago, Ill., received the medal from the World's Columbian Exposition on chilled iron car wheels, for "excellence of design," and furnished Columbian Exposition wheels of all sizes, from the rim of the Ferris wheel, 264 feet in diameter, down to the wheels for the Movable Sidewalk, 18 inches in diameter.

THE STANDARD RAILWAY SUPPLY COMPANY, Monadnock building, Chicago, are extremely busy filling orders for their standard car stoves. Among shipments during the past ten days were one entire car load to the Buffalo Railway Company, and thirty stoves to the Lynn & Boston; also to St. Louis, Milwaukee, Detroit and a number of smaller cities both east and west.

THE R. D. NUTTALL COMPANY, of Allegheny, Pa., have increased their stock of standard gears and pinions and thoroughly overhauled their machinery, so that they are prepared for prompt shipment of orders during the winter. Their new trolley harp, for which several orders were received on first sight at the convention, is designed to avoid striking switches in passing low places in the wire.

THE GRAHAM EQUIPMENT COMPANY, of Boston, writes: "Orders have flown in so largely since the convention, that we have arranged to start a plant in Philadelphia, and also have an office and a representative there. We are building trucks for Grand Rapids, Pitts-

burg, and South Braintree, and are negotiating with half a dozen western roads; and also with a Canadian Street Railway."

THE CALUMET ELECTRIC STREET RAILWAY COMPANY has awarded C. E. Loss, of Chicago, the contract for the paving and rebuilding of the South Chicago avenue line, six miles in length; also the changing of the line on Ninety-fifth street and at Burnside Crossing, to move the traffic on Ninety-third street, through the new subway. They have also awarded him the balance of their overhead work.

THE SAFETY BRAKE SHOE COMPANY, of Boston, whose advertisement will be found in our columns, reports a constantly increasing demand for their brake shoes, especially by electric street railways. Their shoes are in service on over one hundred such roads, the first orders usually bringing duplicates; some of them are on a liberal scale, with the assurance that they are to be adopted as their standard shoe, the braking and wearing features proving so favorable.

THE BATES MACHINE COMPANY, of Joliet, report having run three-fourths their usual force right along and find a gradual increase in inquiries and orders. They will soon be running full time and force as before the depression. Among late shipments are noted a 300-horse-power Bates-Corliss, for the West Side Street Railway, of Elmira, N. Y., the Kentucky Union Railway Company, Lexington, Ky., C. C. C. & St. L. Ry., Co., Cincinnati, and 1,500-horse-power to various manufacturers.

THE GARTON-DANIELS ELECTRIC COMPANY, of Keokuk, Iowa, has just completed one year's business, and in closing the books, find results most gratifying. During this time they have placed Garton Lightning Arrestors on one road to the number of 284. The road referred to is the Cincinnati, Newport & Covington Street Railway, of Cincinnati, Ohio. Next spring they intend to bring out a few new specialties, for which they hope for a record like that of the Garton Arrester. These specialties are now being developed.

SARGENT & LUNDY, 1421 Monadnock building, Chicago, have recently taken the western agency of the Crocker-Wheeler Electric Company, of New York, and are now prepared to supply this well known type of stationary motor and other electrical apparatus. A new machine tool construction, especially adapted for use in repair shops of electric railway and power plants, is also being introduced in the west by this firm. In these tools the motor is built in as a part of the machine, making a directly connected machine tool, which can be moved about the repair shop or power station with ease and started up wherever there are conductors.

P. S. BEMIS, the genial and successful western representative of the Peckham Motor Truck & Wheel Company, has removed his Chicago office to 1137-1138 Mon-

adnock building. The suite commands a magnificent eastern view and is furnished after the best plans of Mr. Bemis, whose taste for the beautiful is well known. Among recent orders captured by Peckham's people are orders both new and second from the Broadway Cable, of New York; the Brooklyn Heights, of Brooklyn; the Jersey City & Bergen, the new road at Atchison, Kansas; the Cincinnati Consolidated and the Pittsburg & Birmingham Traction Company, of Pittsburg.

THE CONSOLIDATED CAR HEATING COMPANY, of Albany, N. Y., reports application of their electric heaters with regulating switch to cars in twenty-nine cities and towns throughout the United States and Canada. Among these towns are: New York, Rochester, Albany, Elmira, Yonkers, Hudson, Jamestown, Rondout, Chicago, (three roads), Pullman, Cleveland, (two roads), Northampton, Holyoke, Haverhill, North Abington, Brockton, New Haven, South Norwalk, Newark, Philadelphia, Allentown, Akron, Piqua, Dayton, Omaha, and Montreal, Toronto, Hamilton, and Niagara Falls in Canada, with second orders from a number of old customers.

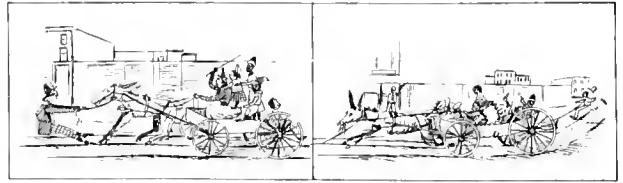

A NEW USE FOR THE CABLE.

—Harper's Bazaar.

THE creditors of the Gilbert Car Company, which was dissolved on August 16, last, are asked to assign their claims to creditors' committee, consisting of Henry S. Hale, chairman, 48 North Sixth street, Philadelphia; Wm. E. Uptegrove, Chas. R. Flint, James L. Howard, Wm. Kemp, and Ralph W. Kirkham. In case all the creditors agree to this, the Gilbert heirs, whose claims are preferred, being in the shape of a mortgage debt, will likewise assign their interest, in which event it is expected to continue the works under the direction of the committee, until such time as the profits shall have wiped out the debts, or the business and works can be sold advantageously.

THE CHARLES MUNSON BELTING COMPANY reports trade gradually improving and orders increasing. They have recently received a number of large contracts for the Eagle belt, a pure oak tanned, strictly short lap belt, with an established reputation. The Munson belt has been a leader for many years, and can always be depended on to do its work. It is not blackened, and comes out with a pure oak tanned color, to show that there is no percentage of hemlock tannage in the leather. This company received award at the World's Columbian Exposition for pure oak tanned leather suitable for belting purposes. This is the second medal that has been awarded the Groetzing leather.

A VISIT to the office and shipping room of the Railway Equipment Company, Pullman building, Chicago, shows that at least as far as this pushing company is concerned, the revival of trade is a reality. Mr. Mason, the general manager, states that the trade of the company in general electric railway supplies is steadily increasing and new customers are being added daily to their already long list. The company has made for itself during the last five years an enviable reputation for honorable dealing and superior material. "The well-known type G. material," says Mr. Mason, "gains in popularity daily and the company is in receipt of the strongest testimonials from a host of desirable customers."

RAN 35,000 MILES.—The rawhide pinions manufactured by the New Process Rawhide Company, Syracuse, N. Y., have repeatedly made some most excellent records. The following letter from superintendent J. K. Urie, of the Austin, Texas, Rapid Transit Railway, is well worth reading. Under date of October 28, he says: "Two of your rawhide pinions, (Thomson-Houston S. R. G.) have been in constant service on one of our motor cars since the 26th day of January, 1893. This car has run a little more than 35,000 miles without change of gears or pinions, and we believe the pinions are still good for several thousand miles. The writer considers your pinions superior to any he has used."

THE CROSSLEY BRAKE, Cleveland, continues to win good words from users. General Manager Stanley, of the Cleveland Electric, under date of November 1, says: "The brakes you put on our cars about nineteen months ago, are doing good service. They never fail. Their simplicity will place them in the front ranks as soon as they become known." Superintendent Bowen, of the Chicago City, says: "After several weeks trial of your brake on one of our motor cars, I can say that its simplicity, low price and cost for repairs, must commend it to all street car managers." Superintendent Mulhern, of the Cleveland City, also says the brake is giving the best of service on both their cable and electric cars.

THE STANWOOD STEPS, built by the Stanwood Manufacturing Company, Chicago, are a strictly reliable and honest step, if they are "all steel," and have a proud record on several hundred roads, where "once used" they are "always used" thereafter. They are now practically perfect, and have nothing to be desired which is within the range of the possible. Recent orders for their improved, all steel step, include, among other companies, the Pullman Palace Car Company, St. Louis Car Company, Lamokin Car Works, Omaha Street Railway Company, Akron Street Railway Company, Cayadutta Electric Railway Company, South Chicago City Railway Company, Calumet Electric Railway Company, Youngstown Street Railway Company. President Stanwood has spared neither time or money in the improvement of this step, and the voluntary testimonials from users would fill a large book.

OUR DICTIONARY OF TECHNICAL TERMS.



A FARE BOX.



BEHIND TIME.

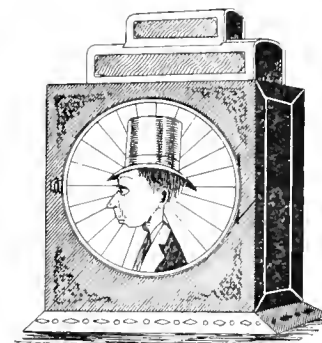

A HEADLIGHT.



A GROUND RETURN.

THE ALTOONA MANUFACTURING COMPANY, of Altoona, Pa., although long and favorably known in eastern power circles, have not until lately begun to push their engines into the western territory. The M. A. Green automatic engines built by the company have, however, of late been introduced to the western users and of course to that user par excellence, the street railway plant. The City Passenger Railway Company, of Altoona, has three 125-horse-power and one 250-horse-power units operating. They have been in constant use for nearly three years without shut down. The Altoona & Logan Valley Electric has two 300-horse-powers operating successfully in their plant; and the Johnson Steel Company, of Johnstown has two 150's operating its electric welding machines. The Pennsylvania railroad is a large user of the Green engine, both for its electric departments and its shops. The Punxsutawney, Pa., Street Railway has two 125's and the light plant uses one 125-horse-power. Besides these, in Pennsylvania alone, thirty other power plants are equipped with the Green engine, using them for every purpose where absolute reliability, strength and quickness of government and close regulation is necessary. This includes electric light plants, coal mine shafts, saw mills, incline planes, hoisting and private light installations. The buyers are such as the Cambria Iron Company, the Berwind-White Coal Company, the Edison light plant at Altoona, and other large, experienced and critical buyers. The record of the Green should be investigated by every street railway man contemplating new power.

VISITORS to the boiler room at Machinery Hall, during the last two weeks of the Exposition, noticed the following conspicuously displayed on a placard, hung on the boiler front of the Babcock & Wilcox battery. As we are informed it represents the sentiments of nearly all the boiler exhibitors, the card is herewith printed in full:

SPECIAL NOTICE.

These Boilers Have Received No Awards.

Why? Read! Learn!

"We were informed that it was the purpose of the jury, to make awards on boilers based entirely upon the written statements of the exhibitors of boilers, without tests or any personal knowledge in the possession of said jury concerning the comparative construction, operation, economy, or durability of said boilers.

We were asked to make such a statement, and were informed that all other exhibitors of boilers had been requested to make a like statement of their claims for the consideration of the Jury of Awards.

Believing that an award, based on such insufficient knowledge on the part of said jury, could be of no practical value, and notwithstanding the expense incurred by this company in making an exhibit, we respectfully declined to make any such written statement for the purpose of receiving an award upon our boilers.

While we do not in the least envy those who have, upon such knowledge by the jury, been awarded premiums, we are equally content to stand upon the record, without an award based on such a knowledge of our goods."



A CONVENTION REMINISCE.

GEO. N. CRAWFORD and E. Stockwell, as Geo. N. Crawford & Company, 1136 Monadnock block, have become western agents of the Watertown Steam Engine Company, besides doing a general business as consulting and constructing engineers. The gentlemen are well known, both as to ability and personal worth, and have good prospects for a successful introduction of the already well known Watertown engine.

A FRENCH STREET RAILWAY STRIKE.

A FRENCHMAN never gets excited without terminating his mental agitation by a physical ebullition. November 6, the ill feeling of the horse car employes toward the employing companies ended in a first class riot. The stables of the companies were immediately surrounded by troops to protect the proprietors, but the rolling stock and horses on the lines were at the mercy of a mob of employes, their friends and sympathizers. This mob, numbering 5,000, gathered in the famous Cannebiere, and overturned fifteen cars which the company attempted to run. One of these was then fired with petroleum, amid cheers and yells. This was followed by the tearing up of some sections of track, and the burning of a few more cars. Altogether sixty cars were badly wrecked or burned, police interference amounting only to the arresting of sixty rioters. The companies' directors accused the mayor and municipal authorities of inciting the trouble. At this juncture these worthies left the council chamber in an angry mood. Women took active part in the rioting, surrounding the cars and driving off the drivers that remained faithful to the company. One of the sympathizers of the rioters placed a bomb on the track, which was exploded by a passing car. The mob immediately made a rush for the fellow, who saved himself by surrendering to the police. No damage was done.

November 8 the cars were running again under military protection, mounted gens-d'armes patrolling the whole city at intervals of sixty yards. The companies claim \$80,000 damages from the city, for loss of rolling stock and business during the riot.

The strikers wrote James Gordon Bennett, of the New York Herald, asking assistance, and recalling the aid given the Parisian strikers.

THE LACROSSE RAILWAY OPENS TO TRAFFIC.

A MATEUR minstrels at LaCrosse, Wis., will have no horse car joke hence forward and forever, and all because the LaCrosse City Railway Company, on October 28, made its formal opening trip.

Superintendent Valier began operations by hanging the stars and stripes to the trolley pole, then Clement Smith, the electrical engineer, grasped the handle and away sped the car with the following party on board: President B. E. Edwards, Secretary West, Superintendents P. Valier and George Smith, Electrician J. Johnson and the usual representation of city officials and local press.

The line is seven miles in length, with a total trackage of ten miles. Nine cars will be run at eight miles an hour.

WARREN H. CARR, of the Bath, Me., Street Railway, is perfecting a track cleaner, which uses rubber or old belting instead of steel plate.



Young Mr. Volt sat on a wire,
And said, "I think ampere,
To anything electrical
Watt I can see 'round here."

Just then the trolley wheel came by,
And said, "Young fellow, come,"
And as the motor used him up,
He wished he'd staid at ohm.

MELODIOUS DEATH KNELLS.—"I don't see no use in havin' sich horrid soundin' gongs on these here cars," said the old lady from the country, in the hearing of an Indianapolis Journal reporter. "Well, madam," replied the ever-ready conductor, "when we started out we did have some real sweet soundin' gongs, but people got so stuck on the sound that they'd stand right on the middle of th' track to listen to 'em, wich same habit killed from four to eight folks a day, so we had to take 'em off." And just here, the voracious conductor bit off another piece of plug and rang up a fare.

SAD BUT TRUE.—The beautiful young thing boarded a Fullerton and Webster trailer. Her eyes were a cerulean blue, her cheeks were pink with the glow of health and her features as regular as the click, click of the wheels on the rails. The old man who sat opposite wore billy goat chin whiskers and a fine expansive smile. He turned and said to his neighbor, "that's a pretty face, how modest and refined she looks. Every feature betokens breeding and culture." The girl blushed. Her lips moved. The old man bent forward to hear. He heard. This is what she said: "Say, old feller, your whiskers is full of hair." The funniest part of this story is that it's true.

EVIDENTLY A DESPERATE CHARACTER.—It was a West Side car, and the talkative, healthy old gentleman was going home. He was stout, florid, with short-cut grey hair, and very self-satisfied. The effeminate degeneracy of modern young men was his theme. "Look at me!" Sixty years of age—never had a day's illness in my life, and can do my five miles an hour! Why? Because from when I was twenty to when I was over forty I lived a regular life. No delicacies for me! No late hours! Every day, summer and winter, I went to bed at nine, got up at five, lived principally on porridge; worked hard—hard, mind you—from eight to one, then dinner, then an hour's walking exercise, and then—"Beg your pard'n, gov'nor," interrupted a young working man sitting opposite, "but wot was you in for?"

AN OLD LIE IN A NEW DRESS.—"Had a 'strordinary 'sperience last night," said a Buffalo, N. Y., conductor to nobody in particular. "Took on a woman at Blank street, and forgot to let her off at Tupper. When we got past Tupper two blocks, she grabbed the rope and rung up thirty-six fares 'fore I cud stop 'er." The passenger groaned. "Tell us somethin' fresher or keep still," said the bad man from Tuftown. "Wait till I git through," retorted the conductor. "When I told her she'd have to pay them fares, she grabbed her purse and give me \$1.50." "Honest woman," said the little man in the corner. "You bet," assented the conductor, "specially as them fares were on the 3-cent dial, and I cleared seventy-two cents on the deal." And the honest conductor absently punched a transfer two hours late.

MUST HAVE BEEN AN HEIRESS.—She had dropped something. That was evident from the startled and pained look that flitted across her face, as she shut up her pocket book and drew on her glove with careful hand. Then she stooped over and pulled her skirt to one side, and gazed piercingly at the mat on the car floor. Her two next neighbors, both women, did likewise, and the tall man who hung to the strap moved one of his feet and then the other very carefully. "Lost something, lady?" inquired the conductor, as he joined the search, in company with the small boy across the aisle, and the fat man, who puffed and blew as he bent over to examine his portion of the floor space. "There it is," she shrieked joyfully, "there!" and as the young man with a red necktie handed back a short pencil stump, the crowd sighed a sigh of relief, and the conductor retired to commune with himself.

HOW SHE WORKS IT.—Some women rush into print when they can't get a seat on a street car. Others say mean things or stare a man out of countenance to obtain this end of comfort. A New York girl has a new method that she says is superior to all others. "How do you manage it?" asked an innocent. "Well," replied the Harlem maid, "I've discovered that if there's anything in the world that a man is particular about, it's his feet. If it happens to be a neat one, he is prouder of it than a woman. So when I enter a car I take a position near the middle, acquire a strap and survey the pedal extremities. I select the largest and most unpolished boots in the row, and fix my eyes on them. I look at the feet. Then I raise my eyes and scrutinize the face. Suddenly I put on a surprised expression, as if saying, 'Impossible that such a handsome man should have such a pair of feet.' I look pityingly at him, as if thinking, 'poor fellow, there must be something the matter—he may have sprained his ankle or—something.' The victim can't stand it long. He wriggles and twists; crosses and uncrosses his feet; looks at them in surprise and disgust, and finally adjourns to the front platform on pretense of smoking. Then's my chance. I drop into the seat—so—" and the fair creature slumped into her victim's place and innocence stood up for four miles.

FOREIGN FACTS.

BERGEN, in Norway, is undergoing the throes of an electric railway project.

TRAMWAY employes on the North Edinburgh line get \$4.32 per week for the first three months, which is gradually raised to \$6 after six months service.

EVEN the much vaunted London omnibusses are not the safest places in the world, one patron complaining that three times within the past six months members of his family have had their purses cut from their garments and stolen.

HERR BRAUNSELS AND DR. SIEMENS, of the Deutsche Reichsbank, spent the last week in October inspecting the Milwaukee Street Railway plant. The Reichsbank is said to hold \$40,000,000 in Northern Pacific stock.

THE LUHRIG GAS MOTOR is attracting considerable attention in England. Major-General Hutchinson, of the all-powerful board of trade, inspected one at Croyden recently and passed his approval upon it. It is a German type and similar to the Conelly.

THE double deck car for which the American daily press calls so loudly is not in favor, during damp weather, in England. Fully half the Pro Bonos, Abused's, and Equal Right's communications in the English press call for something to keep the garden seats dry and habitable.

THE METROPOLITAN RAILWAY system, of Berlin, will be supplemented by an electric line, the general plans of which are to be executed by Siemens & Halske. Part of the new supplementary line will be on a viaduct and the balance in a tunnel. The cars are to be double truck, with an electric motor on each truck.

A CONDUIT accident of rare brilliance recently occurred on the conduit electric line at Buda-Pesth, when a careless teamster smashed a carboy of benzine on the slot rail. The contents poured into the conduit, where ignition by the current sent up a brilliant and dangerous flame. Fortunately the benzine lasted less than ten minutes, and the only damage done was the slight roasting of a passing car.

LORD KELVIN, formally inaugurated the electricity works recently erected for the corporation of Blackpool, October 13. The Blackpool tramway built eight years ago has now become antiquated and hardly a commercial success. It will be superseded by some better and more recent method of operation. The electricity works comprehend the entire electrical lighting and power of Blackpool, which has a sea front of over three miles.

THE corporation tramway depot, at Coplawhill, Glasgow, Scotland, has had its corner stone laid with due speech and applause. The private corporation was duly ridiculed, and the Bellamy-esque street car pictured in

glowing colors. It was even hoped by one daring speaker that some other motor than the horse might be possibly used at some future date. This is the twenty-second year of street cars in Glasgow, and really time that those horses that have attained their majority should be sent out to grass.

THE VOGAN BROTHERS ADJUSTABLE VESTIBULE.

IN addition to the illustrations in our last issue, of how the vestibule platform law in Ohio can be complied with, and an illustration elsewhere in this number, we present herewith an engraving of the simple and inexpensive plan, the design of Vogan Brothers, of the Vogan Brothers Manufacturing Company, New Castle, Pa.

It consists of a paneled front with three windows, the middle one of which is in two frames, the upper of which slides from the top down; the others are fixed. Two iron braces extend upwards and outwards from the plat-

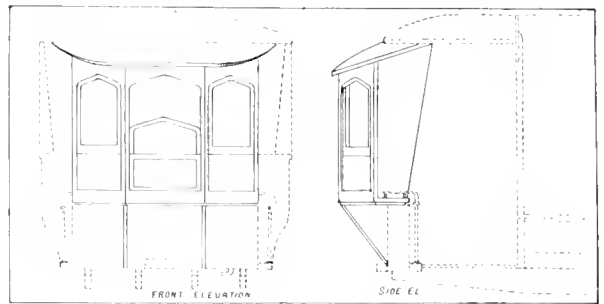

THE VOGAN BROTHERS VESTIBULE.

form sill and support the front, which is carried straight up and joins the hood, to which it is fastened. A side protection of canvas or other suitable material affords protection on either side of the platform, but does not interfere with passage in and out.

Provision is also made for a signal lamp, to be placed behind the lower middle window frame, which serves the two-fold purpose of a signal, and, by its heat, to keep frost from forming on the window, so as to obscure the view. The vestibule front is strong and durable, and quite light, weighing only seventy-five or eighty pounds complete. The Youngstown, Ohio, road is equipping with these vestibules, which are attached without much labor or loss of time.

C. D. MORSE & COMPANY, of Millbury, have reason to be proud of the elegant new cars built by them for, and recently delivered to, the Worcester, Leicester & Spencer Electric Railway. The cars have attracted universal attention, and are compactly and strongly built.

SYDNEY SHAW, late general manager of the Park City Street Railway, of Parkersburg, W. Va., is fighting a legal battle for interests he claims in the Cleveland, O., lake front, now used by certain railroads. The Shaw family is wealthy and respected, but as the claim is for \$2,000,000, it is worth a fight.

THE SCARRITT CAR SEAT COMPANY.

REVIEW readers will remember, perhaps, a brief mention made several months ago of the World's Fair exhibit of the Scarritt Car Seat Company, of St. Louis. We are able this month to illustrate that attractive space.

The space was in the form of a raised platform, roofed over in the shape of a modern street railway car, handsomely decorated and surrounded at the platform with a series of the trade marks of the numerous steam railroads using the Scarritt goods.

The collection of seats shown embodied every style and design of car seats, from the plainest rattan standard seats for suburban passengers, to the most elegantly



SCARRITT CAR SEAT.

upholstered resting places for the millionaire in his private car, or that American prince, the traveling man, in his parlor car.

The Scarritt goods have an international reputation, going into a dozen foreign countries, besides being extensively employed on American roads.

The street railway line into which the Scarritt Company is now going, is up to the standard maintained for

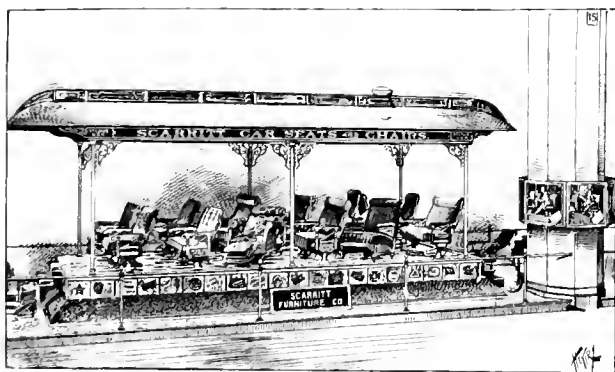

SCARRITT COMPANY'S WORLD'S FAIR EXHIBIT.

its steam road goods. This is sufficient recommendation, and the number of street railways using them may vouch for the rest.

The Lindell Street Railway, of St. Louis, recently placed an order with the Scarritt Company for the equipment of thirty-eight cars, with the Scarritt adjustable seat, which is 31½ inches wide over all, with a back 20 inches high, seat cushion 17 inches, and spaced 33 inches between centers.

THE NORTH CHICAGO CAR BARN FIRE.

CHICAGO'S car barn fire record is added to by the burning of the North Chicago Street Railroad Company's barn, at the corner of Racine avenue and Center street, on the morning of November 9. The building was a two-story brick structure, fronting 125 feet on Center street and 100 feet on Racine avenue. The dense fog which covered the city at that time made the firemen's rescue work harder and the flames gained such headway that in spite of a 4-11 call the outer wall only escaped the ravages of the flames. There were stored in the barn at that time fifteen Connelly

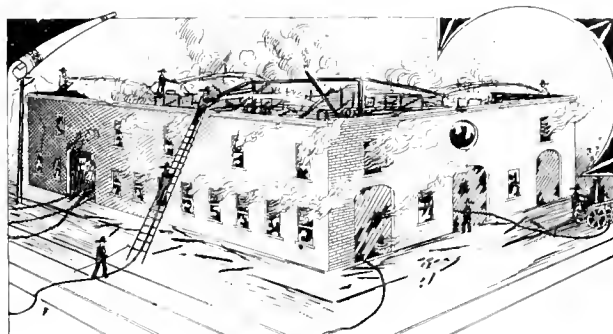

BURNING OF THE NORTH CHICAGO CAR HOUSE.

gas motors, sixteen closed and twenty-two open cars. The tanks of all the motors but one had been discharged before bringing them into the barn. No. 13, was the exception. A careless motorman explored a smell of escaping gas with a lighted match. A flow of gas was ignited from the match, an explosion followed and the car barn was soon on fire. The flames spread with startling rapidity and the employes were able to save only six of the motors. The remainder was a total loss, to the extent of \$50,000, fully covered by insurance in twenty-five companies.

The horse barns immediately opposite the car barn were saved by the efforts of the firemen.

BROOKLYN'S BIG CHIMNEY.

BROOKLYN City's power house, now building at Davidson avenue, will have a land mark of a chimney. It will be 300 feet high and will have a flue diameter of 17 feet. It will be completed December 1, and use 2,000,000 brick in construction. The famous Glasgow stack is 425 feet high, but only 9 feet in diameter. The Fall River Iron Works has a 350 foot 11 foot flue chimney, costing \$40,000, and Frieberg, Saxony, has a stack 452½ feet high, with a diameter of 15.7 feet. It also cost \$40,000.

SANBY'S QUERY TO INGERSOLL.—This beautiful song (words and music, regular sheet music size), will be mailed to anyone enclosing 5 cents in stamps to D. G. Edwards, general passenger agent, C. H. & D. R. R., Cincinnati, O.

A TALK ON "SHORT LAP."

WHAT strictly short-lap belting is, was recently explained to a REVIEW man by the manager of the Charles Munson Belting Company, of Chicago, makers of the celebrated "Eagle" brand of pure oak leather belting.

"You see," said the gentleman, picking up a picture

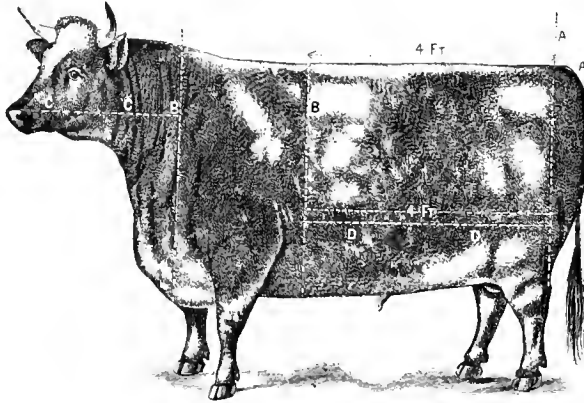

FIGURE 1.

of a large and shapely bovine, "that only so much of the leather can be cut from a hide, free from flank and shoulder pieces. Animals vary in size and weight materially, but the distance from the base of the spine to point directly over the rear point of the shoulder blade is

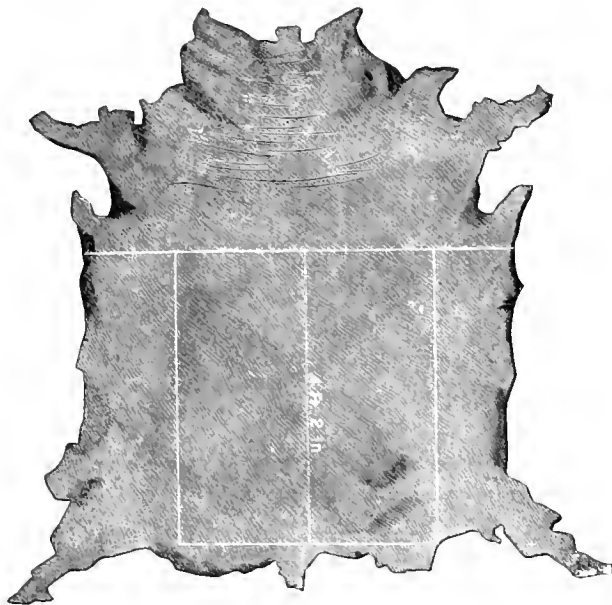

FIGURE 2.

no longer on an animal weighing 2,000 pounds, than one weighing 1,200 pounds of the same age. The leather can only be cut as I mark here, A, A, which is four feet and no longer, (see cut No. 1). Something over is gained by stretching, perhaps three or four inches.

"So in buying short-lap belting, see that no piece is over four feet, four inches long, in all belts from eight inches wide up to 14 inches; from 16 to 24 inches, not over four feet two inches long; from 36 to 48 inches, not over four feet long."

"Now here," showing the auditor a second drawing, marked No. 2, which is a diagram of the hide, "you may see not only the length of the short lap, but also that several inches may be added without going into wrinkly surface. This is the reason that the Charles Munson belting has gained such an enviable reputation for strength and durability, and has become so generally used in spite of the lower prices of poorer goods."

The champion World's Fair ticket seller, was A. J. White, who sold admissions at the Sixty-fourth Alley L station, and the Fifty-seventh street entrance. White came within 35¢ of selling an even million of tickets. White sold tickets for Barnum's circus and can tell a "bad" dollar two blocks away, and see clear through a counterfeit bill. The record is remarkable, considering that the early months were so poor in attendance.

The Oakland Consolidated Street Railway Company proposes to give a series of prizes to passengers on their lines who do the most traveling. These are in the form of ten rebates, aggregating \$200, the highest \$60 and the lowest \$4. Each passenger paying his fare will be presented with a ticket. The person turning in the largest number of these tickets, January 1, 1894, will receive \$60, and the following nine a proportion of the whole amount.

ANYTHING TO MAKE TIME.—A party with satchels, hailed a cable car. One young lady lingered, whereat the conductor shouted: "Hurry up!" "But I want to give my sister a kiss," she replied. "Never mind, get right in," said the obliging fare collector, "I'll attend to that for you!"

SHE'S ALL RIGHT.—The Winchester, Tenn., News assures us, "Our electric car line between here and Decherd is still in good health." Glad of it; didn't know but she might have lost a hood, caught cold, and so got off her wheel base; or been taken with a bad turn on some sharp curve.

5
GREAT ROCK ISLAND ROUTE

TEN PASSENGER TRAINS DAILY OVER THE
CHICAGO, ROCK ISLAND AND PACIFIC.

If you are in a hurry you want to save all the time possible. Take the **BIG FIVE LIMITED**, that leaves Chicago at 10.00 P. M., and lands you at Denver 7.40 A. M. There is nothing better in this country. Of course you want to return quick, then take the **WORLD'S FAIR SPECIAL** No. 6, that leaves Denver at 8.10 P. M., and lands you in Chicago at 7.45 A. M. Anything better than that? I guess not.

Remember that the "Great Rock Island Route" has a wider range of termini than any road out of Chicago.

JNO. SEBASTIAN, G.T. & P.A.,
CHICAGO.

THE BIG FIVE IS A VESTIBULED TRAIN

ASKING FOR YOUR CASE

SPEED

PERFECT TRACK

TRAINS ON TIME



WINDSOR & KENFIELD,

PUBLISHERS AND PROPRIETORS.

269 DEARBORN ST., - - - CHICAGO.

Published on the 15th of each month.

SUBSCRIPTION, - - - TWO DOLLARS.

FOREIGN SUBSCRIPTION, - - - 20 SHILLINGS.

Address all Communications and Remittances to THE STREET RAILWAY REVIEW,
269 Dearborn Street, Chicago.

H. H. WINDSOR,
Editor.

F. S. KENFIELD,
Business Manager.

CORRESPONDENCE.

We cordially invite correspondence on all subjects of interest to those engaged in any branch of Street Railway work, and will gratefully appreciate any marked copies of papers or news items our street railway friends may send us, pertaining either to companies or officers. Address:

THE STREET RAILWAY REVIEW,
269 Dearborn Street, Chicago

Entered at the Post Office at Chicago as Second Class Matter.

This paper member Chicago Publishers' Association.

VOL. 3.

DECEMBER 15, 1893.

NO. 12

The STREET RAILWAY REVIEW has opened an eastern office at Room 14 No. 126 Liberty street, New York City, where our representative will always be glad to welcome our readers.

THE opening of the new Third avenue cable line gives New York City another important rapid transit system. The event passed off pleasantly and successfully, and the system is working nicely and carrying a big business.

A CORONER'S jury in San Francisco properly censured the company for allowing a passenger to sit on the front dash rail with his legs hanging over. Riding under such circumstances is always dangerous, and should never be permitted on any line, even to the extent of ejecting a passenger who insists on doing so. The fact that a car is crowded, as was the one in question, coming from a park, should make no difference in the enforcement of this rule.

IN a general way, I would state that in my opinion, a summer resort, properly conducted, keeping in mind the wants and tastes of each particular locality, is sure to be a profitable source of revenue to an electric railway." So writes the manager of an electric line in the East, under whose progressive ideas his company have expended an hundred thousand dollars in the purchase of land and making it attractive to rich and poor alike. What the measure of success that has followed this enterprise, can be best appreciated in our description this month of the Lowell, (Mass.) suburban railway.

NOW that inventors are offering life-saving fenders, the result of experiments covering quite a period, and the roads are beginning to adopt them, the metropolitan press are wearing in their hat the goose quills with which they were wont to write sensational articles of the juggernaut variety, and fondly imagine the new departure is all of their creating.

ONE road in this state, and a well managed one, too, commencing with the first of the year, will set aside every month a sum equal to one-twelfth the annual premium heretofore paid an accident insurance company. From this account accident claims will be paid, and any surplus at the end of the year is to be divided among the conductors and drivers. The plan is not without merit, and certainly in the long run, if not in each individual year, ought to prove a success.

TO all the accumulator traction interests of the world, the name of the late Anthony Reckenzaun was a household word. A scientist in the best sense of the word, he worked forward towards the end in view, heedless of anything but the steps of progress. As a practical engineer his work was no less meritorious, and although perhaps not known now to the rank and file, his contributions to the literature of electric traction will become his best known literary efforts.

OUR readers will recall our mention, a year ago, of the hot-riveted rail joints, put in experimentally by C. W. Wasson, electrical engineer of the Cleveland Electric Railway. One thousand feet of track was so jointed, and has now been in use eighteen months. Mr. Wasson writes us the track is in line and joints are imperceptible. The traffic on the line has been light—fifteen minutes headway—but the present winter will complete two summers and two winters of use, when a careful inspection will be made of every joint, and some interesting data may be expected.

THE every day use of 500 volt circuits around car barns, seems to breed a contempt for what little danger there is in them, and from the carelessness shown sometimes in barn and car wiring, it is strange that there are not more mysterious car barn fires. The stand the REVIEW has taken, as the champion of railway current for general light and power purposes, is well known, and we wish to again emphasize the fact that a 500 volt grounded circuit is as safe as any, if properly installed. At the same time it is decidedly dangerous if carelessly handled, and while the very few fires that have been caused by it is a powerful argument for the safety of such circuits, there are plenty of companies in the United States that ought to overhaul their barn and car wiring, if they expect to avoid fire losses.

AN interesting and unusual case is reported this month in our digest of recent legal decisions, where a ladder truck of a fire department collided with a horse car, causing one of the firemen to lose his leg. The decision was that although the fireman was riding in an unusual

and dangerous position, the circumstances of his work was a bar to the claim of the defense, that he was not in the exercise of due care. The moral is that when any vehicle of the fire department is answering an alarm call, the driver of any kind of street car should use the greatest possible care, and unless the car occupies a position in the street where it would impede the progress of the department, the car should be immediately brought to a stop until the department has passed. Many roads have a rule to this effect, and all should have.

THE last quarterly report of Brooklyn Heights Railroad Company, discloses the interesting fact that in the matter of casualties to persons, and including even the most trivial, that the ratio is one accident to every 7,870 horse car miles, as against one to every 11,262 electric car miles. In this case at least, the record conclusively proves what we have always maintained, that horse cars are really attended with a greater number of casualties than either cable or electric. In the instance above cited, there is a difference of forty per cent, in favor of the electrics; and all this in the city where there has been more written about the deadly trolley, than in all the other cities of the country combined. It may be an unkind addition for us to state that the electric lines in question, with one exception, have only been changed to electricity within the last three or four months, and when the men become more familiar—but we refrain.

AGLANCE any month at our record of patents issued on devices for street railway purposes, will show the large number of inventions which are constantly being taken out in this business. Of course, many are simply precautionary, and of which patentees never expect to make any radical use. Some are fool-inventions of the first water, but comparing the records with a few years ago, it will be quite apparent that the proportion of useless and impossible, and thoroughly impracticable ideas is growing smaller; and that a constantly larger number of inventions are made by men, actually engaged in street railway work, and whose product is not the creation of a burning desire to "invent something," but the result of an earnest, intelligently guided purpose to improve or meet an actual need. The old guard of grocery and dry goods clerk street railway inventors is happily on the wane. After all a patent is a very delusive affair, and like men's days they are full of troubles and law suits.

THE attempt to vestibule the driver's platform is by no means as recent an idea as many suppose. When the Kansas City cable was opened several years ago, the grip cars were built with glass inclosure but abandoned after two year's trial, and Robert Gillam, who designed these cars, says no satisfactory protection has as yet been devised. The experience in Kansas City was that when the cold became severe and the protection most needed, a thick coating of frost formed on the glass and the gripmen could not see their track. They would

then open the window and the intense blast which poured through the car, carried more severe cold than when the entire car was open. Ten of these old cars are in the barns now, the others having been rebuilt into open grip cars. The officials of all the lines in that city agree that the best remedy is for the gripman to dress warmly. Heavy gloves, a fur coat and warm cap, and possibly a knit hood, worn under the cap, and which covers the face, ears and neck, exposing only the eyes, such as is worn on some roads, would readily seem to make the driver better protected than it is possible for the conductor to be, as his duties preclude his wearing as heavy clothing.

THE attention of our readers is invited to the index to Volume III, published in this issue, and which this number completes. It not only demonstrates the very exhaustive manner in which the multitude of subjects, all relating to street railway interests, has been handled by this magazine, but reveals the magnitude of the street railway industry. That 808 pages of reading matter are possible within the limits of twelve months is something of an indication of the great range and diversity of topics which have grown into the life of street railway management, and go to show that what was once considered a thorough knowledge of the business is no longer true, but that the railway man who would keep abreast of the splendid advance in street railway development, must constantly apply himself to the mastery of new principles and know how to adapt new methods to all systems. Even in twelve months many radical changes have been brought about, and are constantly making, while the possibilities of revenue from other than passenger hauling alone, are becoming better established every month. What will be developed in 1894 affords a pleasant anticipation, and no one for a moment but supposes that some great strides will be made, and a year hence we shall look back on December, 1893, as a way-back number.

AS we have frequently suggested, no manager is fully alive to his duties, or entitled to that coveted title—"a progressive manager," who does not avail himself of every possible, practical means of increasing the earnings of his road. We have demonstrated frequently, what roads are doing in the sale of power for driving motors for all sorts of work; of what intelligently managed pleasure resorts have contributed; of how special attractions, in the way of band concerts and other entertainments, have filled cars, which would otherwise have run empty. We have constantly urged an express and light freight service, wherever there is an opening for the business, and funeral cars are not to be omitted in not a few localities; while the transporting of the mails has brought profit to many roads and effected a great saving in time to the public. To the above list it is now proper to add sprinkling cars, as the results both in superior service and profitable revenue, on several roads which made it a business last season, fully demonstrate its possibilities. Any company operating by electric or cable power, and

even horse roads can undertake the service of sprinkling the streets covered by its lines, at a price considerably below what it is possible to do the work for by the old method, and still have a handsome profit at the end of the season:—to say nothing of the indirect advantages of induced riding, by reason of the freedom from dust.

IF the first three days in December set the style for the three winter months, as people used to believe, there is a busy season of fighting snow in prospect for northern managers. In Chicago these days were full of storm and wind and snow. The unusual absence of rain during the summer and fall, which characterized many portions of the country, would seem to confirm the expectation of many railway men, that there will be abundant use for all the snow plowing apparatus already owned, and in many cases will require considerable addition to this department of equipment. With many there is a strong inclination to try and get through another winter without investing what seems a good deal of money in equipment, which may not be used more than a few times; but on the other hand the interest on the investment is a mere trifle compared with the saving in labor expense during a single hard storm. Even if not used at all there can be no cause for regret, just as one renews his fire insurance and is glad his last premium brought no returns in kind. There is no economy in bucking heavy snow with light apparatus, and where mechanical power is used, no excuse for doing so. Above all, there should be sufficient equipment to enable the crews to get over the lines frequently, and the work should commence as soon as snow begins to fall. There is everything in keeping the upper hand of a snow storm, for once let it get the start one is literally as well as metaphorically snowed under.

OUT of all the dust and noise which have been raised by sensational daily papers, in which ignorance and unfairness have had unrestricted freedom, it is really refreshing to find one metropolitan journal which is honest enough to tell the truth and face the question fairly. That paper is the Baltimore American, and its recent editorial on rapid transit will not only be endorsed by managers, but could with propriety be copied in the local papers wherever rapid transit is operating or proposed. The American says:

With the introduction of rapid transit the liability to accident is necessarily increased, and they are likely to occur oftener and to be more serious than under the old system, no matter how careful the street railway companies are. This is not an excuse for carelessness.

On the contrary, it furnishes the strongest reason for vigilance and the adoption of every precaution that tends to prevent accidents; but in order to secure the utmost immunity from accidents the public must recognize that there are always two parties to an accident—the car which inflicts the injury and the victim who is injured, and that no matter how careful those may be that have charge of the car, they are very nearly powerless if the person hurt is reckless and neglects the commonest precautions against an accident. In other words, the responsibility is a double one. The railway company is bound to do all in its power to prevent injury to a citizen, and the latter is morally bound to second the efforts of the company by not rushing heedlessly into positions which make accidents almost a certainty.

It is a situation which has come upon the people suddenly, and for which they are not adequately prepared. Rapid transit is a necessity,

and is here to stay, and it is, therefore, incumbent on the people to prepare properly for the new order of things, and to do this there must be a certain amount of education. The companies will naturally take precautions to avoid accidents because of the heavy liabilities they incur through carelessness, which the courts are always prepared to enforce, and the public should second them in their efforts. With proper care on the part of both accidents ought to be well nigh impossible.

The same article also suggests that teachers in the public schools periodically caution the children as to avoiding cars and other vehicles when crossing streets.

UNLESS present plans are changed, the Metropolitan Elevated Road, now nearing completion in the West Division, this city, will be operated by electricity, and so operated will be the largest system of the kind in the world, the next in magnitude being the Liverpool, England, road. The operation of the Intramural, at the World's Fair, abundantly demonstrated the advantages to the public of electric haulage, and that the system is mechanically a practical success. Motors, whose normal load was four or five cars, as rapidly and swiftly hauled eight cars filled to their utmost capacity. The advantages to the structure itself, of getting rid of one-half the weight required in a steam locomotive is self evident; and the freedom from gas, smoke, and the delay each trip for coaling and taking water were all appreciated. Mechanically and electrically the demonstration was all that could be wished. What street railway men and engineers would like to know is: "What is the operating expense?" This is known only in the secret archives of the General Electric Company, and is as religiously guarded as the interior of a Keeley motor. If the operating cost per car mile compares favorably with that of steam locomotive hauling, there certainly can be no objection to giving out the figures; and even if the balance is against electricity more good will come from a knowledge of the fact, as electric haulage of this type is in its infancy, and it is to be expected, that with experience already and to be gained, that difficulty can be overcome, just as other and harder problems have been solved by the score. The General Electric have been so prolific in its statements and illustrations of every possible item of interest regarding the Intramural from the day the first post was set until now, that it certainly is due the electrical and railroad fraternity to know that which is most important of all—viz.: operating expenses. Readings, tests and records of the most complete character were taken by one of the company's experts covering the entire month of October, but all inquiries or requests for this information fail to elicit even the faintest inkling. For all of which there must be some reason. What is it?

ON November 18th the New York State Commission successfully ran a canal propellor by electricity. Current was obtained from the Rochester railway power plant. Two ordinary trolley poles were used and two 25-horse-power motors direct connected to the propellor shaft. The total cost of the experiment was \$5,000. Engineers Chessrown of the Westinghouse, and engineer Charles R. Barnes, of Rochester, together with F. W. Hawley, of the Niagara Falls people were principals.

YOUNGSTOWN STREET RAILWAY.

ONE of the most marvelous growths in the street railway field is that enjoyed by the Youngstown, O., Street Railway Company, since the spring of 1892. In May of that year the road was running twelve motor cars and had $7\frac{1}{2}$ miles of track. It had no machine-shop, winding or supply rooms, and all repairs had to be done outside. To-day it is running thirty motor cars over fifteen miles of track and repair facilities are very complete. On investigation it will be found that the season of prosperity, extension and improvement, began with the coming of F. Wayland Brown, as general manager.



F. W. BROWN.

Mr. Brown is a self-made man of 26, and although young in years has passed through enough experience for a man of 40. Since leaving home at the age of twelve



CURVE AT TOP OF TEN AND ONE-HALF PER CENT GRADE.

he has received no financial help. The college education he earned for himself had to be abandoned before completion on account of weak eyes. Going into the dry goods business he remained there for three years, the last one serving as buyer for the A. M. Church Company, Troy. Two and a half years was spent on the road and he then bought out the Osborn Manufacturing Company, Cleveland, O., makers of foundry supplies, with which concern he had wonderful success. While with this he also managed the Huron Rubber Company, and also became interested in the horse road, at Lorain, O. In May, 1893, he accepted the earnest invitation of the directors at Youngstown and took charge of that road. The labor involved in obtaining franchises and making improvements while at the same time tripling the plant will be appreciated only by those who have been through it.

BUILDINGS.

The building is three-story brick with stone trimmings. The main floor is 100 by 270 and contains: waiting room 15 by 15; employes room equipped with lockers 15 by 30; car house 100 by 150, equipped with transfer table, wash rack, etc.; store room 10 by 45; engine room 42 by 120; boiler room 42 by 50; shop 58 by 70; armature room 12 by 22. The second and third floors of the building are 100 feet wide by 150 feet deep. On the second floor are situated the main offices of the company, consisting of general office, office of cashier and book-keeper, and the private office of the general manager. The third floor is rented from time to time for dances, church fairs, etc. In the

POWER PLANT

are three Corliss engines of 250 horse-power each, one of which was manufactured by the Hoover, Owens & Rentschler Company, of Hamilton, Ohio. To each of these engines are belted two Edison 100-kilowatt machines, having a capacity of 200 amperes each.

In the boiler room stand two Hazleton tripod boilers



THE YOUNGSTOWN POWER STATION.

of 500 horse-power each, encased in brick stacks 96 feet high. These boilers are fed by the Roney mechanical stokers, and coal is fed to them by Harrison coal elevators and conveyors, which apparatus also removes ashes from the ash pit under the grate bars. In connection with these boilers is operated a Warren Webster vacuum feed water heater and purifier, which relieves the engines of all back pressure, purifies the water and feeds it to the pumps at an average temperature of 208 degrees Fahrenheit. Pumps have brass plungers, rods and jackets, and pump hot water with excellent success. The two pumps have 10 inch stroke, with water cylinder 12 inches in diameter and steam cylinder 6 inches in diameter.

SHOP.

The shop is equipped with geared hoists for hoisting car bodies as shown in engraving, and a Harrington

chain hoist attached to a swinging crane for handling armatures, motor casings, etc. There is also a special lathe, manufactured by Prentice Brothers, of Worcester, Mass., which lathe has 24-inch swing and a 16-foot bed, double back geared head and gives twelve even changes of speed to the spindle. A 32-inch drill press, manufactured by the same concern, and a Gould & Eberhardt shaper and planer, a grinder with three emery wheels, and brick forge equipped with Sturtevant blower and tuyere, all of which are operated by a 10-horse-power motor, belted to the main shaft running through the center of the shop, are also in use. With the aid of these machines they do practically all their own repair work. The power machines, of course, are supplemented by a full and complete assortment of small tools and hand tools.

In connection with the armature room is a large brick pit, with heavy sheet iron covers, the bottom and sides of which are lined with steam pipes, and in the center of

Ties are spaced to three-foot centers, and are all white oak, 5 inches by 7 inches by 7 feet, except joint ties, which are 6 inches by 10 inches by 7 feet. Poles are extra heavy 3, 4 and 5-inch iron pipe.

The overhead construction used is about half Christie material, manufactured by The Cleveland Construction Company, and the remaining half is nearly all the latest type of line material manufactured by the Ansonia Electric Company, with also about two miles of Railway Equipment Company overhead material.

THE CAR EQUIPMENT.

numbers in all forty cars, thirty-two of which are closed 16-foot bodies, and eight of which are 7-seat open cars. The closed cars were made as follows: six by the Gilbert Car Manufacturing Company, Troy, N. Y.; three by The American Car Company, St. Louis, Mo.; thirteen by the New Castle Car Manufacturing Company, New Castle, Pa. The eight open cars are also manu-



SCENE IN REPAIR SHOP.

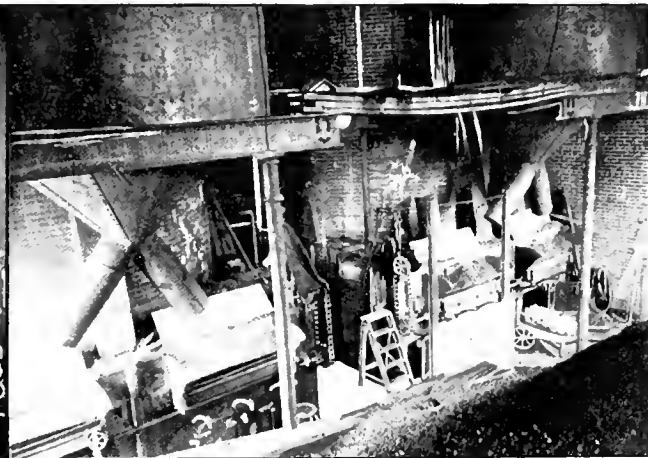

BOILERS AND MECHANICAL STOKERS.

which run two tracks for the support of the ends of armatures shafts, which has proven a most efficient dry box for drying out armatures, commutators, etc. Leading to this is an overhead track made of angle iron, on which runs a chain hoist, so that armatures can be handled readily to and from the armature room to the drying pit. In the rear part of the third floor of the building is a small carpenter shop and paint shop, where is done all of the repairs on building, car bodies, etc. The entire building is heated with the Williams vacuum system of steam heating, in which a small pump, 4½ by 6 by 8, sucks the exhaust steam from the engines through 21,000 feet of pipe, for heating purposes, which heats the building in the coldest weather, and relieves the annoyance of steam hammering in the pipes.

TRACK AND LINE CONSTRUCTION.

There is in all fifteen miles of track, comprising grades ranging from 2½ to 10½ per cent, all within the city limits. Most of the track work is 70-pound Johnson girder rail using braced and plained tie plates alternately.

factured by the New Castle Car Manufacturing Company.

Six Taylor trucks are mounted with Sprague Number 6 motors; sixteen McGuire 19 F. trucks are mounted with Sperry S. W. 10 motors; ten McGuire Columbian trucks mounted with Sperry S. W. 12 motors, and the eight trucks under the open cars were manufactured by The Dorner & Dutton Manufacturing Company, of Cleveland, Ohio. The regular number of motor cars on the line is thirty. The emergency outfit consists of one electric sweeper and one line wagon.

THE West End street railway, of Boston, carried 145,068,370 passengers for the year ending June 30, 1893. During this time one passenger was killed, nineteen other persons were fatally injured. Of five steam roads the total passenger traffic was 91,077,130. They report 362 fatal injuries. These steam roads injured 1,470 people. The West End hurt 310. The steam roads ran 18,864,235 car miles and the West End 18,669,809. We submit the case without comment.

MANUFACTURE OF ELECTRIC RAILWAY APPARATUS IN ENGLAND.

ONE of the most prominent electrical manufactories of Europe is the English company now known as the Electric Construction Corporation, Limited, whose works are situated at Wolverhampton, England, and which is the successor of what was formerly Elwell-Parker, Limited. In view of the rapidly increasing interest in Europe, in electric traction, a sketch of this establishment will be interesting.

These works are complete in every detail, with complete laboratories for the various departments of research. The testing room containing the most approved and delicate machinery. Dining rooms and kitchens for four hundred employes, male and female, are provided for those living at a distance from the works.

The power station and generating plant here is parti-



T. PARKER.

and in common with all the rest of the building they are driven by motors from current, from the main plant. The shafting runs at 120 revolutions.

The motors used are of uniform size throughout the works. Wherever they are wanted, they are placed on the concrete floor, lined and levelled, they are then, when connected to the mains, ready for work. No foundation is required, and the motors are not bolted down. The system is simplicity itself. As soon as a shaft gets too long, or is too heavily loaded for one motor to drive it conveniently, another is put down and belted to it. While upon the subject of line shafting, we may say that it is all 2½ inches diameter, running in long swiveling cast-iron bearings, lubricated with an oil needle lubricator in the center of each bearing, and one Stauffer solid oil cup near each end. The pulleys all have perforated wrought-iron rims. This description of the shafting applies throughout the works. A second line of shafting is placed below the main line, in the erecting shop, to drive various machines for working sheet-iron, in a side-bay, without countershafts.

It goes without saying, that the shops are provided with the most modern tools and appliances, and ample storage and supply rooms. The machine shop is also

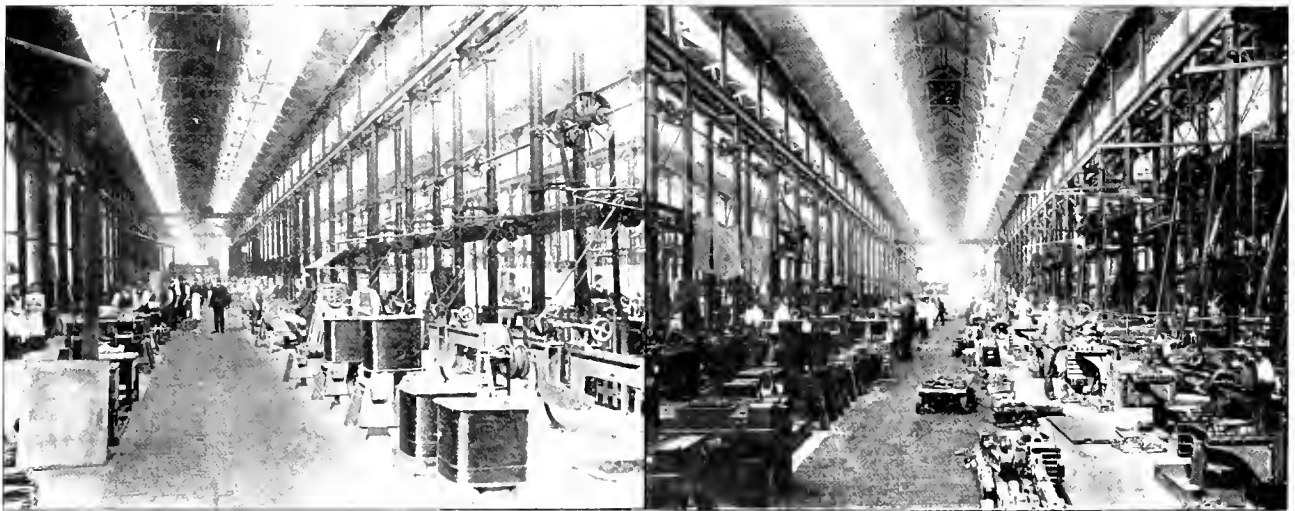

ERECTING AND MACHINE SHOPS ELWELL-PARKER FACTORIES.

cularly interesting, containing four Babcock-Wilcox boilers, Worthington pumps, and Green economizers. The engine room contains a pair of Robey & Company horizontal compound non-condensing engines with one fly wheel between them. The cylinders are 13½ by 21½ inches, by 30 inch stroke. By belt and counter-shaft a shunt wound dynamo is driven with an output of 800 amperes at 110 volts, which supplies power to the works. A reserve engine is also in readiness, and a Fowler engine is used on the arc light dynamo. We show a view of the first bay in the erecting shops, where the smaller machines are assembled. Electric cranes are everywhere present, to assist in heavy lifting,

provided with two traveling cranes, one electric and the other run by hand power.

The pattern shops and iron foundry are all complete of their kind, well lighted by large skylights. The foundry is provided with travelers of ten and five tons capacity, one for the heavy and one for the light work. Summarizing the electrical driving of the works, which is the most remarkable part of the factory, we find 21 motors in use, all told; 12 of these drive line shafting, of which there is 1,500 feet. From these shafts 114 machine tools are driven.

The Electrical Construction Corporation has filled several remarkable railway contracts, notably the Liver-

pool overhead railroad heretofore described in this magazine, and the Staffordshire electric railway of the trolley order, a description of which has likewise appeared on these pages, and a late contract is for a conduit system of underground trolley, which is to be instituted at Madras, India. Besides this, tramway work for other places in England and Australia has made the company pioneers in European electric traction.

The inventor of the company's special electric apparatus is Thomas Parker, whose portrait is presented herewith.

Thomas Parker was born of humble parentage, at Lincoln Hill, near the village of Coalbrookdale, Shropshire, England, in 1843. At the age of nine years he went with his father into the shops at Coalbrookdale as a moulder, in which hard and unremitting labor he continued eight or nine years. All his education, meanwhile, was picked up at odd moments. At that time the possibilities for education were not great for those well-to-do, and for the poor, there was absolutely nothing. Naturally of a bright mind, however, and the night schools and the few books and papers that he was able to get hold of, laid the foundations for his later technical knowledge.

About 1861, Mr. Parker left Coalbrookdale for Birmingham, and thence to the potteries, subsequently to Manchester, where the means of obtaining an education were then more plentiful. Electricity was at that time, 1864, being recognized as having a future, and to it Mr. Parker was attracted. His first electrical education was in the form of popular lectures by Sir Henry.

struggles, Mr. Parker became an enthusiastic laborer in the field of popular education, giving many lectures in the neighborhood.

Meeting with Bedford Elwell, a manufacturer, Mr. Parker formed a partnership that has made both names well known to American and European electricians. This was ten years ago, and the corporation employed three men and a boy, including Mr. Parker. From this

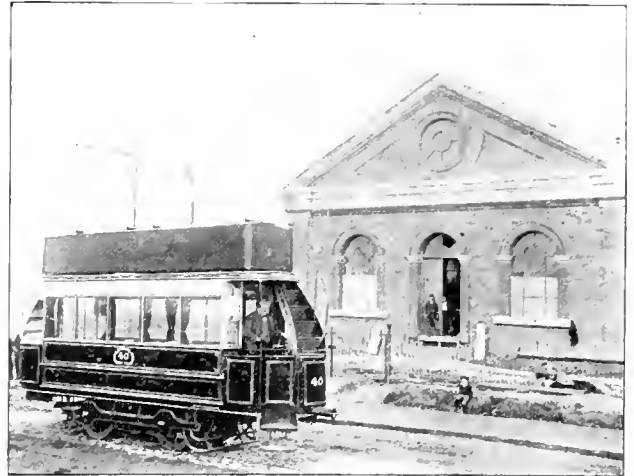

SOUTH STAFFORDSHIRE LINE.

small beginning the present corporation, with a paid up capital of \$2,500,000, has sprung. The thousand employes, and the magnificent works spreading over an area of twenty-five acres, and a world-wide reputation, is another result.

This story, told of a new country, where development is faster, would attract wide spread notice; but spoken of a land which is thought to be over crowded with industry, and where competition and class distinctions are hard and close, it is a wonderful monument to the credit of Mr. Parker's splendid mind, executive ability and foresight.

THE ROMBAUER HAND STRAP.

THIS strap, which is the invention of E. E. Rombauer, of the Scarritt Furniture Company, St. Louis, serves the double purpose of an advertising medium and a great comfort to the "standing army" during the rush hours. It is in reality two straps fastened together in the shape of a letter V. The old hand strap is one of the horse car relics that has proved "entirely inadequate with the mechanical traction of the present day," especially when the motorman is making an emergency stop, or starting without waiting to count five, after each stop on the controller.

A MAN named Bazczkowskiz was injured in a Chicago street car accident. It is a good thing for the newspapers that none of the rest of the family were hurt. Think of reading proof on that name four or five times!

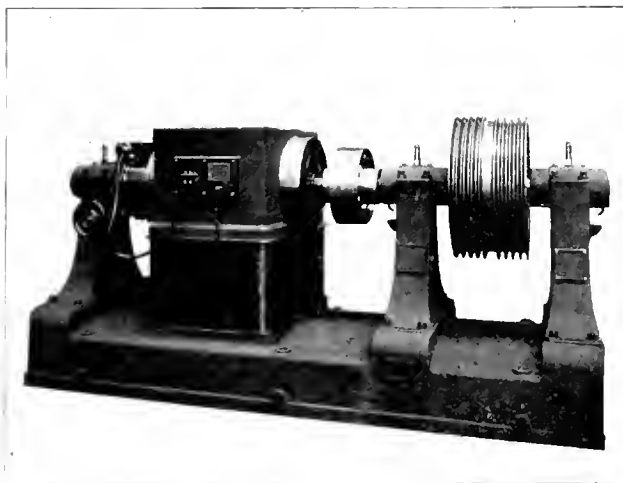

ELWELL-PARKER DYNAMO.

then Professor Roscoe. These advantages were supplemented on his removal to Birmingham, by a course of study at the Midland Institute. Thus equipped, both practically and theoretically, he returned to Coalbrookdale to become associated with his former employer, but in the capacity of expert machinist. During his seven years in this capacity, Mr. Parker devised several valuable, remunerative inventions, among others, the Parker-Weston steam pump. Mindful of his own early

THE EUPHRAT FENDER.

THE fender illustrated herewith is attracting considerable attention in New York at present, because of the fact that there are such good prospects that it will be adopted on the Broadway cable line. It is very simple, as a glance will show. It is made in two styles. As tried in New York, it is left down all the

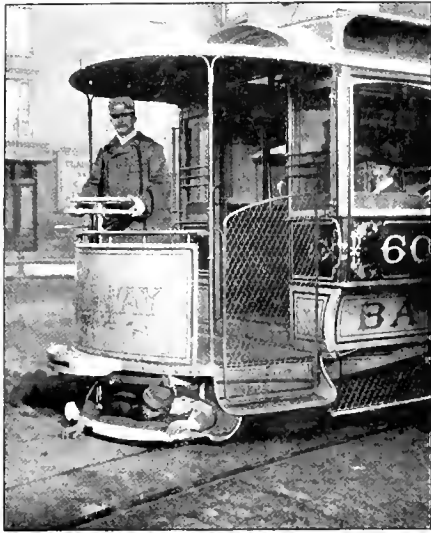

time, clearing the ground by about three inches. When an object strikes the fender, it springs down and almost touches the ground, the weight being carried on the little wheels. It is thus in practical effect, as good as a fender running very close to the pavement, while never hitting it when the car rocks. The other style of fender is of the same form, the only difference being that it is held up close under the platform. The side frame is of

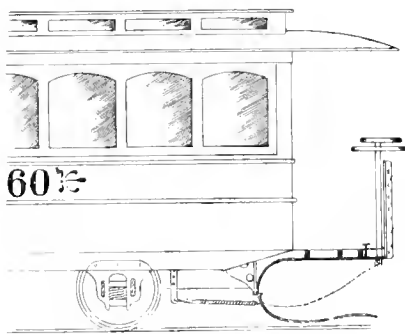

springs, as on the other form, so that when released it will spring down close to the ground. This releasing is done in two ways, either by a treadle pressed by the motorman, or by a person striking the lower edge of the dash. A strip running around in front of the dashboard is attached to the releasing mechanism in such a way that a very slight pressure will let the fender down. The frame, as was said, is of spring steel and the netting of wire. This is apparently a very practical and efficient form of fender.

TRANSPORTATION FOR THE BUSINESS DISTRICT, CHICAGO, BY MEANS OF MOVABLE SIDEWALKS.

THE multiplication of sky scrapers in Chicago, which contain three to five times as many persons as are allotted to the same ground space in other cities, and the remarkable growth and business activity, have combined to make the streets in the business district fearfully congested. Unless speedy relief is afforded, one will soon be able to go out four miles toward the suburbs in same time required to traverse as many blocks in the congested district. While the surface cars occupy almost every street, their progress is slow, and getting slower every month; the elevateds have not succeeded in invading the territory, and are not likely to. The street car companies would save many thousands every year if they could terminate at the border of the congested district (about one mile square), but under present conditions are forced to loop in the very heart of it.

Realizing present and future needs, there has just organized the Central Construction Company, in which many of the wealthiest men in the city are stockholders: men whose names have national reputation. The purpose is to construct a series of loops connecting all depots and prominent buildings, using the movable sidewalk system which was so successful at the World's Fair, and erecting the moving platforms on neat posts at the curb. While the company is not sufficiently advanced in its plans to warrant the publication of details either of intentions or construction, it may be said that the drawings are all under preparation, and as far as completed show a very ornamental and simple structure, which cannot raise any possible objection in the mind of any reasonable man. The proposed construction does not in the slightest interfere with light or passage, and will be noiseless in operation, using electricity as motive power. It is, we believe, the intention to have a very low fare, and for that reason alone, it is to be hoped the enterprise may be in operation at the earliest possible moment. The saving in time to business men and shoppers, not to say the convenience to strangers, who desire to transfer from one depot to another, and suburbanites who must use the steam roads every day, will be incalculable.

It has been a matter of great surprise that no competitive tests were made on the boilers at the World's Fair. As no appropriation was made for the purpose, the jury of awards invited the exhibiting companies to have competitive tests made at their own expense. We understand that the Stirling Company was the only one in the main boiler room offering to have the tests made under these conditions. The Stirling Company's claims were broad, and were borne out by the inspection the judges made of numerous working plants, both in and out of Chicago, hence the award.

The government of India has approved the scheme for a steam tramway at Howrah.

THE LAKE ROLAND ELEVATED.

THE Lake Roland Elevated Railway Company was formed in June 1892, by the consolidation of the North Avenue Railway Company and the Baltimore, Hampden and Lake Roland Company. Before speaking of the company's history in detail, let us take a spin over the system. We take a car at the city hall, and in a moment are whirling up from the street grade to the top of the elevated structure. Below is the bed of North street crowded by ever shifting cars of the Northern Central Railway, making street railway travel at grade impossible, and giving the *raison d'être* of the elevated road. Our course is north for one and a half miles to North avenue, however, our elevated ride is only three-fourths of a mile. Reaching North avenue we go westward a half mile to Oak street. Again our general course is north, for the objective point is Lake Roland, a picturesque body of water more than six miles north from the city hall. The lake is one of the sources of the city's water supply, formed by damming Jones's Falls. We are in the annexed district of the city, and the speed may be increased to fifteen miles an hour, on the elevated structure. Our route is north on Oak street, west on Twenty-third street, north on Hampden avenue, west on Twenty-fourth street and northwest on Amos alley, which is private property, to the Quarry or Stony

Run viaduct, and we have traveled a mile from North avenue. The viaduct stretches 660 feet across a rugged valley. Leaping and dashing over the rocks, more than fifty feet below us, is Stony Run. Several hundred yards down the valley to the westward is the power station of the railway company at the juncture of Stony Run and Jones's Falls. Further west beyond Jones's Falls can be seen the beauties of Druid Hill Park, Baltimore's beautiful outing place of 700 acres. We have reached suburban Baltimore where fine drives, beautiful landscapes, ideal hills and valleys for elegant homes abound. Our route is upward as well as onward and as we spin into Roland Park along Roland avenue, 120 feet wide, we are 400 feet above tide level in Baltimore harbor, five miles away. We can see the hill tops for miles around glistening in the sunlight, the air is fresh and invigorating.

ROLAND PARK.

The building of the railway went hand in hand with the development of Roland Park. The Jarvis-Conklin Company, of Kansas City, while seeking investment for English capital bought 450 acres of ground on this plateau, and began to improve 120 acres of it in September, 1891. A model city of suburban homes was planned, from 300 to 500 men were employed for a year in executing the work, gravel roads or avenues were made and rolled to form park drives, asphalt sidewalks were laid, and 3,000 trees were added to forest trees on the premises. An underground sewer system was constructed. Roland spring, with a flow of 50,000 gallons of water a day, furnished a supply of excellent water. On the premises a pump operated by electric motor forces the water into a stand pipe 20 feet in diameter,

and 70 feet high with a capacity of 165,000 gallons. An observatory crowns the water tower giving an altitude of 465 feet above tide water. Thirteen months ago the Roland Park Company began to sell improved lots. Safeguards were thrown around the sales looking to the maintenance of the artistic and æsthetic of the Park, on which hundreds of thousands of dollars had been spent. About sixty fine cottages, valued at more than a quarter million of dollars, have been erected,

and others are being built. As this plan developed the projectors sought a means of giving residents of Roland Park rapid transit facilities to and from the center of the city.

The Jarvis-Conklin Mortgage Trust Company then obtained control of the railway companies, which were merged into the Lake Roland Elevated Railway Company, and the lines constructed over the routes just described. While the work of construction was in progress an extension from Roland Park was projected northward two miles on Roland avenue and through private property to Lakeside Park, a pleasant resort, fitted up by persons interested in the success of the Roland Park and railway enterprises.

Lakeside Park is the northern terminus of the railway at the south end of Lake Roland. It is six and a half miles in an air line from the city hall. The park

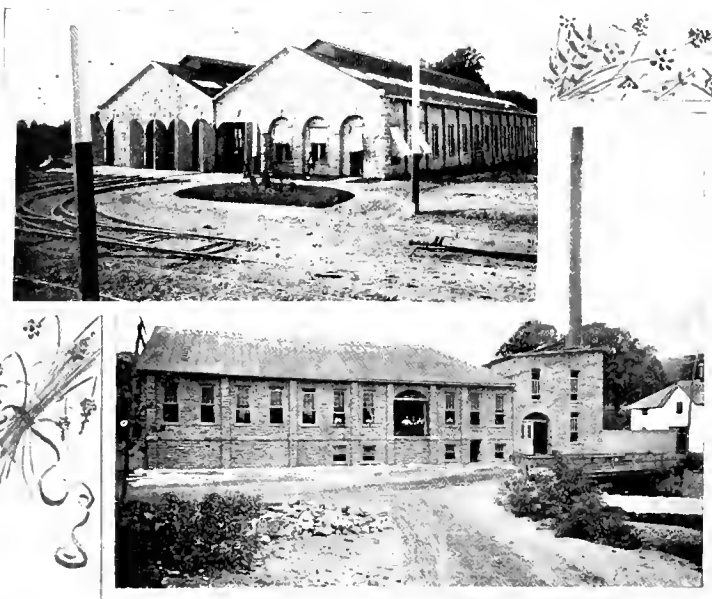

POWER AND CAR HOUSES.

contains sixteen acres of woodland cleared of underbrush, and stretches along the backbone and sloping sides of a ridge 400 feet above tide water. Running off abruptly to the northwest, the ridge sinks into the waters of Lake Roland. Although, small in area, the surface of the park is so varied that it presents many picturesque nooks. A small stream dashes over the rocks at the foot of the hill and from the precipitous boulders, on the opposite side, bursts a stream of excellent water, flowing 15,000 gallons a day. An electric pump forces the water to the hilltop for domestic purposes and to run a number of fountains. From the railway loop a cinder path ascends to the top of the ridge. Midway in the park is a pavilion 50 by 100 feet. The first floor is used as a restaurant, and the second floor for dancing. A number of amusements are provided at the park during the summer. The breast of the Lake Roland dam is near Lakeside park, and the beautiful lake rests in a winding valley a mile long and from an eighth to a quarter of a mile wide. The surrounding country is rich in natural scenery.

The railway to Lakeside Park was opened for regular business July 2, 1893, and blazed with popular success immediately. The facilities of the company were taxed to accommodate the crowds, and from 25,000 to 35,000 persons were frequently carried in a day.

The vicinity of Walbrook, which is tapped by the western branch of the Lake Roland Elevated Railway, is also a high and beautiful suburb of Baltimore, abounding in magnificent hills and fine cottages.

The North Avenue Railway Company operated the first trolley road in Baltimore. An electric car was started by the company on April 16, 1890, on North avenue, to run 8,800 feet. The road was an experiment, and its development into the Lake Roland Railway of to-day was not anticipated. The equipment was one car, which is now in daily use, and is an object of interest as the first trolley car in Baltimore. The North avenue extended its line several times and eventually became what is now the Walbrook branch of the Lake Roland system.

To reach the center of the city a route was selected, part of which included the elevated structure, three-fourths of a mile long, ascending to street grade just north of the city hall, and was the first structure of the kind erected in the county for electrical operation.

The company had a long and bitter fight to accomplish this design. It was pelted with injunctions, pilloried on public opinion, and a batch of law suits seemed to await it in every block of the proposed route. City council and state legislature had to pass upon the scheme, and truces had to be patched up with other railway companies occupying short stretches of North avenue. In the midst of this sea of suits the projectors of Roland Park took hold of the struggling company, re-organized as the Lake Roland Elevated Railway Company, and energetically carried the work to completion. The line was opened from Roland Park to Oak street and North avenue, April 23, and to the city hall, May 6, 1893. The Lakeside Park extension was opened July 2.

The opening scenes were extremely lively. For several weeks from 3,000 to 5,000 people were frequently waiting at the city terminus. The arrival of a car invariably caused a rush for places. Special police squads were detailed to regulate the travel. Women in the crowds fainted and had to be carried out. Boys who clambered into car windows were passed over the heads of passengers and shoved out the windows on the opposite sides. The road is now popular and liberally patronized. The number of passengers carried from May 6 to October 31, 1893 was 3,202,679.

THE ELEVATED STRUCTURE

is 3,910 feet long. The approach consists of a stone abutment 16 by 90 feet with ascending grade of 9 feet in 100. This grade is continued 160 feet farther upon steel trusses, giving the elevated structure a clearance of 20 feet, and a track level 27 feet above the street. These heights are maintained throughout the length of the structure, which has a slightly ascending grade from south to north. The upper end of the approach forks from 8½ feet between track centers to 23 feet, which is maintained on the elevated structure, excepting for 600 feet, in which the distance between centers is 27 feet. This widening was caused by the steam railroad tracks on North street. It is now proposed to straighten the tracks, and establish a uniform distance between track centers.

The elevated structure consists of longitudinal trusses supported on transverse girders, which rest on columns rising from the curb lines. These columns are set opposite each other, and the distances between successive pairs range from 40 to 65 feet so as not to obstruct travel on intersecting streets. Two bridge spans, 156 and 192 feet long, were necessary at Centre and Madison streets on account of the railway tracks. The supporting columns for the bridge spans are 18-inches square, and for girders, 12-inches square. The transverse girders are sixty inches deep, five-eighths of an inch thick, ranging from 36 to 99 feet in length and weighing from 6 to 11 tons. The track includes seventy pound T rail with heavy timbers guards laid on 8 by 10-inch cross ties; the guard and ties being the only wood in the entire structure.

The structural work weighs 1,060 pounds per lineal foot of structure; weight of track, 460 pounds, giving a total dead weight of 1,520 pounds, with a wind strain of 150 pounds per foot for top laterals, 400 pounds per foot for bottom laterals, and 250 pounds per lineal foot on moving loads. The structure is calculated for a live load of 32,000 pounds.

Elevated passenger stations are provided at Pleasant, Little, Franklin, Centre and Madison streets. There is a station with separate stairways for each track. The stations are 10 feet wide and extend from 40 to 65 feet along the track. They are roofed, lighted by electricity, and stairways and platforms enclosed with galvanized iron to a height of four feet, excepting one half of the side towards the track. The trolley wires are carried on center poles spaced to every third girder and the

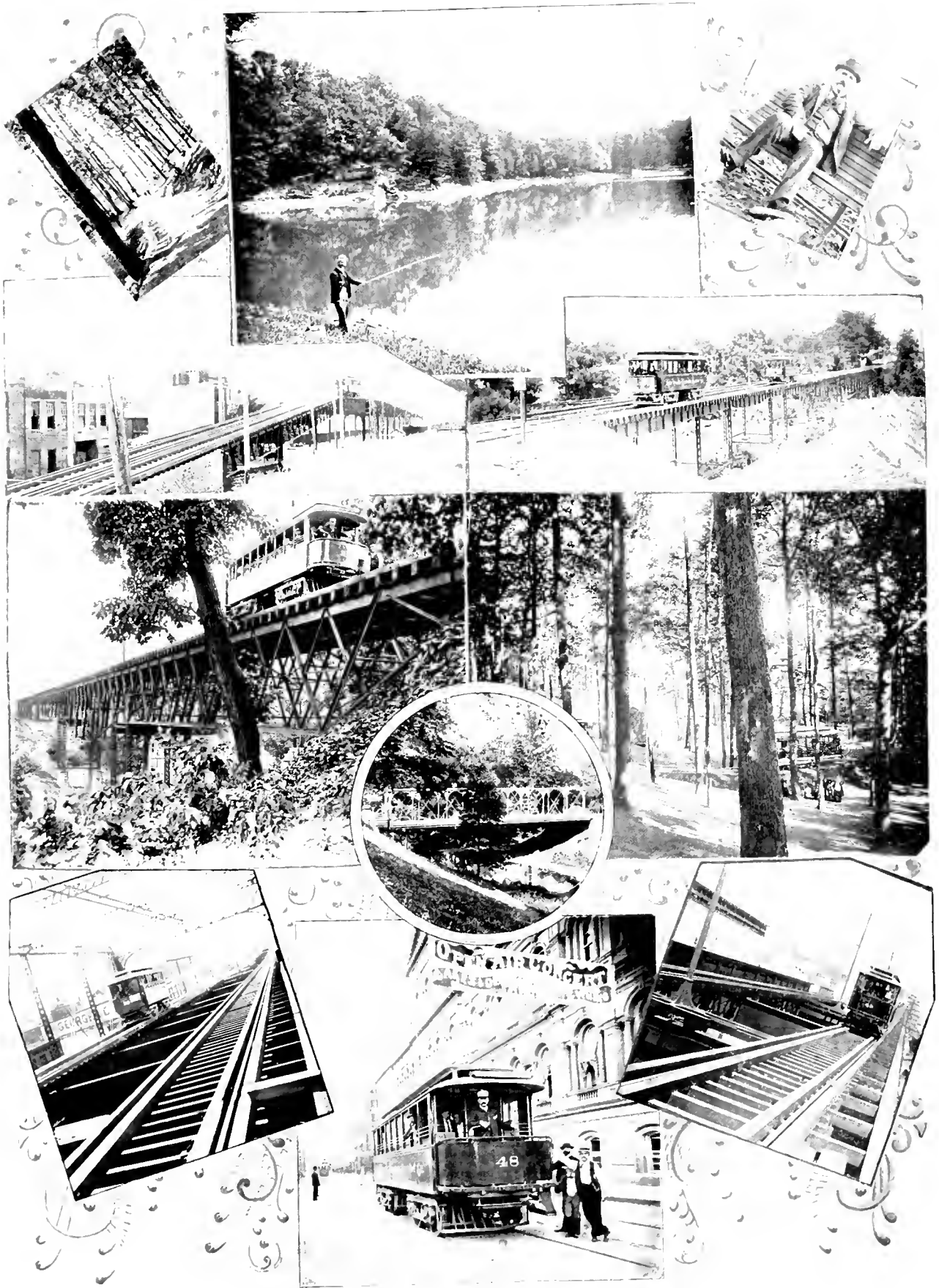

SCENES ON LAKE ROLAND, IN ROWLAND PARK, AND ALONG THE LINE.

feed wires beneath. The structural work was made by the Pennsylvania Steel Company and is said to have cost \$200,000.

The Stony Run viaduct, 660 feet long, is of steel, and was built by the Variety Iron Works. It contains two bridge spans each 130 feet long. The other parts of the structure are carried on piers consisting of four columns. Each pair of columns being spaced 22 feet between centers, and the piers 56 feet from center to center. The

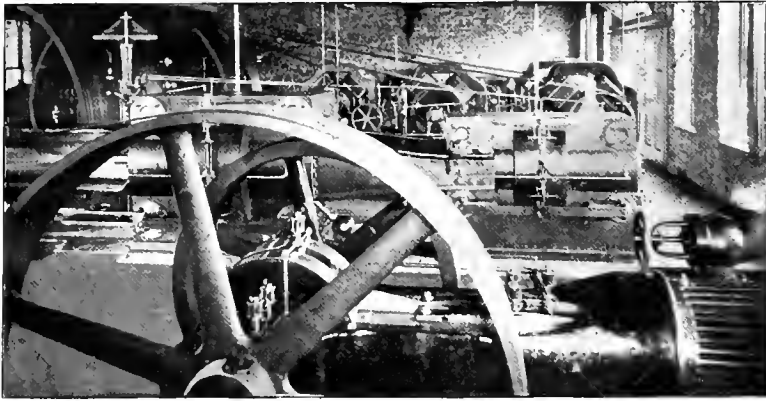

LAKE ROLAND POWER STATION.

piers are set on stone pedestals built from 6 to 18 feet below the surface of the ground. The track is of 58 pound T rail laid on 6 by 12-inch ties, with 6 by 8-inch timber guards. The track is 50 feet above Stony Run. This viaduct cost \$30,000. The iron structure weighs 570 pounds per lineal foot; track construction and esti-

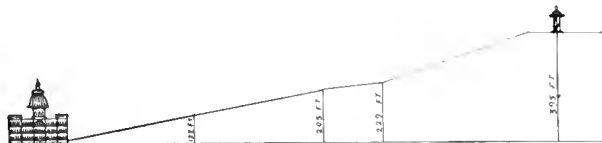

TOPOGRAPHY OF LINE.

mates for walks 690 pounds, making a total dead load of 1,260 pounds per lineal foot, or 420 pounds per foot per truss of entire structure.

THE POWER HOUSE

is 56 by 130 feet and situated at the juncture of Stony Run and Jones's Falls, is built of stone, and has a galvanized iron roof. The mechanical plant consists of two 750-horse-power Corliss tandem compound condensing engines, of improved type, connected for joint or separate use. Two 400-horse-power dynamos are connected with each engine. An alternating current dynamo for electric lighting is operated by a 120-horse-power Ball engine. This plant furnishes power for electric lights at Lakeside Park, the residences and streets of Roland Park and the general offices of the company. Six 250-horse-power Corliss boilers and a National feed-water heater completes the equipment of the power station. The length of feeders is approximately as follows: Walbrook circuit from North avenue and Oakstreet to Walbrook, four miles; Roland Park circuit, from North

avenue and Oak street to Roland Park, four miles; city hall circuit, from North avenue and Oak street to city hall, two miles; and Lakeside circuit, from Roland Park to Lakeside, two miles.

The car house and offices of the company are at Roland Park. The building is 112 by 203 feet, built of stone. It contains machine shops, and 1,640 lineal feet of tracks. The rolling stock consists of 29 closed cars, of which twenty-five are 30 feet long, equipped with two 30 motors. There are also thirteen handsome open cars, from Lewis & Fowler's works, of 28 feet length and carrying two 50-T. H. motors. Westinghouse motors are used on some of the closed cars. Bemis and McGuire are the trucks in service. As already stated, on the outside lines and on the elevated portion, T rails are used, but in the city the Duplex Rail Company's 66-pound section was adopted. In the city proper, side pulls are used on some of the lines.

The system is double tracked except a short distance on the Walbrook branch. The total route measurements are 58,634 feet, divided as follows: City hall to Oak street and North avenue, 9,534 feet; Walbrook branch from Oak street and North avenue to western terminus, 19,100 feet; Lake Roland line from Oak street and North avenue to Roland Park, 18,900 feet; Lakeside

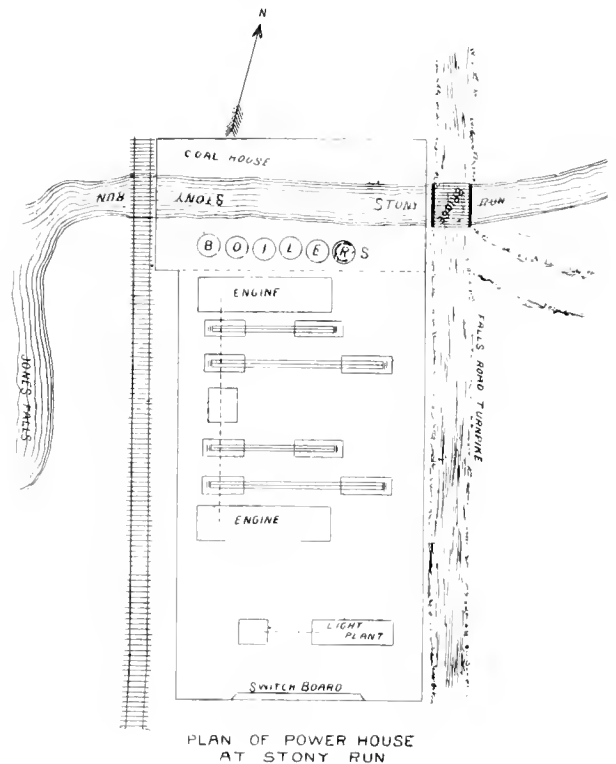

PLAN OF POWER HOUSE AT STONY RUN

extension, 11,100. The company operates a single track for a distance of four blocks west from the corner of North avenue and Lexington street, and a suit is pending to double track this, which will let the Walbrook cars into the retail district.

The officers are: President, James L. McLane; Secretary, Edward H. Bouton; Treasurer, W. Cary McHenry; General Manager, Lawrence N. Frederick. The plans for the elevated structure were prepared by Frederick H. Smith, bridge engineer, Baltimore, Md. The present engineer of the company is W. C. Simmons.

THE LATEST WASHINGTON NONSENSE.

SEVERAL months have elapsed without any distinguishing congressional interference with the Washington, D. C., roads. The latest is a bill introduced providing for a district commissioner to examine all gripmen and motormen before the companies are allowed to employ them, and practically to superintend all repairs on the line and power house. It has been discovered the bill was drawn by an ex-employee, with a view to assess each grip and motorman \$5.00 for each examination. As the employe could not accept a position until passed on by the commissioner, it is needless to comment on the fact that the boys would never escape with merely the five dollars tax. For pure assininity this goes to the head of the class, for if an operating company is not competent to judge of a man's qualifications they had better go out of the business. The Washington employes are well known to rank very high in their work, and the bill, which is an outrage on both street-car men and the companies had best be suppressed or killed.

A RECORD FOR HAZARD CABLES.

ONE of the most practical and brilliant demonstrations of the possibilities of the cable as a motive power in street railway transportation was shown in the record made by the Chicago City Railway Company on "Chicago Day" during the closing month of the World's Fair, when 760,000 people were carried on the various divisions of this company on that day, the cable divisions carrying fully two-thirds of the number. There was not a single accident nor a moment's delay in the operation of machinery and cables.

Under enormous tensile strain, the twelve steel cables, all made by the Hazard Manufacturing Company, of Wilkes-Barre, Penna., bore swiftly and smoothly the crowded trains of three and four cars each without the visible or apparent breaking of a single wire.

It was a splendid test of the capacity of a cable road to meet promptly and successfully an extreme emergency. Never in the history of any street railway has such a throng of people been carried in a day. However, this experience will remain as a valuable precedent to this company, as showing what its fine mechanical equipment and splendid administration could accomplish, and it will be a valuable object lesson to other street railway companies, which have chosen or will choose in the future the cable as a means of sure and rapid transit.

An adjustable platform wagon is evidently a tip-top arrangement.

A STALWART STACK.

THE big new power house of the Brooklyn City Railroad Company, at the corner of Kent and Division streets, Brooklyn, has just celebrated the opening of its big smoke stack. The station and stack were designed by F. S. Pearson, of Boston, and were supervised by M. G. Starrett, chief engineer of the Brooklyn Heights Railroad Company, and his assistant, F. B. Hall.

The foundations of the stack consist of 1,201 piles, seven feet of concrete and fourteen feet of stone work. The chimney is built of hard burned brick, laid in Portland cement, and was four months in being erected. It is constructed in the very best possible manner. It is designed to carry off the waste gases from thirty-six 500-horse-power maximum capacity Babcock & Wilcox boilers in connection with Green fuel economizers. Draft is forced by two 12-foot blowers.

The total height of the stack is 292 feet 6 inches. The height to the cap is 290 feet. The diameter at the base is thirty-eight feet three inches, with a flue diameter of seventeen feet. The granite base is thirty-six feet six inches square. Up the middle of the flue rises a "baffle plate" of fire brick to the height of sixty feet. The iron cap surmounting the stack weighs five tons and is twenty-seven feet ten inches in diameter. The header gains entrance to the flue at the height of forty-five feet. It is estimated that 2,000,000 brick were used in constructing this chimney, and on its completion some sixty workmen took lunch in the flue to celebrate the termination of their work.

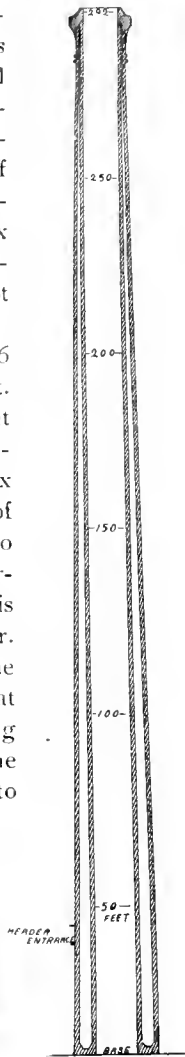
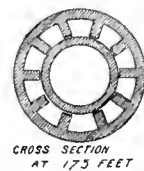
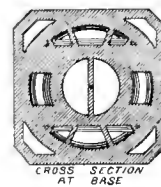

BLESSED is the manager who hath his snow plows overhauled and the loins of his motors girt up and ready; yea, twice blessed is he that hath his joints all raised, and in his barn a large portion of salt. For verily, this shall be a hard, cold winter; even like unto the good old times of the fathers, when the running of street cars was a burden, yea verily, even hard sledding.

TWENTY-TON switching locomotives have replaced the 10-ton machines on the Brooklyn bridge.

THE managing director of the Madras tramway is named Chalk. He ought to make his mark in the world.

PLEASURE RESORTS AND CREATED TRAVEL.

How to Make Popular Attractions in Various Localities and Under Different Conditions.

PART I.

OUR readers will bear us out in the statement that from the very first issue of this magazine we have constantly urged the advantages of pleasure resorts as a means of inducing and creating travel. The development of such resorts has largely been a matter of the past few years, and with several notable exceptions the last three years. Until quite recently a board of directors which would spend \$100,000 for this purpose would have in most cases failed of re-election at the next stockholders' meeting. Even with the history of many successes, other roads have yet doubted their own ability to duplicate those good results, or have dismissed the subject on account of what has seemed to them the entire want of natural advantages on which to start. It is not to be denied that such attractions as lakes, rivers, woods and hills are to be chosen if possible, as sites for resorts, and usually offer more striking results with small expense. Water always is attractive, affording boating, bathing and fishing in the summer, and skating in winter. Where these natural facilities exist the manager has so much at hand, ready made, he can commence on a very unpretentious and economical scale, as people shut up all the week in city houses find a grateful change if only in rocks, trees, wild flowers and pebbly beaches. To add to these cheap walks, settees, tables for picnic dinners, good drinking water, a shelter from sun and rain, and a fleet of row boats can be accomplished with very little money and forms the nucleus of a popular resort. How this has been worked out in various parts of the country will be the subject of this series of articles, as also what can and has been done in less favored places, in one case at least where nothing more romantic than a corn-field was available, but which was transformed into a pretty park, drawing large crowds and profitably remunerating the company which had the pluck to work the transformation. Where Nature has done the least man must do the more, and we firmly believe no road is so unfortunately endowed in its location but can make a successful effort in some one of the numerous directions to be elaborated further on. Practice is better than theory in this matter, and we shall therefore begin with a description of resorts which have already become fixtures, and while the conditions are perhaps the same in no two cities, the suggestions of what others have done may be helpful in planning for each individual case. And now is the time to plan for next summer's pleasure riding. Not every road has parks of natural beauty in the neighborhood but it is yet to be proven that such places are either the most profitable or the least expensive to maintain. However there is a way to induce pleasure riding in every locality. Let us in this article see what some small roads have done. One of the most

noted places for pleasure riding is Decatur, Ill. The City Electric Company of which W. L. Ferguson is superintendent is the owner of two parks to which great crowds flock in the summer and the lines also extend to other places of amusement and resort. Riverside Park is a romantic piece of ground about a ten-minute ride from the center of town. While possessing great natural beauty it was not an expensive purchase as the land was good for nothing but pasture, so steep are the bluffs. The idea of buying a cow pasture along the Sangamon river and building the street railway lines to it through a thinly settled part of town was laughed at by many, but the company went ahead with its venture and was successful from the start. The route to Riverside Park is fast becoming thickly built up with the best class of residences in the city. As for the park itself it took no great length of time for people to appreciate that the cow pasture was really a beautiful spot and it needed only a means of transportation and a few artificial attractions to make people flock to it. The company now has on the park a natatorium, having a pool 30 by 70 feet and from two to ten feet deep. The water is furnished from a spring in a neighboring ravine, the pressure being sufficient to force the water over the intervening hill to the natatorium. A boiler is provided to heat the water before it is let into the pool. On the river the privilege of owning and renting boats is leased to a company which owns fifty small row boats, and three steam launches, each capable of comfortably carrying twenty-five people. Skating is the source of much travel during the winter. The street railway has built a stage on the grounds, and with the aid of a few seats and an awning a theatre is provided, the bluff furnishing the necessary slope. Last summer an opera company played a several weeks engagement there. It is arranged so that admission can be charged if thought best. There is also a pavillion for refreshments. No intoxicating drinks are sold. The park covers fifty acres. Oakland park, another plot of land owned by the company, is of fifteen acres and is used principally for camp meetings, three important ones being held there last year. A Sunday school excursion from Terre Haute the past summer brought 2,300 from out of town to Riverside park, and similar excursions are continually coming to Decatur during the summer season. In some cases the railroad tickets included coupons for street car fare.

AT CHAMPAIGN, ILL.

In strong distinction to the Decatur resorts is the one fitted up last summer at Champaign. At the latter place the attractions had to be purely artificial, as the country is as flat as a billiard table, and with no river near. The first stage of the proceedings was to buy up a cornfield just outside the western city limits. This was, in the opinion of some people, a very foolish move, but B. J. Harris, Jr., the enthusiastic but level headed young president, knew what he was about as subsequent events proved. The fitting up of the West End park was delayed by the want of material until it was barely com-

pleted for the Fourth of July, but on that day the road carried 15,000 people and the switchback in the park 3,800. The fare for a ride on the switchback is five cents, and it nearly paid for itself the first year. The only running expense is for two attendants. The park is a level plat of ground of six acres. The principal improvements are the switchback, an amphitheatre in front of the base ball ground and a pavillion for dancing and refreshments. Free tennis courts are scattered over the grounds, and electric fountains on a small scale will help make the grounds attractive in the future. Arc and incandescent lamps are used plentifully around the enclosure, and shade trees will in a few years make the West End

foot ball games. For certain weeks of the year the control of the park is given to a driving association, which holds meetings there, and attracts large crowds.

HUTCHINSON, KANSAS,

affords a good illustration of what a small road can do. Having only 10½ miles in all, and operating twelve cars by horses, the company secured a pretty park of seven acres, on the river, about a mile from the business center, and erected an auditorium, capable of seating 2,500, and in fact the largest in the state. Hutchinson is centrally located, and the railway superintendent keeps track of all state gatherings and succeeds in locating most of them in his city. The Park and auditorium are tendered free, and the road is satisfied with hauling the visitors, which it does to such an extent that the earnings the first year the scheme was tried paid for the building. Among the State meetings and attractions secured have been: Barnum's show, gathering of State bands, four grand lodge meet-

**WEST END
PARK**
A MOST DELIGHTFUL PLACE
TO SPEND AN AFTERNOON OR EVENING.
OPEN AT ALL TIMES! No charge for admission unless otherwise announced.
Special care given Ladies and Children afternoons.
Keeper and Attendants always in charge.
BEST OF ORDER GUARANTEED.



GREAT PATENT SWITCH-BACK RAILWAY!

ABSOLUTELY NEW! ORIGINAL! UNIQUE!
An Exhilarating and Enjoyable Ride One-Quarter of a Mile. Fifteen Cents
Runs from 1:00 p. m. to 6:00 p. m., 7:00 p. m. to 10:30 p. m.

PAVILION! Electric Lights, Easy Chairs, Good Music, and Fine View.
CASINO! Dancing, Promenade and Band Concerts, First-Class Refreshments.
Grand and Band Stand, Base-Ball Grounds, Free Tennis Courts and Swings, Walks, Seetees and Shade. Park Lighted by Electricity.
Special Arrangements Can be Made for Gatherings and Sociables. Electric Street Cars Run Into the Grounds.
For Special Attractions and Announcements see Daily Gazette and Street Car Signs.
Intoxicating Liquors NOT ALLOWED on the Premises.
WEST END PARK CO., Champaign, Ill.
B. F. HARRIS, JR., Pres and Gen. Mgr.

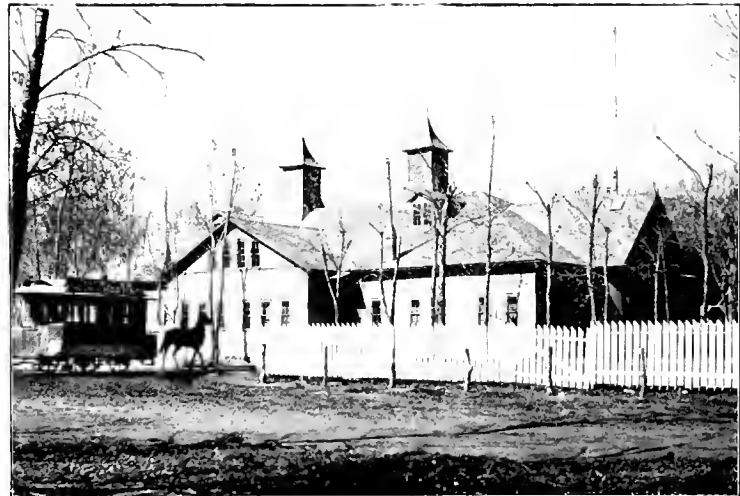

HUTCHINSON AUDITORIUM.

ings, Christian Endeavor, Grand Army of the Republic, State encampment, Forepaugh's show, Teacher's State association, besides numerous concerts, camp meetings, old settler's meetings, etc., etc. Each of these have earned the road from \$100 to \$1,000. Riverside Park, in which the building stands, is a pretty spot and a favorite resort for the citizens of Hutchinson.

THEY TORE UP THE TRACKS.

ONE hundred lusty laborers, headed by the Superintendent of streets, who played the star part, and a street railway company, enacted a little drama in San Francisco not long ago. The properties were 100 picks and shovels and the Bush street railway track from Central avenue to Buchanan street was chosen as the stage. The playwright was his honor the mayor, who sent forth proclamation to the minions of the street department, that whereas the said track was a nuisance and a weariness to the flesh it should be pulled up and cast forth. In 1885 the original franchise was granted.

Park a beautiful retreat. It is the aim of the management to make this the resort for the best class of people.

Another town most favorably situated as regards natural resorts is

PEORIA,

the bluffs of the Illinois river and the mineral springs combining to make parks easily available. The principal resort of the Central Railway is known as Central park. It occupies ten acres on the bluffs, and is leased to outside parties, who maintain a bath house supplied with water from the mineral springs on the grounds, and refreshments are of course available in the park. The Central Railway also owns Lake View driving park. This park is made free to the managers of base ball and

Some say the franchise was granted for spite. However, three years later the Sutter street railway company acquired the franchise and built a line between certain streets. It is claimed by the mayor that the line was not operated frequently enough and that the franchise agreement to spend \$500,000 on the grant had never been fulfilled. The Sutter street company obtained a temporary injunction after two blocks of line had been demolished. A large crowd watched proceedings during the entire day.

THE LOWELL & SUBURBAN STREET RAILWAY COMPANY.

TWENTY-FIVE miles north of the Hub of the Universe lies considerable of the machinery that makes the Hub go 'round and by the same token one of the towns whose name is a synonym for industry.

That is Lowell, Mass.

Situated on the bank of the Merrimac river, with mag-



TYNG'S POND.

nificent facilities for all purposes of manufacture, Lowell has in America the same significance that Birmingham or Manchester have in England.

The population of Lowell is 80,000 and it is intimately connected with the lively towns of Dracut, Tyngsboro', Chetensford, Billerica and Tewksbury, not only by the magnificent street railway system that is the subject of this sketch, but by the bonds of political power and commercial importance. It is this that makes the Lowell and Suburban possible and it is the Lowell and Suburban that gives Lowell the surrounding citizenship making a total in the area of 100,000.

The street railway system, holding exclusive franchise, has now 49 miles of operative track. In 1885 the total was six miles, thus making the very respectable addition of 43 miles in the last few years. All of the system is operated electrically.

The Lowell & Suburban is the direct result of the consolidation of the Lowell & Dracut Street Railway Company and the Lowell Horse Railroad Company. This consolidation was effected June 1, 1891. In August of

the same year the electric franchise was ordered to be acted upon and the revolution began. The capital of the company was increased to \$400,000 and bonds issued to the amount of \$1,000,000 secured by mortgage and bearing 5 per cent for 20 years.

This enabled the company to begin the building of 18 miles of new track, doubling 14 miles and equipping a station of 2,500 horse power. The additional equipment has followed in the past year.

Lowell as a manufacturing center is the principal pleasure of the inhabitants thereof and the humming of looms the most generally accepted form of music. There was no outlet, no summer resort, no play ground, no pleasure spot easily accessible to the great toiling public of Lowell.

There was, however, situated five miles from the central portion of the city in the townships of Tyngsboro and Dracut a beautiful little lake called Tyng's pond. It was about a milesquare and the shores were dreams of sylvan shade and wooded slope. The primeval pines and oaks flourished undisturbed. Nature had intended that at some future day all Lowell should come from the dusty loom and humming spindle and breath fresh air and hear the wind hum in the trees and see the Massachusetts sky clear and cloudless. Man, however, did not take interest enough in these advantages to find a way to utilize them.

This was the Lowell & Suburban's opportunity. So in 1889 an electric to the lake was planned. To get there required the grading of three miles of highway, and the building of three new public highways in conjunction with the town and county. The line was opened for public travel August 1, 1889, and operated until November 1 of the same year. That was the first season and first success. The resort was christened Lakeside and the following season the original six motors and six trailers were added to by sixteen motor cars and a more extensive feeder system.

This year, 1893, the line was changed from single to double track and wired for 34 cars with a business increase over last year of more than 60 per cent.

Now it stands to reason that Lowell's population didn't go to Lakeside simply to breathe and see green trees. People, in spite of poets to the contrary, require nowadays something more interesting.

The Street Railway Company owns and controls over one mile of water front, and 140 acres of park. At the nearest point, the terminus of the line, a large dance hall, restaurant, public and private dining halls, and a banquet hall combined into one building, is erected.

Besides, to entertain those to whom band music hath charms, three band stands are erected. Two buildings for the accomodation of still others, contain twelve bowling alleys, a carousal, stables, carriage sheds, and a theater, at the total outlay of \$100,000.

The theatre is a venture of 1893, and its success was unprecedented. The method of filling the seats is one, that if pursued by managers of greater pretensions and less knowledge, would fill out some sadly wasted pocket books in various parts of these United States. Eight

hundred persons can be seated in the auditorium, but owing to the demand for seats, the capacity is to be enlarged fifty per cent. to accommodate next seasons' crowd. The seats are subject to an admission of ten cents, while ample free standing room is provided for 350. The attractions are clean, morally, and amusing, otherwise.

At the further end of the lake are situated picnic grounds, which are private on picnic days, but at all other times open to the public, in common, with the rest of the

admittance is free to all, whether the patrons of the car service or not. As the resort is conducted on a strictly temperance basis, the best of order is easily enforced, and first class people are liberal in their patronage of the privileges.

The park and the buildings are brilliantly lighted by electricity in the evenings from the company's power house, five miles distant.

The fare to the park is in the form of a round trip coupon ticket, good from any point on the line, in the

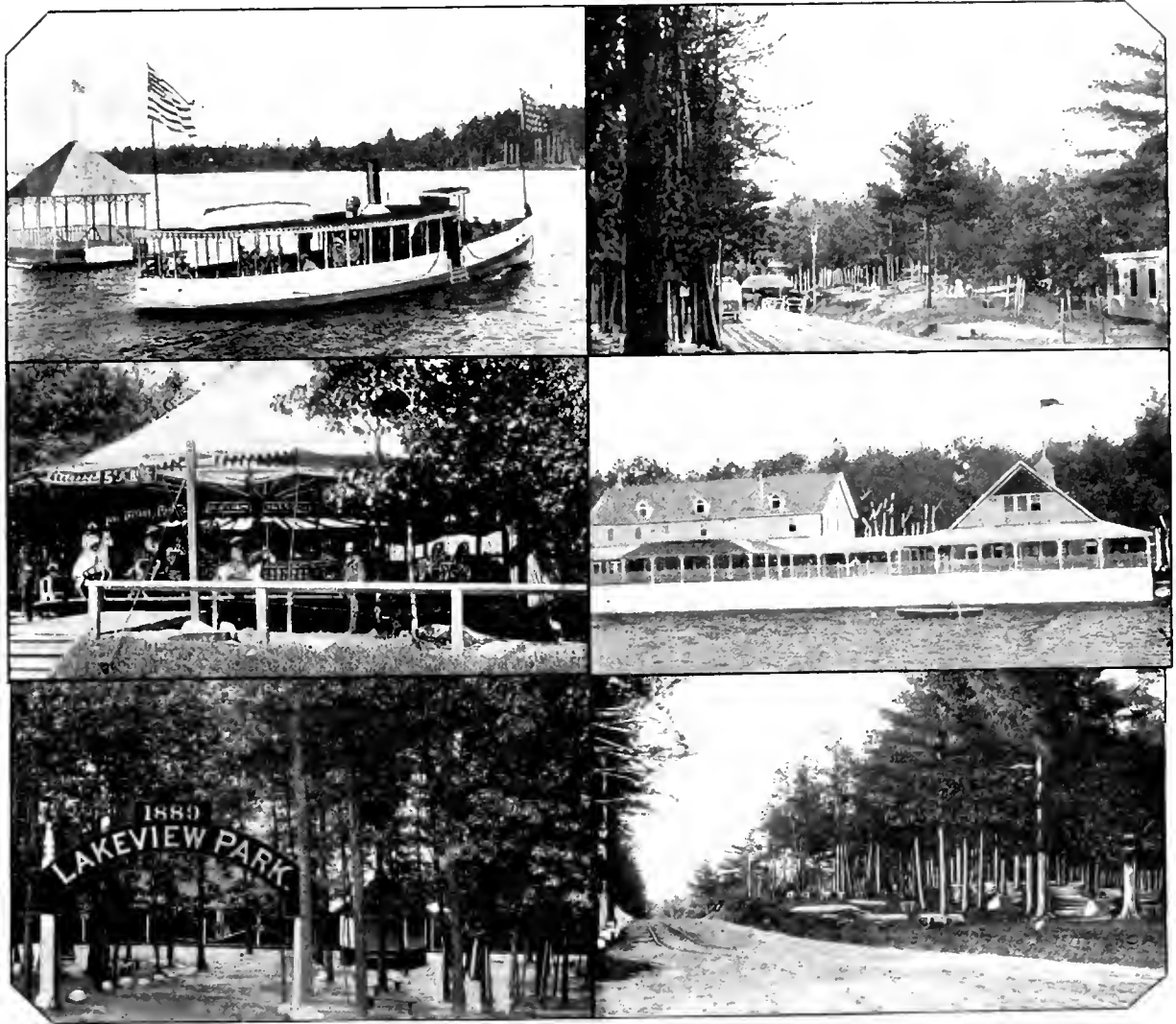

THE LOWELL AND SUBURBAN PLEASURE RESORT.

park. People are transported to these grounds and returned by a steamer, with carrying capacity for 150.

The company owns two steamers, the one referred to and a smaller boat, carrying 30. The steamer rides are reduced to the lowest paying price and are always liberally patronized, nay, jammed, at five cents a round trip. Sixty row boats, also owned by the company, stand awaiting the pleasure of the aquatically inclined, at so much an hour.

The summer program consists of every variety of concerts, fireworks, regattas, and dances, to which the

city of Lowell, to the resort and return. They are sold at 20 cents. The longest possible ride on the system, is twenty miles which, is not often taken advantage of.

The increase in passenger traffic, for the past few years, has been enormous.

In 1886, the gross receipts were	-	\$ 82,027.29
In 1893, the gross receipts were	-	272,961.50
The intermediate years show as follows:		
Receipts, 1887	- - - -	\$111,059.54
Receipts, 1889	- - - -	173,005.91
Receipts, 1891	- - - -	221,284.59

The officers of the Lowell & Suburban are: President, E. M. Tucke; vice-president, August Fels; treasurer, Percy Parker; and P. F. Sullivan, general manager, to whom the road is indebted for its superintendence during the change of motive power, and to whom the people of Lowell give thanks for this magnificent play ground, and whom the readers of the REVIEW may thank for the excellent illustrations and suggestions contained in this article.

Mr. Sullivan says, in regard to summer resorts and induced traffic: "In a general way, I would state that in my opinion, a summer resort, properly conducted, keeping in mind the wants and tastes of each particular locality, is sure to be a profitable source of revenue to an electric railway."

THE FOWLER SNOW SWEEPER.

THIS sweeper needs, perhaps, no other comment or recommendation than its name, and the accompanying engraving which shows the elegant proportions and the effective gearing of the machine. The cab is well protected so that the crew may give strict attention to running the sweeper and not to fighting the

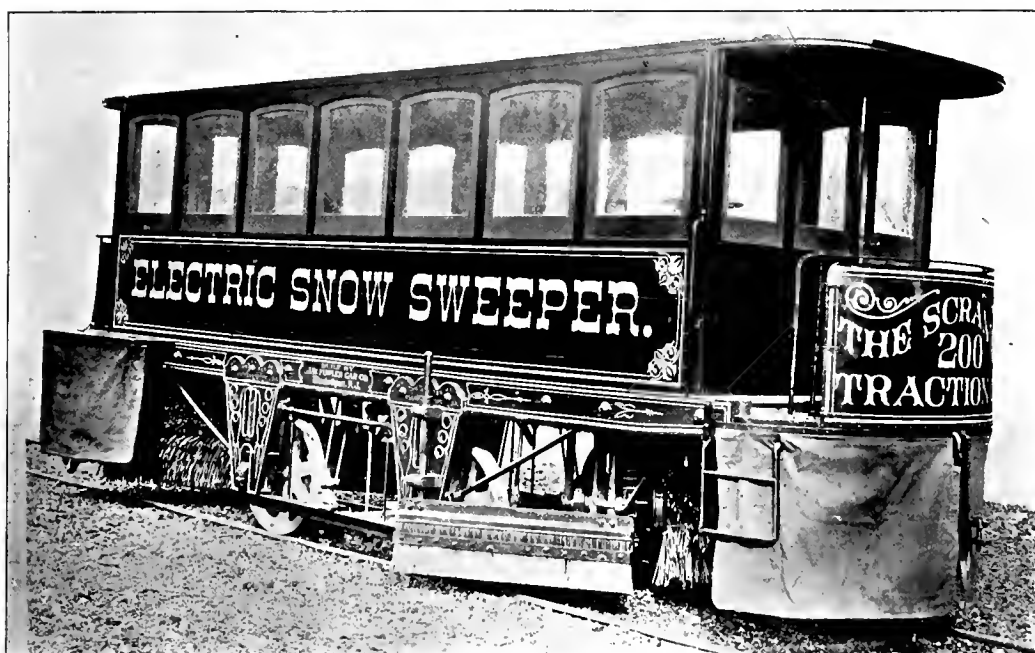

THE FOWLER ELECTRIC SNOW SWEEPER.

weather. The rotary brushes, the efficiency of which will not be found wanting during the snows of this coming season, are run by separate motor, giving the greatest possible sweeping power and speed, regardless of the speed of the car. This independence of the brush speed can not be overestimated. The height of the sweeper body above the rail, and the strength and compactness of the construction, may be as well judged from the engraving as the solidity and honesty of the material may be judged from the name of the maker, borne on the side. The sweeper shown is one bought by the Scranton Traction Company.

CANADIAN VOLTS.

THE Montreal Street Railway has been permitted by the legislature to increase its capital stock to \$5,000,000. At the same time it was given power to acquire the rights and powers of any other corporations or companies on the island of Montreal; to amalgamate with any such corporations or companies; to lease the lines of other railway companies; to make running and traffic arrangements with other railway companies; and to expropriate property for the purpose of its railway. It also received the confirmation and ratification of the agreements, lately entered into between it and the city of Montreal, the town of Maisonneuve and the town of Cote St. Antoine, Que.

A large delegation, representing the Canadian cities of Hamilton, London, Montreal, Peterboro' and Ottawa, is trying to have steel rails for electric railways put on the free lists at Canadian ports. When the tariff was arranged there were no such things as electric railways and no provision was made for them. Now, steam roads have rails admitted free, but electric railways pay \$6 a ton custom duties. This is unjust and hence the petition.

THE Philadelphia board of health has drafted a series of serious resolutions concerning the dangers of spitting in the street cars. The board says tuberculosis is rapidly propagated thus.

THE scheme of the Duluth Street Railway Company for crossing the bay between Connors' and Rice's points is said to be a combination boat and sled. In summer the vehicle will run as a boat and in winter as a sled. An endless cable will be the power. A. C. Mayo will build the craft. A number of Duluth cars have been vestibuled,

STREET RAILWAY LAW.

EDITED BY MR. FRANK HUMBOLDT CLARK, ATTORNEY AT LAW, CHICAGO.

Electric Railway Crossing Steam Railway at Grade.

An Act under which an electric railway was incorporated, authorizing it to cross at grade, any railroad operated by steam or otherwise, cannot be construed to deprive the State of its power to exercise police supervision, and prohibit a crossing which would evidently be dangerous to public travel.

In the opinion the court said: More than twenty years ago the necessity for special judicial control of corporations, and especially railroads, assumed tangible form in the passage of the Act of June 19, 1871, entitled "An Act relating to legal proceedings by or against corporations. The second section declares "when such legal proceedings relate to crossings of lines of railroad by other railroads, it shall be the duty of courts of equity of this commonwealth to ascertain and define by their decree the mode of such crossing, which will inflict the least practical injury upon the rights of the Company owning the road intended to be crossed, and if, in the judgment of such court, it is reasonably practical to avoid a grade crossing, they shall, by their process, prevent a crossing at grade." The manifest purpose of this is not merely to discourage grade crossings because of their danger to the public, as well as injury to the company whose road is crossed, but also to prevent them, whenever in the judgment of the court, it is reasonably practical to avoid such dangerous and injurious crossings. As an exercise of the police power of the State, the wisdom of the provision has become more manifest from year to year as railroads multiply.

It is claimed by defendant, however, that the 18th section of the Act of 1889, under which it is incorporated expressly authorizes it "to cross at grade, diagonally or transversely, any railroad operated by steam or otherwise, now or hereafter built." If, by the language thus employed, the Legislature intended, not only to barter away the police power of the State in regard to such grade crossings, but also to limit the jurisdiction of the Courts of Equity in relation thereto, then indeed the learned Judge fitly characterized such legislation as "exceedingly vicious"; but we cannot think any such construction as that should be given to the 18th section of the Act. It is a well-recognized principle of legislation that grants of franchises are made and accepted in subordination to the police power of the State. We are therefore warranted in concluding that a surrender of that power was neither effected nor intended to be made by the Act under consideration. Nor do we think that the jurisdiction conferred by the second section of the Act of 1871 was in any manner restricted or limited by the Act of 1889. As we have seen, the latter is entitled "An Act to provide for the incorporation and government of street railway companies in this Commonwealth." This title conveys not the slightest intimation of any intention to interfere with the jurisdiction heretofore conferred on Courts of Equity relating to railroad cross-

ings at grade. We have no doubt but that electric railways are within the purview of the Act of 1871. They are certainly within the mischief for which the second section provides a remedy.

(Supreme Court of Pennsylvania. *Pennsylvania Railroad Company vs. Braddock Electric R. Co.* 55 American and English Railroad Cases, 1.)

(NOTE.—See also the case of *Lake Roland El. R. Co. v. Mayor of Baltimore*, 3 Notes of Cases 43. 3 STREET RAILWAY REVIEW 494 and note.)

Contributory Negligence—Fireman on Ladder-truck—Collision with Street-car.

The plaintiff, a fireman, was injured while riding to a fire on a ladder-truck, by a collision with a horse car of the defendant company. On each side of the truck was a running-board extending between the wheels, and above this another running-board. On first starting out plaintiff was standing on the running-board, but as he had not fully equipped himself before starting, he shortly proceeded to complete the equipment by buckling around his body a "dogman's belt." For the purpose of holding on while doing this he lifted his left leg from the running board, and placed it between the rounds of the uppermost ladders. The ladders, which projected several feet in front of the body of the truck, struck the corner of the car and were forced suddenly back, cutting plaintiff's leg off at the knee. There was evidence that the fireman had not time to dress before starting for a fire, but did so while on the way.

The defendant asked the court to charge the jury "As the plaintiff was riding on the ladder-truck, with his left leg down between the ladder-rounds while the truck was going to the fire, he was not in the exercise of due care, and cannot recover." This the court refused. He could not be expected to use the same degree of care as might properly be required of one who had no special duty to perform as he had. Considering his duty and the exigency of the occasion, we cannot say that he was not in the exercise of due care.

(Massachusetts Supreme Judicial Court. *Magee vs. West End St. R. Co.* 23 Northeastern Reporter 1102.)

City Ordinance—Care to be Exercised by Conductor and Driver of Car.

Rev. Ord., St. Louis 1887, art. 6, sec. 1246, sub. 4, providing that "the conductor and driver of each car shall keep a vigilant watch for all vehicles and persons on foot, especially children, either on the track or moving towards it, and on the first appearance of danger to such persons or vehicles the cars shall be stopped in the shortest time and space possible," is valid, since, under the charter of the City, franchises are granted to street railway companies on condition that they submit to all ordinances regulating them: and it is competent, therefore, for the city, in consideration of the franchise granted, to

impose by ordinance the duty of exercising a high degree of care, and their failure to observe the ordinance renders them liable to the person injured, notwithstanding a fine is also imposed for such failure.

(Supreme Court of Missouri. *Fath v. Tower Grove and L. R. Co.* 16 Southwestern Reporter 913.)

Dray stopped on side of street—Collision with street-car—Miscalculation as to Room to pass.

In an action by the driver of a dray against a street railway company for personal injuries, it appeared that plaintiff stopped his dray at what he thought was a safe distance from the car-track, and was putting a blanket on his horse, when he was struck by defendant's car. The driver of the car, who was driving "a fair gait," thought he had room enough to pass plaintiff and his dray. Held, that the accident being caused merely by miscalculation as to distance on the part of both plaintiff and the car-driver, a non-suit was properly entered.

(Supreme Court of Pennsylvania. *Patton vs. Philadelphia Traction Co.* 20 Atlantic Reporter 682.)

Injury to Person Driving Across Track—Driver not Watching Track—Contributory Negligence.

While plaintiff was attempting to drive across a street-car track, her carriage was struck by defendant's car, which was then going down grade. Witnesses testified that the car-driver had time to stop the car after plaintiff drove on the track had he not looked down a cross street; but it appeared that when he crossed this street, no one was on the track or offering to cross in front of him, and it was not shown that his attention was unnecessarily, or for an unreasonable time, withdrawn from the track, and, the accident occurred despite his efforts to stop, though he applied the brakes at once. Held, that there was not sufficient evidence of negligence on the part of the defendant to warrant submission of that question to the jury.

Plaintiff knew that a car was coming and was near having heard bells, but could not see it until she turned her horse on the track; and she testified that she then thought there was time to cross. The car was moving at the usual rate on a down grade, and plaintiff's horse was moving at a slow walk. Held, that plaintiff was guilty of contributory negligence barring recovery.

(Supreme Court of Pennsylvania. *Citizens Pass. R. Co. vs. Thomas.* 19 Atlantic Reporter, 286.)

Elevated Railroad—Station Projecting into Street—Action by Abutting Owner.

Though an elevated railroad company constructs a station projecting into a side street, infringing on the public right therein, an abutting owner, in his capacity as a citizen only, cannot maintain an equitable action for its removal, nor can he maintain it as such abutting owner where it does not appear that he owns the soil occupied by the station, nor that he has sustained any substantial injury, by the encroachment, to any right appurtenant to his premises.

(Court of Appeals, New York. *Adler v. Metropolitan El. R. Co.* 33 Northeastern Reporter, 935.)

Assignment of Street Railway Company—Enforcement of Duties to the Public—Mandamus.

The performance of the duties which a street railway company owes to the public, to operate its lines in accordance with the provisions of a City ordinance under which its road was constructed, may be enforced by mandamus.

The City of Potwin Place granted to the T. R. T. Ry. Co. the right to construct a street railway on certain streets, under an ordinance requiring a stated car service to be furnished by that company. Said company thereafter executed and delivered to defendant a deed by its terms granting, assigning and conveying to the defendant all franchises, powers, privileges and immunities possessed by it, and its line in plaintiff City. Defendant accepted said deed and operated said line for a time. Held, that the defendant thereby assumed the performance of the duties towards the public, which before rested on the grantor.

The granting of a writ of mandamus rests largely in the sound discretion of the court, and where it is asked to enforce the performance of a duty to the public, the interests of all the people concerned will be regarded, and the writ will be so framed as will best preserve and enforce the rights of all parties.

(Supreme Court of Kansas. *City of Potwin Place v. Topeka &c. R. Co.* 33 Pacific Reporter, 309.)

Injury to Person in Elevated Railway Station—Evidence.

The mere fact that the rubber covering on the stairs of defendant's elevated railroad station was out of repair and caused plaintiff to fall, without any evidence that the defective condition of the stair existed before the accident, is not sufficient to charge defendant with want of ordinary care in respect to the stairs.

In an action for injuries caused by falling down the stairs of defendant's elevated railroad station, plaintiff's evidence merely showed that she caught her heel on one of the steps and fell, and that after her fall the rubber covering on one of the steps was observed to be loose; but no witnesses saw her trip on the rubber, and there was no evidence as to its condition before the accident. Held, that the complaint would be dismissed for failure to prove that defendant was negligent.

(Court of Common Pleas of New York City. *Millier vs. Manhattan R. Co.* 25 New York Supplement 753.)

THE Interstate terminal railway bridge at Council Bluffs is finished and the electrical apparatus for the great draw-span installed.

AN accident on the Lowe Mountain road, of Pasadena, Cal., nearly cost a careless motorman his life. The car ran down the mountain and both employes jumped. The car and trailer were smashed. No passengers were hurt.

HALF FARES.

Interesting Facts from All Parts of the Country, Boiled Down for Busy Readers.

Two Youngstown, O., street railway employes have been arrested for making counterfeit money, mainly of 50-cent pieces.

THE church going people of Hamilton, Ont., are urging a Sunday street car service during hours of services.

McKEESPORT, PA., has successfully tried the substitution of the electric railway cars for hearses, for burial services, during the cold weather.

THE Brooklyn Traction Company, operating the Atlantic Avenue Railroad Company lines, has absorbed the Broadway Railroad Company, of Brooklyn.

SALICYLATE OF TOLYLDIMETHYLPYRAZOLON has been patented in this country by Herman Thoms, of Berlin, Germany. No wonder it takes months to get a patent.

SUPERINTENDENT CROSLY, of the Vallamo Passenger Railway, Williamsport, Pa., is the inventor of a car fender, which is said to clear the tracks with neatness and dispatch.

THE compressed air scheme to run cars in Leavenworth has come to an end, and the \$250,000 bonus which has been tied up in escrow two years, now reverts to original owners.

SMOKING is now allowed on the Chicago Alley L, on the south car of all trains. It is said that the change was wrought by demands of smokers who would otherwise patronize the cable.

THE Cleveland Electric Railway Company has introduced a new system of transfer, doing away with the transfer agent. The conductors will hereafter transfer their own passengers.

THE Washington, Alexandria & Mt. Vernon Electric Railway Company has ceased its Sunday service, except an early morning milk train. The road does this on account of the small Sunday patronage.

GARBAGE cars was the subject of a recent experiment, at night, on the Toronto, Ont., lines. The haul one way is five miles, and a contract with the city is probable, as a great saving in expense was demonstrated.

BATTLE CREEK'S street railway has been allowed to suspend operations, until May 15, by a considerate town council. The other street railway men in the state are rather envious of the Battle Creek line's luck.

THE REVIEW wishes to acknowledge the receipt of tickets to the laying of the corner stone of Engineering Hall, of the Illinois State University, at Champaign.

President B. F. Harris, of the street railway company, is no doubt the donor.

THE management of the North Chicago Street Railroad, states that it is the intention to light all the cars on the system with Pintsch gas, a plant making this gas for the Connelly motor being already in operation.

THE Canton City lines, of the Canton-Massillon Street Railway Company, devoted the entire proceeds of thanksgiving day to the associated charities, for distribution to the needy poor. In many cases no change was taken from conductors, and a check for \$120 was handed to the treasurer of the charities.

AN enterprising merchant in Toronto, Canada, printed a lot of tickets in imitation of those used on the street railway, with an advertisement on the reverse side. So much trouble was caused by people attempting to pass them on the cars, the company was obliged to take legal steps, and have destroyed some 30,000 tickets, which had not yet been given out.

THE West End street railway, of Boston, elected the following officers for the ensuing year, December 3: President, Samuel Little; vice-president and clerk of the corporation, Prentiss Cummings; treasurer, Joseph H. Goodspeed; general manager, C. S. Sergeant; auditor, H. L. Wilson; purchasing agent, H. F. Woods, and general solicitor, Henry S. Hyde.

SENSATIONAL suits, involving the affairs of the San Francisco & San Mateo Electric Railway Company, have been filed. The most important, filed by J. Douglass Saunders and John B. Muirhead, alleges that both the construction company and the two Joosts, are seeking to acquire the entire property of the San Francisco & San Mateo electric railway. Severe strictures are also made upon the honesty of the original franchise.

It has been generally reported that the Lynn & Boston electric system are to put on an express and light freight service. Aside from using one freight car, twenty feet long by six high and wide, for its own service, nothing has been decided. Their system is admirably adapted for such a service, covering 150 miles of track and connecting eighteen towns and cities, and it is to be hoped the experiment will be made, although it seems to us the element of uncertainty of success is very small.

AT the recent fire on West Madison street, Chicago, which consumed the Haymarket theatre, a careless gripman ran his train too close to a fire hose, and before he knew it another line of hose closed him from behind. The day was fearfully cold and the spray from the engines froze in the street. The street soon became a young canal. The grip car and trailer, unable to get away, were frozen to the track. The sight of the frozen car attracted a large crowd until the wrecking wagon relieved the line.

THE JACKSON & SHARP COMPANY.

To their World-wide Reputation as Builders of Steam Cars will be added that of Street Cars.

IF seven-eighths of the traveling public were asked what is Wilmington, Delaware, noted for, at least three-fourths of this seven-eighths would point to the car door and say, "Jackson & Sharp."

In fact, throughout the length and breadth of the land no other Delaware industry is so well known. The present interest to the readers of this article centers in the recent news that this company, so famous as makers of railroad cars, is about to begin the making of cars for street railway purposes. Time was when street car building was more closely allied to the coachmakers' trade than to the carbuilders' art. Now, however, strength and capacity are as necessary as lightness and

12 acres of land at the confluence of Brandywine Creek and Christiana river, with good wharfage and with the P. W. & B. Railroad tracks running directly in front of the place. The locality thus affords the best of shipping advantages both by land and water.

It is needless to speak of past work or present facilities, as these go without saying, in an establishment of such age and responsibility. It may be remarked, however, that 7,000,000 feet of well-seasoned lumber is kept in stock, with sheds for 2,000,000 feet of dry lumber. Two immense cargoes of Oregon pine are brought each year from Vancouver, B. C., it having been found superior to our own southern pine. The standing room in the erecting shops and paint shops is sufficient for seventy-five standard steam cars or perhaps two hundred and fifty street cars. Storage room for seventy-five to one hundred more cars is close at hand. In fact, the largest

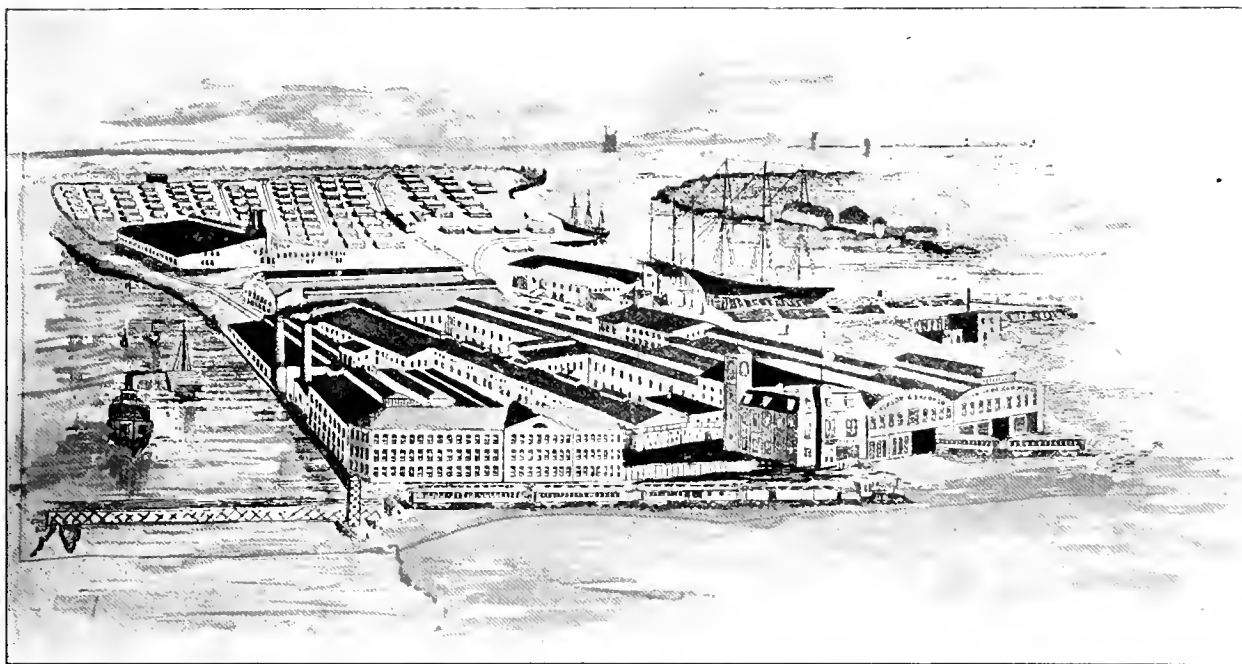

THE JACKSON & SHARP CAR WORKS, WILMINGTON, DEL.

smallness were during horse-car days. Thus the steam car builder succeeded naturally to street-car building and the same skill and care of design is exercised in both branches.

For thirty years the Jackson & Sharp Company has been building cars. At the beginning there were but 30,000 miles of railroad in the United States, now there are over 100,000 miles. Then only the larger and older cities of the country possessed street railway systems, now over a thousand towns and cities on the continent have some means of intramural transit. In 1863 Job H. Jackson and Jacob F. Sharp founded the now great firm, in a modest way, and by unceasing industry and honest dealing, have so far gained the confidence of the railway world that the company has grown with the growth of this great industry, to its present proportions. Admirably situated, the Jackson & Sharp works cover

order will find a ready reception and a small order quite as distinguished attention. The reputation of the Jackson & Sharp Company can not afford to have it otherwise, nor is street car building entirely unknown in the J. & S. factories. Years ago when street cars were small and the demand for their construction even less, this company built a large number of cars, some of which are still in service. But the tremendous impetus which steam railroad building gave to car construction for that work, kept the shops so full that the street-car department was allowed to lapse. Now that the street railway industry has assumed so large and growing proportions it is eminently proper that the immense facilities and trained labor of this establishment should again enter the field.

A few words concerning the founder of the company will not be out of place, and with the work we introduce the worker.

JOB H. JACKSON.

Mr. Jackson was born in humble circumstances, in Chester County, Pennsylvania, in 1833. In 1847 he went to Wilmington, in the capacity of grocery clerk, and in that and in the hardware trade he remained until his twenty-first year. Then going to work for the Pennsylvania railroad he gained a complete knowledge of the



JOB H. JACKSON.

requirements of railroad service. He also built the first telegraph line from Pittsburgh to Crestline, Ohio. Soon afterward he engaged in the stove business, which he left to found the present Jackson & Sharp Company, in 1863. Always prominent in business circles, he also finds time for the duties of citizenship and has served acceptably in the city council and board of education. With a long

WEBSTER VACUUM FEEDWATER HEATER AND PURIFIER.

At the late World's Fair, held during the summer of 1893, at Chicago, the Warren Webster & Company, patentees and owners of the Webster vacuum feed water heater and purifier, had a magnificent practical showing of this specialty. This heater was the largest in use at the exposition, heating over 60 tons of feed water an hour, to a boiling point, with exhaust steam, and that, too, it is claimed, without back pressure on the engines. This heater was liberally awarded after competitive and thorough tests and will be used at the Mid-winter exposition at San Francisco, whither it has been taken.

The Webster heater consists of a closed iron shell rectangular in form, with a doubly inclined bottom and provided with two inlet pipes, one for exhaust steam and one for cold water. The supply of the latter is automatically controlled by a gravity regulator. An outlet pipe leads to the feed pump from which the hot and clear water is delivered to tank or boiler. The iron case contains a series of oppositely inclined perforated trays, which spread the water over an extended surface and bring it in contact with the steam intimately and thoroughly. A number of parallel pipes open at one end, the center group of which is connected with the inlet pipe. This forms the cold water coil. The opposite ends terminate in a horizontal pipe. This cold water coil absorbs all the rising heat units of the vapor. This assists in heating the feed water which is otherwise warmed by flowing over the perforated copper trays. The heavy impurities now already separated fall to the bottom of the chamber, without agitation, and the light impurities may be drawn

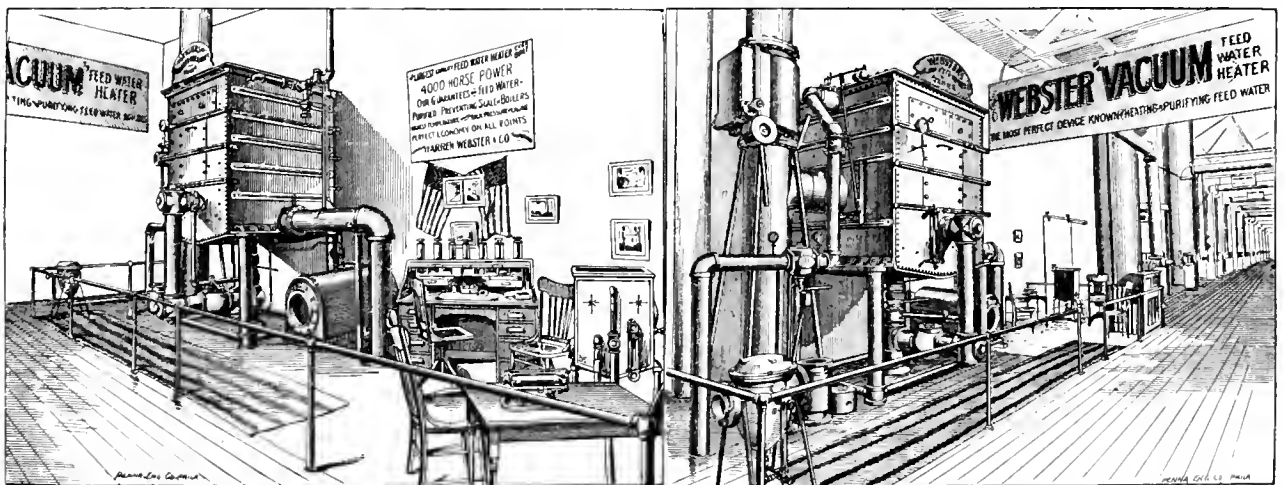

HEATS SIXTY TONS OF WATER PER HOUR.

and valued experience he combines that executive ability which unite to make a leader in commercial enterprises, and which elements of success have made this company so prominent.

The present company is officered as follows: President, Job H. Jackson; vice president and secretary, Ellwood C. Jackson, assisted by Reginald Canning.

off the top. Scum and grease is separated by a hood across the chamber. This heater makes claims to five points: it is efficient, durable, simple, compact, economic.

A plan is proposed for the railway companies carrying to Jackson Park to light the court of honor next summer. It will cost \$125,000 to replace the light plant.

A GENUINE DIPLOMAT.

A woman boarded a Grand River avenue car, at Washington avenue, the other day, who was hopping mad, says the Detroit Free Press. The conductor recognized the fact, and did not reach his paw down and rest it on her shoulder in that benign and fatherly way he had affected all summer. In fact, he would have dodged her altogether, but she stood in the door and surveyed him from head to foot, and demanded:

"Conductor! I want the number of the car which passed up ahead of you!"

"Ye'm—very sorry, ma'am, but I don't exactly recollect whether it was 8,256 or 18,652," he humbly replied.

"But you know the driver?"

"Can't say I do, ma'am. Can't say I know any driver but my own, and he isn't worth cultivating. Anything wrong, ma'am?"

"Of course, there is! I stood right on the corner and held up my hand and he never noticed me!"

"On the upper corner?"

"Certainly!"

"And you held up your hand?"



FORTY TONS OF CABLE.

"Yes, sir!"

"And waved it?"

"Very singular, ma'am. Please let me see your hand."

"There it is!" She snapped, as she held out a hand which a No. 7 glove would have been a tight fit for.

"Ah, ma'am, the mystery is solved!" smiled the conductor, as the color returned to his face. "It's no wonder he didn't see a dainty little hand like that. Why, if you'd held up both hands and one foot he'd have winked and blinked, and hesitated to stop. I thought it was funny. You ought to carry an umbrella or a palm-leaf fan—indeed, you had; unless you want a police whistle with a silver chain to it like some carries. Go right in and sit down ma'am. If I hadn't been looking right at you I should never have supposed you wanted my car."

She hesitated, smiled, gave her hand a toss, and went in and sat down. She did even more. She looked out of the window and smiled at the conductor in a way that

made him stand on his toes and whisper to himself: "Ah, me boy! But cold weather makes no difference with soft soap—not in our line!"

LOS ANGELES RECEIVER'S REPORT.

FROM February 20 to October 13, 1893, D. K. Trask was receiver for the Los Angeles Cable Railway. In his final report and request for discharge Mr. Trask shows that the receipts from all sources were \$201,434, and the total disbursements \$200,042, leaving a cash balance of \$1,391. In addition to the running expense Mr. Trask also paid \$11,740 unpaid debts contracted prior to his receivership, and has settled all damage suits arising during his incumbency. He wishes his remuneration placed at \$1,000 a month. The net earnings of the system during his term were \$43,468. Altogether the receiver's report is a most creditable one, and proves what was always claimed by C. B. Holmes, its principal promoter, that with the revival of business in Los Angeles and good management, the property would bear out the expectations which brought it into existence.

A REEL TRUE STORY.

40 TONS of cable, 40 horses in teams of two abreast, and a large and admiring crowd, are the principal features of the engraving shown on this page, and the incidents in the moving of a reel of wire rope, made by the California Wire Works, San Francisco. The exact weight of the "shoe string" was 79,283 pounds and it was twisted for the St. Louis Cable Railway Company of St. Louis. It was to be delivered to the Southern Pacific Railway Company from the wire company's works at 322 Bay Street. The engraving was reproduced from a photograph and shows everything except the Golden Gate profanity of the drivers when the teams didn't pull together.

THE Third Avenue Railroad Company, of New York, has declared its usual semi-annual 2-per-cent dividend on its \$7,000,000 stock.

THE RETURN CIRCUIT OF AN ELECTRIC STREET RAILWAY.

A Paper Read Before the Wisconsin Electric Club, by O. M. Rau, Electrical Engineer, Milwaukee Street Railway Company.

THE subject of a return circuit for an electric railway system has been the cause of much discussion, both in journals and lectures. The prevailing opinion formed from these discussions, is that the return circuit is insufficient, and that innumerable troubles can be avoided by increasing the return circuit. Hence, the question arises, will this ever be made large enough? The main object of a ground return, is to have as small a loss as possible, so as to avoid the troubles which are attributed to this part of a railway system. An excessive drop of potential in the return circuit, not only gives poor results in the operation of cars, but greatly facilitates the electrolytic action on surrounding metallic bodies, which has given much anxiety to both electricians and city engineers. The ground



O. M. RAU.

has been relied on as a conductor, but to what extent or percentage this medium acted as such, has until lately not been considered; and even at this late date, it is proposed to use the earth through the medium of ground plates, placed at regular intervals along the track, and sunk into the earth to a depth where permanent dampness can be found. To demonstrate the usefulness of these plates, an incident connected with the railway system in this city, will afford a good example. The bridge cable became parted by accident, causing the current to the bridge to be cut off. To avoid delay it was proposed to sink a ground connection at the edge of the river, and another at the bridge, and derive a current in this way to operate the cars and bridge motor. Car wheels, to which were attached a 0000 copper wire, were sunk to the bottom of the river, at a distance of 150 feet from each other, but it was found that a current not exceeding 20 amperes was all that could be obtained through the circuit. Hence, that amount being barely sufficient to operate the draw-bridge motor, the project had to be abandoned and a temporary metallic conductor laid until the cable was repaired. Considering these conditions, where every possible advantage for a ground connection was at hand, it is very evident that the ground plates add very little to the return circuit of a street railway system. To increase the return circuit, so that the loss would be very small, would considerably increase the cost of construction, and it is here where the great trouble lies. It must be admitted that the cost of a good return is certainly very great in the construction of a railway plant, but it is, however, only a simple matter to calculate how long the plant will be in operation before the ground return circuit will pay for itself in the saving it has made. This fact is often lost

sight of, while it should be the primary consideration for constructing engineers.

In some of the earliest electric roads the ground was omitted entirely as a conducting medium, and a return circuit was calculated for a certain drop and the conductor laid accordingly.

In the electrical equipment of one of those roads, each length of track was connected to this conductor (which was of copper) and the bonding, which was not very thoroughly carried out, was only relied on as a substitute. This, although a very expensive construction, proves that the ground return was considered as important, by early electricians, as any other parts of the system. It is only through the saving in the cost of construction that this part of the system has brought itself so conspicuously before the public. With the supply feeder it is a simple question of how much drop to allow for, and calculate the size of the conductors accordingly, and the amount allowable for this drop is readily ascertained by comparing the amount to be used in this part of the system, and the amount the system, while operating, can afford to loose, which is directly dependent on the cost of generating power, but we have a basis upon which accurate figures can be made and we can determine what is going on in this part of the system. In the ground return it is an entirely approximate figure, and in but few roads is it taken into consideration at all; it being simply stated that there is no drop in the return circuit. Since it is a very complicated and difficult matter to arrive at accurately, either by calculation or test, this statement is generally accepted. The return circuit being in the ground escapes the usual inspection which the other parts of the system are subjected to, and any defects which otherwise would be noticed are left to take care of themselves, except when complaints are received from drivers of vehicles whose horses have received shocks; a broken bond or a defect in the return circuit would not be discovered and would receive no attention. During the winter the defective spots on the return circuit are quite easily located, when a faulty rail bond will keep the snow and ice from forming around the joint and a damp spot will there be found while the earth will be frozen around it. A system of bonding where the bond will have the same conducting area as the rail is sufficient with the present heavy rail construction. In a system, however, where a number of independent lines are constructed radiating from one or two main lines this is not advisable, even if the rail bonds and rails have capacity enough to carry the current with a low per-centage of loss. Tracks have to be torn up and repaired and in some cases left out for a length of time. To have the return entirely dependent

on them would cause inconvenience to the repair work as well as an occasional stop on the system. This of course could be avoided if care is taken and the tracks cross-bonded with the up and down tracks, as both are rarely disturbed at one time.

If, however, repairing is done near the power house, where the ground connection is made with the station generators, it is a question whether the carrying capacity of the undisturbed rails is large enough. When such conditions arise, the advantage of return feeders laid to different distributing centers can hardly be discarded. A system thus constructed will not be subject to the criticism of the daily papers, by their reports of runaways caused by a charged rail, and it would assuredly be a great friend to the horses.

This has been very forcibly brought to my notice in this city, where we have both systems of ground return. When out driving the horse will cross the return feeder system track very gently, but when he comes to the tracks dependent alone on the bonding for return, he will try to avoid stepping on them, or race across at a Maud S. pace.

Whether the horse is an expert on bonding I do not know, but it is evident that he does not desire to be the medium for increasing the return. Where a return feeder is used, it is almost impossible to shock a horse while crossing the tracks, as they are fed two ways. A broken bond will not open the circuit.

The size or amount of these return feeders is an approximate calculation at best, but by using good judgment for their distributing centers, and considering the number of cars liable to be in the vicinity of these centers at one time, a fairly accurate size can be determined on. By allowing a drop of 25 per cent in these feeders (not including the rail), a very efficient return circuit is obtained if the track is carefully bonded. Although, as I have already shown, the return feeder will be very expensive as an outlay at first, yet I have no hesitation in saying that it will more than pay for itself in the saving in the coal pile, besides giving satisfactory results in the operation of the road. The deterioration of the ground feeder, or supplementary wire, as it is sometimes called, is brought in as an argument against them, but if properly laid, there is no reason for any anxiety from this cause. A very durable plan for laying these feeders is to lay the bare copper wire in a piece of grooved lumber, the groove being considerably larger than the wire. The end of the lumber should be cut at a sharp angle, so that the joints will overlap and allow for a nail to be driven in them to hold them firmly. The groove is then filled with a mixture of tar and pitch, at a ratio of eight barrels of pitch to one of tar. This mixture is pliable, and expands and contracts enough with the changes of the atmosphere and prevents dampness from the copper wire. A wood cover is nailed over the top of the groove after being filled. The trench in which the return feeder is laid is about one foot deep, and is run near the inside rail. The distribution of the return current is also much more complete by a system of this kind.

The track near the power house is as little overloaded as that a mile away, as the current is taken from the track by the feeders and returned through them to the station. The street railway in this city has the advantage of an excellent return feeder, that is giving very satisfactory results, notwithstanding the difficulties encountered in the opening of streets and constructing of sewers through the lines of the railway, besides having numerous draw-bridges and the power house located some distance from any of its lines.

The tracks are mostly heavy girder rails, which are securely bonded with bonds of $\frac{5}{16}$ inch iron wire. This plan of bonding was specified in the construction contract and carried out accordingly. The bond used in this construction is perhaps worthy of a little explanation. It consists of a piece of iron wire, bent at right angles at each end. The length of the bond head is sufficient to allow for a washer, with a groove on one side to fit the main part of the bond, and to go through the web of the rail*. This washer lies against the rail, forming a shoulder, so that when the bond is riveted to the rail, it makes a solid joint. Although the bond consists of three pieces, electrically it is only one. These bonds are at every fourth joint cross-bonded to the four rails of a double track road. The cross-connections consists of $\frac{3}{8}$ inch iron cable. This system of bonding is carried out throughout the entire system.

The tracks nearest to the front of the station are connected to the ground bus bar in the power house with a 500,000 circular mil cable, and those nearest the rear of the station with a cable of the same area, which crosses the river. Besides these there are six return feeders of 0000 copper wire also connected to this bus bar. These feeders extend to six different centers of distribution, where they are connected at intervals of 200 feet to the track which they are intended to feed. By this means there are eight independent returns to the station. The most important part of the ground return system is the manner of making connections to water mains, and it is to this important feature of this system that this paper was first intended.

Electrolysis has caused a great deal of trouble between city engineers and electric railways on account of the injury done to city water mains, and as city engineers have placed the responsibility on the railway company, it is apparent that something should be done to avoid this action. Here comes the question; can enough ground return be laid so as to avoid this action? I have a few photographs of pipes taken out from the city water mains. Number 1 was taken from a point in the street about 200 feet from the power house. The railway near which this pipe was, had been in operation four years before the pipe was taken out. The rails were bonded Number 4 copper wire, and a Number 0 copper supplementary wire was laid between the rails, and not being protected in any way it became so badly corroded as to render it almost useless. Number 2 shows where a connection was made to the water main with a piece of copper wire. Between this wire and the pipe a wedge was

*For full description of this bond, which is the invention of A. Von Hoffman, of Milwaukee, see page 420 of the STREET RAILWAY REVIEW, for July, 1893.

driven to tighten the wire to the pipe, then on raising the wire a distance from the pipe, on one side the action took place between the wire and the pipe, thus eating it away as shown.

It is apparent that as long as there is a conducting medium in close proximity to the track, which is of a comparative resistance to that of the track or return circuit, a portion of the current in the track will flow into this conductor unless it is insulated from the return circuit; and as this is impossible, the portion of current carried by this conductor is in proportion as the combined resistance of the connecting medium and conductor is to the return circuit.

Although it is almost impossible to measure these quantities, we can for example take a track having a resistance of 10 ohms and the water pipe which is at an approximate figure of 10 ohms; slip the electrolyte or conducting medium between the track and pipes at 190 ohms and the current carried by the pipe will be as 10 is to 200 or 1-20, and if the current is 100 amperes the pipe will carry 5. The electrolytic action of 5 amperes, of current on an iron pipe in favorable soil is considerable and this is not an extreme case. That the resistance from the track to the water pipe in some cases is very low, is undoubtable and as it is not an equal resistance through its entire length is the detrimental point. If there were a leakage from the rail to the pipe on its entire length we would not hear from this trouble for years to come; but as it is accruing in one place more than another it decomposes the iron at that point more rapidly. It is apparent that the place where the current leaves the track to go to the water pipe will show no signs of electrolytic action, but as the pipe has the current it will leave it at some distant point and it is at this point that the pipe is affected. This is generally near the power house or where the least resistance is offered to the passage of the current in the pipe, to the ground bus at the station.

To overcome this it is necessary to insulate the pipe from all possible grounds which are apt to form an approximate low resistance, so as to have a universal leakage from the track to the water pipe, or connect the water pipe to the track so as to have no difference of resistance between them, or the ground bus at the station. By this latter means the current will form no electrolytic action at any one place more than another, nor in fact at any place at all. The current will be conducted to and from the pipe through conductors and not through an electrolyte, thus avoiding all possible decomposition by the current. This plan is at present in vogue on the railway system in this city and it met the approval of the city engineers after much investigation, careful research and consideration. A very careful record is being kept to prove the success of this system. To the forty miles of road there are sixty water main connections made with iron clamps thoroughly cleaned inside and the pipe is filed smoothly where the clamp comes in contact with it. Bolted to the clamp is a lug to which is soldered the connecting cable which runs to the four tracks. The

clamp and pipe are thoroughly painted with a water proof paint to prevent corroding. This joint after being laid one year has proven to be as good as when first made. To insure a perfect connection to the ground bus in the station a 500,000 circular mil cable is connected to the large 10-inch water main in front of the station and a similar cable crosses the river and is connected to a 12-inch main on the opposite side of the river.

In experimenting before the water pipe connections were made I found that a wire connected from the water pipe in the station to the ground bus gave quite a spark, and on applying an ammeter it registered from 3 to 6 per cent of the total load of the station on a dry day, and on a wet day as high as 10 per cent. This plan of connecting the water pipe throughout the city with the tracks, and having a good return connection from them to the station bus bar, not only insures the city against any deterioration of the water pipes, but increases the ground return very materially, and in tests made on the railway plant in this city I find that 28 per cent of the total output is returned by the water mains, and this percentage remains constant during damp and dry weather, which proves that there is no leak of the current to the pipe through the improved conductivity of the earth. This increase in the return circuit represents an investment of \$8,000.00 on return feeders and increase in the return of 28 per cent, which is a very important factor in the operating expenses of an electric railway and as far as present indications show avoids any further electrolytic action.

COLUMBUS BENEFIT ASSOCIATION.

THE employees of the Columbus, O., Street Railway Company have formed a Beneficial Association, the object of which is to give to every member the assurance that in case misfortune or death comes, he or his family shall receive aid, not as charity, but as due. Any employe of the company, of three months' standing, between the ages of twenty-one and fifty, and of good moral habits, may belong. Members sick or disabled from any cause, except "immoral conduct," shall receive five dollars a week benefit. In case of death each member is assessed one dollar, but \$50 is paid immediately to the family. The secretary and treasurer receives \$10 a month, and the sergeant-at-arms one dollar a meeting. A physician is employed, who is paid by the association.

In another place the local benefit association employs a physician on a yearly salary, to attend to the health of the members and their families. In nearly every town a young physician may be found, to whom a steady income of \$50 or \$60 a month, or even less, will indemnify for all time spent on the families of 100 employes. Competent young physicians may be found in every community. This co-operative arrangement makes calls on the physician more frequent, and happily applies the adage, "An ounce of prevention is worth a pound of cure."

SAFETY GATE FASTENER.

AN entirely new idea in a fastener for safety gates for car platforms has been worked out by F. H. Stanwood, president of the Stanwood Manufacturing Company, of Chicago. Removable gates, such as are used on most roads, are generally hooked on one side to the body of the car, and afterwards so held in position by a clasp and pin to the grab handle of the dash. Sometimes the pin is lost, which occasions trouble, and in any event, the operation of so fastening the clamp occupies time. The illustration is in itself a good description of

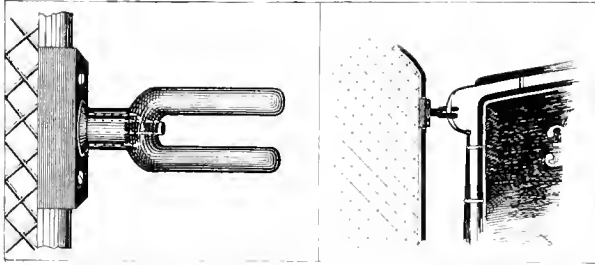

SAFETY GATE FASTENER.

Mr. Stanwood's device, which is made of metal, and riveted firmly to the gate. The shoulder of the "U," being on a swivel, allows it to follow the curved line of the grab handle, when it is desired to detach or fix the gate in its proper position. When set, the gate cannot become unseated, except by lifting it the same distance as in the method at present employed, but permits of the conductor or driver making the change instantly, which under ordinary circumstances is desirable, and in case of any emergency may be specially valuable.

ANTHONY RECKENZAUN.

THE death of Anthony Reckenzaun, occurred on November 11, at his home in Stockwell, England. For many years Mr. Reckenzaun has been one of the most familiar figures at electric association meetings and congresses, and one of the most prolific writers on electrical matters. His contributions to traction literature and his researches in storage battery lines have been of particular note.

Anthony Reckenzaun was born at Gratz, Austria, in 1850, and received an excellent education, both general and technical. In 1872 he went to London as a mechanical engineer in a marine engineering office. He here gained high honors, also under the South Kensington science department on "Steam" and "Marine Drawing and Construction." In 1878 he began to devote his time to electrical engineering, which he had studied previously. In earnestly advocating storage batteries, Mr. Reckenzaun is best known, and to a great degree the present commercial value of the storage battery is due to his efforts. In 1882 he designed a storage battery launch, which was perfected in the "Volta" in 1886. About 1883 he placed a storage battery car on the Metropolitan Tramways of London. He was awarded a silver medal for his paper on "Electric Locomotion," and in 1892 his contribution on "Load Diagrams and Cost of Electric

Traction," was awarded the Paris electrical exhibition premium.

Mr. Reckenzaun spent a year in America, building an electric launch, the Magnet, and attempting to perfect his storage battery cars. His treatise on "Electric Traction" bears evidence of his keen appreciation of the trolley system, and its introduction into Great Britain gave him much pleasure.

Mr. Reckenzaun's many admirable personal traits made him a welcome visitor at the various electro-social occasions, and his profound learning made him a member of all the more prominent electrical societies, by which his death is deeply lamented, as well as by the electrical fraternity at large.

THE ROBINS' LIFE GUARD.

AMONG the very numerous fenders that have been invented, the Robins' life guard is one of the few that have been put to a really practical test, viz., that of landing in safety human beings from the track in front. Two points are embodied in this fender that are not ordinarily thought of in fender design. One is, that it prevents the person caught from striking the dashboard; the other, that it has a second guard, to prevent the individual from falling out after he is caught. As will be seen from the engraving, which represents a man as caught by the guard, October 10, 1893, in Brooklyn, the fender consists of an iron frame, bolted to the under part of the car body, and extending in front of the car 3½ feet. The frame is of one-inch gas pipe. It occupies a space of ten inches when folded. The netting, which

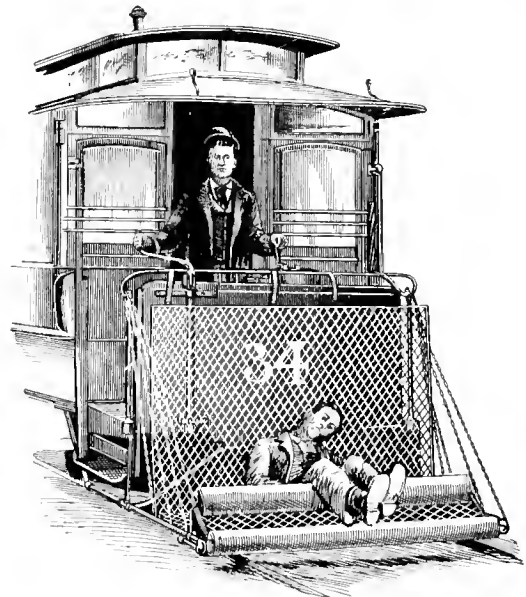

THE FRAME IS ONE INCH GAS PIPE

is wire, is attached to the frame by springs, to cushion the shock. The guards are rubber tubing, on a spring frame. In tests made on several roads, over two hundred and fifty people have been struck and safely landed, at speeds of from four to twelve miles an hour. The maker is the Robins Life Guard & Manufacturing Company, Manhattan building, Philadelphia, Pa.

A NEW WAY TO GET TROLLEY WIRE.

JOHN BYRNS, DRIVER.

WE are at a loss whether to head this article "A New Way to Get Trolley Wire," or "A New Use for Old Motors." Five years ago the Bloomington, Ill., City Railway "equipped itself with electricity" in the form of a lot of Daft 220-volt motors, with dynamos to correspond. These motors, as all old timers will know occupied the greater part of the space between the axles of a six foot truck, and gave the idea that a 90-kilowatt generator had broken loose from the power house and was trying to hide under the car. The fields were laminated with delicate bars of iron an inch square. It was not strange therefore, that in the course of two years, General Manager Patterson saw fit to make a fine large scrap heap of the Daft outfit and substitute something more modern. A look of sadness crept over his face as he beheld the big pile of iron and copper going to waste and he began to investigate the field windings. Eureka! They proved to be wound with Number 1 hard copper, with over 300 feet on each. The wire was unwound, and straightened, the cotton insulation scraped off, and behold! The company was ahead several thousand feet of good trolley wire, most of which is doing service on the road today, and which can not be distinguished from the genuine orthodox article.

NEW YORK CITY RAPID TRANSIT.

IT is anything but a matter of news to remind our readers of the existence of the Rapid Transit Commission in New York. It was generally supposed that body had outlived its usefulness, and had died a natural, though protracted death, and had left no heir. The ghost of underground transportation will not down, or rather up, and now comes forward again Mr Reno, claiming this time, abundant American and English capital necessary to do the deed. The Reno system has already been fully exploited in these columns. The only modification of recent months, being the substitution of electricity for steam locomotives, which is unquestionably a change for the better. The experience of Londoners, if the daily and technical press of that city is any criterion, has been anything but satisfactory in the use of the subterranean route; while the reports of the elevated electric line in Liverpool, make a better showing from every standpoint,—comfort, speed and economy. Mr. Reno's latest estimate for ten miles of four track underground way is as follows:

10½ miles 4-track system, proper at \$1,400,000 per mile.....	\$14,700,000
26 way stations; average cost, \$100,000.....	2,600,000
10 combination express trains, at \$150,000.....	1,500,000
600 passenger cars, at \$3,500 each.....	2,100,000
100 electric engines, 250 h. p., at \$4,000.....	400,000
Lighting and ventilating equipment.....	200,000
3 electric power stations, 10,000 h. p. each.....	1,000,000
Electric power conductors, etc.....	150,000
Storage, yards, terminals, etc.....	2,000,000
Total.....	\$24,650,000

THERE are many drivers, motormen and gripmen who have made trips equal to a voyage around the world. Twenty-five thousand miles is not an exceptional record. Twenty-five times around the world is, though, and it would take a life long service to make.



JOHN BYRNS.

Such however, is the record of John Byrns, driver, of the West End Street Railway Company, Boston. Byrns is the veteran driver and for forty years his familiar figure has marked the front platform or the box of the street car or stage that has plied between Boston and Somerville.

Mr. Byrns is a young fellow of sixty-four, of medium height, blue eyes, light complexion and kindly countenance. He was born in Ireland and served his apprenticeship in driving horses on his native heath, coming to America at the age of twenty-two, a year later he went to Boston and then to Somerville, where his transportation experience was continued from the box of the Putnam and Teele coaches. The coaches made half hour trips during the day, and fifteen minute trips during the rush hours. The fare was first, 15 cents, then 10 cents or twelve for a dollar. Conductors boarded the coaches, collected the tickets, got off and went back for the next coach. About 1860 the Somerville horse cars were put in commission, and Byrns transferred his allegiance to the new vehicles. "It was during the old coach days," says Byrns, "that men paid from three to five dollars for a seat on the top of my coach to see the torchlight procession in honor of Lincoln's "first election."

Mr. Byrns is also a veteran of the late war, enlisting in 1862, in Company E 39th Massachusetts, and serving to the end. After the war, a short period of indoor work made him long for the front platform and he became again a driver on the Somerville avenue line. In regard to the good old times, driver Byrns, says:

"I drove for three years and then became foreman of the West Somerville stables for four years. When I went into the stables I was making nine trips a day from 10 a. m. to 1 a. m. We had no dinner hour then, we could either go without or eat all we wanted before starting. Seven or eight trips made a day's work and we were not paid for extra time either. The estimate of driver Byrns life's work is as follows: average length of trips 10 miles; trips per day, five; time of driving 40 years, total 640,000 miles or twenty-five times around the world. Driver Byrns has seen the total destruction of the coaching business, the inauguration of the street railway business, the eclipse of the horse-car, and the strength of the electric railway, all conquering. His career is a commentary on progress, and he may live to see many more advances in electric traction.

AFTER THE FAIR.

IN spite of prophesy, cranks and the proverbial slowness of official machinery, the White City of a summer's life is now dissolving into its component elements, and the exhibits are returning from ornament to use.

It was but six months ago that the readers of the REVIEW were invited to take a stroll with the REVIEWER, who promised many instructive rapid transit sights, in a few rapid transit flights about the buildings and the grounds of Jackson Park.

all the buildings, especially those state buildings in which agricultural art was illustrated by grain of various kind. The agricultural building is a mine of wealth and peans of sparrow joy are constantly heard there. The newly married couple would be happy in Greenland, they hold each others' hands and coo and coo in each others frosted ears regardless of expense.

The crowds of October has given way to a handful of people, numbered by the few lingering turn-stiles at 300 or, 500 or 750, according as the day is clear or cloudy.

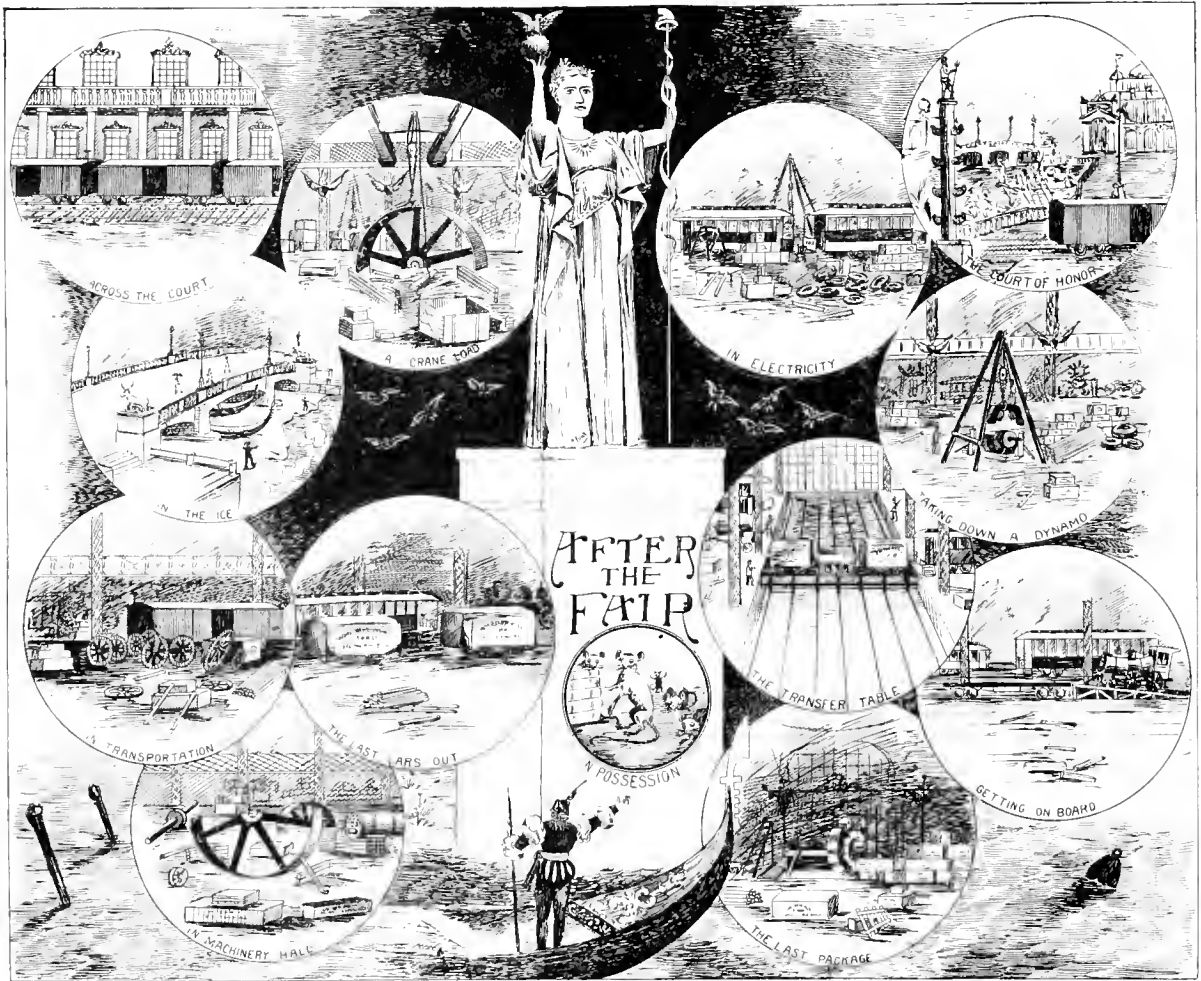

But not so now. In the first place, Jackson Park is a cold, cold place with wild and untamed breezes from Lake Michigan, whistling over an expanse of snow. Inside the buildings it is colder yet to stand, and the erstwhile statuesque Columbian guard paces rapidly to and fro and applies his Stoney Island avenue breath to his numbed fingers. In rare instance there is a little warmth and diversion created by heated altercations between the teamsters as to who has the right of way.

The only ones who enjoy Jackson Park are the English sparrows and the newly married couple, who thought the World's Fair would wait for them. The English sparrows find many crumbs of comfort in almost

Sic transit gloria mundi.

In the Transportation Building the same watchful business like management of the clearing of the building is noticed, as called forth our editorial praise in the installation. The great travelling electrical transfer table is again called into action, and loading up with an 80-ton locomotive or two, trips gaily down the annex and sets its burden down on the side track. The steam cranes are doing their good work, and matters are in wonderfully clear shape.

In street car row, where once all was life and light, now stand only one or two lonely exhibits. The electric transfer table, loading a little narrow gauge engine onto

a flat, was a feature that excited the risibilities of our artist. The big engines ran home by themselves.

In Electricity Building the destroyer has laid his withering touch on the beautiful Western Electric Exhibit, and nearly all the smaller affairs have been removed. The depleting of a General Electric 400-k. w., and a disunited unit of Westinghouse, caught our shivering scribe as descriptive of the building.

If all the wheels, in all the heads, of all the judges of all the exhibits, had sprung off on a tangent at once, there could not have been any greater litter than Machinery Hall, showed the REVIEWING twain. It would have made George Francis Train awarey to have beheld the wheels. A few engines were running, enclosed in canvas sheds.

It was like old times, eight or ten months ago.

The court of honor, with a long railway rip up one side, and a gondola silently frozen into the grand basin, were enough to start tears to the eyes of the tender hearted beholder.

But tears freeze, so weep not, friend.

ELECTRIC LIGHT ON A CHICAGO CABLE LINE.

THE American Battery Company's storage battery is being tried for lighting some of the cable cars on State street in this city. So far, there have been but few equipments put on, as the City Railway Company very wisely thinks best to do the experimenting before the investing. This battery has come into favor for lighting palace sleeping cars, and about one hundred are now so supplied, and more are being fitted up, at the rate of two a day. The battery outfit being tried on the City Railway is 150 ampere hour capacity, and is intended to light four 50 volt lamps, taking about two amperes apiece for eighteen hours. The electrician of the company is George Mayo, who is looking after its interests during the trial.

SUMMER RESORT ROADS.

THE Cottage City Street Railway, down in Massachusetts, shows the years' net income as \$1,515 74, capital stock, \$25,000, and an unfunded debt of \$26,482. The company paid no dividend, but with present surplus has a fund of \$3,260. There are 4½ miles of road, making 7,960 round trips and carrying 83,600 passengers. There were no accidents.

The East Wareham, Onset Bay and Point Independence road, earned \$1,097, net, out of an income of \$6,803 76. It paid a 5 per cent dividend. It is a horse line, 2½ miles long, and carried 50,000 passengers.

IRATE PASSENGER (who has managed to board a car that didn't stop): "Suppose I'd slipped and lost a leg, then what?"

Conductor (kindly): "You wouldn't have to do any more jumpin' then. We always stops for a man with a crutch."—Tid Bits.

FRONT VESTIBULES AT VINCENNES.

THE front vestibule fever, which was legislated upon the Ohio roads, has been voluntarily taken up across the western border of the State, and at Vincennes, Ind., Edward F. Tindolph, secretary and superintendent of the Citizens' Electric Street Railway, has designed, constructed and put in service the vestibule described and illustrated below, and with excellent results.

The entire construction of the frame work is made of poplar strips, 1½ by 1½ inches, with the exceptions of the two side projections at the bottom of the vestibule, which are made of oak, and the 2 by 4 pine strip that runs across to each end of these oak projections. The lower parts are made quite heavy and bolted to the cross-head of the car platform. Running upright on this are the perpendicular frame pieces placed so that when the canvas is stretched on and tacked down it gives a slight bevel from the center window out to the side. The side windows do not run parallel with the sides of the car but are beveled slightly. All the joints of the framework that cannot be safely secured by toe nailing are half cut and

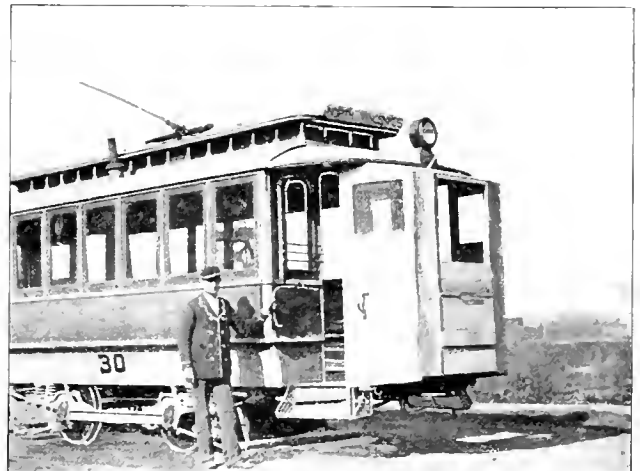

THE VINCENNES VESTIBULE.

bolted with small bolts. The bottom of the vestibule is floored and is used to carry a tool box and box of coal for the stoves. The front end center window can be raised and lowered to any height. The canvas is 40 inches wide and in two widths, having slits cut in it to let handles pass through from dash board and then the slit is sewed up. Vestibule is roofed with canvas and when finished is given two coats of white lead. The brake staff is not changed but vestibule is set about 13 inches forward from center of dashboard. As the Westinghouse system is used the handles do not interfere in the least. The front of the vestibule may be arranged to hang signs or headlight, by placing a strip of iron properly shaped, above, and a light board below, to keep the headlight from punching in the canvas. These vestibules are not built with any intention of bucking wagons off the track, but Mr. Tindolph reports it a great protection to his men and it serves to break the wind from the car. Vestibules are easily removed without disecting, during the summer.

ALWAYS ROOM AT THE TOP.

THE old adage about plenty of room at the top of the ladder was pressed rather hard in this city on the occasion of Chicago Day at the World's Fair. The views are of electric cars, on the Chicago City Railway lines, equipped with Westinghouse motors and McGuire trucks.

are, first, less initial cost, second, less power consumption on light loads, third, fewer parts to inspect and keep in repair, fourth, less weight. The advantage of double equipment is ability to stand heavy loading without lowering the efficiency. This may be in the form of pulling trailers and climbing grades or bucking snow and smashing through the ice. For some of these uses the single motor is absolutely barred out. This brings us around

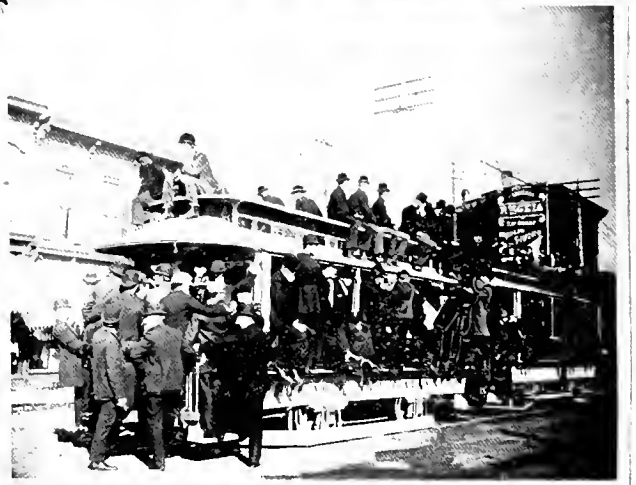
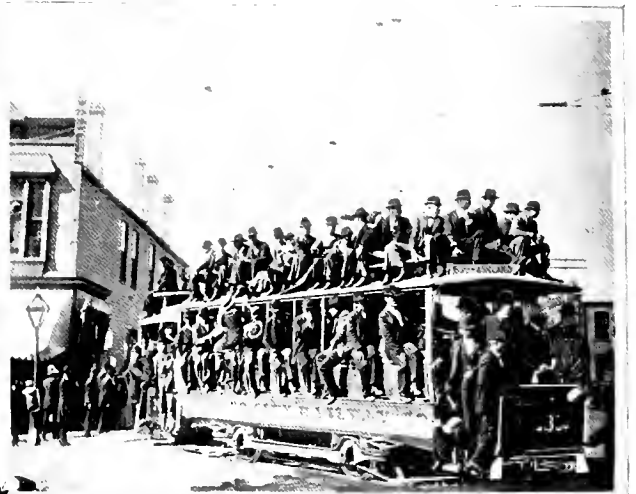

SINGLE AS AGAINST DOUBLE MOTOR EQUIPMENT.

WHILE the single motor equipment undoubtedly has its place, it is a question whether it has not been adopted too much in the past. In this discussion, bevel gear motors are left out of the account, the term single equipment being applied only to the common single reduction motor mounted on one axle. The tests on the Chicago City Railway published in the REVIEW last month show how easy it is to overload a single motor of the size ordinarily put on. For light traffic on a level road with light cars, and with conditions always favorable as to weather, etc., the single equipment is undoubtedly the best. How often do these conditions prevail? A little thought will soon show that it is very seldom. The points in favor of single equipment

in substance to the previous question—how many motor cars are there that will not be subjected to such trying conditions in regular work? The answer to this question should determine the number of single equipments put on a road. The single motor cars may be regarded as a sort of fine weather apparatus, which has its field, but which field is limited by the facts (1) that a slight overload decreases the efficiency, (2) that the traction on the rails is smaller, (3) that owing to the two foregoing reasons they are unable to operate under adverse conditions. During snow and sleet storms in winter the balanced weight of two motors on a truck seems to be necessary not only to break through snow and ice but to secure traction. This being the case the simple enlargement of the single motor hardly fills the bill. The possibility of using the series parallel controller with double motors is another point in their favor.

THE URBANA & CHAMPAIGN ELECTRIC RAILWAY AND ITS OPERATION.

IT is commonly thought that no particular organization and system is needed to run a small road, and doubtless that is one reason why small roads are not better paying investments. The large road, undoubtedly, has the advantage in the way of economical operation and returns per mile run, and it is for this very reason that the best of talent is required to make a small road pay. The Urbana & Champaign Electric Street Railway, under the management of its young president, B. F. Harris, Jr., with Superintendent H. J. Pepper as his right hand man, is an example of a small road, in which full attention is given to all details, and in which the organization is as thorough as if the regular pay roll numbered hundreds of men, instead of twenty-six, as it does now.



B. F. HARRIS JR.

First, be it known that the population of the two cities (which are practically one), amounts to about 14,000, and that the Urbana & Champaign Electric Street Railway is a four mile, single track road, running from the eastern part of Urbana to the western limits of Champaign, with two branches about one mile in length. From 500,000 to 600,000 people are carried yearly. The distance from the business part of Champaign to the court house at Urbana, is about two and one-half miles. Midway between these points, is the State University, of Illinois, which is the source of a considerable travel. The company owns seven Westinghouse motor cars, only about half of which are required for every day use. On special occasions the whole equipment of seven motors and seven trailers, proves none too much. The rail is principally 50-pound T, and brick paving is laid on the main streets. The cars boast the reputation of being the cleanest street cars regularly run in the United States, and their appearance certainly justifies it. One precaution taken to insure this condition of affairs, is the posting of the following notice in the cars:

PASSENGERS ARE REQUESTED
NOT TO DROP PAPERS OR SPIT ON THE FLOOR.
A SEAT, CLEAN CAR IS APPRECIATED BY ALL.

It is probable that the scrupulously clean condition in which the cars are kept, has an overawing effect on the would-be tobacco spitting fiend. Electric heaters only are used.

It is the policy of the management to insist on a strict

adherence to the rules, but at the same time be as liberal as possible with its men. Rules are bound in book form and all regular employes are expected to keep a copy of them, both in pocket and in mind. The result is a very small proportion of accidents. The front platforms are kept closed and no passengers are allowed there.

In case a conductor or motorman wishes to be relieved on account of sickness, or for any other reason, he must get a written order from the office.

Last fall the present company began work on a suitable power station to supply both light and railway current. It had to start on, an old shed, formerly graced with the name of the "sugar works." At that time it contained a car barn, and some railway and arc light machinery. The first step was to tear down the part of the old fire-trap used as a car barn. The balance could not be torn down, as it contained machinery that was in daily use, so the new structure was built over it, and when it was done the "sugar works" were torn down. The result is a light, airy station, with plenty of room toward the roof and plenty of chance for heated air to rise from hard worked armatures. The moving "from one station to another" was accomplished without a shut down. The old shed being out of the way, the machinery capacity was increased. The railway part of the work is done by two of the old form of Westinghouse dynamos, of about 100 horse-power. The plant is so arranged that, if

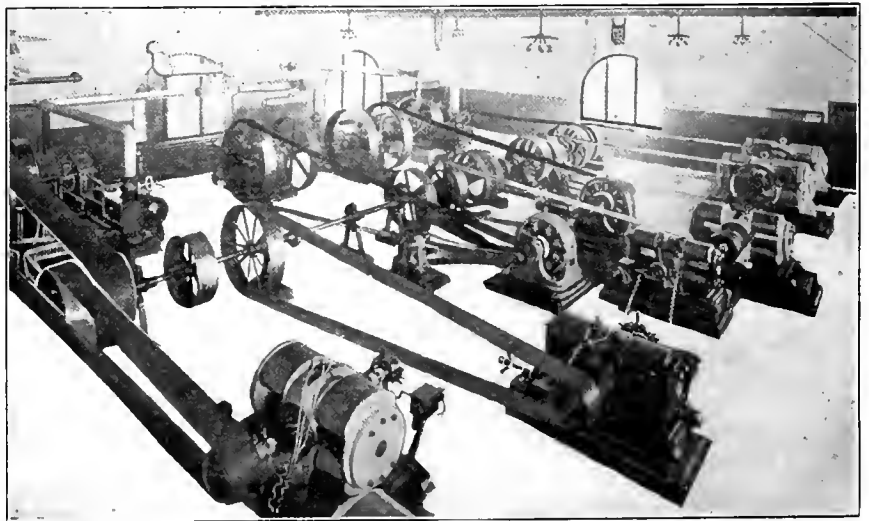

CHAMPAIGN POWER STATION.

necessary, any division of the plant can be run by any engine, by belting it to the countershaft with a belt which is kept on hand for each engine. Ordinarily, each engine runs a certain set of machinery, the railway machines being driven by a Porter-Allen, high speed engine, of 250 horse-power. In addition to the railway load, about 150 horse-power is delivered to motors. The majority of these motors are on meter, the Thomson recording watt-meter being used. The rates are 10 cents per horse-power hour, with discounts, according to the following contract:

AGREEMENT FOR ELECTRIC POWER SERVICE.

GENTLEMEN:

Please make arrangement to provide..... with power service at for..... Electric Motor of..... H. P. capacity, to be located on the..... floor, for the purpose of operating..... machinery. In consideration of such service I agree to pay for the same at your regular rates, and in every respect conform to your rates, rules and regulations; said rates, rules and regulations being as follows:

RATES BY METER MEASURE.

- 10 cents per H. P. hour, with the following discounts:
 - 10 per cent discount on monthly bills of \$15.00 and under, if paid in ten days.
 - 20 per cent discount on monthly bills of \$15.00 to \$30.00, if paid in ten days.
 - 30 per cent discount on monthly bills of \$30.00 to \$60.00, if paid in ten days.
 - 40 per cent discount on monthly bills of \$60.00 to \$75.00, if paid in ten days.
- The meter reads in Watt-hours, and H. P. hours are determined by dividing Watt-hours by 746.

RATES BY CONTRACT.

- One-horse power, \$8.33 per month, net.
- Two-horse power, \$15.00 per month, net.
- Over two-horse power, \$6.25 per month per horse power.

to person or property arising, accruing or resulting from the use of the power.

Consumer may discontinue the use of current for power service at the expiration of contract time, and terminate this agreement by one month's notice given in writing to the Company, and by payment to said Company of all amounts due up to the time of the discontinuance of such use.

The Company reserves the right to disconnect and not to connect with any motors, which it may consider to be other than economical and efficient.

Subscribers are not permitted to use the current for any purpose or purposes, or in any place other than is provided for in this contract, without having first obtained the written consent of this Company, and arranged to pay additional compensation therefor.

In case of deficiency of power or defective service, notice of the fault should be given forthwith at the office of the Company, that the defect may be remedied without delay.

This contract is not transferable without the written consent of the Company.

Signed in duplicate by both parties.

A very neat way of keeping meter accounts is shown by the receipt book leaf reproduced here. The dial faces

Date 189
 Name
 Read by
 Present Reading
 Last Reading
 Consumption
 From
 To
 For
 Amount for Current, \$
 Amount for Extras, \$
 Total of Bill, \$
 Collected by
 Remarks:

Champaign, Ill., 189

DEBTOR TO

Champaign Electric Light and Power Co.

10000^s 1000^s 100^s 10^s

Use of	Power, from	to	
Use of Incandescent Service, from			\$
Lamp Renewals			\$
Materials and Labor			\$
Present Reading			\$
Last Reading			\$
MAKES ALL CHECKS PAYABLE TO		Received Payment,	
B. F. HARRIS, JR., PRES.			

RECEIPT FOR METER ACCOUNTS.

These charges are based on the maximum power used, irrespective of size of motor, the maximum power being determined by a measurement taken by the Company's Ampere Meter, each month, at the motor, with all machinery running.

All rates are based on 10 hours' daily service, except Sunday and legal holidays, from 7:00 a. m. to 6 p. m., and no power service will be rendered for less than \$5.00 per month. It being understood that this power is contracted to be used for one year at rates named. Consumer to exercise due care to prevent the waste of power supplied, and to use the current only to operate the motor mentioned in this agreement.

Consumer to have the motor and connecting lines with switches, rheostats, fuses, lightning arresters and cutouts from Company's service wires properly erected and insulated, so that the building and contents cannot be injured by the amount or pressure of the current delivered, the Company in no event to be responsible for injury from any cause.

That this Company may properly guard its interests, it is necessary that it shall, at reasonable times, by its authorized agents, have free access to the premises in which the power is used, to determine if it is being carried, distributed and used in proper manner, and in accordance with these Rules and Regulations; and the Company reserves the right to shut off the supply for any of the following reasons: 1st, for repairs; 2nd, for want of supply; 3rd, for non-payment of bill when due.

In case the supply of power should fail, whether from natural causes or accident in any way, this Company shall not be liable for damages by the reason of such failure, nor shall it be liable in any event for damage

of the meter are printed on the receipt, and the man who takes the monthly readings also marks the position of the pointers on the dial face, so that not only is there a partial check on the accuracy of his reading, but the consumer has greater confidence in the correctness of his bill when he can see just how his meter stood. The readings for each meter are kept in a book for the purpose. In this book the number of watt-hours recorded can be seen at a glance for any month. It will be noticed that the receipt is adapted to both light and power work.

The largest motor in the service is running a planing mill. It is rated as 25 horse-power. Two of 20 horse-power have just been installed in a large railroad transfer elevator. The installation in this elevator is a model of safe wiring, and the motors are enclosed in wooden cases having doors on all sides and windows in the lids.

The same careful organization that is shown in all other departments, exists in the pay roll and employment of men. The road being small, each crew has a definite

time of service. If any crew is behind in getting around, complaint is soon heard from the crew that it is to relieve. Motormen are considered as conductor's assistants, and the main responsibility rests on the conductors. Car crews are given a rest every fourth day. Conductors wages are between \$13 and \$14 a week. Every night the conductors hand in reports, showing what cars they have had during the day and the names of motormen. Workmen around the plant or on the lines are required to hand in time sheets every night, signed by the head of the department they are working in, giving the hours they worked, the price per hour and the occupation. Workmen from other establishments around the city are given a time sheet signed by the head of the department in which the work is going on, which must be handed in with the bill presented against the street railway company. An order is issued from the office for all supplies bought and no bills allowed unless such order is shown with them. Paying is done weekly. Pay roll blanks provide a line for each man, on which is entered the name, service, time, wages, amount, and signature of the employe in receipt for the amount received.

The company keeps on sale a class of tickets known as "merchants' tickets." These are sold to merchants at the rate of $4\frac{1}{4}$ cents apiece for amounts over 100, and the privilege is given each buyer to have his advertisement printed on the back. Merchants give these away to purchasers, which in turn induces more trade and more riding. About 250 a week are sold of this kind of tickets, one merchant taking 100.

In the past, a liberal accident insurance has been carried, but the coming year this is to be supplanted by a plan which it is hoped will have the same ultimate result. The amount usually paid as a premium on accident insurance is to be laid aside to pay for whatever accidents may occur, and if any is left at the close of the year, it is to be divided among the conductors and motormen. From the accident record in the past, the amount to be divided will probably be a large per cent of the sum laid aside.

The road carries the United States mail between the two towns.

B. F. Harris, Jr., the president, treasurer and general manager, who owns the greater part of the stock and who is mainly responsible for the excellent condition the affairs of the road are in, is a young man, being only 25 years of age. He is the youngest of three generations of the Harris family, all of which are in active business at Champaign, and together own a controlling interest in nearly all the leading enterprises there, besides being among the largest land holders in the state. B. F. Harris, Jr., received his education as a mechanical engineer in the University of Illinois, and as a lawyer at Columbia College Law School, New York, from which latter he holds an L.L. B. An active life is a necessity to the Harris temperament, as Mr. Harris has shown, both by his record in college and in business, and he promises to maintain the position in the community held by the Harris family for so many years.

THE R. & E. TROLLEY HEAD.

THE R. & E. trolley head here illustrated is a product of the factory of Ray & Elsinger, Terre Haute, Ind. One of the principal strong points claimed for this harp is that it is separate from the pole socket, the socket being a permanent fixture on the pole. This is done to save taking the pole off the car to put on a new wheel. Care has been taken in the design of the harp to avoid all sharp corners and round edges, so that

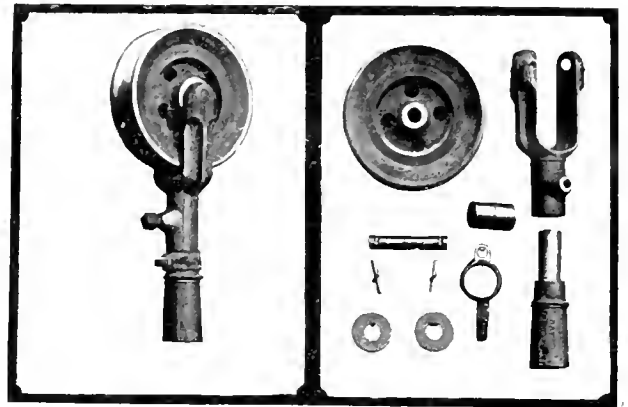

it cannot catch on any of the overhead work. The wheel is of bronze and has a graphite bushing, on which no oil must be used. The rope is fastened to the head by a loose brass ring with an eye in it. On each side of the hub iron washers are used to prevent wear on the harp. The entire device is strong, symmetrical and is proving very popular wherever introduced.

THE UNIVERSAL BRACE.

TO the electrician who does inside wiring his brace is a very important piece of apparatus and, in the majority of cases, it has to be used next to walls and in corners. The universal brace is made so as to give the same motion relative to the work, as an ordinary brace. It can be used with equal ease and effectiveness in any position. The thrust is directly in line with

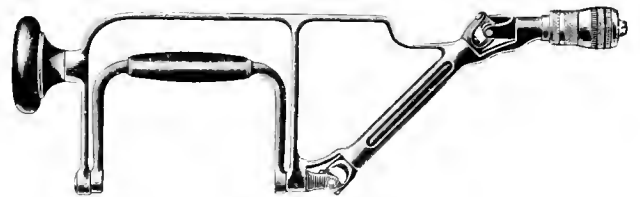

the bit. The frame is held in any working position with one hand and the direction positively controlled. The crank arm revolving at right angles to the bit, the motion is natural and convenient. The frame is light, rigid and strong. It is intended to do the work of the ordinary brace and angle brace besides. It was first introduced in England, France and Germany, where it is extensively used. The manufacturers are the National Manufacturing Company, of Wilkes-Barre, Pa.

STORM VESTIBULES IN TOLEDO.

THE Ohio vestibule law, which has been fully explained in these columns, calls for a protection of canvas or other material. At Toledo, General Manager Lang found it difficult to adopt a wood or iron protection, and so had his cars equipped with a canvas front, suspended from the hood and slanting outward to a point opposite the dash rail, then inclined inward to a point midway between rail and platform. At the top the canvas is attached by hooks, and at the bottom by fastening to the ends of the platform cross sill. This permits

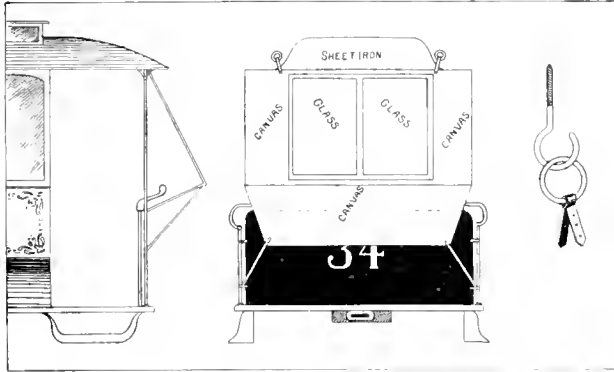

THE TOLEDO STORM VESTIBULE

of its easy removal when desired. The canvas extends across the entire front of the car, and being bulged, allows room in which to work the brake handle; it is also cut for two windows, as shown in the illustration.

When the screens were put in service there was objection on the part of somebody, and the Toledo companies, together with twenty employes, were called before the grand jury, to determine whether or not the device complied with the law. It clearly does comply with the legal requirements, and the grand jury was unable to make out a bill, and the case was dismissed.

AETNA SECTION INSULATOR.

THIS insulator has been severely tested before placing on the market. It is of simple design, strong and durable. The wooden piece between the terminals is renewable and can be changed while on the line. A convenient clamping device renders it possible

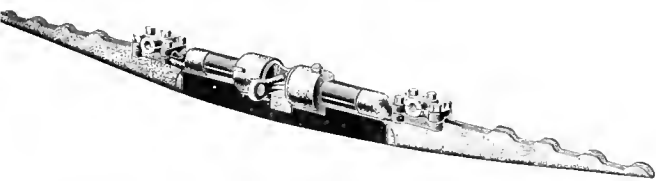

to leave enough trolley wire coiled on top of the section insulator, to allow of its being let out to repair the line in case of a break.

Another part of this combination clamp holds the feed wire in such a way as to obviate the necessity of stripping the insulation from the wire, except at the part held by the clamp. By this arrangement the feeder wire is left insulated from the poles to the section insulators and between the lines where there is a double track.

The insulation is Aetna: no awkward hood is necessary to protect the insulation. Of the several hundreds already in use none have been provided with hoods and results are reported as highly satisfactory. It is manufactured by Albert and J. M. Anderson, Boston.

THE RAY PULLEY COVERING.

EVERY few months the mechanical world is startled by some invention which, though apparently an absurdity on first inspection, proves to be a remarkably practical and efficient device. The Walker differential cable drum is probably the most prominent example of this. The pulley covering here described is one of the same class of absurdities, which work so well in practice. It consists simply in wrapping the pulley with ordinary bell or sash cord. In applying this covering the cord is kept from slipping off the edge of the pulley rim by passing the cord under the rim at regular intervals on the convolution nearest the edge. The use of a slightly flanged pulley would obviate the necessity of this. The drawings show it as applied to an

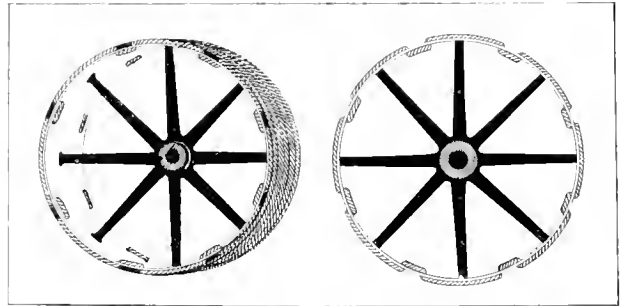

ordinary railway generator pulley. The invention is the property of Sol. Ray, chief engineer of the City Electric Company, Decatur, Ill., and was evolved by the necessities of the station, which was having continual trouble with the belts coming off its 90 kilowatt generator pulleys. Every pulley covering on the market was tried without success, until Mr. Ray, in a fit of desperation, wound the pulley faces with bell cord as described, gave the rope a good coat of pine tar, put on the belt and started up, with the result that there has been no trouble since. The covering has also been tried with success on several other large pulleys in Decatur.

THE REVIEW HAS HORNS.

THE REVIEW has horns, and a very pretty set, too, the kind remembrance of Fred S. Wardwell, recently general manager of the Duluth street railway system. The horns are connected up properly in series, and surmount a nicely mounted head, once the possessor of a large and nimble body, probably an expert at rail bounding, but whose existence was short circuited by the intense voltage of Mr. Wardwell's high speed rifle. The aforesaid horns have been duly installed in the chief editorial dungeon, where they are a source of great admiration.

NEW LINES FOR HAVANA, CUBA.

AMERICAN street railway capitalists have had so much to occupy their minds and money at home, they have not as yet, gone extensively into foreign cities, as have the British investors in Europe. South America, Australia and India. Cuba, however, is so near our own country, both in geographical miles and commercial interests, and the transportation facilities of its principal city are so poor, as to have attracted some enterprising Yankees, who in connection with Edward Morton & Co., of 53 Broadway, New York City, have just closed the purchase of a concession for an important system in the city of Havana. The concession is considered a very valuable one, and was only obtained after a severe fight and mainly on account of the influential position of the parties applying for it; is for sixty years and covers about fifteen miles of the main streets, and the most densely populated portion of the city, taking in all the principal public buildings, hotels, theatres and parks.

The present street railway system only accommodates a portion of the city and does not traverse the most thickly settled portion. It has a length of thirty kilometres and runs through twenty-two wards, with 144,347 inhabitants, which gives an average of 4.812 inhabitants per kilometer. The new system, with only eighteen kilometers, runs across twenty-two wards, with 141,562 inhabitants, or an average of 7.864 inhabitants per kilometers. In density of population the new road has an advantage of upwards of 35 per cent.

The new lines will not in any sense be competitive, but will route through an independent section, with the advantage of running through a more dense and popular portion of the city. The old company with a much larger mileage, has for years paid dividends of 9 per cent on a capital of \$1,600,000. It is expected that the new company, with a smaller mileage and much less capital will even pay better than this.

We understand that arrangements are being made to commence the construction of the road immediately and to push it to completion with all speed, and while on account of the narrow streets, electricity is not at present permitted, the cost of operating by animal power is not excessive and the change to electricity is something to be hoped for later.

Only One Night Out to Florida.

The morning train via the Monon Route connects at Cincinnati with the 7:00 p. m. Through Vestibuled Train, on the Queen and Crescent Route, reaching Jacksonville at 10:50 p. m. the following day. The service of this popular line is unsurpassed by any line to the South. For rates, address City Office, 232 Clark St., Chicago; or Frank J. Reed, G. P. Agt., Monon Block, Chicago.

THE CITY LOSES.

THE London, Ontario, street railway difficulty has become historical in Canada. It has culminated in a decision of Judge Falconbridge in favor of the railway company.

The history of the case is this: The street railway employes were busy laying track on a London street last July. The company claimed that it was merely placing a switch. The aldermen thought it was a double track. The council met hastily that afternoon, and left the matter to the discretion of the mayor and city solicitor. These worthies ordered the policemen to at once stop the work, which was done. The work was stopped, the tracks ripped up, and a suit for damages resulted. This suit has just closed, with a verdict for the company against the city.

A ROCHESTER STREET CAR ADVERTISEMENT.

ONE of the best known and most progressive dailies in the East is the Union and Advertiser, of Rochester, N. Y. It is not only for the Union, but is an advertiser as well. Having occasion recently to get out an extra fine illustrated edition, the



ELECTRIC CAR ADVERTISING.

manager, Mr. Balkam prepared two immense signs, and through the courtesy of the Rochester Railway Company, was allowed the exclusive use of an electric car for an entire day, and before night scarcely a person in the city but was on the lookout for that special edition. The ad. was a great hit.

WHEN the trolley knocks out the canal mule, the tow path line to the White House will be gone forever.

TRAMCAR LETTER BOXES IN DUBLIN.

AMERICANS are not to have all the new ideas exclusively, and the plan of placing letter boxes for the collection of mail, which is already in practice on several roads in this country, is being tried in Dublin. R. S. Tresilian, assistant secretary of the United Tramway Company, informs us the boxes have been in services several weeks and are giving good satisfaction, although the experiment will be continued before a final decision is reached. The boxes are neat iron receptacles placed under the stairs leading to the upper deck, but convenient for persons on the street or

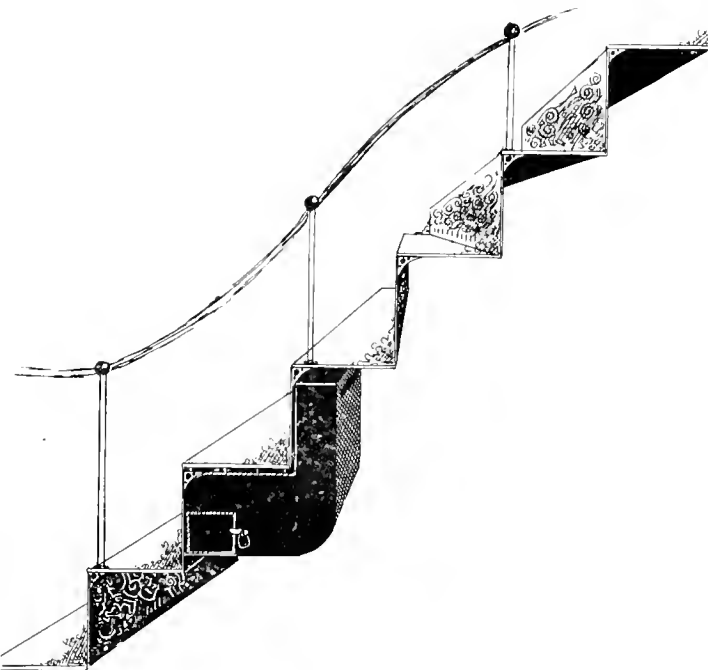

TRAM CAR LETTER BOX.

platform. The boxes are entirely under the control of the local postal authorities, by whom they are owned and who place them in position. Our cut shows the shape and location of the box, which has the usual slot for mailing and a large side door for removal of letters, which is done once each trip by a postal collector. The amount of remuneration the company is to receive has not been settled upon pending the final decision to adopt.

COST OF IRON ORE.

AROUND Bessemer, Mich., there were employed in the iron mines no less than 6,000 men. Of this number during the past few months but 400 have had work, and these only in pumping and similar labor absolutely necessary to keep the mines from going to ruin. In a petition to President Cleveland, the miners ask for the continuation of protective tariff on iron ore, stating that ten-elevenths of its cost of production is for labor, and that it is therefore not properly to be classed under raw materials. The distribution of cost of a ton

of iron ore on the Gogebic range and laid down at Lake Erie ports, is interesting, and as follows:—

Mining	\$ 72
Tramming	.13
Pumping	.10
Loading	.07
Hoisting	.12
Timbering	.25
Miscellaneous, insurance and incidentals	.02
Taxes	.06
Exploring and developing	.25
Maintaining and additions to buildings and equipment	.09
Royalty	.35
Railroad and lake freights	1.65
Commission and insurance	.15
Total	\$3.96

To which must be added the cost of superintendence and interest on the capital invested.

The royalty mentioned is the amount per ton paid the owners of the land for privilege of mining.

COAL PRODUCTION IN JAPAN.

JAPAN is coming to the front as a coal producer, and shippers of English and Australian coal are beginning to feel the effect of the competition in the markets of China. The coal consumption in Japan increased from 85,000 tons in 1887 to 1,500,000 tons in 1891, while the amount mined has increased much faster, the annual yield being something like 3,000,000 tons. The Japanese mine owners do not seem to be actuated by the desire to keep the price up by limiting production. The principal objectors to this policy are their competitors who are being driven out of the market.

WHARTON DERAILING SWITCH.

THIS switch, intended in a measure to prevent grade crossing collisions is the ordinary form of movable tongue derailing switch, but it can only be operated from the box in the centre of the steam road track. The switch is held open by a spring, so that the conductor must stay in the center of the railroad track holding the switch shut until his car has passed. He will manifestly

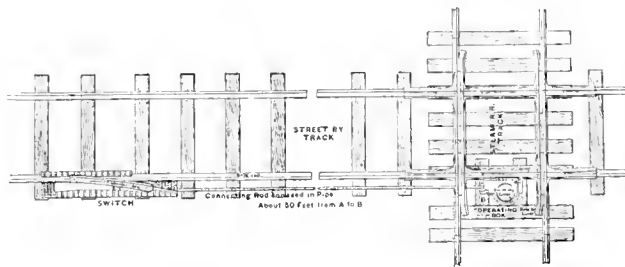

be very careful to make sure that there is no train coming, as he is himself obliged to stay in the most perilous position. The switch box is flush with the pavement. It is intended to put the switch fifty feet from the crossing. The connection is made by an underground pipe provided with expansion joints. To close the switch an iron lever is inserted in a hole in the box lid and the lever pushed around and held in that position as long as the switch is closed.

COST OF STORAGE AND OVERHEAD SYSTEMS.

IT may seem out of place to talk of the comparative cost of the overhead and storage battery systems when no road has as yet conclusively demonstrated that the storage battery can compete with horses, to say nothing of the trolley. However, the tolerably successful use of the Epstein battery on the Birmingham, England, tramways, has brought about some discussion in English papers, tending to show that in case the storage battery kept up its present record on the Birmingham lines it would prove cheaper than the trolley, considering the original investment. The Epstein company is prepared to maintain the cells at a cost of 2 cents per car mile. This alone is more than the entire cost of power and maintenance of line on some American lines. Taking English prices on batteries, the investment would be the same for a double track road with seven minute service at six miles an hour for both systems. The cost of power is about the same with both systems, so that aside from the battery depreciation the cost would be in favor of the storage battery where the headway is more than seven minutes. This would seem to demonstrate that as far as the question of economy is concerned, the storage battery can under no possibility at present in sight, be as cheap to operate as the trolley, except on very small roads, as the battery depreciation comes in as a factor that would greatly decrease the size of the road on which it would be the cheaper form of traction.

THE BRANDAU TRACK AND WHEEL BRAKE.

THE action of this combination track and wheel brake will be made plain by a glance at the engravings. It is simply a modified form of wedge, which is let down in front of the wheels. The track part of the brake is shod with rubber, and as it

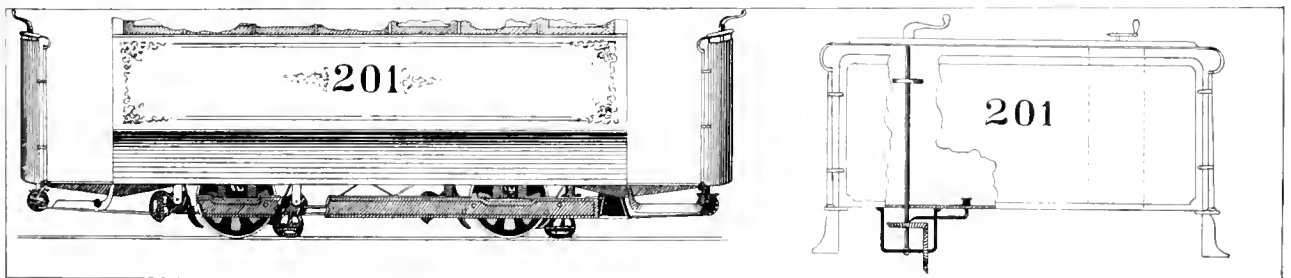

THE BRANDAU TRACK AND WHEEL BRAKE.

is intended only as an emergency apparatus, would probably not wear out very fast. For ordinary service application, only the wheel shoes are used. The track shoes are let fall into their place by their own weight, for emergency application, by a simple pressure on a treadle. At a trial on the Troy City Railway recently, it did its work promptly and apparently without much regard for the condition of the track or weight of car. It is a brake

that is independent of the strength of the motorman or brake chain. The inventor is George Brandau, of Cohoes, N. Y.

SPAN AND BRACKET CONSTRUCTION.

THERE has always been some trouble with bracket and center pole construction, from the breaking of trolley insulators. The blow of the trolley head against a rigidly fixed insulator of any ordinary type causes much trouble. This has been urged as a point against center pole construction, but it would seem to be almost childish to make it an objection of any weight, for unless railway men can overcome so simple a matter as this they had better go out of the business. The patent office records show that this matter is beginning to receive the attention it deserves. The method of temporary relief from broken insulators, as adopted by the Urbana & Champaign road, is to suspend the insulators from the brackets with a short piece of wire. It would be thought that the upward pressure of the passing trolley would interfere with this arrangement, but it does not. The trolley wire is kept fairly tight, and this is probably the secret of the success of the scheme. Another curious fact that has been noted, is that where the span wires are kept rather loose and the trolley wire tight, there is little trouble from trolleys coming off.

LICENSE FOR MOTORMEN.

S T. PAUL'S motormen will be required to carry a license, if the ordinance now drafted shall become a law. Alderman Franklin is the author of the measure, and the qualifications exacted are not more than any just superintendent would require.

Let it be known to the city fathers that damage suits, resultant from careless or incompetent motormen, are just as expensive as any other kind, and the generality of superintendents and managers choose their men with this idea in view.

THE MIDDLETOWN-GOSHEN TRACTION.

THE above company, now owning about three miles of track in Middletown, will begin next spring on a ten mile extension to Goshen. The power house is to be completed in the spring, and will be about 300-horse-power capacity. The track now laid is 60 and 68-pound T and 80-pound girder.

THE ROYAL ELECTRIC RAILWAY MAIL ROUTE AT OTTAWA, CANADA.

HER Majesty Victoria R., has signified to her loyal liegemen, the Ottawa Electric Railway Co., that her majesty's mails may be experimentally conveyed between railway station and the post office.

The service began November 10th, and has continued as far as reported to be satisfactory, both as regards convenience and dispatch. The postal authorities have expressed the greatest pleasure at the change and several similar services are now pending, namely, at Toronto and Montreal. At the latter places also it is suggested that besides carrying to and from railway stations that

sorting is done en route the usual glass windows are dispensed with. The platforms are enclosed a la vestibule.

Our engraving represents Royal Mail 1 on its way rejoicing, to catch the 10:30 train, as the clock in the building opposite marked the hour of 10. The car is handsomely decorated and the miniature of the usual steam mail cars makes it really a noticeably handsome street scene.

To distinguish the approach of the mail car from that of civilian coaches, a special gong has been attached, the sound of which is easily learned.

Under the old system the delivery of mail by horse and wagon cost \$3,600 a year. The Ottawa Street Railway Company has contracted to perform the same service for \$4,000 per annum. The Street Railway Company

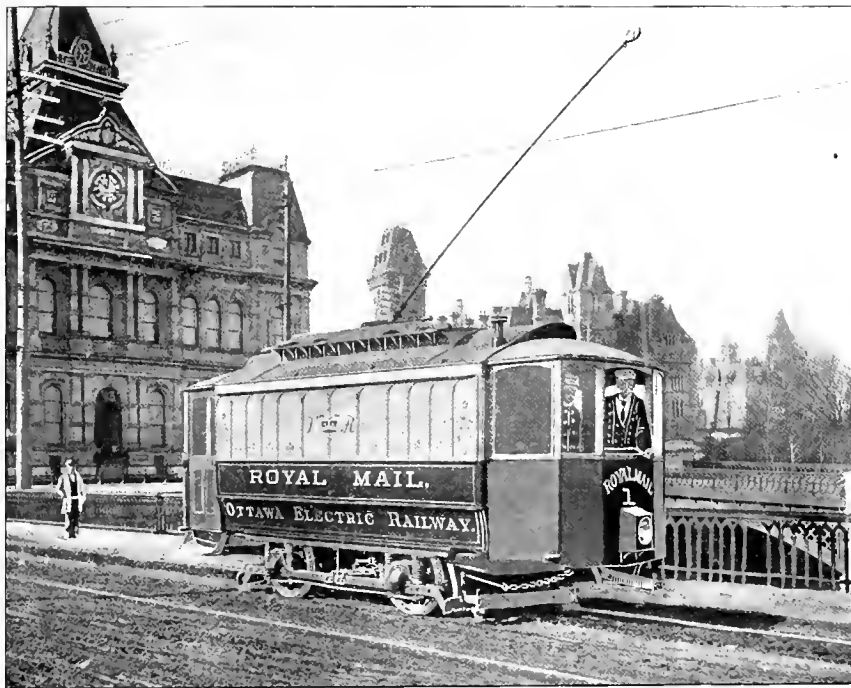

ROYAL MAIL CAR, OTTAWA.

the service be extended to suburban towns, following the practice now in vogue on the Twin Cities Rapid Transit Company and the Cincinnati and St. Louis Electric Railway Companies.

Hitherto the royal mail has been conveyed by wagon in Ottawa, until the present elegant mail cars were put in commission by the well known firm of electrical dealers and Westinghouse Electric and Manufacturing Company, agents. Ahearn & Soper, under whose direction the cars were built.

The cars which are three in number were made by the Ottawa Car Manufacturing Company, and are equipped with 30-horse-power Westinghouse motors. They are 20 feet long, doors in the side for loading and unloading the mail. The interior has been arranged to afford every convenience for handling the pouches, and as no

furnished the motor-man, while the Dominion Postal authorities furnish the messenger or guard who will have charge of the mails, the electric street railway assuming no responsibility in that regard, simply being responsible for their conveyance to and fro under the guardianship of the messenger. Both motormen and messengers are appropriately uniformed. Special sidings have been laid into the Post Office premises and also into the railway yards, thus permitting prompt collection and delivery.

Great credit is due Messrs. Ahearn & Soper for the design of the cars in the institution of this service.

THE Buffalo and Crosstown street railway companies, pay to the city annually, two per cent of gross receipts from passengers, advertising and all other sources of revenue.

CAUGHT ON THE RUSH TRIP.

American Street Railway Association.

HENRY C. PAYNE, PRESIDENT, Milwaukee, Wis.
 WM. J. RICHARDSON, SECRETARY AND TREASURER, Brooklyn, N. Y.
 W. J. STEPHENSON, FIRST VICE-PRESIDENT, Washington, D. C.
 J. R. CHAPMAN, SECOND VICE-PRESIDENT, Grand Rapids, Mich.
 LEWIS PERRINE, THIRD VICE-PRESIDENT, Trenton, N. J.
 EXECUTIVE COMMITTEE: D. F. LONGSTREET, Denver, Col.; T. H. McLAIN, Indianapolis, Ind.; ED. WHITTAKER, W. Y. SOPER, Ottawa, Ont.; and E. S. GOOD, RICH, Hartford, Conn.
 Place of next meeting, Atlanta, Georgia, third Wednesday in October, 1894.

Massachusetts Street Railway Association.

President, J. H. CUNNINGHAM, Boston; First Vice-president, AMOS F. BREED, Lynn; Second Vice-president, FRANK S. STEVENS, Fall River; Third Vice-president, SAMUEL WINSLOW, Worcester; Secretary and Treasurer, A. E. BUTLER, Lawrence.
 Executive Committee, A. A. GLASIER, Boston; E. C. FOSTER, LYNN; CHAS. ODELL, Salem; P. F. SULLIVAN, Lowell; E. P. SHAW, Newburyport; PRENTISS CUMMINGS, Boston; R. S. GOFF, Fall River.
 Regular meetings first Thursday of each month.

Maine Street Railway Association.

President, WILLIAM R. WOOD, Portland.
 Secretary and treasurer, E. A. NEWMAN, Portland.
 Next meeting will be held the first Wednesday in February, 1894.

Ohio State Tramway Association.

President A. E. LANG, Toledo; Vice-president, W. J. KELLY, Columbus; Secretary and Treasurer, J. B. HANNA, Cleveland; Chairman Executive Committee, W. A. LYNCH, Canton, O.
 Meets at Toledo on the fourth Wednesday in September, 1894.

The Street Railway Association of the State of New Jersey.

President, JOHN H. BONN, Hoboken; Vice-president, THOS. C. BARR, Newark, Secretary and Treasurer, CHARLES Y. BAMFORD, Trenton; Executive Committee, OFFICERS and C. B. THURSTON, Jersey City; H. ROMAINE, Paterson; LEWIS PERRINE, JR., Trenton.

The Street Railway Association of the State of New York.

D. B. HASBROUCK, PRESIDENT, New York City.
 G. TRACY ROGERS, FIRST VICE-PRESIDENT, Binghamton.
 JAS. H. MOFFATT, SECOND VICE-PRESIDENT, Syracuse.
 WILLIAM J. RICHARDSON, SECRETARY AND TREASURER, Brooklyn.
 The next meeting will be held at Syracuse, on the third Tuesday in September 1894.

Pennsylvania Street Railway Association.

H. R. RHOADS, PRESIDENT, Williamsport.
 R. L. JONES, FIRST VICE-PRESIDENT, Reading.
 S. P. LIGHT, SECRETARY, Lebanon.
 WM. H. LANIOUS, TREASURER, York.
 Next meeting at Reading first Wednesday, in September, 1894.

California.

OAKLAND, CAL.—Hayward's Electric Railway asks for a franchise on Water street, and also for loop privileges.

LOS ANGELES, CAL.—Pacific Railway Company's cable power house is damaged by fire to the amount of \$1,000.

LOS ANGELES, CAL.—G. L. Dennison asks a fifty-year franchise across southern city limits for electric railway

LOS ANGELES, CAL.—C. G. Baldwin, of Claremont College, introduces his ordinance for electric railway. He will build on county roads also.

SAN FRANCISCO, CAL.—Sacramento street cable, of the Presidio & Ferries system, will be extended. Work already begun on a part of the undertaking.

OAKLAND, CAL.—F. M. Smith, the borax king, will put in a big ferry system and terminal arrangements. This will require extensions of existing lines.

OAKLAND, CAL.—Attorney Geo. W. Reed presents bid for street railway franchise on Fruitvale avenue, from San Leandro road to the depot. W. E. Meck, et al., are the principals.

YUMA, CAL.—Yuma common council grants A. B. Smith franchises for electric railway, waterworks and light systems. One or more to operate May 1. Franchises accepted.

OAKLAND, CAL.—Piedmont Cable Company has withdrawn connecting line service since receivership. Franchise will be held by occasional trains, but nothing definite will be done until electricity be substituted.

POMONA, CAL.—The electric railway between Pomona and Claremont, Ontario and Chino, seems assured. Prof. Baldwin, of Pomona College, E. P. Shaw, F. B. King, et al., are pushing matters. Storage battery is thought of.

LOS ANGELES, CAL.—D. K. Trask, receiver for the Cable road, makes return of account and asks for discharge. Report shows receipts of \$201,434.02, with total disbursement of \$200,042.75. His term was seven months.

SAN FRANCISCO, CAL.—Market Street Railway begins work on the Eddy street electric line. The Market Street Company will build more cars. Behrend Joost says his road will be running to Midwinter Fair grounds, Jan. 1.

SAN FRANCISCO, CAL.—Market Street Consolidated will build a cable line from western terminus of the Sacramento street cable.

Moffatt, Reinstein and Eisner franchise of 1890, later sold to Ferries & Cliff House, is now being built upon.

SAN FRANCISCO, CAL.—Mayor Ellert has begun movement against street railway companies owning franchises not operated. It involves particularly the Market street cable, and will result in a vigorous attempt to cause streets now tracked to be operated or abandoned.

LOS ANGELES, CAL.—C. W. Stewart, Ex-Mayor Workman, Col. L. P. Crane, R. T. Jones, et al., inspect the Los Angeles Street Railway purchase, with a view of locating a double tracked electric interurban between here and Pasadena. The preliminaries have been arranged, and it is claimed that \$830,000 bonds assured. The line will be thirty miles long, and connect with the Lowe mountain road.

Canada

MONTREAL, CAN.—Montreal Street Railway Company elects officers: L. J. Forget, president; H. A. Everett, vice-president and manager; E. Lusber, secretary-treasurer.

QUEBEC, CANADA—Lawrence Lynch, secretary of the Q. M. & C. Railway, will ask extensions and rights to issue bonds for the Montmorency & Charlevoix Railway Company.

TORONTO, CANADA.—Toronto & Scarboro Street Railway Company holds first annual meeting and resolves on two long extensions for next spring, with freight service and mail service. Supplies will be bought this winter. There were present, J. J. Foy, Q. C., John Stark, Ald., J. Hallam, W. D. Matthews, Major H. M. Pellatt, A. E. Wheeler, et al.

Chicago.

CHICAGO.—It is reported that the Secretary of War has granted the Metropolitan Elevated rights to build a new bridge at Van Buren street

CHICAGO.—Corporation Counsel Krause instructs chief of police to stop the use of gas motors on the North Chicago Railroad Company tracks.

CHICAGO.—Call is made by Chicago City Railway for meeting Jan. 15. It is said that official notification of issue of \$1,000,000 new stock has been made.

CHICAGO.—Incorporated, Lefler Electro Magnetic Railway Company, by R. W. Lefler, W. I. Pratt and James Brady. Lefler's office is at 437 Monadnock building.

CHICAGO.—Grand Crossing & Windsor Park Railway Company are granted permit by department of public works to build double track electric on Seventy-fifth street, from Illinois Central station to Stoney Island avenue.

CHICAGO.—Central Construction Company elects Owen F. Aldis Monadnock building, Chas. N. Fay, W. E. Hale, E. S. Pike and Chas. H. Morse board of directors, to build down town elevated terminal for L roads on plan of moving sidewalk. E. F. Getchell and Leslie Carter are interested.

CHICAGO.—The Northwestern Elevated Railway presents franchise to city council. B. J. Arnold, 565 Rookery, is engineer. It is to be an elevated electric. Ordinance also introduced by Ald. Finkler; North Chicago Electric Railway to connect North Chicago and West Chicago lines. Referred.

CHICAGO.—Chicago Elevated Rapid Transit Railway Company incorporates at \$1,000,000. Aims to build elevated railway from corner of Kinzie street and Fifth avenue to Evanston. The incorporators are Russell Whitman, Gilbert A. Powell and Wm. O. Lindley. Mr. Powell, at 115 Dearborn street, lawyer, says that only leave to open books is asked.

Colorado.

MANITOU, COL.—The Manitou Electric Railway & Casino Company elects president, A. M. Leddy; vice-president, John Hulbert; secretary, P. S. King; treasurer, H. S. Cable. Estimates now being received.

DENVER, COL.—Judge Hallett, on motion of Wells, Taylor & Taylor, and Wm. M. Safford, of New York, appoints Geo. E. Randolph, of Denver, and C. S. Sweetland, of Providence, R. I., receivers of the Denver City Railway Company, and the West End Street Railway Company. Receipts have fallen off 50 per cent, and earnings barely meet expenses. Floating debt and mortgages aggregate \$4,300,000.

Connecticut.

NEW HAVEN, CONN.—F. S. Wardwell, formerly of Duluth, Minn., is elected vice-president of the Edgewood Street Railway Company. He will put in the plant and build line immediately. Address Hotel Tompkins.

BRIDGEPORT, CONN.—President N. H. Heft and Henry Setzer, both of this city and president and treasurer of the Electric Railway Company, say that the proposed electric improvements and extensions of the electric railway will involve \$700,000.

NEW HAVEN, CONN.—Clay, Moor & Co., of Philadelphia, put up forfeit of \$25,000 as option on the Centerville Street Railway several months ago, Cornelius Pierpont being owner and the price demanded being \$200,000. Scheme to bond road failed and option forfeited.

BERLIN, CONN.—Central Railway, of New Britain, Conn., has received the report that the Berlin selectmen have given rights to it to construct electric line between the two towns. The bridges and culverts are to be properly protected. Chance for structural iron work.

District of Columbia.

ALEXANDRIA, D. C.—Mt. Vernon Electric Railway Company is given rights for extension of their lines on several new streets and outside of corporation line.

WASHINGTON, D. C.—Georgetown citizens are making a vigorous canvass for the extension of the proposed road to Ballstown. Circulars are issued and public meetings held.

Delaware.

WILMINGTON, DEL.—Samuel K. Smith, of Wilmington, buys Gordon Heights property, and will build electric railway thereto, it is said. Summer resort.

Idaho.

BOISE CITY, IDAHO.—N. J. Sharp, president state wagon road commission of Idaho, will receive until Dec. 26, 1893, at Boise City, bids for construction and building of the state wagon roads and bridges through certain counties. All particulars will be furnished by J. W. Birdseye, Salmon City; J. N. Sharp, Challis; J. A. Ireton, Marsh; D. H. Telcher, Grangeville; J. R. Sanburn, Cour d'Alene City; B. F. Cone, Moscow.

Illinois.

ELGIN, ILL.—Dundee Rapid Transit Company is contracting for lights in Elgin. Electric light plant will be built this winter.

ROCK ISLAND, ILL.—It comes on good authority that electric cars will substitute horse cars on the bridge, and that the secretary of war will announce same officially, soon.

ROCK ISLAND, ILL.—L. M. McCabe and E. H. Guyer, directors of the Moline Central Railway, are negotiating for the lease of the Elm street line of the Tri-City system to boom real estate.

Indiana.

GREENVILLE, IND.—E. Lawrence is granted franchise from city to build an electric light plant.

NEW ALBANY, IND.—The K. & I. Bridge Company, by John McCloud, receiver, says that service will be improved, and new power put in.

TERRE HAUTE, IND.—Assignee, H. J. Baker pays \$50,000, or one-fourth of indebtedness, of the Terre Haute Car & Manufacturing Company.

INDIANAPOLIS, IND.—Haughville has given a liberal franchise to the Citizens Railway, and an electric line will be built to that suburb, and to West Indianapolis.

TERRE HAUTE, IND.—President Russell B. Harrison is giving all his time to the changes being made in the street railway service. Improvements are now being planned.

ELWOOD, IND.—Elwood Electric Light & Railway power house burned, together with car barn. Loss, \$15,000. Cause, natural gas explosion. Small railway plant of four cars.

INDIANAPOLIS, IND.—R. T. McDonald, Ft. Wayne, Spencer Irwin, Philadelphia, B. W. Clay, and Dr. R. C. Light have signed articles for the Broad Ripple Railway. It is to be built in the spring.

GOSHEN, IND.—Franchise of the Indiana Electric Power Company sold at receiver's sale to Hatch & Chadwick, contractors, for \$20,000. Court also grants order for sale of the Elkhart Electric for \$4,000. Consolidation in sight.

HAMMOND, IND.—Chas. F. Griffin, Chicago, president; N. M. Kauffman, of Marquette, Mich., vice president; A. Murray Turner, secretary and treasurer, of Chicago, have taken possession of the Hammond Street Railway and capitalized at \$200,000. Extensions will be made and new equipment put on.

INDIANAPOLIS, IND.—Indianapolis-Broad Ripple Suburban Railroad is incorporated at \$500,000 by R. T. McDonald, R. W. Clay, Sterling R. Holt, R. C. Light, Leon Bailey, Thomas Taggart and A. G. Smith. Besides these named gentlemen, the stockholders are: Samuel Harmony, Fred W. Bailey, G. F. Miller, E. J. Robinson, E. M. Johnson, Joseph Fanning, Geo. Bingham, Jas. R. Henry, J. W. Kern and Fred W. Cady. Mr. McDonald owns 150 shares and Mr. Clay 300. The other fifty are divided up among the prominent men of the city, mentioned. To be operated next season.

Iowa.

COUNCIL BLUFFS, IA.—The Omaha Bridge & Terminal wants an extension.

SIoux CITY, IA.—The Manhattan Trust Company forecloses on \$250,000 worth of bonds of the Sioux City Rapid Transit Company. Decree granted by Judge Ladd.

DES MOINES, IA.—Valley Junction, a suburb, expects to have electric connection with Des Moines Street Railway Company. Mr. Polk says it will be an extension of the Ingersoll Avenue line.

DUBUQUE, IA.—A line of electric railway is to be built from the Fourth street elevator to the Eleventh street elevator by the Rhombbergs. It will necessitate buying considerable track and overhead material.

KEOKUK, IA.—Keokuk Electric Railway Company was shut down by order of the American Loan and Trust Company, which owns controlling interest. It is claimed that cars have been run at a loss for some time.

SIoux CITY, IA.—National Park Bank, of New York, brings suit against Jas F. Peavy, president of the Sioux City Street Railway Company, asking \$42,000, interests and costs. This case is to determine liability of Mr. Peavy on watered stock.

SIoux CITY, IA.—Receiver French submits his report for July, August, September and October; total revenues, \$23,456.99; total from all sources, \$26,832.81; total disbursements, \$22,225.37. A second attempt at reorganization will soon be made.

Kansas.

LEAVENWORTH, KAN.—Newman Erb, receiver of the horse and dummy lines, proposes franchise for an electric, which city is not inclined to accept.

LEAVENWORTH, KAN.—C. W. White, of New York, is putting in the overhead equipment here. Superintendent Baker says the line will be operated January 1.

LAWRENCE, KAN.—City Engineer Holland Wheeler introduces ordinance in city council asking franchise for a cable line on Mount Oread to the University building. Some counterbalance system will be used.

LEAVENWORTH, KAN.—The council and Receiver Newman Erb not being able to agree on franchise, all horse cars were stopped by Mr. Erb, who announces that the line will not operate until a fair electric franchise is granted.

Kentucky.

COVINGTON, KY.—South Covington Electric Railway Company will build an immense car barn for electric cars. All modern improvements to be used.

Louisiana.

NEW ORLEANS, LA.—Prof. Ayers, of Tulane University, H. J. Maloche, electrical engineer of the Southern Electrical Manufacturing & Supply Company, are president and secretary of the new electrical club. G. H. Hopkins, of the New Orleans Traction Company, is of the executive committee.

Maine.

PORTLAND, ME.—Belknap Motor Company re-elects old board of directors and Geo. W. Brown is continued as president of the company. Dividend of 6 per cent declared, payable December 13.

Maryland.

HAGERSTOWN, MD.—Boonboro'-Keedysville Electric Railway Company has completed purchase of its right of way. Work now progressing, and will be continued until the end.

BOONBORO, MO.—Hughes & Rigby Engineering Company, of Baltimore, has contract for the electric railway from here to Keedysville. Stock all taken and right of way secured. The company will also do electric lighting.

RANDALLSTOWN, MO.—Randallstown residents will build an electric to connect with the Baltimore Traction Company. All solid men in the place are enthusiastic. Committee is Messrs. H. M. Benzinger, Robt. B. Chapman, M. Baker, Geo. Lynch, Wm. E. George, R. P. Choate, Wm. Newman, Jas. W. Offutt, Albert Webber, Wm. F. Reil, Martin L. Jean, Edward S. W. Choate and Albert T. Meyer.

Massachusetts.

SOMERVILLE, MASS.—Petitions actively circulated for extensions of electric lines. It will surely come.

BOSTON, MASS.—Reynolds T. White and others file petition for rights to build and operate an elevated road in Boston and suburbs.

GLOUCESTER, MASS.—W. B. Ferguson is elected president, and E. P. Shaw, of Newburyport, director, of the Gloucester Street Railway.

BOSTON, MASS.—Warren T. Putnam, interested in several street railway enterprises and also president of the National Granite State Bank, of Exeter, N. H., has been arrested by the latter institution for embezzlement.

HAYERHILL, MASS.—S. A. Baker, of Windham, N. H., appoints A. E. Simpson, of Windham, George Dow, of Canobie Lake, and others to consider the railway extension fathered by Haverhill electricians and capitalists.

BOSTON, MASS.—The West End Street Railway Company elects new board of directors as follows: Alfred Bowditch, G. T. W. Braman, Eustac C. Fitz, F. L. Higginson, Wm. Hooper, Walter Hunnewell, Henry P. Hyde, Eben D. Jordan, Samuel Little, Theophilus Parsons, Samuel Spencer, Walter S. Swan, B. Rodman Weld, Henry M. Whitney and Alfred Winsor. It is elected on a dividend of 10 per cent dividend.

Mexico.

CITY OF MEXICO, MEXICO.—It is reported here that the United States syndicate, headed by Clarkson, has bought the tram line from Guadaluajara to San Pedro, and that it will be extended both north and west, and changed from horses to electricity.

Michigan.

KALAMAZOO, MICH.—The Kalamazoo Street Railway Company will put in a double track to the street railway park resort.

DETROIT, MICH.—Detroit Suburban files renewal of mortgage given a year ago for \$400,000 to the Union Trust Company.

MUSKEGON, MICH.—Muskegon Street Railway Company has executed a \$4,000 deed of trust to W. F. Drummer, of Chicago.

SAGINAW, MICH.—The Union Street Railway contemplate an extension in the spring and to open up a pleasure resort and park on the Shiawassee river.

BAY CITY, MICH.—Manager J. D. Hawkes, of the Detroit Citizens' Railway is also made manager of the Bay City & Alpena Railway, of which Don M. Dickenson is receiver.

BATTLE CREEK, MICH.—Judge Geo. C. Wing, of Auburn, Me., one of the heaviest stockholders in the Battle Creek Railway, asks United States Court, at Detroit, for a receiver for the road.

Minnesota.

MINNEAPOLIS, MINN.—Twin Cities Rapid Transit Company will make substantial and important improvements in their lines next season.

MINNEAPOLIS, MINN.—It is assured that the City Railway Company will build a line to Ft. Snelling, thus giving a second inter-suburban to the Twin Cities.

DULUTH, MINN.—Incorporated: The Duluth Motor Company, to manufacture electric motors, by D. H. Merritt and Geo. J. Northrup, Marquette, Mich., and F. W. Merritt and Arthur Roe, Duluth, at \$25,000.

DULUTH, MINN.—The City Railway Company publishes incorporation at \$300,000, and names following directors: Andrew H. Burke, Duluth; William C. Green, Chicago; David H. Stephenson, Duluth; Henry E. Harris, Duluth; Patrick R. Haley, West Duluth; Luciene G. Matthews, Pewee Valley, Kentucky.

Mississippi.

JACKSON, MISS.—L. F. Chiles, mayor, will receive sealed proposals until January 2, for lighting the city for five years, according to specifications to be had of city clerk.

Missouri.

KANSAS CITY, MO.—The Vine street electric line will be given a year's extension of time to build.

ST. LOUIS, MO.—The Baden & St. Louis Railroad Company increases capital stock from \$50,000 to \$300,000. Assets, \$50,000; liabilities, \$600.

ST. LOUIS, MO.—The street railways of this city have signified their intention of furnishing the current for light for the fall festivities to be repeated next fall. Decorative car lighting will be practiced.

ST. LOUIS, MO.—South St. Louis Electric Railway Company have secured a number of valuable options on real estate and are about to build an electric railway out Loughborough avenue to Gravois road. The line seems to be well backed and assured.

Nebraska.

OMAHA, NEB.—The Motor Company wants a new and more liberal franchise, which it will probably get.

BEATRICE, NEB.—Paul W. Horbach removed from receivership of Street Railway Company and M. C. Steele appointed in his stead.

New Hampshire.

DERRY, N. H.—A largely attended meeting was held in Haverhill, Mass., to discuss an electric railway scheme, to build such a line from Haverhill to the southern New Hampshire towns, together with a main line to Manchester. The following committee of citizens was appointed: From Chester, Dr. A. L. Emerson, Geo. L. Converse, A. H. Wilcomb; Derry, W. S. Pillsbury, Frederick J. Shepard, Prof. C. S. Campbell; Hampstead, W. E. Fitts, W. A. Emerson, Nelson Orway; Atkinson, John H. Smith, G. P. Dow, Gilman Greenough; Plaistow, G. W. Dobbins, Chas. Cass, John N. Sleeper; Ayers Village, Dr. W. L. Robinson, C. H. Tarleton, C. F. Marshall. Something will be determined soon.

New Jersey.

NEWARK, N. J.—The present system of transfer tickets for the Consolidated is not satisfactory. The road needs a better one.

CAMDEN, N. J.—Camden board of freeholders grant right of way to the Camden Horse Railway Company, knocking out the West Jersey Traction.

BELLEVILLE, ONT.—The Canadian General Electric Company and the industrial and executive committees of the city council are considering proposition of the former for an electric railway in the town.

TORONTO, ONT.—E. A. C. Pew, of Toronto, is trying to organize an electric railway from Buffalo, N. Y., to Port Dalhousie, and build a bridge across Niagara. He says he has interested heavy British capital.

MAY'S LANDING, N. J.—Meritz Lippman and a party of Philadelphia capitalists are petitioning the citizens of Galloway township for a franchise for an electric railway to run from Oceanville to connect with the electric railway at Brigantine.

BRIDGETON, N. J.—Bridgeton Rapid Transit Company elect as directors, W. P. Douglass, E. V. Douglass, and J. P. Newbold, of Philadelphia; T. W. Harris, W. O. Garrison, et al., of Bridgeton. W. P. Douglass was made president, and W. H. Bacon, secretary and treasurer; Millville Rapid Transit Company also elects Geo. B. Langley, president. E. H. Stokes, secretary and treasurer.

New York.

BINGHAMPTON, N. Y.—Street Railway Company want franchise for extension, and will undoubtedly get nearly all it wants.

ELMIRA, N. Y.—Elmira & Horseheads elects Reuben Leland, president; Geo. S. Spencer, secretary; and C. H. Baldwin, treasurer.

ALBANY, N. Y.—The Secretary of State incorporates the Whitestone & College Point Railway Company at \$60,000, to operate between points named and Flushing.

BROOKLYN, N. Y.—Brooklyn City Railroad buys Flushing & College Point Electric Railway, and will assume control January 1. It will be materially extended and improved.

SING SING, N. Y.—Summers R. Stone is appointed receiver of the Ossining Street Railway by Judge Dykman, at White Plains, on application of stockholders. No opposition, as the Vanderbilts can control it.

NEW YORK CITY.—Austin Corbin threatens to return to the rapid transit field, and Gen. Jas. R. O'Brien says that his syndicate, headed by Solomon Simpson, organized for the Bushe system, is still in the field.

NIAGARA FALLS, N. Y.—Publication in obscure Canadian papers discloses a scheme for laying tracks on the bridge across the Niagara below the American falls, for the purpose of running horse, electric or cable cars between the two countries.

BROOKLYN, N. Y.—Kings county grand jury suggests, among other things, that safety fenders and safety gates be used on electric cars in Brooklyn. The grand jury found that the companies were endeavoring to find such successful appliances.

BROOKLYN, N. Y.—Brooklyn Traction Company, controlling the Atlantic avenue system, and the Long Island Traction Company, leasing the Brooklyn City system, are said to be about to consolidate. President Lewis, of the Brooklyn City, and H. B. Hollins & Company, New York City bankers, know most about it.

NEW YORK CITY.—Conduit Construction Company organized, by Thomas C. Buck, C. W. Keep, and Julian Meyers, of New York City; Robert L. Keen, of Montclair, N. J., and John J. Green, of Boonton, N. J. Will build electric conduits in connection with electric railways, and introduce conduit system of underground trolley.

BROOKLYN, N. Y.—The Peoples' Railroad Company incorporates at \$325,000, to construct thirty-two miles of street railway in Brooklyn and suburbs. The directors are: Francis J. Callahan, of Rutherford, N. J.; John S. Fargotston, L. George Fargotston, Michael J. Kelly, E. Wright Nelson, and Horace Moody, of New York City; Chas. M. Nichols and Frank Gardner, of Brooklyn, and Stephen Parish, of Jersey City.

BROOKLYN, N. Y.—Brooklyn, Bergen & Canarsie Railway incorporated, to build eighteen miles electric railway on Brooklyn streets, Flatbush, and so forth. Capitalized at \$200,000. Directors are: Thomas Adams, Jr., and Louis R. Adams, of Brooklyn; Percy G. Williams, of New York City; Frederick Rosebush, of Ozone Park; Henry E. Hughes, Chas. E. Morrell, and F. W. Lenken, of Canarsie; Daniel J. Wright and Alexander Stafford, of Flatlands.

NEW YORK CITY.—The New Jersey Traction Company, of North New Jersey, accepts resignation of Thomas C. Barr, president, and John I. Waterbury, as vice-president. David Young, of Newark, was elected as vice-president and general manager. B. M. Shanley will probably be elected president. It is officially stated that the \$5,000,000 guaranteed to be taken up in stock of the Consolidated Traction Company is now on hand and that the latter will assume charge of all the New Jersey Company roads.

Ohio.

TIFFIN, O.—The Tiffin Fostoria line increases capital stock from \$100,000 to \$150,000.

PORTSMOUTH, O.—The street railway, electric, has begun business after much tribulation.

CHILLICOTHE, O.—A. H. Reutinger, receiver of the electric railway, reports business better.

CLEVELAND, O.—The new council order that street cars shall be heated to 60 degrees, will be late in being enforced.

CLEVELAND, O.—The Cleveland Electric Railway Company has bought sixty new motors, and made new transfer arrangements.

SHARON, O.—John Cole, right-of-way agent for the Warren-Sharon Street Railway, says that prospects are still bright for the construction of the line.

MANSFIELD, O.—Fire destroyed the power house of the Citizens' Street Railway. The loss was \$8,000, partly insured. To be replaced immediately.

MANSFIELD, O.—Report is here that the Fulton Foundry, of Cleveland, will remove to this city. It is said that \$100,000 is subscribed by Mansfield men.

TIFFIN, O.—F. W. Brightman, of Fall River, Mass., C. F. Shaw, of New Bedford, Mass., Thos. B. Williams, of New York, have decided to change the Tiffin Street Railway (a horse line) to electricity, and unite with the Tiffin & Fostoria Electric. It is reported that the men named are interested in the Tillotson scheme.

CINCINNATI, O.—Z. V. Purdy, 23 Neave street, this city, has invented a storm front for street cars, and disposed of same to Jo Nagel, Church street, who will promote it.

CLEVELAND, O.—West Cleveland city council grants extension of the West Madison avenue line of the Little Consolidated, giving exclusive rights for twenty-five years.

CLEVELAND, O.—Superintendent Mulhein, of the Cleveland City Railway, says that through service will be run from Rocky river to Glenville. New power is to be added.

CINCINNATI, O.—The Consolidated Street Railway files bonds for the street railway extensions, which will be immediately prosecuted, with probable opposition at only one point.

CLEVELAND, O.—Consolidated Street Railway asks for bids for equipping lines with platform screens, according to the state law. Horace Andrews favors Canton screen.

CINCINNATI, O.—The Cincinnati Street Railway Company has bought some Consolidated Car Heating Company heaters, some Dewey's and a car stove. A fender is also on trial.

COLUMBUS, O.—John R. Hunt, Theo. Leonard, et al., bring suit, enjoining Columbus & Westerville Electric Railway from occupying certain streets. It is an attempt to kill the C. & W. road.

SANDUSKY, O.—The Peoples' Electric Company is to elaborately extend their system and put in express and baggage service. Fifteen thousand dollars worth of bonds will be issued immediately. Supplies wanted.

CINCINNATI, O.—The board of administration passes five resolutions, giving the Cincinnati Street Railway Company rights to equip present horse lines with electricity. Five cent fare allowed, and 5 per cent for franchise demanded.

NORWALK, O.—F. H. Jones and J. W. Foster, assignees of the Incandescent Light & Power Company have conferred with the Cleveland owners of the company, and decide not to sell plant, but to ask to light city on moonlight schedule.

CLEVELAND, O.—The project of an electric line from here to Chardon and Burton, in Geauga county, is again on foot. The line will be used both for freight and passengers. Surveys have been made, and it is said the capital gathered together.

TOLEDO, O.—The Robisons, of the Toledo Electric Street Railway Company, are said to be in the field to build an electric railway from Monroe, Mich., to Detroit, as part of the Toledo-Detroit long line. The Robisons offer to put up a forfeit.

TOLEDO, O.—The Maumee avenue bridge disaster, of May, 1892, has been settled in court by a verdict of \$5,000 each from the city, the Consolidated Street Railway, and the L. S. & M. S. Railroad, in favor of the estate of the motorman killed during that accident.

CLEVELAND, O.—Ex-Secretary Foster, the Carnegies, of Pittsburg and one Dr. Anderson, of this city, are said to be backed by \$100,000,000 to build an elevated electric railway from New York to Chicago, via Philadelphia, Pittsburg, etc. The Anderson patents are to be used. The address of Anderson is 1019 Euclid avenue, Cleveland. This seems to be the perennial scheme.

CINCINNATI, O.—J. J. Shipherd, Cleveland; Chas. O. Otis, of New York; W. Brenton Willing, of New York; Chas. C. Orr, of Pittsburg; M. Kauffman, Pittsburg, met in this city to consider possession of new bridge which will span the Ohio at Cincinnati. This syndicate has already large street railway holdings and will endeavor to control the traffic between the cities. Mr. Ferris, of Ferris wheel fame, and Mr. Kauffman, of Pittsburg, will design the bridge.

Oregon.

PORTLAND, ORE.—Fire destroys car house and five cars of the Portland Consolidated Street Railway. Loss, \$50,000; fully insured.

CORVALLIS, OREGON.—Corvallis Street Railway, rolling stock, franchise, are sold by sheriff, and bid in by the Security Savings & Trust Company, of Portland, for \$350. The property originally cost \$20,000 and has been in operation about four years.

Pennsylvania.

PHILADELPHIA, PA.—Pennsylvania and Maryland Steel companies will reorganize.

LEBANON, PA.—Lebanon & Annville Electric Railway elects J. M. Schenk, president; S. P. Light, vice-president.

JOHNSTOWN, PA.—The Johnson Company has started double turn and will soon resume full time in all departments.

STEELTON, PA.—H. W. Smith, of Steelton, is made superintendent of the Cumberland Valley Electric Railway, at Carlisle.

OIL CITY, PA.—Electric Railway Company has started its cars. J. B. Smithman is president and C. W. Atmore, superintendent.

PHILADELPHIA, PA.—Philadelphia Traction Company shows earnings of \$4 a share, a dividend of \$1.50 a share paid Dec. 1.

PHILADELPHIA, PA.—W. C. Carrington & Son are awarded contract for the new Traction Company power house, on Hutchinson street.

PITTSBURG, PA.—The Pittsburg & Mansfield Railway Company wants franchise for a double track electric, partly surface and partly L.

SCRANTON, PA.—E. W. Clark, Jr., J. P. Hsley, H. H. Archer, C. F. Stevens and T. Burke are elected directors of the Scranton Traction Company.

SCRANTON, PA.—Chas. H. Smith resigns from Scranton Traction Company and will return to Wilmington, Del., to the Delaware Electric & Supply Company.

PHOENIXVILLE, PA.—Spring City council grants franchise for the Schuylkill Valley Illuminating Company Electric Railway, which is to run from Valley Forge to Royersford via Phoenixville.

PITTSBURG, PA.—Homestead bridge charter has brought out several bids for street railway privilege across same. Birmingham Traction Company is in the lead. A lively fight will soon be on.

CARBONDALE, PA.—Organized: The Carbondale & Forest City Passenger Railway Company, to run from Forest City to Carbondale, a distance of twenty miles; capital, \$150,000. Directors, John W. Aitken, Henry B. Jadwin, J. M. Nichol, Carbondale; Geo. Carrogan, Bayonne, N. J.; Edwin Corey, Jersey City.

EAST STROUDSBURG, PA.—An electric road to run from the D. L. & W. depot to the top of the mountain is proposed. W. F. Halstead, general manager of the D. L. & W. Railroad, and the hotel men of the town are at the head of the affair.

PHILADELPHIA, PA.—Charter has been granted to the Pennsylvania Traction Company, of Philadelphia; capital, \$10,000. The incorporators are: Sydney R. Miner, G. W. Shonk, J. M. Thomas, John B. Yeager, of Willkesbarre; C. J. Lewis, Wyalusing, and H. G. Kulp, Pottstown.

PITTSBURG, PA.—Citizens' Traction Company report of year ending October 31, 1893, shows total receipts, \$724,928; operating expenses, \$388,948; total expenditures, \$505,119. Net earnings, 7½ per cent. Old board re-elected. Citizens' Passenger Railway elects C. L. Magee, John G. Holmes, Jas. Verner, et al., directors.

PHILADELPHIA, PA.—Organized: The Manayunk Passenger Railway Company, of Philadelphia, at \$12,000, to build two miles of street railway. The president is Wm. H. Heulings, and the directors are Jas. Rawle, Geo. W. Vanhorn, John F. Dunlap, and Fletcher Pearson. The route of this road does not conflict with that of the Manayunk & Wissahickon road.

NEW HOLLAND, PA.—The following committee is appointed to solicit subscriptions and rights to extend the Reading & Southwestern Electric Railway: L. T. Custer, Elmer E. Billingfelt, Henry G. Mohn, James J. Coldren, Wm. Knauer, Jacob Keasler, Mohnsville; R. V. Regar, Swartzville; Benjamin F. Hemig, James Mohr, Gunglersville; John R. Miller, Reading.

CARLISLE, PA.—The Cumberland Valley Traction Company elects officers, as follows: B. Ritter Iekes, president; and Colonel John Lemon, of Tyrone, J. R. Miller, Esq., of Carlisle, W. J. Iekes, of Altoona, and William Wighton, of Altoona, as directors. The Traction Company will operate the line, but the Electric Passenger Railroad Company will still exist with the regular officers. Work begun.

PITTSBURG, PA.—The charter has been granted to the Pittsburg & Homestead Electric Street Railway Company. Pittsburg capital, \$12,000. The proposed road will be two miles long and will run from the Twenty-third ward of Pittsburg to Homestead; thence to Munhall station. The president of the company is Herman Laub, of Pittsburg, and the directors Everett G. Weinschenk, James P. Wilson and Homer Sweeney, of Pittsburg.

Tennessee.

JACKSON, TENN.—T. F. Dalby, superintendent of the Street Railway Company, died December 1 of pneumonia.

CHATTANOOGA, TENN.—The Electric Railway Company will build a line out Carter street, as designed some time ago.

Texas.

CORSICANA, TEX.—Street railway barns burn, together with four cars, tools, harness, etc. Loss on cars, \$1,200, no insurance. Only two cars left in town.

DALLAS, TEX.—It is reported that the Queen City Street Railway Company and the Oak Cliff Company would consolidate and that the latter would be changed to electricity. A. W. Childress is president of the Queen City Company.

Utah.

SALT LAKE CITY, UTAH.—W. H. Rowe, et al, ask for franchise for a street railway on certain streets.

SALT LAKE CITY, UTAH.—Big Cottonwood Power & Water Company will utilize water power for production of electricity for all purposes, and organize at \$1,000,000. John W. Donnellan, president; Geo. M. Cannon, secretary and general manager; Geo. M. Downy, treasurer. Franchise gained from city council for construction of plant. Eastern capital is back of it.

Washington.

SPOKANE, WASH.—J. W. Goss and Engineer Riblet leave for Tokio, Japan, to put into that city an electric railway. Rev. V. M. Law has gained a charter. The Americans will return to Spokane about January 1. Mail care of American consul at Tokio.

WHITESTONE, L. I.—The incorporators of the Whitestone College Point Railway are J. J. Merritt, Jr, Moses Worms, Oliver Taff, D. Steffens and Harvey Place, of Whitestone; John F. Anderson, of Bay-side, Harry D. Low, of Mt. Vernon; Walter C. Foster, of Long Island City, and John J. Delaney, College Point.

West Virginia.

POINT PLEASANT, W. VA.—Capitalists are endeavoring to organize a street railway here.

WHEELING, W. VA.—Benwood & Moundville Street Railway seems to be a live scheme. Col. Ben Wilson, of Clarksburg, is promoting the scheme, and says that 75,000 people will patronize the line.

Wisconsin.

MILWAUKEE, WIS.—Mr. Payne says that in the spring an extension will be made on Twenty-seventh street to North avenue, but not until then.

MILWAUKEE, WIS.—Capt. Pabst applies for franchise for electric conduits and will go into the electric lighting business. Geo. Parker is the manager of the Pabst electric plant.

RACINE, WIS.—The Belle City Street Railway Company has decided to go into the electric light business, in connection with the street railway plant. D. Elmer Roberts is made manager of the lighting business, and W. C. Rittman, superintendent.

MILWAUKEE, WIS.—Fred Isenring, Max Zabel, C. A. Rogers, A. F. Remington and T. W. Williams have organized the Milwaukee & Whitfish Bay Rapid Transit Company. The company's line will run along Humboldt avenue.

MILWAUKEE, WIS.—Villard syndicate brings suit against Milwaukee & Whitefish Bay Dummy line, to collect \$240,000, advanced for extension. Although owned by Villard people, this will force the dummy line into receiver's hands, and the present Isenring scheme will carry through for a new route, line and company.

JANESVILLE, WIS.—Geo. W. Blabon, of Philadelphia, is elected president of the Street Railway Company. Mr. Blabon buys a controlling interest from the assignee of the Mutual Loan, Trust & Safe Deposit Company Bank of Philadelphia. Levi B. Carle is placed in the directory. The board is now composed of Geo. W. Blabon, president; A. A. Jackson, vice president; W. R. Proudfoot, secretary and treasurer; Alexander Graham and L. B. Carle, directors. All of Janesville except Mr. Blabon.

STREET RAILWAY PATENTS.

ISSUED NOVEMBER 7, 1893.

Electric locomotive, Joseph I. Conklin, Brooklyn, N. Y.....	507,997
Brake handle, John Kirby, Jr., Dayton, O., assignor to the Dayton Manufacturing Company, same place	508,025
Clamp for holding articles while being welded, Arthur J. Moxham, Johnstown, Pa.....	508,037
Railroad track, Arthur J. Moxham, Johnstown, Pa.....	508,038
Rail securing device, John L. Pope, Cleveland, O.....	508,047
Combined rail support and cross tie, Franklin P. Reilly, New York, N. Y., assignor by mesne assignments to the Johnson Company, of Pennsylvania.....	508,049
Electric railway system, Carl T. B. Brain, Liverpool, England.....	508,083
Conduit railway trolley, Herbert A. Goreham, Decatur, Ill.....	508,104
Closed conduit electric railway, Otis B. Benton, Cleveland, O.....	508,199
Conduit electric railway, Jacob Pawolowski, Cincinnati, O.....	508,236
Car truck, Austin A. Brooks, Eau Claire, assignor to the Brooks Safety Truck Company, Chippewa Falls, Wis.....	508,276
Electric regulator and switch, Walter N. Jones, Jr., Petersburg, Va	508,322
Car truck, John E. Anger, Green Island, N. Y., assignor one-fourth to Edmund J. Gilbert, same place	508,362
Electric car attachment, Isaac H. Davis, South Butte, Mont.....	508,373

ISSUED NOVEMBER 14, 1893.

Car brake, David N. Cook, Salem, Mass.....	508,409
Fender for electric cars, Caleb N. Homan, Lawrence, Mass.....	508,472
Electric railway trolley, James Case, Rochester, N. Y.....	508,538
Electric railway trolley, Stephen D. Field, Stockbridge, Mass.....	508,539
Car fender, Alfred L. Clark, Springfield, O.....	508,565
Railroad rail brace, David Markley, Lexington, O.....	508,575
Conduit for electric railways, Archibald J. Robertson, New York, N. Y., assignor to himself, Geo. S. Brush, Brooklyn, and Henry Carey, Elm Park, N. Y.....	508,578
Rail joint, Johann Schuler, Bochum, Germany.....	508,580
Electric railway, John C. Henry, Westfield, N. J.....	508,615
Electric railway trolley, Walter H. Knight, New York, N. Y.....	508,622
Switch box for controlling electric circuits, Edward R. Knowles, Middletown, Conn., and Edwin H. Park, Millbury, Mass., assignors to the Schuyler Electric Company, of Connecticut.....	508,625
Electric railway motor, Edward D. Priest, Lynn, assignor to the General Electric Company, Boston, Mass.....	508,633
Metal tie and nut lock, Jasper P. Warner, Decatur, Mich.....	508,664
Snow sweeper, Norman C. Bassett, Lynn, Mass., assignor to the Thomson-Houston Electric Company, of Connecticut.....	508,668
Trolley for electric railways, Norman C. Bassett, Lynn, Mass., assignor to the Thomson-Houston Electric Company, of Connecticut.....	508,669
Switch for electric railways, Edward M. Bently, New York, N. Y.....	508,672
Electric railroad track cleaner, Hugh O'Connor, Passaic, N. J.....	508,743
Construction of trolley lines, George Q. Seaman, Brooklyn, N. Y., assignor to himself, Alexander Wilson and William Jones, same place.....	508,771

Electric brake for railways, Armand de Bovet, Paris, France.....508,805
 Converter system for electric railways, Chas. S. Bradley, Yonkers, N. Y.....508,807
 Car wheel, Dexter Hazard, Marquette, Mich.....508,824
 Electric brake, Ernest B. Skinner, Ogden, Utah.....508,851
 Life preserving guard for cars, Anton Knowlauch, Minneapolis, Minn.....508,888

ISSUED NOVEMBER 21, 1893.

Skid shoe for railway cars, Ludwig Reetz, Eshweileraue, near Aix-la-Chapelle, Germany.....508,971
 Electric railway, Jonathan H. Vail, New York, N. Y.....509,002
 Electric railway conduit, Granville T. Woods, New York, N. Y., assignor to the Universal Electric Company, of the city of New York.....509,065
 Electric railway, John H. Dale, New York, N. Y., assignor to the Universal Electric Company of the city of New York.....509,072
 Trolley mechanism, John T. Fuller, Calvert, Texas.....509,123
 Electric locomotive, John C. Henry, New York, N. Y.....509,311
 Supply system for electric railways, John C. Henry, New York, N. Y.....509,312
 Current controlling device, William H. Morgan, Alliance, Ohio, assignor of three-fourths to Thomas R. Morgan, Sr., Thomas R. Morgan, Jr., and John R. Morgan, same place.....509,322
 Hanger for trolley wires, George H. Ricke, Cincinnati, Ohio, assignor of three-fourths to Owen H. Hilland, Michael A. McGuire and Charles C. Agin, same place.....509,328
 Switch operating mechanism, Samuel Walker and Le Grand Marshall, Milwaukee, Wis.....509,340

ISSUED NOVEMBER 28, 1893.

Car truck, William S. G. Baker, Baltimore, Md.....509,355
 Electric closed conduit system for railways, George W. Von Siemens, Berlin, Germany, assignor to Siemens & Halske, same place.....509,493
 Conduit electric railway, Adolph Womer, Buda-Pesth, Hungary, assignor to Siemens & Halske, Berlin, Germany.....509,421
 Rail joint, Frank C. Balch, Kalamazoo, Mich.....509,422
 Electric railway, Thomas A. Edison, Liewellyn Park, N. J.....509,518
 Rail joint, Milton C. Niles, Oak Park, Ill.....509,581
 Clamp ear for trolley wires, Edwin B. Gates, Decatur, Ill., assignor one-half to Don Carlos Shaw, same place.....509,616
 Conduit electric railway, Edward H. Johnson, New York, N. Y.....509,622
 Car fender, Ivory Bean, Brookline, Mass.....509,646
 Trolley track, William H. Brodie, Brooklyn, N. Y.....509,650
 Closed conduit system for electric railways, Emile Chabeault, Marseilles, France.....509,651
 Subway for cable railways, Charles Voegel, San Anselmo, Cal., and Colin McIntosh, Tacoma, Wash, assignors to the Vogel Cable Construction Company, of Colorado.....509,833

THE Lake Street L., this city, has gained rights for a branch line, for a northwest line to Humboldt Park.

Custer's Last Battlefield.

A visit to this spot, which is now a National Cemetery, is extremely interesting. Here, seventeen years ago, General Custer and five companies of the Seventh U. S. Cavalry, numbering over 200 officers and men, were cut to pieces by the Sioux Indians and allied tribes under Sitting Bull. The battlefield, the valley of the Little Big Horn, located some forty odd miles south of Custer, Montana, a station on the Northern Pacific Railroad, can be easily reached by stage. If you will write Chas. F. Fee, St. Paul, Minnesota, inclosing four cents in postage, he will send you a handsomely illustrated 100 page book, free of charge, in which you will find a graphic account of the sad catastrophe which overtook the brave Custer and his followers in the valley of the Little Big Horn, in June, '76.



EXPERIENCES OF A SUPERINTENDENT.

By C. P. Young, Superintendent of the Chattanooga Electric Railway.

IN this progressive age of rapid changes, in no business have advancements been wrought so vastly as in the revolutionizing of street railroading. A few years back the man that was a good judge of horse flesh and that could swear the most at the inferior class of men under his command, constituted then the successful street railroad manager and superintendent. But now things have changed. More money has been invested in changing the motive power of street cars than in any other business of modern times. The owners of horse roads in the majority of cases maintain their interests in the new electric roads. They have thought and many still think that because a man can make an old horse trot he can also make delicate electric machinery work successfully. A greater mistake was never made, and millions of dollars are lost every year by investors in electric railroad stock by this illusion.



C. P. YOUNG.

It cannot be denied that electricity as a motive power is generally the best and most economic if properly handled and controlled. While on the other hand it is a fortune-taker instead of a fortune-maker. We all know by cruel experience that in many cases it is not a financial success. Where to locate the trouble, to point out and overcome the difficulties is the aim of the writer of this article.

Man is not gifted with the power of making an old rope stand the strain of ten tons when it was designed for one ton, yet this is what nearly every railroad in changing its motive power has vainly tried to do. The track that was good enough for a half ton car running about four to six miles an hour, cannot hold up the weight of ten tons at twenty-five miles per hour, any more than the one ton rope can hold a ten ton weight without breaking. Light rail causes poor traction and waste of current. Bad joints see-saw the car and by so doing break the gears and pinions, crystalize the wires in amatures and fields, ruin bearings and journals, break cable wires, and shorten the life of motors and cars which is the cause of endless troubles and useless expense. The proper rail for electric car track has not yet been made. There ought to be a certain mathematical relation between every part of a rail. The base in the present rail, no matter what make or size, is too narrow. If rail is four inches high, base ought to be eight inches wide, etc. The pounding of motors on top of a rail makes the base of a narrow rail quickly sink into the tie and then an uneven track is the result. Experience teaches practical men that ties ought to be from ten to twelve inches wide and to be of best oak, placed no more than eighteen inches apart with at least one foot of good ballast well tamped under each tie. All joints should rest on a tie. Flexible joints are

a humbug and fraud, and are a production of ignorance. Tracks built of rail made at the present time ought to have an iron plate 12x12 inches on top of each tie, as the pounding on top of a rail is transmitted to the plate which has a large surface on the tie and therefore would prevent the rail sinking into the tie. All crossings of railroad tracks should be made of the best material and workmanship, with at least two feet of good ballast and tamped ground foundation. All bolts should be made of machine steel and a good lock-nut and split-pin outside of nut, as close to the outside face of nut as possible, so as to make the pin press hard against nut. All fish or connecting plates should have no less than four bolts in each rail; plates to be of steel and fit tight at the top and bottom; also to be as thick as possible, so as to give great strength to joints which really are the weakest parts of a track. Turnouts should be at least four times longer than the longest car on the road, and the lead between switch points and frogs should be no less than 90 feet. Every dollar put in the improvement of electric railroad track is two dollars made by the investor. Bonding of track is of utmost importance.

The power house is to an electric road what the heart is to the human body. Thousands of dollars have been lost on account of engine builders not understanding the enormous strain to which street railroad engines are subjected. They are now beginning to realize their mistake, yet break downs which ought not to exist are a frequent occurrence. Any engine above one hundred and twenty revolutions per minutes, should never be installed in an electric railway station. Fly wheels should be made of malleable iron instead of cast iron.

TRAINING OF EMPLOYEES.

Electrical financiers forget that five-dollar brains are seldom found in two-dollar skulls, and that to run an electric car right requires even more than five-dollar brains, and the superintendent in charge of an electric road must take the raw material at less than two dollars and put a five-dollar brain in that low priced skull, and that can only be done by hard and constant training. Every man hired for either end of a car should have a thorough knowledge of everything pertaining to a road, and above all, to know all about the detail parts of the motor, trucks and brakes. The only method (or rather the best to my knowledge, and the one the writer pursues,) is the following: When a new man is hired he goes first in the shop to get the names and function of all parts of motors, cars and brakes; then they go to the engine room to learn how the current is produced, what effect grounds, short circuits and lighting may have, the path of the current, etc.; then with the trackmen and linemen, so as to get an intelligent idea of track, line, etc., name of every part and, what to do in case of trouble; then he goes for at least three days on each division with expert motormen and conductors, without doing anything except get a reason for everything from the older employes, learn every inch of track, which means in fact every joint by night as well as day, every overhead

switch, every street crossing, up and down grades, traffic of teams and where most frequent, even to the temper and behaviour of horses, truck and carriage drivers, passengers' faces, at least all those that live along the line, names of all principal hotels, theaters, where located, etc., schedule, meeting places, how to handle car with heavy and light load during wet and dry weather, how to make up and lose time, and what to do quickly in case of lightening storm, and if car should get off track. When this has been learned he goes in the shop again to learn how to handle the switch and brake on a car with trolley down from wire. When he has acquired the proper knowledge in this he then goes out and handles a car under an expert motorman's instructions. After he is through with all this then comes the examination where he has to answer over one thousand questions. The day he is hired he receives our rule book, which he must study until he not only knows every word, but understands it as well. When he has passed through this, I go with him a few trips on each division and watch every movement and correct him if any errors are made. Then every motorman and conductor must attend lectures delivered by me no less than twice a month, when every detail is gone over again, faults and mistakes are pointed out, economy in current and brakes and greater care of car is discussed. If any accidents have occurred they are explained, causes for same and how to avoid them in the future.

(To be continued.)

THOSE ABSURD CURVES.

AN electrical paper, from the isle across the water, some time ago editorialized on American street railway practice, in a way which, though no doubt highly edifying to the writer thereof, was, in the eyes of American street railway men, one of the most ludicrous things ever written. The article was to the effect that the condemnable practice on American street railroads, of making curves which cars had to nearly double their backbones to get around, led to another engineering monstrosity, namely, the radial truck. One bad practice led to another, as was demonstrated by this fact. Does our English friend think that our cities and towns consist of vast expanses of prairie, over which street railways can be built on straight lines, or does it think that a right of way should be condemned straight through solid blocks of buildings? Possibly street railways are built to accommodate the public and get traffic, or again, they may be built for the purpose of satisfying the aesthetic tastes of the engineers building them. With all due respect to our English cousins, there are some things in railway practice they have not even dreamed of.

Playing Cards.

You can obtain a pack of best quality playing cards by sending fifteen cents in postage to P. S. Eustis, Gen'l Pass. Agent, C. B. & Q. R. R., Chicago, Ill.

MAIN POWER STATION OF THE THIRD AVENUE ROAD OF NEW YORK CITY.

ON the block bounded by Sixty-fifth Street, Third Avenue, Sixty-sixth Street and Second Avenue, where erstwhile the stables for the horses of the same line once stood, now appears the magnificent proportions of the new and recently commissioned power station of the Third Avenue Railroad Company of New York City.

The building occupies 200 feet front on Second and Third avenues by 610 feet on Sixty-fifth and Sixty-sixth streets. The building is constructed throughout of the best material and the exterior faced with Colaburg brick, and trimmed with rock finished blue-stone. The interior of the engine room is faced with light buff brick, and has a high wainscoting of cherry and maple, with doors and windows finished in a similar manner. The

BOILER ROOM

in which the lungs of the installation are.

The boiler room occupies the Second avenue end of the building, and measures $72\frac{1}{2}$ by $193\frac{1}{2}$ feet. Here, arranged in four batteries of eight boilers each, are the 125 horse-power horizontal return flue type boilers, built by the Pennsylvania Iron Works, of Philadelphia. They are arranged two batteries on each side of the passage way. On the second and third floors of the building, coal storage is arranged for 4,000 tons. The supply is hoisted by special elevators and descends to the boilers through chutes, directly in front of the furnaces. The fuel is weighed automatically in its fall, and each day's record may be found by adding the totals for the day. Goubert feed water purifiers have found favor in the Third avenue's sight, and four are required, of 1,000 horse-power capacity each. Two Snow duplex pumps

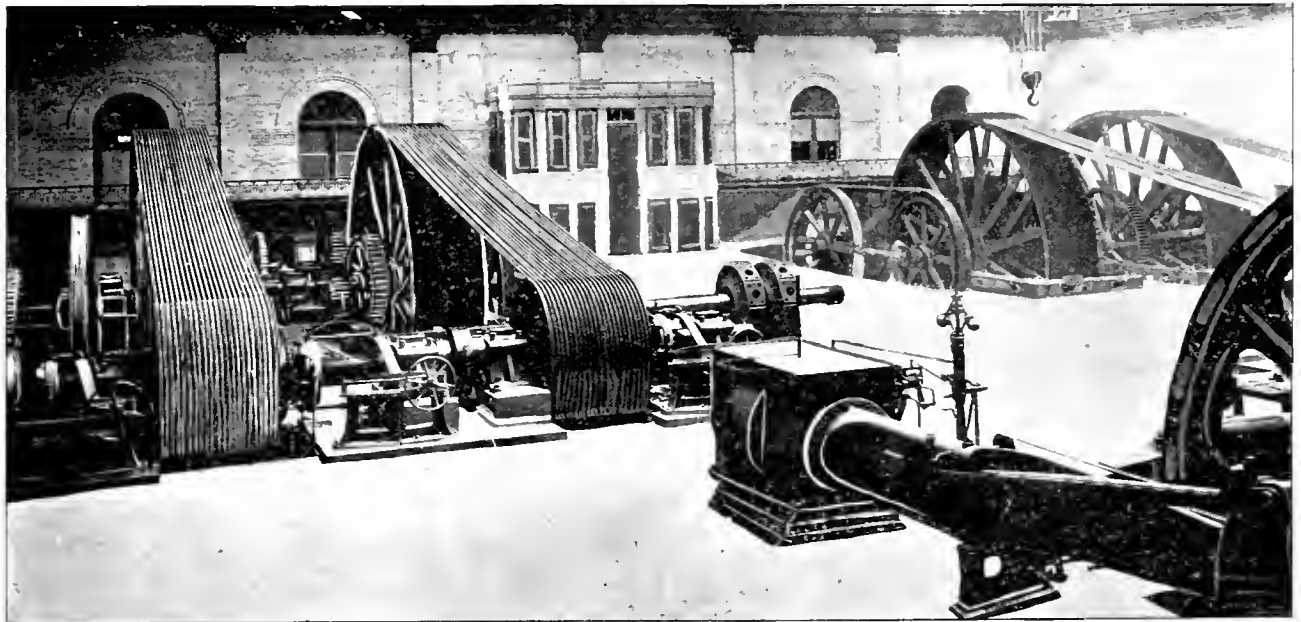

THIRD AVENUE POWER STATION.

roof has a clear span of 137 feet, and is supported by seven heavy truss girders.

On the Second avenue front the building is three stories in height, faced as above described, and relieved by projecting pilasters which have rock-faced blue-stone binders throughout, and heavy rock-faced bases. The windows have arched copings, and each window level is relieved by a band of recessed work. The cornice is surmounted by a serrated coping.

The smoke stack, that stretches 140 feet above the roof, is octagonal in shape and has recessed panels and an ornamental cap at the top.

The Sixty-fifth and Sixty-sixth street fronts are finished similar to the others.

The completeness of the plant can perhaps best be judged by a short description of each of the divisions, and naturally we look first at the

are used in this connection. Steam is led through two 16-inch headers, to an 18-inch main header, which runs clear across the engine room. Twenty inch exhaust piping is in vogue.

Through the centre of the power station stretches the engine room. It measures 170 by 137 feet, and has two alcoves on both the north and south sides. Four Providence-Corliss engines are here installed, of the non-condensing single expansion pattern. The cylinders measure 40 inches in diameter, by seventy-two inches stroke. The engines are arranged in pairs. One pair is placed at the east end of the engine room, driving shafts, 26 feet 9 inches in length, and 18 inches in diameter. The fly wheels mounted on those shafts are of 23 feet 9 inches diameter. On these shafts also are driving pulleys of 22 feet diameter, driving 22 foot pulleys on the main shaft, by means of twenty-two $2\frac{1}{4}$ inch

Lambeth cotton ropes. The other pair of engines are placed at opposite ends of the main shaft. This shaft, which is in eight sections, connected by plate couplings, of 48 inches in diameter, is 20 inches in diameter in the swell, and has bearings, 18 by 30 inches, and here are placed four 9 foot pinions of 22 grooves each, mounted in brass bushings and capable of being connected and disconnected from the main shaft by friction clutches.

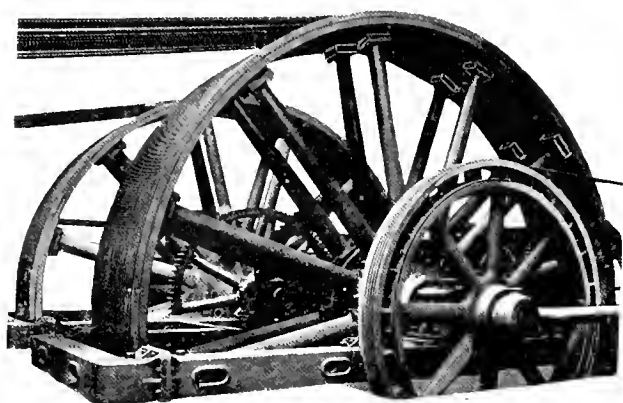

ONE OF THE BIG DRIVERS.

Twenty-two $2\frac{1}{4}$ inch cotton ropes directly connect the pinions with a 32 foot driven drum. A 15 foot cable drum with Walker differential rim, is mounted on the main shaft. There is one large pulley for every pair of cable drums. The other driver of each set, is driven by an intermediate gear of 8 foot diameter. The idea of this arrangement, is of course, the ability to operate, any set of drivers by any engine, if necessity arises.

of the way, one in a corner of the boiler room and the other in the gallery of the engine room. December 4 was opening day and the company invited the great of the city to participate in its joy. Of the company attendant were president Elias, contractor T. E. Crimmins, Henry Hart, and the engineers of the Pennsylvania Iron Works. Besides these assembled, representatives of the Laclde Car Company and many other prominent supply men as well as newspaper men took the formal opening trip.

The road is of course magnificently equipped. Laclde cars thirty feet over all, finished in mahogany and birdseye maple are used. They are mounted on Baltimore Car Wheel Company's trucks and Hale & Kilburn's elegant dark red plush seats add to the comfort and effect. There are seven windows on each side glazed with French plate. The lower part of the car body is white with a center panel of bright red with silver striping and gold lettering, the upper part of the body is red, as are the dashboards. The Pintsch gas and 300 combination Smith lamps light the cars.

The ones to whom the honor of the completion of this is due and to whose engineering and technical skill it is a monument we introduce to our readers in the following brief biographies:

B. W. GRIST, C. E.

was born in Boston, England, in 1842, and in the good old English style, began his mechanical education in the machine shop to which vocation he was apprenticed. Having thoroughly learned the business, Mr. Grist seeing the opportunities for the exercise of his skill, came to America and settled in Philadelphia, where he followed his profession, becoming at a later date general manager of several large machine shops in the cities of Lebanon



B. W. GRIST.



E. A. MOORE.



J. H. ROBERTSON.

Each engine is capable of operating two sets of drivers. For inspection and pulling in the ropes, a pair of auxiliary engines is provided, connecting with the drivers by gears and clutches. The drums have in place of outside bearings, a special strut to keep the drivers in parallel; the invention of engineer Grist. The tension carriage is mounted on 30 inch wheels. The tension runs are 255 feet long, at the Third avenue end of the house, and below the street.

A special isolated light plant and complete blacksmith and repair shop are connected with the plant, and are out

and Reading, Pennsylvania. In 1880 Mr. Grist began business for himself as B. W. Grist & Company, Ltd., and did a general machine business.

In 1886 Mr. Grist became associated with William Elkins, Jr. and others. This association has since become that great institution, the Pennsylvania Iron Works. In this enterprise Mr. Elkins and Mr. Grist have shown to magnificent advantage a combination of financiering skill and executive ability rarely found. Great credit for the success of the company belongs to these gentlemen, whose interest in the great enterprise has never flagged.

E. A. MOORE, C. E.,

whose connection with the cable railway building, has given him national reputation, was born in 1864, at Glen Moore, Pa., the residence of the Moore family. When six years of age, the family removed to Reading, where Mr. Moore received his education. When eighteen, he became associated with Mr. Grist, then general manager of a machine shop, of that city. With Mr. Grist, young Moore went into the Pennsylvania Iron Works, where his career is familiar to all our readers, who have followed the construction of the Pennsylvania Iron Works' magnificent plants, in various parts of the country.

SUPERINTENDENT J. H. ROBERTSON,

is a Scotchman, as might be imagined from the name. His residence in Caledonia, however, was not of long duration, for at the age of eight, in 1842, he came with his parents to New York. Here he attended the public schools until sixteen, when he was apprenticed to the carriage trade.

Being a Scotchman, he was naturally a warrior, and being a New Yorker, he was naturally a federalist, so it is not strange, that 1863 found him in the Sixty-ninth New York Infantry, serving until the end of the war. After the war he returned to New York and engaged with the Third avenue street railway, of which he was made superintendent of shops in 1871, and ten years later, general superintendent. Mr. Robertson's position has been won by his own native ability and worth, and the fine system of the Third avenue is a credit to his executive ability.

R. P. TOMASSEK

the chief Engineer of the Third avenue railroad was born in Austria, in 1839. His education began in the public schools and at the age of 19 he entered the Imperial Engineering College, from which institution he received the degree of civil engineer. In 1865 Engineer Tomassek went to Mexico, as engineer for the Austrian government, remaining there two years in this service.

At the close of this engagement Mr. Tomassek came North and settled in New York City, but later went to Buffalo as chief engineer for the Kellogg Bridge Works. Railway engineering however had charms, or at least it would so appear, for Mr. Tomassek left bridge building to build the Buffalo & Johnstown Railway. His next experience was as engineer and contractor at Hamilton, Ontario, later, returning to Mexico as bridge engineer for the Mexican Central Railway. Here he remained until his present appointment with the Third Avenue Railroad Company as chief engineer.



R. P. TOMASSEK.

STREET CAR CURTAINS.

Of all the refining and comfort producing improvements which the modern luxurious street cars have called into use, perhaps no one feature contributes more than the street car curtain. The difference between struggling with a wooden shutter, which unlike Banquo's ghost, will not "up," and a noiseless, easy running shade which a lady may regulate with a touch, is as great as the contrast between the old style cars and

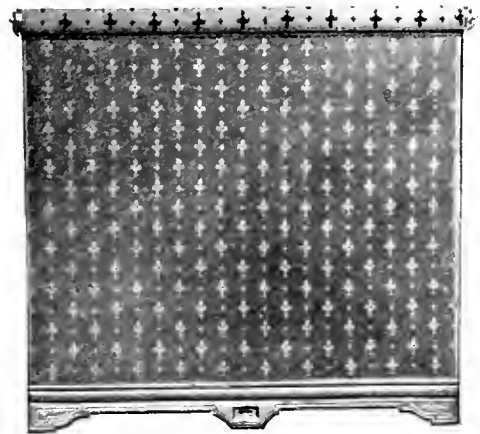

the new palace cars. The wooden blinds also are notorious for getting "rattled," and form the lodging place for dust, which suddenly appears in clouds, from no one knows where. The car shade is taking the place of the old style, just as an hundred other improvements and conveniences have already done. The shade illustrated herewith is one of a choice variety of styles, manufactured expressly for street car work, by the McKay Curtain Company, of Wilmington, Del., whose facilities are among the largest in the country, and the quality of whose work is proven in every shade that leaves the factory.

OBITUARY.

ROBERT YOUNG.

We regret to announce the death of Robert Young, chairman of the Glasgow Tramways & Omnibus Company, on November 16. Mr. Young was seventy years of age and to his last retained the business sagacity for which he was noted. His life was a varied one and his death regretted in many circles of business in which he was interested.

STEPHEN WILCOX.

Stephen Wilcox, of the firm of Babcock & Wilcox, died at his home at Brooklyn, November 27.

EZEKIEL H. TROWBRIDGE,

one of the most prominent citizens of Connecticut, died at his New Haven home, Nov. 24. Mr. Trowbridge was 75 years of age, and left an estate estimated at \$1,000,000. He was one of the chief owners of the Fairhaven & Westerville Street Railway.

STREET SPRINKLING BY STREET RAILWAYS.

THIS is a season of the year when managers are more immediately interested in sprinkling with salt than with water, but at the same time the wise ones are planning for next summer, and one of the questions that ought to come up is that of sprinkling. It comes to different companies in very different ways. In some places the street is already sprinkled by a company collecting its revenue from the property owners; and in many places, companies must sprinkle their tracks, the same as maintaining pavement. On other lines there are long, dusty stretches of suburban road, that have to be sprinkled in some way to make it endurable for passengers. It is unnecessary to speak of the saving in power,

under the car. The street is wet down by means of a long perforated tube. This tube can be swung around next to the car, to avoid teams. Two men make a crew for each car, one to run the motor, the other to tend to the sprinkler arms, and regulate the flow of water.

For purposes of filling, flush hydrants connected to the waterworks are located about once a mile along the street in manholes between tracks. By the help of a specially designed ball and socket connection, the car hose is attached, the car filled and hose hung up ready to start, in an interval of about two and a half minutes. It has been used on the Calumet Electric Railway, of this city, during the past summer, to subdue the clouds of dust that made travel a burden on its lines. It was operated entirely at the company's expense, and took the place of numerous high salaried sprinkling wagons. At



SPRINKLING ON THE CALUMET LINES, CHICAGO.

and wear and tear on motors, due to having a clean rail and dustless roadway. Street railway men are apt to be rather indifferent on the sprinkling question, and look on sprinkling cars as nuisances, that are only endured because they are sometimes a necessity. It has been demonstrated in the past two seasons, however, that sprinkling can be made a source of profit, as well as a gain from an engineering standpoint. This is accomplished by having a sprinkling car that will not only sprinkle the track, but will take the place of an ordinary sprinkling wagon on the street. The cars built by the United Tramway Sprinkling Company, of Louisville, Ky., afford a method of sprinkling that is far superior to wagons, from the standpoints of economy, speed, and the quality of the work done. The track sprinkling is done by sprinklers

other places, most notably, Rock Island and Louisville, these cars are quite a source of revenue to the street railway. At Louisville they are run between cars on a $2\frac{1}{2}$ minute headway. At Rock Island and Davenport, the local sprinkling company owns the cars and pays for the use of power and track. Our engraving shows the car on the Calumet, running on one of the streets of South Chicago. Wherever fairly tried, these cars have proved a great success and a decided improvement on old methods. Even where the railway company does not care to undertake a contract with property owners to keep the entire street wet, although most companies could realize a handsome revenue by doing so, it will pay them to encourage the formation of a local company for the purpose. This relieves the road of all the office

and detail work of making contracts and collecting bills, but insures a regular rental for hauling the cars over its lines. In all but the larger cities the railway company can undoubtedly handle the business itself and at a very small expense, and in the smaller cities the present office force is amply sufficient. The question should be taken up at once and contracts made, and sprinkling equipment ordered, so that everything may be in good working order for prompt commencement of the work in the spring. The United Tramway Sprinkling Company, Louisville, kindly offer to furnish any manager with full data as to operating cost and profits, and the figures should be secured and studied by every manager. They are surprising.

THE ADAMS WATER TUBE BOILER.

THE Adams water tube boiler as will be seen from the illustration is of the type having a central tank with outwardly projecting tubes, which type, as is well known, one of the most efficient on the market as far as coal consumption goes, the main trouble having

been with scale. In the Adams boiler this difficulty is lessened in several ways. The tubes are all constantly below the water line. As shown in the illustration the water is fed into the reservoir formed by the extension of the central tube up into the steam drum. From this chamber the water descends to the bottom of the boiler through an outside tube as shown. The upper reservoir acts as a live steam purifier so a great deal of the solid matter in solution is dropped before it reaches the boiler proper. If the water is very bad a trap can be put on the pipe connecting top and bottom of boiler to give sediment an extra chance to settle. It is an easy mat-

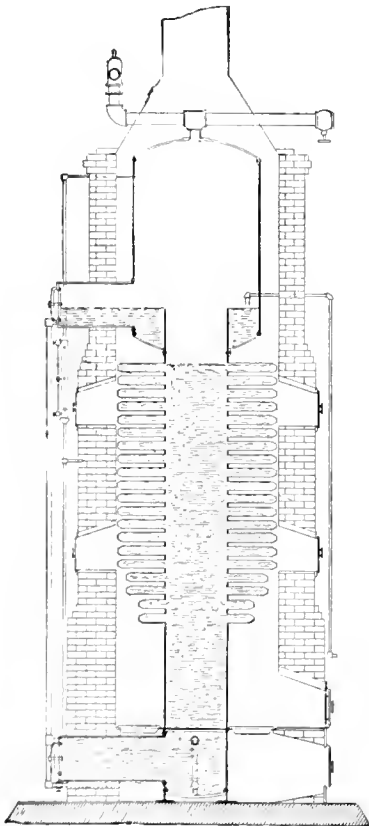

ter to clean out the bottom of the dome. Each boiler is a complete unit by itself with the stack castings and fittings. The guarantees made by the maker places its evaporative duty equal to any water tube boiler made. It has been extensively used in iron works through Ohio and Pennsylvania. C. P. Adams, 807 the Cuyahoga, Cleveland, is the maker.

STORAGE BATTERY TRIAL IN CHICAGO.

THE Twenty-second street small boy has been greatly exercised of late over a street car that has no visible means of locomotion. The car in question was, however, carrying passengers running trip about with the trolley car and actuated by an old Rae motor of 25 horse-

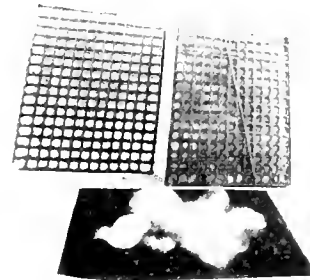

GRIDS.

power, geared to both axles, getting current from a series of Globe storage batteries, of which is this story:

The Globe battery, which has been mentioned from time to time, is the invention of H. C. Porter, of Chicago, and is particularly intended by the inventor for traction work. The interest shown in storage batteries and the points of excellence claimed for the battery in question prompt the description of the element. The cell has a hard rubber case which may be sealed, and one of the principal claims of the battery is its lightness consequent upon this construction. The component parts of the element are:

(1) The conducting plate, which consists of thin strips of metallic lead, applied to the active material by insertion. (2) The active material which is held in place by (3), two hard rubber grids in a perpendicular position. These grids at each square have shelves or projectors which sustain the material. Two grids, face to face, form a box for the reception of the material and into this the lead conducting rods are forced perpendicularly, but in no wise supporting the material. This combination effects an electrode and a number of these form the positive and negative elements. These are bound in sufficient numbers and encased in the hard rubber covering. The construction of the electrodes enables them to take energy faster than if they were thicker, and the shelf arrangement gives greater stability to the

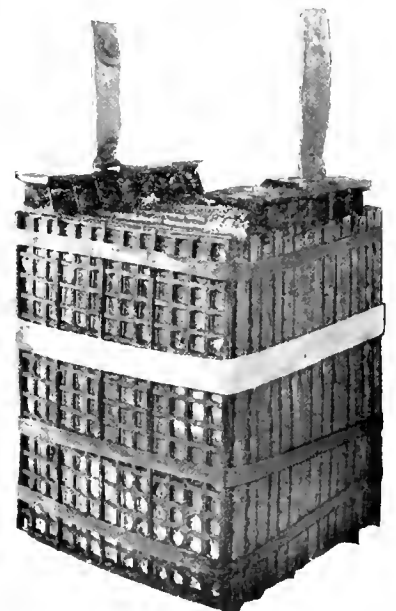

BATTERY COMPLETE.

material. Another claim is that with usage the material becomes porous, making it more retentive of energy than batteries depending on lead support.

The car in question, on the Twenty-second street line, is a 16-foot body, mounted on a Peckham 6 A truck and equipped with 84 cells of the Globe battery placed under the seats. The motor as noted is a 25-horse-power Rae. Power was obtained until lately from the Siemens-Halske station, from which generators the trolley cars obtained their current. The charging station was a picnic affair, in fact, nothing but a tapped trolley and a resistance, to reduce the voltage to 210. The batteries were not removed from the car, but charged while in place. The

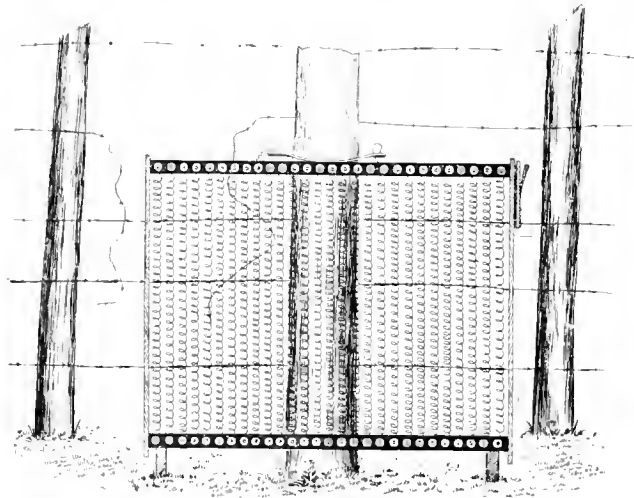

THE REDUCING STATION.

cells are charged once a day, at from 55 to 65 amperes. The car operated some time, without hitch or hinderance, speeding up to trolley rate. It takes seven hours to charge.

The readings of a 68-pound Globe storage cell give some interesting data. The voltage began at 1.92 and the results were:

	1	2	3	4	5
Voltage,	1.92	1.90	1.88	1.80	1.75
Amperage,	25	50	80	100	120
Time,	45 min.	60	20	40	20

The same cell is said to have discharged at 25 amperes showing a capacity of 317 amperes, at a potential beginning at 2.0 and finishing at 1.85.

No figures are extant as to the life of the electrodes, but the Syracuse line, operated by this battery, returns some data. C. L. Pack says: "We find the actual cost of charging the car is 37 cents for seven hours. We run 125 miles on one charge; voltage at start 204, at end 192. The road is quite level and the track terribly rough. The motor seldom draws less than 45 amperes and sometimes as high as 200 amperes in starting. In one of our day's work we carried about 400 paid fares, distance run 117 miles, time 15 hours, cost of fuel 35 cents, labor 65 cents. We furnished our own dynamos."

THE PORTSMOUTH, O., Street Railway Company opened its line November 16, with fitting ceremonies.

PERSONAL.

F. X. CICOTT, well known to all street railway men, was a recent caller at the REVIEW office.

MRS. T. H. McLEAN, of Indianapolis, who has had a long and dangerous illness is recovering.

C. B. THURSTON, of the Jersey City Consolidated, has been made receiver of the Newark Chemical Company.

MARCUS C. LANIUS, brother of Captain W. H. Lanious, president of the York, Pa., street railway, died recently.

PRESIDENT J. A. RHOMBERG, of the Dubuque, Ia., Street Railway Company, was seriously injured by falling on a slippery walk.

WILLIAM H. GRAHAM, secretary of the Pleasant Valley Traction Company, of Pittsburg, has been distinguishing himself as a lecturer on the World's Fair.

F. E. PRITCHARD has returned to Oswego, N. Y., and resumed his position as superintendent of the Oswego Street Railway and the People's Electric Light & Power Company.

PRESIDENT JOEL HURT, of Atlanta, is already beginning to think up attractions for the coming convention and spent several days in Boston recently, conferring in the matter.

A. E. JONES, who had entire charge of the installation and exhibit of the Morrin climax boilers at the fair, has just returned to New York. He made hosts of friends while here.

H. H. LYNCH, recently appointed chief of construction of the Consolidated Street Railways of San Francisco, was given a banquet in the maple room of the Palace hotel, by his friends.

G. H. VAN VOORHIES, of the Railway Equipment Company, is just at present afflicted with a broken leg. For a man of Mr. Van Voorhies activity he is bearing the confinement very well.

B. E. CHARLTON, president of the Hamilton, Ontario, Street Railway Company, has undergone an operation on his eyes for cataract, and says he believes the operation will prove quite successful.

ROBERT HILL, chief engineer of the Chicago City Railway, has just returned from a three weeks trip through the east, where he made a very thorough inspection of the largest electric systems.

SUPERINTENDENT HENRY A. NEWELL, of the Broadway cable, New York City, and Miss Stewart, of the same city, were married several months ago, but their wedding has just been made public.

SUPERINTENDENT M. K. BOWEN, of the Chicago City Railway, has returned from his first vacation since his connection with the company. He spent two weeks in Tennessee, a-hunting of wild animals.

SUPERINTENDENT GEO. W. HOMMELL, of Milwaukee, is, we are happy to say, recovering from an attack of pneumonia that nearly cost him his life. His many friends will be glad to know of his returning health.

H. A. EVERETT, has resigned his position as managing director of the Montreal Street Railway, but will remain on the board. His successor is Granville C. Cunningham, the chief engineer, who now takes the title of manager.

GASTON DE LASSUS, assistant secretary of the Duquesne Traction Company, Pittsburg, is on his first vacation since his connection with the company. He will visit his

KNOX TOWER WAGON ON THE CITY RAILWAY.

IT is one thing to build a tower wagon, it is another thing to build one that will stay together for any length of time, and it is still another to make one that will stand the service of a wrecking wagon. The one illustrated in our engravings is in use on the Chicago City Railway, being located at the barn at Sixty-first and State streets. It is the design of G. W. Knox, the electrician, who gathered up the results of his extensive experience with tower wagons, and drew the plans for the present one which is in regular service as a wrecking wagon, answering emergency calls. It is fitted with all the tools ordinarily put on a wreck wagon, and also material for fixing overhead work. The wagon, complete with tools, weighs 3,800 pounds, and is so strong and compact as to be admirably adapted to making runs. The tower is entirely of iron, and the platform is raised

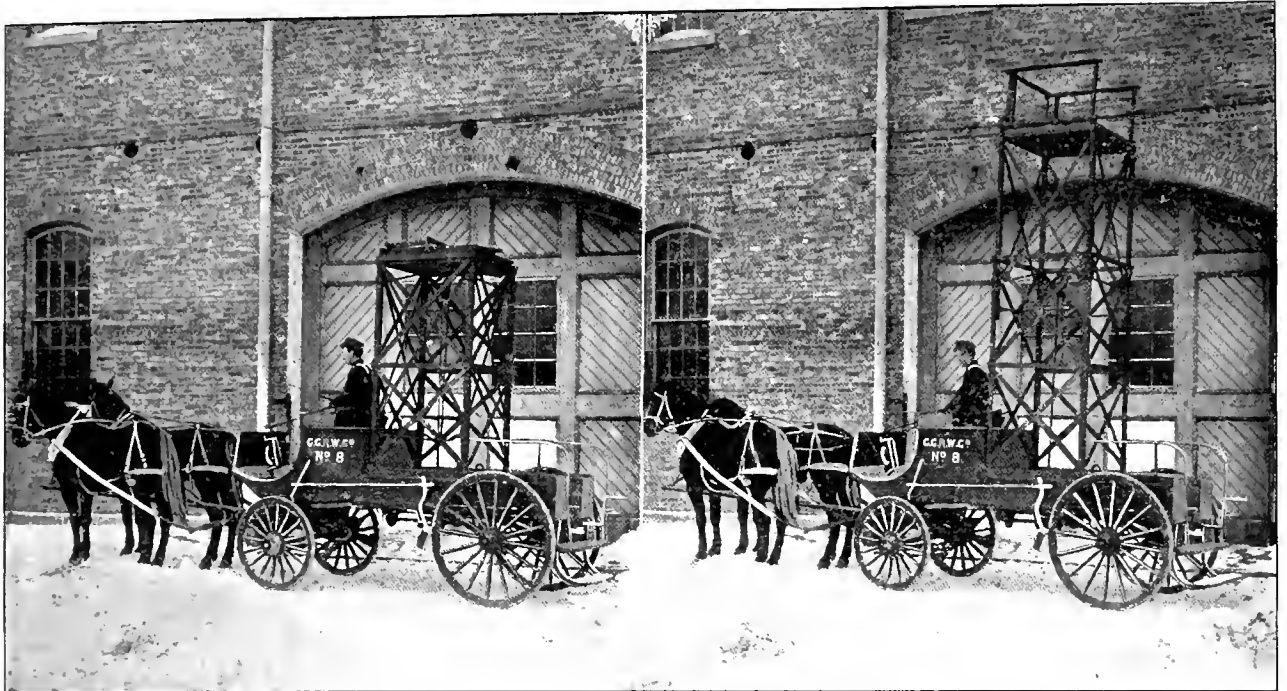

THE COMBINED TOWER AND WRECKING WAGON.

New Orleans home and take a trip into Mexico and Central America.

HERBERT WARREN, the recently appointed general manager of the Duluth City Railway, is a self-made man, having raised himself to his present position by his own efforts and sterling worth. Seven years ago he was collector on the St. Paul City Railway.

ALEX. LEWIS, formerly of the General Electric, has become western representative of the Curtis Electric Company, with offices in the Monadnock building, Chicago. Mr. Lewis is too well known to require introduction, and the Curtis motor is to be congratulated on its introducer.

from a height of ten feet to fifteen feet and a half by a chain and pulley, operated with a detachable crank at the rear steps, and shown in the engravings. The axle turned by this crank is geared to the chain drum. A ratchet on this crank axle keeps the platform at any position it is left. The platform corner supports slide up and down inside the four corner posts of the main frame, both sets of posts being of angle iron. Tool boxes are located under the driver's seat and along the sides of the box. The wagon itself is very similar to that used as a wrecking wagon.

THE Third avenue cable of New York will use the lever instead of the wheel grip on their cars.

THE LAKE COMPANY'S FRICTION CLUTCHES AND COUPLINGS.

THE specialties of the J. H. & D. Lake Company, of Massilon, Ohio, are the Barnes screw lever friction clutch pulley and the Barnes screw lever friction clutch cut-off. Figure 1 is a longitudinal section of the friction clutch pulley as released, and having the

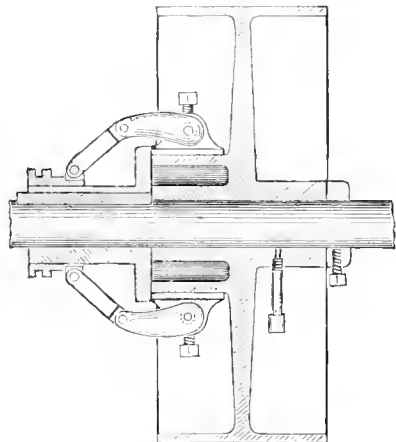

FIG. 1.

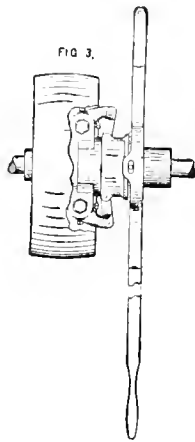

FIG. 4.

driving hub keyed to the shaft. The same is shown in perspective in Figure 2 and a sectional end view is illustrated in Figure 3. The latter shows the friction hub

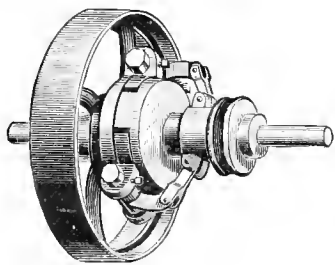

FIG. 2.



FIG. 3.

encircled by the friction ring, the hub being cast in one solid piece with the pulley. The projecting lugs on the opposite side of the driving hub of the ring drop into the

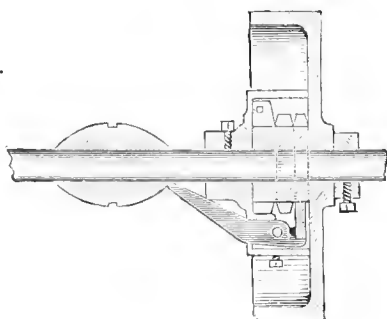

FIG. 5.

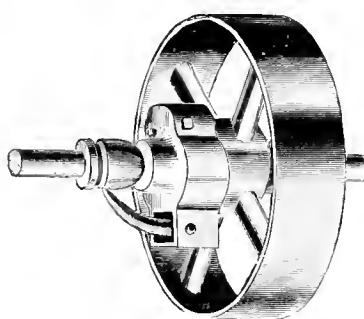

FIG. 6.

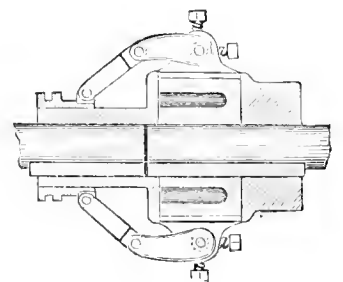

FIG. 7.

lug cavities of the friction ring and when the clutch is on these lugs take all the strain. In Figure 4 the whole combination with lever attached is shown. Figure 5 and 6 are of a friction clutch pulley intended for light work on countershafts, etc., and known as the Barnes single

lever or multiband friction clutch pulley. The friction ring is simply a spiral band which closes by traction pressure at the ends.

In spite of the recent depression the J. H. & D. Lake Company has prospect for a good business during the winter. They moved to Massilon recently, from Hornellsville, N. Y. The new establishment is a model of completeness. The daily capacity of the foundry is about 20 tons.

NEW TERMINAL AT SAN FRANCISCO.

THE plans adopted, and published recently in the Review, for terminal arrangements of all the lines in San Francisco, at the Ferries, have been changed as illustrated herewith.

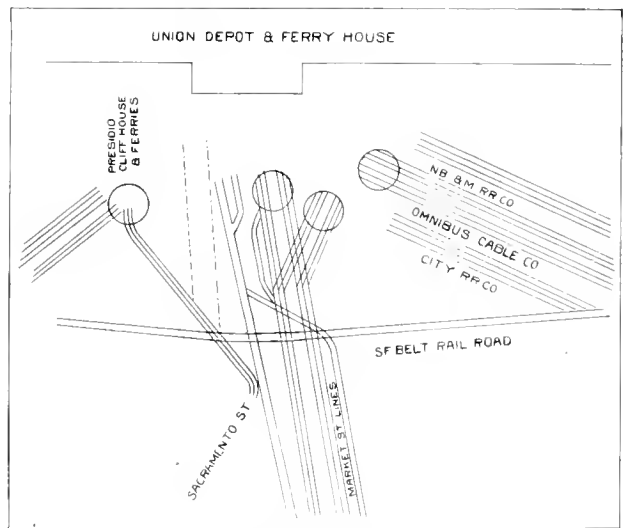

On some of the Hamburg lines coal dust is being experimented with as a rapid burning fuel. It is blown into the furnace by a jet.

CHAS. COON, chief inspector, of the Buffalo Railway Company, on his recent promotion to that office was presented with a gold watch by his fellow employees.

AFTER an exciting suit the case of Peter Conley vs. the Cincinnati Street Railway Company has been decided, and Peter has been awarded 12 cents damages in place of the \$3,000 he wanted for a mis-punched transfer.

ANNUAL REVIEW OF THE YEAR WITH OUR ADVERTISERS.

Reports Received from only a Small Number, but Indicate a Better Business than could Reasonably have been Expected. First Six Months very Heavy. July, August and September, dead. Last Quarter shows Steady Recovery.

93 HAS been a disappointment. At this time a year ago the universal expectation of the supply dealers and manufacturers was for a continuation through the months of this year, of the phenomenal business enjoyed in '92. Notwithstanding the almost certain indications, it was scarcely to be hoped that the tremendous pressure under which new lines were built and old ones re-constructed at even greater expense, could in the nature of things long continue; but at the same time there were promises and even many contracts made, which the sudden stringency in the money market withered and blighted as suddenly as a frost. Up to July 1 our reports show a fine business; in many cases its volume even exceeding the 12 months of last year. Then the bottom seemed to drop out within a week, and the wires were hot, countermanding orders already placed and extending indefinitely delivery date of machinery and materials in process of manufacture. This was much easier for buyers to do than manufacturers to carry out, and in nearly every instance worked a severe hardship, for large investments had been made and were now left on the builders' hands as a dead weight. Others who had gone to much expense preliminary to bidding on contracts, no small sum in the aggregate, had to call a halt and try and exercise patience. Not only were there no orders placing during the summer quarter, but sales of repair parts were far below the actual necessities of roads, most of which reduced service and deferred any but the most absolute repairs. The result is that many roads throughout the country have kept on wearing out, and are already beginning to reap the harvest of neglect, and eventually there will be demands for this branch in excess of what would otherwise have been required. Few extensive betterments were made this year, and by spring many roads will have to do some lively work.

The last three, especially November and December months, indicate a strong, though not complete, recovery, and really present a much brighter outlook for next year than was believed possible 90 days ago.

One good feature of the depression, and which should be maintained for the mutual good of buyers and sellers, was the almost general refusal on the part of dealers to grant long time payments. By this we mean 12 and 18 months' paper, as was getting to be an altogether too frequent occurrence. Competition was the cause which had led up to this by slow degrees, and when bottom prices were reached by active bidders, they commenced a frantic struggle to see which could outdo the other in deferring the day of settlement the longest. This is radically wrong, and can eventually result only in the purchaser paying more for supplies than had they bought on shorter time.

With one or two exceptions, the street railway supply firms have weathered the storm wonderfully, and it is at least a matter of congratulation, as one writes, that "we are still in existence." Quite a number have even increased their manufacturing facilities, and a few have erected entire new factories.

And what about the new year? From every hand come encouraging reports. We do not look for a feverish boom in building new lines, where no urgent necessity exists, but everything now points to a firm, steady and much more extensive construction and renewals than is at all evident on the surface. Capital is already weary of its enforced hiding and is getting hungry for its accustomed interest revenue, and the probabilities are, abundant finances will be available for all really meritorious and legitimate enterprises.

We most heartily wish for all our advertisers a busy, prosperous year, in the coming months of 1894.

AUGUSTUS DAY, Detroit, has made but few changes in his popular track cleaners, for which there has been a steady demand for years. Finds present orders up to the average years. He now makes a type for grooved rails.

DURING the year, J. H. Gates has assumed the western management of the Waddell-Entz Company, with offices in Monadnock building, Chicago, being the first representative of that company in the west. He has secured a very satisfactory number of contracts and has every reason to be satisfied.

C. S. VAN NUIS, New York, brought out his Ajax lightning arrester, which was favorably received. Foreign orders include South America and Canada. Last two months somewhat slower, but balance of year, business fully up to last year. "With easy money market, business should be very brisk in '94."

THE NEW CASTLE CAR MANUFACTURING COMPANY, New Castle, Pa., has had a busy year in which its business was doubled. Increased capital stock \$12,000, added new buildings and machinery, doubling capacity; are about to erect a large varnishing shop. Have brought out several styles of baggage and combination cars. Outlook very satisfactory.

THE MILBURN WAGON COMPANY, Toledo, O., made a big gain the first six months, and while the depression was noticed the following months, have enjoyed a good business, and will require full force January 1. The Lincoln tower wagon has given perfect satisfaction, and buyers have sent in very gratifying testimonials of satisfaction.

Street Railway Review

INTERNATIONAL REGISTER COMPANY, Chicago, have had a healthy increase in trade; have put in more machinery; have sold large special orders to the Calumet Electric and West Chicago roads of this city. Expect to treble capacity next year, and will put their new "Aluminium" register on the market January 1. Received medal at World's Fair.

LANE & BODLEY, Cincinnati, added new machine tools to their already extensive plant, and brought out a new set of Corliss engine patterns—the Columbian. The frame has a bed section, and is a most rigid and strong construction, specially designed for street railway work. Foreign shipments to Mexico and Cuba. For 1894, predict "a fair volume of business."

THE JOHNSON COMPANY, Johnstown, Pa., notwithstanding the great falling off in new construction, have made a surprisingly large output of rail, much of which has gone on second orders. In special work there has been plenty to do in intricate curves and crossings, the tendency of buyers being to order better and heavier work than was once thought necessary.

THE NEW HAVEN CAR REGISTER COMPANY has been kept busy, especially the past two months, in filling some large export orders. Is now getting out several large orders for American roads. "We believe the coming spring will show greater activity than ever in the construction of new lines, and are much gratified at our own prospects."

THE UNITED SPRINKLER TRAMWAY COMPANY, Louisville, Ky., has made substantial progress this year, introducing its cars into several new cities where splendid records were made. A large amount of preliminary work incident to the introduction of all new ideas, has been accomplished, and as a result numerous contracts are closing for next season's business, which promises bright.

THE BROWNELL CAR COMPANY, St. Louis, have nearly doubled last year's facilities by additions to former factory and increased machinery. The record of the Accelerator cars where introduced last year has been highly pleasing, and large sales were made to Detroit, Cincinnati, Covington, Baltimore, Brooklyn, Boston and Chicago. The volume of business has been larger than '92.

THE GARTON-DANIELS ELECTRIC COMPANY, Keokuk, Iowa, date their incorporation from May, 1893. The Garton metallic circuit arrester has met with a large sale, not only to new companies, but second and third orders from old users. Foreign shipments went to Belgium, Germany and Panama. A specially large order was 284 arresters to the Cincinnati, Newport & Covington road.

ABENDROTH & ROOT MANUFACTURING COMPANY, New York, greatly enlarged their erecting shop. Foreign shipments of boilers and spiral riveted pipe were made to Central and South America, Mexico, Africa and

Japan. The output exceeded that of 1892, which, under the depressed conditions, is particularly a matter of satisfaction and highly complimentary to the firm's products.

J. H. & D. LAKE COMPANY, Massilon, O., doubled their foundry and machine shops. A large shipment of friction cut off couplings and friction clutch pulleys was made to Santiago de Cuba. Business has gradually increased in spite of hard times, and a new pattern shop is about to be erected. "The prospect for business in our line, after January 1, is very good, judging from the volume of inquiries which is increasing daily."

HALE & KILBURN, Philadelphia, report large shipments to Europe, Canada, Mexico, Cuba, Brazil and China. First six months of the year up to high water mark of '92, but felt depression somewhat last six months. New goods include reversible cross seat No. 71½ for street cars, which has met with great favor; also improved their spring side seating. Traveling force increased in the person of J. S. Lindsey, who gives his entire time to street car department,

ALBERT & J. M. ANDERSON, Boston, will remember 1893 as the year they erected and occupied their new and extensive factory, affording greatly needed and increased manufacturing facilities. Among several new devices of the year may be mentioned the Boston or Pivotal Boston trolley; the West End trolley wheel, and a new section insulator described elsewhere in this issue. Foreign orders have been good, and the business of the year quite satisfactory.

THE MOSHER ELECTRIC COMPANY, Chicago, whose arc lamps for railways circuits have made a splendid record, have had a good year with an increasing business, as railway managers became aware of the excellent merits of the Mosher lamp. During the year they brought out a new constant potential direct current arc lamp and a new alternating current arc lamp, both of which are favorites. Foreign orders include South America, China and Finland.

IDE & SON, Springfield, Ill., established new agencies with W. H. Post, Detroit, and Fred. Beall, Ft. Worth. Added more machinery for improving and lessening cost of product. New appliances include power transmission with idler pulleys and direct connected engines, seven of the latter of which were sold. One engine was sent to British Columbia. Volume of business was a trifle less than '92; may erect new shops next year, but consider business outlook discouraging.

THE STEEL MOTOR COMPANY, Cleveland, have added new machine tools, affording increased facilities. New devices are: New single reduction "steel clad" railway motor and series multiple controller, both showing remarkable results in power efficiency and low cost of maintenance. Of fifty car equipments, which ran entirely encased all through the hot weather, all are still

running, without having required any outlay for electrical repairs. Will soon increase machinery in motor department.

THE CHARLES SCOTT SPRING COMPANY, Philadelphia, have had a steady demand for their well known elliptic springs, which are standard on nearly all the trucks in the market. The year has shown an increasing tendency, both of truck makers to recommend, and managers to use an increased spring support on motor trucks, a step undoubtedly in the right direction. Their success with trolley and brush holder springs, has been very gratifying, and this type of spring has also had a greatly increased sale.

C. D. MORSE CAR MANUFACTURING COMPANY, Millburg, Mass., are another of the firms who will date their street car business from '93, having entered the field last spring. Their efforts were successful, and in a very short time were obliged to double most of their buildings, and contemplate erection of still more buildings in the spring; are highly gratified with the year's business, and "predict a very busy year for car building, and consequently, in other lines of supply business, for 1894, and the outlook exceedingly brighter."

THE BALL ENGINE COMPANY, was unable to break last year's record, because, in 1892, they ran night and day during the entire year, excepting July and August. Their business, however, has been very large, and considering the greatly decreased demand for all kinds of machinery, has been surprisingly large. They are now bringing out a line of vertical engines, and have added two sizes of horizontals. Foreign shipments were to Mexico, Cuba, Manilla Islands and other countries. Find business improving and "believe it will be good in 1894."

CONSOLIDATED CAR HEATING COMPANY, Albany, N. Y., made E. A. Smith, formerly assistant secretary and purchasing agent at the home office, general agent at Chicago, with office at 200 Western Union Building. Their new electric heaters were a feature of this year, and required additional facilities and increased help in the factory. Volume of business exceeds last year by 10 per cent. Fifty-seven electric lines were equipped with electric heaters, the Calumet and South Chicago roads taking heaters for 75 cars. Considers prospects for '94 good.

THE GRAHAM EQUIPMENT COMPANY opened a new office in Philadelphia, at 232 Carter street, with W. A. Bartlett, Jr., in charge; also established new works in that city and increased the Boston factory by an addition, 35 by 70 feet. The improved Graham truck has been adopted as the standard on 14 roads, an excellent showing. One truck, on telegraph order, to go under a snow plow at Bath, Me., was assembled and shipped in five hours. Plans are now making for an entirely new and much more extensive plant at Boston. Predict a good year.

PITTSBURG STEEL HOLLOWWARE COMPANY have had a busy year and have doubled the record of '92, notwithstanding the close money market, capital was increased from \$12,000 to \$50,000, and main office established at 43 Federal street, Pittsburg, with James McNaugher, Jr., secretary and treasurer, in charge; also a branch at San Francisco, McLure & Kaufman. Facilities increased to 500 gongs per day. Foreign shipments to Canada, with recent inquiries from New Zealand and Australia. "We look forward to a large increase next year, judging from all present indications and inquiries."

THE SHULTZ BELTING COMPANY, St. Louis, have increased their machinery and established additional agencies abroad. A notably large order was one of 22,000 feet to Russia. One "wanted quick" order, was for \$11,000 worth of belts for the Sherman Oil & Cotton Company. President Schultz says: "We think the outlook for next year is good for all lines of business, as people have been economizing and using up old material and material on hand, and there will be good demand for everything next year. The country will go on, and labor will be employed, and we will be happy."

THE RICE MACHINE COMPANY, Chicago, opened a branch in Milwaukee, at 93 West Water Street, in charge of Wm. L. Phillips. Their machinery was considerably added to. Very satisfactory results are reported from all users of their wood-rim iron center fly-wheels and Dodge patent split clutches, for electrical generating. Volume of business has been extraordinary, amounting to 80 per cent over last year, due partly to a large World's Fair order. Reports increasing favor for rope transmission for main power connections. Secured World's Fair medals on Dodge special wood-rim dynamo pulley.

HOPPES MANUFACTURING COMPANY, Springfield, O., report a change in firm, by the addition of Robert Johnson and J. A. Hayward, the latter becoming secretary. A Chicago office was recently established in the Rookery building, in charge of Wm. S. Love. Additional machinery was installed in factory; improvements made in their feed water heaters and purifiers, foreign shipments of which were made to Mexico, a very favorable and encouraging increase over preceeding year. Consider outlook for '94 good. Have just occupied a new office building, built on the cottage plan; most complete in the city.

ARTHUR S. PARTRIDGE, of St. Louis, has had a most excellent year's business in electric railway iron poles, trolley, feeder and line wires, for all of which he is agent for the strongest and most energetic manufacturers in their lines in the country. In addition to construction material, the volume of his business in repair parts, such as rawhide blanks, mica and micanite, carbon brushes, gears, pinions, steel trolley poles, etc., has increased largely in 1893, and he now has the exclusive agency in

St. Louis and the southwest for the product of the best manufacturers of electric railway supplies. Considers outlook "most favorable."

TAYLOR ELECTRIC TRUCK COMPANY, Troy, N. Y., are pleased to report their business fully up to expectations. "Trucks which we have sent on orders to many of the leading street railways in this country have been very satisfactory, and while of course there is more or less uncertainty about the out-look for the coming year, we would say that we feel encouraged to believe in a gradual resumption of business upon sounder basis than heretofore. We have put upon the market this year our empire state radial truck for double truck cars, and also a simple truck for freight and construction cars, to be used with or without brakes."

SAWYER, MANNING & COMPANY, New York, have greatly increased their sales of uniform cloths, partly through the splendid record their goods have made, and partly through the efforts of C. L. Bowler, in charge of this department of their business. While they make a full line of blues, they specially recommend their West End cadet gray cloth, which is largely used by street railways, being specially adapted for conductors and drivers, on account of its non-dirt showing, and wearing qualities. This firm are not makers of uniforms, as many suppose, but manufacturers of cloth, samples of which will be sent anywhere on request.

LEWIS & FOWLER GIRDER RAIL COMPANY, Brooklyn, brought out two new sections of rail, styled "Section L" and "Section M," to meet the demand for heavy traffic, and the usual number of new designs of special work in switches and frogs, for the manufacture of which they have large facilities. The year's business has been extremely satisfactory, being far in excess of '92, and which has required the laying out of additional assembling yards for special work. The intention now is to erect additional buildings again next spring. Sufficient orders are already in hand to keep the works busy all winter, and the prediction for next year is "most excellent."

GEORGE CUTTER, Chicago, has kept things moving in his line at a rate which has made that trade marked imp step lively to keep his toes from getting burned. A new specialty is his knife switches with a spring snap in all sizes from 25 to 1,000 amperes. Large single orders included 10 car-loads simplex feeder wire for Chicago City Railway; and simplex wire for the Ferris wheel, delivered out of stock in Chicago. Business was unusually heavy during the first six months. The Chicago factory of the Western Electric Heating Company, of which Mr. Cutter is the manager, was enlarged, and special attention will be paid to rheostats and heaters with enameled resistances.

THE RAILWAY EQUIPMENT COMPANY, Chicago, have had a busy year. Branches were established at New

York, J. L. Luding, agent; San Francisco, P. A. Roger, agent; and at Philadelphia, C. M. Corpening, agent. Facilities for manufacturing their Type G overhead material were largely increased to meet demands. New overhead switches, circuit breakers, strain insulators, and the new rail bond spring bushing were specialties of 1893. England, Germany and Canada were large buyers. Unusually large home orders went to Worcester, Indianapolis, New York and Cincinnati. Owing to the very large business early in the year, 1893 will equal 1892. Outlook most encouraging for large deals.

THE WALKER MANUFACTURING COMPANY, Cleveland, has maintained the reputation of all their varied iron products, specially large work for railways use, being the Walker-Weston friction clutches of 1,000 and 1,200-horse-power, for the Fifty-first street station, and Houston street station of the Broadway cable road, and 1,000-horse-power friction clutches for the Sixty-fifth street and Bowery stations, of the Third Avenue cable line. Also 500 and 750-horse-power clutches for the Baltimore Passenger, and Blue Island avenue power house, of the West Chicago cable road. Shipments of large orders of hydraulic machinery were sent to Glasgow, Scotland. The important plans of the Walker company, for new departures and additional departments for 1894, are mentioned elsewhere.

THE MCGUIRE MANUFACTURING COMPANY, Chicago, have no reason to complain, for the first seven months of 1893, showed a handsome increase over the entire twelve of last year. Their steel frame truck has enjoyed a continued popularity, and the eventful year was duly celebrated with the advent of the new "Columbian" truck, which has also been introduced with great success in Germany. The company also brought out a new pivotal truck, the "adjustable traction," so called, from the fact, that the construction of the truck permits the placing of the entire load upon one pair of wheels, the other being used as idlers, or guides, and when curving, sufficient of the load is transmitted automatically to the idle axle to facilitate the curving. From its exhibition at the World's Fair, numerous orders were sold to foreign manufacturers, who desired to introduce them in their respective countries, as their own make, but the McGuire people say they will be confronted with patents in Germany, France, England and Canada. The McGuire trucks received World's Fair medals, and President W. A. McGuire reports more inquiries for new business, during November, than the three preceding months combined, and predicts that next year will be a grand year for street railway business. He also reports that some of the railway companies in different parts of the country suffering from the panic, that were compelled to ask for long time in which to pay their accounts, and whose paper the McGuire company had taken, falling due well into next year, have actually anticipated payment rather than pay interest, and he considers this a hopeful indication of an improvement in business.

THE GOUBERT MANUFACTURING COMPANY, New York, whose feed-water heaters are power household words, have enjoyed a prosperous year, although, like others, the last six months fell below the early half of the year, which was phenomenal.

"SMITH, OF NEW YORK," whose lamps enlighten the street car world, has been running full time all through the year, and worked the factory nights during October and November. The increase of '93 is 30 per cent, which, under the circumstances of business depression, is a remarkable testimonial to the merit of the company's work. New styles have been a combination lamp, a new double signal lamp and a new style heater. The South American trade has been very large. Notably large orders in this country were 200 headlights and 400 signal lamps for the Brooklyn City lines; and 300 combination lamps for the Third avenue. Altogether '93 shows the largest business of any during the past ten years, and Chas. G. Smith, the manager, says indications are for a very good trade during '94.

M. C. BULLOCK MANUFACTURING COMPANY, Chicago, suffered the loss by death of its secretary, O. H. Blanke,

wants, or possible requirements, and the cheap cut-and-dry methods of the past will be relegated to the rear, and model plants, consisting of self-stoking boilers, designed for highest evaporation duty and made to carry from 150 to 200 pounds of steam, will be installed, while high speed, compound or triple-expansion engines, coupled direct to dynamos, will take place of belted engines and dynamos, thus saving from three-quarters to seven eighths of the valuable floor space required by the existing plants, which, by the way, is of vital importance in figuring on the first cost of a plant.

The carrying of high steam pressures and the use of compound or triple expansion high speed engines will also effect an enormous saving in fuel, oil and attendance.

With free trade staring him in the face, the American engineers' motto must be "economy in all things."

CLEAR THE TRACK.

THESE are the days when snow, and snow fighting devices command enough time in the mind of the superintendent, to more than make up for the neglect and humble position the plow must needs occupy when the sprinkling cart and open cars are in their glory. Our illustration is of a time tried veteran, whose construction and proportions will immediately commend themselves, and is one of the plows made by the Fleming Manufacturing Company, of Ft. Wayne, Ind. This firm has a famous reputation for snow-bucking apparatus,

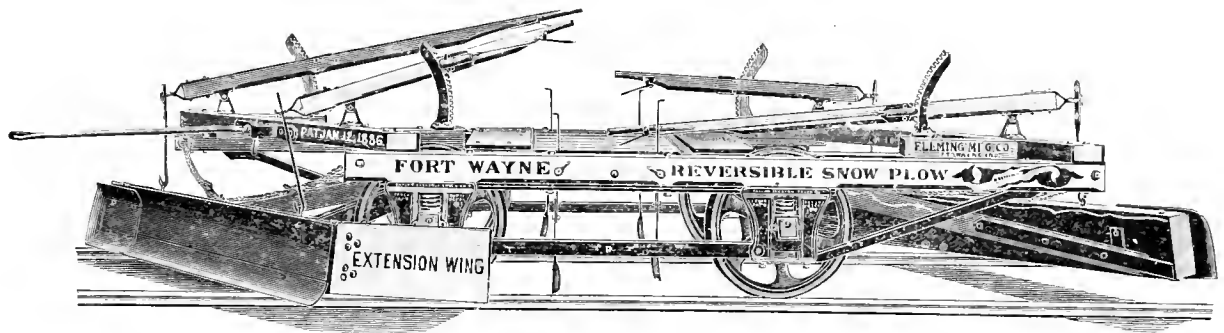

FLEMING SNOW PLOW.

a promising young business man of sterling qualities, who died in March. Increase in manufacturing facilities include a full line of drawings, patterns etc., for building the Willian's central valve engine, for which this firm took the American agency this year. While the year's business falls a little under 1890 and 1891 it is larger than '92, and in Corliss engines particularly larger than any previous year. President M. C. Bullock, whose long years of experience and observation are well known, says of the business outlook for '94—

"Not brilliant, for owing to the continued depression in financial condition of the country, capitalists are scrutinizing all investments with great care, and nothing but "gilt edged" schemes can be floated; consequently there will be less projecting and building of new lines of roads and less additions and extensions of plants than there has been for several years.

This may result in a lasting benefit to the general public, for only roads which have able management and ready capital will be built or extended, and all the best managed roads are now making a special study of how to obtain, first, highest efficiency, and second, how to reduce operating expenses. This will result in the discarding, in the near future, of many experimental plants, which were erected as "make shifts" and fitted out with cheap engines and boilers, which were generally "steam-eaters" instead of being "steam-users".

Now that the experimental stage has passed, competent constructing engineers will be employed to examine present conditions and future

which includes the "walk-away," which cleans a good sized street in about two trips. The "Reversible," illustrated, can be drawn by either electric, cable or horse, and the one shown is mounted on a Taylor truck. The Fleming Manufacturing Company have sold plows in all parts of the north, a large number having been in use on the Chicago lines for several years.

THAT OLD CASE.

IN an appeal taken before Judge Wickham in regard to Sunday work, under the blue law of 1794, was decided November 26, upholding the law. The case was that of Glenn Wallace, et al, vs. the Commonwealth of Pennsylvania. The conductors of the street cars on College Hill were prosecuted for violation of the Sunday law of 1794. The cases were first heard before Justice White, of College Hill, who decided for the prosecution. The decision of the appellate judge was against the conductors and the company, but it is quite unlikely any radical enforcement of a dead law will be attempted.

ECHOES FROM THE TRADE.

THE RELIABLE Manufacturing Company, of Boston, reports good trade in electric heaters, and have orders enough to keep its full capacity running until new years.

THE BEMIS CAR BOX COMPANY reports an order from the Laclede Car Company, for 50 Standard motor trucks, (making 300), for cars for the Philadelphia Traction Company.

D. W. DAVIS, of Dick, Church & Company, 519 Rookery, has resigned The Phoenix. Chicago business is now conducted by J. W. Koch, who has been connected with the business for the past six years.

THE Storelectro car at Cleveland, Ohio, is said to have run a distance of 2,100 miles, and to have carried 7,000 passengers. G. A. Ford, of the company, says that two more cars will be put into commission shortly.

WILLIAM SHARPE, formerly the Company of W. E. Reid & Company, western representatives of the J. H. McEwen Company, of Ridgeway, Pa., has succeeded to the entire business of the western office, of which he will hereafter be manager.

THE WM. C. BAKER street car heater, New York, is having a large and increasing sale to roads in all parts of the country. Among recent purchasers are the Cedar Rapids and Marion, the Johnstown street railway and the Norwalk street railway.

THE Root improved water tube boiler's good reputation is constantly growing. The boiler is a very popular one and the manufacturer, the Abendroth & Root Manufacturing Company, 28 Cliff Street, New York City, enjoys a large and steadily increasing business.

THE WESTINGHOUSE ELECTRIC & MANUFACTURING COMPANY, has established a district office at Portland, Oregon, which will have charge of the development of their interests in Oregon, Washington and British Columbia. R. L. Warner, recently connected with the engineering corps of the company, in charge.

THE 500-horse-power cross compound condensing engine, exhibited by the Ball Engine Company, Erie, Pa., at the late World's Fair, has been sold by them to the Maryland Lighting Company, Baltimore, Md. This engine received the highest award. The particular work of the engine at the Fair was the illumination of the electrical fountains.

F. H. LINCOLN has sold orders of his tower wagon, made by the Milburn Wagon Company, of Akron, O., to the following roads: Austin, Tex., Rapid Transit Company; four to the Philadelphia Traction Company; New Haven & Fair Haven Company; Madison, Wis. Street Railway Company; Watertown, N. Y. Street Railway Company, and others. They are highly appreciated.

THE J. W. FOWLER CAR COMPANY, of New York has sold through sales agents George Whipp, snow sweepers such as we illustrate this month, to the following roads: eight to the Atlantic Avenue of Brooklyn, two to the Brooklyn & Newtown, two to the Baltimore Traction Company, one to Hartford's Horse Railway and two to the New Market & South Orange Street Railway Company.

THE CONSOLIDATED CAR HEATING COMPANY, of Albany, N. Y., was organized in 1889. It reports that their sales have just passed the million dollar mark. The total at the close of business, November 4, being \$1,003,598,89. The figures show perhaps more clearly than any other statement, the progress which the company has made and the high esteem in which its appliances are held by railroads throughout the United States and Canada.

THE business of the Railway Equipment Company, Pullman building, Chicago, has largely increased during the past few months. At this season of the year large orders are being filled for the Brand's Patent Track Brooms; the new rail bond spring bushing is also being adopted by a great many roads. Other agencies, such as the Garton lighting arrester, the A. Mertes gears and pinions, and Holmes Booth & Hayden K K and magnet wire, add largely to the business of the company. Railway men seem to appreciate an exclusive railway supply business.

THE ALLEN ELECTRIC & SUPPLY COMPANY, No. 232 Carter Street, Philadelphia, Pa., will handle the Graham trucks for the states lying between the Hudson river on the east and the Mississippi river on the west. The increased orders taken for the truck recently, and the great number of enquiries in the middle states, made it necessary to have a competent agency in this territory. The truck will be made in Philadelphia, complete, and prospective customers will thus have the advantage of home consumption, and save besides the item of freight. The Allen people will have a complete truck at their office, No. 232 Carter Street. The Allen concern are very enthusiastic over the possibilities of the truck, and they say that all they have to do to make a sale is to have a customer ride on their truck and then compare it to other non-oscillating patents.

C. E. LONG, the superintendent of the York, Pa., Street Railway Company, gave all the York "boys" a winter cap. A warm, serviceable and appreciated present.

THE Lehigh Valley Railroad has settled all its labor difficulties and is running, as smoothly as usual, the most elegant and comfortable of passenger trains between New York City and Buffalo, with direct connections to all points both East and West.

DAY'S SPRINKLER.

THE advantage of street sprinkling for cable and electric railways has been previously noted by the REVIEW. Several devices are now in the market looking towards the economical method of its accomplishment.

One of these is the sprinkler invented and manufactured by Josiah F. Day, of 63 Murray street, New York City.

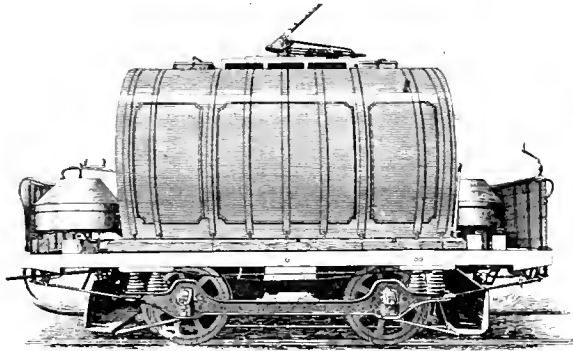

SIDE VIEW OF SPRINKLER.

The famous Miller-Knoblock Wagon Company's downward spray sprinkler device is used in connection with this sprinkler, and is said to be remarkably effective, as regards power, close relation and economy.

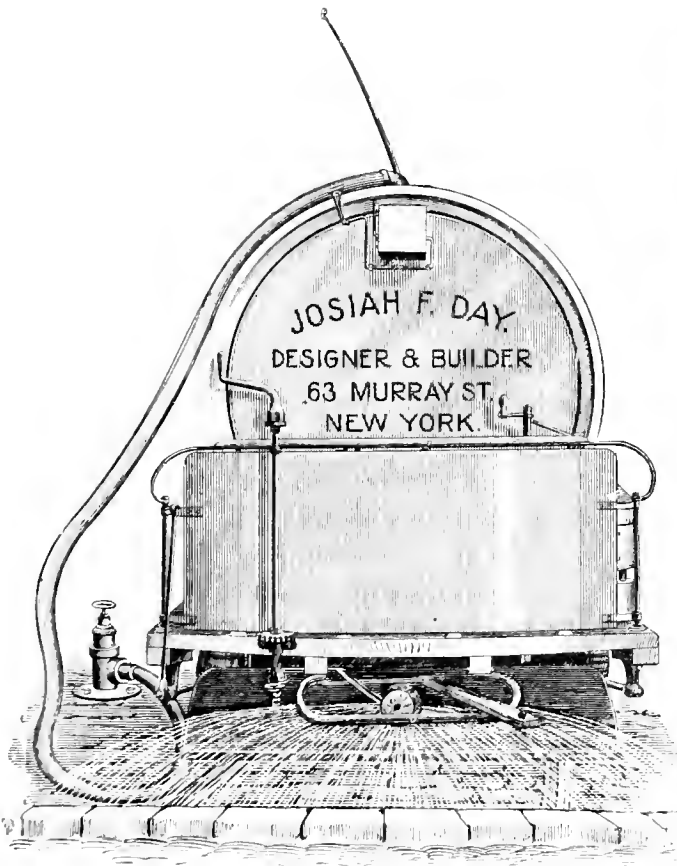

END VIEW OF SPRINKLER.

Our illustrations show plainly the general appearance of the Day sprinkler. It holds from 2,000 to 2,500 gallons of water and spreads the spray from 8 to 25 feet. Its

principal claims for excellence are: ease of regulation, spreading the same amount of water at fifteen miles an hour as at four miles. When spreading 8 to 9 feet the tank will be 50 to 60 minutes in emptying, laying the dust completely. The spray is regulated while the car is in motion, throwing the quantity of water needed when running fast or slow. It can also be used for street railway sprinkling in crowded streets. The manufacturer will furnish the car complete, or simply tanks and fixtures, as desired by the purchaser, and any information will be furnished on application.



HIDE AND SEEK—AN ECHO OF THE FAIR.

The conductor was a small man. He knew it. She was a large, powerful woman and she was ignorant of the fact.

"I want you to put me off at Jumpoph street," she said.

He viewed the majestic figure a moment and replied with emphasis as noted.

"Madam, I will stop the car and let you get off."

And the man on the back platform smiled.

NEW YORK has had to learn rapid transit. Not long ago a middle-aged man, born and bred in New York, jumped from an up-bound car and rushed carelessly across the track, escaping a down car by the skin of his teeth. Saved by mere chance he came to himself, on the sidewalk, and said: "Of all—fools, I am chief." And he was just as near right as he could be, except that there are lots of others.

CUTTER'S MOTOR SWITCH.

SO many of our electric railways are now supplying current to motors from their 500 volt circuits, that there has been a growing demand for single pole knife switches suitable for this special work. Most of the motors being comparatively small, say of ten or fifteen horse-power at the most, a twenty-five ampere switch is ample for the purpose, but it must be able to both carry and break this current without heating or arc-

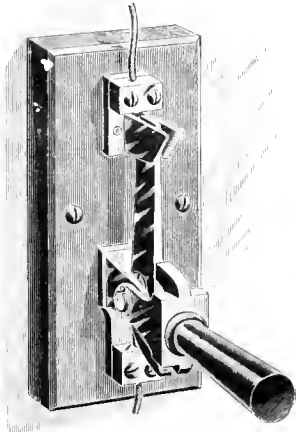

ing at the contacts. These points seem to be met by the new motor switch just put on the market by George Cutter, of Chicago, which is the outcome of a series of incandescent switches which he has been perfecting. As the cut shows, this is of the same type as the 220-volt switches, but has a longer and wider break, so as to instantly rupture the spark at the contacts. The spring connecting the yoke with the blade insures a quick snap motion, and the contacts are all of ample size.

MAMMY'S ADVICE.

When de trolley car comes hummin'
Yoh, hyah me, chile; Looke out!
Er Santy Claus 'll hafter change
His Christmas callin' route.—Washington Star.

A SMART boy at Muncie, Indiana, made a toy motor car to run in his papa's store-window. One day the car jumped the track and the spark set fire to goods in the window, making a fine blaze, and creating a wish in his father's breast that his son was not quite so much of a genius.

A TRAVELING HOSPITAL.



WILLIAM ANN (on Broadway)—“That is what is commonly called a grip-car.”

UNCLE TREETOP—“And air all them people inside a-suffering with it?”—Milwaukee News.

F. M. ZIMMERMAN, superintendent of the electrical plant of the Detroit Citizens' Railway has been presented with a silver tea set.

THE motorman on the ill fated Portland car that went through the bridge into the Madison street draw has been indicted for man-slaughter by the grand jury. The first suit for damages of this accident is from C. F. Albee and the demand is for \$10,000 for the death of the Albee boy, aged 14.

THERE are sixty-four governments in the world granting patents: to secure a patent in them all would cost \$14,500.

THE SUNRISE CLUB, composed of gentlemen connected with the Ansonia Electric Comyany, this city, recently gave a complimentary dinner at the Union League Club, in honor of F. S. Terry. Toastmaster was Col. George Carter.

CLIFT WISE, the well known engineer, has opened a pleasant office at 1401 Monadnock building, Chicago, as western representative of the Complete Electric Construction Company, of New York City. A specialty is made of railway contracting and Mr Wise's many friends welcome his return to Chicago.



A FEW FEATURES OF A CHICAGO STREET CAR.

PICTORIAL EVENTS OF THE MONTH.

THE first snow storm of the season was a November surprise, and the isothermal line running through Chicago was a Thanksgiving treat to the small boy and the livery stable man and a cold wet blanket on the hopes of the street railway superintendent. Up through St. Paul and Minneapolis, and down east near the sea shore and mountains snow was an earlier comer.

The electric snow plow and sweepers and the greater prevalence of mechanical traction this winter, has lessened the perils of snow storms considerably. The horses, however, to use a British phrase, are "distressed."

Everywhere that the storm was taken in time there was very little difficulty in keeping the lines open, but when two or three inches of sticky, wet snow had already made its bed on the track trouble was experienced.

Our artist has caught the effect of Mr. Suburban trying to get down town on a horse line on November 30.

NUMBER 2 is the To-So Coolie Railway Company of Yien Ste-Stain, China, which is capitalized at two billion cash. On this line the cars will be drawn by coolies who previously have carried sedan chairs. Each car will accommodate four passengers, and the rate of fare will be 10 cash (about 1 cent) a mile. The projector is a Chinese real estate man, who wishes to sell town lots in Manderin, a suburban town. The franchise is already acquired.

NEWARK, N. J., Contocksin, Pa., and Boston, Mass., have amazonian protectors of the private right to make a fuss. At these three places the street railway company had found it necessary to plant poles whereon to suspend wires that the hum of the trolley might be heard in the land. Now, in order not to attract too marked attention from inquisitive people, who perhaps might think that the whole street belonged to the man fortunate enough to own an abutting town lot, the wary pole planters seized upon the evening time wherein to plant. But the female

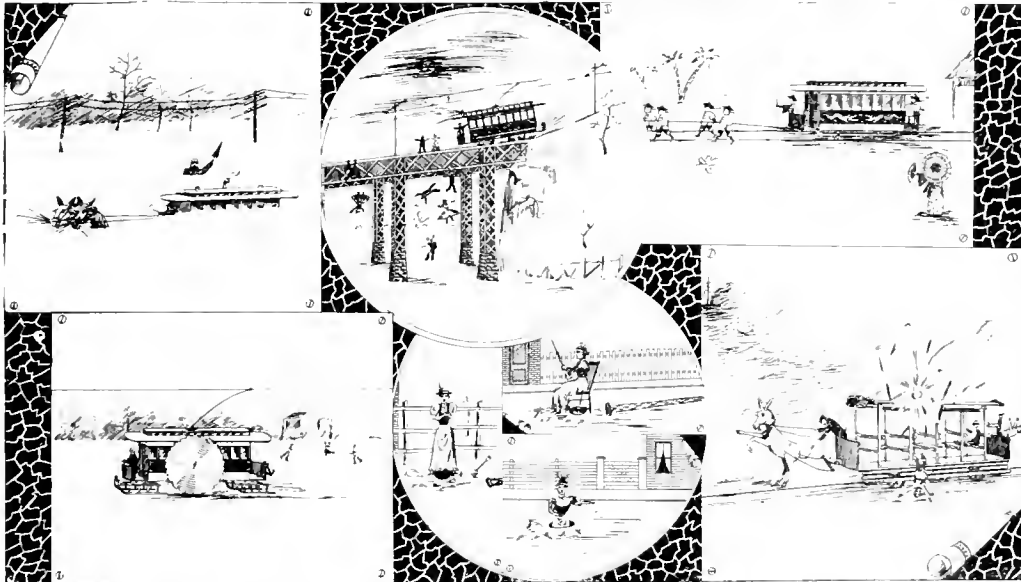

Two magnificent monumental and artistic figments of the imagination have become current in Europe and will soon be repeated by our brethren of the lay press of this country.

NUMBER 1 relates to the project of the Campagnie Findlandaise des Bateaux Mouches for a railway on the ice, on the river Neva, Russia. The line will be electric, on the trolley system, but instead of wheels the cars will travel on runners and be actuated by a wheel furnished with sharp points to stick in the ice. The cars, or sleds, will be very light, carry but few people and run at a high rate of speed. Multiphase transmission from a long distance with the aid of transformers will be used. It is expected that a large pleasure-seeking population will patronize the novelty, and concessions for the sale of "red hots," "whale blubber," train oil and other Northern delicacies are now being sold.

element here interposed, and in one case while pa went for an injunction, ma took the shot-gun and guarded the property rights; in another, the lady planted herself in the hole prepared and there stuck until succor came; in the third instance, the disposition of the guard over the place and the menacing look on her face, short circuited any attempts on the part of the construction party, and the party of the first part was conqueror.

EAST LIVERPOOL, OHIO, was the scene of a frightful accident, November 30. A party of 13 were coming home from Thanksgiving festivities, using the street railway track and trestle one mile east of town as a thoroughfare. A car coming down grade on the frosty track was unable to be controlled in spite of the efforts of the motor man, and dashed into the party. Three of the thirteen were fatally injured and several others hurt. The trestle was 25 feet high at the scene of the accident.

DURING the late unpleasantness down in Brazil, the insurgent vessels found it expedient to bombard the town of Rio. Among the incidents attending this diversion was the explosion of a bombshell over an innocent, peaceful and non-partisan street car of the bob tailed variety. The expression of surprise on the mule's countenance can be replaced only by the advent of electricity.

THERE was once a car in Philadelphia upon which age was beginning to tell. But it was a horse car, and even the barn foreman didn't think it worth while to trouble himself about it. Hence we have this story to relate: The car was of the bob-tail variety and the horse

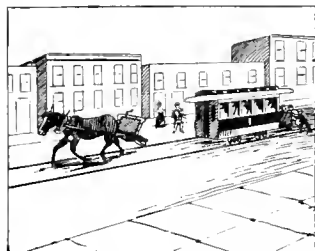

was jogging comfortably along while the driver was collecting fares. Suddenly the car began to slow down, then it stopped, and the driver was just ready to relieve his mind by a little

profanity when he saw the horse jogging along some hundred feet ahead with the dashboard and tackle dragging at his heels. It made an awful clatter, and the speed at which that usually apathetic nag went down the street was, to use Geo. Francis Train's words, a "mild surprise." The passengers got off and pushed, to the great amusement of the spectators who walked.

For some reason or other the Milwaukee avenue line of the West Chicago Street Railroad Company had more than its share of traffic the other day. With customary enterprise and firm resolve to get the first car, Chicago's numerous residents on that thoroughfare arranged themselves on the first cars until they looked like bee-hives. Having practice during the Fair, a number climbed on the roof, expecting to escape paying fare. But Mr. Parsons' ready-witted conductors were prepared for that trick, and as the car approached a barn a ladder was secured and the conductor's roof fares were all safely garnered.



KANSAS CITY'S L and the West Side Company have decided to erect a handsome depot for the accommodation of its patrons. The depot will be two stories high. "It will be built immediately," says Superintendent Clark.

A CINCINNATI horse nearly wrecked an electric car not long ago by getting its bit tangled up in the trolley cord and pulling off the trolley from the wire. The car was at a stand still on an up grade, so that when the brakes were loosened the car ran rapidly backwards until the brake could be again applied.

GERMAN IRON POLES.

THE accompanying engravings show samples of iron electric railway poles, as built by W. Fitzner, of Laurahutte, Germany, and which many of our readers will recall as exhibited in the mining building at the World's Fair. These taper welded tubular poles are

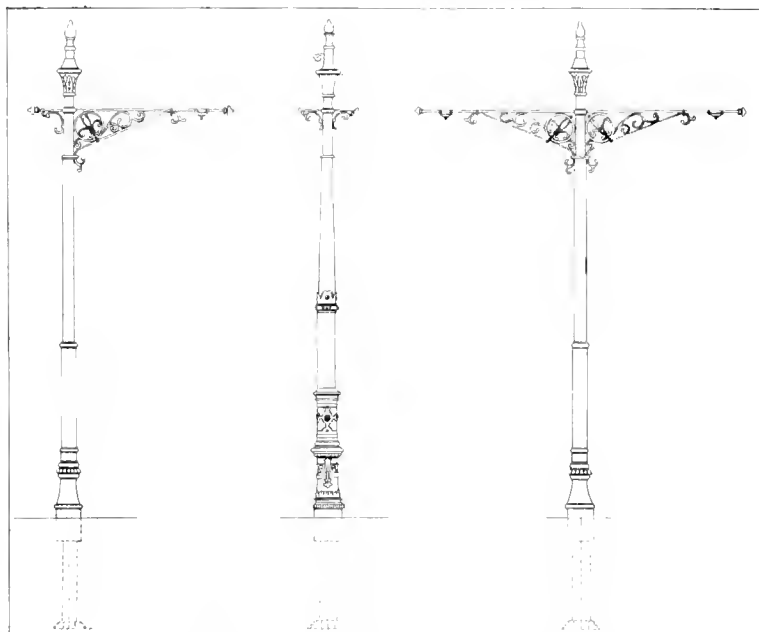

not only highly ornamental but very strong and light. They are made in all the common lengths. Large numbers are in use on German railways.

E. F. DEWITT, of Lansingburg, N. Y., personally superintended the work of placing his sand boxes on the cars of the Broadway line, New York, where they were adopted after a most thorough and exacting test, which sustained all the claims of excellence made by the manufacturer.

THE war department has announced that your Uncle Sam has no objections to the Metropolitan L bridge across the river at Van Buren street, Chicago.

THE Globe Street Railway Company, of Fall River, Mass., divided \$420 among the fourteen most efficient employes. Several special prizes for bravery and care were given.

OIL CITY, PA., celebrated the opening of its street railway system on Thanksgiving day. Superintendent C. W. Atmore, President J. B. Smithson and a distinguished party made the first trip.

It is said that J. W. Goss and Engineer Riblet, of Spokane, Wash., are promoters of a Japanese electric railway, at least the gentlemen are in Japan and both have railway men. It is said that Rev. V. M. Law, a medical missionary of Tokio, has secured a franchise. The travelers will return about January 1.

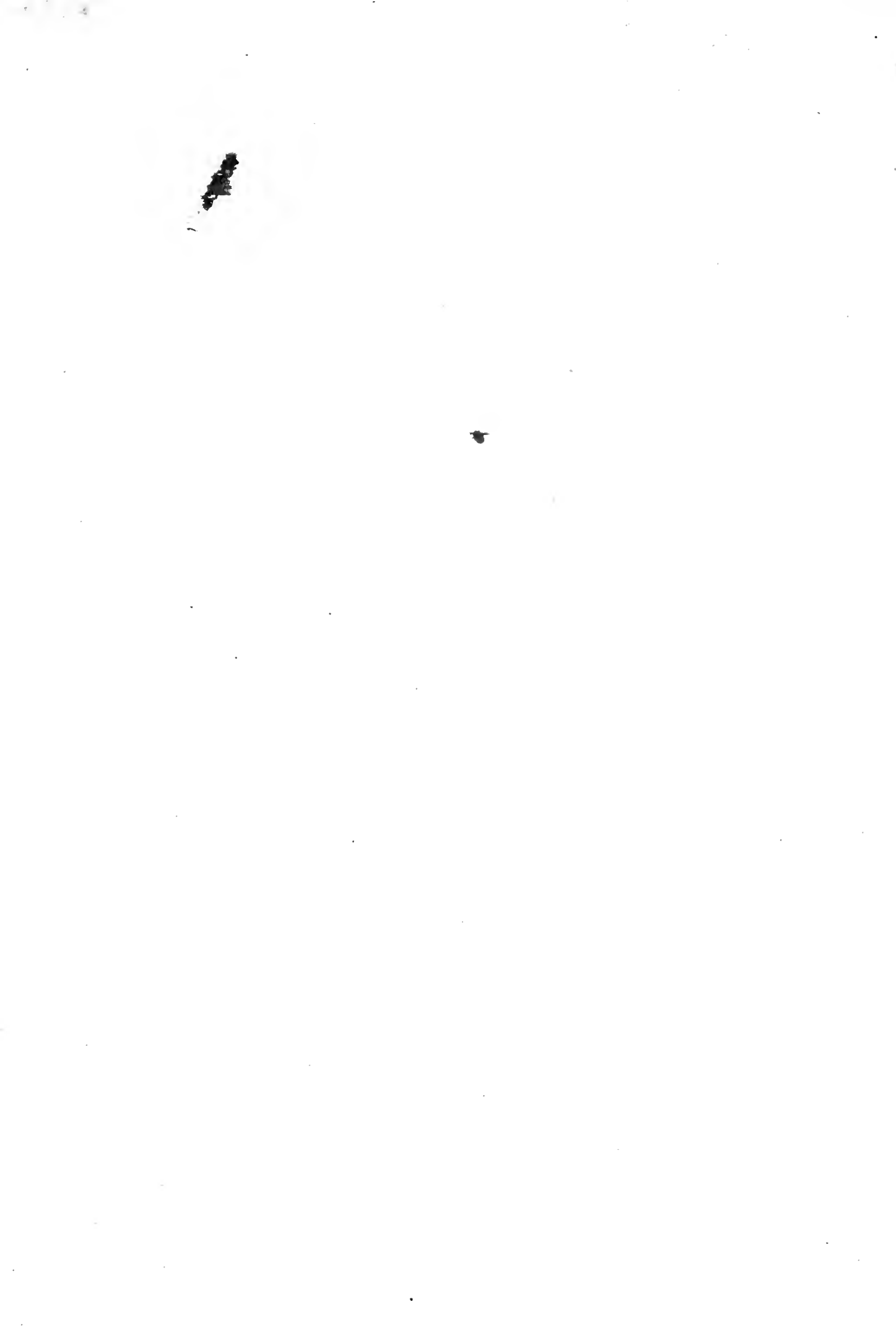

CARNEGIE LIBRARY OF PITTSBURGH
3 1812 04298 4717