

A Synopsis of the
**GENERAL MORPHOLOGY
OF ANIMALS**

BY EDWIN GRANT CONKLIN

MBL/WHOI



0 0301 0018675 5

GENERAL MORPHOLOGY OF ANIMALS

77
C. 2

A Synopsis of the
**GENERAL MORPHOLOGY
OF ANIMALS**

By EDWIN GRANT CONKLIN
Professor of Biology in Princeton University

PRINCETON
PRINCETON UNIVERSITY PRESS

1927



COPYRIGHT, 1927, BY PRINCETON UNIVERSITY PRESS

PRINTED AT THE PRINCETON UNIVERSITY PRESS
PRINCETON, NEW JERSEY, U.S.A.

CONTENTS

	PAGE
A. TAXONOMY	1
I. DISTINCTIVE CHARACTERS OF ANIMALS AND PLANTS	
II. SUBDIVISIONS OF ANIMALS AND PLANTS.....	2
1. Protophyta and Protozoa	
2. Metaphyta and Metazoa	
3. Transitions from Unicellular to Multicellular Forms	
4. Chief Subdivisions of the Plant Kingdom.....	3
5. Chief Subdivisions of the Animal Kingdom	
6. Binomial Nomenclature	
B. PRINCIPLES OF MORPHOLOGY.....	4
I. DIFFERENTIATION AND INTEGRATION	
1. Grades of Organization	
2. Methods of Differentiation.....	5
3. Structure and Function	
II. INDIVIDUALITY	6
1. Definition	
2. Grades of Individuality	
(a) Ultra-microscopic units	
(b) Visible cell structures	
(c) Cells	
(d) Tissues	7
(e) Organs	
(f) Systems	
(g) Antimeres	
Metameris	8
(h) Persons	
(i) Corms	
(j) Societies	

CONTENTS

	PAGE
III. HOMOLOGY AND ANALOGY	
1. General or Meristic Homology.....	9
(a) Bilateral Homology (Homotypy)	
(b) Serial Homology (Homodynamy)	
2. Special Homology (Homogeny, Homophyly)	
3. Homoplasy (False Homology or "Convergence")	
4. Causes of Homology	
(a) The Cause of General Homology.....	10
(b) The Cause of Special Homology	
IV. ORGANIC SYMMETRY.....	11
C. MORPHOLOGY OF METAZOA	12
I. STAGES OF METAZOAN DEVELOPMENT	
1. The Fertilized Egg.....	14
2. The Cleavage Stages	
3. The Blastula	
4. The Gastrula	
II. MODIFICATIONS AND COMPLICATIONS OF THE GASTRULA	15
1. Axes and Symmetry	
(a) Protaxonia	
(b) Heteraxonia	16
2. Mesoderm and Body Cavities	19
3. Metamerism	20
III. ORGAN SYSTEMS	23
1. Integumentary System	
(a) Epidermis	
(b) Dermis	25
2. Skeletal System	
3. Motor System	28
(a) Amoeboid movement	
(b) Ciliary Movement	30
(c) Muscular Movement	32

CONTENTS

	PAGE
4. Alimentary System.....	34
Digestion	
Intracellular Digestion	35
Extracellular Digestion	
Openings into Digestive Cavity	
Fore, Mid, and Hind-Guts	37
Digestive Cells and Glands	40
Movements of Food in Alimentary Canal	
5. Respiratory System	
Branchiae, Gills	41
Tracheae, Lungs	44
6. Circulatory System	47
Blood-Vascular System	
Circulation and Respiration	49
7. Excretory System	54
Nephridia	
Proto-nephridia	55
Meta-nephridia	
Kidneys of Chordata; Pronephros	57
Mesonephros	58
Metanephros	59
Theories of Excretion	61
Excretory Ducts as Sex Ducts	
8. Reproductive System	62
Sexual Reproduction; Sexes	
Ovaries and Testes	63
Gonads of Vertebrates	64
Semination	65
Secondary Sexual Characters	
Asexual Reproduction, or Monogony	66
9. Nervous System	
(1) Diffuse nervous system	69
(2) Linear nervous system	
(3) The ganglionic type	70

CONTENTS

	PAGE
(4) The tubular type of nervous system.....	71
10. Sense Organs	72
(1) Organs of smell and taste	74
(2) Organs of hearing and equilibration.....	76
Statocysts	
Arthropod Statocysts and Ears.....	78
Lateral Line Organs of Vertebrates	79
The vertebrate ear	
(3) Visual Organs	81
Vesicular Eyes	
The paired eyes of Vertebrates	83
The compound eyes of Arthropods.....	85

TABLE OF CLASSIFICATION AND MORPHOLOGY OF ANIMALS

INTRODUCTION

THE following pages give a brief synopsis of that part of the course in General Biology in Princeton University which deals with the General Morphology of Animals; other parts of that course are General Physiology, Ecology and Biogeny (Genetics and Evolution). The General Morphology is printed in this form because of the difficulty of finding elsewhere any such brief summary and because of the repeated requests of students for such a syllabus. In general the whole subject of animal morphology is here dealt with from the genetical (embryological and evolutionary) point of view because it is easier to understand complicated structures when they are seen in the process of becoming and also because by this method fundamental resemblances or homologies are more readily appreciated. In so brief a statement covering so wide a field only bare outlines can be given; very much has been omitted and many statements which should have been qualified have been given baldly, but it has seemed best in an elementary course to present only the leading principles, processes and structures of animal morphology without confusing the beginner with a multitude of details or with many qualifications or exceptions. It is expected, of course, that students will use this synopsis only in connection with lectures, laboratory work, and assigned readings.

GENERAL MORPHOLOGY

GENERAL Morphology deals with the forms and structures of living things and is studied by methods of observation, comparison, development, and experiment. By observing and comparing the resemblances and differences among organisms they are classified into groups that are more or less alike; such classification is known as *Taxonomy*. By methods of comparison, development and experiment, the factors or causes which determine resemblances and differences in structure are studied, such studies being known as *Comparative* or *Experimental Anatomy* or *Embryology*.

A. TAXONOMY (= CLASSIFICATION)

All organisms are classified according to their structure into two kingdoms, plants and animals, a few main branches of each kingdom, and many minor subdivisions. Animals and plants are alike in the more fundamental features of (1) Protoplasmic and Cellular organization, (2) Metabolism, (3) Reproduction, (4) Irritability.

I. DISTINCTIVE CHARACTERS OF ANIMALS AND PLANTS

<i>Animals</i> generally have:	<i>Plants</i> generally have:
1. No cellulose cell-walls	1. Cellulose cell-walls
2. Holozoic nutrition	2. Holophytic nutrition
3. Excretory organ	(in green plants only)
4. Movements relatively free	3. No excretory organ
	4. Relatively little movement

MORPHOLOGY OF ANIMALS

However, there may be exceptions to each of these criteria and then the decision as to whether the organism is a plant or animal may be difficult if not impossible to make.

II. SUBDIVISIONS OF ANIMALS AND PLANTS

Both animals and plants are subdivided into one-celled and many-celled forms and each of these is further subdivided as is shown in the tables, pages 11, 12, 13 of the Laboratory Directions, and at the end of this Synopsis.

1. *Protophyta* are one-celled plants, and *Protozoa* are one-celled animals in which the entire body consists of a single cell, which may be independent, or may be joined with others like itself to form a colony of similar cells.
2. *Metaphyta* are many-celled plants and *Metazoa* are many-celled animals in which the body consists of many cells which differ more or less from one another.
3. *Transitions from Unicellular to Multicellular forms.* In plants there is a complete series of intermediate forms from the single cell to the solid aggregate of cells as follows:
 - (a) Single cell (e.g. Spherella),
 - (b) Linear aggregate of cells (e.g. Spirogyra),
 - (c) Superficial aggregate of cells (e.g. Ulva),
 - (d) Solid aggregate of cells (e.g. mushrooms and all higher plants).

Among animals a great gap exists between Protozoa and Metazoa, there being no animals living today that are intermediate between the two. However, all Metazoa, in their development from the egg, pass from a unicellular to a multicellular condition through the *cleavage stages*, the *blastula* and the *gastrula* (FIG. 1).

MORPHOLOGY OF ANIMALS

4. *Chief subdivisions of the Plant Kingdom* are into two Subkingdoms, 4 Divisions, at least 6 Subdivisions, about 50 classes, 130 orders, several thousand genera, and nearly half a million species (see Laboratory Directions p. 11). The "Subdivisions" of plants correspond more or less to the "Phyla" of animals, while the Classes, Genera, and Species in the two kingdoms are of approximately coordinate value.
5. *Chief Subdivisions of the Animal Kingdom.* The main subdivisions of the animal kingdom are called Phyla; these differ in adult structure so widely that it is difficult or impossible to find connecting links between them. These phyla are subdivided into Subphyla, Classes, Orders, Families, Genera, Species. At present we recognize 14 phyla of animals, 50 classes, about 200 orders, about 50,000 genera, more than half a million species. The phyla, orders and classes of the animal kingdom are shown in the table, pages 12 and 13, of the Laboratory Directions and in the tabular classification at the end of this publication.
6. *Binomial Nomenclature.* The entire classification of any plant or animal involves its assignment to its proper Phylum, Class, Order, Family, Genus, and Species, but its scientific name consists merely of the Latin name of the genus and species to which it belongs (e.g. *Euglena viridis*, *Amoeba proteus*). This method of naming animals and plants was instituted by Linnaeus (1707-1778) and is known as binomial nomenclature.

In the following pages continual reference is made to the different phyla, classes, and genera of animals and *it is*

MORPHOLOGY OF ANIMALS

absolutely necessary that the student should know the location in the table of classification at the end of this Synopsis of every group mentioned in the text, that he should see actual specimens of each of them in the museum or laboratory, and that he should study carefully the figures in the text and their descriptions if he is to get any proper understanding of the morphology of animals.

B. PRINCIPLES OF MORPHOLOGY

In comparing the structures of different organisms (Comparative Morphology) there are a few principles applicable to all plants and animals.

I. DIFFERENTIATION AND INTEGRATION

Organizations means differentiation and integration; every living thing, even the simplest, is composed of different parts (differentiation) which parts are united into a single whole (integration). Many lifeless things are organized, that is, they are composed of different parts that are united into a single whole,—as, for example, the solar system, a chemical molecule, a watch or any other machine. But living things are so highly and so peculiarly organized that they are called “organisms.” It is protoplasmic and cellular organization that is distinctive of living things.

First among the principles of comparative morphology is the fact that many organisms differ in the degree and number of their differentiations; those in which there are relatively few differentiations are commonly called “lower,” those with many differentiations “higher” organisms.

1. *Grades of organization* from the relatively simple to the relatively complex, or from the low to the high, are found

MORPHOLOGY OF ANIMALS

(a) in plants and animals now living on the earth, (b) in the history of organisms through past geological eras, (c) in the development of animals and plants from egg cells to their adult condition.

2. *Methods of Differentiation.* The method by which increasing differentiation is brought about is best seen in the process of individual development. Here the single egg cell divides into many cells which come to differ from one another in both structure and function. (a) In this process there is a distribution of different structures to different cells and a concomitant distribution of functions among these cells; that is, there is "morphological division of substance" and "physiological division of labor." (b) But increasing differentiation does not consist merely, nor chiefly, in the division of structures and functions already present and their segregation into separate cells, but also in the appearance of new structures and functions in the later stages that were not present in the earlier ones. These new structures and functions were not created *ex nihilo*, but have come from new combinations of factors already present, that is from transformation of old structures and functions rather than from new formation. These new differentiations of development are, therefore, the results of "creative synthesis," just as water with its many peculiar properties is the result of the chemical synthesis of two atoms of hydrogen and one of oxygen.
3. *Structure and function* are not separate or independent entities, they are merely two aspects of one thing, namely, organization. From the morphological point of view a living thing is a system of structures, from the physio-

MORPHOLOGY OF ANIMALS

logical, a system of functions, but these never exist separately. Changes in function inevitably involve changes in structure and *vice versa*, but neither is the cause of the other, any more than one side of a coin is the cause of the other side. Morphology and physiology are merely two aspects of one thing, namely life.

II. INDIVIDUALITY

All living things from the simplest to the most complex are distinct but not wholly independent individuals.

1. *Definition*. An organic individual may be defined as any unit capable of maintaining and of reproducing itself, or in other words, capable of assimilation and reproduction.
2. *Grades of Individuality*. The degree of differentiation of any organism is directly proportional to the number of unlike units that constitute it and to the degree of their unlikeness. The following grades of organic individuals, from the smallest and simplest to the largest and most complex, are recognized:

(a) *Ultra-microscopic units*, such as inheritance factors, genes, etc. These invisible, but real units, have the power of assimilation, growth, and division.

(b) *Visible cell structures*, such as chromomeres, chromosomes, plastosomes, chromatophores, etc. These units also assimilate, grow and divide; in both the ultra-microscopic units (a) and these microscopically visible ones (b) division is always into like portions, that is, it is non-differential.

(c) *Cells* are more complex units composed of the preceding simpler ones (a and b), each consisting of cytoplasm

MORPHOLOGY OF ANIMALS

and nucleus. They may exist independently as "free cells," or they may be united with other cells, when they are called "fixed cells." They are the smallest units capable of independent existence, *the ultimate independent units of organic structure and function*. Every cell reproduces by division. The division of the nucleus is typically into equal halves, but that of the cytoplasm may be equal or unequal,—that is the nuclear division is non-differential, but the division of the cytoplasm may be either differential or non-differential.

(*d*) *Tissues* are groups of similar cells together with their products (secretions, etc.). In animals there are two fundamental types of tissues which give rise to all others; these are *epithelia* which are composed of cells closely united side by side to form layers, and *mesenchyme* which consists of cells loosely connected by processes into a more or less spongy mass. In the animal embryo epithelial tissue usually gives rise to the covering and lining layers of the body and the glands, also much of the muscular, nervous and germinal tissues; while mesenchyme produces chiefly connective, skeletal, vascular and fatty tissues.

(*e*) *Organs* are groups of different tissues, each performing specific functions. Thus the heart is an organ composed chiefly of muscular and connective tissues having the specific function of pumping blood.

(*f*) *Systems* are groups of organs, each performing some general function, such as the heart and vascular system for the circulation of blood, the nervous system for the reception, transmission and coordination of stimuli, etc.

(*g*) *Antimeres* (homo-typical parts) are bilaterally or

MORPHOLOGY OF ANIMALS

radially symmetrical portions of the body, such as the right and left arms and legs, each composed of several systems and organs.

Metameres (homo-dynamic parts) are serially symmetrical portions of the body, such as the successive somites (segments) of the body of an earthworm or lobster, each composed of many systems and organs. When the somites are all alike they are said to be *homonomous*, when they differ one from another they are *heteronomous*.

(*h*) *Persons* are separate, distinct individuals, composed of many or all of the preceding units, such as an earthworm, a frog, or a man.

(*i*) *Corms* are groups of persons morphologically united, such as a colony of sponges, hyroids, polyzoa, or ascidians.

(*j*) *Societies* are groups of individuals physiologically united, such as a colony of ants, bees, or men.

III. HOMOLOGY AND ANALOGY

The general functions of living things, such as metabolism, reproduction, sensitivity, are found in all plants and animals, but the various organs and systems by which these functions are performed differ widely in different phyla.

Analogy is similarity in function but not in structure. Thus the wings of insects and birds are analogous, though differing widely in structure.

Homology is resemblance in structure and position, though the function may or may not be similar. Thus the wing of a bird, the fore-leg of a horse, and the arm of a man are homologous, because they show fundamental resemblances in position and structure, although they differ in function.

MORPHOLOGY OF ANIMALS

Homology may exist between similar parts of the same organism, or between similar parts of different organisms; the former is called General Homology, the latter Special Homology.

1. *General or Meristic Homology* is similarity between parts which are duplicated or repeated in the same body, such as arms, legs, fingers, teeth, etc. These repetitions may be bilateral or serial in position, and accordingly we recognize
(a) *Bilateral Homology (Homotypy)* such as the resemblance between the right arm and the left, etc.
(b) *Serial Homology (Homodynamy)* such as the resemblances between arms and legs, the series of fingers, teeth, etc.
2. *Special Homology (Homogeny, Homophyly)* is similarity between corresponding parts of different organisms, such as the fore-limbs of all vertebrates, the eyes of all insects, etc.
3. *Homoplasny (False Homology or "Convergence")* is apparent resemblance but fundamental difference between parts of different organisms, as for example the eyes of vertebrates and cephalopods. Such superficial resemblance may be attributed to the influence of similar environments and needs upon fundamentally different hereditary types; that is, starting from different types these structures have "converged" toward superficially similar ones.
4. *Causes of Homology.* There is only one scientific explanation of the cause of all real homology, whether general or special, and that is similarity of source or origin, or common inheritance from the same ancestors, just as the fundamental resemblances of all Africans, or of other

MORPHOLOGY OF ANIMALS

human races, are due to inheritance from common ancestors.

(a) *The Cause of General Homology.* General homology is the result of common origin from the same substance or primordium in the egg or embryo. The different fingers on one hand come from a single hand-pad in the embryo which partially divides into the several fingers; the same is true of the teeth in each jaw, etc. The arm and leg come from a common limb-ridge in the embryo which divides into an anterior and a posterior portion, and the resemblance between one somite and another in the earthworm is due to the incomplete division of the body into successive somites. The resemblances between right and left halves of the body (bilateral homology) must be traced back to a still earlier period in the egg or embryo when a bilateral division of embryonic substances occurs. Thus all forms of general homology are attributable to origin from common substances or primordia in the egg or embryo, which substances undergo partial division, the same being a form of incomplete asexual reproduction.

(b) *The Cause of Special Homology* must be traced back to still earlier sources, namely to descent from similar germ cells or germplasms. The only scientific explanation of the homologies between the arm of a man and the fore-leg of a horse is that both have had common ancestors. Special homology is thus attributable to descent from common ancestors, or to the division of a common inheritance material and its distribution to different individuals in the process of sexual reproduction. It is therefore a powerful argument in favor of evolution.

MORPHOLOGY OF ANIMALS

IV. ORGANIC SYMMETRY

Many inorganic things, such as molecules and crystals, have varying forms of symmetry depending upon the spatial relation of their atoms and molecules. Likewise the constituent parts of an organism, such as cells, organs, antimeres, and metamerer, bear certain spatial relations to one another, and this is what is meant by organic symmetry or asymmetry.

In any solid body there are typically three axes in the three dimensions of space and each of these axes has two poles. If all the axes and poles are alike we have spherical symmetry, a condition which is found in few if any living things. When the two poles of one axis differ from each other (polar differentiation) while all the other poles and axes are alike we have radial symmetry, a condition which is found in many egg cells as well as in some adult organisms. When all three axes differ from one another, while the two poles of only two of these axes differ from each other, we have bilateral symmetry, a condition which is found in a great number of plants and animals. These and other forms of symmetry are summarized in the following table:

SYMMETRY	AXES	POLES		ANIMAL EXAMPLES	
1. Spherical (ideal)	Homaxial	Homopolar		Few if any	
2. Radial	Single heteraxial	Single heteropolar		Hydra, jellyfish	
3. Biradial	Triple heteraxial	"	"	Ctenophores	
4. Bilateral	"	"	Double	"	Almost all animals above Ctenophores
5. Asymmetry	"	"	Triple	"	Paramecium, Snails

Probably the higher forms of symmetry and asymmetry were originally derived from the lower forms by progressive

MORPHOLOGY OF ANIMALS

differentiation of axes and poles. This can actually be seen in the embryology of certain animals where radial symmetry develops into bilateral, and the latter into asymmetry. On the other hand, in the case of some bilateral animals the eggs even are bilateral.

The chief axis of the adult connects the anterior and posterior poles and is called the antero-posterior axis. The side of the body which is usually directed downward is ventral, the opposite side dorsal, and the axis connecting these is the dorso-ventral axis. The axis connecting the right and left sides of the body is the transverse axis. A plane passing through the body in the antero-posterior and the dorso-ventral axes and dividing the body into equivalent right and left halves is called the median (bilateral) plane or section. A plane passing through the dorso-ventral and the transverse axes is a transverse plane, or section, while a plane passing through the antero-posterior and the transverse axes is called a coronal (frontal) plane or section.

C. MORPHOLOGY OF METAZOA

Metazoa are animals composed of many cells which are arranged in at least two layers, an outer layer covering the body, the *ectoderm*, and an inner layer lining the digestive cavity, the *endoderm*; in addition most metazoa have a middle layer or aggregation of cells, the *mesoderm*, lying between the ectoderm and endoderm. All have male and female sex-cells (spermatozoa and ova).

I. STAGES OF METAZOAN DEVELOPMENT

In the course of development all metazoans pass through the following stages (FIG. 1):

MORPHOLOGY OF ANIMALS

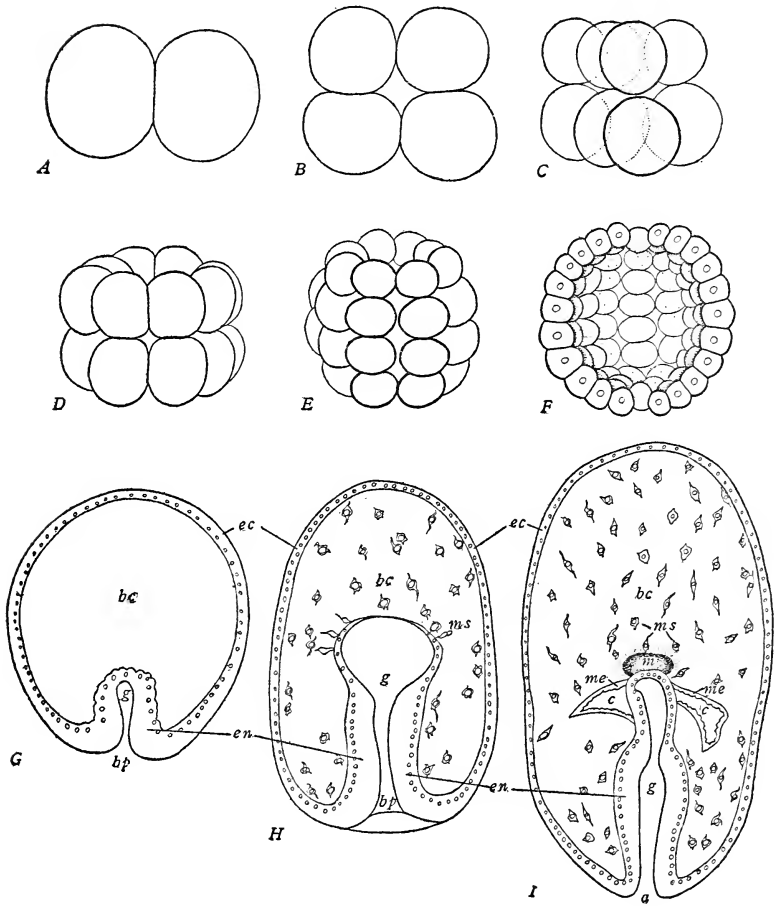

FIG. 1. *Cleavage, Blastula and Gastrula of an Echinoderm (Echinarachnius)*. A, 2 cells; B, 4 cells; C, 8 cells; D, 16 cells; E, 32 cells; F, Optical Section of a Blastula of about 128 cells showing a hollow sphere. The cavity in the sphere is the blastocoel. G, H, I, optical sections of young, medium and old gastrulae: *a*, anus; *bc*, blastocoel; *bp*, blastopore; *c*, coelom; *g*, gastrocoel; *m*, mouth; *me*, mesothelium; *ms*, mesenchyme.

MORPHOLOGY OF ANIMALS

(1) The *Fertilized Egg* which is a single cell, comparable to a one-celled organism; (2) the *Cleavage Stages*, during which the egg divides into a large number of cells, which are roughly comparable to a protozoan colony (FIG. 1, A-D); (3) the *Blastula*, which is typically a hollow sphere, radially symmetrical, composed of many cells, surrounding a central cleavage cavity, and resembling somewhat a *Volvox* colony (FIG. 1, E, F); (4) the *Gastrula* (FIG. 1, G-I), which is typically composed of two primary layers of cells, the outer layer, the *ectoderm* (*ec*), covering the body, the inner, the *endoderm* (*en*), lining the digestive cavity or *enteron* (*gastrocoel*, *g*), which opens to the exterior through a primary mouth or *blastopore* (*bp*). A third layer or group of cells, the *mesoderm*, arises from one or both of the primary layers or from certain of the cleavage cells before layers are formed, and comes to lie between ectoderm and endoderm. It may consist of loose, scattered cells (*mesenchyme*, *ms*), or of an epithelial layer (*mesothelium*, *me*), or of both (FIG. 1, H, I).

Such a gastrula is a real metazoan and some of the lowest metazoa are, in their adult condition, little more than gastrulae (e.g. *Hydra*). The gastrula is the ground-form of all metazoa and from this stage onward in the development of higher metazoa different phyla diverge, the gastrula undergoing certain modifications and complications which transform it into the adult form characteristic of each phylum. The earliest stages of ontogeny are in many respects like the lowest living organisms, as shown in the following table:

MORPHOLOGY OF ANIMALS

ONTOGENETIC SERIES	TAXONOMIC SERIES
1. Egg - -	Protozoan
2. Cleavage - -	Protozoan Colony
3. Blastula - -	Volvox-like Forms
4. Radial Gastrula	Simple Sponge, Hydroid
5. Bilateral Gastrula	Polyclad-like Forms

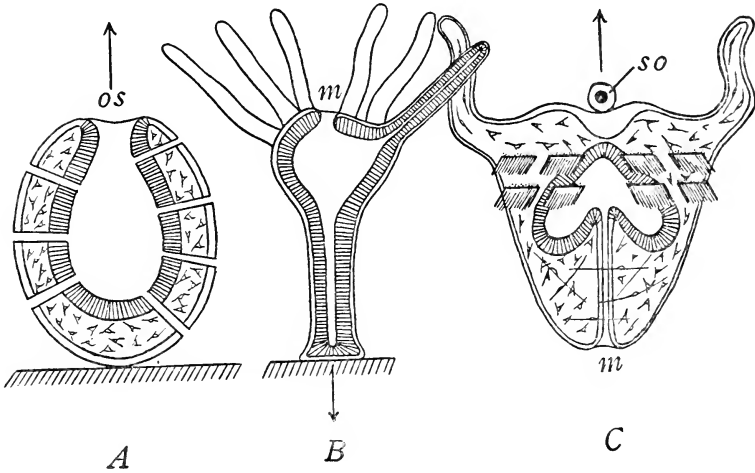

FIG. 2. Diagrams of Protaxonia in which the gastrula axis becomes the chief axis of the adult. A, a simple sponge in which the gastrula becomes attached by its oral pole, the blastopore then closes and a new opening into the gastric cavity, the osculum (*os*), appears at the apical pole; B, a Hydroid which has attached by the apical pole of the gastrula while the blastopore becomes the mouth (*m*) which is then surrounded by a row of tentacles; C, a ctenophore or jelly-sphere which swims by means of plates of fused cilia (8 plates are shown); the apical pole of the gastrula gives rise to the sense organ (*so*) of the adult while the blastopore becomes the mouth (*m*). (After Hatschek).

II. MODIFICATIONS AND COMPLICATIONS OF THE GASTRULA

1. Axes and Symmetry

(a) *Protaxonia* are the lowest Metazoa (Spongiaria, Cnidaria, Ctenophora) in which the chief axis of the gastrula becomes the chief axis of the adult (FIG. 2). In the

MORPHOLOGY OF ANIMALS

simplest forms the symmetry is radial, but in more complex forms it may be bilateral or biradial (Ctenophora, FIG. 2, C).

(b) *Heteroxonia* (= *Bilaterata*) are all other Metazoa except the protaxonia. In these the chief axis of the gastrula does not directly become the chief axis of the adult. By the greater growth of the gastrula on one side (ultimately posterior, FIG. 3, B-D) the oral and aboral poles of the gastrula become widely separated on that side and nearer together on the opposite (anterior) side; thus the axis running from the apical pole of the gastrula to the blastopore

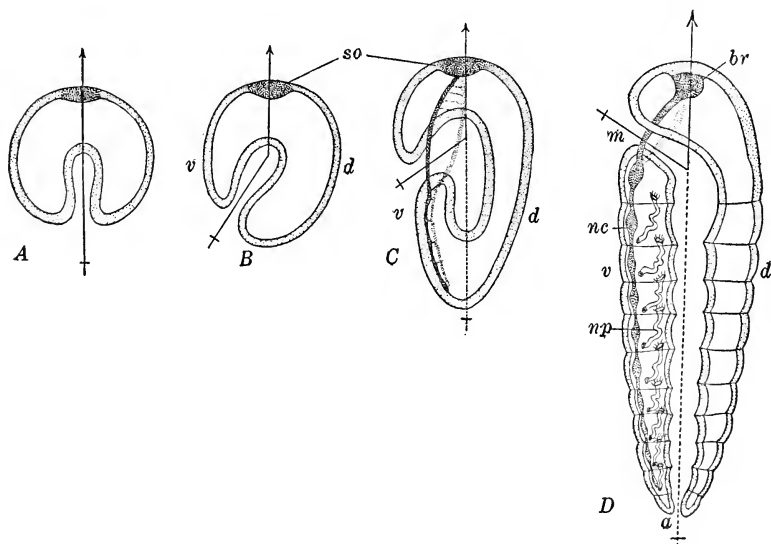

FIG. 3. Diagrams of the origin of *Heteroxonia* from a typical gastrula. Chief axis of gastrula indicated by arrow, apical (sensory) pole shaded, oral pole at blastopore. A, typical gastrula, radially symmetrical; B, bending of gastrular axis by greater growth of gastrula on dorsal-posterior side and consequent establishment of bilateral symmetry; C, stage corresponding to adult flat-worm (*Turbellaria*) with mouth in middle of ventral side, without anus and with two nerve cords (shaded) running from brain around oesophagus and along ventral side of body; D, stage corresponding to an annelid, the trunk segmented into several somites, with mouth near anterior end of body, anus at posterior end, nervous system consisting of brain, circumoesophageal ring and ventral chain of ganglia and with a pair of nephridia in each somite.

MORPHOLOGY OF ANIMALS

is bent, as shown in FIG. 3, and the gastrula becomes strikingly bilateral in symmetry.

The apical pole of the gastrula usually becomes the anterior pole of the adult. There is frequently a sense organ at this pole of the gastrula (FIG. 3, *so*) and it is often called the "sense pole"; the brain and higher sense organs of the adult usually develop at or near this pole. When the gastrular axis bends through approximately 90° the oral pole of the gastrula (blastopore) comes to lie on the ventral side of the adult in many invertebrates (some flatworms, FIG. 3, C, and arthropods); if it bends through more than 90° the blastopore approaches the anterior end (apical pole) of the adult (annelids, FIG. 3, D, mollusks). These relations are reversed in the lower vertebrates (*Amphioxus*, ascidians, amphibians) where the blastopore is at first dorsal and later posterior in position (FIG. 4, C-E). In general among invertebrates the blastopore becomes the mouth of the adult, and the anus, when present, is a new formation; in the echinoderms and lower vertebrates it becomes the anus (in part), the mouth being a new formation; in arthropods it usually closes completely, the mouth and anus being new formations.

These relations of gastrula and adult may be summarized as follows:

GASTRULA	ADULT
Apical Pole becomes	Anterior Pole
Oral Pole “	{ ventral side (invertebrates)
	{ dorsal “ (vertebrates)
Blastopore “	{ mouth (most invertebrates)
	{ anus (echinoderms, some chordates)

MORPHOLOGY OF ANIMALS

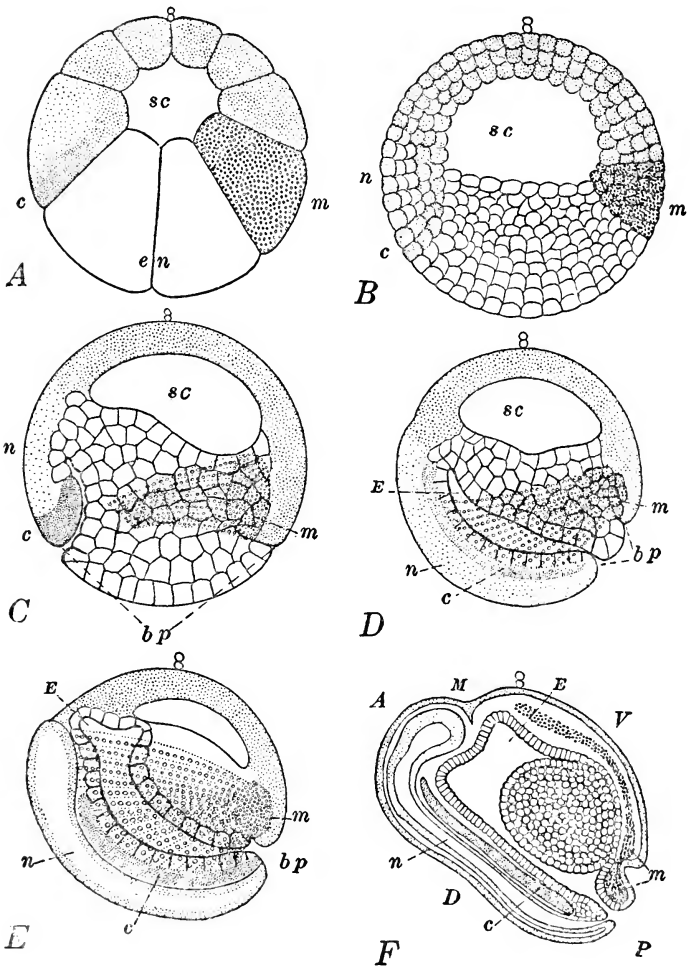

FIG. 4. Early Development of Frog's Egg. A, Late Cleavage; B, Blastula; C, Gastrula; D, E, F, young embryos. The animal pole of the egg is marked by two small polar bodies. The left side of each figure is anterior (*a*), right posterior (*p*), upper side ventral (*v*), lower side dorsal (*d*); *bp*, blastopore; *c*, notochord or area of embryo from which it comes; *E*, enteron; *en*, endoderm; *m*, mesoderm; *n*, neural tube, or plate, or area from which it comes; *sc*, segmentation cavity or blastocoel.

MORPHOLOGY OF ANIMALS

While the brain lies at or near the anterior pole in all Metazoa, the rest of the central nervous system lies on the ventral side of the body in most invertebrates, but on the dorsal side in vertebrates. The heart lies on the dorsal side in many invertebrates (annelids, arthropods) but on the ventral side in vertebrates. The side of the body on which most of the nervous system lies is called the *neural side*; that on which the heart lies is the *haemal side*.

A few Heteraxonia are apparently radially symmetrical (starfish, sea urchins, etc.), but they are really bilateral. Such apparently radial animals develop from bilateral larvae, probably in adaptation to a sedentary life. The internal organs of Heteraxonia are frequently asymmetrical, thus the heart of man is on the left side and the larger part of the liver on the right, but this asymmetrical condition is derived from a bilateral stage. Similarly some adult animals, such as snails, Amphioxus, flounders, etc., are strikingly asymmetrical but they are derived from bilateral embryos.

2. *Mesoderm and Body Cavities*. These develop in the space between the ectoderm and endoderm, that is in the *blastocoel* or *primary body-cavity* (FIG. 1, *bc*, FIG. 5, *a*, in A and B). In the lowest Metazoa the blastocoel is filled with scattered branched cells (mesenchyme), the spaces between cells being parts of the blastocoel (sponges, Cnidaria, Ctenophora, flat-worms). Among higher Metazoa the mesoderm is usually divided into an inner portion lying next to the endoderm and an outer one next to the ectoderm. Between these is a space, the *coelom* or *secondary body-cavity* (*c*, FIG. 5, C and D). This is lined by

MORPHOLOGY OF ANIMALS

flattened mesoderm cells, the *peritoneum*, and is usually divided into right and left halves by two longitudinal partitions, the dorsal and ventral *mesenteries*, one of which lies dorsal to the alimentary canal, the other ventral to it (*d, v*, FIG. 5, C); in some animals, one or both of these mesenteries may disappear (FIG. 5, D). In segmented animals the coelom may be further divided into a series of chambers by transverse partitions, the *dissepiments* or *septa* (FIGS. 3, D; 12, A), which may disappear more or less completely in some cases. The excretory and sexual organs are developed in large part from the walls of the coelom and project into its cavity. The portion of the coelom surrounding the heart is usually separated from the remainder and is called the *pericardial cavity*; while in the highest vertebrates (mammals) the anterior portion of the coelom which contains the lungs is separated by the *diaphragm* from the posterior part containing the abdominal viscera.

3. *Metamerism*. A further complication of the gastrula is introduced in segmented animals by the repetition of the principal organs of the body in a series, one behind the other (FIG. 3, D); such repetition is known as metameric segmentation, and each segment of the body is called a *somite* (annelids, arthropods, vertebrates). In the simplest cases each somite has its own section of the coelom and its own sensory, nervous, muscular, alimentary, respiratory, excretory, and sexual organs, and each may bear a pair of limbs or locomotor organs. Each somite in short, contains all the important organs and may properly be called a little body (i.e. somite).

MORPHOLOGY OF ANIMALS

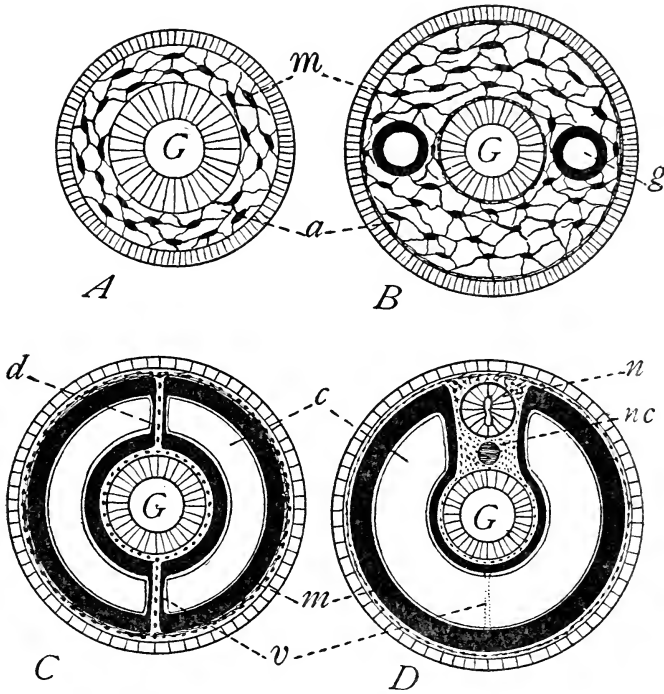

FIG. 5. Diagrammatic Transverse Sections of the bodies of A, Coelenterate; B, Flatworm; C, Annelid; D, Vertebrate; *a*, blastocoel filled with mesenchyme cells (*m*); *G*, Gastrocoel lined with endodermal epithelium; *g*, gonocoel or cavity of sex ducts and glands, probably homologous with *c*, coelom of animals with true body cavity; *n*, nerve tube; *nc*, notochord. The walls of the coelom are composed of a thin layer of mesothelium (peritoneum), a thick muscular layer (solid black), a thin layer of mesenchyme cells (*m*) in what was earlier the blastocoel (*a*), and covering the outside of the body the ectodermal epithelium, while endodermal epithelium lines the gastrocoel (*G*); *d*, dorsal mesentery; *v*, ventral mesentery, which has almost disappeared in the vertebrate (D).

In the higher segmented animals the various somites are no longer alike (homonomous), but show physiological division of labor, some being differentiated for one function and some for another (heteronomous). In this way some of the organs named above disappear in certain segments, while others become greatly enlarged or modified.

MORPHOLOGY OF ANIMALS

Finally this specialization of the somites is carried a step farther in higher arthropods and vertebrates, in which we have an intimate fusion of metameres and a coalescence of organs in certain regions, such as to more or less completely mask the fundamental segmentation. This is especially true of the vertebrates, the lower forms of which show segmentation of the axial skeleton (vertebrae and ribs) and attached muscles, of the nerves, of the gills and their blood vessels, and of the excretory and sexual organs; while in the higher vertebrates (reptiles, birds, and mammals) segmentation is limited in the adult to the axial skeleton, muscles, and nerves. The fusion of somites is most pronounced in the anterior part of the body; such fusion leads to the formation of a head (*cephalization*). The head of insects contains three or four somites (FIG. 15, A), while the vertebrate head is composed of not fewer than nine.

Primitively the limbs are all alike and a pair is borne on each somite (many annelids); however in higher annelids and arthropods they disappear entirely from certain somites and in others undergo great modifications of structure to fit them for particular functions. In the case of vertebrates they are limited to but two pairs, and it is probable that these are derived from a continuous lateral limb-ridge by the suppression of an intermediate portion.

The great modifications and complications which have been briefly sketched lead far from the simple form of the gastrula, which is the ground-form of all Metazoa.

MORPHOLOGY OF ANIMALS

III. ORGAN SYSTEMS

Organ systems are two or more organs associated in a common function. We recognize the following systems: (1) Integumentary, (2) Skeletal, (3) Motor, (4) Alimentary, (5) Respiratory, (6) Circulatory, (7) Excretory, (8) Reproductive, (9) Nervous, (10) Sensory.

1. *Integumentary System*

(a) *Epidermis*. In all animals the outer covering of the body consists of a layer of epithelial cells, derived from the ectoderm and known as the *epidermis*. Beneath this layer a *basement membrane* is present, which in some animals is thick and serves for protection and support (Cnidaria, Platoda). This epidermis is frequently ciliated and it always contains gland and sensory cells and in addition may contain nerve and muscle cells as well as stinging cells (Cnidaria). In some animals the epidermis, which in these cases is called *hypodermis*, secretes on its outer surface a cuticular covering which may be a thin and flexible membrane or cuticle (hydroids, trematodes, cestodes, annelids, rotifers), or it may be thick and flexible (nematelminths) or dense and inflexible except at the joints (arthropods). In other cases the epidermis secretes skeletal structures in certain regions only, thus giving rise to calcareous shells (corals, mollusks, brachiopods). In arthropods this epidermal secretion is particularly dense and tough and is known as *chitin*; it may become calcified in certain portions. In mollusks the superficial epidermis remains naked except in a certain region, the embryonic shell-gland, where it first secretes a cuticular covering and then forms beneath this a dense calcareous layer, the shell;

MORPHOLOGY OF ANIMALS

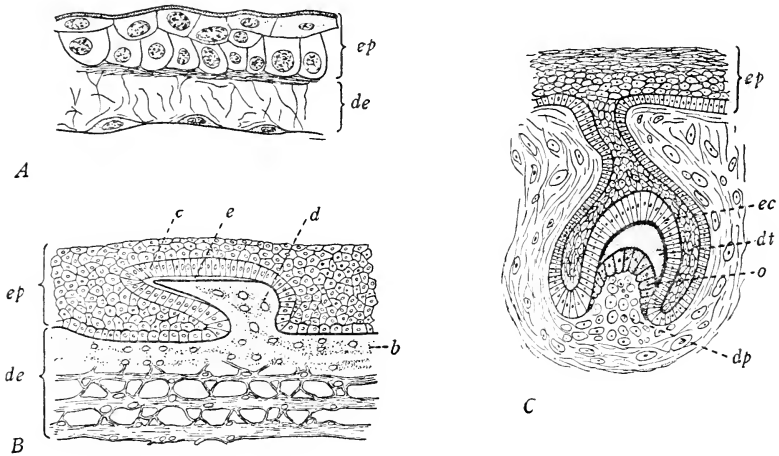

FIG. 6. Sections of the Integument of A, young salamander; *ep*, epidermis only two cells thick, *de*, dermis consisting of branched cells and a felt-work of fibers; B, embryo shark showing formation of denticle (scale); its core of dentine *d*, resting on a plate of bone *b*, both from the dermis *de*, and its outer surface covered by enamel *e* from the columnar epidermal cells *c*; C, developing tooth, *ep*, epidermis of mouth infolded to form enamel cells *ec* which secrete enamel (black line); *dp*, dental papilla from dermis, covered on outer side by odontoblasts *o* which secrete dentine *dt*. (B and C after Wiedersheim).

at the margins of the shell gland (mantle edges) the secretion of these layers continues throughout life. In reptiles, birds, and mammals the superficial epithelium (epidermis) becomes many layers thick and the outer layers of cells die and are transformed into horny or cuticular substance, an adaptation to life out of water (FIG. 7). In these three classes of vertebrates there are also a number of characteristic epidermal outgrowths: in reptiles these take the form of horny scales or plates; in birds they appear as feathers which are only modified scales; and in mammals as hair (FIG. 7), while nails or claws are formed from the epidermis in all of these classes. In the mammals there are also epidermal ingrowths which

MORPHOLOGY OF ANIMALS

may give rise to various types of glands, such as sweat, oil, wax, and milk glands, all of which are epidermal in origin (FIG. 7).

(b) *Dermis*. Beneath the surface epithelium, which is always ectodermal in origin, there is in many animals a fibrous or connective tissue layer known as the *dermis* or *corium*. This layer is derived from mesenchyme and is sometimes called "leather-skin," since leather comes from it. It is especially well developed among echinoderms and vertebrates, in both of which it may give rise to skeletal spicules or plates, thus forming a dermal exoskeleton (FIG. 10, *pl*, *sp*). Among the vertebrates this is especially well developed in fishes, the scales which cover the body being of dermal origin; in some cases these dermal scales are covered by enamel which is derived from the epidermis. The same is also true of the teeth of vertebrates; the inner portion or dentine is of dermal origin, while the enamel comes from the epidermis; teeth are in fact only modified scales (FIG. 6, B and C).

2. *Skeletal System*

An internal skeleton, not the product of the integument, is present in relatively few invertebrates, but is found in all vertebrates and is always derived from mesenchyme. Such a skeleton is found in sponges in the form of calcareous, silicious and horny spicules; in cnidarians and ctenophores, as a supporting jelly; in many invertebrates, as a system of connective-tissue cells and fibres; in cephalopods and certain arthropods, as cartilages surrounding the central nervous system.

On the other hand the possession of a primitive axial

MORPHOLOGY OF ANIMALS

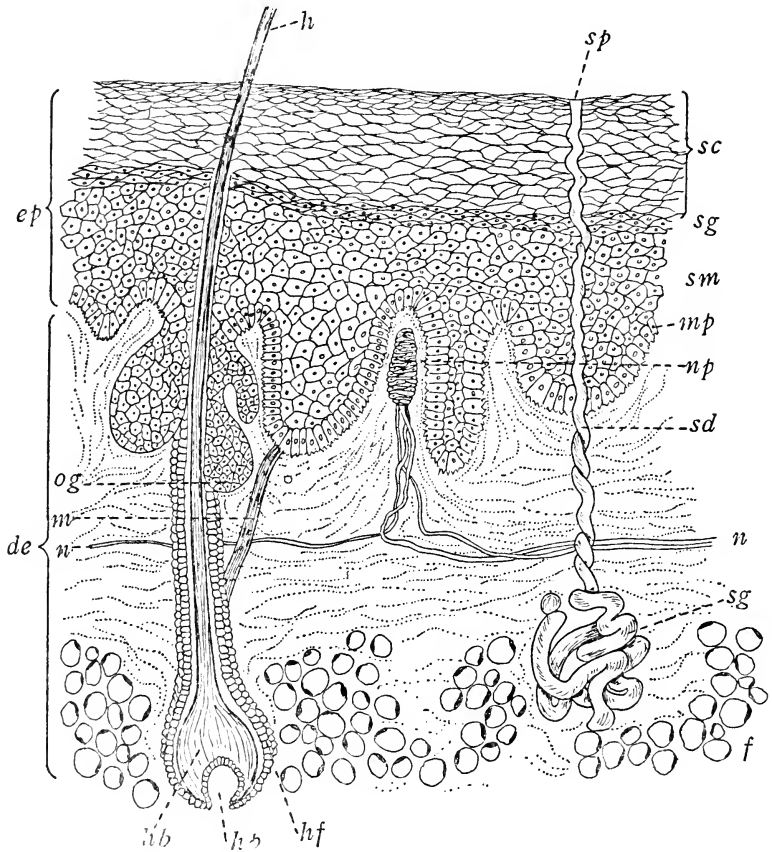

FIG. 7. Section of human skin; *ep* epidermis, *sc* stratum corneum, *sg* stratum granulosum, *sm* stratum mucosum, *mp* Malpighian layer, all of epidermis; *h* hair, *hf* hair follicle, *hb* hair bulb, *og* oil gland, *m* muscle of hair, *sp* sweat pore, *sd* sweat duct, *sg* sweat gland, all epidermal ingrowths; *n* nerve, *np* nerve papilla, *hp* hair papilla, *f* sub-cutaneous fat, all in dermis.

skeleton, the *notochord* (FIG. 12, B, *nc*), is one of the chief characteristics of the Chordata; in addition to this there are generally present in this phylum many other skeletal elements which are usually cartilaginous or bony. In all

MORPHOLOGY OF ANIMALS

true vertebrates the notochord becomes surrounded by cartilage, and the whole is then constricted into a series of segments, the *centra* of the vertebrae; from these centra cartilaginous *arches* grow dorsally around the spinal cord, while other skeletal arches, the *ribs*, surround the trunk and later articulate with the vertebral column; finally the ribs may be united ventrally, thus forming the *sternum*: these parts constitute the *axial skeleton* (FIG. 8). The degree of development of notochord and vertebral column in embryos and adults of different classes of vertebrates is shown in the following table:

AXIAL SKELETON	UNSEGMENTED CELLULAR ROD	SEGMENTED VERTEBRAL COLUMN	EACH VERTEBRA COMPOSED OF SEVERAL BONES	EACH VERTEBRA A SINGLE BONE
Amphioxus and Lowest Chordates	In adult	————	————	————
Sharks	In embryo	In adult	————	————
Bony fishes Amphibia Reptiles	In early embryo	In later embryo	In young and some adults	————
Birds and Mammals	In earliest embryo	In early embryo	In young	In adult

In addition there is the skeleton of the head (the skull) and that of the limbs (the appendicular skeleton). In the lower vertebrates and in the embryos of all higher forms the skull consists of a *cartilaginous cranium* partially surrounding the brain, and of paired cartilaginous rods forming the skeleton of the *jaws* and *gill arches*. In higher vertebrates these cartilaginous elements undergo ossification,

MORPHOLOGY OF ANIMALS

and in addition dermal bones are formed which partially overlie this cartilaginous basis. The appendicular skeleton consists of two limb girdles partially surrounding the trunk and axial skeleton, namely the *pectoral* and the *pelvic girdles*, and of the skeleton of the limbs themselves (FIG. 8). In the fishes these girdles and limbs are peculiar and it is difficult to homologize their skeletal parts with those of higher forms; in all vertebrates above the fishes, however, the relations of these parts are similar and their homologies are not difficult to determine.

The corresponding parts and bones of the

<i>Fore Limbs</i>		and	<i>Hind Limbs</i>	
PARTS	BONES		PARTS	BONES
Upper arm	Humerus		Thigh	Femur
Fore arm	Ulna and Radius		Shank	Tibia and Fibula
Wrist	Carpals		Ankle	Tarsals
Palm	Metacarpals		Sole	Metatarsals
Fingers	Phalanges		Toes	Phalanges

3. *Motor System*

All animals at some time in their lives have the power of locomotion, though in some cases this is lost before adult life is reached and the animal becomes fixed like a plant (hydroids, sponges, crinoids, mollusoids, and many parasites). However, in all these cases certain parts of the body preserve the power of movement, though the animal as a whole is incapable of locomotion. Animal movement is of three fundamental types: amoeboid, ciliary, and muscular.

(a) *Amoeboid movement* is limited to individual cells and is manifested especially by free cells. It consists of a

MORPHOLOGY OF ANIMALS

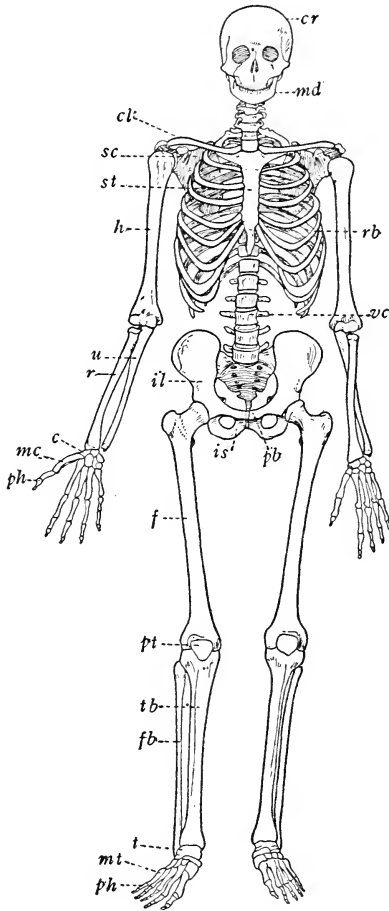

FIG. 8. *Human Skeleton*. Axial skeleton consists of vertebral column (*vc*), ribs (*rb*) and sternum (*st*). Skull consists of cranium (*cr*), bones of the face, jaws (*md*) and hyoid arch. Appendicular skeleton consists of the shoulder girdle (*cl*, clavicle and *sc*, scapula), the pelvic girdle (*il*, ilium, *is*, ischium, *pb*, pubis) and the skeleton of the arm and the leg. The bones in the arm and hand are humerus (*h*), ulna (*u*) and radius (*r*), 8 carpals (*c*), 5 metacarpals (*mc*), 14 phalanges (*ph*); the bones of the leg and foot are femur (*f*), patella (*pt*), tibia (*tb*), and fibula (*fb*), 7 tarsals (*t*), 5 metatarsals (*mt*) and 14 phalanges (*ph*).

MORPHOLOGY OF ANIMALS

streaming of semi-fluid protoplasm and is typically illustrated by the proteus animalcule, Amoeba. In this protozoan small lobes, or *pseudopodia*, may appear anywhere on the body, and into one or more of these the endoplasm, with all that it contains, may be seen to stream, at the same time being withdrawn from the other lobes. This flowing may continue for some time in a given direction, the outflow of protoplasm at one end of the body being compensated for by the inflow at the other end, thus producing an actively progressive movement; this is, therefore, a vortex, the current moving forward through the middle and backward at the periphery (FIG. 9, A). The causes of this movement are obscure, but in some cases it seems to be associated with temporary inequalities in the tension of the surface layer; at points where the tension of this layer is reduced, an outflow of protoplasm occurs, forming a lobe or pseudopod, into which protoplasm from the main body continues to flow so long as the tension is least at this place. Several points of reduced tension may exist at the same time on the surface of an amoeboid cell, so that several lobes or pseudopodia are found radiating from a common center. In other cases such movement is, perhaps, due to the general contractility of protoplasm, local contraction in one part of a cell causing an outflow in another part.

(b) *Ciliary movement* consists in the rhythmical beating of innumerable small protoplasmic threads (*cilia*) which project from the free surfaces of certain cells and which act somewhat like oars. Among one-celled organisms the entire cell may be covered by these cilia; in all

MORPHOLOGY OF ANIMALS

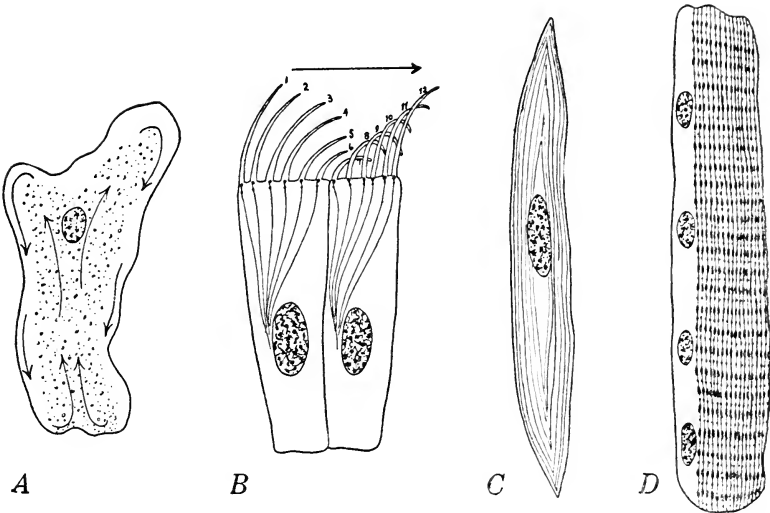

FIG. 9. *Types of Motor Cells.* A, amoeboid cell, arrows show direction of flow; B, ciliated cells, showing successive stages in the stroke (1-7) and in the recovery (7-12); C, smooth muscle cell, the peripheral portion of cell converted into contractile fibrillae; D, striated muscle cell, with four nuclei, one side of cell filled with fibrillae, each consisting of a series of nodes and internodes, the latter with a granule at its middle.

multicellular animals they are limited to the free borders of certain epithelial cells. The beating of a cilium includes two movements,—the stroke, which is rapid and by which the cilium is sharply bent in one direction, and the recovery of the original position which is relatively slow and weak. It is probable that the cause of this beating is the unequal contraction of the protoplasm on different sides of the cilium, by which it is bent first in one direction and then in another. All the cilia covering a free surface beat in unison, the stroke being in one direction, and the movement is so timed that beginning at one end of a ciliated tract it seems to pass in a wave-like movement to the other end (FIG. 9, B).

MORPHOLOGY OF ANIMALS

(c) *Muscular movement*, the principal type of movement in higher animals, is caused by the contraction of muscle fibres consisting of a kind of protoplasm especially differentiated for this purpose (FIG. 9, C, D). During the contraction or expansion of a muscle there is no change in its volume, the shortening of a fibre in one axis being compensated for by its expansion at right angles to that axis.

All of these types of movement are found in certain Protozoa and in many Metazoa. Amoeboid movements are, however, usually restricted to free cells without membranes or dense cortical layers of protoplasm, such as certain egg cells, embryonic cells, endoderm cells, excretory, pigment, and lymph cells of various Metazoa; in no case is this type effective in the movement of large bodies. In the larvae of all phyla except the nemathelminths and arthropods, locomotion is brought about, at least in part, by cilia, and even among the adult forms of many lower metazoans this is the principal type of locomotion (ctenophores, turbellarians, nemertines, rotifers). Among the nemathelminths and arthropods cilia are usually lacking throughout the whole life-cycle. In large animals locomotion is effected entirely by muscular contractility, while cilia are limited to certain regions where by their beating they produce currents. Muscle fibres are found in all Metazoa; they are of two kinds, striped and non-striped or smooth (FIG. 9, C, D); the latter are of very wide distribution throughout the Metazoa, the former are limited to a few phyla (mollusks, arthropods, chordates). Smooth muscle is contractile to a much greater extent than striped muscle, but is much slower in action.

MORPHOLOGY OF ANIMALS

The muscular system may consist of isolated fibres such as are found in many cnidarians, platodes, and rotifers, or these fibres may be united into bundles or sheets as is the case in most higher animals; these groups of muscles show many differences and can be compared only in a general way.

In general the arrangement of the body muscles depends upon the presence or absence of a skeleton. Animals such as annelids, which have no skeleton, usually have the body musculature arranged in the form of two coats, an outer layer of circular fibres and an inner of longitudinal ones; while the intestinal musculature is also arranged in two coats, the outer (next the coelom) longitudinal and the inner circular (FIG. 5, C, D). If an exoskeleton is present, as in arthropods, these muscular layers of the body wall are broken up into bundles which become attached to the skeleton; if an endoskeleton is present, as in vertebrates, the muscles become attached to the bones, many of which serve as levers.

The locomotor apparatus of echinoderms is unique, consisting of a great number of tube-feet, which are hollow muscular tubes, closed at the end by a sucking disk. The cavity of each tube is connected with the water-vascular (*ambulacral*) system within the body, from which water can be forced into the tube-feet. In this way they are protruded until the sucking disk touches and becomes attached to some object; then by contraction of the muscles of the tube-foot the water is forced back into the water system, and by simultaneous action of many of these feet the body is slowly warped along (FIG. 10).

MORPHOLOGY OF ANIMALS

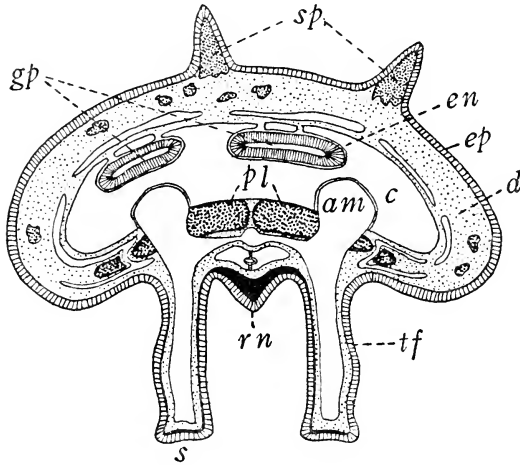

FIG. 10. Cross section of arm of Starfish; *ep*, epidermis; *d*, dermis containing calcareous plates (*pl*) and spines (*sp*); *c*, coelom; *gp*, gastric pockets, lined with endoderm (*en*); *rn*, radial nerve, lying in epidermis; *tf*, tube foot, containing a water tube which communicates with an ampulla (*am*); *s*, sucking disk at end of foot.

4. Alimentary System

With the exception of a few internal parasites which absorb their food in a digested condition from the bodies of their hosts, some form of digestive system is present in all animals.

Digestion is the process of rendering insoluble foods soluble and dialyzable. One of the distinguishing characteristics of animals is that they, unlike plants, take in, through a mouth opening, solid food, much of which is in an insoluble condition. This process is called *ingestion*. By the process of *digestion* some of this insoluble food is rendered soluble, and hence capable of diffusing to all parts of the organism, where by a process known as *assimilation* some of it is built up into the substance of the proto-

MORPHOLOGY OF ANIMALS

plasm itself. After the substances rendered soluble by digestion have been removed from the food, the indigestible remnants are cast out of the body in solid form (*egestion*).

Intracellular Digestion. Among the Protozoa digestion occurs within the body of a single cell, that is, it is intracellular. The same is true of sponges and some Cnidaria, in which the food, consisting of microscopic particles, is ingested and digested by certain epithelial cells, lining the endodermal cavities. In all animals above the sponges intracellular digestion is limited to the endoderm cells and to certain free cells, such as white blood-corpuscles (*leucocytes*) and it is of decreasing importance as one ascends the scale.

Extracellular Digestion. In all animals except the lowest, digestion occurs principally in a digestive cavity surrounded by cells which pour their secretions into the cavity. By the action of these secretions certain insoluble food substances are transformed into soluble ones. This digestive cavity is in all cases derived from the enteron or primitive digestive cavity of the gastrula, and in the simplest cases it is little more than a sac whose walls may be folded into ridges or septa, thus enlarging the digestive surface (Anthozoa), or they may be extended to form tubular canals, the gastro-vascular system, by means of which the digested food is also distributed to all parts of the animal (Scyphozoa, Ctenophora, Turbellaria, FIG. 11, A).

Openings into Digestive Cavity. In all Cnidaria except the lowest class, and in all animals above the Cnidaria,

MORPHOLOGY OF ANIMALS

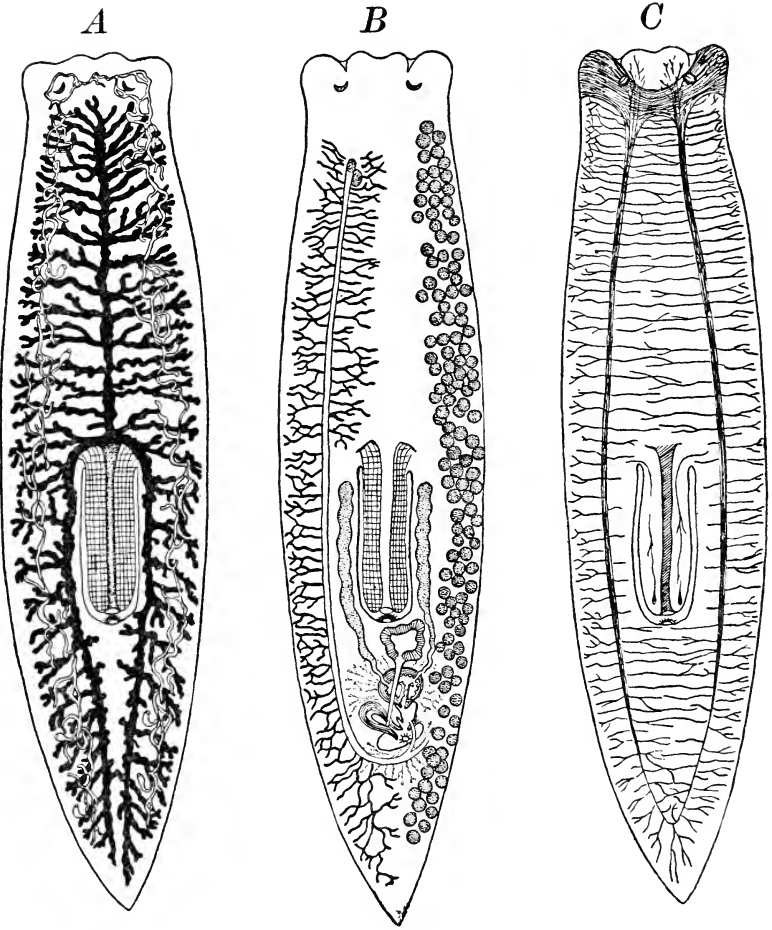

FIG. 11. *Diagrams of a Flat-worm (Planarian)*. A, showing gastro-vascular system in black, water-vascular (excretory) system as unshaded tubules ending in flame-cells, muscular pharynx, containing oesophagus, cross-hatched; B, showing female reproductive organs on left, single ovary at anterior end of oviduct, which receives along its sides vitellaria, or yolk ducts; testes, numerous shaded spheres on right; uterus and copulatory organs, posterior to pharynx; C, showing nervous system consisting of brain at anterior end, two nerve cords running posteriorly through body and giving off numerous lateral branches. (After Hatschek).

MORPHOLOGY OF ANIMALS

the ectoderm surrounding the mouth is folded in at the mouth opening, thus forming an ectodermal tube, or stomodaeum, which opens at the inner end into the gastric cavity. Among chordates this ectodermal invagination forms only the mouth cavity, the oesophagus being derived from the endoderm. In all Cnidaria, Ctenophora, and Platyzoa there is but one opening into the gastric cavity, the mouth, and through this single opening food is taken in and undigested remnants cast out. In the Nemertinea, and with a few exceptions in all higher animals, there is a second opening into the gastric cavity, namely the anus, through which the ejecta pass out. The anus is formed by an infolding of the ectoderm which meets and fuses with a portion of the gastric wall; this terminal ectodermal portion of the digestive tract is the hind-gut, or proctodaeum.

Fore, Mid, and Hind-Guts. With the formation of an anus the digestive tract becomes tubular, with mouth at one end and anus at the other, and the entire canal is divisible into three portions, an ectodermal stomodaeum or fore-gut, an endodermal mid-gut, and an ectodermal hind-gut. The relative development of these three portions differs much in different phyla; for example among chordates the fore-gut is limited to the mouth-cavity, and the hind-gut to an insignificant terminal portion of the intestine, while the mid-gut gives rise to all the intervening portions of the digestive tract (FIG. 12, B). Among arthropods, on the other hand, the mid-gut is limited to an extremely small portion of the digestive tube between the stomach and the intestine, while all the remaining portions

MORPHOLOGY OF ANIMALS

are derived from the fore and hind-guts. In all the higher animals the fore and mid-guts may be subdivided into mouth-cavity, pharynx, oesophagus, stomach, and intestine (FIG. 12, A and B) and in some cases these portions may be further subdivided, as for example in birds where the oesophagus gives rise to an enlargement, the crop, the stomach is divisible into a glandular stomach and a grinding stomach, or gizzard, and the intestine consists of two portions, the small and the large intestine. Finally into a portion of the hind-gut the excretory and sexual ducts as well as the intestine may open, in which case this common chamber is called the *cloaca* (FIG. 12, B, *cl*).

Various portions of the fore-gut may be armed with teeth, usually of a horny character among invertebrates, and of calcareous material in vertebrates; salivary glands open into it, and both mouth and pharynx may be protrusible. The digestive and absorptive surfaces of the mid-gut may be increased in three ways,—either (1) by an increase in length, in which case it becomes folded or coiled, or (2) by folds which project into the canal, or (3) by diverticula, that is blind sacs or tubes, which open out from the canal; in many higher forms all of these methods coexist in the same individual. The extent of the digestive surface depends primarily upon the character of the food; if the latter is highly nutritious the digestive surfaces are much smaller than where it is poor in nutrition. In carnivorous mammals, for example, the alimentary tract is from four to five times the length of the body, whereas in certain herbivora it may be from twenty to thirty times the length of the body.

MORPHOLOGY OF ANIMALS

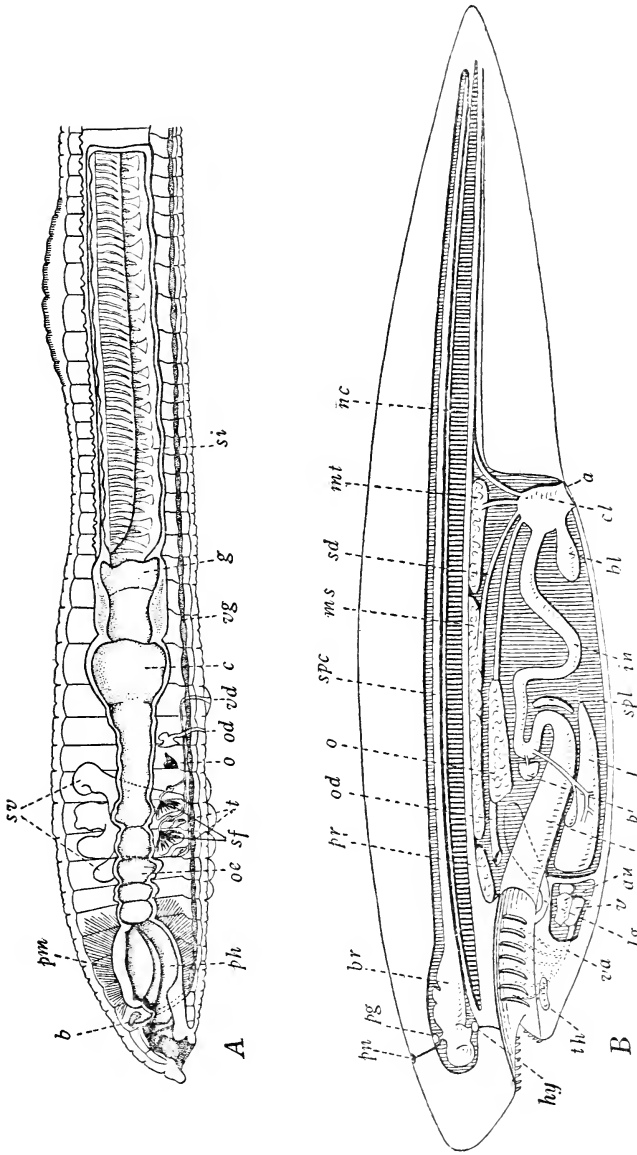

FIG. 12. Diagrammatic Median Sections of A. Earthworm; *b*, brain or cerebral ganglion; *c*, crop, *cr*, gizzard; *o*, ovary; *od*, oviduct; *oc*, oesophagus; *pl*, pharynx; *pm*, muscles of pharynx; *st*, stomach-intestine; *sf*, sperm-funnels; *sv*, sperm vesicles; *t*, testes; *vd*, vas deferens (sperm duct); *vg*, ventral ganglion chain. (After Howes) B. Idealized Vertebrate; *a*, anus; *ar*, auricle, dorsal to ventricle; (*v*); *bl*, bladder opening into cloaca (*cl*); *br*, hind brain; *hy*, hypophysis; *in*, intestine; *l*, liver; *lg*, lung or air bladder; *ms*, mesonephros; *mt*, metanephros; *pr*, pronephros; *nc*, notochord; *o*, ovary; *od*, oviduct; *p*, pancreas; *pg*, pineal gland; *pn*, pineal eye; *spc*, spinal cord; *spl*, spleen; *st*, stomach; *th*, thyroid gland; *v*, ventricle. (After Parker and Haswell).

MORPHOLOGY OF ANIMALS

Digestive Cells and Glands. In the simplest Metazoa it is probable that all the cells lining the digestive cavity are alike and that they all secrete the same digestive fluids; in more complex animals the cells differ in structure in different portions of the tract. Some of these cells form diverticula or blind tubes opening out from the canal; thus digestive glands are formed which pour particular digestive secretions into the alimentary canal. Those most generally present are the salivary glands, opening into the fore-gut, and the liver and pancreas (or where both are united, as often happens among the invertebrates, the hepato-pancreas), which open into the mid-gut.

Movements of Food in Alimentary Canal. In all of the lower invertebrates except the round worms the food is moved about in the alimentary tract by means of cilia or by general contractions of the body. In all higher forms the contraction of muscle fibres surrounding the canal plays an important part in this movement, though cilia may also be present. In the chordates both longitudinal and circular muscles surround the canal and by their rhythmical contractions produce a wave-like constriction of the canal (*peristalsis*), which passes along the canal from mouth to anus.

5. *Respiratory System.*

Respiration consists in the exchange of gases between the body and the medium which surrounds it. The gas given off from the body is principally carbon-dioxide, one of the products of combustion within the body, while that which must be supplied to it is oxygen. Since oxidation is the one essential feature of destructive metabolism

MORPHOLOGY OF ANIMALS

which occurs in all living matter, it follows that respiration is a universal function in organisms. In small and simple animals this exchange of gases takes place directly between the living cells and the surrounding medium and occurs all over the surface of the body. In more complex forms with body fluids the exchange takes place between the cells and the body fluid or blood (*internal respiration*) and then between this fluid and the external medium (*external respiration*). There are no special organs for internal respiration. External respiration may take place through the general integument of the body without the aid of any specific organs, as is the case in all small animals and in many larger ones,—for example flat worms, round worms, rotifers, small annelids, and even some vertebrates, such as the lungless salamanders. However, in most animals of any considerable size, special organs exist to facilitate this exchange.

Branchiae, Gills. In aquatic animals vascular processes are present which serve to bring the blood into close relation with the water. These processes, which are called *branchiae* or *gills*, are covered by a thin epithelium through which an interchange of gases contained in the blood and in the water can readily take place. To facilitate this interchange the gills are usually much folded or branched so as to afford a large surface, and they are frequently covered by cilia which serve to keep the water in motion, while at the same time the blood is circulated through them. The simplest type of gill is a ciliated tentacle, which may also serve other functions, as in Mollusca and some Mollusca (FIG. 13, A); such gills may

MORPHOLOGY OF ANIMALS

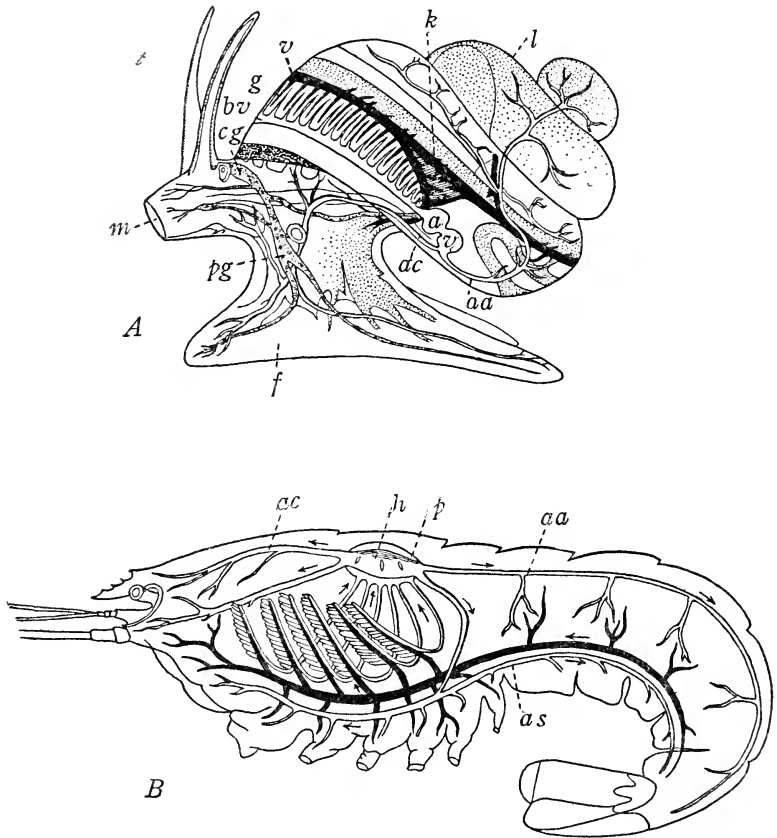

FIG. 13. *Respiratory and Circulatory Organs of Snail and Crayfish.* A, Snail (*Paludina*); *a*, auricle; *v*, ventricle of heart; *aa*, abdominal aorta; *ac*, cephalic aorta; *k*, kidney; *l*, liver; *g*, gills; *v*, vein carrying blood from body to gills; *bv*, branchial vein carrying blood from gills to heart (blood goes from heart to all parts of body, comes back to kidney and gills and then goes to heart); *t*, tentacles; *m*, mouth; *cg*, cerebral ganglion with eye on its anterior side; *pg*, pedal ganglion with statocyst on its posterior side; *f*, foot. (After Leydig).
 B, Crayfish; *h*, heart with 3 ostia (openings) on each side into pericardium (*p*); *aa*, abdominal aorta; *ac*, cephalic aorta; *as*, sternal artery. Arteries are shown as empty tubes, veins and sinuses as black. Blood goes out from heart to all parts of body, comes back through veins and sinuses to gills, and then goes to the pericardium and heart. (After Claus).

MORPHOLOGY OF ANIMALS

become branched or plume-like or may fuse together into plates (Lamellibranchia). Gills are situated on those parts of the body where they will be most exposed to currents of water, and they occur in the most extraordinarily different positions in different phyla; thus they may be found on the limbs (some annelids, crustaceans, FIG. 13, B), on or around the head (sedentary annelids, molluscoids), along the sides of the body (primitive mollusks), on the lateral walls of the pharynx (chordates), or as outgrowths of the hind-gut (holothurians). Homology being "correspondence in the relative position and connection of parts," there can of course be no homology between structures occurring in such diverse positions, and yet within a given phylum they may be homologous and of high morphological value (for example chordates).

In the chordates a series of gill-clefts opens right and left through the walls of the pharynx (FIG. 12, B), and in the lower classes of this phylum the gills are found as highly vascular plates or tufts on the outer side of the arches lying between these clefts; water is taken in through the mouth and then forced out through the gill-clefts and thus over the gills. In the higher classes of the phylum (reptiles, birds, and mammals), imperforate gill-clefts and gill-arches are present during embryonic life, though at no time in their entire life history do these animals have gill filaments and respire water. The constancy of gill-clefts and arches among vertebrates gives this character a high value in determining the affinities of such doubtful forms as *Balanoglossus*, *Cephalodiscus*, and *Tunicata*.

MORPHOLOGY OF ANIMALS

The fate of the embryonic gill-pouches in different classes of vertebrates is shown in the accompanying table:

Embryonic Gill Pouches	} Become in adult				
	<i>1st Pair</i>	<i>2nd Pair</i>	<i>3rd Pair</i>	<i>4th Pair</i>	<i>5th Pair</i>
Lower Fishes	Spiracle and Thymus	Open Slit and Thymus	Open Slit and Thymus	Open Slit and Thymus	Open Slit and Thymus
Lower Amphibia	Never Open	"	"	"	Never Open
Higher Amphibia	Never Open Eustachian Tube and Middle Ear	Open in Larva, closed in Adult			"
Reptiles, Birds Mammals	"	Never open at any stage. Remnants of various pouches become Thymus, Tonsils, Parathyroids.			

Tracheae, Lungs. In animals which do not dwell in water, and in some few which do (insect larvae, lung-fishes, etc.), certain infolded portions of the body wall or of the pharynx occur into which air is drawn and from which it is again expelled. Among invertebrates these infolded portions are generally derived from the skin; among vertebrates from a portion of the alimentary canal, the pharynx. In the case of insects and allied forms (Tracheata) these infolded portions have the form of much branched tubes, the tracheae, which reach to all parts of the body, the terminal twigs of the tracheal system of tubes being found in connection with almost every bit of tissue in the body (FIG. 15, B). These tracheae open to the exterior through closeable pores, the spiracles, situated on the sides of the body (FIG. 15, A); air is taken in

MORPHOLOGY OF ANIMALS

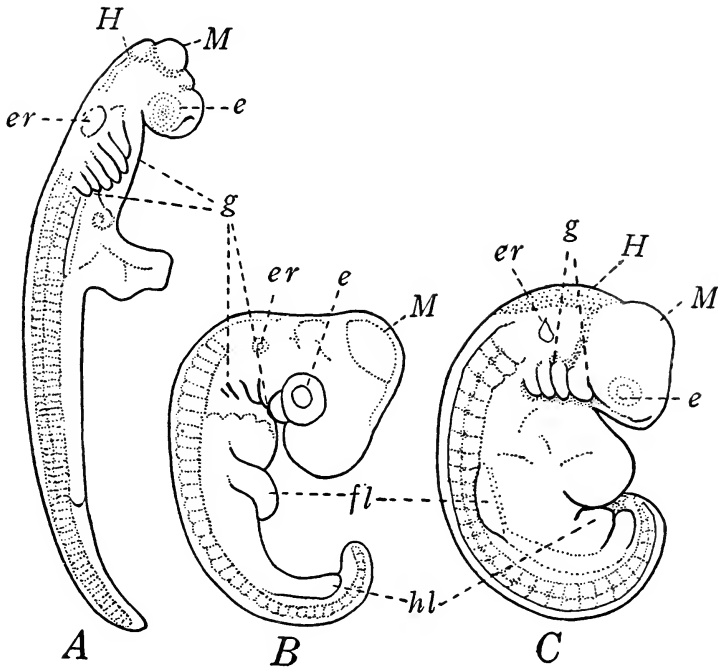

FIG. 14. *Gill Clefts of Vertebrate Embryos.* A, Shark; B, Chick; C, Man; *g*, the gill clefts (black lines) between which are the gill arches (unshaded); *M*, mid-brain, *H*, hind-brain; *e*, eye, *er*, ear; *fl*, fore-limb, *hl*, hind-limb. (After Scott).

through these pores and by means of the tracheal tubes penetrates to all parts of the body, the exchange of gases taking place directly between the tissues and the tracheae (FIG. 15, B). Among the vertebrates the lungs are an evaginated portion of the pharynx. The swim-bladder, which in most fishes is a hydrostatic apparatus, (FIG. 12, B, *l*), in the lung fishes (Dipnoi) becomes highly vascular and may serve as a lung. In all higher vertebrates the lung is paired, and its walls which in the lower classes are relatively simple, become much folded and very richly sup-

MORPHOLOGY OF ANIMALS

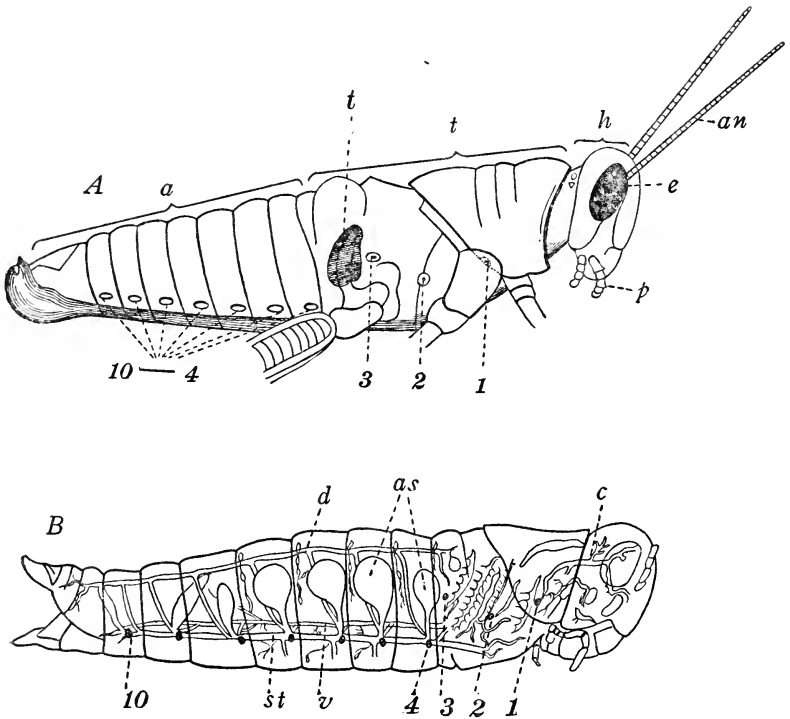

FIG. 15. *Respiratory and Sensory Organs of Grasshopper.* A, Surface view, showing head (*h*), thorax (*t*) and abdomen (*a*); the head bears antennae (*an*), eyes (*e*) and mouth palps (*p*); the thorax bears 3 pairs of legs and 2 pairs of wings (here removed); the abdomen consists of 7 segments and a terminal portion, each thoracic and abdominal segment bears a *spiracle* (1-10), and the last thoracic segment has a *tympanum* or ear drum (*t*). (After Hatschek).

A, Internal Air Sacs (*as*) and Tracheae; *c*, cephalic trachea, *d*, dorsal trachea; *st*, stigmatal trachea into which spiracles (4-10) open; *v*, ventral trachea. (After Packard).

plied with blood vessels. The exchange of gases here takes place between the blood and the air within the lung, and in most vertebrates the oxygen-carrying capacity of the blood is increased by the presence of haemoglobin (the coloring matter of red blood-corpuscles) which enters into a loose chemical combination with oxygen.

MORPHOLOGY OF ANIMALS

6. Circulatory System

The physiological significance of the circulation of fluids within the body is the distribution of nutriment and, in some cases, of oxygen to all parts. In the simplest Metazoa (Cnidaria, Ctenophora) there is no need of a special circulatory apparatus other than that which is furnished by the gastric cavity itself; this may branch and extend to various parts of the body of a jellyfish or hydroid colony, thus forming a *gastro-vascular system*, through which the distribution of nutriment takes place; the branched gastric cavity of certain turbellarians also serves a similar function (FIG. 11, A). Circulation of body fluids also occurs in many lower animals without the aid of any special circulatory apparatus; in such cases lymph, containing the products of digestion, is distributed through all the intercellular spaces in the primary body-cavity, and by the contractions of the general musculature of the body it is kept in irregular movement.

Blood-Vascular System. With the single exception of the nemerteans a blood-vascular system is found only among animals with a secondary body-cavity, or true coelom, and is lacking even in some of these, particularly such as are quite small or are evidently degenerate forms. With a few exceptions it is present in mollusks, echinoderms, annelids, arthropods, and all chordates. In its simplest form it consists of branching and anastomosing tubes which contain blood. The walls of the tubes are composed of flattened epithelial cells (endothelium) which may be surrounded on the outside by muscle and connective tissue fibres. The blood which fills these vessels consists of a

MORPHOLOGY OF ANIMALS

fluid or plasma within which floating cells or corpuscles are almost invariably present. With the increasing complexity of this system the walls become thicker by increase of the muscular or connective tissue coats, and in certain parts of the system the vessels become larger. The muscular walls may be pulsatile throughout the entire length of a vessel, or this function may be limited to a small portion of a large vessel, which is then known as a heart; even in the highest animals the heart is only a differentiation of a simple pulsatile blood vessel. The vessels leading away from the heart are arteries, those through which the blood flows back to the heart are veins, while the small thin-walled vessels connecting these two, and through the walls of which the plasma escapes into the tissues, are capillaries. In annelids there is a large longitudinal vessel on the dorsal side and another on the ventral side of the body, which are connected in each somite by commissural vessels. The dorsal vessel is pulsatile along its whole length, and peristaltic contraction waves can be seen in a living worm to pass from its posterior to its anterior end; correspondingly the blood flows forward in the dorsal vessel, down through the commissural vessels into the ventral one, and then backward through the latter to the posterior portion of the body, where the blood ascends through the commissural vessels to the dorsal vessel, after which the same circuit is repeated. Throughout this whole course the blood flows through vessels with definite walls, and therefore the circulation is said to be closed.

In mollusks and arthropods a heart is present which is more complicated and more complete than in annelids. In

MORPHOLOGY OF ANIMALS

arthropods this generally consists of a thick-walled, pulsatile tube lying on the dorsal side of the body and extending through several somites; in each somite are a pair of openings, the ostia, which open into the heart from the pericardium, and through which returning blood enters the heart (FIG. 13, B). In the mollusks also the heart is of a compact type and is divided into auricular and ventricular portions. Primitively two auricles are present, though in some gasteropods this number is reduced to one; in all mollusks there is but one ventricle (FIG. 13, A). In primitive arthropods and mollusks the blood flows out of the ventricle at both its anterior and posterior ends; in more highly differentiated members of these phyla, out of the anterior end only. The vascular system of arthropods is not a continuous system of vessels; the arteries soon end in lacunar spaces in the tissues, and from these spaces the blood is gathered into large sinuses and thence flows back to the heart. These lacunar spaces and sinuses are not true vessels, since they do not have definite walls, but they are derived from the primary and secondary body-cavities; the circulation is therefore an open one. In mollusks the vascular system is more extensive than among arthropods, but here also the circulation is open, the arteries being connected with the veins by a system of lacunar spaces instead of by capillaries. Finally among the echinoderms and chordates the circulation is closed as among the annelids; that is, the blood throughout its entire circuit is contained within definite vessels.

Circulation and Respiration. The manner in which blood is supplied to the respiratory organs is of great im-

MORPHOLOGY OF ANIMALS

portance in explaining the structure of the circulatory organs in air-breathing vertebrates. In annelids, crustaceans, and mollusks the blood flows directly from the heart to all parts of the body, whence it is gathered into trunks which carry it to the gills; from these organs it is then returned oxygenated to the heart (FIG. 13, A, B). In fishes the blood passes from the heart directly to the gills, whence it is gathered into the dorsal aorta and distributed to all parts of the body; it is then returned laden with waste products from the tissues to the heart (FIG. 16, A).

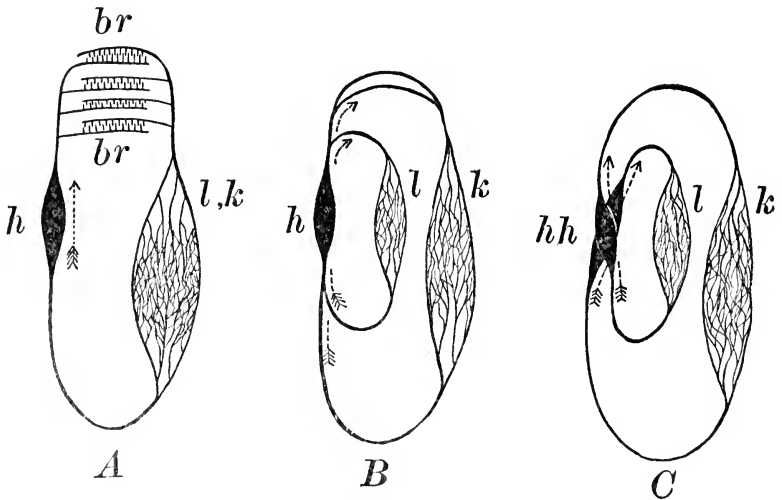

FIG. 16. *Diagrams of the Course of Circulation in different classes of Vertebrates.* A, Fish, blood goes from the heart (*h*) to the gills (*br*), thence to the swim bladder (*l*) and body (*k*) and then back to the heart. B, Frog, blood goes from the heart (*h*) through 3rd and 4th aortic arches to the body (*k*) and then back to the heart (*h*); through the 6th aortic arch to the lungs and then back to the heart. C, Birds and Mammals, blood goes from left side of heart (*hh*) through the 3rd and 4th aortic arches to the body (*k*) and then back to the right side of the heart, whence it goes to the lungs (*l*) and then back to the left side of the heart. (After Hatschek).

The heart of fishes consists of one auricle and one ventricle; it is essentially a simple tube more or less bent upon

MORPHOLOGY OF ANIMALS

itself (FIG. 17, A and A¹). In air-breathing amphibia a part of the blood passes directly from the heart to the lungs, whence it returns to the heart oxygenated, while a part of it goes at once to the body (FIG. 16, B); the former is known as the pulmonary, the latter as the systemic circulation. In these animals the heart is incompletely divided by a partition which separates the auricular chamber into two auricles, but which leaves the ventricle undivided (FIG. 17, B). The blood returning from the body is carried into the right auricle, while that from the lungs goes into the left; in the ventricle both kinds of blood mingle to a certain extent, though by a peculiar arrangement of folds and valves the larger part of the oxygenated blood which enters the left auricle is pumped to the anterior part of the body, while the blood from the right auricle goes to the lungs and to the posterior part of the body. Finally in all birds and mammals and in

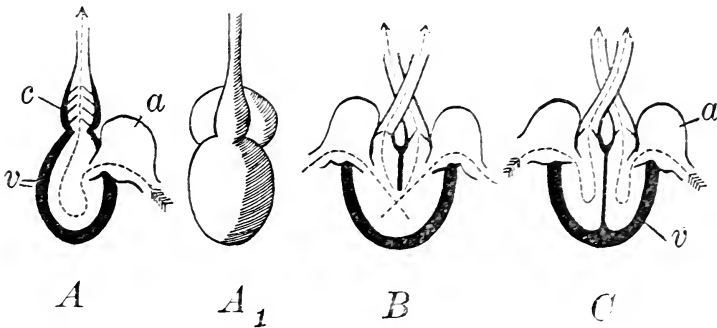

FIG. 17. *Diagrams of Hearts of different classes of Vertebrates.* A, Heart of Fish viewed from left side; 1 auricle and 1 ventricle; arrow shows course of blood through the heart, entering the thin-walled auricle (*a*), passing through the thick-walled ventricle (*v*) and issuing from the heart through the conus arteriosus (*c*) into the ventral aorta; the valves are flaps protruding into the ventricle and conus. A₁, same viewed from ventral side, B, Heart of Amphibians, 2 auricles and 1 ventricle. C, Heart of Birds and Mammals, 2 auricles and 2 ventricles; course of blood shown by arrows. (After Hatschek).

MORPHOLOGY OF ANIMALS

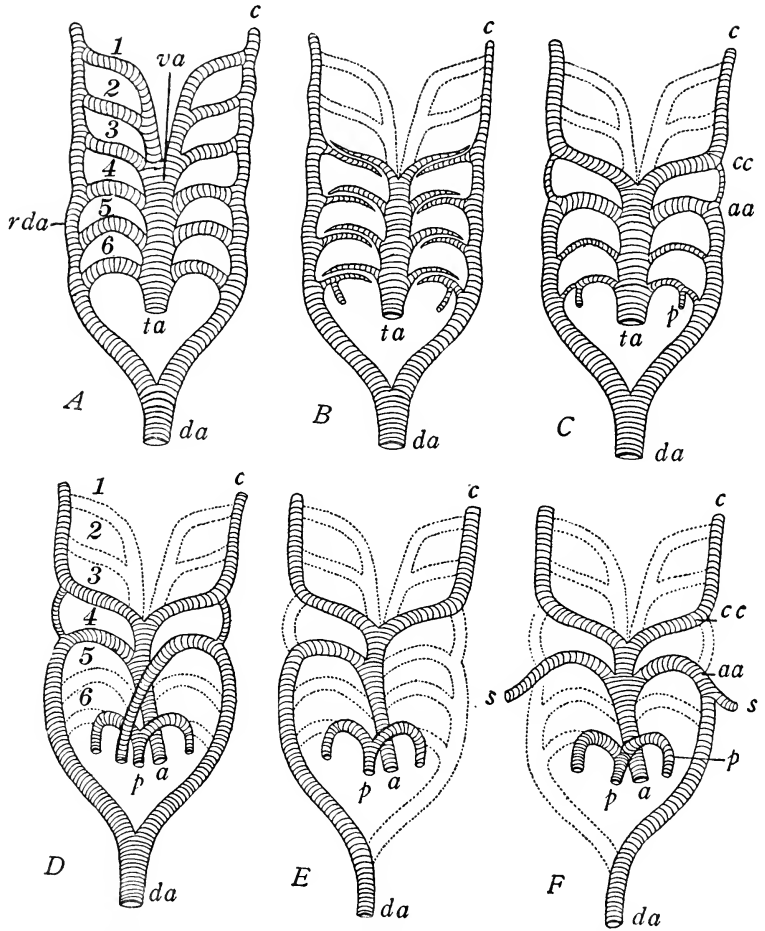

FIG. 18. Diagram of Embryonic Aortic Arches and their adult Derivatives in different classes of Vertebrates, all viewed from ventral side. A. Embryonic Aortic Arches of all vertebrates, six pairs (1-6), running from the ventral aorta (*va*) between the gill-slits to the right (*rda*) and left dorsal aortae which join posteriorly to form the single dorsal aorta (*da*); *c*, carotid artery going to head; *ta*, truncus arteriosus where it issues from the heart. B. Bony Fishes (Teleostei) with arches 3-6 preserved, each breaking up in the gill filaments. C. Tailed Amphibia (Urodela), arches 3-6 preserved, 3d becoming the common carotids (*cc*) and 4th, the great arches of the aorta (*aa*), while 5th and 6th are reduced and the latter gives off a pulmonary artery (*p*) to the lungs. D. Reptiles, 3rd and 4th arches preserved as in C, 5th arch disappears, 6th becomes pulmonary (*p*). E. Birds, 3rd arch as in D, 4th preserved only on right side, 5th and 6th as in D. F. Mammals, 3rd arch as in D and E, 4th becomes the great arch of aorta (*aa*) on left, and sub-clavian (*s*) on right, 5th and 6th as in D and E. (After Boas).

MORPHOLOGY OF ANIMALS

the highest reptiles (Crocodilia) the heart is completely divided by a partition into two auricles and two ventricles, and a double circulation, systemic and pulmonary, is established (FIG. 17, C). The blood from the left ventricle goes at once to all parts of the body, whence it returns to the right auricle; it then falls into the right ventricle and is pumped from that to the lungs; there it is oxygenated and returned to the left auricle, and then from the left ventricle it is again sent out to all parts of the body (FIG. 16, C).

The transformations of the embryonic aortic arches, lying in the pharyngeal walls between the gill-slits, in different classes of vertebrates is shown in FIG. 18 and in the following table:

Embryonic Aortic Arches	} Become in adult stages				
	<i>1st, 2nd Pairs</i>	<i>3rd</i>	<i>4th</i>	<i>5th</i>	<i>6th</i>
Fishes	Disappear	Persists	Persists	Persists	Persists
Lower Amphibia	"	Common Carotid	Right and Left Arches of Aorta	"	Right and Left Pulmonary
Higher Amphibia and Reptiles	"	"	"	Disappear	"
Birds	"	"	Right Arch of Aorta	"	"
Mammals	"	"	Left Arch of Aorta	"	"

The condition of the heart in the embryos and the adults of different classes of vertebrates is summarized in FIG. 17 and in the accompanying table:

MORPHOLOGY OF ANIMALS

<i>Heart with</i>	<i>1 Auricle 1 Ventricle</i>	<i>2 Auricles 1 Ventricle</i>	<i>2 Auricles 2 Ventricles</i>
Fishes	In adult	————	————
Amphibia and Lower Reptiles	In embryo	In adult	————
Crocodilia Birds Mammals	In early embryo	In later embryo	In adult

7. *Excretory System*

Excretion is the process of removing nitrogenous waste products, particularly urea and allied compounds, from the body. These waste substances are formed as the result of protein combustion within the body, and as this form of metabolism is universal among animals nitrogenous waste substances are everywhere formed. With few exceptions all animals possess some form of excretory organ; in fact this is one of the distinguishing characteristics of animals as contrasted with plants. In Protozoa the excretory organ is a pulsatile vacuole which gradually fills with fluid containing these waste products and then suddenly contracts, forcing this fluid out of the body. In coelenterates excretion is probably performed by isolated gland cells, so that no specific organ exists for this function. Even in higher animals excretion is performed to a limited extent by individual cells or small glands, for example the chlorogogue cells of annelids, the dermal glands of Crustacea, and the sweat glands of mammals.

Nephridia. In all higher animals a special excretory organ exists; this usually consists of minute tubules which take up the waste substances and pass them through the tubules to the exterior; such an excretory tubule is known

MORPHOLOGY OF ANIMALS

by the general name of nephridium. The forms of nephridia differ considerably in different phyla, but two principal types may be recognized; these are the proto-nephridia, or water-vascular system, and the meta-nephridia.

Proto-nephridia are found in flat-worms (FIG. 11, A) and rotifers; that is, among worm-like animals without a true coelom; they are also found as the larval excretory organ ("head kidneys") in annelids. They consist of more or less branched tubules opening at one or more places to the exterior, while the inner end of each tubule is closed by a single large cell which bears a tuft of long cilia projecting into the lumen of the tubule (FIG. 19, A). This tuft beats with undulatory movement and looks somewhat like the flickering flame of a candle, whence it is called a "flame" and the large cell which bears it is a "flame cell." The tubule itself is usually composed of a single series of long glandular cells ("drain pipe" cells), with the lumen running through the middle of each cell. In larger branches of the protonephridium the walls of the tubule may be formed of many cells which are ciliated on the side next the lumen. These cilia as well as the "flame" drive fluids within the lumen to the exterior. It is probable that these fluids are transuded body fluids containing nitrogenous waste substances which first appear as vacuoles in the flame cells and then discharge into the lumen of the tubule (FIG. 19, A)

Meta-nephridia are found among annelids, mollusks, molluscoids, prototracheates, and chordates, while a modified form exists in crustaceans. Typically each meta-

MORPHOLOGY OF ANIMALS

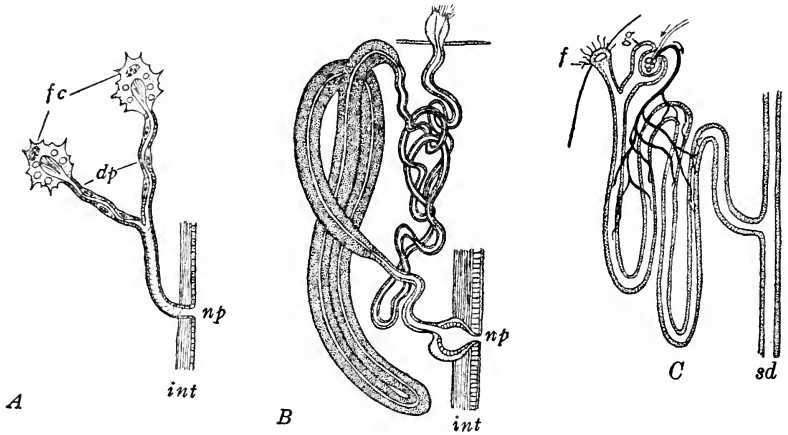

FIG. 19. *Types of Excretory Organs.* A, Protonephridium of flat-worm or rotifer (Acoelomata); *fc*, flame-cells with excretory vacuoles and "flame" of cilia in lumen; *dp*, "drain pipe" cells of tubule; *np*, nephropore opening to exterior; *int*, integument. B, Metanephridium of annelid (Coelomata); *f*, ciliated funnel opening into coelom; *int*, integument. C, Metanephridium (mesonephric tubule) of frog; *f*, ciliated funnel opening into coelom; *g*, glomerulus, containing a plexus of capillaries, between the entering artery and the emerging vein; the latter spreads out over the walls of the tubule; the tubule opens into the segmental duct (*sd*), which empties into the cloaca.

nephridium consists of a tubule opening to the exterior at one end and into the body-cavity (or some portion of it such as the pericardium) at the other (FIG. 20, A). Where it opens into the body-cavity the tubule is widened and covered with long cilia and is known as the ciliated funnel or *nephrostome* (FIG. 19, B and C, *f*). Following this is the glandular portion of the tubule, consisting of a single series of perforated ("drain pipe") cells, and following this is an epithelium, composed of many cells, which form the wall of the lumen. The latter is ciliated throughout, and by the action of these cilia, together with those of the ciliated funnel, coelomic fluid is drawn into the tubule through the funnel and then driven to the exterior. Finally

MORPHOLOGY OF ANIMALS

the terminal portion of the tubule, which is derived as an invagination from the ectoderm, serves as a collecting tube or reservoir (FIG. 19, B). Generally a single pair of these tubules is found in unsegmented animals, such as Mollusca and Molluscoidea; this number may be reduced, however, as in the Polyzoa where they are entirely lacking, or in certain Gasteropoda where one of them is suppressed, or it may be increased as in the case of certain Cephalopoda (Tetrabanchia), where two pairs are present. In segmented animals, such as annelids, prototracheates, and chordates, it is probable that originally one pair existed in every somite, and this is still approximately the case in some of the simpler members of these phyla (FIG. 20), while in higher forms they are limited to certain segments and have disappeared from others (FIG. 21). The segmental character of these organs is so characteristic in the phyla last named that they are called *segmental organs*.

Kidneys of Chordata; Pronephros. In the Chordata these organs undergo modifications which deserve especial mention. They lie in the dorsal portion of the body-cavity on each side of the notochord. Only in Amphioxus do they open individually to the exterior; in other chordates the peripheral ends of the tubules unite on each side of the body into a duct which extends backwards and opens into the cloaca near the anus; this is the *segmental duct* (FIG. 20, B). This earliest system of segmental tubules in chordates is known as the *pronephros*, and it extends throughout the entire trunk of the lowest vertebrates (cyclostomes), though in all higher forms it is limited to a few anterior somites just back of the head (hence called

MORPHOLOGY OF ANIMALS

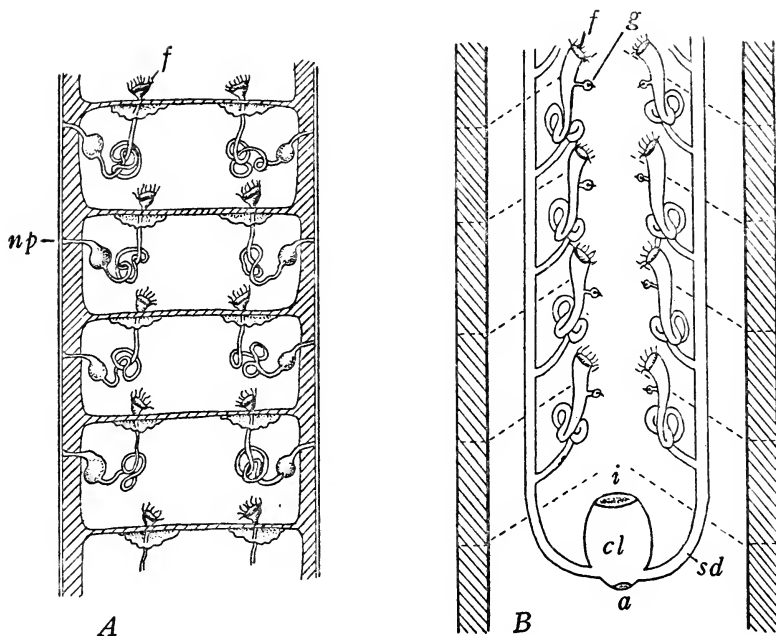

FIG. 20. Diagrams of Excretory System in Annelid (A) and in primitive Vertebrate (B); *f*, ciliated funnel; *g*, glomerulus; *np*, nephropore; *sd*, segmental duct; *cl*, cloaca, cut off from the intestine at *i*; *a*, anus. (After Semper).

“head kidney”) and is usually a purely embryonic organ (FIG. 21, A).

Mesonephros. In all vertebrates above the cyclostomes longer and more complicated tubules are formed in the somites behind the pronephros, which also open into the segmental duct at one end and into the body-cavity at the other. Near the ciliated funnel a knot of blood vessels forms on the side of the tubule and infolds its wall; this is the *glomerulus* or Malpighian corpuscle (FIG. 19 C, *g*). Many of the tubules in this region then lose their ciliated

MORPHOLOGY OF ANIMALS

funnels and no longer open into the body-cavity, the fluid which passes through the tubule being transuded plasma from the glomerulus; at the same time the single pair of tubules originally present in each somite may give rise to others by budding, so that several may be found in each somite. This second edition of the nephridial system of vertebrates is known as the *mesonephros*, and it is the permanent excretory organ of fishes and amphibians (FIG. 21, C), while it is only an embryonic organ in reptiles, birds and mammals (FIG. 21, B, *mes*).

Metanephros. Finally, in the last-named classes, the definitive kidney or *metanephros* appears in several of the somites posterior to the mesonephros (FIG. 21, D, E, *met*). Its tubules, while similar to those of the mesonephros, are still more complex, having no trace of a ciliated funnel, and by budding, very many of them are formed in each somite. The duct into which they open is called the *ureter* (FIG. 21, D, E, *u*), and it is an outgrowth from the segmental duct. It is thus to be seen that the very complex excretory system of vertebrates can be derived, step by step, from the simple nephridial system of such invertebrates as the annelids.

The stage of development of the kidney system in

KIDNEY SYSTEM	PRONEPHROS	MESONEPHROS	METANEPHROS
Fishes Amphibia	In embryo	In adult	—————
Reptiles Birds Mammals	In early embryo	In later embryo. Transformed into sex ducts in adult male	In adult

MORPHOLOGY OF ANIMALS

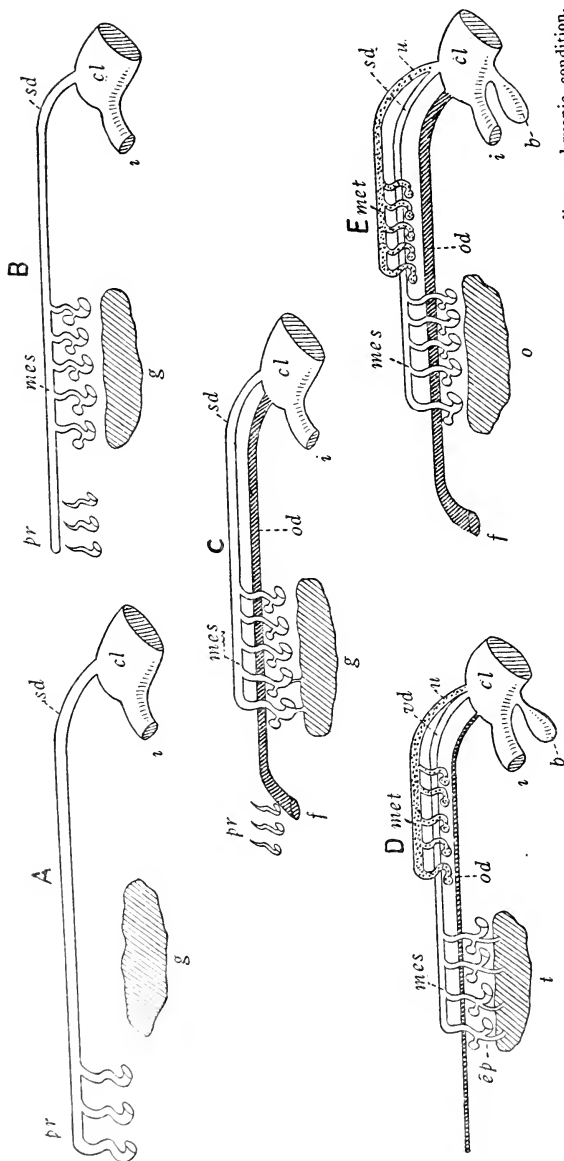

FIG. 21. Diagrams of Urino-genital Systems in Embryos and Adults of different classes of Vertebrates. A, Earliest embryonic condition, with only pronephros (*pr*), segmental duct (*sd*) and gonad (*g*); both segmental duct and intestine (*i*) open into cloaca (*cl*). B, Later embryonic condition; pronephros disappearing, mesonephros (*mes*) taking its place; the remainder as in A. C, Condition in adult Amphibia and later embryos of reptiles, birds and mammals; both male and female organs present; the oviduct (*od*) has split off from the segmental duct and opens into the coelom through a pronephric funnel (*f*); eggs escaping from the ovary (*o*) into the coelom pass into this funnel and down the oviduct; the rest of the pronephros is vestigial; the mesonephros (*mes*) is the functional kidney and in the male some of its tubules enter the testis (*t*) and carry spermatozoa to the segmental duct (*sd*) which carries off both urea and sperm only to carry spermatozoa from the testis (*t*) to the segmental duct which is now the vas deferens (*vd*); the metanephros (*met*) is the definitive kidney and its duct, the ureter (*u*) was split off from the segmental duct; *b*, allantoic bladder. E, Adult Female of Reptiles, Birds, Mammals, mesonephros and segmental duct are vestigial; oviduct well developed; other parts as in D. In Mammals of both sexes the cloaca divides so that the intestine and the urino-genital ducts open separately to the exterior. (After Parker and Haswell).

MORPHOLOGY OF ANIMALS

embryos and adults of different classes of vertebrates is shown in the accompanying table:

Theories of Excretion. There are two conflicting theories as to the method of excretion. (a) *The theory of Heidenhain* holds that the cells of the nephridial tubules take urea out of the surrounding blood capillaries and pass it into the tubules, while the fluid which comes through the ciliated funnels or glomeruli merely flushes out the tubules. Excretion on this theory consists in *selection of urea* by the cells of the tubules. (b) *The theory of Ludwig* maintains that fluids containing urea pass into the tubules through the funnels or glomeruli and the cells of the tubules then take up pure fluid from the tubules and pass it back into the surrounding capillaries. The cells of the tubule therefore merely *concentrate the solution of urea* in the tubules. The latter theory is the more probable.

Excretory Ducts as Sex Ducts. Finally, the nephridia may carry off from the body-cavity not only coelomic fluid, but also cells which are set free into this fluid; some of these cells in the annelids may be loaded with urates which are thus carried to the exterior (chlorogogue cells), but the most important of the cells which thus escape from the coelom are the sex cells, ova and spermatozoa. The excretory ducts may be especially modified for carrying off these sex cells, in which case they are known as *gonoducts*. Even among the vertebrates the oviducts and spermiducts are derived from the nephric system. In some vertebrates the oviduct is split off in the embryo from the segmental duct and opens into the body-cavity at its anterior end through a pronephric funnel (FIG. 21, C, f); its

MORPHOLOGY OF ANIMALS

posterior portion may enlarge to form a uterus. The spermiduct is the segmental duct itself (FIG. 21, C, *sd*); in Amphibia it carries off both urine and spermatozoa (FIG. 21, C); in animals above the amphibians, which have a metanephros and ureter, it acts exclusively as a spermiduct (FIG. 21, D). Some of the mesonephric tubules (nephridia) grow into the testes and become the *vasa efferentia* and *epididymis* (FIG. 21, D, *ep*). There is thus an intimate relation between excretory ducts and genital ducts, and therefore these two systems in vertebrates are usually classed together as the *urino-genital* system.

8. Reproductive System

Reproduction among animals is both sexual and asexual: the former occurs among all animals, the latter is limited to the lower forms and to the constituent cells and organs of higher ones.

Sexual Reproduction; Sexes. Sexual reproduction or *amphigony* consists in the union of the nuclei of two cells, the sex cells or gametes, to form a single nucleus or cell, of double origin, the *oosperm* or *zygote*, from which a new individual similar to the parental form develops. If the gametes are approximately equal in form and size their union is spoken of as *conjugation*, if they are very unlike in these respects they are called ova and spermatozoa, and their union is known as *fertilization*. Both conjugation and fertilization occur among the Protozoa, whereas Metazoa reproduce by means of differentiated sex cells, namely ova and spermatozoa. In a few animals ova have the power of developing without previous fertilization, the process being known as *parthenogenesis*. If such de-

MORPHOLOGY OF ANIMALS

velopment without fertilization occurs in larval forms which have not completed their development it is known as *paedogenesis*. In many animals the sexes are separate,—that is, ova and spermatozoa are produced by different individuals, males and females, and the species is *dioecious*; in some cases, however, both kinds of sex cells are produced by the same individual, which is then said to be *hermaphrodite*, and the species is *monoecious*. Separate sexes were probably derived from hermaphrodites by the suppression of female organs in the male and of male organs in the females; in fact each sex has rudiments of the organs of the opposite sex.

Ovaries and Testes. The essential reproductive organs are the *gonads*, or the glands which produce ova and spermatozoa, namely the ovaries and the testes. In sponges the reproductive cells are widely scattered through the mesoderm so that in these animals ovaries and testes cannot be said to exist. In the lowest cnidarians (Hydrozoa) the sex cells are at first widely scattered in the ectodermal epithelium, but they actively migrate to certain portions of the hydroid stem where reproductive buds are being formed, and, aggregating there, form gonads. A similar migration of sex cells into the gonads has been described in several vertebrates. In all higher animals definite gonads are present.

No genital ducts are present in the coelenterates and none are needed, since the sex cells can escape directly into the water in which they live. In animals above the coelenterates the sex cells are mesodermal in origin, and in most cases form a part of the epithelium lining the coelom. In

MORPHOLOGY OF ANIMALS

animals without a true coelom the sex cells arise in tubes or glands the cavities of which may perhaps represent the coelom (FIG. 5, B). In flatworms the gonads, especially the testes, occur in considerable numbers in a single individual (FIG. 11, B). In round worms they are limited to one or two elongated tubes; in rotifers, mollusks, molluscoids, and echinoderms they are confined to one or at most a few sex glands, while in segmented animals they are found in primitive forms in every body somite, though with advancing organization they become limited to a few somites or even to one (FIG. 12, A). In most animals above the coelenterates some form of duct (gonoduct) exists for carrying the sex cells to the exterior; among the flatworms, roundworms, and rotifers these gonoducts are never the protonephridia, though they may possibly represent the coelom of higher animals. In higher forms the gonoducts are usually metanephridia, or modified excretory ducts.

Gonads of Vertebrates. In vertebrates the sexes are separate. A single pair of ovaries or testes is located in the dorsal part of the body-cavity near the kidney (FIG. 21, *g*), but in almost all mammals the testes descend from this position and come to lie outside the abdominal cavity in the *scrotum*, where a lower temperature favors the development of spermatozoa. The ovaries remain in their original position and when the ova in them are ripe they break out into the body-cavity and are then carried to the exterior through the oviducts (FIG. 21, *od*). Spermatozoa of vertebrates never escape into the body-cavity but pass out

MORPHOLOGY OF ANIMALS

through the mesonephric tubules and segmental ducts (epididymis and vas deferens, FIG. 21, D, *cf.*, *vd*).

Semination. In many aquatic animals the ova and spermatozoa escape directly into the water, and there the eggs are fertilized and undergo development; it is probable that in these animals the escape of ova stimulates the males to eject spermatozoa so that both kinds of sex cells are shed at about the same time. In such cases enormous numbers of sex cells are produced and very many are wasted. A slight advance over this condition is found in those animals (frogs, bony fishes, etc.) in which the openings of the male and female ducts are placed close together at the time of shedding of the sex cells; this is known as external copulation. In other cases the spermatozoa only escape from the body, and by means of currents of water they are carried into the body of the female, where they fertilize the ova *in situ*, as in sponges, or they are carried into certain receptacles, into which the eggs also are collected, as in fresh-water mussels. In other animals copulatory organs exist which serve to introduce spermatozoa into the sex ducts of the female, thus increasing the chances for the fertilization of the ova; this is known as internal copulation. In many cases copulation occurs rarely, sometimes but once, and the spermatozoa are stored in a seminal receptacle which opens into or near the oviduct. Internal copulation is a necessity in all land animals and in most parasites, and it also occurs in many aquatic forms (flatworms, round worms, rotifers, gasteropods, cephalopods, annelids, arthropods).

Secondary Sexual Characters. In certain animals the

MORPHOLOGY OF ANIMALS

sexes differ not only with respect to the sexual apparatus but also in many other regards, which are known as secondary sexual characters; when such differences are very marked they constitute what is known as *sexual dimorphism*. In such cases the male is sometimes very degenerate in form, being occasionally only a small fraction of the size of the female and entirely lacking alimentary canal, sense organs, and nervous system (rudimentary males of rotifers, barnacles, etc.).

Asexual reproduction, or monogony, consists in the formation of new individuals by division of an old one. In one-celled organisms and in the constituent cells of higher animals this takes the form of cell division or the partial division of cell aggregates. In the lower Metazoa asexual reproduction is not limited to cell division, but the entire body or portions of it may undergo constriction and subsequent partial or complete division, thus giving rise to new individuals. This division may be into equal parts, in which case it is called *fission*; or into unequal parts, when it is known as budding or *gemmation*. In animals which reproduce both sexually and asexually there is more or less regular alternation of one method with the other; this is known as alternation of generations or *metagenesis*. The alternation of amphigony with parthenogenesis is called *heterogony*.

9. Nervous System

Sensation and coordination are manifestations of protoplasmic irritability, or that capacity of receiving and responding to stimuli characteristic of every cell. Animals, even the simplest, are sensitive to a variety of stimuli,

MORPHOLOGY OF ANIMALS

among which may be mentioned mechanical, chemical, thermal, and electrical, as well as light, gravity, etc. These stimuli acting on the organism, start changes in the protoplasm (impulses) which are transmitted to portions of the body distant from the point first stimulated and call forth the coordinated activities of many different parts. In higher animals there are special sense organs for receiving certain of these stimuli and specialized protoplasmic fibres (nerve fibres) for transmitting impulses, while nerve centers (nerve cells) for coordinating activities appear very far down in the animal scale. In the lowest animals, however, there are neither nervous system nor sense organs, and yet through the irritability of the general protoplasm these functions are performed.

In some of the higher Protozoa there are specialized parts of the protoplasm which serve for receiving and transmitting stimuli, but in the lower forms of this phylum these differentiations are lacking; and of course there are no specialized sensory or nerve *cells* in any protozoan. The same is true of sponges, where none of the cells are differentiated for receiving and transmitting stimuli, i.e., there are no specialized sensory or nerve cells. In all other phyla, however, certain cells of the body are set apart for these particular functions, and the greater the differentiation in these respects the more definite and varied are the sensations, the more swiftly impulses are transmitted to the motor system, and the more complicated are the responses.

The elements of the nervous system are nerve cells and fibres, the latter being merely outgrowths of the former

MORPHOLOGY OF ANIMALS

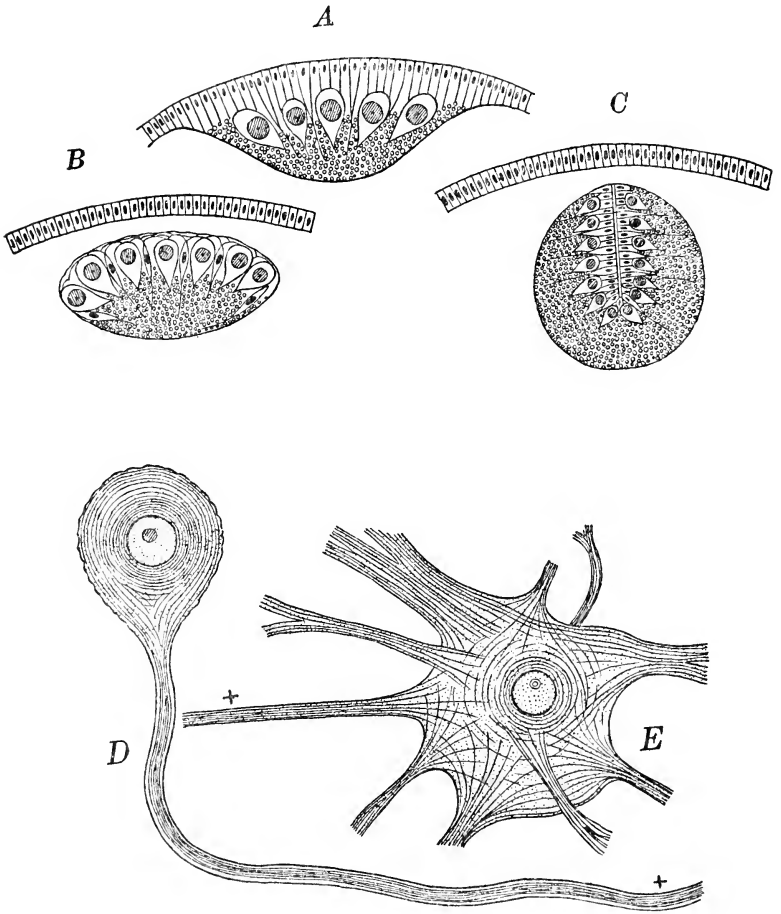

FIG. 22. *Nerve Cells and their Origins.* A, Epithelial nervous system, the five large nerve cells and the many nerve fibers (small circles) being part of the surface epithelium. B and C, Epitheliogenous nervous systems. B, Delaminate Nervous System, the nerve cells and fibers having split off from the surface epithelium; C, Tubular Nervous System, the nerve cells and fibers having folded in and then separated from the surface epithelium. D, Unipolar Nerve Cell of an Annelid with one nerve fiber (+). E, Multipolar Nerve Cell of Electric Ray, the fiber marked + is the neurite or axon, the others are dendrites. (After Hatschek).

MORPHOLOGY OF ANIMALS

(FIG. 22, D, E). A nerve cell with all of its outgrowths is called a *neuron*. In practically all Metazoa these cells are derived from ectoderm, and in a good many animals the sense organs and entire nervous system remain throughout life a part of the superficial epithelium which covers the body (Coelenterata, Chaetognatha, certain Annelida, Molluscoidea, many Echinodermata, Balanoglossus); such a nervous system is said to be *epithelial* (FIG. 22, A). In all other Metazoa the nervous system, though formed from epithelium, separates from it in the process of development, so that brain, ganglia, and nerve trunks come to lie some distance from the surface of the body; this is known as an *epitheliogenous* nervous system (FIG. 22, B, C). In addition to the two classes just mentioned, which are based on the relations of the nerve cells to the body layers, four types of nervous system are found among Metazoa which are based upon the relations of the nerve cells to one another; these are (1) the diffuse type, (2) the linear type, (3) the ganglionic type, and (4) the tubular type.

(1) A *diffuse nervous system*, consisting of nerve cells and fibres scattered throughout the superficial epithelium, is the simplest type known and is found among such animals as hydroids and sea anemones; the nerve cells are here connected together by means of fibres into a nerve plexus.

(2) The next step in increasing complexity is represented by a *linear nervous system* found in jellyfishes, echinoderms, flat-worms (FIG. 11, C); here many nerve cells and fibres are aggregated into definite lines or strands,

MORPHOLOGY OF ANIMALS

thus forming a centralized nervous system; other nerve cells remaining scattered throughout the epidermis serve to connect the nerve strand with the muscles.

(3) *The ganglionic type.* In ctenophores, a sense organ from which nerves radiate, is found at the apical pole (FIG. 2, C, *so*), and in a great many of the higher animals the earliest formed and most generally present portion of the nervous system is a group of nerve cells, or ganglion, which appears at the apical pole of the gastrula, and becomes in the adult the *cerebral ganglion*, or brain, lying on the dorsal side of the oesophagus (FIGS. 3, 11, 12, A). Nerve trunks are always given off from this ganglion, and very generally two of them run down on each side of the oesophagus to its ventral side, thus forming a *circum-oesophageal nerve ring* (FIG. 3, D). In different phyla longitudinal nerve trunks may be given off from different parts of this ring; in the case of annelids and arthropods this ring connects on the ventral side of the oesophagus with the "*ventral nerve chain*," which consists of a bilateral pair of ganglia in each somite connected with those in front and behind by nerve cords. The first one in the chain is the *sub-oesophageal ganglion*, connected with the cerebral ganglion by the circumoesophageal connectives (FIG. 23, A). In the mollusks the nervous system consists of a pair of supra- and sub-oesophageal ganglia (*cerebral* and *pedal*) which with their connectives form an oesophageal ring. To these is usually added a pair of *plural* and *parietal ganglia* forming a loop which extends back into the body, while ventral trunks (*pedal cords*) may be present in the foot (FIG. 13, A).

MORPHOLOGY OF ANIMALS

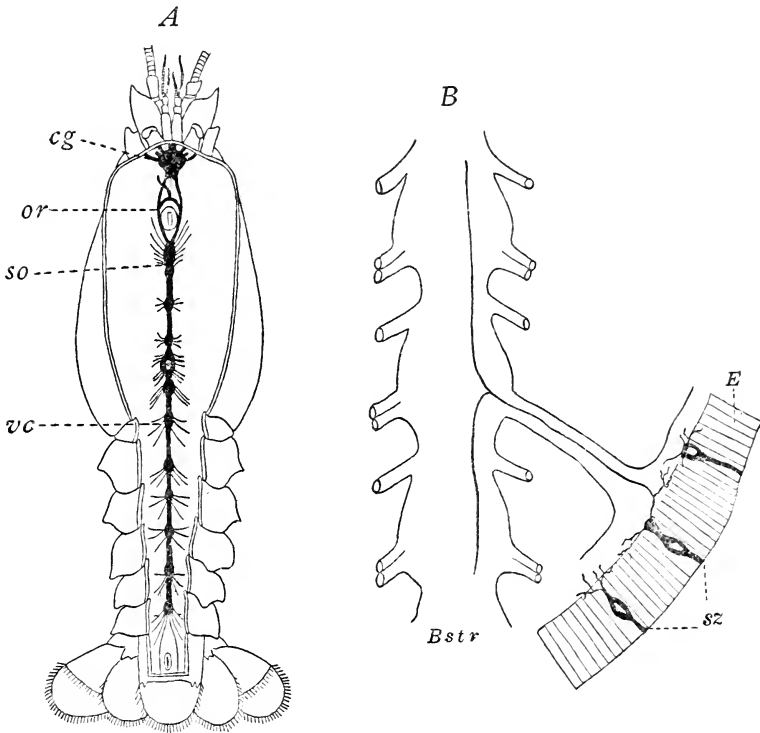

FIG. 23. A, Nervous System of Crayfish, consisting of cerebral ganglion (*cg*), circumoesophageal ring (*or*), sub-oesophageal ganglion (*so*) and ventral chain (*vc*) of 12 ganglia. (After Huxley). B, Sense Cells in Epidermis of Earthworm; E, epidermis; sz, sense cells with fiber running into the ventral chain of ganglia (*Bstr*). (After Heidenhain).

(4) *The tubular type of nervous system* is found only among the chordates; here the nervous system develops from an epithelial plate (*neural plate*) on the dorsal surface of the embryo, which becomes invaginated in such a way as to form a longitudinal groove, the *neural groove*. This then separates from the epithelium as a tube (FIG. 22, C), which in all vertebrates is enlarged at its anterior

MORPHOLOGY OF ANIMALS

end to form the *brain* (FIG. 4, E, *n*). This neural tube, while apparently a continuous structure, is really composed of segments, the *neuromeres*, one neuromere being formed in each body somite; the neuromeres are thus comparable to the ganglia of the ventral chain of arthropods and annelids. This segmentation of the central nervous system of vertebrates, is indicated even in the adult by the segmental arrangement of the *spinal* and *cranial nerves*. In the embryonic development of all vertebrates the brain consists of three enlargements or vesicles, the *fore-brain*, *mid-brain*, and *hind-brain* (FIG. 24, A); the first gives rise to the *cerebrum* and *'tween brain* of the adult, the second remains as the *mid-brain*, while the third gives rise to the *cerebellum* and *medulla* (FIG. 24, C). The portion of the neural tube posterior to the brain becomes the *spinal cord* of the adult. With the differentiation of nerve cells and fibres in the walls of the neural tube these walls increase greatly in thickness, while the originally large cavity of the tube becomes restricted in size, forming in the adult the *ventricles* of the brain and the *central canal* of the cord (FIG. 24, K).

10. *Sense Organs*

The simplest sense organs are the *scattered sensory cells* found in the superficial epithelium of many animals; these may be solitary or aggregated into buds. They are elongated epithelial cells with a hair-like process at the free border and a fibre at the deeper end connecting with the branches of a nerve cell (FIG. 23, B). They are organs of general sensation,—that is, they are capable of receiving

MORPHOLOGY OF ANIMALS

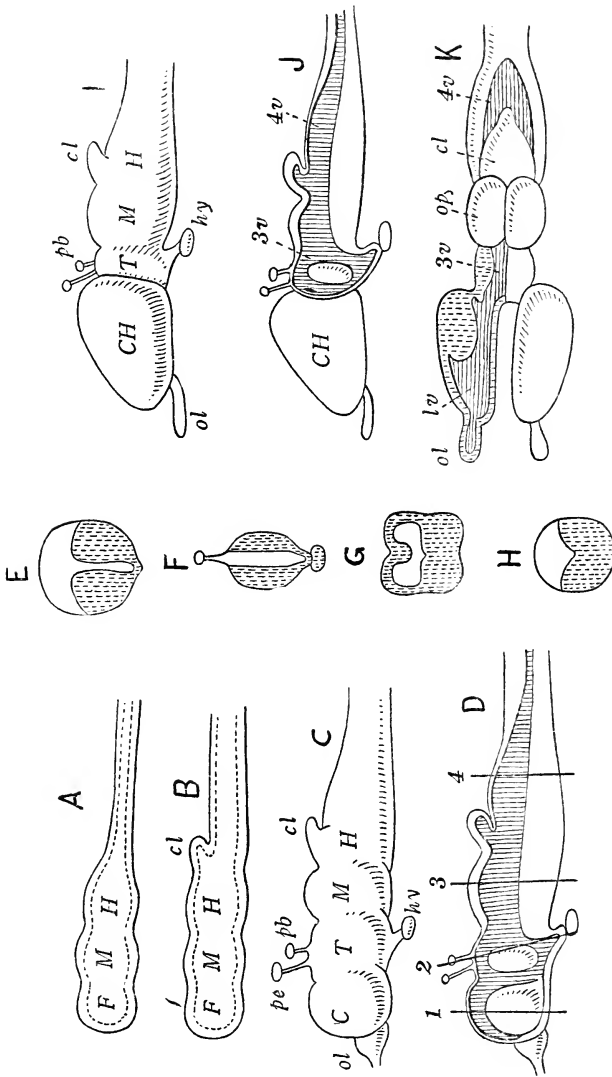

FIG. 24. *Diagrams of Brain of Vertebrates.* A, early embryonic brain; F, fore-brain; M, mid-brain; H, hind-brain. B, Later embryonic brain showing the cerebellum (cl) as a dorsal outgrowth of the hind-brain. C, Older stage; ol, olfactory lobe, C, cerebrum, T, twelve brain (dienecephalon) all derived from the fore-brain (F); pb, pineal eye, pb, pineal body, dorsal outgrowth of twelve brain; kv, hypophysis, a ventral outgrowth of same. D, Median longitudinal section through C, E, Transverse section in plane of 1 in D. F, Transverse section in plane of 2 in D. G, Transverse section in plane of 3 in D. H, Transverse section of I, passing between the two cerebral hemispheres; 3v, cerebral hemispheres (CH); other parts as in C. I, Median longitudinal section of I, passing between the two cerebral hemispheres; 3v, third ventricle; 4v, fourth ventricle. K, Same stage viewed from dorsal side, right half sectioned to show lateral ventricle (lv), third ventricle (3v), fourth ventricle (4v); op, optic lobes on dorsal side of mid-brain. (Modified from Parker and Haswell).

MORPHOLOGY OF ANIMALS

various kinds of stimuli, such as mechanical, thermal, electrical, and chemical, and are therefore largely undifferentiated, though probably chiefly subserving the sense of touch. These integumentary sense organs are found in almost every group of animals. Among the vertebrates they are present in primitive form over the general body surface; in the fishes and amphibia they are aggregated into buds, forming the *lateral line organs*, while among the vertebrates which do not dwell in water, deeper-lying organs, of modified type, are found (*tactile cells, corpuscles, and bulbs*, FIG. 7, *np*). In addition to these organs of general sensation, higher Metazoa generally possess specific sense organs namely, those differentiated for the reception of particular kinds of stimuli. These are organs of (1) smell and taste, (2) equilibrium and hearing, (3) vision.

(1) *Organs of smell and taste* are organs for receiving chemical stimuli; they are present in all vertebrates and in many invertebrates. Their structure is extremely simple, being but slightly modified from the type of the primitive organs described above. In fact the olfactory sense cells of vertebrates are merely scattered sensory cells, while the organs of taste (taste buds, FIG. 25, A) are simply aggregations of such cells. Throughout the Metazoa the organs of taste and smell are generally located in ciliated pits or depressions of the integument either on the head or at least near the mouth or respiratory organs. In these positions they serve in the one case to test food and in the other the quality of the medium used in respiration. Among fishes the olfactory organs are located in pits on the front of the head; in all air-breathing vertebrates these pits open posteriorly into the mouth-cavity or pharynx, and thus form the anterior part of

MORPHOLOGY OF ANIMALS

A

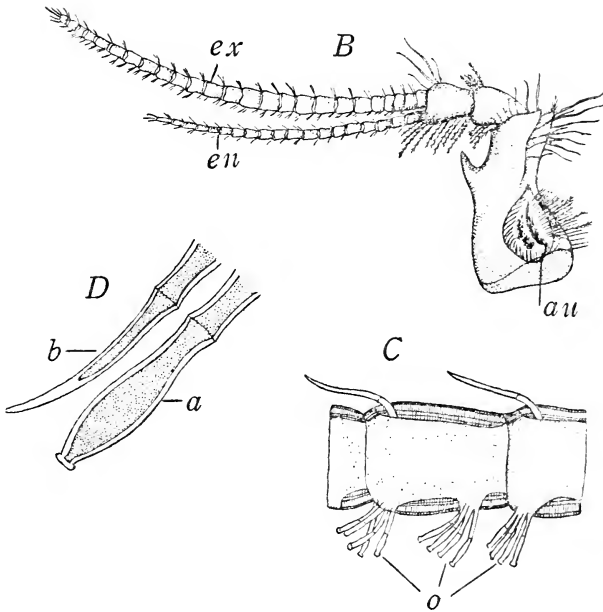
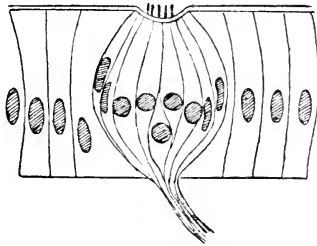

FIG. 25. *Organs of Taste and Smell.* A, Taste bud in epithelial layer. B, Antennule of Crayfish, *au*, auditory sac on basal joint; *ex*, exopodite; *en*, endopodite. C, Portion of exopodite bearing many hollow, olfactory hairs (*o*). D, Olfactory hairs much enlarged, *a*, face view; *b*, side view. (After Huxley).

MORPHOLOGY OF ANIMALS

the respiratory tract. The organs of taste are, of course, in or near the mouth. Among the mollusks a sense organ which is probably olfactory in function, the *osphradium*, is located near the gills. Among the arthropods we find notable modifications of these organs owing to the fact that the entire body-surface is there covered with an impermeable chitinous coat. These sense organs are here peculiar hollow tubes or cones, which are borne on the anterior portion of the body, usually on the antennae and mouth parts; these hairs are filled with fibrillar protoplasm which connects with sense cells at the base of the hair (FIG. 25, B, C, D).

(2) *Organs of hearing and equilibration* are differentiated for the reception of vibratory or mechanical stimuli; they are very widely represented throughout the animal kingdom. It is advisable to consider these two organ systems together, since the two functions which they subserve are united in the same general organ in the vertebrates, while in lower forms it is by no means easy to distinguish between the two. It has long been customary to speak of all vesicular sense organs containing free solid bodies as auditory in function, but it is much more likely that in the lower Metazoa they serve to acquaint the animal with its bodily positions,—that is, that they are organs of equilibration; they are *statocysts* rather than *otocysts*.

Statocysts. In many respects the simplest type of organs of this class is found among certain jellyfishes. It here consists of a short tentacle situated in a depression of the ectoderm and bearing a solid body or *statolith* near its free end; by the movement of the tentacle the hairs or protoplasmic processes of surrounding sensory cells are stimulated (FIG.

MORPHOLOGY OF ANIMALS

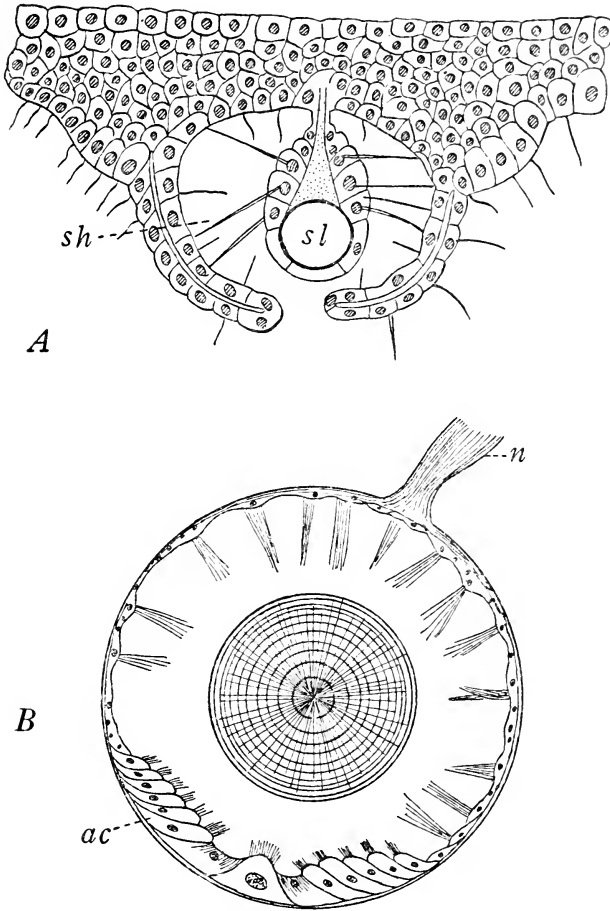

FIG. 26. *Statocysts*. A, of Jellyfish, *sl*, statolith, *sh*, sensory hairs. (After Hatschek). B, of Gasteropod; *ac*, auditory cells; *n*, nerve. (After Claus).

MORPHOLOGY OF ANIMALS

26, A). In other jellyfishes the sensory cells may entirely enclose the tentacle, thus forming a vesicle or statocyst. The organs of equilibration and hearing of most vertebrates, as well as of most invertebrates, can be traced back to this simple type. The sensory cells forming the walls of the statocyst are similar to tactile cells,—that is, they bear processes projecting into the cavity of the statocyst (FIG. 26, B). By the movements of the statolith, usually a calcareous concretion, these cells are stimulated and the impulses thus generated are conveyed away by the nerve fibre. Statocysts of this type are possessed by mollusks, certain annelids, turbellarians, and brachiopods.

Arthropod Statocysts and Ears. In the case of arthropods organs of a different type are usually found, owing to the fact that the body is here covered with chitin and that the fine protoplasmic processes or cilia are absent. Among the higher crustaceans the auditory organ usually consists of a cavity in the basal joint of the first antenna (FIG. 25, B), which is open to the exterior and which contains water and grains of sand; the wall of the cavity bears chitinous processes or auditory hairs which have a nervous connection at their base; these hairs are stimulated by the movement of water and sand within the auditory sac. Many insects have a true tone-perceiving organ, the *chordotonal organ*; in principle this consists of a few elongated cells, the chord, one end of which is attached directly to the integument, while a ligament runs from the other end to an opposite point of the integument; when this apparatus is thrown into vibration, impulses are conveyed to the nerve cells attached to some portion of the chord. In other insects (Orthoptera) a

MORPHOLOGY OF ANIMALS

tympanal organ may be present, consisting of a vibrating membrane overlying a tracheal chamber (FIG. 15, A, *t*): sense cells are present between the membrane and chamber, and when the membrane is set into vibration by sound waves the sense cells are stimulated.

Lateral Line Organs. Among aquatic vertebrates (fishes and amphibians) a system of integumentary sense buds is found along the right and left sides of the body and over the head, which is known as the *lateral-line system*. The function of these organs is to receive vibrations of low frequency such as waves in water; probably they are organs also of equilibration. In all vertebrates it is probable that the auditory organs, as well as the organs of smell and taste, have been derived from integumentary sense organs homologous with those of the lateral line.

The Vertebrate Ear. In the process of development the ear of vertebrates appears as a pit-like invagination of the skin which is then infolded to form a vesicle; this vesicle then becomes partly divided into two chambers, the *utricle* and the *sacculle*. In most vertebrates the former bears three pairs of *semi-circular canals* which are organs of equilibration, while the latter gives rise to a recess, the *lagena*, or *cochlear duct*, which is the specific auditory organ. Calcareous concretions or otoliths are frequently present in the utricle (FIG. 27, A). These sensory portions of the auditory organ are known as the *inner ear*; to this is added in all animals above the frogs and toads a *middle ear* or *tympanum* which develops out of the first gill cleft and which transmits the sound waves from the surface to the inner ear. Finally, in mammals there are folds of the integument around the

MORPHOLOGY OF ANIMALS

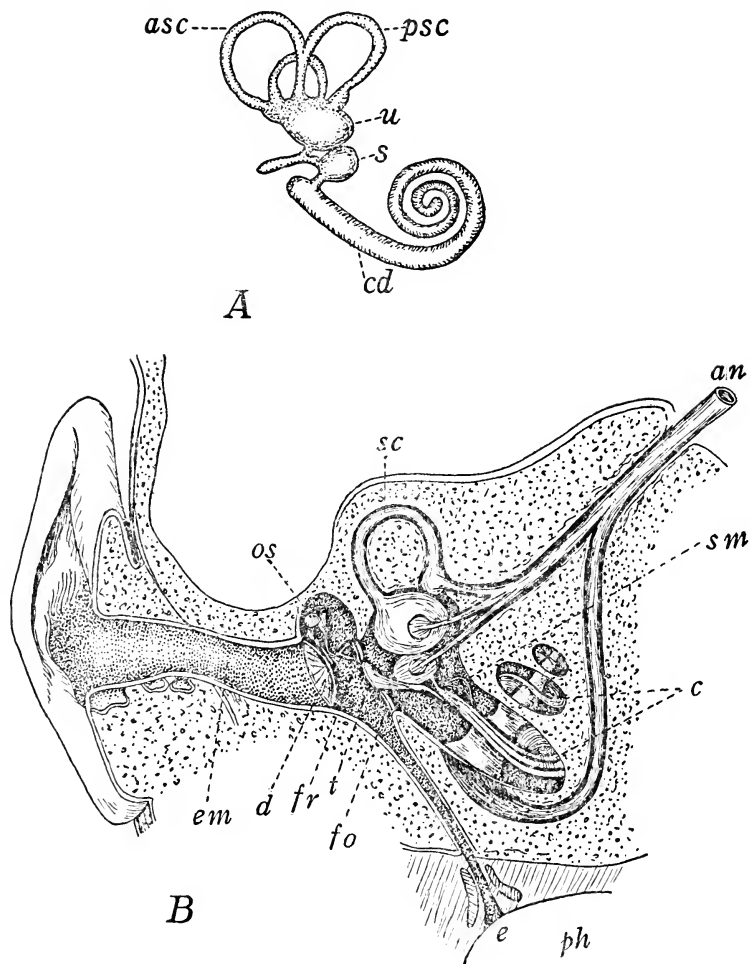

FIG. 27. *Human Ear.* A, Internal Ear, sensory portion, infolded from ectoderm of embryo; *u*, utricle; *s*, saccule; *cd*, cochlear duct; *asc*, anterior-vertical semi-circular canal; *psc*, posterior-vertical semi-circular canal. B, Section through Ear; *em*, external auditory meatus; *d*, ear drum; *os*, 3 ossicles or chain of bones across tympanic chamber, *t*, *e*, eustachian tube; *ph*, pharynx; *fr*, foramen rotundum; *fo*, foramen ovale; *sc*, vertical semi-circular canal; *c*, cochlea; *sm*, scala media or cochlear duct; *an*, auditory nerve. (After Tschermak).

MORPHOLOGY OF ANIMALS

tympanic membrane which serve to collect sound waves and which constitute the *external ear* (FIG. 27, B).

(3) *Visual Organs* are differentiated for the reception of light stimuli. Animals without any trace of eyes are sensitive to light (certain protozoans, annelids, many larvae), and it is therefore certain that protoplasm may be directly stimulated by light without the intervention of any special organ. In its simplest form an eye consists of one or a few transparent cells partially surrounded by pigment in the form of a cup, so that the light can enter only from one side; the pigment not only absorbs light rays, but it optically isolates the cells within from those without this cup (some jellyfish, turbellarians, annelids). The function of such an eye is probably to determine the direction of light, since it could give no image of luminous objects. A slight advance over this simplest type of eye is found in the cup-shaped eyes of certain mollusks; here certain superficial epithelial cells are infolded to form a cup; some of these cells are deeply pigmented, while other intermediate cells remain clear and unpigmented. The latter are the sensory cells and are connected at their bases with nerve fibres. If this cup-shaped eye becomes infolded still further and its opening grows smaller, it forms a "pin-hole camera" type of eye (Nautilus, Haliotis, FIG. 28, A).

Vesicular Eyes. If the optic cup finally closes altogether, it forms a *vesicular eye* such as is present in certain mollusks and annelids. The wall of this vesicle, which is turned toward the epidermis, is transparent and may become thickened to form a *lens*; the opposite wall of the vesicle is pigmented and is known as the *retina*. In such an eye the free ends of

MORPHOLOGY OF ANIMALS

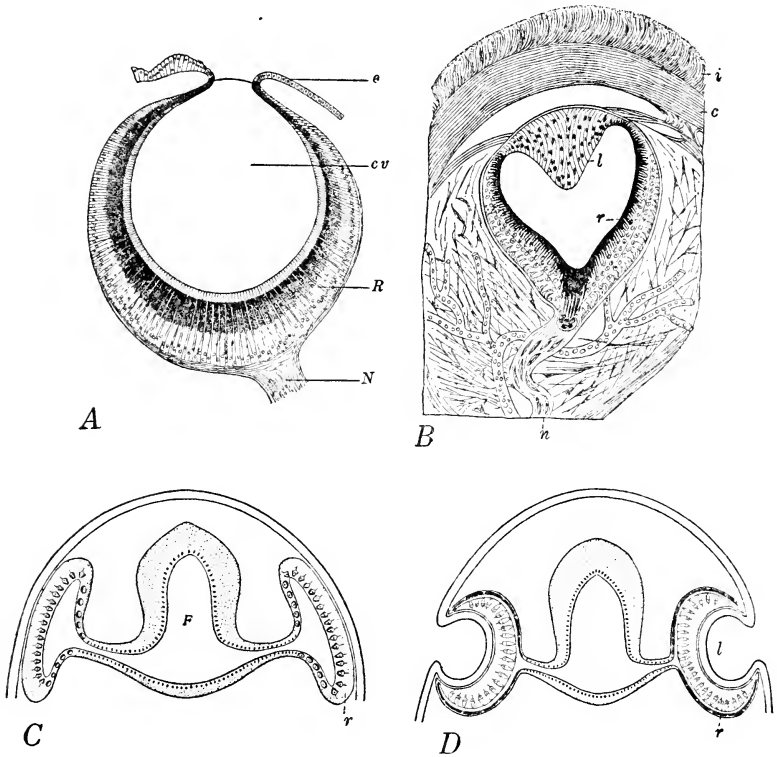

FIG. 28. *Types of Eyes.* A, Eye of *Haliotis* (Mollusk) of "pin-hole camera" type; e, epidermis; cv, cavity of eye; R, retina of direct type; N, optic nerve. (After Hatschek). B, Pineal (unpaired) eye of a lizard (*Hatteria*); i, integument; c, connective tissue capsule; l, lens; r, retina; n, nerve. (After Parker and Haswell). C and D, Diagrams of two stages in formation of paired eyes of vertebrates. C, evagination of optic vesicles from fore-brain. D, invagination of epidermis into optic vesicles to form lens, l, and infolding of retina, r, which thus becomes inverse. (After Boveri).

the retinal cells are turned toward the cavity of the vesicle, while the opposite ends, which are directed away from the vesicle, are prolonged into fibres; such an eye has a *direct retina*. This type of eye reaches its highest development among the cephalopods, where it bears a striking, though

MORPHOLOGY OF ANIMALS

superficial, resemblance to the vertebrate eye. A rudimentary eye of this type is present in some vertebrates as the *pineal* eye. This is an unpaired structure on the dorsal side of the 'tween brain, and in certain reptiles it is plainly a vesicular eye with direct retina (FIG. 28, B).

The paired eyes of vertebrates are also vesicular, but in them the *retina is inverse*, that is, the free ends of the retinal cells are directed away from the cavity of the vesicle, while the ends which bear the fibres are directed towards it. The explanation of this remarkable condition is found in the study of the development of these eyes. They arise as lateral evaginations of the walls of the embryonic fore-brain, are then constricted from the brain, and become vesicles connected with the fore-brain by only a stalk. At this stage the vertebrate eye is like the invertebrate one save only that it has arisen from the neural instead of the superficial epithelium. All the cells which form the vesicle have their free ends directed toward its cavity, while their basal ends are directed away from it (FIG. 28, C). The outer wall of this optic vesicle is then infolded until it comes into contact with the inner wall, thus forming a cup open toward the skin. The ectoderm over the opening of the optic cup is then infolded to form the *lens*, which completely separates from the skin and lies in the mouth of the cup. The infolded wall of the cup alone forms the retina, and therefore the free ends of the retinal cells are directed away from the lens and from the cavity of the cup (FIG. 28, D). The lens and optic cup are then surrounded by fibrous and vascular coats, the *sclerotic* and *choroid*; a chamber is formed in front of the lens which is filled with aqueous humor, while one behind the

MORPHOLOGY OF ANIMALS

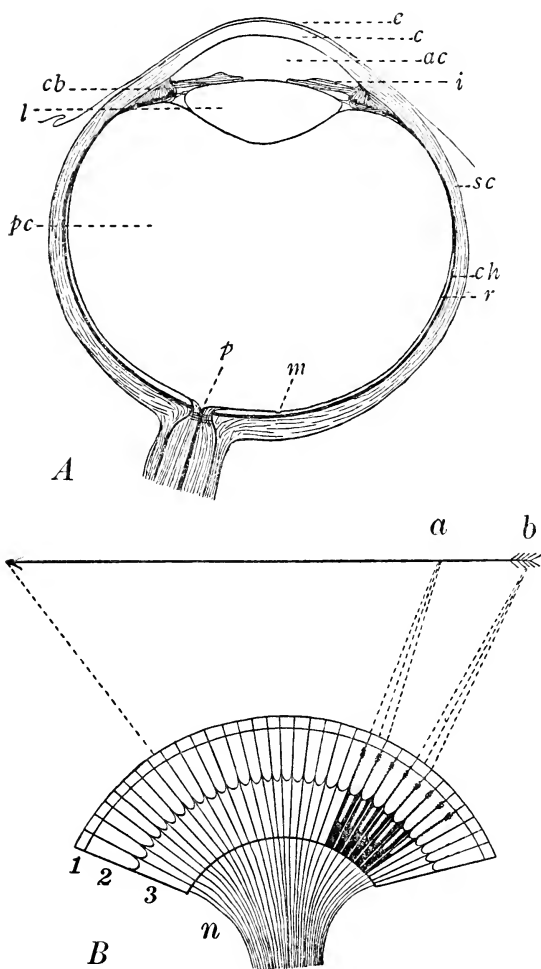

FIG. 29. A, Human Eye, horizontal section; *e*, corneal epithelium; *c*, cornea; *ac*, anterior chamber; *i*, iris; *cb*, ciliary body; *l*, lens; *pc*, posterior chamber; *p*, blind spot at point of entrance of optic nerve; *m*, macula, point of clearest vision; *r*, retina; *ch*, choroid; *sc*, sclerotic coats. B, Compound Eye of Arthropod, composed of many individual eyes or ommatidia; *1*, layer of corneae; *2*, crystalline cones; *3*, retinulae, or sensory layer; *n*, nerve. Dotted lines indicate that each ommatidium receives light from only a small part of the arrow, thus constituting mosaic vision. (After Hatschek).

MORPHOLOGY OF ANIMALS

lens and in front of the retina is filled with vitreous humor (FIG. 29, A).

The compound eye is another type found chiefly among arthropods. It consists of a large number of closely packed single eyes or *ommatidia*, each of which is surrounded by pigment and is optically isolated from the others. Each ommatidium consists of (1) a polygonal *cornea* at the surface, (2) a *crystalline cone* below this, and (3) the *retinula* or group of retinal cells which are connected with nerve fibres. The cornea and crystalline cone are refractive and serve in the capacity of a lens, while the retinula alone is the sensory element (FIG. 29, B).

A summary of the Morphology of Animals is given in the appended Table.

Morphology of Animals

CHIEF SUBDIVISIONS OF THE ANIMAL KINGDOM			PRINCIPAL ORGAN SYSTEMS											
SUBKINGDOM	PHYLUM (or TYPE)	SUBPHYLUM	CLASS	1. INTRUMENT	2. SKELTON (INTERNAL)	3. MOTOR	4. ALIMENTARY	5. RESPIRATORY	6. CIRCULATORY	7. EXCRETORY	8. REPRODUCTIVE	9. NERVOUS	10. SENSE	
A. PROTOZOA Without gastric cavity, germ layers or tissues.	I. PHOTOGLOA Entire body composed of a single cell which may be subdivided or joined with others to form a colony.		1. Flagellata (Euglenae)	Cortex.	Lacking	Lacking	Gelatin present or absent	Lacking	General Body Surface	Lacking	Contractile Vacuoles	No special organs	No special organs	Stigmata in some forms.
			2. Infusoria (Paramecium)	Cortex.	Lacking	Lacking	Gelatin and Vacuole	Lacking	General Body Surface	Lacking	Contractile Vacuoles	No special organs	No special organs	No special organs
B. METAZOA With gastric cavity, germ layers and tissues; animals develop from eggs through cleavage, blastula and gastrula stages.	(a) Protozoa With persistent gastrula and with oral, buccal, or buccal-lateral symmetry.	II. SPONGIARIA (Sponges) Fixed forms, chiefly marine. Gastrula attaches by oral pole.	1. Calappa	Endodermal Simple	Endodermal Lacking	Collagenous Sponges	Inhalant Pores, Canals, Gastrocoel, Gastrocoel.	General Body Surface	Mesodermal-Lacunae	Excretory Cells (?)	Scattered Sex Cells No Gonads or Ducts	Lacking	Lacking	
			2. Demospongia (Commercial Sponges)	Endodermal Simple	Endodermal Lacking	Collagenous Sponges	Inhalant Pores, Canals, Gastrocoel, Gastrocoel.	General Body Surface	Mesodermal-Lacunae	Excretory Cells (?)	Scattered Sex Cells No Gonads or Ducts	Lacking	Lacking	Lacking
(b) Heterozoa (= lateral)	(a) Actinostoma Without true oral, buccal, or buccal-lateral symmetry.	III. CNIDARIA Attached polyps, or free medusae.	1. Hydrozoa (Hydra)	Simple	Pericystic	Mesodermal Jelly	Mouth-Enteron-Canals	General Body Surface	Gastrovascular System	Excretory Cells (?)	2-8 Gonads, no Ducts	Epithelial, Scattered or Lateral	Tentacles, Eyes, Statocysts	
			2. Scyphozoa (Jellyfish)	Simple	Pericystic	Mesodermal Jelly	Mouth-Enteron-Canals	General Body Surface	Gastrovascular System	Excretory Cells (?)	2-8 Gonads, no Ducts	Epithelial, Scattered or Lateral	Tentacles, Eyes, Statocysts	Tentacles
(c) Ctenophora Jellyfishes, chiefly marine. 8 meridional rows of swimming plates.	(b) Nemertea	IV. CTENOPHORA Jellyfishes, chiefly marine. 8 meridional rows of swimming plates.	1. Nemertea	Simple	Lacking	Mesodermal Jelly	8 Rows of Swimming Plates	General Body Surface	Gastrovascular System	General Pores (?)	8 Gonads, no Ducts	Epithelial, Scattered or Lateral	Tentacles, Statocysts (Apical Sense Organ)	
			2. Nemertea	Simple	Lacking	Mesodermal Jelly	8 Rows of Swimming Plates	General Body Surface	Gastrovascular System	General Pores (?)	8 Gonads, no Ducts	Epithelial, Scattered or Lateral	Tentacles, Statocysts (Apical Sense Organ)	
(d) Carcinata With cilia which may be limited to perianth cavity.	(a) Nematozoa Round Worms. Mostly parthenitic, with unsegmented bodies covered by dead cuticle.	V. PLATYHELMINTHES Worms flattened dorso-ventrally. Oral pole of material usually on ventral side. Apical pole with tentacles and oral sucker.	1. Platyhelminthes	Ciliated	Basement Membrane	Connective Tissue	Connective Tissue	General Body Surface	Gastrovascular Sys. Lacunae	Protonephridia	2-8 Gonads, Ducts, Copula	Epitheligenous Cerebral Ganglia and Lateral Cord	Eyes, Tentacles, Statocysts (Apical Sense Organ)	
			2. Platyhelminthes	Ciliated	Basement Membrane	Connective Tissue	Connective Tissue	General Body Surface	Gastrovascular Sys. Lacunae	Protonephridia	2-8 Gonads, Ducts, Copula	Epitheligenous Cerebral Ganglia and Lateral Cord	Eyes, Tentacles, Statocysts (Apical Sense Organ)	
(e) Annelida Ringed Worms. Mostly parthenitic, with unsegmented bodies covered by dead cuticle.	(b) Nematozoa Round Worms. Mostly parthenitic, with unsegmented bodies covered by dead cuticle.	VI. ROTIFERA Microscopic animals with head (trochophore) trunk and tail (foot).	1. Rotifera	Hypodermis	Cuticle	Lacking	Trochophore Disk of Cilia, Muscles	General Body Surface	Lacunae	Protonephridia	2-8 Gonads, Ducts, Copula	Cerebral Ganglia and Lateral Cord	Eyes, Ciliated Pits	
			2. Rotifera	Hypodermis	Cuticle	Lacking	Trochophore Disk of Cilia, Muscles	General Body Surface	Lacunae	Protonephridia	2-8 Gonads, Ducts, Copula	Cerebral Ganglia and Lateral Cord	Eyes, Ciliated Pits	
(f) Annelida Ringed Worms. Mostly parthenitic, with unsegmented bodies covered by dead cuticle.	(c) Nematozoa Round Worms. Mostly parthenitic, with unsegmented bodies covered by dead cuticle.	VII. NEMATHELMINTHES Thread Worms. Mostly parthenitic, with unsegmented bodies covered by dead cuticle.	1. Nematodes	Hypodermis	Cuticle	Lacking	Trochophore Disk of Cilia, Muscles	General Body Surface	Lacunae	Protonephridia	2-8 Gonads, Ducts, Copula	Cerebral Ganglia and Lateral Cord	Eyes, Tentacles, Statocysts (Apical Sense Organ)	
			2. Nematodes	Hypodermis	Cuticle	Lacking	Trochophore Disk of Cilia, Muscles	General Body Surface	Lacunae	Protonephridia	2-8 Gonads, Ducts, Copula	Cerebral Ganglia and Lateral Cord	Eyes, Tentacles, Statocysts (Apical Sense Organ)	
(g) Annelida Ringed Worms. Mostly parthenitic, with unsegmented bodies covered by dead cuticle.	(d) Annelida Ringed Worms. Mostly parthenitic, with unsegmented bodies covered by dead cuticle.	VIII. ANNELETA Ringed Worms with segmented bodies, each segment receiving portion of coelom, and of vascular, excretory and nervous systems.	1. Annelida	Hypodermis	Cuticle	Lacking	Trochophore Disk of Cilia, Muscles	General Body Surface	Lacunae	Protonephridia	2-8 Gonads, Ducts, Copula	Cerebral Ganglia and Lateral Cord	Eyes, Tentacles, Statocysts (Apical Sense Organ)	
			2. Annelida	Hypodermis	Cuticle	Lacking	Trochophore Disk of Cilia, Muscles	General Body Surface	Lacunae	Protonephridia	2-8 Gonads, Ducts, Copula	Cerebral Ganglia and Lateral Cord	Eyes, Tentacles, Statocysts (Apical Sense Organ)	
(h) Mollusca Unsegmented animals usually attached by siphon. Coelom of tentacles (Lophophore) around mouth.	(e) Annelida Ringed Worms. Mostly parthenitic, with unsegmented bodies covered by dead cuticle.	IX. MOLLUSCA Unsegmented animals usually attached by siphon. Coelom of tentacles (Lophophore) around mouth.	1. Mollusca	Hypodermis	Cuticle	Lacking	Trochophore Disk of Cilia, Muscles	General Body Surface	Lacunae	Protonephridia	2-8 Gonads, Ducts, Copula	Cerebral Ganglia and Lateral Cord	Eyes, Tentacles, Statocysts (Apical Sense Organ)	
			2. Mollusca	Hypodermis	Cuticle	Lacking	Trochophore Disk of Cilia, Muscles	General Body Surface	Lacunae	Protonephridia	2-8 Gonads, Ducts, Copula	Cerebral Ganglia and Lateral Cord	Eyes, Tentacles, Statocysts (Apical Sense Organ)	
(i) Mollusca Unsegmented animals usually attached by siphon. Coelom of tentacles (Lophophore) around mouth.	(f) Annelida Ringed Worms. Mostly parthenitic, with unsegmented bodies covered by dead cuticle.	X. ARTHROPODA Animals with jointed legs and legs covered in dense coat of chitin, without cilia.	1. Arthropoda	Hypodermis	Cuticle	Lacking	Trochophore Disk of Cilia, Muscles	General Body Surface	Lacunae	Protonephridia	2-8 Gonads, Ducts, Copula	Cerebral Ganglia and Lateral Cord	Eyes, Tentacles, Statocysts (Apical Sense Organ)	
			2. Arthropoda	Hypodermis	Cuticle	Lacking	Trochophore Disk of Cilia, Muscles	General Body Surface	Lacunae	Protonephridia	2-8 Gonads, Ducts, Copula	Cerebral Ganglia and Lateral Cord	Eyes, Tentacles, Statocysts (Apical Sense Organ)	
(j) Mollusca Unsegmented animals usually attached by siphon. Coelom of tentacles (Lophophore) around mouth.	(g) Annelida Ringed Worms. Mostly parthenitic, with unsegmented bodies covered by dead cuticle.	XI. CHLATHROPHORA Small marine animals with body divided into head, trunk and tail; sit on sides of mouth.	1. Chlathrozoa	Hypodermis	Cuticle	Lacking	Trochophore Disk of Cilia, Muscles	General Body Surface	Lacunae	Protonephridia	2-8 Gonads, Ducts, Copula	Cerebral Ganglia and Lateral Cord	Eyes, Tentacles, Statocysts (Apical Sense Organ)	
			2. Chlathrozoa	Hypodermis	Cuticle	Lacking	Trochophore Disk of Cilia, Muscles	General Body Surface	Lacunae	Protonephridia	2-8 Gonads, Ducts, Copula	Cerebral Ganglia and Lateral Cord	Eyes, Tentacles, Statocysts (Apical Sense Organ)	
(k) Mollusca Unsegmented animals usually attached by siphon. Coelom of tentacles (Lophophore) around mouth.	(h) Annelida Ringed Worms. Mostly parthenitic, with unsegmented bodies covered by dead cuticle.	XII. MOLLUSCA Unsegmented animals usually attached by siphon. Coelom of tentacles (Lophophore) around mouth.	1. Mollusca	Hypodermis	Cuticle	Lacking	Trochophore Disk of Cilia, Muscles	General Body Surface	Lacunae	Protonephridia	2-8 Gonads, Ducts, Copula	Cerebral Ganglia and Lateral Cord	Eyes, Tentacles, Statocysts (Apical Sense Organ)	
			2. Mollusca	Hypodermis	Cuticle	Lacking	Trochophore Disk of Cilia, Muscles	General Body Surface	Lacunae	Protonephridia	2-8 Gonads, Ducts, Copula	Cerebral Ganglia and Lateral Cord	Eyes, Tentacles, Statocysts (Apical Sense Organ)	
(l) Mollusca Unsegmented animals usually attached by siphon. Coelom of tentacles (Lophophore) around mouth.	(i) Annelida Ringed Worms. Mostly parthenitic, with unsegmented bodies covered by dead cuticle.	XIII. MOLLUSCA Unsegmented animals usually attached by siphon. Coelom of tentacles (Lophophore) around mouth.	1. Mollusca	Hypodermis	Cuticle	Lacking	Trochophore Disk of Cilia, Muscles	General Body Surface	Lacunae	Protonephridia	2-8 Gonads, Ducts, Copula	Cerebral Ganglia and Lateral Cord	Eyes, Tentacles, Statocysts (Apical Sense Organ)	
			2. Mollusca	Hypodermis	Cuticle	Lacking	Trochophore Disk of Cilia, Muscles	General Body Surface	Lacunae	Protonephridia	2-8 Gonads, Ducts, Copula	Cerebral Ganglia and Lateral Cord	Eyes, Tentacles, Statocysts (Apical Sense Organ)	
(m) Mollusca Unsegmented animals usually attached by siphon. Coelom of tentacles (Lophophore) around mouth.	(j) Annelida Ringed Worms. Mostly parthenitic, with unsegmented bodies covered by dead cuticle.	XIV. CHORDATA Segmented animals with axial skeleton (Notochord), chief axis has of cartilage, neural tube and alimentary canal on ventral side with all organs in the upper lateral wall of pharynx.	1. Chordata	Hypodermis	Cuticle	Lacking	Trochophore Disk of Cilia, Muscles	General Body Surface	Lacunae	Protonephridia	2-8 Gonads, Ducts, Copula	Cerebral Ganglia and Lateral Cord	Eyes, Tentacles, Statocysts (Apical Sense Organ)	
			2. Chordata	Hypodermis	Cuticle	Lacking	Trochophore Disk of Cilia, Muscles	General Body Surface	Lacunae	Protonephridia	2-8 Gonads, Ducts, Copula	Cerebral Ganglia and Lateral Cord	Eyes, Tentacles, Statocysts (Apical Sense Organ)	

*p or a = present in some, absent in others





