



THE LIBRARY
OF
THE UNIVERSITY
OF CALIFORNIA
DAVIS

GIFT OF
JIM HUNT





Digitized by the Internet Archive
in 2007 with funding from
Microsoft Corporation

THE TECHNO-CHEMICAL RECEIPT BOOK:

CONTAINING

SEVERAL THOUSAND RECEIPTS, COVERING THE LATEST, MOST
IMPORTANT AND MOST USEFUL DISCOVERIES IN CHEMICAL
TECHNOLOGY, AND THEIR PRACTICAL APPLICATION
IN THE ARTS AND THE INDUSTRIES.

EDITED CHIEFLY FROM THE GERMAN

OF

DRS. WINCKLER, ELSNER, HEINTZE, MIERZINSKI,
JACOBSEN, KOLLER AND HEINZERLING.

WITH ADDITIONS BY

WILLIAM T. BRANNT,

Graduate of the Royal Agricultural College of Eldena, Prussia,

AND

WILLIAM H. WAHL, PH. D. (HEID.),

Secretary of the Franklin Institute, Philadelphia; author of "Galvanoplastic Manipulations."

Illustrated by Seventy-eight Engravings.

PHILADELPHIA:

HENRY CAREY BAIRD & CO.,

INDUSTRIAL PUBLISHERS, BOOKSELLERS AND IMPORTERS,
810 WALNUT STREET.

LONDON:

SAMPSON LOW, MARSTON, SEARLE & RIVINGTON,

CROWN BUILDINGS, 188 FLEET STREET.

LIBRARY
1889.

UNIVERSITY OF CALIFORNIA

DAVIS

Written by my

Mr. Ed. Corbett
Indianapolis

Indiana

135 ... Street

Copyright by HENRY CAREY BAIRD & Co., 1886.

Ferguson Bros. & Co.,
Electrotypers,
15 N. Seventh Street,
Philadelphia, Pa.

PHILADELPHIA:
COLLINS, PRINTER, 705 JAYNE STREET.

P R E F A C E .

THE principal aim in preparing THE TECHNO-CHEMICAL RECEIPT BOOK has been to give an accurate and compendious collection of approved receipts and processes of practical application in the industries, and for general purposes. The work is essentially what it claims to be—a receipt book; and all theoretical reasoning and historical detail have been omitted. Popular and simple descriptions have, wherever possible, been preferred to technical and scientific language. The materials have been principally derived from German technical literature, which is especially rich in receipts and processes which are to be relied on; most of them having been practically tested by competent men before being given to the public.

In the laborious task of translation and compilation only the best and latest authorities have been resorted to, and innumerable volumes and journals consulted, and wherever different processes of apparently equal value for attaining the same end have been found, more than one has been introduced. Every care has been taken to select the best receipts of each kind, and we are confident that there are few persons, no matter in what business or trade they may be engaged, who will not here find something of use and benefit to them.

In regard to the use of the receipts, the observance of the following rules is recommended: 1. Be careful to use the exact proportions prescribed. 2. Always experiment first with small quantities. 3. Should the first attempt prove unsuccessful, do not condemn the receipt, but make another trial, as the fault can generally be traced to a mistake in the manipulation or an error in the quantities.

The alphabetical arrangement adopted and a very copious table of contents, as well as index, will render reference to any subject or special receipt prompt and easy.

PHILADELPHIA, *June 10th*, 1886.

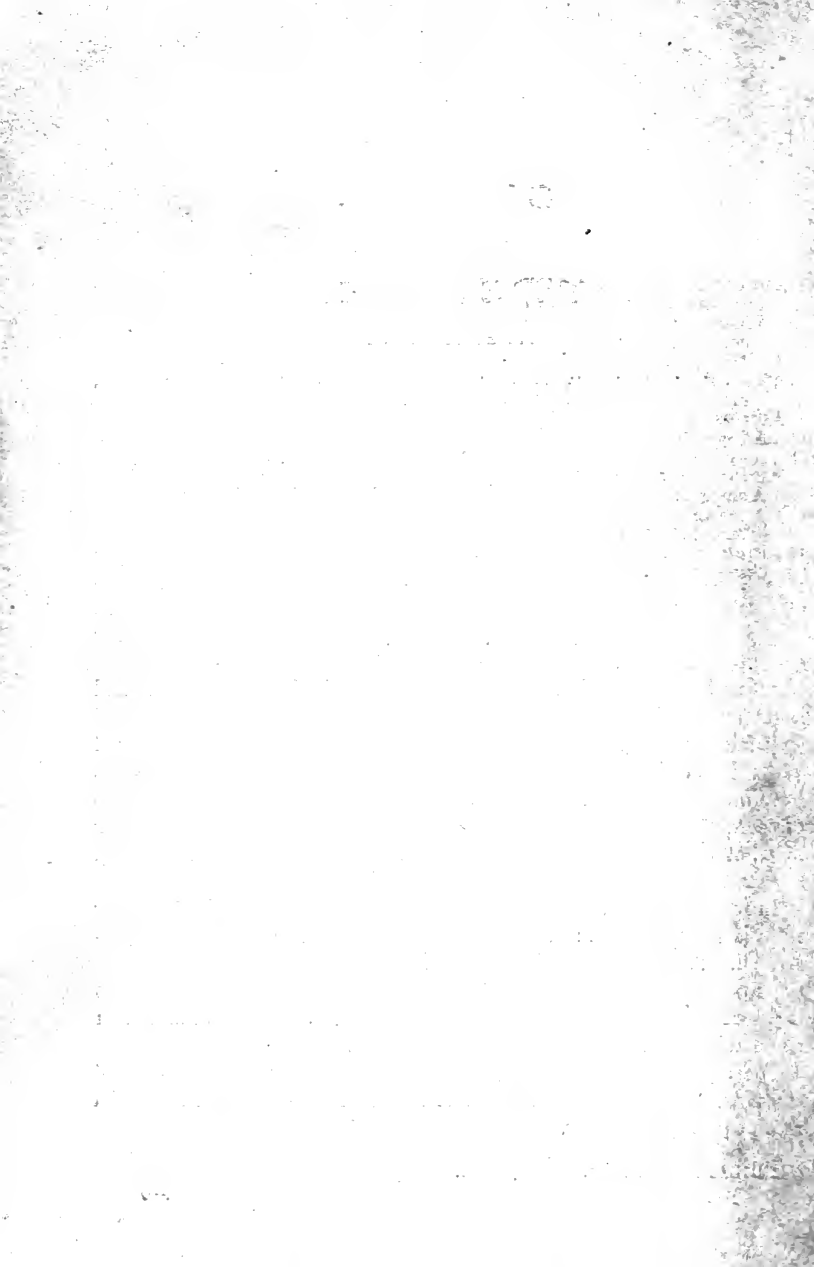

CONTENTS.

ADULTERATIONS, IMITATIONS, ETC. HOW TO DETECT THEM :	
Olive oil ; Animal charcoal ; Determination of percentage of oil in seeds Vinegar, the substances with which it can be adulterated ; Simple process of distinguishing genuine gilding and silvering from imitations ; Milk adulterations ; Adulteration of wax with tallow	1 2
To test dyes for adulterations ; To detect alum in red wine ; Simple method for distinguishing genuine butter from artificial ; Crock's method	3
ALLOYS :	
Alloys for teapots ; Oroide ; Britannia metal ; Alloys for taking impressions of coins, medals, wood-cuts, etc. ; Chrysolite ; Prince's metal ; Pinchbeck ; Robertson's alloy for filling teeth ; Aluminium alloys	3
Aluminium bronzes ; Aluminium alloy for soldering aluminium ; Silver and aluminium alloys ; Gold and aluminium ; Zinc and aluminium ; Tin and aluminium ; Bismuth and platinum ; Lead and aluminium ; Iron and aluminium	4
Tissier, Debray, and Roger on iron aluminium alloys ; American sleigh-bells ; Platinum bronze ; White metal ; Alloys resembling silver ; Nickel alloys ; Alloy of Christophe and Bouilhet ; Lutecine, or Paris metal ; A new and very fusible alloy ; Wood's metal ; Alloy of Lipowitz	5
Type metal ; Alloy for music printing plates ; Spence's metal ; New alloys for journal-boxes ; Alloys for dental purposes ; Manganese bronze	6
Unalterable alloy ; Chinese and Japanese bronzes ; Bronze for objects of art ; Chinese silver ; Composition for metal stop-cocks which deposits no verdigris ; Alloy for anti-friction brasses ; Fenton's alloy for axle-boxes for locomotives and wagons ; English copper alloys ; Brass ; Brass for turned articles	7
Red bronze for turned articles ; Bronzes for castings ; Coin metal ; Metals for gongs and bells ; Bell metals ; Bronze for cocks ; Statuary bronze ; Bronzes for medals, rivets, and ornaments ; New alloy resembling gold ; Alloy resembling silver ; Alloy for imitation gold and silver wires ; Minargent ; Composition of some alloys	8
ARTIFICIAL GEMS, PEARLS, AND TURKISH BEADS :	
Jesem's glass-melting furnace ; Schrader's fluxes	9
Donault-Wieland's flux ; "Strass ;" Ruby ; Splittgerber's receipt for ruby glass ; Sapphire ; Emerald ; Chrysolite	10
Opal ; Beryl, or aqua-marine ; Hyacinth ; Garnet ; Tourmaline ; Topaz and Chrysolite ; Amethyst ; Lapis Lazuli ; Agate	11
Schrader's and Wagner's processes for producing artificial gems ; Coloring substances ; Artificial Pearls, Geissler's process ; Turkish beads	12
BITTERS, CORDIALS, ELIXIRS, LIQUEURS, RATAFIAS AND ESSENCES ; EXTRACTS, TINCTURES, AND WATERS USED IN THEIR MANUFACTURE, AND THE MANNER OF COLORING THEM :	
Mode of coloring cordials, liqueurs, etc. ; Coloring substances	12
Essences, extracts, tinctures, and waters ; Absinthe tincture ; Ambergis essence ; Angelica essence ; Anise-seed essence and extract ; Anise-seed tincture ; Aromatic tincture ; Barbadoes essence ; Bergamot essence ; Bitter almond essences	13
Bitter essences ; Bitter extract for Grünwald bitters ; Calamus tinctures ;	

Caraway essence (Cumin essence); Cardamon extracts; Cherry extract; Cherry water; Chocolate essence; Cinnamon essence; Clove essence; Coffee essence; Cognac essence; English bitters essence; Fennel essence; Gold water essence	14
Herb cordial essence; Juniper berry essences; Lavender essence; Lemon essence; Mace extract; Marjoram essence; Musk essence; Nut essence; Nutmeg essence; Orange-blossom extract; Orange-blossom water; Orange juice; Orange peel extract; Parfait d'Amour essence; Peach essences	15
Peppermint essences; Quince essence; Raspberry extracts; Raspberry water; Rose essence; Rose water; Rosemary essence; Sage essence; Spanish bitters essence; Strawberry extract; Strengthening tincture; Vanilla essence; Vanilla water and tincture; Wormwood essence; Elixir	16
Angel elixir; Elixir de St. Aur; Elixir-Colombat; Elixir of life; Elixir Monpou; Elixir des Troubadours; Elixir vital; Juniper elixir; Tabourey elixir; Bitters, cordials, liqueurs and ratafias; Anise-seed cordials; Anisette cordial; French unisette	17
Holland anisette; Angelica cordial; Aqua Bianca; Aqua reale; Aquaturco liqueur; Aromatic cordial; Ambergris water; Berlin bitters; Bitter Rossoli; Breslau bitter cordial	18
Calamus liqueur; Cardinal water; Cardinal de Rome; Carminative cordial; Capuchin cordial; Chartreuse; Cherry liqueur; Cherry cordial	19
Chocolate liqueur; Christoffe; Citronelle; Crambambuli; Danzig crambambuli; Cumin cordial (Kümmel); Cumin liqueur; Curaçoa; French and Holland curaçoa; Eau Americaine	20
Eau d'Amour; Eau d'Argent; Eau d'Ardelle; Eau d'Absynth Citronné; Eau de Cypre; Eau de Dauphin; Eau de Napoléon; Eau d'Orient; Eau d'Or (Gold water)	21
Eau de Paradise; Eau des Princesses; Eau Precieuse; Eau royale; Eau de Santé; Eau de Sept Graines; English bitters; Greek bitters; Hamburg bitters; Juniper liqueur	22
Koch's herb extract; Maraschino; Mogador; Nectar; Orange peel cordial; Parfait d'Amour; Peach cordial; Peppermint cordials; Polish water; Polish whiskey; Quince cordial (Quittico); Rosemary cordial	23
Rossolio de Turin; Rostopschin; Scubac; Soya aqua vitæ; Spanish bitters; Stettin bitters; Stomach bitters	24
Vienna stomach bitters; Swiss cordial; Thiem's bitters; Tivoli cordial; Trappistine; Vanilla cordial; Véritable extrait d'absinthe; Vienua bitters; Wormwood cordial; Ratafias; Barbadoes ratafia	25
Cocoa ratafia; Citronat-ratafia; Claret ratafia; English bitters ratafia; Fennel ratafia; Ginger ratafia; Ratafia Chinoise (Chinese liqueur); Ratafia de Grenoble; Mulberry ratafia; Orange ratafia; Apple ratafia; Pear ratafia; Stomachic ratafia	26
Celery, Scotch, Vanilla and Wormwood ratafias	27
BLASTING COMPOUNDS, BLASTING POWDER, DYNAMITE, GUN-COTTON, GUNPOWDER, NITRO-GLYCERINE, FULMINATES, ETC.:	
Nitro-glycerine; Mowbray's process of manufacturing nitro-glycerine	27
R. Böttger's process of manufacturing nitro-glycerine; Dynamite and various formulæ of making cellulose dynamite; Lithofracteur; Dittmar's dualin; New dynamite by Anthoine & Genaud; Carboäzotine	29
Brise-rocs; Pudrolith; Pyrolith; Trets' blasting powder; Frozen dynamite; Augendre's white powder; Hafenegger's gun and blasting powder	30
Dr. Borlinetto's gunpowder; Sharp & Smith's patent gunpowder; Spence's powder for cannon of large calibre; Non-explosive powder; Green's blasting powder; Giant dynamite; Blasting compound from potato-starch	31
Martinsen's new blasting powder; To protect blasting agents containing	

nitro-glycerine and ammonium nitrate from moisture, and to prevent the exudation of the nitro-glycerine; Giant powder; Faure & French's Blasting compound; Gun-cotton; New blasting compounds; Peralite; Jaline; New blasting compound from a combination of honey and glycerine	32
Preparation of blasting compounds by directly nitrating crude tar oils; Gelatinous nitro-glycerine; "Foreite;" Cartridge shells of easily combustible substances; Fulminate of mercury; Fulminate of silver; Fulminating platinum	33
Fulminating gold	34
BLEACHING:	
New method of bleaching cotton yarns, tissues, etc.; Cleansing of cotton and other vegetable fibres; To bleach cotton goods with woven borders; To bleach muslin; Frohnheiser's method of bleaching cotton; To bleach cotton goods; Cotton, bleaching	34
Bleaching of woollen tissues	35
To keep woollen goods white; To bleach wool without sulphur; To make wool bleached without sulphur beautifully white; Bleaching of silk; Hartmann's quick method of bleaching flax yarn	36
To bleach sponges; To bleach and harden tallow; To bleach bristles; To bleach copper plate engravings, wood-cuts, etc.; To bleach shellac	37
To bleach straw; David's new process of bleaching	38
To bleach stained marble	39
BOILER INCRUSTATIONS:	
Receipts to prevent and remove boiler incrustations	39
Alfieri's receipt; Baudet's preventive; Rogers' preventives	40
BONE, HORN AND IVORY—TO BLEACH AND DYE THEM, AND MAKE IMITATIONS AND COMPOSITIONS:	
To bleach bone and ivory; To bleach bones; Hedinger's method of bleaching bones for turners' use; Peineman's process of bleaching ivory turned yellow; To make ivory soft and flexible	40
New process of bleaching ivory and bones; Dyeing of bone and ivory; Receipts for different colors	41
To produce black and colored drawings upon ivory	42
Artificial ivory; Artificial ivory for photographic purposes; New artificial ivory; To bleach ivory articles fastened upon leather, etc.; Compound for buttons, dice, dominos, etc.; A new method of treating horn; To dye horn to resemble tortoise shell	43
Buttons from waste of horn	44
BRONZING AND COLORING OF METALS:	
Green bronzes for brass; Chinese bronze; Bronzing process used in the Paris Mint; Oxidized silver; Antique green	44
Fire-proof bronze upon copper and brass; Commercial bronzes; Bronze for plaster-of-Paris figures; Bronze powders; Copper-colored bronze powder; Moiré metallique	45
Black bronze for brass (R. Wagner); Walker's chemical bronze; Blue bronze; Brown bronze; Gold bronze of great lustre on iron; Steel blue on brass; Black on brass; Red copper-bronze on white sheet tin and tinned articles; To give copper a durable lustre; New method of coloring metals	46
Graham's bronzing liquids for brass	47
Graham's bronzing liquids for copper and zinc; Dead-black on brass instruments; Substitute for gum-Arabic in manufacturing bronze colors; Preservation of bronze monuments	48
BUILDING MATERIALS, ARTIFICIAL BUILDING STONE, MORTARS, ETC.:	
Various formulæ for artificial stone; Artificial building stone; Artificial building stone prepared with cork; Artificial stone from quartz sand and plumbic oxide; E. Schaffer's artificial stone (Elizabeth, N. J.); E.	

E. Westermeyer's artificial stone (Chicago, Ill.); F. Coignet's (Paris); A. Quesnot's (Bloomington, Ill.)	49
Artificial stones of J. Schellinger, New York; Of J. Ordway, Jamaica Plains, New York; Of S. Sorel, of Paris; Of Adolph Ott, New York; "Victoria stone" (Highton's process); Ransome's artificial stone; Apœnite	50
Frear's artificial stone; Building stones, pipes, etc.; Artificial mill-stones; Grindstones; New plastic water-proof grindstones; To imitate variegated marble; A. Garvey's, of Memphis, Tenn., "lithomarlite;" Artificial marble; Cement from blast furnace slag	51
Very hard and durable cement; To manufacture cement from blast furnace slag; To prepare white cement; To prepare artificial cement; To harden cement, lime, and similar materials; Oil cement paint for felt roofing; Requisites for good mortar	52
Hydraulic mortar from lime and alum shale; Bitumen mortar; Hydraulic mortar; Water-proof mortar; To prepare clay plaster; Plaster for damp walls; Treatment of asphaltum for paving purposes; Marble-izing sandstone	53
To make sandstone and other porous stones tough and impermeable; To repair worn-down sandstone steps; Concrete marble; To make wood almost incombustible; To dry damp walls; Lyons asphaltum	54
To make glass roofs water-tight; To preserve wood; Bricks, size and weight of; Making brick masonry impervious to water	55
COCOA AND CHOCOLATE:	
Machines required for manufacture of chocolate	55
Receipts for ordinary and spiced chocolate	56
Receipts for fine Spanish spiced, for Vienna, Paris, Milan, Hygienic, and Iceland moss chocolates; Chocolate with meat extract; Iron chocolate; Chocolate with carbonate of iron; Racahout des Arabes; Dr. Koeben's nourishing and healing powder	57
Vakaka indorum; Palamaud or Palmgrène or allataim du harem; white chocolate	58
CELLULOID, CAOUTCHOUC, GUTTA-PERCHA, AND SIMILAR COMPOSITIONS:	
Preparation of celluloid; Treatment of pyroxyline in the manufacture of plastic masses	58
How to work and treat celluloid; New celluloid; Manufacture of rubber stamps	59
To soften rubber hose after it has become hard; Metalized caoutchouc; To remove stickiness from the surface of dried caoutchouc; Cement for vulcanized caoutchouc; Utilization of vulcanized caoutchouc waste; Gutta-percha composition; To color caoutchouc and gutta-percha black or green; Solution of gutta-percha for shoemakers; Caoutchouc compositions for sharpening and polishing knives, etc.	60
Caoutchouc cements for glass; Cement for rubber shoes and boots; Gutta-percha cements for glass, leather, and rubber combs; Elastic gutta-percha and linseed oil cement; Gutta-percha cement for horses' hoofs; Substitute for caoutchouc	61
Substitute for gutta-percha; Compositions for ornaments, busts, toys, etc.; and for rollers of wringers and washing machines; Asbestos and rubber packing; Composition for billiard balls; and for picture frames; A masses for toys, vessels, etc., and for dolls' heads	62
Marmorin; New mass for hollow articles; Papier maché from flour; Fine pasteboard mass for moulding large figures; Composition for razor strops	63
CEMENTS, PASTES, AND PUTTIES:	
To cement iron to iron; Mastic cement; Cement for steam-pipes, for glass retorts, and for porcelain; Water and fireproof cement for metal, porcelain, and earthenware	63

Cements for fastening metal letters upon glass, marble, wood, etc.; Cement for fastening iron articles in stone; Cement for stone troughs and wooden vats; Cement for repairing articles of sandstone; Davy's universal cement; Cements for joining leather driving belts, for fastening rubber upon metal, for aquaria, and for repairing defective places in castings.	64
Cement for leather; Glycerine cement; Cement for petroleum lamps, for tortoise shell, for ivory and bone; Caseine cements; Chinese blood cement; Blood and ash cement	65
Jewellers' cement; Armenian glue; Cement for quickly closing leaky places in barrels; Cement for iron stoves; To prepare liquid glue; Liquid glue; Glues for labels, for fancy articles, fine leather goods, etc.; Water-proof glue for wooden utensils; Glue for ivory and bone; Glue for joining glass to wood; Diamond glue of the best quality	66
Chromium glue; Mouth glues; Lime putty and French putty for wood; Powdered wood, oil, and glue putties; Putty for floors of soft wood; Putty for floors which are to be scrubbed, and for floors which are to be lacquered	67
Paste for wall-paper; Paste for microscopic objects; Glycerine glue for microscopic preparations; Paste for postage stamps; Sugar and lime paste; Fluid paste; Dry pocket paste; Good cements for filling teeth.	68
Cement for injured trees; German tree wax and grafting wax; Durable paste; Paste for fixing printed labels on machines; Safety pastes for post-office packages	69
CHEMICAL AND TECHNO-CHEMICAL EXPEDIENTS, PREPARATIONS:	
Johnson's process and apparatus for manufacturing potassium ferrocyanide; Phosphorescent (illuminating) powder; To thaw frozen ground	70
Artificial sandstone for filtering; To prepare tincture of litmus; New method of extracting tannin	71
Process and apparatus for purifying water with a mixture of caustic magnesia or carbonate of magnesia and saw-dust; Caustic potash; Caustic soda; Pure chlorine gas; Chloride of zinc	72
Chloride of gold; To prepare pure oxalic acid; To prepare purified oleic acid; Cream of tartar; Lunar caustic; Pure acetic acid; Sulphocyanic acid; Molybdic acid from molybdenum di-sulphide	73
Potassium acetate; To prepare sulphate of copper; Liver of sulphur; Schiel's apparatus for testing the percentage of nicotine in tobacco; Wilson's process of preparing glycerine; To restore faded manuscripts.	74
CLEANSING, POLISHING, AND RENOVATING AGENTS:	
To remove ink stains from wood; Ink and rust stains from clothes; Mildew, wine, or fruit stains from silk or linen; Tar, grease, oil, and varnish from silk; Ink stains from silk; To remove wax from velvet; Grease stains from paper; Scouring water for removing grease stains; Le François scouring fluid; "Gantein" for cleansing gloves	75
To cleanse glasses and saucers; Longet's polishing powder for gold workers; To cleanse glass vessels; To cleanse manilla indigo; To cleanse files; To cleanse paint brushes from dried-in paint; To cleanse steel and iron from rust; To cleanse barrels; Polishing powder for glass and metal; To cleanse straw hats; Scouring soaps	76
To purify bisulphide of carbon; Polishing powder for plate glass, mirrors, etc.; Polishing rags and polishing paste for metals; Wabeck's polishing wax; Fine jewellers' rouge; To remove stains from books; To free paper from fatty substances	77
To cleanse gloves without wetting them; To cleanse tea and coffee trays, marble busts, alabaster, and precious stones; To cleanse and beautify old oak furniture; To cleanse brass and silver; Polishing powder for silverware, gold, etc.; Magnus' patent polish for slate	78

COLORED CHALKS, CRAYONS, PENCILS, AND INKS FOR MARKING LINEN, ETC. :	
Blue chalks; Colored crayons; Pencils for writing on glass, and for marking linen; Marking-ink for linen	79
New marking ink; Colored indelible inks; Blue stamp color	80
CONFECTIONERY :	
To prepare elaeosaccharum, or oil sugar; Malt and orange sugars; Pectoral troches	80
Pectoral, raspberry, carrot, cream, and malt bonbons; Cream walnuts; To prepare bonbons of caramel sugar with soft filling; Sweetmeats (conserves); Chocolate and orange sweetmeats	81
Orange blossom, rose, jasmine, carnation, vanilla, filbert, heliotrope, angelica, lemon, cinnamon, cherry, peppermint, and love sweetmeats	82
Sweet smelling and violet sweetmeats; Medicinal sweetmeats: Spoonwort, water cress, antiscorbutic sweetmeats; Crème du café; Crème du chocolade; Coated filberts; Roasted almonds and filberts; Coated chestnuts; Candied cherries	83
Glazed almonds; Coated orange blossoms; Candied oranges; Peppermint drops; Punch drops; Lozenges: Spice for lozenges; Chinese, lemon, peppermint, ginger, and stomachic lozenges; Cherry marmalade	84
Iceland moss, isinglass, gelatine, buckhorn, sago, tapioca, and Irish moss jellies; Ground mass for crème (Crème fondant); Red color for sweetmeats, jellies, etc.; Innocuous green color for candies; Receipts for preparing bandoline or Fixateur; baking powder	85
COPYING AND PRINTING :	
A new method of copying engravings, drawings, and designs; Gelatino-graphy: A cheap, quick, and simple process of duplicating drawings by means of the printing press; Autographic method of printing; To duplicate writings and drawings; Printing in colors	86
To copy drawings in black lines on white ground; Cyanotype (blue prints); Almography; Polygraphic method	87
Jacobsen's callograph; The hektograph; Edison's electric pen; The cyclostyle	88
DAMASKEENING STEEL :	
Genuine damask; Imitation of damask; Damaskeening with gold or silver	89
DECORATION, ORNAMENTATION, ETC. :	
To gild glass	89
Gold for illuminating; To gild porcelain; To gild an ornamental frame; Applying the first coat; Preparation of gilding size; Applying the gilding size	90
Bright lustre; Dead lustre; Silvering; Silvering with a dead lustre; To silver wooden figures with bismuth; To gild and silver visiting cards; To gild or silver morocco paper; To gild cotton; Gilding and silvering on parchment and paper; Italian method of gilding wood	91
Burot's process of silvering and gilding silk, cotton, and woollen yarns; To make glass opaque or frosted; Ornamenting metal surfaces; Aubriat's new process of decorating glass	92
Artificial wood for ornamental purposes; Use of wood tar for architectural decorations; To produce ornaments from wood mass	93
To fasten leather ornaments, etc., upon metal; To decorate tin with copper plates and lithographs; Impressions of flowers on glass	94
DENTIFRICES AND MOUTH WASHES :	
American tooth powder; Asiatic dentifrices; Cartwright's tooth powder; Deschamp's alkaline and acid tooth powders	94
Charcoal, Circassian, red, Hufeland's tooth powder; Paris tooth powder; Mouth wash for strengthening the teeth and gums; Mouth wash against toothache; Antiseptic mouth paste; Kolbe's mouth wash; Hager's red tooth powder and tooth paste; Quillaya dentifrice	95

DYEING WOOLLEN AND COTTON GOODS AND YARNS, SILK, STRAW HATS, FELT HATS, KID GLOVES, HORSEHAIR, ETC. MORDANTS:	
Cleansing old silk to be dyed	95
Dyeing silks of various colors; To dye woollen goods and yarns; Dark blue	96
Blue (dark fugitive color); Gens d'Armes blue on loose wool, yarns, and piece goods; Various shades of brown; Brown (sanders wood, fast); Chamois	97
Various shades of gray; Green: Olive and brownish olive; Lilac; Orange; Yellows	98
Cotton goods and yarns: To dye black, chocolate-brown, chamois, crimson; Gold color (cotton for fringes, etc.); Silver-gray; Dark green	99
Mineral green; Yellow; Chrome-yellow; To dye wool, silk, and cotton with aniline colors: Fuch sine on wool; Fuch sine on silk (bluish shade); Fuch sine on cotton; Eosine on wool	100
Eosine on silk; Eosine on cotton; Scarlet and erythrosine on wool; Violet on wool; Violet on silk; Aniline blue (blue, light blue, and soluble blue); On wool and silk; On cotton; Alkali blue; For 100 pounds of wool; Light blue on cotton	101
China blue on cotton; Dahlia and primula; Methyl-violet; Methyl and emerald-green; Wool, silk, and cotton; Woollen yarn; Malachite green	102
Naphthaline colors (ponceau, orange, and Bordeaux) on woollen yarn and piece goods; Composition of tin; To dye silk and cotton with naphthaline colors; Acetate of alumina free from lead; To dye felt hats with aniline colors; To dye felted fabrics with aniline colors	103
To dye mother-of-pearl with aniline colors; To dye straw and straw hats, black, chestnut-brown, silver-gray, and violet; To dye kid gloves; Morocco-red; Gray	104
To dye kid gloves orange-yellow; To dye horsehair black, blue, brown, and red; To dye imitation corals; Animalizing of hemp, jute, etc.; Mordants: Olivier's mixtures as substitutes for tartar in dyeing wool; Huillard's substitute for tartar in dyeing wool black; Mordant for dark red on cottons; Mordant for light red on cottons	105
Mordants for scarlet, light scarlet, crimson, rose-red, fiery red, purple, and violet on cottons; Manner of preparing the mordants; Use of metallic sulphides as mordants in dyeing cottons with aniline colors; Practical directions for dyeing cotton yarn Turkey-red with alizarine	106
To prepare the so-called Turkey-red oil; English alizarin oil (Patent oil); A new dye	107
ELECTRO-PLATING, GALVANOPLASTY, GILDING, NICKELLING, SILVER- ING, TINNING, ETC.:	
Nickel plating	107
Improvement in nickel plating (E. Weston, Newark, N. J.); Martin and Delamotte's process of nickel plating; Latest improvements in nickel plating (Powell, of Cincinnati, O.)	108
Receipts for ordinary nickel baths; American nickelling; Bath for iron, cast-iron, and steel; Bath for brass, copper, tin, Britannia metal, lead, zinc, and tinned sheet metal; Latest Anglo-American nickelling	109
Preparation of the metals to be nickelled; To nickel iron without the use of electricity; Doumesnil's process of platinizing metal	110
Platinizing of metals; To electroplate metals with cobalt; Plating with aluminium; Gilding copper by boiling	111
To impart a more brilliant gold color to gilded or gold-plated articles; To silver articles of Bessemer steel; Adrielle's process of silvering metals; Piffard's galvanoplastic silvering; Silvering tincture; Cold silvering of copper	112
New process of making silvered telescopic mirrors; New process for sil-	

vering iron and steel (Pierre de Villiers, St. Leonards, England); Tinning of cast-iron	113
To tin cooking utensils; Cold tinning; New process of galvanizing iron; Gourlier's salt mixtures for galvanic coppering, bronzing, etc.; Coating of brass; Bronzing wrought and cast-iron; To coat wire with brass	114
Coppering bath for wrought and cast-iron or steel articles; Simple fire-plating for iron; Method and apparatus for preparing paper matrices for stereotype plates; Composition for moulds for galvanoplastic deposits; Elastic moulds for galvanoplastic copies in very high relief	115
ENAMELS AND ENAMELLING:	
To enamel cast-iron utensils	115
Enamel for sheet-iron vessels; To enamel iron; To enamel copper cooking utensils; Process of enamelling cast-iron; To enamel and cement metals and other substances	116
Enamel for watch dials; Colored enamels; Preparation of fluxes; Blue, brown, reddish-brown, Vandyke-brown, yellow, orange, green, dark red, pale red, and black enamels	117
Very beautiful black enamel for inlaying and ground; Black enamel for painting and mixing with other colors; Opaque white enamel; Glass enamel for iron; Niello	118
FEATHERS, OSTRICH, MARABOUTS, ETC., HOW TO WASH, RESTORE AND DYE:	
Description of feathers, plumes, and marabouts	118
To wash feathers and marabouts; To bleach feathers; To restore crushed and bent feathers; To dye feathers; To dye feathers black	119
To dye feathers black, brown, and puce colors	120
To dye feathers blue; To dye with indigo red, Bleu de France, crimson, and ruby-red; Rose-colors; Yellow; Garnet-brown; Gray	121
Green; Chestnut-brown; Lilac; Orange; Ruby-red; Violet; To dye feathers with aniline colors; Rose-color; Reddish-blue; Greenish-blue; Genuine alkali (Nicholson's) blue; Green; Orange; Puce; Bronze lustre	122
FIRE-EXTINGUISHING AGENTS AND MEANS OF MAKING TISSUES, WOOD, ETC., INCOMBUSTIBLE:	
Munich fire-extinguishing powder; Vienna fire-extinguishing powder; Fluids for making tissues incombustible; To make tissues incombustible (Prize process of J. A. Martin, Paris, France)	123
For all light tissues; For painted decorations and wood; For coarse linen, ropes, straw, and wood; Cartridges for extinguishing fire; To make paper incombustible; To make theatre scenes, wood, etc., incombustible; Bucher's fire-extinguishing powder; Hand-grenades	124
FIREWORKS:	
Bengal lights	124
Quick matches; White fire; Mohr's white fire; White fire for theatres; Greenish-white fire; Bluish-white fire	125
Red fire; Braunschweiger's red fire; Holtz's red fire; Red fire mixtures; Purple fire; Rose-red light; Red-orange fire; Dark-violet, pale-violet, and blue fires	126
Dark-blue and pale-blue fires; Blue fire with a bluish-green flame; Green fire; Green fire according to Braunschweiger; Other receipts for green fire; Pale-green fire; Dark-green fire; Yellow fire; Other colored fireworks; White, red, green, and blue stars	127
Bluish-green, yellowish-green, and yellow stars; White, red, green, blue, bluish-green, and yellow candles; Japanese matches; Prof. Böttger's imitation of Japanese matches; Fireworks for use in rooms according to Perron; Pharaoh's serpents	128
Harmless substitute for Pharaoh's serpents	129

FOOD AND FOOD PREPARATIONS:

- Soup extract; Meat flour; Pressed feed for horses; Strengthening foods known as "Dictamia" and "Palamoud;" Soup tablets; Stilton cheese as prepared in England; Honey from beets and carrots 129
- To prepare potato flour for soups; Meat biscuit; Apparatus and method for preparing a substitute for coffee; Bread for horse-feed; Pudding powders (vanilla); Almond and chocolate puddings; Manufacture of artificial butter 130
- Margarine; Mège's process for oleomargarine 131
- Other processes for oleomargarine; Tables of the composition of the best-known milk foods for children; Condensed milk; Infants' food 132
- Receipts for Vienna economical butters; Ambrosia; Hydroleine 133

FREEZING MIXTURES:

- Freezing salt; Other mixtures 133

FRUIT AND OTHER SYRUPS:

- American syrups for mineral waters and lemonades; Receipts for lemon syrups; Mulberry, vanilla, vanilla cream, and cream syrups; Ginger, pineapple, strawberry, peach, raspberry, currant, cherry, and orange syrups; Sherbet, nectar, coffee, and wintergreen syrups 134
- Maple syrup; Chocolate syrups; White or red wine syrup; Coffee cream syrup; Solferino syrup; Ambrosia syrup; Orgeat syrup; Milk punch syrup; Champagne syrup; Sherry cobbler syrup; Orange-flower syrup; Cinnamon syrup; Ginger beer syrup; How to clarify sugar syrups; Marshmallow, balsam, and barberry syrups 135
- Blackberry, lemon, camomile, manna, rhubarb, saffron, senna, Seneca root, licorice, violet, cinnamon, egg, and cochineal syrups; Syrup of ferrous nitrate 136

FUEL AND HEATING. HEAT INSULATION (NON-CONDUCTING COVERINGS):

- Necker's kindling compound; Economical fuel; Fuel from coal and rosin; King's patent fuel; Coal-dust fuel (Loiseau's patent); Blair's patent fuel; Infusorial earth for insulating steam-pipes; Heat-insulating coverings for steam-pipes, etc. 137

FUSIBLE COLORS USED IN PORCELAIN PAINTING:

- Brianchon's peculiar process of painting glass, porcelain, etc.; Preparing the flux; Ador and Abbadie's zinciferous metallic colors; Solution of zinc salt 137
- Bronze color; Chamois color (leather yellow); Gray, green, rose-red, golden yellow, Roman yellow, and yellowish-green colors; Other colors; Black (cobalt and manganese); Black (iridium); Black (refractory); Blue (azure); Blue (dark); Blue (shading); Blue (Turkish); Bluish-green 138
- Bluish-red; Brown (Bistre); Brown (dark); Brown (pale); Brown (sepia); Brownish-red; Chamois; Flesh color; Gray (chrome); Gray (iridium); Green (dark); Green (grass); Green (shading) 139
- Lustre colors; Gold; Orange-red; Orange; Prismatic colors; Purple (dark); Purple (pale) 140
- Purple (rose-red); Yellow (dark); Yellow (lemon color); Yellow (pale); Yellow (uranium); Yellowish-red; Yellow for figures and landscapes; Yellow for landscapes; White (covering) 141

GLASS. COMPOSITION OF THE VARIOUS KINDS OF, COLORS FOR, AND PROCESSES FOR ENAMELING, ENGRAVING, GILDING, SILVERING, PULVERIZING, FILING, BENDING, ETC.:

- Dark-green bottle glass 141
- Jähkel's glass for champagne bottles; Elli's cryolite glass; Bohemian crystal glass (free from lead); Plate glass of the mirror manufactory at Aix la Chapelle; French mirror glass; Belgian, Bohemian, English, French, and Prussian window glass; Stein's receipts for compositions

of glass as actually used in various glass works; Potash crystal glass; Bohemian mirror glass; Bohemian chalk glass (ground glass, white concave glass); Bohemian window glass; French mirror glass; French soda glass	142
White soda window glass; Semi-white potash window glass; Bottle glass; Lead crystal glass; Crown glass (Bontemp); Crown glass (Guinaud); Flint glass; Flint glass (Bontemp); Compositions for strass (according to Donault-Wieland)	143
Compositions for opaque glass; Tin enamel; Arsenical enamel; Bone glass; Opal glass; Alabaster glass; Compositions for colored glass; Aventurine glass (according to Clémandot); Blue glass; Sapphire-blue; Azure-blue; Golden topaz glass; Green glass	144
Hyalite glass; Orange glass; Red glass; Red with copper; Red with gold; Turquoise glass; Violet glass; Yellow glass; New combination of materials for the production of glass; Iridescent glass; Engraving on glass; Colored designs upon glass; Glass engraving	145
To pulverize glass; To bend glass tubes	146
GLAZES FOR EARTHENWARE:	
Glazing for common earthenware; English glaze for earthenware; Glazes free from lead for earthenware; New glazing free from lead for kitchen utensils; Very fine composition for white glaze (Feilmer's, of Berlin).	146
White glazes; To give earthenware or porcelain a marbled or granite appearance	147
GLASS AND OTHER SIGNS:	
To etch glass (fine and coarse grained); Gilding glass	147
Silvering on glass; Gilding on show windows; Correcting the isinglass mixture; Backing the inscription on show windows; Backing glass signs without shades; Backing glass signs with shades; With mother-of-pearl insertions; Mother-of-pearl insertions; Backing with tin-foil; Transparent glass sign (Child's American patent); Sign-painting	148
Japan gold size	149
GLUE, MANUFACTURE OF:	
The raw material; Steeping the stock in lime	149
Glue boiling; Boiling with wet waste; Boiling with dry waste	150
Clarifying the glue; To color the glue yellow; To whiten the glue; Pouring into the boxes (moulds)	151
Taking the glue from the moulds; Ruthay's new process of making glue from waste of hides and skins in tanneries; Glue from waste of tanned leather	152
Maclagan's apparatus and process for manufacturing glue and gelatine; Extracting the gelatine	153
To make gelatine from glue; Liquid steam-glue; Heller's steam-glue; Cold liquid glue; To prepare excellent glue which will hold in water; Good furniture glue; Glue for books; Glue resisting wet and moisture; New liquid glue; Bone glue	154
Dupasquier's process of preparing bone glue as a substitute for isinglass; Selecting and bleaching the bones; Comminuting the bones; Immersing the comminuted bones in hydrochloric acid	155
Bleaching; Pouring the gelatine into moulds; Isinglass (fish glue); Printers' rollers from glue and glycerine; Birdlime	156
HOUSEHOLD AND RURAL ECONOMY:	
How to construct a table fountain; Pine leaves or "needles" as a substitute for hair, feathers, etc.; To keep milk from souring; Mass for artificial flowers and fruits; Simple process for preparing potato flour; Roasted malt as a substitute for coffee; Lemonade powder; Champagne powder; Champagne mixture	157
Currant champagne; English champagne; Fruit champagne; Fruit wines; Apple wine (cider, English process; Cider (Normandy process);	

Apple champagne (champagne cider); Birch wine; Blackberry wine . . .	158
Cherry, currant, damson, elderberry, ginger, honey, and orange wines; Orange wine with lemon; Raisin wine . . .	159
Raspberry wine; Remedy for warts; Remedy for chilblains; Remedy for corns; Ginger beer; English ginger beer; Spruce beer; English spruce beer; Root beer . . .	160
To prepare fly paper; Fly paper free from poison; Persian insect powder; To destroy insects and worms infesting wall paper, etc.; To preserve animal skins; To preserve stuffed animals; To destroy insects infesting herbaria and collections of insects; To protect woollen goods and furs; Hager's mixtures for preserving cloth and furs . . .	161
Receipts for destroying moths; For the destruction of bed-bugs and other insects; For the destruction of fleas on dogs, horses, and cattle; To de- stroy cockroaches, mosquitoes, and gnats; To drive away ants from closets, etc.; To drive rats away from a building; Phosphorous paste for destroying rats and mice; To destroy field-rats and mice; London purple for the destruction of insects (Prof. C. V. Riley); Hager's uni- versal composition for the destruction of vermin . . .	162
For the destruction of phylloxera (vine grub); Simple disinfectant; Dis- infecting powder of Max Friedrich . . .	163
Efficacious disinfectants; To cleanse lacquered and stained articles of wood; To cut and pierce rubber corks; To protect stone and brick walls from moisture; Rosin as a protection against moisture in walls; To pre- vent rust on iron; To prevent wooden posts from rotting; Excellent wash for wood and stone . . .	164
Brilliant whitewash closely resembling paint; Utilization of chicken feathers; Preservation of wooden labels; Collodion for plant slips; To destroy stumps of trees; To prepare beef tea . . .	165
To disguise the taste of cod-liver oil; Remedy for hoarseness; Extract of elder blossoms; Belladonna ointment; Cantharides ointment; Com- pound chloride of sulphur ointment; Compound lead ointment; Creos- ote ointment; Elderberry ointment; Elemi ointment; Gall-nut oint- ment; Hemlock ointment; Iodide of lead ointment; Iodide of mercury ointment; Iodide of potassium ointment; Iodide of sulphur ointment; Lead ointments; Litharge ointment; Prussian lead ointment; Saxon lead ointment . . .	166
White lead ointment; Lead cerate; Mercury ointment; Opium ointment; Pitch ointment; Savin ointment; Spermaceti ointment; Sulphur oint- ments; Tar ointment; Tartar emetic ointment; Zinc ointment; Am- monia liniment; Camphor liniment; Compound camphor liniment; Lime liniment; Opium liniment; Soap liniment; Turpentine liniment; Verdigris liniment; Betton's celebrated cattle liniment (critical oil); Turkish balsam for fresh wounds . . .	167
To soften hard water; To keep tallow and lard from becoming rancid; To purify rancid butter; To purify rancid fat; Dougal's powder for puri- fying the air in stables; To remove foul air from wells; To keep ice without an ice-house . . .	168
To keep fruits in ice-houses; Substitute for coffee; To preserve canvas, cordage, etc.; Stove-polishing compound; Wigger's process of purify- ing lard and tallow; Manure salt from urine; Solution of guano for flowers; Substitute for guano; Manure from coal ashes; Manure for turnips, rutabagas, etc.; Stockhard's manure mixture for vegetable gardens; Manure powder from blood; Manure from waste animal sub- stances . . .	169
ILLUMINATING MATERIALS:	
Incombustible wicks; Metallic wicks; Material for preparing incombus- tible torches; Gas from cork; Naphtha ether, a new illuminating mate- rial; Air-tight and flexible tissue for dry gas-meters . . .	170

To detect a leak in a gas-pipe; Improvement in dry meters; Apparatus for manufacturing illuminating gas from ligroin and air by the cold method; Purification of illuminating gas; Preparation of wicks for stearine candles; "Melanyl" candles; To coat tallow candles with a hard substance which will not crack	171
To color paraffine, wax, stearic acid, etc., black; Coloring tallow; Junemann's process of producing white and hard tallow candles burning with a large flame and consuming the wick	172
Fabrication of stearine candles without the use of presses and other expensive machinery; New automatic gas lighter	173
IMITATIONS, SUBSTITUTES, ETC.:	
Artificial leather for lithographers' rollers; Vegetable ivory; Substitute for horn, hard rubber, ivory, etc.; Vegetaline; Substitute for linseed oil and oil of turpentine in preparing paints; Substitute for bristles; Artificial chalk; Artificial leather (X. Karchesky, Belleville, N. J.)	174
Artificial leather (Stierlin's German and French patent); Artificial wool; Substitute for meerschaum, ivory, etc.	175
Porous substance as a substitute for felt, for trays, for beer glasses; Substitute for cast-iron, stone, clay, and cement; To make heels of boots and shoes, buttons, etc., from pulverized leather; Hall's substitute for leather; Preparation of leather cloth; Micoud's artificial leather	176
Artificial slating for blackboards and school slates; Artificial ebony; Leather, soap, and glue, from sea-weed (algæ); Transparent sea-weed leather; Opaque sea-weed leather; Sea-weed soap; Sea-weed glue, substitute for animal glue; Artificial stone for sharpening lead and slate pencils; To convert ordinary agate into onyx	177
Substitute for opaque window glass (Chardon); Porous substance as a substitute for blotters; Flexible mirrors; Artificial whalebone for umbrella and parasol ribs, busks for corsets, etc.; Buffaloeskin as a substitute for horn (Rohn); Substitute for tinfoil; Zeiodelite; Imitations of mother-pearl and marble with glue	178
Preparation of the plates, and of the glue solution; Imitation of mother-pearl veneers	179
Pouring the colored glue solutions upon the plates	180
Transferring the layer of glue to a layer of gelatine; Drying and detaching the veneers; To make gelatine foils	181
Sorel's substitutes for gutta-percha and caoutchouc; To give a pearl lustre to various articles; Substitute for slate; Bertolio's substitute for meerschaum	182
To prepare ratan to be used in the manufacture of corsets; Composition for cane heads, gun and pistol stocks, etc.; Sören Sörensen's imitations of leather; For soles, heels, and insoles; Imitation of marble for plastic ornaments and picture frames; To dye hard-nut shell buttons, coal black, and brown	183
To dye hard-nut shell buttons, dark brown, gray and fancy colors, olive colors; For coloring with aniline colors; Blue, red, scarlet, and green	184
INDIGO, INDIGOTINE, AND ALIZARINE:	
Crystallized indigo; Indigo carmine; Acetate of indigo	184
Indigo-violet; Indigo-carmin in the form of extract; Kopp's process of gaining indigotine and alizarine; The apparatus	185
The operation; Artificial alizarine; Coloring artificial alizarine, dark red and rose color	186
Inspissation for red; Aluminium acetate; Aluminium hydrate; Solution of calcium acetate of 16° B.; Printing colors for red and violet articles by using a paste containing 10 per cent. of dry dye-stuff, very dark red; Aluminium nitrate; Another red without oil; Violet printing color; Violet inspissation; Geitner's alizarine liquor	187

INKS, LITHOGRAPHIC, PRINTING, AND WRITING :

To make a good printing ink	187
Description and illustration of apparatus for making printing ink	188
Receipts for printing inks	189
Printing ink from coal-tar; Thick printers' varnish with coal-tar varnish oil; Fine printers' ink with coal-tar varnish oil; Black printing colors patented in Germany; New process of preparing printing inks; Printing and stamping ink containing iron; Bronze color for direct printing upon paper, oil-cloth, etc.	190
Black printing ink which may also be used as etching ground; Preparation of tannin black, and its use for printing ink and other purposes; Lithographic inks	191
Autographic ink; Lithographic printing ink; English lithographic ink; Writing inks	192
Indestructible inks according to Traille, P. A. Gaffard, of Paris, and Stark; Stark's patent copying ink; Böttger's copying ink	193
Solid inks (ink powders and ink stones); Karmarsch's black ink; Reid's black ink; Lipowitz's process of preparing black ink; Brand's black ink; Booth's excellent black ink; Van Moos' good black ink; Geissler's black ink; Jahn's black ink	194
Lewis' black ink; Ure's black ink; Schmidt's ink for steel pens; Runge's ink for steel pens; Haenle's ink which does not corrode steel pens	195
English inks; Duncan, Clockhart & Co.'s, of Edinburgh, celebrated bluish-black inks; Ink for steel pens; Vanadium ink (Berzelius' receipt); Alizarine ink; Elsner's alizarine ink; Dubell's alizarine ink	196
Winternitz's alizarine inks; Receipt with oxalic acid; Copying inks; Beau's French copying ink; Black copying inks	197
Alkaline copying ink; Aniline inks of various colors; Indestructible or permanent inks; Indestructible inks according to Bosse, Kindt, Bossin, and Braconnot; Excellent blue ink	198
Red inks; Carmine ink; Wueckler's durable red ink; Violet inks; Violet copying and violet writing inks; Encre violette de Rouen; Solid inks (cakes and powders); Platzer's ink powder; Ink powder in capsules (G. J. Collins, Brooklyn, N. Y.); Ink cake	199
Marking ink; Ink for writing on glass; Indestructible ink for writing on glass; Red and black ink, not acted upon by acids, for marking glass and metal labels; Stamping ink; Sympathetic ink; Incombustible ink and paper; Indestructible ink for stamping cotton and woollen goods which are to be bleached with chlorine; Changing writing executed with pale ink immediately into black	200
Colored sands; Brush for marking boxes, etc.; Chemical test of written documents (Wm. Thompson's, Manchester, Eng.); Printers' rollers	201
JEWELLER'S FOILS:	
Turnbull's blue foil; Green, red, and yellow foils; To prepare a crimson fluid for Dutch gold or paper; Yellow fluid for foils; Green fluid for Dutch gold; Process of producing cameos	202
LACQUERS AND VARNISHES:	
Manufacture of fat copal varnish (Violette)	202
Illustrations of apparatus for manufacturing varnish	203
Spirit lacquers; Iron lacquers; Clarifying varnish; Filtering varnishes	205
Spirit gold-lac varnishes; Gold-lac varnish with shellac and other resins; Gold varnish without lac; Gold-lac varnishes with oil of turpentine and oil of lavender, with and without linseed-oil varnish	206
Walton's process of preparing linseed-oil varnish; Several universal furniture varnishes; Balloon varnish	207
Copal varnish with spirit of sal-ammoniac; Chinese varnish; Incombustible varnish for wood; Varnish for wood not acted upon by boiling	

water; Varnish for earthenware vessels; Japanese transparent lac varnish; Japanese black lac varnishes; Varnish for fans, fancy boxes, etc.; Varnish for umbrellas; Black varnish for tinsmiths; Gold varnish on iron; Pitch varnish for buildings	208
Spirit varnish for violins and other musical instruments; Black varnish for zinc; Parisian wood varnish; Furniture varnish; To lacquer flowers; White unchangeable lacquer for leather; To polish carved work	209
French polish; Parisian bronze lacquer; Black polish on iron and steel; A new varnish (German patent); Parisian bookbinders' lacquer; Excellent glass-like varnish; Varnish for wood naturally colored or stained; Colorless varnish; French leather lacquer	210
Cheap lacquer for harness and carriage tops; Lacquer for drawings; Transparent lacquer for closing bottles; Tar varnish; Polishing of wood; Elastic lacquer; Black harness lacquer; Parchment fluid; To provide bars of spring steel with a coating not acted upon by acids, alkalis, chlorine, and steam; Aluminium palmitate and its uses in different branches of industry	211
New method of preparing fat lacquer and varnish, patented in Germany by Zimmermann and Holtzwich; Light copal varnish with coal-tar varnish oil; Light Parisian varnish with coal-tar varnish oil; Light varnish for lacquering photographic negatives; English method of varnishing coaches; Pumicing	212
Puttying, saturating the panels with oil; Laying on the ground; Pumicing the ground; Laying on the paint; First, second, and third pumicings of the paint; Laying on the lac varnish	213
Polishing the lacquer; Ordinary body-carriage lacquer; Quick-drying body copal varnish; Neil's carriage lacquers	214
LEATHER, TANNING AND DYEING, INCLUDING FURS, ETC.:	
New tanning process; Quick tanning process; Manufacture of calf-kid in Philadelphia	214
To depilate hides; Curriers' black gloss; Heating the liquor in tanning; Heinzerling's quick method of tanning	215
Boegel's process of quick tanning; Jungschläger's process of quick tanning; New process of depilating hides; To prepare transparent leather; To preserve and water-proof skins	216
To prepare calf leather with a white flesh-side smooth as a mirror; To preserve the yelks of eggs used in tawing glove leather; To preserve hair in a tannery; To improve hides and skins; Dyeing leather; Azure on tawed white leather; Black on leather; Blue on leather; Red on morocco; Saffron-yellow on leather; Dyeing of chamois skins; Black, green, gray, tan, yellow, and yellowish-brown; Dyes for ordinary tawed leather; Blue, camel-brown, chestnut-brown	217
Coffee-brown, flesh color, garnet, green, lilac, olive-green, orange, rose color, scarlet, violet, and dark and pale yellow; Dyes for kid leather, azure, black, brown, English gray, French green	218
Gray, gray-brown, gray-green, gray stone color, green stone color, light and dark green, olive and orange-brown, orange-red, pensée, or violet-blue, silver gray, straw color; Apparatus and process for dyeing and patterning animal skins; To dye rabbit skins black; To dye sheep skins brown	219
Process of dyeing naturally white skins, or skins with naturally white points, various shades of brown, leaving the points white; Imitation of sable skins; To protect furs against moths; To tan linen, hempen, and cotton fabrics; To give leather the smell of Russia leather	220
LIQUORS AND BEVERAGES: BEER, BRANDY, GIN, WHISKEY, WINES, ETC.:	
Beer brewing; Fabrication of malt; Steeping; Germinating (couching);	

Kiln-drying; Preparation of the liquor containing the dextrine and sugar (mashing)	221
Boiling the wort with hops; Cooling; Fermentation; Improved brewing process; New brewing process; Clarifying beer; Flaxseed pulp for clarifying beer	222
Brewers' pitch; Brown brewers' pitch; Hop pitch; Glaze for beer barrels; Glaze of Prof. Artemus; Testing beer for foreign bitter substances; Pure beer	223
Acid mixtures; Petroleum-ether; Benzole; Chloroform; Ammoniacal shakings; Beer wort; Wormwood; Benzole and chloroform; Marsh rosemary (sedum palustre); Bog bean; Marsh trefoil; Quassia; Colchicum seeds	224
Indian berries (cocculi Indici), petroleum ether, and benzole; Colocynths; Willow bark; Strychnine; Atropin; Hyoscyamin; Aloes	225
Gentian root; Determination of glycerine in dark and light beers; Alcohol and compressed yeast from uncrushed cereals without the use of steam-pressure; To convert alcohol of 70 per cent. into 90 per cent. in the cold way; To purify alcohol obtained from beets and molasses	226
To purify alcohol; To prepare absolute alcohol; Manufacture of cognac; Artificial cognacs; Dutch method of distilling and manufacture of compressed (dry) yeast	227
Mashing; Setting (Anstellen)	228
Clarifying the wash; Receipt for Holland gin; Rum (Fagon rum); To destroy fusil oil (amyl alcohol)	229
To purify alcohol and liquors; To remove the taste of the barrel from whiskey; Wines; Bordeaux, Burgundy, Champagne; Artificial Champagnes; Champagne liqueur; Chandon et Moet (green seal); Louis Roderer (green and bronze seal); Heidesick et cie (sealed with tinfoil).	230
Lemberg Geldermann et Deitz (sealed with tinfoil); Schneider; Fleur de Sillery; Jacquesson et fils; Madeira; Malaga; Essence de Goudron; Port wine; To improve wine must; Remedy for ropiness or visciduity of wines; To remove the taste of the barrel from wine	231
LUBRICANTS FOR MACHINES, WAGONS, ETC.:	
Adhesive grease for machine belts; Grease for water-proofing leather	231
To make kid leather soft; Lubricant for industrial purposes; Pulverulent lubricant for axles, etc.; Doulon's caoutchouc lubricant; Patent wagon-grease from rosin oil soap; Blue patent grease; Yellow patent grease; Black patent grease; Patent palm-oil wagon grease; Lubricant from paraffine residues; Consistent machine oil	232
Lubricant for belts; French's machine grease; Lubricant for car axles; Belgian wagon grease; Excellent carriage grease; Lubricant from oil residues; Pyroleine (lubricant for machinery); Thinly fluid pyroleine; Thickly fluid pyroleine	233
Metalline; New lubricant for machines from sea-weed (solid and liquid); Lubricating oil for astronomical instruments; Vulcan oil, for spindles, for carding machines, for hydraulic motors; Machine oil from coal-tar varnish oil; Lubricant for carriages from coal-tar varnish oil; Persoz's patent wagon grease	234
Oil for watchmakers; Very fine lubricant for clocks and watches; To test the fitness of oils for lubricating watches and clocks	235
MARINE GLUE:	
Hard marine glue; Elastic marine glue; Marine glue for damp walls	235
MATCHES:	
Swedish matches; Striking surface of Swedish matches; Matches without sulphur; Inflammable compounds (Schwarz); Inflammable compound without phosphorus; Parlor matches; Colored parlor matches	236
Anti-phosphorus matches; Matches inextinguishable by the wind; Matches without phosphorus; Amorces d'Allumettes; Nickle's process of preparing an amorphous phosphorus from the ordinary article	237

METAL INDUSTRY :

To harden cast-iron; To give iron articles a brilliant lustre and silvery appearance; To restore burnt cast-steel; To make steel so soft that it can be worked like copper; Welding steel to cast-iron; Hardening and welding compounds; Hardening compound; Welding compound for welding wrought-iron to wrought-iron; Welding compound to weld steel to wrought-iron at a red heat; To weld wrought-iron to wrought-iron at a white heat	238
Hardening compound to make wrought-iron very hard; Welding cast-steel; To harden files and other steel instruments; To re-sharpen files	239
Dr. Hartmann's hardening compound for thin steel; New process of hardening gun-barrels; To harden steel in sealing-wax; Hardening water; Poncelet's fluids for hardening steel articles; New case-hardening compound; To obtain smooth castings; To harden saws and springs	240
To convert iron into steel (J. H. Wilson, of Liverpool); Hard silver; Malleable brass; Very tenacious brass; Steel wire for musical instruments (Webster & Horsfall); To weld copper; New process of preparing malleable nickel	241
To obtain dense and flexible copper castings; To obtain copper steel; Silicon; To protect lead pipes; To protect iron from rust; To protect lightning-rods, metal roofs, etc., from rust; To protect wire, iron, and steel from rust	242
Cleaning guns with petroleum; To protect wrought-iron bridges from rust; Staining metals; Blue stain on iron and steel; Gray on steel and iron	243
Black; To stain iron, gun-barrels, etc., brown; English process of staining gun-barrels brown, light brown, and light yellowish-brown; Lacquering of sheet metal; Glazing	244
Glazing: Green, yellow, blue, chamois, red-brown; White lac color; Lilac or violet; Black lacquer; Blue or steel glaze; Red glaze	245
MUSTARDS :	
To prepare ordinary mustard; Frankfort and wine mustards; Lenormand's method of preparing mustard	245
Moutarde de Maille; Moutarde à la Ravigotte; Sour Düsseldorf mustard; Soye's method of preparing mustard; Aromatic and English mustards; Black and compound mustard powders; Compound English mustard powder; Compound black mustard powder; Very fine table-mustard	246
OILS AND FATS—ANIMAL, VEGETABLE, AND MINERAL :	
Purification of mineral oils; Uses of the residues in the manufacture of shale oil; French process of cleansing vegetable fat oils; Manufacture of castor oil (Brosius & Co.); Baeder, Adamson & Co.'s process	247
Manufacture of neat's-foot oil; To prepare Chinese drying oil; To solidify petroleum and other mineral oils; Rosin oil and its uses	248
To prepare pure naphthaline; Vaseline or cosmoline	249
New process of purifying paraffine; To purify and bleach fat of bones extracted with benzine, and make it available for the manufacture of soap; Process of gaining glycerine	250
Corn oil from corn mash; Oil from acid tar; To refine cotton-seed oil; To purify train oil; To purify illuminating oil; To purify turbid or impure poppy-seed oil; To purify animal oils	251
Böttger's simple process of making commercial petroleum clear as water without distillation; Oil from sunflower seed; Macassar oil; To prepare oil used in pumicing wood; Cowper's process of deodorizing coal-tar, rosin oil, etc.; To detect rape-seed oil and all oils derived from Cruciferæ; To detect rape-seed oil in other fat oils	252
Preparation and uses of paraffine	253
Belmontine and Sherwood oil; A new oil from California; To distinguish light oils from crude petroleum from light tar oils	254

Practical purification of crude, heavy wood-tar oil and preparation of crude wood-tar creosote; Separating and purifying fats	255
To remove sulphuric acid and sulphur adhering to mineral oils after refining (Perutz); Coal-tar varnish oil; Process of producing heavy coal-tar oil in England	256
Manufacture of yellow shoemakers' wax from purified coal-tar oils; Manufacture of blacksmiths' pitch from coal-tar; Testing oils (Mau-méné)	257
OIL-PAINTINGS: HOW TO CLEANSE, PACK, AND VARNISH THEM, AND TO RESTORE GILT WORK:	
To cleanse oil-paintings	257
Action of water, olive oil, or butter; Wood-ash, potash, soap, spirit of wine, oil of turpentine, oil of lemon, and oils of lavender and rose-mary, upon paintings	258
To remove a painting from the old canvas and transfer it to a new; How to pack oil-paintings for transportation; To paste an oil-painting on wood; To cleanse beef-gall to be used as a varnish on paintings; Cleansing and lacquering of oil-paintings	259
To cleanse and renovate the gold and framework of old altars; For cleansing the framework from dirt; To repair lustre gilding on altars; To restore silver on altars and tabernacles	260
PAINTS AND PIGMENTS. GRINDING AND MIXING COLORS. GRAINING. IMITATION OF MARBLES. PAINTS AND WASHES FOR VARIOUS PURPOSES, ETC.	
Grinding colors; Brushes	260
Graining oak, mahogany, and rosewood	261
Satinwood, maple, and walnut; Imitation of marble; Green marble; Dove-colored marble; Receipts for colors, American green, apple-green, aurora, azure-blue, blue (cornflower), bluish-white, Bremen green, chamois, cherry-red, chestnut-brown, crimson, enamel-white, flax-gray, golden-yellow, beautiful golden-yellow, grass-green, hazel-yellow, jon-quil, and lemon color	262
Light-gray, lilac, mahogany, oak, olive-green, sea-green, silver-gray, straw, sulphur, violet—dark, medium, light, very light, bluish—and walnut—dark, light, and very light—colors; Paints for various purposes; Flexible paint; New paint for floors, stone, wood, and brick work; Water-proof paint; Paint suitable for vessels, submarine work, etc.	263
Cheap and durable paint for brick work; To prepare a zinc wash for rooms; Durable paint for tin roofs; White paint for metallic surfaces; Green paint for articles exposed to the action of the weather, such as doors, shutters, etc.; Universal paint; Paint for outside walls; Paint which resists all moisture, for wood or stone; Cheap white paint for outside work; Red wash for brick floors and pavements; To prevent disintegration in stone work	264
For marble; For sandstone; To make sail-cloth pliable, durable, and water-proof; Swedish paint for wood work; Paint for constructions of iron; Paraffine paint; Quickly drying oil-paint; Paint for roofs; Paint on wood exposed to the action of the weather	265
Water-proof paint for metal; Coating for blackboards; To protect the bottoms of ships and other articles under water; Dryer for oil colors and varnish; To prepare dryers; Patent dryer; Dryer for zinc paint; Drying oil; To paint tiles red; Pigments; Black; Lampblack	266
Frankfort black; Carbon from peach stones; Ivory black; Brunswick black; Black from coal ashes and blood; Berlin blue; Mountain blue; Ultramarine (artificial); Robiquet's artificial ultramarine	267
Carmine; Carmine lake; Florentine lake; Green borate of copper for oil and porcelain painting; Chrome-green; Chrome-green for painting;	

Innoxious green color; Mineral green; Neuwied green; Paris green or Scheele's green; Schweinfurth green as made in Schweinfurth . . .	268
Verdigris; Indigo carmine; Chrome-red; Cassel yellow; American chrome-yellow . . .	269
Baltimore chrome-yellow; French chrome-yellow (Spooner's); Paris chrome-yellow; Naples yellow (various shades); Patent yellow; Vandyke red; Innoxious colors for painting toys . . .	270
Colors which, on account of the poisonous qualities, should not be used for painting toys or in coloring articles of food; Artists' colors and for restoring pictures; Kremnitz or Venetian white; Light and dark ochres . . .	271
Light and dark burnt ochres; Sienna; Burnt sienna; Umber; Cologne earth; Ivory black; Parisian blue; Cinnabar; Naples yellow; Fine Vienna lake; Minium; Ultramarine; Verona earth; Cobalt blue and brown Munich lake; Water colors; Deep black; Blue; Indigo blue; Green; Red; Violet blue; Yellow; White; Sap red . . .	272
Painting with sympathetic colors; Preparation of the colors used; Purple and rose red; Yellow, Green, and blue; Painters' cream . . .	273
PAPER AND PAPER MATERIALS, MANUFACTURE, STAINING, ETC., GLASS, SAND, AND EMERY PAPER:	
Preparation of the different kinds of straw used in the manufacture of paper . . .	273
Corn leaves and stalks; Oats, barley, wheat, and rye straws; Process of gaining fibrous substances from different plants; Transformation of woolly fibre; Paper for documents, checks, etc.; Improved cigarette paper; Safety paper (to prevent erasures) . . .	274
Cork paper (H. Felt & Co. patent); Wrapping paper for silverware: Preparation of parchment paper; Water-proof paper; Peterson's water-proof paper; Carbohc acid paper . . .	275
Two new varieties of preserving paper; Plastic pasteboard for surgical bandages; Preparation of tracing paper, tracing linen, and transparent packing paper; Photo-lithographic transfer paper and transfer-color belonging to it; Writing, copying, and drawing paper which can be washed; Tracing paper; Transfer paper; Tar paper . . .	276
To prepare leather waste for use in the manufacture of paper; Iridescent paper; Colored paper for tying up bottles; Pouget-Maisonneuve's electro-chemical telegraph paper; Amianthus paper; To water-proof cylinders of pasteboard; To produce enamelled writing surfaces on pasteboard and paper; Imitation of mother-of-pearl on paper . . .	277
To make paper transparent; Emery paper (Edwards' apparatus); Water-proof emery paper . . .	278
Stains in coloring paper for artificial flowers; Stains for glazed papers . . .	279
Stains for morocco papers; Stains for satin papers . . .	280
How to split a sheet of paper . . .	281
PERFUMERY, AROMATIC VINEGARS, COSMETICS, EXTRACTS, HAIR OILS, POMADES, POWDERS, WASHES, FUMIGATING ARTICLES, ETC.:	
Extraction of perfume from flowers; Manufacture of perfumery; Eau des Alpes; Eau de Cologne (Otto's, Thillaye's, and Wagner's); Eau de lavande ambra; Eau de Paris; Empress Eugenie's nosegay; Esprit de patchouli; Esprit de rose triple; Esprit de toilet Française . . .	282
Ess. bouquet; Extrait violet; Extract of iris; Jockey club; Heliotrope; Millefleur; Moss rose and musk extracts; New garden nosegay; New mown hay, Styrax, Tonka bean, and vanilla extracts . . .	283
Victoria extract; West End and white rose bouquets; Ylang-ylang; Ambergris, Aromatic, Clover, Jasmine, Lavender, Musk, Orange-blossom, Rose, and toilette vinegars . . .	284
Vanilla vinegar; Vinaigre de Beauté; Vinaigre des Dames; Vinaigre aromatique de J. V. Bully; Vinaigre d'Hebé (to remove freckles);	

Cucumber essence; Cucumber milk; Lily essence; Narval bouquet; Moss rose essence; Odeur fin national	285
Tea rose essence; Violette de Bois; White rose essence; Hair oils; Flower oil; Good and cheap hair oils; Hamilton's hair oil; Huile antique à la Bergamotte; Huile antique à l'Héliotrope; Huile à la l'Héliotrope	286
Huile à l'Oeillet; Huile antique à la Vanille; Huile de Millefleurs et de Pot-pourri; Pot-pourri oil; Macassar oil; Sweet-scented oil; Lime-juice and glycerine hair oil; Pomades; Crème Céleste; Crème Cristallisée; Glycerine balsam; Ice pomade; Neroli pomade	287
Pomade (Wagner); Pomade (Winterberg); Pomade à la Duchesse; Pomade au bouquet; Pomade divine; Red and rose pomades; Stick and beard pomatum; Held's beard pomatums; Hungarian moustache pomatum; Stick pomades; Hair restorers, tonics, washes, etc.	288
American shampooing liquid to promote the growth of hair; Baudolines; Bay-rum hair tonic; Bühligen's hair tonic; Cheap and efficacious hair tonic; Cheap hair wash; Eau de lustre (for dressing the hair); Glycerine wash; Rosemary hair wash; Wash to remove dandruff; Hair dyes; Brown hair dye; Eau de Chine pour Noircir les Cheveux	289
Eau Lajeune; Hager's innocuous hair dye as a substitute for lead preparations; Innocuous hair dye; Turkish hair dye; Depilatory compounds; Sulphhydrate of sodium; Cosmetic and medicated waters; Anhalt water; Barège waters; Napoleon's bath	290
"Bretfeld water;" Cascarella water; Creole water; Eau Athenienne; Eau de l'Impératrice; Eau des Odalisques; Eau des Princesses; English honey water; Florida water; Held's cosmetic washes	291
Kummerfeldt water; Cosmetic powders, rouges, etc.; Bran of almonds; Cosmetic wash powder; Flour of almonds; Held's washing powder for the hands; Oriental rouge; Paris powder; Rouge; Vinaigre rouge; White or pearl powder; Augustin's cosmetic wash; Copland's aqua cosmetica; Flacon Générateur Universel des Cheveux de Madame S. A. Allen; Fumigating articles; Black fumigating pastils	292
Fumigation with chlorine; Fumigating essence; Fumigating pastils; Fumigating spirits; Imperial fumigating powder; Medicated fumigating pastils; Iodine pastils; Stramonium pastils; Tar pastils; Opium pastils; Oriental fumigating balsam	293
Paris, perfumed and white fumigating pastils	294
PHARMACEUTICAL PREPARATIONS:	
Artificial Karlsbad water; Artificial koumiss; Balm of Gilead; Balsam of horehound for colds and asthma; Bitter elixir; Bland's female pills; Blistering ointment; Blume's remedy for spavin, etc.; Camphor ice; Cheltenham salts; Cod-liver oil and iodide of iron	294
Compound Storax pills; Dolorifuge elixir anti-odontalgique; Edinburgh stomachic elixir; Glycerine collodion; English peppermint lozenges; Erasing powder; Hoff's malt beer; Improved collodion styptic; Iodoform (Vulpius formula); Iodoform pencils; Aromatic balsam	295
Locatelli's balsam for wounds and ulcers; Soap balsam for sprains; Gelatine capsules for medicinal purposes; English plaster; Malt extract; Malt extract with iron, with lime, with quinine, with pepsin, and with iodide of iron; Neutral citrate of magnesium (Cornelis); Neutralizing the taste of cod-liver oil; New American patent medicines; Phosphorole	296
Fluid hydrastis; Lacto-pepsin; Thermaline; Oleum aromaticum compositum (spice oil for kitchen use); Opodeldoc; Pepsin wine with malt (Ernst Schmidt, of Lille); Plastic bandage; Simple and compound lead plasters; Preparation of sticking plaster; New sticking plaster by Dr. A. Hewson; Galbanum and saffron plaster; Saffron plaster	297
Soap plaster; Powdered camphor; Buchner's antarthritic paper; English antarthritic paper	298

PHOTOGRAPHY:

Alcoholic solution of gelatine; Alkaline gelatine developer; Chloride of silver and gelatine emulsion; Claudet's instantaneous positive paper; Cleansing mixture for glass plates	298
Cleansing fluid for glass plates; Clear caoutchouc solutions; Damson's tannin plates; Receipt for the collodion cotton; Collodion; Solution of tannin; Developer for gelatine plates (Mottu, of Amsterdam); Davanne's intensifier; H. W. Vogel's developing solution of oxalate of iron; Direction for calculating focus distances for enlarging pictures	299
Email photographs; Gelatine emulsions (Abney); Glacé or enamelled photographs; Gold and fixing baths; Toning bath	300
New intensifying bath for gelatine negatives; New developer for bromide of silver dry plates; New method of preparing emulsion; New photo-printing receipts; Preliminary preparation; Chrome-gelatine layer; Fixing solution; Fluid for drawing off negatives; Painting the operating-room	301
Petschler's new dry method of preparing plates; Photo-diaphanie, or process of transferring photographs together with the albumen layer on glass, porcelain, etc.; Photo-emulsions; Improvements by H. W. Vogel; Photo-printing without a press	302
Photographic process with phosphorescent substances; Photographic reproduction	303
Platinotypy; Precipitation of gold from old toning baths; Rapid method; Sensitive collodion	304
Developers for children and for adults; Rapid collodion process by Borlinetto; Neutral silver bath; Developing bath; Fixing bath; Regaining silver from residues of gelatine emulsions; Removing the negative layer from the glass plate; Reproduction of photo-negatives	305
Sensitive collodion emulsion; Sensitive photo-paper; Simple and quick process of preparing pyrogallie acid; Sutton's new developer; Sutton's weak silver-bath for albuminized paper; Toning bath with calcium chloride and sodium acetate by Parkinson; Transfer paper with collodio-chloride of silver; Various practical receipts; Collodion for hot weather	306
Collodion for outside work; Developer; Silver bath; Developer for landscapes; After developer; Good intensifying bath; Solution for preparing paper; Silver bath; Developer; Fixing bath; Negative lacquer with castor oil; Various receipts for the gelatine process; Edwards' glycerine developer; Dr. Eder's oxalate of iron developer; Nelson's developer; Bedford's developer; Abney's intensifying bath; Varnishes; Good negative lacquer; Retouching varnish	307
Elastic lacquer; Excellent lacquer for photographs; Vibrotypes; Photographs on wood; Worthly's negative process, without intensifying bath; Collodion; Developer for negatives; Varnish for negatives; Polishing glass plates	308
PLASTER OF PARIS CASTS WHICH CAN BE WASHED:	
Dr. Reissig's prize process of preparing plaster casts	308
Process with baryta water; With silicate of potassium	309
Brethauer's method of preparing plaster of Paris casts resisting the action of the weather; Jacobsen's process; Shellhass' coating for plaster casts	310
PRESERVING MEAT, MILK, VEGETABLES, VEGETABLE SUBSTANCES, WOOD, ETC., AND PRESERVATIVES:	
Boro-glycerine for preserving organic substances; Boro-tartrate for preserving meat and other food; English pickle for meat; Fluids for preserving corpses, anatomical specimens, plants, etc.	310
Fluids of Struve, and Jacobsen; Wickersheimer's patent "injecting" and "immersing" fluids; Improved process for preserving meat, fish, fruits,	

liquids, etc.; New process of giving preserved vegetables a natural color; New process of preparing preservative salt; New method of preserving sugar beets, potatoes, and other tubers	311
Preserving lemon juice; Process of preparing preserved cattle-feed from agricultural products and waste; Rapid process of corning meat on a small scale; To dry fruit by means of a cold air blast; To pack apples and other fruit for transportation; To preserve the blood from meat cattle; To preserve burnt lime; To preserve butter and eggs	312
To preserve fish; To preserve fluids containing nutritive substances; To preserve hops	313
To preserve meat; Wickershemier's patent for preserving meat; To preserve meat and vegetables, milk, vegetables and fruits	314
To prevent the formation of mould on fruit jellies; Two new kinds of preservative papers; To smoke beef; To preserve vine props and wine barrels by impregnating the wood; Impregnation with linseed oil, with preparations of lime, with common salt, with solution of sulphate of copper, with coal-tar	315
With rosin; New preservative for wood; To restore the original natural color of old parquet floors	316
SEALING-WAX AND WAFERS:	
Receipts for all colors of sealing-wax	316
Transparent sealing-wax; Gold or silver transparent sealing-wax; Aventurine sealing-wax; Parcel sealing-wax of a great variety of colors	317
Cheap Parcel sealing-wax; Bottle sealing-wax; Substitute for bottle sealing-wax; Wafers; White and colored wafers	318
Gelatine or French wafers; Light red wafers; Transparent red wafers; For yellow and blue wafers; English metallic wafers	319
SHOE-BLACKING, DRESSINGS, ETC.:	
Ingredients of good blacking	319
Mixing the ingredients; Caoutchouc blackings, paste, and fluid; Caoutchouc oil; Cordova blacking; Dressing for dancing shoes; Dressing free from sulphuric acid; Dressings superior to Paris dressing; English water-proof blacking; Fluid blacking, a substitute for ointment and lacquer	320
French paste for patent leather; Good shoe-blackings; Gutta-percha blacking; Hardeg's leather ointments; Konrad's celebrated blacking; Ointment for boots used by the Normandy fishermen; Shoe-blackening from potatoes; Water-proof blacking; Water-proof ointments for shoes and boots	321
To give the soles, after scraping, a smooth and beautiful appearance; For hemlock leather soles; To prevent boots and shoes from squeaking; To make water-proof boots	322
SIZING AND DRESSING FOR COTTON, WOOL, STRAW, ETC.:	
Back's improved size and dressing for linen, cotton, and woollen goods	322
Dressing and size; Eau de Crystall; Glycerine, and its use in sizing and dressing; New preparation, glutine, used for giving gloss to wall papers, and as an inspissation for dyeing and printing purposes	323
New size; Preparation of artificial gum to be used in place of gum-Arabic; Preparation of blood albumen	324
To prepare patent albumen; Preparation of dextrine; Process of sizing all kinds of tissues with alkaline solutions of silk, wool, or feathers; Size for bobbinet; For cotton yarns; For cotton and woollen yarns; Size for cotton; Dressing cotton prints	325
Glaze dressing for colored cotton goods; Glaze on black; Glaze on black goods when the color is not sufficiently deep and dark; Glaze on blue and green; Glaze on crimson paper muslin; Glaze on rose-colored muslin; Size for laces; For linen; For half-bleached linen; For fine Holland linen; For table linen and damask; Dressing for Panama hats; Size for petinet and marly	326

Size for woollen goods, cloths, and flannels; Sulphate of barium; Gerard's apparatus	327
SOAP. HARD AND SOFT SOAPS, MEDICATED AND TOILET SOAPS, ETC.:	
American rosin soap	327
American soaps; Superior soaps; Old English soap; First premium soap; Brown rosin soap in the cold way; Coconut-oil soap in the cold way	328
Cold water soap; Elaine soap; Floating soap; Molasses soap; Cocoanut-oil and molasses soap	329
Oranienburg soap; Process of preparing all kinds of perfectly neutral soaps; Water-glass soaps, hard and soft; Sand soap	330
Toilet and medicated soaps; Bitter almond soap in the cold way; Bouquet soap; Camphor soaps; Camphor and sulphur soap; Eagle soap (brown); Family soap; Gall soap; Glycerine soaps, brilliant and transparent	331
Substitute filling in making glycerine soap; Iodide soap; Kummerfeldt's soap for frosted limbs; Lemon, lily, and mignonette soaps; Musk soap in the cold way; Orange and patchouli soaps; Prime pumice soap in the cold way; Rose soap; Savon de Riz; Savon ess. bouquet; Savon orange; Soap crèmes	332
Crème d'Amandes Amères; Crème à la rose; Sulphur soap; Swiss herb soap; Tannin, tar, vaseline, violet, and white alabaster soaps	333
White Windsor soap; Shaving soap in the cold way; Soap for washing silk goods; To give a gloss to the surface of toilet soaps; New process of treating fats	334
Balling's method of preparing caustic soda-lye; Tunnermann's tables giving the percentage of soda in a soda-lye at 59° F., and percentage of anhydrous potash in potash-lye at 59° F.	335
Prinz's practical soap-boiling tables for hard and soft soaps	336
SOLDERING AND SOLDERS:	
Explanation of soldering	336
Autogenous soldering; Ordinary soft solder; Bismuth solder; Darcet's metal; Hard solders; Copper for joining iron to iron; Brass hard solder; Hard solder containing tin; Solder for argentan (German silver)	337
Hard silver solders; Softer hard silver solders; Hard gold solders; Easily liquefiable solders for articles less than 14-carat gold; Refractory solder for articles of 14-carat gold and over; Solder for articles of 20-carat gold, which are to be enamelled; Very refractory solders for articles to be enamelled; Other hard gold solders for articles of 14-carat gold	338
Good hard solder for soldering brass; Excellent soft solder; Table of alloys for soft solder and their respective melting points; Silver solder for plated ware; Soft solder for cast Britannia metal; Solder for pewter; Hard white solder; Hard yellow solder; Solder for gold on aluminium bronze; Golden yellow hard solder; Medium light hard solder; White hard solder; To solder brass, sheet-tin, iron, and steel	339
To solder steel on sheet-iron; Soldering without a soldering iron; Soldering liquid causing no rust; Another soldering liquid free from acid; Simple method of soldering small articles; To solder saws	340
SUGARS, GLUCOSE, ETC.:	
Preparation of milk-sugar	340
Engling's process of preparing milk-sugar; Improvement in refining and crystallizing of starch sugar (glucose); Refining and preparation of anhydrous glucose; Apparatus and process for starch, glucose, and hard grape sugar (dextrose), by Wm. T. Jepp, of Buffalo, N. Y.	341
To remove gypsum from solutions of glucose; Preparation of pure levulose; A new source for supplying Mannite	342
Purification of sugar-beet juice by means of silica hydrate; To prepare strontia sugar from treacle and syrup	344

TEXTILE FABRICS AND TISSUES:

Coating textile fabrics with metallic substances; Effect of heat on textile fabrics; Feather plush	344
Down cloth; Improvement in the treatment of vegetable fibres; Improvement in the preparation of surfaces to be printed on, embossed, etc.; New method of compressing the fibres of cotton tissues, and giving the colors more lustre; New yarn, called pearl yarn; Oil-cloth	345
Apparatus and process for scouring and removing the oil from fleece, wool, and silk, and woollen fabrics of every description; Process for animalizing vegetable fibres with nitro-glucose (nitro-saccharose); Patent process to give to colored fabrics a metallic lustre; Preparation of fibres that can be spun from nettles, hemp, jute, etc.	346
Shoddy; how it is made	347
Silk gauze; Tinning of tissues; To produce a metallic lustre upon fabrics; Utilization of short hair; Utilization and working of jute	348
"Heckled yarn," or "jute line yarn;" Utilization of hop-stalks; A new yarn produced in France	349
TOBACCO, SMOKING TOBACCO, SNUFF, STERNUTATIVE POWDERS, ETC.:	
Smoking tobaccos; Brazilian tobacco; "Legitimo;" Havana leaf	349
Ordinary American leaf tobacco; Chinese or star tobacco; Canaster; Half canaster; Maracaibo tobacco; Ostend tobacco; Petit canaster	350
Petum optimum, according to the Dutch process; Portocarero tobacco; Porto Rico tobacco, according to the Dutch process; Porto Rico tobacco from ordinary leaf; Swicent tobacco (English process); Swicent tobacco (ordinary); Sweet-scented tobacco	351
Varinas tobacco; Improvement of inferior qualities of tobacco	352
To remove the disagreeable smell and taste of inferior qualities of tobacco; Snuff manufacture; Bärenburg snuff; Bergamot snuff; Dutch Musino snuff; Espaniol or Sevilla snuff	353
Frankfort snuff; Parisian Rappée; Rappée (genuine); St. Vincent Rappée; Sternutative (sneezing) powders; Green sternutatory; Variegated sternutatory; White sternutatory; Sternutatories for cold in the head; Corrizinio; Perfumes for cigars; Turkish smoking tobacco	354
To impart to common American tobacco the flavor of Havana; New process of preparing tobacco; Preparation of leaf for cigars	355
VINEGAR: MANUFACTURE OF ORDINARY AND FINE TABLE VINEGARS:	
Altwater's process of manufacturing vinegar; The factory; Utensils	355
Plunging "vinegar producers;" Utilization of cork-waste in the manufacture of vinegar; Concentration of vinegar; To prepare the yellow color for coloring vinegar; To prepare acetic ether; Quick vinegar process; Production of vinegar by means of bacteria	358
Investigations of Pasteur and Wurm	359
White wine vinegar; To prepare acetic acid; To prepare excellent vinegar; Vinegar from potatoes or rice; Fine table vinegars; Anise vinegar; Aromatic vinegar	360
Dragonswort (Estragon) vinegar; Compound dragonswort, or herb table-vinegar; Spiced dragonswort vinegar; English spiced vinegar; Effervescing vinegar; Herb vinegar as prepared in the northern part of Germany; Herb vinegar as prepared on the Rhine; Lemon vinegar	361
Orange, pine-apple, raspberry, strawberry, and vanilla vinegars; Vinaigre à la Bordin; Vinaigre à la Ravigote	362
WASHING AND SCOURING. MANUFACTURE OF WASHING-BLUE, ETC.:	
To wash satin, silk ribbons, brocade, and silk damask; To wash silk ribbons mixed with gold and silver threads, silver and gold lace	362
To wash gold laces; To wash white silk crape, white gauze, fine muslin, linen, and batiste and velvet; To wash velvet which has become hard and rough by rain or mud; To wash veils, silk, and silk fabrics	363
To wash embroidered fabrics, or muslin, linen, etc., woven with gold; To	

wash silk stockings, and taffeta; To polish gold and silver lace; To polish silver lace or embroidery; To wash laces	364
To wash point lace; To whiten lace; To cleanse feathers; Cleansing and rosing salt for red cloths stained by use; To wash genuine pearls; Dye-starch, and crimson dye-starch; Washing with water-glass	365
Palme's process of washing; New wash process; To wash dresses of fast-colored silk; To make washed silk glossy; To restore the color of fabrics; To wash pearl embroideries; To bleach or whiten clothes; Clark's wash for carpets; To wash straw and chip hats	366
Experiments in washing woollen fabrics	367
To wash cotton and muslin prints without injury to the colors; Panama essence for cleansing and washing clothes; Cleansing fluid for tissues, etc.; Use of tin salt for removing rust-stains from clothes (Hörmann's experiments); Manufacture of washing-blue	368
Table of means of removing stains	369
Liquid wash-blue; Several other receipts for liquid washing-blue; Washing powders; Washing crystal; Lustrine Alsacienne (starch gloss)	370
WASTE AND OFFAL, UTILIZATION OF :	
Fabrication of lampblack from waste in working coal-tar	370
Specially constructed furnace for manufacturing lampblack; Manufacture of lampblack from asphaltum, pitch, or blacksmiths' pitch	371
Manufacture of various kinds of lampblack from the resinous sodic residues in the working of coal-tar; Manufacture of artificial manures from residues in the working of coal-tar	372
Manure for meadows; With wood-ash; With peat-ash; Utilization of ammoniacal liquor from coal-tar	373
Ammonia, tar, and other products of distillation from the gases of coke-ovens	374
To regain hydrochloric acid used in the manufacture of gelatine from bones; Tartrate of calcium and spirit of wine from wine lees	375
Process of producing white or black pigment from the clarifying slime in sugar houses; Process of working fecal substances in a rarefied space; Sulphur, sulphuric acid, etc., from gas-lime; Recovering fat and color from waste wash liquors	376
Utilization of waste wash liquors from wool manufactories; To cleanse woollen waste; Utilization of waste of sheep wool; To regain indigo from old colors and residues of colors; Production of cyanide of potassium, ammonia, tar, and gas from nitrogeous organic substances; To restore rubber corks; Process of gaining the volatile products developed in roasting coffee and their utilization	377
WATER-GLASS (SOLUBLE GLASS) AND ITS USES :	
Potash water-glass; Water-glass from infusorial earth; Soda water-glass; Buchner's process; Compound water-glass	378
Preparation of fixing water-glass; Kuhlmann's (of Lille) process; Water-glass as a substitute for cow-dung for fixing alumina and iron mordants on cotton-prints, linen, etc.; Use of soda water-glass for protecting white colors in printing fabrics; Water-glass for silicifying stones; Water-glass as a bleaching agent (H. Grothe)	379
Water-glass for finishing linen and cotton goods; Potash water-glass as a binding and fixing medium for ground colors on cotton goods; For light blue ultramarine colors; Violet; Different green tints; Yellow; Orange and red; Red-brown; Copper-brown; White; Different vegetable lakes; "Solid blue;" "Solid green"	380
Water-glass in painting (Feichtinger); Use of water-glass for coating rough-cast and stone walls; Water-glass in painting metals and glass; Advantages to wood painted with water-glass; Creuzburg's process of painting with water-glass; Water-glass as a substitute for borax and boracic acid in soldering and welding; Water-glass cements	381

To cement cracked bottles with water-glass; To prepare hydraulic water-glass cement; Water-glass cement for glass and porcelain; Water-glass cement with zinc and pyrolusite; Water-glass and lime cement; Böttger's water-glass and lime cement; Water-glass and caseine cement for glass and porcelain; Water-glass and powdered chalk mortar; Water-glass for preserving barrels and other wooden articles	382
WATER-PROOFING COMPOUNDS:	
Preparations for water-proofing tissues	382
To make sacking water-proof; Soap for water-proofing woollen cloth and other fabrics; Various processes of water-proofing tissues; Preparation of collodion varnish for water-proofing fabrics; A new water-proofing compound; To manufacture water-proof cloth which is not impervious to the air; Prepared cloth as a substitute for leather	383
To water-proof felt, woollen, and half-woollen fabrics, and to give them greater consistence; To water-proof vegetable fibres; To water-proof textile fabrics, leather, paper, etc.; To water-proof paper; For water-proofing woollen fabrics	384
Impregnation with caoutchouc; Impenetrable double stuff; Becker, Delivaire & Co.'s process of water-proofing fabrics; New process of water-proofing fabrics; Vanel's water-proof composition; Roelandt's water-proofing compounds; French preparation to make boots and shoes water-proof; To water-proof sugar-bags for transport use	385
English patent water-proofing compound; Water-proofing felt hats; Water-proof sail-cloth, known as "Imperial cloth;" Zwilling's water-proofing compound; Dr. Fournaise's water-proofing compound; Kuhr's receipt for water-proofing linen; To water-proof textile fabrics and paper, and to give them greater consistence; Composition for water-proofing textile fabrics, and protecting them against moths	386
WAX AND WAX PREPARATIONS:	
Unadulterated beeswax; To bleach beeswax; Green wax; Black wax; Red wax; Polishing wax; Polishing wax for furniture; Wax soap	387
Waxed paper; Colors for wax-work; Gold ground upon wax; Wax for waxing threads to be woven; Wax tapers; Wax candles	388
Floor wax; New compound for waxing floors; Spirit lacquer for lacquering wax tapers; Excellent modelling wax	389
WOOD. GILDING, POLISHING, STAINING, ETC.:	
Extraction and impregnation of sounding-board wood; To prepare sounding-board wood; To make wood flexible and fire-proof	389
To render wood incombustible and impermeable (Folbacci); To render wood fire-proof; To render wood impermeable to water	390
How osiers can be peeled in winter; Staining wood for fine cabinet work (Denninger, of Mayence); Gallic acid; Sulphate of iron; Logwood shavings; Pulverized sanderswood; Saffron and annotto; Shavings of Brazil wood and of fustic; Crushed Persian berries; Pulverized cochineal; Aqueous decoction of logwood; Pulverized indigo; Solution of tin; Denninger's process of producing colors	391
Other stains on wood (Thimm's patent); Black ground for lacquering; To stain walking-canes; To stain maple wood silver-gray	392
Ebony stains; For veneers; Stain for floors; Staining wood for veneers, mosaics—various colors	393
Moiner's method of staining wood rose color by chemical precipitation; New polish for wood; Moody's new polish; Gilding on wood	394
American process of preserving wood; Preparation of mine-timber; Relative durability of the timbers	395
Shrinking of wood; Strength of some American woods; Hard coating for wood; Imitation of cedar wood; New glaze for barrels, vats, etc.	396
New method of drying wood; New paint for wooden posts, etc.; New process of preserving wood	397

Polishing wax for wood; Practical experiments in producing new colors upon wood with known coloring matters	398
Preparation of fire-proof wood	399
YEASTS. MANUFACTURE OF PRESSED YEAST, BAKERS' AND BREWERS' YEAST, ETC.:	
Schubert's method of manufacturing pressed yeast	399
Saccharization and cooling; Setting the mash; Scooping off the yeast and freeing it from husks; Washing and pressing the yeast; Moulding the pressed yeast; Vienna pressed yeast; Zettler's process of manufacturing Vienna pressed yeast	400
Prof. Otto's directions for preparing pressed yeast; Pressed yeast from potatoes; American dry yeast; Artificial yeast	401
Cramer's process of preparing pressed yeast from beer-yeast; Improvements in treating yeast; Pressed yeast from beer-yeast	402



ADDENDA.

ALLOYS:

Alloy of copper, platinum, and palladium; Alloys resembling silver; Minargent; Warne metal; Trabak metal; Manganese alloys	403
New alloy for silvering; Aluminium bronze; Phosphor bronze	404
Manganese bronze; Density of alloys; Alloys exhibiting greater density than the mean of their constituents; Alloys exhibiting less density than the mean of their constituents; Fusibility of alloys; Spence's metal; Receipts for metal-workers proved in practice; Metal for brasses; Machinery metal for various purposes	405

ANTISEPTIC AND PRESERVATIVE AGENTS:

Boroglyceride	405
Calcium and sodium glyceroborates, two new antiseptics	406
Effective power of different antiseptic agents; New iron fruit-drying apparatus; New process of greening canned vegetables; For peas; For beans; Novelties in preserving organic substances, and apparatus used	407
Preparation, free from arsenic, for preserving animal skins; Preservative packing-paper to protect cloth, furs, etc., from moths	408

ARTIFICIAL EYES, MANUFACTURE OF

Asbestos industry in England	409
--	-----

ASBESTOS AND ITS USES:

Asbestos industry in England	409
--	-----

BLEACHING:

Bleaching of fabrics and yarns without chlorine	409
Bleaching yarns and fabrics; Novelties in bleaching	410

BOOKBINDING, GILDING, AND ORNAMENTING:

Folding; Rolling; Sewing; Rounding	410
Edge-cutting; Binding; Covering; Tooling and lettering; Edge-gilding; For plain edges; Marbling; Reichardt's rosin compound for gilding paper, leather, etc.; Reber's process of gilding leather; Parchment glue; White of egg; Marbled and dark leather of one color	411
Calfskin; Dull gilding on calfskin; To gild velvet; Gilding on silk; Bookbinders' lacquer; Improvement in book covers	412

BRONZING, GILDING, SILVERING, ETC.:

Apparatus for coating tools	412
Bronzing copper; Cold black stain for brass; Galvanizing and nickelling of iron in Cleveland, Ohio; Gilding of steel	413
Gold and orange stain for brass; Green bronzing; Liquid cement for coating articles; New process for producing a bronze-colored surface on iron; Painting on zinc	414

To cleanse brass; To color soft solder yellow	415
BUILDING MATERIALS:	
Fire-resisting properties of building materials; Cork stone; Enamelled bricks	415
Mass for roofing, fire-proof ceilings, floors, etc.; Plaster for ceilings; Terra-cotta lumber; Utilization of saw-dust	416
CELLULOID. IMITATIONS, SUBSTITUTES, ETC.:	
Artificial ivory; Celluloid printing plates	416
Elastic mass resembling leather; Flexible insulating mass; Insulating material for electrical conductors; Mass for plastic models; New imitation of ivory; New substitute for caoutchouc	417
Substitute for gutta-percha; Superior modelling wax; Vegetable leather	418
CEMENT WORK:	
Water-proof cement work	418
CLEANSING, POLISHING, AND RENOVATING AGENTS:	
Cleaning-powder for show-windows; Cleansing-rags for polishing metal; Cleansing wash-leather; Cloth-cleaning compound; Furniture renovator; Liquid polish for silver-plated ware; New polish for wood	419
Polishing soaps and pastes; Restoring plush; To clean glass and silver-ware; To clean marble	420
To cleanse silvered dial plates; To clean smoky walls	421
COLORS, ENAMELS, CEMENTS, GLUE, VARNISHES, WATER-PROOFING SUBSTANCES, ETC.:	
American wood-filler; Cement for mending enamelled dial plates; Crystalline coating for wood or paper; Enamel for fine cards and other purposes; Imitation of cinnabar	421
Enamel free from lead and metallic oxides for iron and sheet-iron, and utensils manufactured from them; New method for the production of water-proof and incombustible fabrics; Phosphorescent enamel; Preparation of lustre colors with carbolic acid; Bismuth, tin, uranium, and iron lustres	422
Soap varnishes; Johnson's varnish for water-proofing paper or cloth; Soap varnish for gilding; Water-proof glue	423
COPYING:	
New method of copying drawings; Phytochromotypy	423
EXPLOSIVE AGENTS:	
Blasting cartridges; Blasting paper; Explosive combination; Explosive substance; Explosive and pyrotechnic substances; Method of blasting under water with compressed gun-cotton	424
New blasting powder; New method of preparing giant powder; Preparation of hypouitric acid and its use for explosive and illuminating substances	425
GLASS:	
Appert's method of blowing glass by means of compressed air	426
Cutting glass with a carbon pencil; Receipts for making carbon pencils	430
Etching ink for glass; Glass with copper lustre	431
Lead-pencils for glass and porcelain; Receipts for different colored pencils; Lithium glass; Manufacture of plate glass	432
Ornamenting frosted glass; To transfer photographs to glass; Platinizing glass; Toughened glass	434
HORN-COMBS, MANUFACTURE OF:	
Treatment of horn for manufacture of horn-combs	435
LUBRICANTS, BLACKING, ETC.:	
Belt grease	435
Caoutchouc lubricant for driving belts; Harness grease; Harness polish; Thurston's machine for testing lubricating oils	436
Lubricants; Experiments on the effect of admixture of mineral oil with animal oil in lessening the liability of the latter to spontaneous combustion; Purification of lubricants after use; New receipts for blacking	438

METAL INDUSTRY.

Hardening composition for steel; Iridium, its preparation and use; Mac- kiunon stylographic pen as made by John Holland (Cincinnati) . . .	439
Phosphor-iridium and its properties; Cowles' electric furnace for reducing refractory ores . . .	440
Fleetman's process of refining nickel; Ostberg's process for wrought-iron (or mitis) castings; Mechanically hardened steel; New solder for metal, glass, and porcelain; Oxidized silver	441
Phosphorizing bronze or brass	442
Prevention of rusting-in of screws; To mark tools with a name; Utiliza- tion of nickel waste; Zincing screw bolts	443

MISCELLANEOUS:

Continuously-working furnace for the manufacture of animal charcoal . . .	444
Gilding and silvering leather; Coating leaden water pipes to prevent con- tamination of the water supply; New floor covering; New process of manufacturing gold wall paper	445
Phosphorescent mixtures; Preparation of precipitated chalk for tooth- powders; Process of joining two pieces of horn; To make horn combs elastic; Roach and moth exterminator; Shaving cream	446
To preserve India rubber goods from becoming hard and cracking; To render rubber hose odorless; Washing white straw hats; Window panes which indicate the moisture of the atmosphere	447

OILS AND FATS:

Bleaching of bone-fat; Bleaching of paraffine and similar substances for the manufacture of candles; Bleaching of oils and fats	447
Bleaching tallow	448
Clarifying olive oil; Detection of water in essential oils; Manufacture of cotton-seed oil	449
Fat from sheep's wool; "Suint," or potassic sudorate in sheep's wool . . .	450
Refining of cotton-seed oil; Production of light-colored soap, or light- colored sebacic acids, from crude cotton-seed oil, or from residues obtained by its purification; To remove the disagreeable odor of soap made from cotton-seed oil; Utilizing cotton-seed hulls; New process of extracting fish oil; Preparation of heavy oils and paraffine from petro- leum residues	451
Purification of oils; Solidification of liquid hydrocarbons; Substitute for linseed oil; To purify oils	452
White vaseline oil; Solvent power of glycerine; Tables showing the parts of other substances dissolved by 100 parts (by weight) of glycerine . . .	453

PAPER:

Cupro-ammonium for rendering paper and textile fabrics water-, rot-, and insect-proof (Willesdenizing)	453
Fabrication of parchment; Fire-proof papers, colors, and printed matter; Gas-pipes from paper; Luminous paper	454
Manufacture of bottles, etc., from paper; New method of manufacturing paper pulp; Paper for covering boilers; Preparation of soap paper; To make parchment paper impermeable to oil	455

STRAW, BLEACHING AND DYEING OF:

Bleaching straw	455
Dyeing straw of various colors	456

STRENGTH OF MATERIALS:

Thurston's autographic torsion testing machine	456
--	-----

WILLOW-WARE:

Bleaching willow-ware; Stains for willow-ware; Receipts for various colors	458
Coloring osiers with aniline colors	459
Varnishing, gilding, and painting willow-ware	460

INDEX	461
-----------------	-----

TECHNO-CHEMICAL RECEIPT BOOK.

ADULTERATIONS, IMITATIONS, ETC. HOW TO DETECT THEM.

Olive Oil. The following process of testing olive oil for cotton-seed oil has been authorized by the Italian Government: Mix 1 part of pure nitric acid with $2\frac{1}{2}$ parts of the oil to be tested. Place a clean copper wire in the mixture, and stir thoroughly with a glass rod. The oil, if it contains cotton-seed oil, will turn red in the course of half an hour.

Animal Charcoal. To detect adulterations of animal charcoal used in the manufacture of sugar, place a weighed quantity of the suspected charcoal, previously finely powdered and dried, in a porcelain crucible, and heat until all organic substances have been incinerated. Not more than *one-tenth* of the weight should be lost by this operation. To determine whether the charcoal has been used before, boil the sample several times with pure water, dry, add a small quantity of potassium hydrate and bring again to the boiling point. After a few minutes, filter. If the filtrate appears colored, the charcoal has already been used, and not thoroughly revived.

Determination of Percentage of Oil in Seeds. The apparatus, Fig. 1, consists of the vessel *a*; the cylindrical vessel *b*, and a small air pump *c* on the side of the vessel *a*. Further, of a small copper still, *d* (Fig. 2), and a boiler *e*, a tinned copper saucer *g*, and the water-bath *h*. The lower half of this is perforated, and connected with the still by a rubber hose.

A convenient quantity, say 4 oz., of the seed to be tested is ground as fine as possible. One-half of it is placed in the cylindrical vessel *b*, a diaphragm placed upon it, and on the top of this, the second half of the seed, also covered

by a diaphragm. A sufficient quantity of bisulphide of carbon, to thoroughly

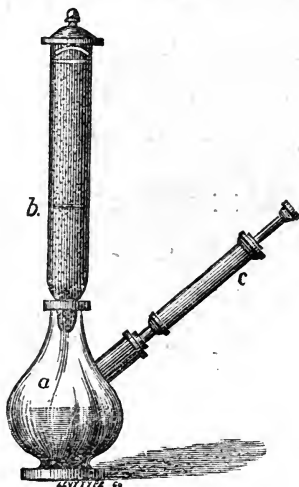

Fig. 1.

moisten the seed, is then poured over it. After a few minutes the vessel *a* is



Fig. 2.

emptied by means of the air pump *c*, the oily bisulphide of carbon runs off,

the vessel is charged anew with bisulphide, and the pumping and charging repeated, until the liquid runs off quite colorless, and leaves no grease stain upon printing paper after evaporation. Four ounces of seed will usually require about 16 ounces of bisulphide of carbon.

To separate the bisulphide of carbon from the oil, the still is filled three quarters full with water, heated by a lamp placed under it, and the fluid to be evaporated poured into the saucer. When the bisulphide of carbon has been evaporated, the still is removed, the saucer placed over the lamp, and removed the moment the oil commences to boil. It is then allowed to cool off, and the oil contained in the saucer is weighed. By this process it was found that

Rape seed . . .	yielded 40 to 50 per cent. of oil.
Flaxseed . . .	“ 34 “ “ “ “
White poppy seed . . .	“ 46 “ “ “ “
Peanuts . . .	“ 38 “ “ “ “
Water melon seed . . .	“ 36 “ “ “ “
White mustard seed . . .	“ 30 “ “ “ “
Black mustard seed . . .	“ 29 “ “ “ “
Hemp seed . . .	“ 28 “ “ “ “

Vinegar may be adulterated :

a. *With Sulphuric Acid.* To detect this adulteration mix a small sample with some powdered starch, boil it for half an hour, then allow it to become entirely cold (this is absolutely necessary); and add a few drops of iodine solution. The vinegar, in case it is adulterated, will be colored blue.

b. *With Nitric Acid.* Mix a sample with solution of sulphate of indigo. The fluid becomes discolored, or assumes a yellowish color, if adulterated.

c. *Tartaric Acid.* A specimen of the vinegar to be tested is evaporated nearly to dryness. The residue is extracted with alcohol, filtered and treated with a solution of potassium chloride. A white precipitate indicates adulteration.

d. *Lead* is present when a sample of vinegar is evaporated to one quarter of its volume, and this, being treated with sulphuric acid, yields a white precipitate.

Saffron. Concentrated sulphuric acid is the surest means of testing saffron. The stigmas of the genuine article will immediately assume an indigo color, which changes quickly into dark red and brown, while the leaves of *crocus vernus*, the most common adulteration of saffron, are colored dark green.

Asphaltum. To detect adulterations, dissolve a sample in bisulphide of carbon, filter, evaporate to dryness, and heat until it can be rubbed to a fine powder in a mortar. One part by weight of this is gently digested with 50 parts of sulphuric acid for twenty-four hours, and then gradually with 100 parts of water, and allowed to cool thoroughly. This mixture is filtered and diluted with 1,000 parts of water. The unadulterated asphaltum gives a colorless or pale-yellow fluid, while, if pitch, coal-tar, etc., are present, it is dark brown or black.

Simple Process of Distinguishing Genuine Gilding and Silvering from Imitations. a. *Gilding.* Diluted solution of chloride of copper produces a black discoloration on imitation gilding, but has no effect whatever upon the genuine. b. *Silvering.* A mixture of equal parts of bi-chromate of potassium and nitric acid produces a red coloration on genuine silvering, while it has no effect upon the imitation.

Milk. Besides the common method of diluting milk with water, another species of adulteration has recently been detected. It is now frequently sophisticated with dextrine. This fraud can easily be detected by means of a solution of iodine; if the specimen contains the smallest quantity of dextrine, it will acquire a red color.

Adulteration of Wax with Tallow. Wax floats in alcohol of 29°. By observing the strength of the alcohol in which the sample floats, the percentage of wax may be deduced as follows :

If the alcoholometer shows :	The wax contains wax :
29°	100 per cent.
39.63°	75 “ “
50.25°	50 “ “
60.87°	25 “ “
71.50°	0 “ “

To Test Dyes for Adulteration. Red dyes must neither color soap solution nor limewater, nor must they themselves become yellow or brown after boiling. This test shows the presence or absence of Brazil-wood, archil, safflower, sanders-wood or the aniline colors. Yellow dyes must stand being boiled with alcohol, water and lime water. The most stable yellow is madder yellow; the least stable are anotto and turmeric, while fustic is rather better. Blue dyes must not color alcohol red, nor must they decompose on boiling with hydrochloric acid. The best purple colors are composed of indigo and cochineal or purpurin. The test for blue applies also to them. Orange dyes must not color water, boiling water, alcohol, nor hydrochloric acid green. Brown dyes must not lose their color on standing with alcohol, or on boiling with water. If black colors have a basis of indigo, they turn green or blue on boiling with sodium carbonate; if the dye be pure gallnuts, it turns brown. If the material changes to red, on boiling with hydrochloric acid, the coloring substance is logwood without a basis of indigo, and is not durable. If it changes to blue, indigo is present.

To Detect Alum in Red Wine. Boil a sample of the wine for a few minutes. Pure wine remains unchanged, while the adulterated article becomes turbid.

Simple Method for Distinguishing Genuine Butter from Artificial. Heat the suspected butter in a crucible or test-tube, to about 300° to 320° F. At this temperature artificial butter froths but little, and the mass exhibits irregular movements resembling those of boiling, accompanied by sudden, forcible shocks which frequently throw a part of the fat from the crucible. Casein at the same time is separated and forms on the edge of the crucible in small balls, which assume a brown tint, while the fat retains its original color. Genuine butter, under these circumstances, foams copiously, the agitation occasioned by boiling is not nearly so forcible, and the entire mass assumes a uniform brown color.

W. G. Crock melts and filters the suspected butter. He then takes 10 grains of this, heats it in a test-glass,

150.8 F., then adds 30 minims of phenole, shakes the mixture and heats it in a water bath until the fluid becomes transparent. The test-glass is then allowed to stand quietly for some time. Genuine butter will give a clear solution, but suet, tallow or lard forms two separate layers of fluid, the upper of which becomes turbid on cooling.

ALLOYS.

Alloys for Tea Pots. 88.55 parts of tin, 9.53 of antimony, 9.94 of zinc, 0.88 of copper.

Oroide. This alloy, resembling gold (specific gravity 8.79), consists of 68.21 parts of copper, 13.52 of zinc, 0.48 of tin and 0.24 of iron.

Britannia Metal. Köller prepares this as follows: 85.72 parts of tin, 10.34 of antimony, 2.91 of zinc, 0.78 of copper.

Alloys for Taking Impressions of Coins, Medals, Wood Cuts, etc. Melt at as moderate a heat as possible, 4 parts of bismuth, 2½ of lead, 2 of tin and 1 of worn-out metal types.

Chrysoline. This alloy, in color, closely resembles 18 to 20 carat gold. It has a beautiful lustre and does not tarnish when exposed to the air. It consists of 100 parts of copper and 50 of zinc. It is used, like *Prince's metal*, for watch cases and parts of the works.

Prince's metal consists of 6 parts of copper and 1 of tin, and resembles gold in color.

Pinchbeck. This alloy, resembling gold in color, derives its name from the English town *Pinchbeck*, where it was first manufactured, and consists of 90 parts of copper and 30 of zinc.

Robertson's Alloy for Filling Teeth. 1 part of gold, 3 of silver and 2 of tin. First melt the gold and silver in a crucible, and at the moment of fusion add the tin. The alloy, when cold, may be finely pulverized. Equal quantities of the powder and mercury are kneaded together in the palm of the hand to form a paste for filling teeth.

Aluminium Alloys. Aluminium forms alloys with many metals. Those with copper, silver and tin are to some extent employed for technical purposes, the most important being those with

copper, with which aluminium can easily be alloyed. Lange & Sons have obtained a patent in the United States for an alloy consisting of 95 parts of aluminium and 5 of copper, which is malleable, and used for clock springs. Ten parts of aluminium and 90 of copper give a hard alloy, but nevertheless ductile. It takes a high polish, resembles gold and is but little attacked by ammonium hydrosulphide.

Aluminium Bronzes contain from 6 to 10 per cent. of aluminium. They are prepared by fusing chemically pure copper with aluminium. Aluminium bronze, consisting of 90 parts of copper and 10 of aluminium, is used more than any other composition. It gives sharp castings, is more easily worked than steel, may be engraved, rolled in sheets, and when exposed to the air suffers less change than brass, silver, cast-iron or steel. It is serviceable for ornamental articles, household utensils, parts of geodetical and astronomical instruments, pivots, gun and cannon barrels. Aluminium bronze can only be soldered with an aluminium alloy.

Aluminium Alloy for Soldering Aluminium. I. Melt 20 parts of aluminium in a crucible. Then add gradually 80 part of zinc, and when this is melted some fat. Stir the mass with an iron rod and pour into moulds.

II. Take 15 parts of aluminium and 85 of zinc.

III. Or, 12 parts of aluminium and 88 of zinc.

IV. Or, 8 parts of aluminium and 92 of zinc. All these alloys are prepared as indicated above.

The *flux* consists of a mixture of 3 parts of copaiba balsam, 1 of Venetian turpentine and a few drops of lemon juice. The soldering iron is dipped into this mixture.

Silver and Aluminium are very easily alloyed. The alloys are harder than aluminium, but more easily worked.

An alloy of 3 parts of silver and 97 of aluminium has a beautiful color, and is not affected by ammonium hydrosulphide.

Equal parts by weight of silver and aluminium give an alloy as hard as bronze.

An alloy of 5 parts of silver and 100

of aluminium can be worked like pure aluminium. It is harder than the latter, and takes a very high polish.

An alloy with one-tenth per cent. of gold is as ductile as pure aluminium, but harder, although not as hard as that with 5 parts of silver.

An alloy of 95 per cent. of aluminium and 5 of silver is white, elastic and hard. It is used for blades of dessert and fruit knives.

Gold and Aluminium. 99 parts of gold and 1 of aluminium give a very hard but not ductile alloy, possessing the color of green gold.

An alloy of 90 parts of gold and 10 of aluminium is white, crystalline and brittle.

Ninety-five parts of gold and 5 of aluminium give an alloy as brittle as glass.

An alloy, the color of which resembles gold so closely as to defy detection, is obtained by fusing together 90 to 100 parts of copper, 5 to 7½ of aluminium, and 2½ of gold. The resulting alloy is used for jewelry as a substitute for gold.

Zinc and Aluminium. These alloys are very hard and take a beautiful polish. 3 parts of zinc and 97 of aluminium give an alloy as white as the pure metal, very ductile and harder than aluminium. It is the best of all alloys of zinc with aluminium.

An alloy of 30 parts of aluminium and 70 of zinc is white, very brittle and crystalline.

Tin and aluminium give brittle alloys when they contain little tin and much aluminium, but those with a small quantity of the latter are very ductile, and may be used as substitutes for tin. They are harder and more elastic.

An alloy of 3 parts of aluminium and 100 of tin is hard, and but little affected by acids.

Five parts of aluminium and 95 to 100 of tin give a useful alloy.

With *bismuth and platinum* aluminium gives very brittle alloys.

Lead and aluminium do not alloy.

With *iron* aluminium alloys so easily that the iron rods used in preparing aluminium become coated with a lustrous covering, giving them the appearance of being tinned.

According to *Tissier*, a slight percentage of iron exerts an injurious influence upon aluminium. He claims that 5 per cent. makes the aluminium hard and brittle, and so refractory that the pure metal can be fused upon the alloy. *Debray*, on the other hand, asserts that 7 to 9 per cent. of iron produces no perceptible change in the properties of aluminium. Iron can be easily separated from aluminium by fusing the alloy with saltpetre, which oxidizes the iron.

Roger claims that the presence of aluminium in steel makes it very hard, and gives to it the properties of "wootz," or Indian steel. When steel contains but 0.008 per cent. of aluminium, the articles manufactured from it, when etched with sulphuric acid, will show wavy lines like Damascus steel.

American Sleigh Bells. These bells, excelling in beauty, fine tone and small specific weight, are manufactured by fusing together 10 parts of nickel and 60 parts of copper. When this alloy has become cold, add 10 parts of zinc and two-fifths parts of aluminium, fuse the mass and allow it to cool; then remelt it with the addition of two-fifths parts of mercury and 60 parts of melted copper.

Platinum Bronze. By alloying nickel with a small quantity of platinum, it loses its slight tendency to oxidation, and is not affected by acetic acid. To prepare the alloy, the nickel is fused with the platinum and definite quantities of tin, *without* the aid of a fluxing agent. The following alloys may be used:

	PARTS.			
	Nickel.	Plati- num.	Tin.	Sil- ver.
For knives and forks . . .	100	1	10	
" bells	100	1	20	2
" fancy articles	100	$\frac{1}{2}$	15	
" telescopes and opera glasses	100	20	20	

The following alloy will not oxidize: 120 parts of brass, 60 of nickel, 5 to 10 of platinum.

White Metal. Fuse together 750 parts of copper, 140 of nickel, 20 of black cobaltic oxide, 18 of tin, 72 of zinc.

Alloys Resembling Silver. I. 25 per cent. of manganese, 55 of copper, and 20 of zinc.

II. 5 per cent. of manganese, 10 of nickel, 45 of copper, and 40 of zinc.

III. 5 per cent. of iron, 20 of manganese, 6.5 of nickel, and 57 of copper.

New Nickel Alloy. Fuse together in a reverberatory furnace 20 cwt. of finely powdered nickel sesquioxide and 1 to 2 cwt. of copper with 2 cwt. of fluor-spar, or 1 cwt. of cryolite and 2 cwt. of anthracite coal. Purify the resulting alloy in any known manner.

A nickel alloy in great demand for technical purposes has been prepared by *Christoffe* and *Bouilhet*. It consists of 50 per cent. of nickel and 50 of copper, can be easily remelted, and is especially adapted for the manufacture of argentan (German silver). An alloy with 15 per cent. of nickel is remarkable for its ductility, homogeneity and white color. It can be rolled out into sheets about one-twentieth millimetre (0.019 inch) thick, and drawn out into wire of any desired diameter. It is used for ornaments of every kind.

Lutecine, or Paris Metal. Eight hundred parts of copper, 160 of nickel, 20 of tin, 10 of cobalt, 5 of iron, and 5 of zinc.

A new and very Fusible Alloy. Fuse a mixture of 79 per cent. of cast-iron, 19.50 of tin, and 1.50 of lead. This alloy has a beautiful appearance, fills the mould completely, and is therefore well adapted for casting small articles. It is malleable to a certain extent.

Wood's metal, fusing below 158° F., consists of:

	PARTS.			
	I.	II.	III.	IV.
Bismuth	49.87	49.89	49.81	49.72
Lead	26.81	26.73	26.80	26.90
Tin	13.25	13.36	13.53	13.41
Cadmium	10.13	9.93	9.69	10.10

According to *Lipowitz*, an alloy consisting of 3 parts of cadmium, 4 of tin, 8 of lead, and 15 of bismuth, becomes soft between 122° and 140° F., and entirely liquid at 140° F.; while *Wood* found that the mixture most easily fusible became sufficiently liquid for casting purposes at 159.8° F. and congealed at 150° F., and therefore he fixed

its melting point as between 150° and 159.8° F. The following proportions give the lowest melting points in both cases, 150° F. or very close to it:

	PARTS.	
Cadmium	1	3
Tin	1	4
Lead	2	8
Bismuth	4	15

Type Metal. The following are some of the principal alloys made for this purpose:

Type Metal.	PARTS.						
	Lead.	Antimony.	Tin.	Copper.	Zinc.	Nickel.	Cobalt. Bismuth. Aluminium.
Ordinary	75-80	20-25		0.4			
French	55	30	15				
English							
No. 1	55	22.7	22.3				
English							
No. 2	61.3	18.5	20.7				
English							
No. 3	69.2	19.5	9.1	1.7			
Ehrhardt's							
No. 1	3		4	4	80		
Ehrhardt's							
No. 2	2		3	2	93		
Besley's	100	30	20	8		8	5
Cambrien's				50			10

Alloy for Music-Printing Plates, etc. Ten parts of tin, 12 of zinc, 3 of antimony regulus, 1 of copper, and 74 of lead. *Jean*, who introduced this compound, calls it "heterogeneous alloy."

Spence's Metal. This new compound, discovered by *Spence*, and used in England for manifold purposes, is obtained by melting the three sulphides of iron, zinc and lead with sulphur. The product is a dark gray mass of great tenacity, small power of conducting heat, a specific gravity of 3.4, and melting point at about 320° F. In congealing it expands like bismuth and type metal, and resists in a remarkable degree the action of atmospheric influences, alkalies and acids, even of *aqua regia*; its surface being scarcely affected after having been exposed to the action of the latter for four weeks. Its property of expanding in congeal-

ing, and therefore filling completely all depressions of the mould, makes it particularly available for castings. If the compound is poured upon a plate on which the impression of the hand has been made, the cast will show all the lines and pores of the palm.

In England it has been lately used for jointing gas and water pipes.

New Alloys for Journal Boxes.

	Babbitt's Metal.	English White Metal.
Lead	5 per cent.	33.0 per cent.
Copper	4	2.4
Zinc	69	1.0
Antimony	3	10.6
Tin	19	53.0
Specific gravity	8.32	7.22
Melting point	170° F.	290° F.

Alloys for Dental Purposes.

	PARTS.		
	A.	B.	C.
Tin	91.63	36.78	51.72
Silver	3.82	48.32	34.35
Copper	4.4		
Gold		14.72	
Mercury			8.52

Manganese Bronze. Fifty per cent. of sesquioxide of manganese, 35 of cupric oxide, 15 of coal, all finely powdered. To this are added 2½ to 10 parts of organic substance, as tar, starch (2 parts of starch and 3 of water), etc.

Alloys which can be rolled when at a red heat consist of:

	PARTS.		
	I.	II.	III.
Manganese	25.50	13.00	22.25
Copper	54.50	55.50	52.25
Zinc	20.00	31.50	25.50

If it is not necessary for the alloy to be rolled while red hot, iron may advantageously be introduced. The following proportions may be used:

	PARTS.	
	I.	II.
Iron	5.88 per cent.	5.00 per cent.
Manganese	26.35	20.00
Copper	56.00	57.00
Zinc	11.77	11.50
Nickel		6.50

The alloys are very white, and, when cast and worked, give a very clear tone, making them available for spoons and forks.

Unalterable Alloy. This is used for objects of art, imitation jewelry, etc. It has a yellowish-red tint, and when treated with polysulphides, chloride of antimony, chloride of arsenic, etc., it becomes coated with a black patina, capable of being polished. It consists of 70 to 73 per cent. of copper, 2 to 11 of tin, 15 to 20 of lead, 0.5 to 1 of zinc.

Chinese and Japanese Bronzes. Some bronzes exhibited at the last Paris Exhibition attracted especial attention, not only on account of their artistic beauty, but also on account of the unusually deep bronze color, which in many specimens presented a beautiful dead black appearance. The color, which was doubtless intended to contrast with the silver of the filigree work, was proved to belong to the substance proper of the bronze, and not to have been artificially produced by an application upon its surface. Analysis of the different specimens of the bronze gave the following results:

	PARTS.		
	I.	II.	III.
Tin	4.36	5.52	7.27
Copper	82.72	72.09	72.32
Lead	9.9	20.31	14.59
Iron	0.55	1.73	0.28
Zinc	1.86	0.67	6.00
Arsenic		traces	
	99.39	100.32	100.46

These alloys contain a much larger proportion of lead than is found in ordinary bronze; and it is noticeable that the quantity of lead augments precisely with the intensity of the bronze color, proving, as before stated, that the latter is due to the special composition of the bronze.

Some of the specimens contain a considerable proportion of zinc, but the presence of this metal, instead of improving the appearance, seemed rather to counterbalance the effect of the lead.

In imitation of the Chinese bronze, some alloys were made of the following composition:

	I.	II.
Tin	5.5 parts.	5.0 parts.
Copper	72.5 "	83.0 "
Lead	20.0 "	10.0 "
Iron	1.5 "	
Zinc	0.5 "	2.0 "

NO. I. produced an alloy exceedingly difficult to work, and, without giving any superior results as regards color, furnished castings which were extremely brittle.

NO. II., on the contrary, gave an alloy exactly resembling the Chinese bronze. Its fracture and polish were identical, and when heated in a muffle it quickly assumed the peculiar dead-black appearance so greatly admired in the Chinese specimens.

Hitherto it has been found difficult, if not impossible, to obtain this depth of color with bronzes of modern art; since the surface scales off when heated under similar conditions.

Bronze for Objects of Art. The proportions used by Keller Bros., during the time of Louis XIV., are generally employed in Paris at the present day. The bronze consists of 91.60 per cent. of copper, 5.33 of zinc, 1.70 of tin, and 1.37 of lead. Somewhat more zinc is taken for articles to be gilded.

Chinese Silver. 2.05 parts of silver, 65.24 of copper, 19.52 of zinc, 13 of nickel, 0.12 of cobalt and iron. Utensils of every kind manufactured from this alloy are, it is claimed, preferable to silver, as they are not affected by boiling vinegar, as is the case with genuine and German silver.

Composition for Metal Stop Cocks which deposits no Verdigris. Seventy-two parts of zinc, 21 of tin, and 7 of copper.

Alloy for Anti-friction Brasses. Eighty parts of zinc, 14 of tin, 5 of copper, and 1 of nickel.

Fenton's Alloy for Axle Boxes for Locomotives and Wagons. Eighty parts of zinc, 5½ of copper, 14½ of tin. This alloy may be recommended as regards cheapness and lightness. Experiments have shown that boxes of this alloy require but half as much oil for lubricating as others. The components can be melted in an ordinary iron boiler, and the alloy is less difficult to work than brass.

ENGLISH COPPER ALLOYS.

Brass. Thirty parts of zinc and 70 of copper, in small pieces.

Brass for Turned Articles. One hundred parts of copper, 50 parts of zinc, and ½ to 1½ parts of lead.

Red Bronze for Turned Articles. One hundred and twenty parts of copper, 25 parts of zinc, $2\frac{1}{2}$ parts of lead. The lead is added during casting.

Another Receipt. Eighty parts of copper, 25 of zinc, 5 of lead, and 1.3 of antimony.

First Quality of Bronze for Castings. One hundred and twenty parts of copper, 25 of zinc, $\frac{3}{8}$ of bismuth.

Ordinary Bronze for Castings. One hundred parts of copper, $6\frac{1}{2}$ of zinc, $12\frac{1}{2}$ of tin.

Bronze for Hard Castings. Twenty-five parts of copper, 2 of zinc, $4\frac{1}{2}$ of tin.

Bronze. Seven parts of copper, 3 of zinc, and 2 of tin; or, 1 part of copper, 12 of zinc, and 8 of tin.

Coin Metal. Six parts of copper and 4 of tin. This alloy can be rolled, and is treated warm.

Metal for Gongs and Bells. One hundred parts of copper with about 25 of tin. To give this alloy a very clear tone, the castings are heated, and then dipped in cold water.

Another Receipt. A composition of 78 parts of copper and 22 of tin gives very satisfactory results, and can be rolled.

Bell Metal (Best Quality). Seventy-one parts of copper, 26 of tin, 2 of zinc, and 1 of iron.

For Large Bells. One hundred parts of copper and 20 to 25 of tin.

For Small Bells. Three parts of copper and 1 of tin.

Bronze for Cocks. Twenty parts of copper, 8 of lead, $\frac{2}{3}$ of litharge, $1\frac{1}{2}$ of antimony.

Statuary Bronze. 91.4 parts of copper, 5.53 of zinc, 1.7 of tin, 1.37 of lead; or, 80 parts of copper and 20 of tin.

Bronze for Medals. Fifty parts of copper and 4 of tin.

Bronze for Rivets. Sixty-four parts of copper and 1 of tin.

Bronze for Ornaments. Eighty-two parts of copper, 3 of tin, 18 of zinc, 2 of lead; or, 83 parts of copper, 17 of zinc, 1 of tin, and $\frac{1}{2}$ of lead.

New Alloy Resembling Gold. (Patented by Meiffren of Marseilles.) Eight hundred parts of copper, 25 of platinum, and 20 of tungstic acid are melted

together with a flux in a crucible. The mass, when melted, is granulated by pouring it into alkaline water. The alloy is then melted with 170 parts of gold.

To Prepare an Alloy Resembling Silver. Sixty-five parts of iron are melted with 4 of tungstic acid, and granulated; and also 23 parts of nickel, 5 of aluminium, and 5 of copper. To avoid oxidation, a piece of sodium is placed in the crucible. The granulated metals are then melted together. This alloy resists the action of hydrogen sulphide.

Alloy for Imitation Gold and Silver Wires. In place of copper, generally used, *Hélouis* of Paris employs argentan, composed as follows: 70 per cent. of copper, 15 of nickel, and 15 of zinc. From this alloy he has drawn wire as fine as 0.01 inch in diameter.

Minargent. This new alloy contains 100 parts of copper, 70 of nickel, 5 of tungsten, and 1 of aluminium.

Composition of some Alloys.	PARTS.				
	Copper.	Tin.	Zinc.	Lead.	Antimony.
Ordinary sheet brass and wire. No. 1 . . .	70		30		
Ordinary sheet brass and wire. No. 2 . . .	64.8	0.4	32.8	2	
Brass of a light yellow color	66.6		33.3		
Tombac	83.4		16.6		
Red brass	91		9		
Bell metal	80		20		
Gun metal and medical bronze	90	10			
Alloy for journal boxes, soft	82	16	2		
Alloy for journal boxes, hard	22.2	33.3			44.4
Alloy for valves and piston rings	80	60		1.25	
Alloy for chilled work No. 1	5		85		10
Alloy for chilled work No. 2	5.5	14.5	80		
Alloy for chilled work No. 3	2	80			18
Alloy for chilled work white, and brittle	13.3	73.3			13.4
Alloy for gongs	80	20			
Statuary metal	91.4	1.7	5.33	1.37	

ARTIFICIAL GEMS, PEARLS, AND
TURKISH BEADS.

The art of imitating gems consists simply in the production of a glass possessing greater hardness and density than the ordinary product, and colored to simulate the precious stones. These properties are imparted to the flux, partly by special treatment, partly by admixtures, but principally by the purity of the substances used. Besides the essential components, lead oxide, minium, etc., are added to the fluxes. These impart greater density to the glass, more lustre and specific gravity. But too much lead oxide must be avoided, as it disintegrates the surface and spoils the lustre. A great degree of hardness can be obtained by using large proportions of silica, but the flux becomes refractory, to prevent which borax is added.

The following requisites will be necessary for mixing a good flux :

1. Pure silica. It is best to use for this finely-powdered rock crystal.
2. Pure potash or soda.
3. Borax.
4. Lead oxide, carbonate, or minium.
5. A little saltpetre, partly to promote the fusion, but especially to destroy by oxidation any carbonaceous impurities which might injure the color.
6. A metallic oxide to give color to the flux ; but of this usually very little must be taken.

It is best to fuse the mass in a new Hessian crucible. It is filled about half full with the flux, which has been finely powdered and sifted through a fine sieve, and is then covered with a clay plate.

The glass-melting furnace manufactured by *Th. Jesem*, of Berlin, is decidedly the best to use. It has been introduced almost everywhere, as it excels in suitability of construction and cheapness. Fig. 3 represents a cross-section of this furnace. *a* is the gas-conducting pipe from which the pipes *b b* branch off.

The upper end of the pipes *b* is bent inward. The gas flame is under the fire-brick furnace *k*, the thick walls of which form the hearth. The bottom is provided with an opening through which the gases enter into the crucible *h*, placed exactly over it, in order to

circulate around the actual crucible *f* containing the flux, and resting upon a support of fire-clay *e*, and the movable rod *c*. The gases, after playing around *f*, pass out through a hole in the cover

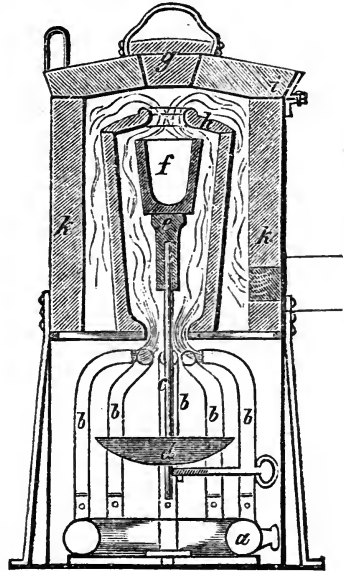

Fig. 3.

of the crucible *h* and then around and down the walls of *h* towards the escape pipe. The cover *i* moves on a hinge joint.

Schrader, who made these combinations a special study for many years, uses the following mixture for fluxes. Powder and mix :

Rock crystal	29.23 parts.
Dry sodium carbonate	14.61 "
Calcined borax	10.96 "
Minium	7.20 "
Saltpetre	1.21 to 3.65 "

The mixture is fused in the manner indicated above.

A harder flux is obtained by mixing the following proportions:

Rock crystal	43.84 parts.
Powdered dry sodium carbonate	14.61 "
Calcined and powdered borax	10.96 "
Minium	7.20 "
Saltpetre	1.21 "

Pure flint finely powdered may be used instead of rock crystal, or white powdered glass, but in the latter case some white arsenic must be added to obtain the frit entirely colorless.

A flux so hard that it will emit sparks when struck with a steel can be prepared from the following substances:

Powdered glass	29.23 parts.
Rock crystal	10.96 "
Minium	10.96 "
Calcined borax	7.20 "
Saltpetre	2.43 "
Arsenic	0.60 "

Donault-Wieland recommends the following proportions:

	PARTS.			
	I.	II.	III.	IV.
Rock crystal	300	300		100
Minium	470	462		160
Potash purified with alcohol	163	163	96	
Borax	22	18	27	66
Arsenious acid	1	½	1	5
Very white sand			300	
Very pure white lead			514	
Saltpetre				22

These fluxes furnish the "strass" which is the basis for the manufacture of artificial gems.

Ruby. The following mixtures, according to *Schrader*, are the best for manufacturing imitations of this beautiful gem. Powder and mix:

	PARTS.	
	I.	II.
Rock crystal	29.23	29.23
Dry sodium carbonate	14.61	14.61
Calcined borax	10.96	4.84
Saltpetre	5.47	2.43
Purple of Cassius	3.65	0.91
Antimony trisulphide	0.48	
Manganese peroxide	0.48	
Minium	10.96	
Sal ammoniac		3.65

D. C. Splittgerber gives the following receipt for a beautiful ruby glass:

Fine white quartz sand	1650.0 parts.
Dry white soda	966.6 "
Chalk, marble, or calcium carbonate	433.3 "
White arsenic	133.3 "
Minium	150.0 "
Antimony bisulphide	133.3 "

Mix the sand intimately with a solution of a ducat (about two dollars gold value) and then add the other ingredients. Expose the mixture for thirty

hours to a white heat in a plate-glass furnace. When poured out and cold it is entirely colorless and transparent, and only assumes a beautiful ruby color after heating to a moderate red heat, 932° F. If exposed to a very strong heat it acquires a liver color. Glass prepared with purple of Cassius has a more violet shade of color.

Sapphire. Powder and mix:

	PARTS.	
	I.	II.
Rock crystal	43.84	29.23
Sodium carbonate	21.92	14.61
Calcined borax	7.20	10.96
Minium	7.20	5.47
Saltpetre	3.65	1.82
Cobalt carbonate	0.06	
Copper carbonate		1.82

Emerald. This is prepared with copper and iron. Powder and mix:

Rock crystal	43.84 parts.
Dry sodium carbonate	21.92 "
Calcined borax	7.20 "
Minium	7.20 "
Saltpetre	3.65 "
Red ferric oxide	1.21 "
Green copper carbonate	0.60 "

A beautiful green is obtained by using the following ingredients. Powder and mix:

Rock crystal	43.84 parts.
Dry sodium carbonate	14.61 "
Calcined borax	7.20 "
Minium	7.20 "
Saltpetre	2.43 "
Cobalt carbonate	0.09 "
Chrome green	0.30 "

Uranic oxide, which, as a general rule, gives yellow colors shading only slightly into green, furnishes an *emerald* green when used in the following proportions. Powder and mix:

Rock crystal	36.43 parts.
Dry sodium carbonate	10.96 "
Minium	7.20 "
Saltpetre	3.65 "
Uranic oxide	2.43 "
Green copper carbonate	0.18 "
Stannic oxide	0.18 "
Calcined bones	0.18 "

Chrysoprase. The following mixture is decidedly the best for imitating the transparent, apple-green color of this stone. Powder and mix:

Rock crystal	43.84 parts.
Dry sodium carbonate	14.61 "
Calcined borax	10.96 "
Minium	7.20 "
Saltpetre	1.21 "
Calcined bones	7.20 "
Copper carbonate	0.12 "
Ferric oxide	0.24 "
Chrome green	0.36 "

This mixture gives the *dark chryso-prase*.

A *lighter shade* is obtained by taking one-quarter of the three metallic oxides, but retaining the same proportions of the other ingredients. Several different shades can be produced by varying the proportions of the three metallic oxides.

Opal. Powder and mix :

Rock crystal	32.29 parts.
Sodium carbonate	10.96 "
Calcined borax	7.20 "
Minium	5.47 "
Saltpetre	0.91 "
Purple of Cassius	0.06 "
Calcined bones	0.09 "
Silver chloride	0.12 "

Beryl, or Aqua Marine. Powder and mix :

Rock crystal	43.84 parts.
Sodium carbonate	14.61 "
Calcined borax	10.96 "
Minium	7.20 "
Saltpetre	3.65 "
Ferric oxide	0.36 "
Copper carbonate	0.12 "

Instead of the last two ingredients the following may be used :

Ferric oxide	0.24 parts.
Cobalt carbonate	0.01 "

Hyacinth. Antimony trioxide and antimony trisulphide have been recommended for this. By adding to this mixture manganese, or manganese with some iron,

Garnet is obtained as follows: Powder and mix :

Rock crystal	32.29 parts.
Sodium carbonate	10.96 "
Calcined borax	7.93 "
Minium	5.47 "
Saltpetre	2.43 "
Pyrolusite	0.30 "
Ferric oxide	0.18 "

If a brighter color is desired add 0.06 parts of purple of Cassius to the mixture.

Tourmaline of a reddish-brown
Color is obtained by using nickel.
Powder and mix :

Rock crystal	29.23 parts.
Sodium carbonate	14.61 "
Calcined borax	10.96 "
Minium	5.47 "
Saltpetre	5.47 "
Nickel sesquioxide	0.48 "

Tourmaline of a greenish-blue Color.
This is obtained by powdering and mixing:

Glass	58.44 parts.
Rock crystal	21.92 "
Minium	21.92 "
Calcined borax	14.61 "
Saltpetre	2.43 "
Cobalt carbonate	0.09 "

Topaz and Chrysolite may accidentally be obtained if iron should be present in the mixture. They may also be produced by using 0.30 parts of yellow uranic oxide in the above mixture, instead of cobaltic oxide.

Chrysolite. A good dark chrysolite is obtained by powdering and mixing:

Rock crystal	21.92 parts.
Sodium carbonate	7.20 "
Calcined borax	5.47 "
Minium	3.65 "
Saltpetre	0.60 "
Pyrolusite	0.12 "

Amethyst is prepared by using radiated pyrolusite, but not more than 0.06 parts of it must be taken for a frit producing about 30 parts of flux. Powdered glass in the proportion of 30 parts, 3.65 of saltpetre, and some borax and minium gives also a good imitation of the amethyst.

Lapis Lazuli. This is produced by using a cobalt flux, to which is added some admixture which will dim the mass. Powder and mix :

Rock crystal	21.92 parts.
Sodium carbonate	7.20 "
Calcined borax	5.47 "
Minium	3.65 "
Saltpetre	1.00 "
Calcined bones	3.65 "
Cobaltic oxide	0.12 "

Agate can be imitated by allowing fragments of different fluxes to run together, stirring the mass in the meanwhile.

Schrader has obtained several varieties of agate by mixing about 1.82 parts of ferric oxide with 43.84 of flux.

R. Wagner suggests the following method of producing artificial gems: 2 parts of pure silica (rock crystal), 1 of calcined soda, $\frac{2}{3}$ of anhydrous borax, $\frac{1}{2}$ of lead oxide (massicot), are rubbed together as intimately as possible, and heated in a crucible for one hour without allowing the mass to become liquid. It is then brought into fusion and kept so for one hour, when it is allowed to congeal. It is then moderately heated for 24 hours, and the resulting flux taken from the crucible, cut and ground.

This forms the base for the flux of the artificial gems. The following minerals are added as coloring substances:

Blue: Cobaltic oxide.

Yellow: Antimony pentoxide.

Green: Cupric oxide.

Red: Purple of Cassius.

Violet: Black oxide of manganese.

Artificial Pearls. Geissler's Process.

The principal constituents of these pearls are hollow glass beads, silver from the scales of *Cyprinus alburnus* (a species of carp), fish glue, isinglass, and wax. The so-called silver is first obtained from the scales of the fish, cleansed, mixed with the dissolved isinglass, and blown into the hollow beads by means of a special apparatus. While doing this the beads must be constantly revolved in order that the color may be uniformly deposited on the sides. They are then allowed to lie quietly for a few days to allow the color to become dry and hard. Filling the beads with wax gives them a more beautiful and pellucid lustre and greater durability. The manufacture of artificial pearls is tedious, as every pearl must be handled five or six times, but as the work can be done by girls and children, it is possible to produce them at astonishing low prices.

Turkish Beads. Dissolve 4 parts of catechu in 16 of rose water. Strain and reduce the solution by boiling to 6 parts. Then add to it: 1 part of powdered Florentine orris root, $\frac{1}{2}$ of musk, 20 drops of oil of bergamot or lavender, and $\frac{1}{4}$ part of swelled isinglass, and knead the whole to a paste. Form of

this, first, round sticks, and then small balls, either in the hollow of the hand or by a special machine. Pierce the balls with a needle dipped in oil of almonds or of jasmine. Then pour oil of almonds or of jasmine over them and allow them to dry. Different colors and perfumes can be given to them by adding coloring substances and sweet smelling oils.

BITTERS, CORDIALS, ELIXIRS, LIQUEURS, RATAFIAS AND ESSENCES; EXTRACTS, TINCTURES AND WATERS USED IN THEIR MANUFACTURE, AND THE MANNER OF COLORING THEM.

Most of the bitters, cordials, liqueurs, etc., are produced in the cold way, either by mixing a solution of oil in alcohol with a warm solution of sugar in water, or by adding to this solution tinctures or essences, and diluting the mixture with the quantity of water required. As every cordial or liqueur appears turbid after mixing it, clarification becomes necessary. For ordinary qualities a solution of one-half ounce of alum in a pint of water for every 20 gallons of cordial can be recommended, and if this has not the desired effect, a solution of one ounce of soda in a pint of water may be added to the same quantity of cordial. But for the finer brands it is better to use a solution of 4 ounces of isinglass to a pint of water.

Mode of Coloring Cordials, Liqueurs, etc. Cordials and liqueurs should be colored after they have been filtered. A large number of cordials are not colored, especially anisette, bergamot, calamus, cardamon, caraway, fennel and maraschino.

Coffee, chocolate, curaçoa, nut, and most bitters are colored brown.

Barbadoes and orange blossoms cordials, dark yellow or orange.

Anise, lemon, orange and peach, pale yellow.

The cordials prepared from fresh herbs, green.

Cherry, gold water, raspberry, strawberry, rose and nutmeg, red. We have added the color required to most of our receipts.

I. COLORING SUBSTANCES. *Blue.* Dissolve $\frac{1}{2}$ ounce of finely powdered

indigo in 2 ounces of sulphuric acid, and add 6 ounces of water to the solution.

Green. I. Boil 2 parts of liquid wash blue, 1 of powdered turmeric; add some alum to the mixture and filter it.

II. To obtain a fine green, mix the tinctures of yellow and blue as given under their respective headings.

Purple. Boil archil in water, and add some alum.

Red. I. Crush $\frac{1}{2}$ ounce of cochineal and 15 grains of alum; pour over the powder 8 ounces of boiling water and filter the fluid. The color is made darker or lighter according to the quantity of cochineal used.

II. Macerate 1 lb. of bilberries in 2 quarts of alcohol for 2 days, press the mass through a linen cloth and filter the fluid.

III. Macerate 3 ounces of finely powdered cochineal in 3 pints of alcohol for 2 days, then add $\frac{1}{4}$ ounce of powdered alum, and filter the fluid.

Yellow. I. Macerate 1 ounce of genuine saffron in 3 pints of alcohol, and then filter the fluid.

II. Take a quantity of marigolds according to the shade of color to be produced, steep them in alcohol, and filter the fluid, when it has assumed the desired shade of color.

II. ESSENCES, EXTRACTS, TINCTURES AND WATERS. *Absinthe Tincture.* Dissolve 2 fluid drachms of oil of wormwood, $1\frac{1}{2}$ fluid drachms of oil of badian seed, $1\frac{1}{4}$ fluid drachms each of oil of anise seed, oil of fennel and oil of coriander seed; $\frac{3}{4}$ fluid drachm each oil of Crete marjoram (origan) and of oil of angelica, and 20 drops of oil of cardamon, 2 gallons of rectified spirits of 90 per cent. Tr.; dilute the solution with $2\frac{1}{2}$ quarts of water, and color it green.

Ambergris Essence. Pour 12 fluid ounces of spirit of wine of 90 per cent. Tr. over 1 ounce of coarsely powdered ambergris, and let it stand for a few days. Then draw off the liquid, extract the residue with spirit of wine, filter the extract, and add it to the other portion.

Angelica Essence. Mix by shaking $\frac{1}{2}$ fluid ounce of pure angelica oil with 1 quart of alcohol of 90 per cent. Tr.

Anise-seed Essence. Distil 1 pound of crushed anise seed, $1\frac{1}{2}$ gallons of strong rectified spirit, and $\frac{1}{2}$ pint of water. Add to this $\frac{3}{4}$ fluid ounce of anise seed oil and $\frac{1}{2}$ gallon of rectified spirit, and clarify the mixture with 1 ounce of alum.

Anise-seed Extract. Dissolve by shaking 40 drops of anise seed oil, 4 drops of fennel oil, and 2 drops of coriander seed oil in 3 pints of rectified spirit of 90 per cent. Tr.

Anise-seed Tincture. Dissolve 2 fluid drachms of anise seed oil and $1\frac{1}{2}$ fluid drachms of badian seed oil in 2 gallons of rectified spirit of 90 per cent. Tr.; dilute the solution with $\frac{1}{2}$ gallon of water, and color it green, as above.

Aromatic Tincture. Comminute 6 ounces of zedvary, 4 ounces each of calamus root, galanga and angelica root, $2\frac{1}{2}$ ounces of bay leaves, 2 ounces each of cloves, cinnamon blossoms and scraped orange peel, 3 ounces of Roman camomile, $\frac{1}{2}$ ounce of ginger, and $\frac{1}{2}$ ounce of mace. Pour $1\frac{3}{4}$ gallons of rectified spirit of 90 per cent. Tr. over the ingredients, and let them macerate for 8 days, then filter, and add 40 drops of oil of peppermint and $2\frac{1}{2}$ quarts of water.

Barbadoes Essence. Mix 25 drops of oil of lemon, 25 of oil of bergamot, 6 each of oil of cinnamon, oil of cloves and oil of nutmeg, with 1 gallon of rectified spirit of 90 per cent. Tr., shake the mixture thoroughly, and filter it.

Bergamot Essence. Dissolve $\frac{1}{4}$ fluid ounce of oil of bergamot in $\frac{1}{2}$ gallon of spirit of wine of 90 per cent. Tr.

Bitter Almond Essence. Crush 9 ounces of bitter almonds, place them into a still with $2\frac{1}{2}$ gallons of water, let them macerate for 12 hours; then add $2\frac{3}{4}$ gallons of spirit of wine of 90 per cent. Tr., and distil off a distillate 75 per cent. strong.

Or, Pour $3\frac{1}{2}$ quarts of strong rye whiskey over 1 pound of crushed apricot kernels, 4 ounces of cherry kernels, 1 fluid drachm of cloves, and $\frac{1}{2}$ fluid drachm of mace, and distil off 3 quarts of essence of bitter almonds, or kernel extract.

Or, Dissolve 1 fluid drachm of oil of bitter almonds in 3 quarts of rectified spirit of 90 per cent. Tr., and store the fluid for some time before using it.

Bitter Essence (Single). Macerate $\frac{1}{2}$ ounce of dried orange peel, $\frac{1}{4}$ ounce of calamus root cut in small pieces in $1\frac{1}{2}$ quarts of spirit of wine of 90 per cent. Tr. Let the mass stand for 2 days and then filter it.

Bitter Essence (Double). Comminute $2\frac{1}{2}$ ounces of leaves of common buck bean, $1\frac{1}{2}$ ounces each of germander water, dried orange peel, and leaves of wormwood, and $\frac{1}{2}$ ounce each of cinnamon and gentian root. Pour $1\frac{1}{2}$ gallons of rectified spirit of 90 per cent. Tr. over the ingredients and let them digest for 2 days, when the fluid is drawn off and filtered.

Bitter Extract for Grünwald Bitters. Comminute 2 ounces of orange peel, $\frac{1}{2}$ ounce each of gentian root, leaves of common buck bean, and galanga, $\frac{1}{4}$ ounce of leaves of blessed thistle, and 1 drachm of leaves of wormwood. Put the ingredients in a suitable flask, pour $1\frac{1}{2}$ gallons of spirit of wine 90 per cent. strong over them, place them in a warm place and let them digest. Then draw off the fluid, press out the residue, add the extract to the first fluid, and filter it through porous paper.

Calamus Tincture. Dissolve 1 fluid ounce of oil of calamus in 2 quarts of rectified spirit of 90 per cent. Tr.

Or, Comminute 15 ounces of calamus root and 1 ounce of angelica root. Pour 5 gallons of whiskey, 45 per cent. strong, over the roots, let them macerate for 2 days, and then distil off 3 gallons of essence 75 per cent. strong.

Caraway Essence (Cumin Essence). Pour 5 gallons of spirits of wine, 50 per cent. strong, over:

Crushed caraway seed	2 lbs.
Crushed anise seed	1 oz.
Crushed fennel seed	1 oz.
Orris root cut in pieces	$1\frac{1}{2}$ oz.
Powdered cinnamon	$\frac{1}{2}$ oz.

Let the mass digest for 24 hours, and then distil off a distillate 85 per cent. strong.

Cardamon Extract. Peel and comminute $4\frac{1}{2}$ ounces of cardamons, pour $2\frac{1}{2}$ pints of rectified spirit of 90 per cent. Tr. over them, add and mix thoroughly with it $1\frac{1}{2}$ fluid drachms of oil of cardamon, and let the entire mass digest for 2 days, when the fluid is drawn off and filtered.

Or, Mix $1\frac{1}{2}$ fluid drachms of oil of

cardamon with $1\frac{1}{2}$ quarts of rectified spirit of 90 per cent. Tr. and filter the fluid through porous paper.

Cherry Extract. Press out the flesh of ripe cherries, let the mass stand quietly in a moderately warm room until the pure juice has separated from the pulp. Then place the mass in a bag, press the juice out, let it stand for a few hours longer, and add an equal quantity of rectified spirit of 90 per cent. Tr.

Cherry Water. Distil $5\frac{1}{2}$ pounds of crushed cherry stones with $7\frac{1}{2}$ gallons of water, add $4\frac{1}{2}$ to 5 gallons of cherries, and distil off 3 to $4\frac{1}{2}$ gallons of cherry water.

Chocolate Essence. Pour $2\frac{1}{2}$ quarts of spirit of wine over $12\frac{1}{2}$ ounces of roasted and ground cocoa beans, $\frac{1}{2}$ ounce of powdered cinnamon, and $\frac{1}{4}$ ounce of powdered cloves; let the ingredients digest and filter the fluid.

Cinnamon Essence. Dissolve $\frac{1}{2}$ fluid ounce of oil of cinnamon in $1\frac{1}{2}$ quarts of rectified spirit of 85 per cent. Tr., and filter the solution.

Clove Essence. Comminute 9 ounces of cloves, pour $1\frac{1}{2}$ quarts of rectified spirit of 90 per cent. Tr. over them, let them digest for a few days, and then filter the fluid.

Coffee Essence. Pour $1\frac{1}{2}$ quarts of rectified spirit of 90 per cent. Tr. over $5\frac{1}{2}$ ounces of finely-roasted and ground coffee, let it digest for some time, draw off the fluid and filter it.

Cognac Essence. Dissolve $3\frac{1}{2}$ fluid ounces of sulphuric ether in $\frac{1}{2}$ gallon of alcohol of 90 per cent. Tr.

English Bitters Essence. Comminute $\frac{3}{4}$ ounce each of leaves of wormwood, leaves of centaury, and leaves of blessed thistle; $\frac{1}{2}$ ounce each of gentian root, china root, and orange peel; $\frac{1}{4}$ ounce of orris root, and 1 ounce of grains of Paradise. Pour $1\frac{1}{2}$ quarts of rectified spirit of 90 per cent. Tr. over these ingredients, let them digest for some time, then pour the fluid off and filter it.

Fennel Essence. Dissolve 1 fluid drachm of oil of fennel, $\frac{1}{4}$ drachm each of anise seed oil and oil of lemon, and 10 drops of cumin oil in $1\frac{1}{2}$ quarts of rectified spirit of 90 per cent. Tr.

Gold Water Essence. Dissolve 4 fluid drachms of oil of lemon, 2 fluid drachms of oil of orange, 1 fluid drachm

each of rose oil, oil of nutmeg, and oil of cinnamon, $\frac{1}{2}$ fluid drachm each of oil of calamus, oil of lavender, and oil of juniper, and $\frac{1}{2}$ fluid drachm of oil of cloves in $\frac{1}{2}$ gallon of rectified spirit of 90 per cent. Tr., and filter the solution.

Herb Cordial Essence. Comminute $\frac{1}{2}$ ounce each of orange peel and lemon peel, $\frac{1}{2}$ ounce of calamus root, $\frac{1}{4}$ ounce each of juniper berries, ginger, orris root, angelica root, and coriander seed, and 1 ounce each of galanga, leaves of marjoram, and leaves of rosemary. Pour 1 gallon of rectified spirit of 90 per cent. Tr. over these ingredients, let them digest for some time, then press out the fluid and filter it.

Juniper Berry Essence. Dissolve 1 to $1\frac{1}{2}$ fluid ounces of oil of juniper in $1\frac{1}{4}$ quarts of rectified spirit of 90 per cent. Tr. and filter the solution.

Or, Distil $1\frac{1}{2}$ pounds of crushed juniper berries, $1\frac{1}{2}$ ounces of bruised anise seed, and 3 ounces of powdered cinnamon, with whiskey sufficient to give a distillate of 3 gallons 75 per cent. strong.

Lavender Essence. Dissolve $\frac{1}{2}$ fluid ounce of oil of lavender in $3\frac{1}{2}$ quarts of rectified spirit of 90 per cent. Tr., and filter the solution.

Lemon Essence. Dissolve 2 fluid drachms of oil of lemon in $1\frac{1}{2}$ quarts of rectified spirit of 85 per cent. Tr., and shake the solution thoroughly.

Mace Extract. Pour $3\frac{1}{2}$ quarts of rectified spirit of 90 per cent. Tr. over 2 ounces of mace, let it digest for a few days, and then filter the fluid.

Marjoram Essence. Dissolve $\frac{1}{2}$ ounce of oil of marjoram in $3\frac{1}{2}$ quarts of rectified spirit of 90 per cent. Tr., and filter the solution.

Musk Essence. Pour $1\frac{1}{4}$ pints of rectified spirit of 90 per cent. Tr. over 1 drachm of powdered musk and $\frac{1}{2}$ drachm of pulverized gray ambergris. Let the ingredients macerate for a few days and then draw off the clear fluid. Extract the residue with spirit of wine, filter the extract and add it to the first portion.

Nut Essence. Crush 50 large green walnuts, pour $1\frac{1}{2}$ gallons of rectified spirit of 90 per cent. Tr. over them, let them digest for a few days and press out the fluid. Distil the residue with sufficient whiskey to give a distillate 80

per cent. strong, and add this to the first essence.

Nutmeg Essence. Comminute $8\frac{3}{4}$ ounces of nutmegs, pour 6 gallons of rectified spirit of 90 per cent. Tr. over them, let them digest for a few days and then filter the fluid.

Orange Blossom Extract. Pour $1\frac{1}{4}$ pints of boiling milk over $10\frac{1}{2}$ ounces of fresh orange blossoms; place the same on the fire and let it boil up; then add and thoroughly mix with it 3 quarts of rectified spirit of 90 per cent. Tr., and add $1\frac{1}{4}$ quarts of champagne to the filtrate.

Orange Blossom Water. Distil 11 pounds of preserved orange blossoms in 6 gallons of water, so that the distillate will amount to 3 to $3\frac{1}{2}$ gallons of aromatic water.

Orange blossoms are preserved in the following manner: Put a handful of salt on the bottom of an earthen jar, place upon this a layer of orange blossoms, and repeat this alternately until the jar is filled. By keeping the jar in a cool place the orange blossoms will remain fresh for a long time. *Rose leaves* are preserved in the same manner.

Orange Juice. Mix the juice of 12 or more oranges with 12 fluid ounces of rectified spirit of 90 per cent. Tr. When the sediment has all settled to the bottom, draw the fluid off and filter it.

Orange Peel Extract. Crush in a stone mortar the rinds of 12 oranges with some sugar, and let the mass digest for a few days by placing it in $\frac{1}{2}$ gallon of rectified spirit of 90 per cent. Tr. Then decant the clear fluid and filter it.

Parfait D'Amour Essence. Dissolve $\frac{1}{2}$ fluid ounce of oil of cinnamon, 6 fluid drachms each of oil of cardamon, oil of rosemary, and anise seed oil, and 20 minims each of oil of lemon, oil of orange, oil of cloves, oil of camomile, and oil of lavender in $1\frac{1}{4}$ quarts of rectified spirit of 90 per cent. Tr. Shake the solution thoroughly and filter it.

Peach Essence. Dissolve 1 fluid drachm of oil of bitter almonds in $3\frac{1}{2}$ quarts of rectified spirit of 90 per cent. Tr., allow the solution to stand for a few days, and then filter it.

Or, Crush $8\frac{3}{4}$ ounces bitter almonds, put them in a still, pour $2\frac{1}{2}$ gallons of

water over them, and let them digest for 12 hours. Then add 2½ gallons of spirit of wine, and distil off a distillate 75 per cent. strong.

Peppermint Essence. Dissolve ¾ to 1 ounce of oil of peppermint in 2½ quarts of rectified spirit of 90 per cent. Tr.

Peppermint Essence may also be prepared by steeping 1 part of the leaves of the plant in 3 of spirit of wine 90 per cent. strong. After remaining in the spirit for 5 or 6 days, the clear fluid is poured off, the residue pressed, and the extract filtered and added to the clear fluid.

Quince Essence. Grate the quinces, press the juice out, add equal parts by weight of rectified spirit of 85 per cent. Tr.; let the mass stand until it settles and then filter.

Raspberry Extract. Crush 2 pounds of ripe raspberries, press them out and add 2 quarts of rectified spirit of 90 per cent. Tr.

Or, Take freshly picked raspberries, place them in an earthen dish, crush them to a pulp with a wooden spoon, and let this stand quietly in a moderately warm room until the pure juice has separated. Then place the pulp in a bag, press it out, let the juice stand for a few hours longer, and add the same quantity of rectified spirit of 90 per cent. Tr.

Raspberry Water. This is prepared from the residue left in preparing the extract by stirring it into a mash with water and distilling.

Rose Essence. Dissolve 2 fluid drachms of rose oil in 1½ quarts of rectified spirit of 90 per cent. Tr., and filter the solution.

Rose Water. Preserved rose leaves are distilled in the same manner as given under *Orange Blossom Water*.

Rosemary Essence. Mix 6 fluid drachms of oil of rosemary with 1½ quarts of rectified spirit of 90 per cent. Tr.; let the mixture stand for a few days and then filter it.

Sage Essence. Dissolve 1 fluid ounce of oil of garden sage in 1¾ pints of rectified spirit of 85 per cent. Tr.

Spanish Bitters Essence. Commi-
nute 6 parts of calamus root, 3½ each of centaury and polypody root, 3 of orris root, 2 each of galanga, leaves of

blessed thistle, elecampane root, and gentian root, and 1 each of leaves of wormwood, angelica root, and masterwort root. Pour 400 parts of rectified spirit, 90 per cent. strong, over the ingredients, let them digest for 48 hours, then press the fluid out and filter it.

Strawberry Extract. Bruise 4½ pounds of wild strawberries; pour 3 quarts of spirit of 90 per cent. Tr. over the mass; let it stand for some time and filter. The product will be about 1 gallon of strawberry essence.

Strengthening Tincture. Commi-
nute 4½ ounces each of gentian root, calamus root, and oak bark, 2 ounces each of orange peel and angelica root, 1 ounce of cinnamon, and ½ ounce each of cloves and ginger. Pour 1½ gallons of rectified spirit of 90 per cent. Tr., and 1½ quarts of water over the ingredients, and let them digest for eight days. Then filter the mass, add 40 minims of oil of wormwood, and a like quantity of oil of peppermint and oil of balm to the filtrate.

Vanilla Essence. Cut 2½ ounces of vanilla beans, pour 1½ quarts of rectified spirit of 90 per cent. Tr. over them; let them digest for some time, and filter the fluid. This essence should be kept in hermetically closed flasks.

Vanilla water may be made by pouring 1 gallon of water over the extracted residue.

Vanilla Tincture. Macerate ½ ounce of vanilla beans for 8 days in 2 fluid ounces of rectified spirit of 90 per cent. Tr., and filter the fluid.

Wormwood Essence. Commi-
nute ¾ ounce each of leaves of wormwood, leaves of centaury, and leaves of blessed thistle, ½ ounce each of gentian root, china root, and orange peel, ½ ounce of orris root, and 1 ounce of grains of Paradise. Pour 2½ pints of rectified spirit of 90 per cent. Tr. over the ingredients, let them digest for some time, and filter the fluid off.

III. ELIXIRS. *Abbé Elixir.* Commi-
nute 3½ pounds of lemon peel, 6½ ounces of nutmeg, and a like quantity of cloves. Place the ingredients in a wickered demijohn, and pour 20 gallons of 33 per cent. alcohol over them, and let them digest for 3 to 4 weeks, placing the demijohn in a warm place.

The mass is then strained through a cloth, the residue pressed out, the fluid filtered, and the filtrate compounded with a sufficient quantity of white sugar syrup.

Angel Elixir. Comminute and mix 4½ ounces of cinnamon, 2 ounces of galanga, 1½ ounces of cloves, 1 ounce each of nutmeg, orange peel, and lemon peel, ¾ ounce of ginger, ½ ounce each of orris root, zedvary, cubebs, and cardamons. Pour 3 pints of alcohol over the ingredients, and let them digest for 8 days. Then filter and add 2½ gallons of double distilled rose water, and 13 pounds of sugar syrup.

Elixir de St. Aur. Distil 9 ounces each of lavender blossoms, orange peel and rose leaves, 5½ ounces of lemon peel, 1 ounce each of cinnamon, cloves and nutmegs, with 5 gallons of alcohol and 4 gallons of water. Add 2½ quarts each of rose water, orange blossom water, balm water, and cinnamon water, and 30 pounds of sugar syrup to the distillate, and color it rose-red.

Elixir-Colombat. Dissolve 120 drops of oil of juniper, 40 each of oil of angelica, oil of wormwood, and oil of lemon, and 20 of oil of cinnamon in 1½ gallons of alcohol; add 2¾ pounds of sugar dissolved in 1½ gallons of water to the solution, and color it pale red.

Elixir of Life. Dissolve 2 fluid ounces of oil of wormwood and 1 fluid ounce each of oil of cardamon, oil of calamus, oil of nutmeg, and oil of orange peel, in 3½ gallons of alcohol 90 per cent. strong, and add ¾ of a gallon of water to the solution. Color the fluid brown with burned sugar.

Elixir Monpou. Dissolve 120 drops of oil of peppermint, 40 each of oil of balm, oil of orange peel, rose essence, and orange blossom essence; 32 each of oil of mace and oil of cloves, and 60 of vanilla tincture, in 1½ gallons of rectified spirit of 90 per cent. Tr.; sweeten the solution with a syrup made of 7 pounds of sugar and 1½ gallons of water. Color it rose-red.

Elixir des Troubadours. Macerate 2 pounds of musk roses, 1½ pounds of jasmine blossoms, 9 ounces of orange blossoms, 2½ drachms of mace in 3½ gallons of whiskey, 22 per cent. strong. Let the mass stand for 14 days; distil on the water bath, and add a syrup

made of 11 pounds of sugar and 3 quarts of water. Color rose-red.

Elixir Vital. Dissolve 120 drops of oil of bergamot, 32 each of oil of mace, oil of coriander seed, and oil of cloves; 24 each of cumin oil and oil of cinnamon, and 60 of vanilla tincture in 1½ gallons of rectified spirit of 90 per cent. Tr.; sweeten the solution with a syrup made of 6½ pounds of sugar and 1½ gallons of water. Color green.

Juniper Elixir. Crush 4½ ounces of juniper berries, pour 1 gallon of spirit 22 per cent. strong over them, and let them digest for 4 weeks. Then strain the fluid off, and add a syrup made of 9 pounds of sugar and 1½ quarts of water.

Taboutrey Elixir. Comminute ½ ounce of aloes, 2 ounces each of cinnamon and walnuts, 4½ ounces each of orange peel and lemon peel, and 1 ounce of cloves. Pour 2¾ gallons of spirit of wine 33 per cent. strong over the ingredients, and let them digest for some time; then distil in a water bath, and add a syrup made of 13 pounds of pulverized sugar, and 1¾ quarts each of orange blossom water and rose water. This elixir is colored rose-red.

IV. BITTERS, CORDIALS, LIQUEURS AND RATAFIAS. *Anise-seed Cordial.* Dissolve 2 fluid drachms of anise-seed oil and 20 drops of badian seed oil in 1½ gallons of alcohol of 90 per cent. Tr. Compound this solution with 6½ pounds of sugar in 1½ gallons of water, and filter.

Another Recipe. Dissolve 2 fluid drachms of anise seed oil, 40 drops of fennel oil, 32 drops of cummin oil, and 30 drops of oil of lemon, in 2¾ gallons of spirit of wine. Mix with this a solution of 8¾ pounds of sugar in 2½ gallons of water, and store it away for 3 to 4 weeks. Then draw off the clear fluid, filter the sediment and color yellow.

Anisette Cordial. Dissolve 2 fluid drachms of anise seed oil and 18 drops of oil of bitter almonds in 1½ gallons of alcohol of 90 per cent. Tr.; add a solution of 5½ pounds of sugar in 1½ gallons of water, and filter.

French Anisette. Dissolve 2 fluid drachms of anise oil, 20 drops of oil of bitter almonds, and 2½ fluid ounces of cognac essence (see Essences) in 1½ gallons of alcohol of 90 per cent. Tr. Mix

this solution with one of 5½ pounds of sugar in 1½ gallons of water, and filter.

Holland Anisette. Dissolve 1 fluid drachm of anise oil, ½ fluid drachm of cognac essence, ¼ fluid drachm each of badian seed oil, oil of bitter almonds, and vanilla essence (see Essences), 1½ gallons of alcohol of 90 per cent. Tr. Mix the solution with one of 6 pounds of sugar in 1½ gallons of water, and filter.

Angelica Cordial. Macerate the following ingredients in 4 gallons of alcohol of 90 per cent. Tr., and expose them to a moderate heat for 4 days:

Lemon peel	8½	ounces.
Orange peel	5½	"
Mace	1½	"
Nutmeg	1½	"
Cassia	2½	"
Cloves	2	"
Orris root	1	"
Rosemary leaves	2	"
Lavender flowers	13	"
Marjoram	¾	"
Orange flowers	2¼	"
Vanilla	1½	"
Crushed juniper berries	2¼	"

Filter the mixture and compound the filtrate with a solution of 26 pounds of sugar in 2½ gallons of water.

Aqua Bianca. Dissolve 30 drops of oil of lemon, 27 drops of cedar oil, 33 drops of oil of balm, 30 drops of oil of peppermint, ½ fluid drachm of vanilla essence, and ½ fluid drachm of ambergris essence (see Essences), in 1½ gallons of alcohol of 90 per cent. Tr. Compound the fluid with a solution of 6½ pounds of sugar in 1½ gallons of water, and filter.

Aqua Reale. Dissolve 1 fluid drachm of oil of lemon, ¾ fluid drachm of oil of orange peel, 27 drops of oil of cinnamon, 30 drops of oil of cloves, 30 drops of oil of mace, 2 fluid drachms of vanilla essence, and ¾ fluid drachm of ambergris essence. Add to this solution one of 6½ pounds of sugar in 1 gallon of water, and filter.

Aqua-Turco Liqueur. Pour 2½ quarts of boiling water over 4½ ounces of imperial tea, ½ ounce of green tea, 1 ounce of black gunpowder tea, 1½ ounces of strong infusion of lime blossoms, and ½ ounce of angelica seed. Close the vessel tightly to prevent the vapors from escaping, until the infusion has become cold. Then draw off the clear fluid

and pour 2½ quarts of boiling water over the residue. Filter this infusion when cold and add it to the first infusion. Then add 28½ pounds of sugar and 2½ gallons of rectified spirit of wine. Clarify the fluid with the whites of 3 eggs and 1½ pints of sweet cream, and perfume it with some musk and spirit of ambergris. Finally, add 8½ fluid ounces of vanilla essence and let the fluid rest quietly for 24 hours. Then filter the liquor through a bag filled with animal or wood charcoal in order to obtain it entirely colorless.

Aromatic Cordial. Mix 30 drops of oil of lemon, 24 of oil of rosemary, 27 of oil of lavender, 30 of oil of peppermint, 27 of oil of angelica, 27 of oil of marjoram, and 33 of oil of cardamon with 1½ gallons of alcohol of 90 per cent. Tr. Shake thoroughly and then compound the solution with one of 5½ pounds of sugar in 1½ gallons of water, and filter.

Ambergris Water. Macerate 2 drachms of powdered gray ambergris, 30 grains of powdered musk, 80 grains of civet in 1½ pints of spirit of wine 40 per cent. strong, add ¼ ounce of refined sugar. Let the mixture stand for 14 days and then filter.

Berlin Bitters. Dissolve 80 drops of oil of juniper, 80 of oil of coriander, 40 each of oil of angelica and badian seed oil, and 44 drops of oil of ginger in 1½ gallons of alcohol of 80 per cent. Tr. To this solution add 1½ gallons of water and 1 pound of sugar. Filter and color brown.

Bitter-Rossoli. Comminute 8½ ounces of oranges and 4½ ounces of sandal wood. Add 2½ pounds of orange peel and 12 gallons of good rye whiskey. Let the mass digest for 14 days, then press, filter, and sweeten it with a solution of 3½ pounds of sugar in 1 pint of water.

Breslau Bitter Cordial.

Cassia	1½	pounds.
Cloves	5½	ounces.
Mint leaves	4¼	"
Caraway seed	2	"
Fennel seed	4½	"
Anise seed	8½	"
Coriander seed	2	"
Ginger	2½	"
Cubebs	2	"
Rosemary leaves	1½	"
Cardamons	4½	"
Juniper berries	5¼	"

Lavender blossoms	1½ ounces.
Nutmegs	4¼ "
Roman camomile	3 "
Orris root	3 "
Angelica	6½ "
Oranges	6½ "
Orange peel	7½ "
Lemon peel	10½ "
Gentian root	4¼ "
Oelanga	5¼ "
Calamus root	3 "
Wormwood	5¼ "
Alcohol of 90 per cent. Tr.	8 gallons.

Is sweetened with a solution of 58 pounds of brown sugar in 10 gallons of water and allowed to digest for 8 to 10 days, when it is filtered. This cordial is colored either dark yellow or dark red.

Calamus Liqueur. Macerate 9 pounds each of calamus root and of angelica root in 4½ gallons of alcohol of 90 per cent. Tr., and let it stand for 60 days. Then filter the fluid, sweeten it with a solution of 22 pounds of sugar in 1½ gallons of water, and color it red.

Cardinal Water. Distil:

Fresh lemon peel	3.3 pounds.
Balm	5½ ounces.
Anise seed	4½ "
Coriander seed	4½ "
Cinnamon	8¾ "
Mace	2¼ "
Nutmeg	1 "
Alcohol of 90 per cent. Tr.	4¾ gallons.
Water	4 "

Dissolve 26½ pounds of syrup in 5½ gallons of water; add the solution to the distillate. Color sky blue.

Cardinal de Rome. Dissolve 2 fluid drachms of oil of lemon, 1 fluid drachm of oil of cloves, 40 drops of oil of nutmeg, 20 drops of oil of cinnamon, and 4 grains of gray ambergris in 3 gallons of spirit of wine, sweeten the fluid with a solution of 11 pounds of sugar in 2½ gallons of water and filter.

Carminative Cordial. Distil:

Dried green orange peel	6½ ounces.
Dried green lemon peel	6½ "
Caraway seed	4½ "
Juniper berries	3¾ "
Anise seed	3¾ "
Camomile	3¼ "
Mint	2¼ "
Nutmeg	1 "
Alcohol of 90 per cent. Tr.	4¾ gallons.
Water	4 "

Add 27½ pounds of syrup and 3½ gallons of water to the distillate.

Capuchin Cordial. Dissolve 1½ fluid drachms of oil of parsley, 1 fluid drachm of oil of orange blossoms, 24 drops of oil of cinnamon, 1½ fluid drachms of cumin oil, and 20 drops each of anise seed oil, oil of mace, and fennel seed oil in 2 gallons of alcohol of 90 per cent. Tr.; sweeten the solution with a syrup made of 5½ pounds of sugar and 1½ gallons of water. Color brown.

Chartreuse. Three varieties of this liqueur, differently colored, are found in commerce. The following receipts can be highly recommended for manufacturing this liqueur.

	Green.	Yellow.	White.
	Ozs.	Ozs.	Ozs.
Mountain wormwood	1¾	¾	¾
Aloes		1½	
Angelica seed	¾	¾	¾
Angelica root	1½	¾	10 grains.
Arnica blossoms	1½	1½	
Buds of poplars	1		
Calamus root			1½ oz.
Cassia	¾	1½	1½ "
Cardamoms		10½	1½ "
Coriander seeds			35 grains.
Tonka beans			1½ oz.
Cloves		1½	1½ "
Hyssop in bloom	2	1	1½ "
Nutmeg	1½	1½	1½ "
Mace			1½ "
Balm	3½	1¾	1½ "
Peppermint	1¾		
Thyme	1¼		
Spirit of wine of 85 per cent. Tr.	2¾ gl.	1¾ gl.	2½ gl.
Sugar	11 lb.	11 lb.	16½ lb.

Macerate the herbs in the alcohol for about 36 to 48 hours, add a quantity of alcohol equal to that of the distillate, and rectify the resulting product with the addition of an equal quantity of water. Then mix the distillate with the cold solution of the sugar, and add a sufficient quantity of water, so that the entire product will amount to 4½ gallons; then color the liqueur green or yellow.

Cherry Liqueur. Mix 1½ gallons of cherry juice and 2½ gallons of pure alcohol, and dissolve in the mixture ¼ ounce of Indian balsam, 1 drachm each of oil of cinnamon and oil of bitter almonds, and 35 drops of oil of cloves. Sweeten the solution with 13½ pounds of syrup and 4½ pounds of white sugar dissolved in 4½ gallons of water, and after shaking the fluid thoroughly store it away until it becomes clear.

Cherry Cordial. To a mixture of 4½

pounds of cherry juice and 3 quarts of alcohol of 80 per cent. add 16 drops of oil of cloves, 1 pound of sugar, and 3½ quarts of water, and filter the cordial.

Chocolate Liqueur.

Cocoa beans moderately roasted and crushed	3½ pounds.
Finest cassia	3½ ounces.
Cloves	1½ "
Vanilla	5/8 "
Cardamons	1/2 "
Saffron	1/8 "
Cinnamon flowers	1½ "
Alcohol of 90 per cent. Tr.	2½ gallons.
Water	5¼ "
White sugar	28½ pounds.

Color dark red with cochineal.

Christoffe. Dissolve 80 drops of oil of orange peel, 60 of oil of lemon, 40 of oil of cinnamon, 40 of oil of balm, 32 of oil of cloves, and 24 of oil of mace in 13 pounds of alcohol of 90 per cent. Tr., add a solution of 5½ pounds of sugar in 1½ gallons of water and filter.

Citronelle. Commixute 8½ ounces of lemon peel, 3¼ ounces of orange peel, ¼ ounce of nutmegs, and ½ ounce of cloves. Pour 1¾ gallons rectified spirit of 90 per cent. Tr. over these ingredients and allow them to digest for 8 days, when they are pressed out and the fluid is filtered and compounded with a solution of 6½ pounds of sugar in 1½ gallons of water and the liqueur colored yellow.

Crambambuli. Mix 1 fluid drachm each of oil of cloves and oil of mace, ½ fluid drachm of oil of cinnamon, and 20 drops of oil of cardamon with 1¾ gallons of rectified spirit of 90 per cent. Tr. Sweeten the solution with a syrup made of 5½ pounds of sugar and 1½ gallons of water, and filter.

Danzig Crambambuli. Commixute 4½ ounces of cinnamon, 1 ounce of cloves, ½ ounce of ginger, 1 ounce of mace, and ½ ounce of anise seed. Pour 2¾ gallons of rectified spirit of 90 per cent. Tr. over these ingredients, let them digest for 14 days, then press them out, filter the fluid, and sweeten it with a solution of 8¾ pounds of sugar in 2¼ gallons of water.

Cumin Cordial (Kümmel). I. Dissolve 2 fluid drachms of cumin oil and 4 fluid drachms of anise seed oil in 1¾ gallons of rectified spirit of 90 per cent. Tr., and sweeten the solution with a syrup made of 6½ pounds of sugar and 1½ gallons of water.

II. 1½ fluid drachms of cumin oil, 24 drops of oil of coriander seed, 24 drops of oil of orange peel, 24 drops of cognac essence. Treat and sweeten in the same manner as No. I.

III. Dissolve 1½ fluid drachms of cumin oil, 24 drops of fennel oil, 12 drops of oil of cinnamon, in 1½ gallons of rectified spirit of 90 per cent. Tr. Sweeten the solution with a syrup made of 1½ pounds of sugar and 1½ gallons of water, and filter.

Cumin Liqueur. Macerate for 6 days 1 pound of caraway seed, 1 ounce of anise seed, ½ ounce of orris root, ½ ounce of cinnamon, ¼ ounce of angelica root, ½ ounce of cloves, in 2½ gallons of alcohol of 90 per cent. Tr. Sweeten the solution with a syrup made of 11 pounds of sugar and 2 gallons of water, and filter.

Curaçoa. Commixute 1 pound of fresh orange peel, ¼ ounce of nutmegs, 2 ounces of cinnamon. Pour 2 gallons of rectified spirit of 90 per cent. Tr. over them, allow them to digest for 8 to 10 days, and compound the filtered fluid with a solution of 6½ pounds of sugar in 1½ gallons of water.

French Curaçoa. Dissolve 1½ fluid drachms of oil of orange peel, 20 drops of oil of cinnamon, 12 drops of oil of mace, 30 drops of vanilla essence, 30 drops of raspberry essence, and 4½ fluid ounces of Jamaica rum in 1¾ gallons of rectified spirit of 90 per cent. Tr., and add a solution of 6½ pounds of sugar in 1½ gallons of water.

Holland Curaçoa. Dissolve 1½ fluid drachms of oil of orange peel, 20 drops of cognac essence, 8 drops of oil of lemon, 10 drops of oil of mace, and 1 fluid drachm of vanilla essence in 1¾ gallons of rectified spirit of 90 per cent. Tr., and compound the fluid with a solution of 6½ pounds of sugar in 1½ gallons of water. Color the liquor light brown.

Eau Americaine.

Orange peel	1 pound.
Rosemary leaves	4½ fluid oz.
Lavender blossoms	4½ "
Cinnamon	3½ "
Cloves	2¼ "
Nutmegs	1 "
Alcohol of 90 per cent. Tr.	4¾ gallons.
Water	4 "

Add to the distilled fluid 3 gallons of

water and 26 pounds of syrup, and color the distillate green.

Eau D'Amour. Distil:

Bitter almonds	13 $\frac{1}{4}$ ounces.
Fresh lemon peel	13 $\frac{1}{4}$ "
Cinnamon	6 $\frac{1}{2}$ "
Mace	1 "
Cloves	$\frac{1}{2}$ "
Lavender blossoms	9 "
Alcohol of 90 per cent. Tr.	4 $\frac{3}{4}$ gallons.
Water	4 "

Then add 1 $\frac{3}{4}$ gallons of Muscatel wine, 37 drops of ambergris essence, 22 pounds of syrup, and 1 $\frac{1}{2}$ gallons of water, and color the fluid rose-red.

Eau D'Argent. Distil:

Fresh lemon peel	1 pound.
Cloves	2 $\frac{1}{4}$ ounces.
Angelica seed	1 $\frac{3}{4}$ "
Badian seed	1 $\frac{3}{4}$ "
Floer-tine orris root	1 $\frac{3}{4}$ "
Cinnamon	4 $\frac{3}{4}$ "
Alcohol of 90 per cent. Tr.	4 $\frac{3}{4}$ gallons.

Add to the distillate 1 $\frac{3}{4}$ quarts of balm water, 26 $\frac{1}{2}$ pounds of sugar syrup, and 2 $\frac{3}{4}$ gallons of water. Color the fluid red, and mix some silver leaf macerated with honey with it.

Eau D'Ardelle. Distil 4 $\frac{1}{2}$ ounces each of mace and of cloves, 4 $\frac{3}{4}$ gallons of alcohol of 90 per cent. Tr., and 4 gallons of water. Mix with the distillate 3 $\frac{1}{4}$ gallons of syrup and 2 $\frac{3}{4}$ gallons of water, and color violet.

Eau D'Absynth Citronné. I. Distil 4 $\frac{1}{2}$ pounds of wormwood leaves, $\frac{3}{4}$ ounce of lemon peel, 4 $\frac{3}{4}$ gallons of alcohol of 90 per cent. Tr., and 4 gallons of water. Add to the distillate 1 $\frac{1}{4}$ fluid drachms of oil of peppermint, 26 $\frac{1}{2}$ pounds of syrup, and 3 $\frac{1}{2}$ gallons of water.

II. Dissolve 1 $\frac{1}{4}$ fluid drachms of oil of lemon, $\frac{3}{4}$ fluid drachm of oil of wormwood, 24 drops of oil of peppermint, 15 drops of anise seed oil, 1 $\frac{1}{4}$ fluid drachms of oil of cardamon in 1 $\frac{3}{4}$ gallons of rectified spirit of 90 per cent. Tr.; sweeten with a solution of 5 $\frac{1}{2}$ pounds of sugar in 1 $\frac{1}{2}$ gallons of water, and color green. The same quantity of oil of orange blossoms may be used instead of cardamon oil.

Eau De Cypre. Dissolve 1 $\frac{1}{4}$ fluid drachms of oil of lemon, 30 drops of oil of bergamot, 20 drops each of oil of cin-

namon, oil of orange blossoms and of vanilla essence, and 24 drops of oil of cardamon in 1 $\frac{3}{4}$ gallons of rectified spirit of 90 per cent. Tr., and sweeten with a solution of 6 $\frac{1}{2}$ pounds of sugar in 1 $\frac{1}{2}$ gallons of water. The liquor is left either colorless or colored pale yellow.

Eau de Dauphin. Dissolve 5 drops of oil of juniper, 20 drops each of angelica oil, coriander oil, and oil of ginger, 10 drops of oil of cardamon, and a like quantity of badian seed oil in 1 $\frac{3}{4}$ gallons of rectified spirit of 90 per cent. Tr.; sweeten by adding a solution of 3 $\frac{1}{2}$ pounds of sugar in 1 $\frac{1}{2}$ gallons of water, and filter.

Eau de Napoléon. Distil:

Fresh jasmine blossoms	6 $\frac{1}{2}$ ounces.
Fresh lemon peel	11 "
Cloves	3 $\frac{1}{4}$ "
Cinnamon	3 $\frac{1}{4}$ "
Nutmegs	2 $\frac{1}{4}$ "
Alcohol	5 gallons.

Then add to the distillate: 2 fluid drachms of vanilla essence, 3 $\frac{1}{2}$ quarts of double distilled rose water, 3 $\frac{1}{2}$ quarts of orange flower water, 1 $\frac{3}{4}$ quarts of peppermint water, 3 pounds of sugar syrup, 3 $\frac{1}{2}$ quarts of water, and color blue.

Eau D'Orient. Distil:

Fennel	1 pound.
Dates	3 $\frac{1}{4}$ "
Lemon peel	3 $\frac{1}{4}$ "
Orange peel	3 $\frac{1}{4}$ "
Pine apples	1 $\frac{1}{4}$ "
Grains of Paradise	2 ounces.
Calamus	2 $\frac{1}{4}$ "
Allspice	2 "
Alcohol of 90 per cent. Tr.	4 $\frac{3}{4}$ gallons.
Water	4 "

Add to the distillate 2 $\frac{1}{2}$ gallons of sugar syrup and 5 $\frac{1}{4}$ gallons of water, and color blue.

Eau D'Or (Gold water). Dissolve $\frac{3}{4}$ fluid drachm of oil of lemon, 24 drops of oil of cinnamon, 24 drops of oil of coriander, 20 drops of oil of mace, 15 drops of oil of orange blossoms in 1 $\frac{3}{4}$ gallons of rectified spirit of 90 per cent. Tr., and sweeten by adding a solution of 7 pounds of sugar in 1 $\frac{3}{4}$ gallons of water. Color the fluid pale yellow, filter, and add a small quantity of finely macerated gold leaf.

Eau de Paradise (Paradise Water).

Distil:

Fresh lemon peel	2¼ pounds.
Angelica root	¾ ounces.
Orris root	2 "
Calamus	2¾ "
Anise seed	2¾ "
Rosewood	2 "
Cardamoms	1 "
Alcohol of 90 per cent. Tr.	4¾ gallons.

Add to the distillate 26½ pounds of sugar syrup and 3 gallons of water. Color green and add some silver leaf rubbed fine.

Eau des Princesses. Dissolve 80 drops of oil of lemon, 80 of oil of bergamot, 40 of oil of cloves, 40 of oil of balm, 20 each of oil of cinnamon, oil of bitter almonds, and oil of peppermint, 60 of vanilla essence, and 40 each of rose essence and orange blossom essence in 2 gallons of rectified spirit of 90 per cent. Tr., sweeten with a solution of 7¾ pounds of sugar in 1½ gallons of water, and filter.

Eau Precieuse. Comminute 4¼ ounces of rosewood and a like quantity of bitter almonds, and let the mass digest for 6 to 10 days in 3 gallons of rectified spirit. Then press out, filter, and add to the filtrate 20 drops of oil of cloves, 12 of oil of lemon, and 12 of oil of nutmeg, and also a solution of 8¾ pounds of sugar in 2¼ gallons of water. This liquor is colored green, and a small quantity of silver leaf macerated in alcohol is added.

Eau Royale. Distil:

Lemon peel	11 ounces.
Orange peel	11 "
Jasmine blossoms	8¾ "
Mace	4½ "
Cinnamon	4½ "
Cloves	2½ "
Nutmeg	1 "
Alcohol of 90 per cent. Tr.	4¾ gallons.
Water	1¾ "

Add to the distillate 20 drops of ambergris essence, 2 fluid ounces of vanilla essence, a like quantity of orange flower water, 2½ gallons of water, 26½ pounds of sugar syrup, and color the fluid red.

Eau de Santé. Mix 4 fluid drachms of oil of lemon, ¾ fluid drachm each of oil of rosemary, oil of lavender, oil of peppermint, oil of angelica, oil of marjoram, and oil of eubeb, and 13½ pounds of sugar in 3 gallons of rectified

spirit of 90 per cent. Tr. Color the solution green and filter.

Eau de Sept Graines (Water of Seven Seeds). Comminute ½ ounce each of anise seed, fennel seed, caraway seed, and coriander seed, and 6 grains each of dill seed and of wild thyme seed. Macerate the seeds for about 14 days in 3½ quarts of French brandy, then filter, and sweeten with a solution of 2¾ pounds of sugar in ¾ of a pint of water.

English Bitters. I. Compound 4¼ ounces of English Bitters essence (see *Essences*) and ¾ fluid drachm of cognac essence; sweeten the liquid with a solution of 4½ pounds of sugar in 1½ gallons of water, filter, and color brown.

II. Compound 80 drops of oil of orange peel, 60 of oil of angelica, 40 of oil of wormwood, 24 of oil of marjoram, and 16 of oil of cardamon with 1¾ gallons rectified spirit of 90 per cent. Tr.; sweeten the solution with 5½ pounds of sugar in 1½ gallons of water, filter, and color brown.

Greek Bitters. Dissolve 80 drops of oil of lemon, 48 of oil of wormwood, 40 each of oil of angelica and oil of calamus, 24 each of oil of mace, oil of cloves, oil of bitter almonds, and 12 of cardamon oil, in 1¾ gallons of rectified spirit of 90 per cent. Tr.; sweeten this solution with a syrup of 6 pounds of sugar and 1½ gallons of water, filter, and color reddish brown.

Hamburg Bitters. Dissolve 120 drops of oil of cinnamon blossoms, 40 each of oil of cloves, oil of calamus, and oil of wormwood, 24 of oil of mace, and 20 of oil of cardamon, in 1¾ gallons of rectified spirit of 90 per cent. Tr., and add a solution of 5½ pounds of sugar in 1½ gallons of water; filter the fluid and color it brown.

Juniper Liqueur. I. Compound 2 fluid drachms of oil of juniper and 24 drops of oil of cardamon with 1¾ gallons of spirit of 90 per cent. Tr.; sweeten the mixture with a solution of 5½ pounds of sugar in 1½ gallons of water, and filter the fluid.

II. Dissolve 2 fluid drachms of oil of juniper, 24 drops of oil of ginger, 24 drops of oil of coriander, and 1¼ fluid drachms of cognac essence in 2 gallons of rectified spirit of 90 per cent. Tr., and sweeten the solution with 5½ pounds of sugar dissolved in 1½ gallons of water.

Koch's Herb Extract. Macerate:

Lemon peel	4½	ounces.
Calamus	2½	"
Cinnamon	2½	"
White ginger	2½	"
Peruvian bark	2½	"
Orris root	2½	"
Juniper berries	4½	"
Bay leaves	2½	"
Cubeba	2½	"
Orange peel	2½	"
Roman camomile	1½	"
Elder flowers	1½	"

in 2½ gallons of rectified spirit of 90 per cent. Tr. Then press out and filter the fluid.

Maraschino. Compound 1 pound of maraschino essence with 4½ gallons of rectified spirit of 90 per cent. Tr. and 9 gallons of water; sweeten the mixture with a solution of 44 pounds of sugar, and filter.

Mogador. Dissolve 40 drops each of oil of wormwood, oil of calamus, oil of peppermint, and oil of orange peel, and 20 drops each of oil of cinnamon, oil of cloves, oil of ginger, and oil of balm in 1½ gallons rectified spirit of 90 per cent. Tr.; sweeten the solution with 6 pounds of sugar dissolved in 7 pints of water, color it red with bilberry juice, and filter.

Nectar. Dissolve 120 drops of oil of lemon, 80 of fennel oil, 40 each of oil of calamus, oil of cinnamon, oil of cardamon, and oil of orange blossoms in 1½ gallons of rectified spirit of 90 per cent. Tr.; sweeten the solution with 6½ pounds of sugar dissolved in 1½ gallons of water, color it blue, and filter.

Orange Peel Cordial. I. Dissolve 2 fluid drachms of oil of orange peel in 1½ gallons of rectified spirit of 90 per cent. Tr.; add 6½ pounds of sugar in 1½ gallons of water, color the fluid yellow, and filter.

II. Commixute ½ pound of fresh orange peel, pour 1½ gallons of rectified spirit of 90 per cent. Tr. over them; sweeten with 6½ pounds of sugar dissolved in 1½ gallons of water, and filter.

Purfait D'Amour. Dissolve 80 drops of oil of lemon, 40 of oil of cinnamon, 30 of oil of bergamot, 20 of oil of cloves, 16 of oil of nutmegs, and 10 each of oil of lavender blossoms and oil of rosemary in 2½ gallons of rectified spirit of 90 per cent. Tr.; sweeten the solution

with 8½ pounds of sugar dissolved in 2½ gallons of water, color the fluid pale red, and filter.

Peach Cordial. Cut 1 pound of peaches in slices, then pour 1½ gallons of rectified spirit of 90 per cent. Tr. over them, and allow the mass to digest for 8 to 10 days. Then filter and mix the filtrate with 1½ gallons of good white wine and 7½ pounds of sugar dissolved in 1½ quarts of water.

Peppermint Cordial. Dissolve 2 fluid drachms of oil of peppermint in 1½ gallons of rectified spirit of 90 per cent. Tr.; sweeten the solution with 6½ pounds of sugar dissolved in 1½ gallons of water, and filter.

Or, Dissolve 2 fluid drachms of oil of peppermint and 1 fluid drachm of cognac essence in 1½ gallons of rectified spirit of 90 per cent. Tr.; sweeten the solution with 6½ pounds of sugar dissolved in 1½ gallons of water, and filter.

Polish Water. Commixute 6½ ounces of dried currants, 1 ounce each of anise seed, cinnamon, cloves, fennel seed, mint, rosemary, marjoram, and galanga. Pour 4 gallons of alcohol and 3 gallons of rose-water over them, and let the mass digest for 14 days. Then add 44 pounds of sugar syrup, and filter.

Polish Whiskey. Commixute ½ pound of large raisins, 1 ounce of licorice root, ¾ ounce each of cinnamon and cardamoms, ¼ ounce each of cloves, galanga, gum ammoniac, anise seed, and coriander seed, and ¼ ounce of saffron. Pour 1½ quarts of whiskey over these ingredients, let the mass digest for a few days, then press the liquor out, filter it, and sweeten it to the taste with sugar dissolved in rose-water.

Quince Cordial (Quittico). Powder coarsely 2 ounces of cinnamon, ½ ounce of coriander seed, ½ ounce of white ginger, and ¼ ounce of nutmeg. Macerate these ingredients for 8 days in 1 pint of spirit of wine 85 per cent. strong, then strain and press out the liquid and add 7 pounds of fresh quince juice in which 6 pounds of white sugar have been dissolved, and add 3 quarts of spirit of wine 85 per cent. strong. Mix the mass thoroughly and filter through felt or blotting paper.

Rosemary Cordial. Dissolve 2 fluid drachms of oil of rosemary and 24 drops of oil of lemon in 1½ pints of rec-

tified spirit of 80 per cent. Tr.; sweeten the solution with 1 pound of sugar dissolved in $1\frac{1}{2}$ gallons of water, and filter.

Rossolio de Turin. Commiute 1 pound of fresh rose leaves, $\frac{1}{2}$ pound each of jasmine blossoms and orange blossoms, 1 ounce each of orris root and cinnamon, $\frac{1}{4}$ ounce each of cloves and vanilla. Pour $1\frac{3}{4}$ gallons of spirit of wine over these ingredients and let them macerate for 8 to 12 days, placing them in a warm place. Then pour off the fluid, press out the residue, sweeten the liquor with $7\frac{1}{2}$ pounds of sugar, and let it stand for 3 to 4 weeks. Then pour off the clear liquor, filter the sediment, and color red with cochineal or cherry juice.

Rostopschin. Dissolve $1\frac{1}{4}$ fluid drachms of anise seed oil, $\frac{1}{2}$ fluid drachm of oil of cardamons, 40 drops of oil of lemon, and 20 drops each of oil of cinnamon and oil of coriander seed in $1\frac{3}{4}$ gallons of rectified spirit of 90 per cent. Tr.; sweeten the solution with $6\frac{1}{2}$ pounds of sugar dissolved in $1\frac{1}{2}$ gallons of water, and filter.

Scubac. Commiute $4\frac{1}{4}$ ounces of juniper berries, 2 ounces of coriander seed, 1 ounce each of saffron and cinnamon, $\frac{1}{2}$ ounce each of angelica seed and anise seed, $\frac{1}{4}$ ounce each of mace and cloves, and the fresh peel of 4 lemons. Pour 2 gallons spirit of wine over these ingredients and let them macerate for 2 to 3 weeks. Then boil $1\frac{1}{2}$ ounces of raisins or dates in $1\frac{3}{4}$ gallons of water, pour off the liquor, press out the residue, and sweeten with $6\frac{1}{2}$ pounds of sugar, and add this to the liquor pressed out of the macerated mass. Let the whole stand for 3 or 4 weeks, then pour off the clear liquor and filter the sediment.

Soya Aqua Vita. Commiute 3 ounces of anise seed, 1 ounce each of coriander seed, elecampane root, nutmeg, and cloves, $\frac{1}{2}$ ounce each of caraway seed and elderberry blossoms, $\frac{1}{4}$ ounce of Roman camomile, $4\frac{1}{4}$ ounces each of lemon peel and orange peel, and $1\frac{1}{2}$ ounces of cinnamon. Macerate these ingredients in alcohol for 2 or 3 weeks, then distil them with $5\frac{1}{2}$ gallons of rectified spirit, add the necessary quantity of sugar, and compound the distillate with $1\frac{3}{4}$ pints of rose-water and as much water as may be required.

Spanish Bitters. Dissolve 80 drops

of oil of Crete marjoram (organ), 40 each of oil of bitter oranges and oil of wormwood, and 20 each of oil of angelica, oil of cardamon, oil of calamus, oil of marjoram, and oil of thyme in $1\frac{3}{4}$ gallons of rectified spirit of 90 per cent. Tr.; sweeten the solution with $6\frac{1}{2}$ pounds of sugar dissolved in $1\frac{1}{2}$ gallons of water, color it brown, and filter.

Stettin Bitters. Macerate 1 pound of gentian root, $8\frac{1}{4}$ ounces of wormwood, 1 pound of cloves, $4\frac{1}{2}$ ounces each of coriander seed, cinnamon, and orange peel, $2\frac{1}{4}$ ounces each of green oranges and quassia in $9\frac{1}{4}$ gallons of spirit of wine 40 per cent. strong. Pour off the fluid, strain the residue, add 11 pounds brown sugar, filter the liquor, and color it brown.

Stomach Bitters. I. Commiute 2 ounces each of calamus, anise seed, caraway seed, and fennel, $1\frac{1}{2}$ ounces each of ginger and cinnamon, $\frac{1}{2}$ ounce of mace, 1 ounce of cloves, $4\frac{3}{4}$ ounces of lemon peel, 1 ounce each of galanga, zedoary, and cubeb, $\frac{1}{2}$ ounce of pepper, $\frac{3}{4}$ ounce of sassafras bark, $1\frac{1}{2}$ ounces each of rose leaves, myrrh, and lavender blossoms, and 2 ounces of orris root. Pour 2 gallons of whiskey and $1\frac{3}{4}$ pints of water over the ingredients, let them macerate for 8 days, then press them out, filter the liquor, and add some common salt and $4\frac{1}{2}$ pounds of crushed sugar.

II. Commiute $\frac{1}{2}$ ounce each of speedwell, mint, balm, wormwood, arum root, zedoary, calamus root, small pomegranates, caraway seed, and cinnamon. Pour over them $1\frac{3}{4}$ quarts of good whiskey and let them macerate for 14 days in a warm place, with frequent shaking in the meanwhile. Then press the liquor out, filter, and put it in bottles.

III. Dissolve 40 drops each of oil of orange peel, oil of wormwood, oil of mint, and oil of calamus, 20 drops each of oil of marjoram, oil of cinnamon, oil of cloves, and oil of cardamon, and $1\frac{1}{4}$ fluid drachms of cognac essence in $1\frac{3}{4}$ gallons of rectified spirit of 90 per cent. Tr.; sweeten the solution with $6\frac{1}{2}$ pounds of sugar dissolved in $1\frac{1}{2}$ gallons of water, color the liquor brown, and filter.

IV. Dissolve 60 drops of oil of orange peel, 40 each of oil of calamus, oil of angelica, oil of cardamon, oil of worm-

wood, oil of ginger, and oil of marjoram, and 2 fluid drachms of cognac essence in $1\frac{3}{4}$ gallons of rectified spirit of 90 per cent. Tr.; sweeten the solution with $5\frac{1}{2}$ pounds of sugar dissolved in $1\frac{1}{2}$ gallons of water, and filter.

V. Vienna Stomach Bitters. Dissolve 40 drops each of oil of balm, oil of orange peel, and oil of angelica, 24 drops each of oil of marjoram, oil of wormwood, oil of cinnamon, oil of coriander seed, and oil of mace, and $\frac{1}{2}$ fluid ounce of cognac essence in $1\frac{1}{4}$ gallons of rectified spirit of 90 per cent. Tr.; sweeten the solution with $7\frac{3}{4}$ pounds of sugar dissolved in 2 $\frac{1}{2}$ quarts of water. Color red and filter.

Swiss Cordial. Dissolve 40 drops each of oil of wormwood, oil of calamus, and oil of peppermint, 24 drops each of oil of bitter oranges, oil of marjoram, oil of cinnamon, oil of cloves, and oil of cardamons in $1\frac{3}{4}$ gallons of rectified spirit of 90 per cent. Tr.; sweeten the solution with $4\frac{1}{2}$ pounds of sugar dissolved in $1\frac{1}{2}$ gallons of water, color the fluid green, and filter.

Thiem's Bitters. 1 pound of peeled calamus root, $2\frac{1}{4}$ pounds of orange peel, $\frac{1}{2}$ pound of galanga, $\frac{3}{4}$ pound of white cinnamon, $5\frac{3}{4}$ ounces of cardamons, $4\frac{3}{4}$ ounces each of cloves and allspice, $2\frac{1}{4}$ ounces each of anise seed and fennel, $5\frac{3}{4}$ ounces of nutmeg, 1 ounce of Roman camomile, and 2 $\frac{1}{2}$ ounces of elecampane root are digested in 17 gallons of spirit of wine 50 per cent. strong for 24 hours in a still, and then $8\frac{1}{2}$ gallons of liquor are distilled off, 55 pounds of sugar are dissolved in the distillate, and a sufficient quantity of water is added to give a volume of $26\frac{1}{2}$ gallons of liqueur 30 per cent. strong.

Tivoli Cordial. Dissolve 80 drops each of oil of coriander seed and oil of mace, and 40 drops each of oil of lemon, tincture of vanilla, oil of cinnamon, and tincture of orris root in $1\frac{3}{4}$ gallons of rectified spirit of 90 per cent. Tr.; sweeten the solution with $5\frac{1}{2}$ pounds of sugar dissolved in $1\frac{1}{2}$ gallons of water, and color the cordial brown.

Trappistine. $3\frac{1}{2}$ ounces each of wormwood and angelica root, $1\frac{3}{4}$ ounces each of myrtle leaves and calamus root, $\frac{1}{3}$ ounce of cloves, $3\frac{1}{2}$ ounces of cardamons, 7 ounces of peppermint, $2\frac{1}{2}$ ounces of common balm leaves, $\frac{1}{2}$ ounce of cin-

namon, and $\frac{1}{2}$ ounce of nutmeg are macerated for 48 hours in $2\frac{1}{4}$ gallons of rectified spirit 85 per cent. strong; $2\frac{1}{2}$ gallons of water are then added and the macerated mass is distilled. One gallon of water is then added to the distillate, and this is compounded with a cold syrup of $17\frac{1}{2}$ pounds of sugar in 1 gallon of water, and finally a sufficient quantity of water is added to give an entire product of $5\frac{1}{2}$ gallons. This liqueur is colored green.

Vanilla Cordial. Macerate $2\frac{1}{2}$ ounces of vanilla beans for a few days in $1\frac{1}{2}$ gallons of rectified spirit and 3 gallons of water, and then distil the mass. Add 22 pounds of dissolved sugar to the distillate, color it with cochineal, and filter.

Véritable Extrait d'Absinthe. Five pounds of anise seed, a like quantity of fennel, $1\frac{1}{2}$ pounds of elecampane root, 2 pounds of calamus, 2 ounces of wormwood, $2\frac{1}{2}$ ounces of leaves and stalks of wild basil, $6\frac{1}{2}$ ounces of bitter almonds, 2 ounces each of hyssop, mint, and gnaphalium flowers are comminuted and digested in 3 gallons of rectified spirit of 90 per cent. Tr. The macerated mass is then pressed out, the liquor filtered, and 2 gallons of rum are added, and the fluid sweetened with 5 pounds of brown sugar dissolved in $2\frac{1}{2}$ gallons of water.

Vienna Bitters. Dissolve 40 drops each of oil of bitter oranges, oil of wormwood, and oil of Crete marjoram (origan), 32 of oil of calamus, 20 each of oil of peppermint, oil of marjoram, oil of anise seed, oil of thyme, and oil of cinnamon, 24 of oil of coriander seed, and 12 of oil of cloves in 2 gallons of rectified spirit of 90 per cent. Tr. Add 3 quarts of good red wine to the solution, sweeten it with $6\frac{1}{2}$ pounds of sugar dissolved in $3\frac{1}{2}$ quarts of water, color it red, and filter.

Wormwood Cordial. Dissolve $1\frac{1}{2}$ fluid drachms of oil of wormwood, 32 drops of oil of lemon, and 20 drops each of oil of cinnamon and oil of cardamon in $1\frac{3}{4}$ gallons of rectified spirit of 90 per cent. Tr.; sweeten the solution with $5\frac{1}{2}$ pounds of sugar dissolved in $1\frac{1}{2}$ gallons of water, and filter.

VI. RATAFIAS. *Barbadoes Ratafia.* Dissolve 80 drops of oil of lemon, a like quantity of oil of bergamot, 40

each of oil of cinnamon, oil of cloves, and oil of mace, and $1\frac{1}{2}$ fluid drachms of vanilla tincture in $1\frac{1}{2}$ gallons of rectified spirit of 90 per cent. Tr., and add 11 pounds of sugar, dissolved in $1\frac{1}{2}$ gallons of water.

Cocoa Ratafia. Seven pounds of roasted cocoa are digested for 14 days in 1 gallon of alcohol 35 per cent. strong. Sweeten the mixture with $18\frac{3}{4}$ pounds of sugar dissolved in $2\frac{1}{2}$ quarts of water, filter and add 90 drops of vanilla tincture.

Citronat-Ratafia. Dissolve $2\frac{1}{2}$ fluid drachms of oil of lemon and 1 fluid drachm each of oil of bergamot, vanilla tincture, and essence of roses in 2 gallons of rectified spirit of 90 per cent. Tr., and sweeten the solution with 13 pounds of sugar dissolved in $1\frac{1}{2}$ gallons of water.

Claret Ratafia. Comminute 2 ounces each of anise seed, dill, fennel, and coriander seed, and $4\frac{1}{2}$ ounces of caraway seed; macerate these ingredients for 14 days in 2 gallons of whiskey 22 per cent. strong, then strain the macerated mass through a linen cloth; add $5\frac{1}{2}$ pounds of sugar dissolved in $\frac{3}{4}$ pint of water, and filter.

English Bitters Ratafia. Dissolve 80 drops of oil of bitter almonds, a like quantity of oil of angelica, 40 of oil of marjoram, 32 of oil of balm, 20 each of oil of wormwood and oil of cardamons, 120 of cognac essence, and 80 of vanilla tincture in $1\frac{1}{2}$ gallons of rectified spirit of 90 per cent. Tr., and sweeten the solution with a syrup made of 10 pounds of sugar and $1\frac{1}{2}$ gallons of water.

Fennel Ratafia. Dissolve 2 fluid drachms of fennel oil, $\frac{3}{4}$ fluid drachm of oil of coriander seed, a like quantity of oil of anise seed, and $1\frac{1}{2}$ fluid drachms of orange blossom essence in $1\frac{1}{2}$ gallons of rectified spirit of 90 per cent. Tr., and sweeten the solution with a syrup made of 10 pounds of sugar and $1\frac{1}{2}$ gallons of water.

Ginger Ratafia. Comminute $\frac{1}{2}$ pound of ginger and $\frac{1}{8}$ ounce of vanilla beans. Pour $1\frac{1}{2}$ gallons of rectified spirit of 90 per cent. Tr. over these ingredients, let them stand for some time, draw off the fluid, and sweeten it with a solution of 10 pounds of sugar in $1\frac{1}{2}$ gallons of water.

Ratafia Chinoise (Chinese Liqueur). Comminute $1\frac{1}{2}$ pounds of green oranges and $5\frac{1}{2}$ ounces of fresh stems of angelica; pour $2\frac{1}{2}$ gallons of spirit of wine over these ingredients, and let them macerate for 10 to 15 days. Then press the macerated mass out, filter the liquid, and sweeten it with 9 pounds of sugar dissolved in 1 gallon of water.

Ratafia de Grenoble. Comminute 1 drachm of cinnamon, $\frac{3}{4}$ ounce of cloves, $8\frac{1}{2}$ ounces of peach leaves, and a like quantity of cherry stones. Pour 1 gallon of whiskey over these ingredients, and let them digest for 2 to 3 weeks, when they are distilled. Add to the distillate 1 gallon of cherry juice, in which $2\frac{1}{2}$ pounds of sugar have been dissolved.

Mulberry Ratafia. Pour 22 pounds of spirit of wine over $26\frac{1}{2}$ pounds of mulberries, 1 pound of orris root, the juice of 4 lemons and of 4 oranges, and the peel of these fruits. Let them macerate for 4 to 6 weeks, then filter and compound the filtrate with $6\frac{1}{2}$ to 9 pounds of sugar syrup.

Orange Ratafia. Slice 20 oranges, pour $13\frac{1}{2}$ pounds of rectified spirit of 90 per cent. Tr. over them, and let them stand for 8 days. Then press out the fluid, filter it, and add a solution of 10 pounds of sugar in $1\frac{1}{2}$ gallons of water.

Apple Ratafia. $26\frac{1}{2}$ pounds of apple juice, $\frac{1}{2}$ ounce each of cloves and mace, $7\frac{3}{4}$ pounds of sugar, and 22 pounds of spirit of wine are allowed to digest for 4 to 6 weeks, then add some ambergris, filter, and color the fluid yellow.

Pear Ratafia. $26\frac{1}{2}$ pounds of pear juice, $\frac{1}{2}$ ounce each of mace and cloves, $7\frac{3}{4}$ pounds of sugar, and 22 pounds of spirit of wine. Treat in the same manner as apple ratafia.

Stomachic Ratafia. Comminute $8\frac{1}{2}$ ounces of pomegranates, 1 ounce of calamus root, $\frac{1}{2}$ ounce of cloves, 2 ounces of caraway seed, 1 ounce of cinnamon, and $\frac{1}{4}$ ounce of mace. Pour 1 gallon of spirit of wine over the ingredients, and allow them to digest for 16 or 20 days. Then pour off the liquid, and press out the residue. Pour $\frac{3}{4}$ quarts of boiling water over 1 ounce of peppermint, drain off the fluid, dissolve in it $3\frac{1}{2}$ pounds of sugar, and

add this to the above fluid. Then let it stand quietly for 3 or 4 weeks, when the clear fluid is poured off, and the sediment filtered.

Celery Ratafia. 4½ ounces of celery seed, 5 drachms of coriander seed, and 3 drachms of cardamons are comminuted and digested for 3 weeks in 2½ quarts of whiskey 24 per cent. strong, when they are distilled on a water bath. The distillate is sweetened with 2¼ pounds of sugar dissolved in 1½ pints of water.

Scotch Ratafia. Mix 5½ ounces of jujube berries, 2¼ ounces of saffron, 1½ ounces of dates, 1½ ounces of grapes, ¾ drachm of coriander seed, ¾ drachm of cinnamon, and pour ¾ gallon of whiskey of 24 per cent. over the mixture. After allowing it to digest for 14 days, pour off the fluid, and add to it the fluid pressed from the residue. Sweeten with 2¾ pounds of sugar dissolved in 1½ pints of water.

Vanilla Ratafia. Cut 1 ounce of vanilla beans in small pieces. Pour 13¼ pounds of rectified spirit of 90 per cent. Tr. over them, add ½ fluid drachm of oil of orange blossoms, let them stand for 8 days, then filter, add 11 pounds of sugar dissolved in 1½ gallons of water, and color pale red.

Wormwood Ratafia. Dissolve 2 fluid drachms of oil of wormwood, 32 drops of oil of cinnamon, 20 drops each of oil of cloves and oil of cardamons in 1½ gallons of rectified spirit of 90 per cent. Tr.; sweeten the solution with a syrup of 8¾ pounds of sugar, add 1 gallon of water, and color green.

BLASTING COMPOUNDS, BLASTING POWDER, DYNAMITE, GUN-COTTON, GUNPOWDER, NITRO-GLYCERINE, FULMINATES, ETC.

Among the blasting compounds nitro-glycerine and the explosive substances, dynamite, etc., derived from it, occupy the foremost place.

Nitro-glycerine is obtained in the following manner: Fuming nitric acid of 49° to 50° Beaumé is mixed with twice its weight of highly concentrated sulphuric acid in a vessel kept cool by being surrounded with cold water. Ordinary commercial glycerine, free

from lime and lead, is evaporated to 30° or 31° Beaumé. When entirely cold, it should be of a syrupy consistency. 7¼ pounds of the cold acid mixture are brought into a glass flask or earthen vessel; this is placed in cold water, and 1 pound of glycerine is slowly poured into it; constant stirring being kept up during the addition of the glycerine. Great care must be observed to avoid any heating of the mixture, as the consequence of this would be an oxidation of the glycerine with development of carbonic acid. When the mixture is complete, it is allowed to stand quietly for 5 or 10 minutes, when it is poured into 5 or 6 times its volume of cold water, to which a rotary motion has previously been imparted. The nitro-glycerine subsides quickly as a heavy oil, which, by decantation, is brought into a vessel of greater height than width. It is now washed with water, until not a trace of acid reaction is indicated by blue litmus paper, when it is put in flasks ready for use. It is a yellow or brown oil, heavier than water, and practically insoluble in it, but soluble in alcohol and ether. When impure or acid, it decomposes spontaneously in a short time, with development of gas, and formation of oxalic and glyceric acids.

Mowbray's Process of Manufacturing Nitro-glycerine. This product is pre-eminent because of its stable character. It freezes at 45° F., is clear as water, and never of an orange color. When detonated it does not produce what is known as glycerine headache and is non-explosive when frozen. These excellent qualities are imparted to it by the care taken in its preparation. The nitrifying acid is made in a well-ventilated building, in which are placed five retorts each of 1½ pounds' capacity and charged with 10½ ounces of sodium nitrate and 13¼ ounces of sulphuric acid. Terra-cotta pipes conduct the vapors from each retort into a row of four earthenware receivers standing upon a trestle raised slightly above the floor. 165 pounds of sulphuric acid are poured into the first two receivers and 110 pounds into the third, while the fourth remains empty. The nitric acid vapors are condensed in the receivers, whereby the mixture of acids

required for nitrating is at once obtained. When the distillation, which requires 24 hours, is finished, the acid mixture (about 660 pounds) is drawn off and emptied into a large trough of soapstone. To remove the hyponitric acid, as well as to obtain a homogeneous mixture, *Mowbray* passes a current of air into the trough through an iron pipe, which answers the purpose perfectly. This operation is of great importance, as the presence of hyponitric acid and nitrous acid probably causes the spontaneous decomposition and consequent explosion of this substance. The room in which the nitrating process is carried on is about 103 feet long and contains 116 jars of earthenware in 9 wooden troughs. 18½ pounds of acid are poured into each of the jars and the troughs are filled with ice water, or with a mixture of ice and salt, to within ½ inch of the edge of the jars containing the acid. Upon a shelf above the troughs are placed glass vessels, one for each jar. Each contains 2¼ pounds of pure glycerine (not crude glycerine), which is conveyed drop by drop into the acid mixture by means of a siphon and rubber hose. Beneath the shelf upon which the glycerine vessels stand runs an iron pipe 2½ inches in diameter, through which passes a current of cold and dry air, which is introduced into the jars, while the acid and glycerine intermingle, through glass tubes 16½ inches long and ¼ inch in diameter. 1½ hours are required for the glycerine to run off, and the greatest attention and care are necessary during this time. The three workmen overseeing the mixing process walk constantly up and down with a thermometer in hand, and should they find the temperature rising in one of the jars, or that red vapors are emitted, they stir the mixture with a glass rod. It happens sometimes that the glycerine runs too rapidly, when the flow must be diminished, and in case the engine should cease working must be entirely stopped and the mixture stirred.

When the conversion of glycerine into nitro-glycerine is completed, and no more red vapors escape, the jars are emptied into a vat containing cold water (42.8° F.). The quantity produced amounts at each operation to

495 pounds. In this vat the oil subsides to the bottom, being covered with water about 6 feet deep. It remains here for 15 minutes, when, after the water has been run off, it is drawn off into another vat resembling an old-fashioned churn, but much larger. Here it is washed 5 times—three times with pure water and twice with a solution of soda, a current of air being passed through it at the same time. The water from the washing apparatus is allowed to run into a vat, and from this through two barrels buried in the ground, whence it finds its way to the outside. If any of the oil should have been carried off with the wash-water, it is regained in one of the barrels. The nitro-glycerine is then transported in copper vessels to a magazine about 300 feet distant from the work-room and emptied into crocks each having a capacity of 66 pounds. These are placed on wooden shelves, each holding about 20 crocks, which are immersed in water of about 70° F., reaching to within 6 inches of the edge of the crocks. Here they remain for 72 hours, during which time the impurities that may be contained in the oil rise to the surface in the form of a scum, which is removed with a spoon. The nitro-glycerine is then chemically pure, transparent as water, and strongly refracts light. In this condition it is ready for packing. The tin cans used for this purpose are coated inside with paraffine, and have a capacity of 61½ pounds each. When they are to be filled they are placed in a shallow wooden vat; the oil is first poured into copper cans and then through a rubber funnel into the tin cans. To render any oil which may be spilled harmless the precaution is used to cover the bottom of the vat with a thick layer of plaster of Paris, which quickly absorbs the fluid. When the cans have been filled they are placed in a wooden vat filled with ice water, or ice and salt, until their contents are frozen, and 30 to 40 of them are stored away together in smaller magazines at a distance of about 325 feet from the factory. For transporting the nitro-glycerine the tin cans are packed in open wooden boxes, the bottom of which is covered with several inches of sponge. Around the cans themselves

are fastened two gutta-percha tubes crossing each other on the bottom of the can. To thaw the nitro-glycerine each can is provided with a tube about 10 inches long and $1\frac{1}{2}$ inches in diameter, passing through the centre from top to bottom, into which water of from 70 to 90° F. is poured. The cans are closed by a cork covered with a piece of bladder. Sleighs are used in winter for transporting the cans, and in summer wagons covered with a layer of ice and this with a blanket.

R. Böttger recommends the following process as free from risk for preparing small quantities of nitro-glycerine: A few grammes of anhydrous and entirely pure glycerine are poured into a test-glass kept cool by being surrounded with a freezing mixture, and containing 1 part by volume of concentrated sulphuric acid of 1.52 gravity, and 2 parts by volume of stronger sulphuric acid of 1.83 gravity. The mixture is poured as quickly as possible into a larger volume of water. In this the nitro-glycerine, resembling drops of oil, subsides to the bottom; it is then washed and re-washed, first with water, and finally with a weak solution of soda. It is freed from water by means of a few small pieces of chloride of calcium, when a product will be obtained of such purity that it may be kept without risk for an indefinite time and without suffering decomposition.

Dynamite possesses all the properties of nitro-glycerine for blasting purposes, and is less dangerous. Explosion is accomplished by means of a percussion cap in the same manner as with nitro-glycerine. The most common mode of making dynamite is by mixing 75 per cent. of nitro-glycerine with 25 per cent. of powdered sand.

Dynamite, according to *H. Champion* and *H. Pellet*, may be divided into, *a*, dynamite with an inert absorbent (infusorial earth, ashes, tripoli, etc.), and *b*, dynamite with an active absorbent. In the latter variety rosin, finely-powdered coal, or saltpetre are used as absorbents. To this class belong dualin, lithofracteur, etc.

To make the manufacture of dynamite less dangerous, *A. Sabrero* suggests to stir infusorial earth with water into a dough, form it into shapes of suitable

size, dry them at 212° F., and finally dip them into nitro-glycerine. Dynamite with 75 per cent. of effective explosive can be prepared in this manner.

Cellulose Dynamite. *Franzl* has succeeded in producing a nitro-glycerine powder which, while it possesses all the properties of dynamite prepared with infusorial earth, has the advantage of being unaffected by water. He found that certain organic absorbents possessed the property of retaining absorbed nitro-glycerine, even when placed under water, and did not lose their explosive power. The nitrogenized absorbents—wood fibre and gun-cotton—were found to be too dangerous for manufacturing large quantities. But *Franzl* has now succeeded in preparing a wood fibre which absorbs from 70 to 75 per cent. of nitro-glycerine, which retains these proportions unchanged when in contact with water, and which retains also its explosive power after being pressed out and dried.

Norbin & Ohlsson's Patent Dynamite consists of a mixture of ammonium nitrate, with 8 to 10 per cent. of pulverized charcoal or coal, and 10 to 30 per cent. of nitro-glycerine. The compound, which, on account of the hygroscopic property of the ammonium nitrate, must be kept in metallic cases or glass vessels, is exploded by means of a percussion cap.

A. Nobel's Dynamite is a mixture of 69 parts of saltpetre, 7 of paraffine or naphthaline, 7 of coal dust, and 20 of nitro-glycerine. It is claimed that the addition of paraffine or naphthaline renders the mixture less hygroscopic.

Lithofracteur, as manufactured by *Krebs & Co. of Deutz*, is composed of 52 parts of nitro-glycerine, 30 of infusorial earth, 12 of coal, 4 of saltpetre, and 2 of sulphur.

Dittmar's Dualin consists of 50 parts of nitro-glycerine, 50 of nitrated saw-dust, and 20 of saltpetre.

New Dynamite by Anthoine & Genaud. In this preparation unsized paper takes the place of silica. The paper is not only saturated with nitro-glycerine, but dipped in succession into solutions of saltpetre, potassium chlorate, and potassium picrate.

Carboäzotine. This explosive mixture, patented in France by *de Soulages*

and *Cahuc*, is composed of 50 to 64 parts of saltpetre, 13 to 16 of sulphur, 14 to 16 of spent tan, or very fine sawdust, 9 to 18 of lampblack, and 4 to 5 of ferrous sulphate. The mixture is heated with a suitable quantity of water to 230° to 248° F., then allowed to cool, and the solid mass dried and shaped into bricks.

Brise-rocs, an explosive agent patented by *Robaudi*, consists of 40 parts of saltpetre, 20 of soda saltpetre, 15 of sulphur, 1 of rock salt, and 15 of woody substance, spent tan, sawdust, etc.

Pudrolith. *Poch's* blasting powder, known under this name, consists of 3 parts by weight of spent tan, 5 of sawdust, 3 of soda saltpetre, 3 of barium nitrate, 6 of wood charcoal, 12 of sulphur, and 68 of saltpetre. The barium and sodium salts are dissolved in hot water, the tan and sawdust stirred into the solution, and the mixture is evaporated to dryness. The other ingredients, previously pulverized, are intimately mixed with the powdered residue in a revolving cylinder.

Pyrolith. This blasting powder, patented by *Wattlen*, and used for blasting hard rocks, such as granite, etc., consists of 12.5 parts by weight of sawdust, 67.5 of saltpetre, and 20 of flowers of sulphur.

For blasting softer rocks, such as limestone, coal, etc., *Wattlen* recommends the following composition: 11 parts by weight of sawdust, 50.5 of saltpetre, 16 of soda saltpetre, 1.5 of powdered charcoal, and 20 of flowers of sulphur.

Tret's Blasting Powder, patented in England, consists of 52.5 per cent. of Chili soda saltpetre, 20 per cent. of sulphur, and 27.5 per cent. of spent tan.

Frozen Dynamite. Dynamite, when frozen solid, is comparatively valueless, as in thawing for use it becomes injured and sometimes ignites; but by granulating it, as freezing takes place, and keeping it in this condition, it may be transported, handled, or poured and rammed into bore holes with entire safety and convenience. Freezing the dynamite in grains may be readily accomplished by passing it through a coarse sieve after it is manufactured, but just before

it congeals, and allowing it to fall loosely and lie undisturbed during its exposure to a freezing temperature. The particles will slightly adhere, but may be readily separated by stirring. Dynamite so frozen will readily explode by the ordinary means, but the cap should have about three times the usual quantity of fulminate.

Augendre's White Powder. This powder may be advantageously used for blasting very hard rock, although it is somewhat expensive. Considerable care and caution are required in ramming it into the drill holes, and for this reason the work should be only intrusted to experienced workmen. By the following process *Augendre's* gunpowder can be produced as a very homogeneous mixture and of great explosive energy. The three ingredients of white gunpowder, potassium ferrocyanide, sugar, and potassium chlorate, are pulverized, each by itself, in a mortar, and then thoroughly dried. Each of the ingredients, when dry, is again pulverized as finely as possible, and passed through a fine hair sieve. The respective quantities of the ingredients are then weighed off, poured upon a sheet of paper, and intimately mixed with the fingers or with a feather. The powder is then placed in a capacious porcelain mortar, moistened with absolute alcohol, and an intimate mixture is produced by continued rubbing with a pestle, the process being entirely free from danger if done in this manner. The powder, which is now in the form of a stiff dough, is spread upon a smooth board and dried in a warm room. The alcohol evaporates quickly, when the thin, dry cakes of powder are crushed between two smooth boards, and the powder passed through a fine sieve. In this manner it is obtained in the form of very fine, intimately mixed dust, possessing excellent explosive properties.

Hafenegger's Gun and Blasting Powder, several varieties of which have been patented in England, resembles *Augendre's* white powder. Their composition is as follows:

I. Nine parts of potassium chlorate, $\frac{1}{2}$ of sulphur, and $\frac{1}{4}$ of wood charcoal.

II. Two parts of potassium chlorate;

1 of refined sugar, and 1 of potassium ferrocyanide.

III. Four parts of potassium chlorate, 1 of sulphur or sugar, $\frac{1}{4}$ of wood charcoal, and 1 of potassium ferrocyanide.

IV. Four parts of potassium chlorate, 4 of sugar, $\frac{1}{4}$ of wood charcoal, and $\frac{1}{4}$ of sulphur.

V. One part of potassium chlorate and 1 of sugar.

VI. Eleven parts of potassium chlorate, $\frac{1}{4}$ of sulphur, and $\frac{1}{4}$ of wood charcoal.

Dr. Borlinetto's Gunpowder. Mix very intimately 10 parts of Chili saltpetre, 10 of picric acid, and $8\frac{1}{2}$ of potassium bichromate.

Sharp & Smith's Patent Gunpowder consists of 2 parts of saltpetre, 2 of potassium chlorate, 1 of potassium ferrocyanide, 1 of potassium tartrate, and 2 of sulphur.

Spence's Powder for Cannon of Large Calibre. Two parts by weight of finely-pulverized charcoal are boiled with 38 parts by weight of water. The boiling is interrupted after a short time, and, with constant stirring, 20 parts by weight of potassium chlorate, 2 of pulverized coal, and 4 of sodium bicarbonate are added to the mixture of charcoal and water. The mass is again brought to the boiling point, 7 parts by weight of fine sawdust are added, and the boiling continued until the woody mass has formed a magma with the water. When this is done the mass is evaporated in open pans until it is of a consistency to be granulated in the usual manner in the powder-mill.

Non-explosive Powder. When this powder is ignited it does not explode, but burns slowly with a hissing noise. It loosens and raises stones without blasting them. It is cheaper than the ordinary powder, of quite a coarse grain, and contains 3 parts of potassium nitrate to 1 of sodium nitrate. The powder is mixed in the following proportions: 56.22 to 56.23 per cent. of potassium nitrate, 18.33 to 18.39 per cent. of sodium nitrate, 9.68 per cent. of sulphur, and 14.14 to 15.01 per cent. of charcoal.

Green's Blasting Powder consists principally of barium nitrate, contains but little saltpetre and no sulphur. There is less danger in manufacturing

it than gunpowder, but it is not fit for firearms. It possesses the great advantage of not emitting thick smoke or choking gases, and therefore does not interrupt the work in mines; and further, that it takes up less room than gunpowder and is much cheaper. Its effect as compared with gunpowder is as 18 to 11.

Giant Dynamite is a mixture of 18 to 28 parts by weight of pyroxyline, 55 to 44 of nitro-glycerine, 5 to 10 of pyro-paper, 20 to 16 of nitro-starch, 1 to 1 of nitromannite, and 1 to 2 of water-glass. The materials, which should be free from acid, are carefully mixed and brought under a cartridge press, in the stamp of which is fastened a needle which makes a hole in the cartridge for the reception of the fuse. The cartridge thus prepared is hermetically closed with collodion, and packed in the same manner as lithofracteur. Shortly before the cartridge is to be used the coating of collodion is broken on those places where the holes are for the reception of the fuse. This consists of soft gun-cotton impregnated with potassium chlorate and plumbic ferrocyanide, and is prevented from dropping through by a knot on one end. It is drawn through the holes and a *Bickford's* fuse fastened to the other end.

Blasting Compound from Potato-Starch. The process is similar to that of manufacturing nitro-glycerine. The potato-starch is shaken with concentrated nitric acid until it is dissolved, and then, with vigorous stirring, poured into sulphuric acid, whereby the preparation is separated in a finely-divided condition. All traces of acid are then removed by washing and rewashing, and treating the preparation with sodium carbonate. The explosive starch flour, when dry, forms a tender white powder. When touched with a glowing piece of wood it is quickly consumed with a yellow flame without leaving a residue. A great advantage of the explosive starch flour is that it explodes only after having been repeatedly struck with a hammer upon an anvil. Its ignition temperature is between 356° and 374° F. In external appearance this explosive agent does not differ from ordinary starch flour. It remains entirely unchanged when boiled in

water, but loses the property of being colored blue by iodine. If examined with the microscope the well-known starch globules cannot be detected.

A *New Blasting Powder*, patented in Germany by *Th. Martinsen*, consists of:

	PARTS.		
	I.	II.	III.
Saltpetre	70	64	56
Sulphur	12	12	22
Lampblack	5	3	3
Sawdust or tan	13	21	29
Ferrous sulphate	2	3	5

The ferrous sulphate is completely dissolved in a little water, and the other components are mixed with it at 248° to 266° F. The mixture is cooled off by constantly stirring it and then dried. This powder can be stored, transported, and used without danger, and develops no smoke in the mine. The first mixture is intended for dense rocks, the second for anthracite, and the third for bituminous coal.

To protect blasting agents containing nitro-glycerine and ammonium nitrate from moisture, and to prevent the exudation of the nitro-glycerine, *Nobel* adds paraffine to them. He recommends the following proportions: 69 per cent. of sodium nitrate, 7 per cent. of paraffine, and 4 per cent. of charcoal. These ingredients are carefully mixed, and 20 per cent. of nitro-glycerine is added to the mixture. Or, 75 per cent. of ammonium nitrate, 3 per cent. of charcoal, 4 per cent. of paraffine, and 18 per cent. of nitro-glycerine.

Giant Powder. Forty parts of nitro-glycerine are mixed with 60 parts of a dry mixture, consisting of 40 parts of sodium nitrate, 6 of rosin, 6 of sulphur, and 8 of infusorial earth or other analogous absorbent substance. This forms a powerful blasting compound, which will not ignite from contact with flame nor from a blow, but may be readily exploded by the shock given by discharging a cap containing fulminate.

Faure & French's Blasting Compound is a mixture of 1 part of charcoal, 16 of barium nitrate, and 1 of nitro-cellulose stirred into a dough with some water and then formed into disks and dried.

Gun-Cotton. Cotton-wool is immersed in a boiling dilute solution of

potassium carbonate, then washed with water and well dried. It is now steeped for a few minutes in a cold mixture of 1 part of concentrated nitric acid and 3 of oil of vitriol, then squeezed, and again placed in a fresh acid mixture and left there for 48 hours. It is then again well squeezed and washed for a long time with running water, and finally steeped in a solution of potassium carbonate.

Gun-cotton thus manufactured will keep without change indefinitely, and may be kept under water for safety's sake, and possesses, after drying, all its original properties.

It is insoluble in water, alcohol, and ether. It takes fire at 300° F., burning away rapidly but without explosion; but when ignited in a confined space, or by percussion, it decomposes with a violent detonation, the energy of which equals that of five times its weight of gunpowder.

New Blasting Compounds.

1. *Peralite* is a coarse-grained powder consisting of 64 per cent. of salt-petre, 30 per cent. of charcoal, and 6 per cent. of sulphide of antimony.

2. *Jaline* contains 65 to 75 per cent. of saltpetre, 10 per cent. of sulphur, 10 to 15 per cent. of lignite, 3 to 8 per cent. of sodium picrate, and 2 per cent. of potassium chlorate.

New Blasting Compound from a Combination of Honey and Glycerine. The following proportions by weight are used:

No. I. Fifty parts of combination of honey and glycerine, 12 of potassium chlorate, 16 of potassium nitrate, 17 of prepared sawdust, and 5 of prepared chalk.

No. II. Thirty-eight parts of combination of honey and glycerine, 19 of potassium chlorate, 24 of potassium nitrate, 10 of prepared sawdust, and 9 of prepared chalk.

The combination of honey and glycerine is prepared as follows: Mix 1 part of nitric acid of 1.50 specific gravity and 2 parts of sulphuric acid of 1.84 specific gravity, and let the mixture cool off to 62° F. Eight parts of this mixture are placed in a wooden vessel lined with lead, and to this is added, with slow and constant stirring, 1 part

of a mixture of equal parts of honey and glycerine, keeping the temperature of the compound between 59° and 68° F. After stirring for about 5 minutes the combination of honey and glycerine settles on the bottom of the vessel. It is then separated from the supernatant acid and washed first with water and next with a solution of soda to remove the last traces of acid. It is now ready for mixing with the other ingredients, which must have been previously pulverized and intimately mixed. The sawdust flour is prepared by passing ordinary sawdust through a fine sieve and boiling it in a solution of soda until all resinous and coloring substances have been extracted, when it is washed in cold water and dried.

Preparation of Blasting Compounds by directly Nitrating Crude Tar Oils. The crude tar oils are gradually compounded by constant stirring with nitric acid of a high grade. The clear oil standing over the precipitate is poured off into another vessel, nitric acid added to the residue, and the process repeated.

The nitrogenized substances obtained in this manner are washed, dried, and mixed with substances yielding oxygen. The nitrates of alkalies, potassium chlorate, and the strongest nitric acid (1.5 specific gravity) are principally used for the purpose.

Gelatinous Nitro-glycerine. Cotton carefully cleansed and comminuted is boiled in a closed boiler with 5 parts by weight of dextrine and some acetate of ammonium; the resulting jelly, of which as much as 7 per cent. may be dissolved in nitro-glycerine, forms with it a mass from which no nitro-glycerine can escape.

To prepare the blasting compound "*Forcite*" 76 parts of the above gelatinous nitro-glycerine are mixed with 15 parts of saltpetre and 9 of sawdust.

Cartridge Shells of Easily Combustible Substances. The material consists of very loosely woven cotton or silk tissue, which is impregnated with nitro-glycerine, or with a mixture of sulphur and saltpetre. When the tissue is dry, collodion, to which a small quantity of castor oil has been added, is poured over it and it is then smoothed between rollers.

Fulminate of Mercury is used for

filling percussion caps. It is prepared on a large scale by dissolving 1 part of mercury in 12 of pure nitric acid of 1.36 specific gravity, and adding 12 of spirit of wine, when a violent reaction takes place, which is kept in check by adding gradually more alcohol. First, the liquid becomes black by the separation of metallic mercury, which, however, soon disappears. When the liquid becomes cool the fulminate of mercury separates as a crystalline powder. It is nearly insoluble in cold water: from a boiling solution it is obtained in white prismatic crystals. When kindled in the open air it burns away like gunpowder, but by percussion it is decomposed with a violent detonation. The explosion of the fulminate is so violent and rapid that it is necessary to moderate it for percussion caps. For this purpose it is mixed with potassium nitrate or chlorate. For gun caps potassium chlorate is generally mixed with the fulminate, and powdered glass is sometimes added to increase the sensibility of the mixture to explosion by percussion. After a little of the composition has been introduced into the cap, it is made to adhere by a drop of solution of shellac in spirit of wine, which renders it also water-proof.

Fulminate of Silver. Ten grains of pure silver are dissolved, at a gentle heat, in 70 drops of concentrated nitric acid of 1.42 specific gravity and 50 drops of water. As soon as the silver is dissolved the heat is removed and 2,000 drops of alcohol are added. If the action does not commence after a short time, a very gentle heat may be applied until effervescence begins, when the fulminate of silver will be deposited in minute needles, and may be further treated as in the case of fulminate of mercury. When dry the fulminate of silver must be handled with the greatest caution, since it is exploded far more easily than the fulminate of mercury. It should be kept in small quantities, wrapped up separately in paper, and placed in a pasteboard box. The violence of its explosion renders it useless for percussion caps, but it is employed in detonating crackers.

Fulminating Platinum is obtained by dissolving binoxide of platinum in diluted sulphuric acid and mixing the

solution with an excess of ammonia, when a black precipitate will result which detonates violently at about 400° F.

Fulminating Gold is obtained as a buff-colored precipitate when ammonia is added to a solution of terchloride of gold. It explodes violently when gently heated.

BLEACHING.

New Method of Bleaching Cotton Yarns, Tissues, etc. This new method of bleaching, invented by *Baues* and *Grisdales*, is based upon rendering the goods more porous and receptive of the bleaching agent of any kind by treating them in a vacuum boiler from which the air is removed by an air-pump.

Cleansing of Cotton and other Vegetable Fibres. Mix 8 parts of soda with 1 part of unslaked lime, and stir the mixture with a quantity of water sufficient to dissolve the soda. Then allow the fluid to clear by standing, and pour it off from the residue. The clear fluid, according to circumstances, should show 1.5° to 2.5° of Twaddle: 1.5° is sufficient for fine, light goods, while a stronger fluid is required for coarse, heavy materials. The yarns or tissues are dipped for 30 to 50 minutes in the fluid, and then bleached in the usual manner.

To Bleach Cotton Goods with Woven Borders. 1. Soak in alkaline lye. 2. Rinse thoroughly, using a centrifugal. 3. Boil with solution of soap in a high-pressure boiler. 4. Place them for 6 to 8 hours in Javelle's lye. 5. Rinse thoroughly with water. 6. Pass them through a hydrochloric acid bath. 7. Rinse in ammoniacal water. 8. Pass them through a centrifugal, and dry.

To Bleach Muslin. For 100 pounds. Boil the muslin for 4 to 6 hours in a lye consisting of 4½ pounds of caustic soda, then rinse it out and winch. Now place the muslin in a bleaching bath composed of 5½ pounds of chloride of lime of 100° and water; allow it to remain in this for 8 to 12 hours and then place it in fresh water to which 1 pound of sulphuric acid has been added. Here it remains for 1 hour, when it is rinsed and dried.

Frohnheiser's Method of Bleaching Cotton. Five pounds of calcined soda and 3 pounds of chloride of lime are mixed, each by itself, with water, and then poured together. The mixture is allowed to settle and the clear fluid poured off. In it 200 pounds of cotton yarn are boiled for 8 hours and then rinsed in water. Now 10 pounds of chloride of lime are stirred with water and 1½ pounds of sulphuric acid added to it. In this the yarn is placed for 6 to 8 hours, when it is brought into a cold-water bath to which 5 pounds of sulphuric acid have been added. It remains here for 6 hours, when it is rinsed in warm water and is then brought into a solution of 3 pounds of potash or 4 pounds of calcined soda, where it remains for 3 to 4 hours, when it is thoroughly washed, passed through a centrifugal, and then completely dried.

To Bleach Cotton Piece Goods. 1. Wash the pieces thoroughly in a washing machine. 2. Boil for 6 hours in a high-pressure boiler with an addition of milk of lime. 3. Place them over night in a hydrochloric acid bath of 3° Beaumé. 4. Rinse them thoroughly to remove all traces of acid. 5. Boil for 4 hours in a solution of soda of 5° Beaumé. 6. Remove all traces of the solution of soda by rinsing. 7. Place them for 6 hours in a perfectly clear bath of chloride of lime of 4° Beaumé. 8. Place them for half an hour in the hydrochloric acid bath. 9. Remove all traces of acid by rinsing.

In place of the hydrochloric acid bath a sulphuric acid bath may be used. The lime separated by this has the effect of loading the fibre.

Cotton, as it comes from the spinning machine, can be bleached by placing it in a hermetically closed box and passing through a current of freshly developed chloroform. The chloroform is developed in an alembic from equal parts of chloride of lime, caustic lime, and alcohol, and a sufficient quantity of water to form a thin paste, and enters the box in the form of vapor. Towards the end of the operation sulphuric acid is slowly added to the chloroform mixture, whereby the development of vapor is promoted. After the vapor has acted upon the cotton for 1 hour the alembic is re-

moved and a strong current of a mixture of carbonic acid, vapor of ether, and hydrogen gas is passed into the box for 10 to 12 hours, when the cotton will be thoroughly bleached and is dried in the drying room.

Bleaching of Woollen Tissues. The process of bleaching woollen tissues may be divided into *Cleansing and Bleaching* the goods.

1. *Cleansing.* This is done with soap and soda in a special apparatus. Woven woollen goods should not be brought into the apparatus in loose folds like cotton, but must be kept stretched, or else they lose much of their beauty. The temperature of the bath must not be raised too high. If the goods are to be bleached entirely white the treatment with soda and soap must be repeated several times. *Clauzon* cleanses the wool without employing heat, and uses for this purpose a weak solution of ordinary soda, brings it then into very dilute sulphuric acid, and finally into water. For very fine goods he uses ammonium carbonate instead of soda. In bleaching he first dips the wool in a solution of soda, then exposes it to the fumes of burning sulphur, and finally washes it.

The use of caustic soda is not without danger, as, besides the fatty substances, the wool itself may be decomposed. The operation must be carefully and constantly watched to prevent the presence of an excess of caustic soda in the bath. When the cloths have been thoroughly cleansed the next operation is

2. *Bleaching.* This is accomplished by means of sulphurous acid. This gas has an entirely different effect from that of chlorine, as, instead of destroying the coloring matter, or of transforming it so that it can be removed from the goods by washing, it forms a permanent combination which remains fastened upon the fibre. The sulphuring is done either with gaseous or with fluid sulphurous acid. In the first process, which is generally employed, large chambers which can be hermetically closed are used. These are provided with valves, opening inward, for the admittance of air during the time the gaseous acid is absorbed by the cloth. After the goods have been

stretched over frames in the chamber, an iron pot containing sulphur is placed in the room, which is then hermetically closed. The developed sulphurous acid is absorbed by the wet goods and comes in contact with the coloring matter and bleaches it. A rarefied space is formed by the absorption, but this is immediately equalized by the air entering through the above-mentioned valves, which supply the oxygen necessary for the combustion of the sulphur. The goods remain for 24 hours exposed to the action of the sulphurous acid, although sometimes this is not sufficient. If this should be the case, a fresh quantity of sulphur is placed in the room and the operation repeated.

Forty pieces of goods from 20 to 30 yards long are arranged together, singed like cotton goods, and then treated as follows: 1. Bring them 3 times into a bath composed of 25 pounds of crystallized soda and 12 pounds of soap to 125 to 150 gallons of water, and heated to about 100° F. Add $\frac{1}{2}$ to $\frac{3}{4}$ of a pound of soap to the bath every time after the goods have been passed through it. 2. Rinse them twice in clean water of the same temperature. 3. Bring them 3 times into a similar bath as No. 1, but containing no soap. After having been passed through for the first time add $\frac{1}{2}$ pound of fresh soda to the bath. 4. Sulphur them for 12 hours in the apparatus mentioned above. Twenty-five pounds of sulphur are burned for the 40 pieces. 5. Bring them 3 times into a bath containing 30 pounds of soda to 125 to 150 gallons of water, and heated to 120° F. Add $\frac{1}{2}$ pound of soda to the bath each time after the goods have been passed through it. 6. Second sulphuring like No. 4. 7. Repeat the bath as in No. 5. 8. Wash them twice in water of 85° F. 9. Sulphur them for 12 hours. 10. Wash them twice in lukewarm and once in cold water. 11. Blue them with indigo.

These operations generally suffice for ordinary woollen goods, but not if they contain much coloring matter, or if they are intended for fine dyes. All traces of fatty matter must be removed, as they exert an injurious effect upon the dyestuffs. In these cases the following process is employed: After singeing and

washing the goods in water pass them, 1. Through an alkaline soap bath consisting of 50 pounds of crystallized soda and 10 pounds of soap to 125 to 150 gallons of water, and heated to 140° to 150° F. 2. Rinse them in warm water. 3. Pass them twice through a bath consisting of 25 pounds of soda to the same quantity of water as No. 1 and of the same temperature. 4. Wash them in warm water. 5. Sulphur them for 10 hours with 25 pounds of sulphur for 250 pieces. 6. Wash them. 7. Pass them twice through a bath of 16½ pounds of soda to the same quantity of water as No. 1, but heated to 140° to 150° F. 8. Pass them twice through a bath of 13 pounds of soda to the same quantity of water as No. 1, but heated to 140° to 150° F. 9. Wash them in warm water. 10. Sulphur with 17 pounds of sulphur to the same number of pieces. 11. Wash, and, 12. Blue them.

To Keep Woollen Goods White. The goods, after bleaching by sulphuring, are placed in a bath of 10 gallons of water, 3 pounds of castile soap, and 1 to 1½ pounds of spirit of sal ammoniac. The addition of sal ammoniac prevents the goods from turning yellow when stored, and that of soap from feeling rough to the touch.

To Bleach Wool without Sulphur. The loose wool, or yarn, is thoroughly washed with soda and soap in the ordinary manner. It is then brought into a cold bath of 2 pounds of hyposulphite of sodium to 11 gallons of water, where it remains for 1 hour, when it is taken out. 6½ pounds of hydrochloric acid are then added to the same bath, the wool is replaced in it, and allowed to remain for 1 hour. The vessel containing the wool must be well covered during the last treatment, and the bath must be large enough to conveniently handle the wool in it. The loose wool, or yarn, acquires, by this operation, a much better appearance than that bleached with sulphur, and keeps white for a longer time.

To make Wool bleached without Sulphur beautifully White. Take to 1 part of spun wool 2 of chalk, scrape this fine and stir it into a thin paste with soft water. The wool is thoroughly rubbed with this paste, as if it were to

be washed with soap, and is thus left for 24 hours. It is then rinsed in soft water until all traces of the chalk are removed. By repeating the operation the white becomes more brilliant.

Bleaching of Silk. Raw silk, according to R. Wagner, can be bleached entirely white without previously removing the gum by boiling, and with but a small loss of weight. This is done by digesting the raw silk in a mixture of 1 part of hydrochloric acid and 23 of alcohol. The fluid assumes a green color, and the silk, after it has been washed and dried will be perfectly white. One hundred parts by weight of raw silk give by this process 97.19 parts by weight of bleached silk. The loss in weight, therefore, amounts to but 2.91 per cent.

Quick Method of Bleaching Flax Yarn, according to C. Hartmann. The yarns are soaked for 48 hours in water at 110 to 122° F., to dissolve the dirt accumulated in spinning. The water is then drawn off and fresh water poured over them until it runs off quite clear. The yarns are then dried and boiled 2 to 3 hours in a soda lye of 2½° to 3° Twaddle. Fresh water is again poured over them until it runs off clear. The yarns are dried, and again boiled in equally strong lye, and soaked in water. They are then dried and winched in a solution of sodium chloride ¾° to 1° Twaddle strong, or in a solution of chlorine. They are then thoroughly washed and laid upon the bleaching ground, where they remain for 8 days, are then turned and allowed to remain for 3 days longer. They are then again boiled, treated as above, dried, brought into a weak chlorine bath, dried, and placed upon the bleaching ground. If the yarns are to be only ¾ bleached, they are placed in a 1° strong solution of sulphuric acid. If they are to be bleached entirely white, they are boiled a fourth time in the same manner as above, and, after having been dried, are brought into a weak chlorine bath, and finally in a sulphuric acid bath as above.

For a better comparative view, *Hartmann* recapitulates the process for entirely bleached and ¾ bleached yarns as follows:

Entirely Bleached.

Soaking 48 hours.
 Rinsing with water.
 Drying.
 Boiling with soda 4 hours.
 Rinsing with water.
 Drying.
 Boiling with soda.
 Rinsing with water.
 Drying.
 Chlorine bath or winching.
 Washing.
 Eight days upon the bleaching ground.
 Turning upon the bleaching ground.
 Boiling with soda.
 Rinsing with water.
 Drying.
 Chlorine bath.
 Washing.
 Four to 6 days upon the bleaching ground.
 Boiling with soda.
 Rinsing in water.
 Drying.
 Chlorine bath.
 Washing.
 Sulphuric acid bath and washing.
 Drying.

 $\frac{3}{4}$ Bleached.

Soaking 48 hours.
 Rinsing with water.
 Drying.
 Boiling with soda 4 hours.
 Rinsing with water.
 Drying.
 Boiling with soda.
 Rinsing with water.
 Drying.
 Chlorine bath or winching.
 Washing.
 Eight days upon the bleaching ground.
 Turning upon the bleaching ground.
 Boiling with soda.
 Rinsing with water.
 Drying.
 Chlorine bath.
 Washing.
 Sulphuric acid bath.
 Drying.

when they are taken out, rinsed in soft water, squeezed out and dried.

To Bleach and Harden Tallow.

Place 100 pounds of the brownish tallow in a copper boiler, and add $\frac{1}{2}$ gallon of clean water. Then melt the tallow at a moderate heat, and add, with constant stirring, a mixture of 1 pound of sulphuric acid in $1\frac{1}{2}$ gallons of water. Next add $\frac{1}{2}$ pound of finely powdered potassium bichromate, and finally $1\frac{1}{2}$ gallons of pure water. The fire is now allowed to go out, and the tallow, which will be as clear as water, and of slightly greenish tint, is left to congeal, when it is skimmed from the dark green fluid on the bottom of the boiler.

To Bleach Bristles. Wash the bristles thoroughly in a solution of soft soap in tepid water; then rinse them in cold water. Now place them for 2 or 3 days in a saturated aqueous solution of sulphurous acid, wash them in clean water and dry them.

To Bleach Copper Plate Engravings, Woodcuts, etc.

Place a quantity of phosphorus in glass carboy with a wide mouth, such as is used for storing sulphuric acid will answer the purpose. Pour into the carboy sufficient water at 85° F. to half cover the phosphorus fragments. Close the carboy loosely with a cork, and let it stand for 12 or 18 hours in a moderately warm place. The paper, print, etc., to be bleached, is moistened with distilled water, then fastened to a platinum wire, and suspended in the carboy, where it will become entirely white in a short time. But as there will be some acid reaction after the paper has been taken from the carboy, it must be rinsed with water until the latter does not turn blue litmus paper red. The paper is then passed through a weak solution of soda, next through clean water, and finally dried upon a glass plate.

To Bleach Shellac. Rub 2 pounds of chloride of lime to a paste with water, strain this through linen, and wash out the residue with 2 pounds of water. A solution of 1 part of potash in 3 of water is added to the filtrate until no more precipitate is formed, when the precipitate is filtered off. Generally 4 ounces of potash or 1 pound of the solution of potash is allowed for each pound of chloride of lime.

Hartmann remarks that the yarns should be washed as little as possible, or else they will lose too much weight, which should never amount to more than 18 to 20 per cent. After each boiling, rinsing the yarns in water is sufficient, but washing is absolutely necessary, after treating them in the chlorine bath, and with sulphuric acid.

To Bleach Sponges. Beat the sponges carefully, and then place them in a mixture of 1 part of hydrochloric acid and 20 of water. They are then boiled in water and thoroughly washed, after which they are placed in a water bath to which a sufficient quantity of sulphuric acid has been added to bring it to 4° Beaumé. This bath is compounded with bleaching liquor, until it is entirely saturated with gas. The sponges remain in this for half an hour, when they are taken out, rinsed off in soft water, and passed through an acid bath. They are placed several times in succession in a bath acidulated with sulphuric acid to 4° Beaumé, and to which a sufficient quantity of potassium hydrate or of sodium hydrate has been added to impregnate it with gas. The sponges remain here for some time,

Two pounds of the shellac to be bleached are digested for a few days in 1 gallon of highly-rectified spirit of wine. To this is added, with constant stirring, the above fluid, and, in the course of half an hour, a sufficient quantity of hydrochloric acid is added to produce an acid reaction.

The shellac will assume the appearance of a white, tough mass. This is freed from the acid by rinsing, and washed with boiling water until this has no longer a milky appearance. The shellac is then placed upon a moist board, formed into strips, and dried in the air.

The fluid, which is first poured off, is saturated with hydrate of lime, and the spirit of wine contained in it can then be recovered by distillation.

To Bleach Straw. There is no better process than treatment with sulphur in connection with very weak chlorine, as by this the straw will lose nothing of its lustre and durability. Bleaching by natural means does not suffice, as the coloring matter is not sufficiently destroyed, and, moreover, the straw will lose its durability by having to remain for a long time upon the bleaching ground. Bleaching by chlorine alone cannot be recommended; for although it exerts a powerful bleaching effect upon straw, as it must be used very strong, it makes the straw brittle and destroys its lustre. In using sulphur in combination with chlorine, the straw is first soaked for 24 hours in hot water, and then boiled for 3 hours in water containing 1 pound of potash to 9 gallons of water. The straw is then soaked in cold water, this being repeated until the water runs off entirely colorless. The straw is now boiled in a lye half as strong as the first and then soaked in cold water for 3 days. This finishes the cleansing operation. The straw is now subjected to the actual bleaching process. For this purpose it is brought into a hermetically closed chamber and exposed, while still moist, for 12 to 16 hours to the action of sulphurous vapors produced by the combustion of sulphur. It is washed in water and soaked for about 30 hours in a very dilute solution of chloride of lime, which should be as clear as water. It is then rinsed off with pure water, and finally, to free it

from the odor of chlorine, a very weak solution of sodium hyposulphite is poured over it and allowed to act upon it for several hours. When the odor of chlorine has disappeared the straw is washed with pure water and dried.

David's New Process of Bleaching. Gaseous chlorine is generated in a closed receptacle by one of the ordinary methods (as by the action of an acid on chloride of lime diluted with water), and is conveyed by a pipe into a chamber containing the articles to be bleached. The sides of the chamber are constructed of a transparent material in order to admit the entrance of light, which assists considerably in the process of decolorization. After some length of time, varying with the nature of the articles to be bleached, a rapid current of carbonic acid gas, obtained by any of the well-known methods, is sent into the chamber. The apparatus in which the carbonic acid is generated communicates with a vessel containing liquid ammonia, the fumes of which combine with the carbonic acid and are conveyed into the chamber, where the two gases neutralize the hydrochloric acid and accelerate the decolorization of the materials contained therein. The ammonia should be contained in a vessel of such a shape that the evaporating surface of the liquid can be augmented or diminished according to the quantity of chlorine employed.

In the second process, permanganate of lime is obtained by the action of peroxide or binoxide of manganese on lime aided by heat in the following manner: One part by weight of peroxide of manganese and 3 parts by weight of quicklime in powder are mixed together and submitted to a red heat for about 3 hours. When the heat has been continued for 1 hour a rapid current of carbonic acid is passed through the mixture and continued until the process is completed; the object of this being to peroxidize the compound. The permanganate of lime thus prepared is placed in a closed receptacle which communicates by a pipe with the bleaching chamber, ordinary sulphuric acid is gradually added, and "ozonized oxygen" is evolved. In order to accelerate the evolution of this gas a vegeta-

ble acid in quantity equal to the sulphuric acid is added.

In the third process phosphorus and acetic acid are employed. The production of ozone by means of phosphorus in a moist atmosphere is well known, but the quantity thus obtained is very small. By causing air which has been previously forced through acetic acid to bubble through the water containing the phosphorus, the quantity of ozone is considerably increased. The ozone is conveyed to the bleaching chamber in the same manner as before described, the air being forced through the liquids by means of a fan.

When the materials are removed from the bleaching chamber it is desirable to expose them for a time to the action of the atmosphere in order to remove the odor of ozone. This process is adapted to the bleaching of raw or worked materials, especially those which from their shape or nature cannot be immersed in a liquid, and also to books, papers, and engravings.

To Bleach Stained Marble. Soap the stained marble with a fine piece of linen. Then cover it with a cloth and pour upon this a solution of 1 ounce of cream of tartar in 2½ gallons of water. Repeat the moistening 6 to 8 times a day for 6 weeks, and expose the marble to the action of the sun, when the stains will be removed and the marble become entirely white. Cracks in white marble are filled with a paste of powdered alabaster with glue water; for gray marble a paste of powdered slate and glue water is used; for red marble, ochre, etc.

BOILER INCRUSTATIONS.

The following remedies are recommended to remove and prevent boiler incrustations:

Saillard's Receipt.

Catechu	100 parts.
Potash	50 "
Soda	50 "
Common rosin	10 "
Lime	20 "
Water	200 "

The lime, rosin, soda, and water are boiled for 30 minutes and then allowed

to settle. A decoction of the catechu in 100 parts of water is prepared in another boiler, strained, and mixed with the other solution. The fluid is then stored for future use. Every 6 weeks 1 pint of the liquor for each horse-power is introduced into a boiler by means of the feed-pump.

For a 10 horse-power boiler, fed with water containing calcic sulphate, take:

Catechu	4 pounds.
Dextrine	2 "
Crystallized soda	4 "
Potash	1 pound.
Cane sugar	1 "
Alum	1 "
Gum Arabic	1 "

For a boiler of the same size, fed with water containing lime, take:

Turmeric	4 pounds.
Dextrine	2 "
Sodium bicarbonate	4 "
Potash	} each 1 pound.
Molasses	
Alum	

For a boiler of the same size, fed with water containing iron, take:

Gamboge	4 pounds.
Soda	4 "
Dextrine	2 "
Potash	} each 1 pound.
Sugar	
Alum	
Gum Arabic	

For a boiler of the same size, fed with sea water, take:

Catechu	4 pounds.
Glauber's salt	4 "
Dextrine	4 "
Alum	1 pound.
Gum Arabic	1 "

When one of the above preparations is to be used ½ gallon of water is added to it, and, in ordinary incrustation, the boiler is charged with it every month; but, if the incrustation is strong, every 2 weeks.

For boilers of 30 horse-power, fed with river water, the following mixture is used, which should be renewed every time the boiler is emptied:

Crystallized soda	6 pounds.
Dextrine	6 "
Alum	2 "
Sugar	2 "
Potash	1 pound.

For the same sized boiler, fed with sea water :

Soda	8 pounds.
Dextrine	8 "
Sugar	4 "
Alum	1 pound.
Potash	1 "

Alferi's Receipt. A mixture of 250 parts of carbonate of baryta, 325 of ammonium nitrate, 225 of sodium chloride, and 200 of animal charcoal, prevents incrustations, and dissolves those already formed.

Baudel's Preventive consists of 15 parts of sodium hyposulphite, 10 of rain water, and 10 of glycerine. It augments the solubility of gypsum (calcic sulphate), and separates the carbonates and phosphates in the form of powder, and the other salt forms a jelly with the glycerine.

Rogers' Preventives. Dr. Joseph G. Rogers has proposed two methods for preventing boiler incrustation: one consists in introducing into the boiler a sufficient quantity of *sodium oxalate*, which converts the scale-forming impurities of the feed water into insoluble oxalates as soon as they enter the boiler. These oxalates are precipitated as a mushy sediment, which has no tendency to form scale, and which may be blown out from the mud drum from time to time: another consists in the use of *sodium tannate*, which is kept constantly present in the boiler in solution; it decomposes the calcium and magnesium carbonates as they enter, tannates being precipitated in a light, flocculent, amorphous form, which gradually accumulate in the mud drum, from which they may be readily blown out from time to time. The sodium carbonate formed in the reaction remains in solution, becoming bicarbonate by appropriation of the free carbonic acid in the water. This reacts upon the calcium sulphate, forming sodium sulphate and calcium carbonate, which latter in turn is acted on as above by fresh portions of the sodium tannate. The constant presence of the alkali protects the iron from any injurious action of the tannic acid. A similar reaction will take place between the tannate and the already formed scale, though the action will be a gradual one.

Rogers' processes are based on sound chemical principles, and can be commended. (W.)

BONE, HORN, AND IVORY—TO BLEACH AND DYE THEM, AND MAKE IMITATIONS AND COMPOSITIONS.

To Bleach Bone and Ivory. Prepare a solution of 1 part of fresh chloride of lime in 4 of water. Place in it the discolored articles of bone or ivory, and allow them to remain for a few days. Then take them out, wash, and dry them in the open air. Articles of ivory must remain somewhat longer in the solution.

To Bleach Bones. Place the bones in a mixture of unslacked lime, bran and water, and boil them until they are entirely free from fatty substances, and are white.

Hedinger's Method of Bleaching Bones for Turners' Use. Pour oil of turpentine over the bones in tin boxes which can be hermetically closed, let them remain for 10 hours, remove, and boil them for 3 hours in water containing soft soap. Skim off the impurities floating on the surface, cool the hot water with cold, and dry the bones upon pine boards in the open air protected from the sun.

Peineman's Process of Bleaching Ivory turned Yellow. According to one receipt, the ivory is placed in a saturated solution of alum, and allowed to soak in it for 1 hour. It is then rubbed with a woollen cloth, next wrapped in linen, and allowed to dry.

The other process which, according to experiments we have made, is to be preferred, is as follows: Prepare a thin lime paste, heat it over a fire, place the ivory in it, and allow it to remain until it has become white. Then take it out, dry, and polish.

To Make Ivory Soft and Flexible. Place the ivory articles in a solution of phosphoric acid of 1.130 specific gravity, and allow them to remain in it until they have assumed a transparent appearance. Then take them out of the acid, wash them carefully in water, and dry them between soft linen. They are now as soft as thick leather, become hard on exposure to the air, but regain

their plasticity in warm water. Weaker phosphoric acid than the above has no effect.

New Process of Bleaching Ivory and Bones. The following is a very efficacious means of removing the disagreeable odor and fatty emanations of bones or ivory, while it leaves them beautifully bleached. The articles are placed in a glass vessel with oil of turpentine, and exposed to the sun for 3 or 4 days; a little longer in the shade. The turpentine acts as an oxidizing agent, and forms an acid liquor which sinks to the bottom of the vessel, and strongly attacks the bones if they are allowed to touch it. To prevent this they should rest upon strips of zinc, so as to be a fraction of an inch above the bottom of the vessel. The action of the turpentine is not confined to bones and ivory, but extends to wood of various kinds, especially beech, maple, elm, and cork.

Dyeing of Bone and Ivory. Bone and ivory are dyed either without any preliminary preparation, or are first treated for 3 to 4 days with a mixture of sulphuric acid and water, with an addition of a small quantity of tartaric acid, until they are rough and can be pressed with the fingers.

The articles may also be placed in boiling vinegar instead of the diluted mineral acid. After the ivory has been softened in this manner it can be dyed by placing it in the alcoholic solution of any coloring substance, and then worked into the article for which it is intended. The original hardness is restored by wrapping it in a sheet of white paper covered with dry, decrepitated common salt, and allowed to remain for 24 hours.

If alcoholic solutions are not used, the ivory must first be placed in a mordant. This, for most colors, consists of tin salt or a solution of stannous sulphide, obtained from 4 parts of tin, 6 of hydrochloric acid, 8 of sulphuric acid, and 6 of water.

Receipts for Different Colors.

Yellow. I. Prepare a decoction of rasped fustic in water, place the ivory in a solution of tin in *aqua regia*, and then in the decoction of fustic, which should be previously strained.

II. An *orange* color is obtained by adding shavings of Brazil wood.

III. Or, place the ivory in a concentrated solution of potassium chromate and then in a boiling hot solution of sugar of lead in water.

IV. Mordant the ivory in a solution of stannous sulphide or of alum and then place it in a hot decoction of weld.

V. Place the ivory in a solution of yellow orpiment saturated with ammonia.

Blue. I. Prepare a highly diluted solution of sulphindigotic acid, which must be partly saturated with potash. Allow the ivory to remain in this for a longer or shorter time, according to the intensity of the color desired.

II. Dissolved precipitated indigo (blue carmine) may also be used for dyeing ivory blue. Hydrochloric acid should be used as a mordant instead of nitric acid; as the latter colors the cartilage yellow and therefore produces a green color with the indigo.

Green. I. Dip the articles already dyed blue for a few minutes in a solution of tin in *aqua regia*, and finish dyeing in a hot decoction of fustic in water.

II. Dip the ivory in a solution of verdigris in vinegar.

III. Place the ivory for a few hours in a partly saturated solution of potassium chromate, and expose it for some time to the direct rays of the sun. It will acquire a *dark bluish-green* color.

IV. It has been recommended to treat the articles to be dyed green, first with nitric acid, then with a solution of yellow prussiate of potash (potassium ferrocyanide) and an iron salt, and finally with a solution of picric acid.

Red. I. Place the articles for a few minutes in a solution of tin in *aqua regia* and then in a hot decoction of Brazil wood, cochineal, etc., which should first be strained.

II. Boil the ivory with $\frac{3}{4}$ pound of Brazil wood and 1 gallon of water, then add $\frac{1}{4}$ pound of alum, and boil once more.

III. Dip the ivory in a weak solution of aqua fortis and then place it in a solution of carmine.

IV. A more beautiful red is obtained by finishing the dyeing in a decoction of cochineal, or dissolving the carmine

in ammonia. When cochineal is used add alum and a small quantity of tartaric acid to the bath.

Crimson. a. Preparation of the Mordant. Place the prepared and polished ivory in a solution of $\frac{1}{4}$ pound of chloride of zinc in $\frac{1}{2}$ pint of rain or distilled water; allow it to remain 1 hour, though a longer time does no harm.

b. Preparation of the Dye. Boil for 5 minutes in a porcelain saucer 1 ounce of cochineal and 2 pinches of purified tartar in 1 pint of water. Then,

I. Place the mordanted ivory in the fluid and boil until it has acquired a beautiful crimson color. If a darker tint is desired, repeat the process, rinse the ivory off with clean water, dry, and lacquer it with bookbinders' lacquer.

II. A *carmine color* is also produced by rubbing 2 drachms of carmine with 6 drachms of crystallized soda and compounding them with $1\frac{1}{4}$ pints of water. To the solution add acetic acid slightly in excess. Boil the ivory in this bath until it has acquired the desired color.

III. The articles are first dyed in a decoction of weld and then in a solution of carmine. To prepare the latter, dissolve a pinch (as much as will lay upon the point of a knife) of carmine in $4\frac{1}{2}$ fluid ounces of spirit of sal ammoniac, dilute the solution with 1 pint of water and heat the bath. Then place the articles in it and allow them to remain until they are sufficiently dyed. A still more brilliant color will be produced by mordanting the articles with a solution of phosphate of tin instead of with stannous sulphide.

Cherry-Red. This is obtained by placing the articles which have been dyed crimson in an aqueous solution of potash.

Purple. Boil the ivory in a decoction of logwood, then add for every pint of the decoction $\frac{1}{2}$ ounce of alum and boil the articles in this.

Violet. I. The articles are mordanted with the solution of tin, as given under carmine, and then brought into a decoction of logwood in water.

II. Dye the ivory red and then dip for a moment in a solution of indigo.

Lilac is obtained by placing the mordanted ivory in a nearly exhausted bath of logwood.

Black. I. Place the ivory for some

time in a diluted solution of nitrate of silver and then expose it to the sun. But as the color has frequently a greenish shade it will be necessary to repeat the operation several times to deepen the black.

II. A beautiful black color is obtained by boiling the ivory in a strained decoction of rasped logwood, then taking it out and placing it in a solution of sulphate or acetate of iron.

III. Boil the articles first in a decoction of gall-nuts and logwood and then in a solution of sulphate or acetate of iron. If, as for instance in billiard balls, white stripes are desired on a black ground, lay a ribbon saturated with wax around the ball and wrap some cord around it. The places thus covered will remain white in dyeing. We will remark here that all colors adhere better to unpolished than to polished ivory, and it is therefore better to polish the articles after they have been dyed. This is done by rubbing with soap and Vienna lime with the naked hand. In dyeing the boiling should not be continued too long or else the ivory will become full of cracks, and the pieces should be cooled off quickly by being placed in cold water when taken out of the dye.

To Produce Black and Colored Drawings upon Ivory. Rub 1 ounce of tears or drops of mastic to a fine powder and gradually pour into it the same quantity of melted wax, to which add 9 drachms of powdered asphaltum, and stir them into a homogeneous mass which should be placed in tepid water, and, after cooling, rolled into balls about 1 inch in diameter, and when entirely cold wrapped in taffeta. White wax is cheaper and can be substituted for mastic by using the following proportions: $2\frac{1}{2}$ ounces of asphaltum, 1 ounce of rosin, and 9 drachms of wax. The warmed and polished surface of the ivory is covered with this and the drawing scratched into the ivory surface. Concentrated sulphuric acid is poured over the wax enamel and forms a black deposit upon the surface of the ivory exposed by the etching. Warming the ivory or acid facilitates the operation. Immersion in a solution of nitrate of silver, and subsequent exposure to the sun, gives also a very

durable black etching. Solution of gold gives purple. The etching ground is removed with oil of turpentine.

Artificial Ivory. I. Commi-nute the waste of ivory, bones, horn, etc., by rasping, and immerse the shavings in a somewhat diluted solution of a mineral or vegetable acid. The maceration of the material may be accelerated by heating in a water bath to 95° or 100° F. Strain and compound the shavings with $\frac{3}{4}$ of their volume of ivory glue, and free them from excessive moisture by means of an air-pump. The mass is then mixed with a solution of copal in alcohol and poured into sulphur moulds, where it soon becomes hard. This artificial ivory has the appearance of genuine; thin plates of it are as translucent and can be dyed in the same manner.

Artificial Ivory for Photographic Purposes. Allow glue or gelatine to remain in a bath of acetate or sulphate of alumina until it combines with the alumina. The mass is dried until it becomes hard and is polished in the same manner as genuine ivory. A mixture of equal parts of bone dust, glue, and albumen, brought into a suitable form by rolling and pressing, is also used as a substitute for ivory.*

New Artificial Ivory. Mix 10 parts by weight of white shellac, 8 of ivory dust, $4\frac{1}{2}$ of acetate of lead, and 5 of camphor. Heat the mixture, dry, powder, and press it.

To Bleach Ivory Articles fastened upon Leather, etc. Add hydrochloric acid to a solution of chloride of lime, apply the mixture to the ivory by means of a brush, and then expose it to the action of the sun. To prevent the leather, etc., from being attacked by the bleaching agent, it is best to cut the pattern of the ivory ornament out of strong paper, lay this over the leather, and if necessary fill up the joint with wax. When the ornament is bleached, wash off the particles of lime with a brush and water and polish with chalk. For ornaments of horn the bleaching agent must be applied several times; the acid used may also be more concentrated, and a paste consisting of 1 part of water and 1 of chloride of lime

may be employed instead of the solution of chloride of lime.

Artificial Ivory. Two pounds of pure India rubber are dissolved in 32 pounds of chloroform and the solution saturated with purified ammoniacal gas. The chloroform is then distilled off. The residue is mixed with pulverized phosphate of lime or carbonate of zinc, pressed into moulds, and cooled. When the phosphate of lime is used the resulting compound partakes in a great degree of the nature and composition of genuine ivory.

Compound for Buttons, Dice, Dominos, etc. The powder or other filings of soapstone (steatite), obtained in the manufacture of gas burners, is saturated with water-glass, dried, and ground. Buttons and similar articles are pressed from this powder, burned in ovens, dipped again in water-glass, and once more burned. They are then placed in a tumbling box with some water and polished by tumbling, dried, and again polished in a similar box with soapstone powder. Dominos and dice are pressed in a similar manner in dies of brass or steel and then polished.

A New Method of Treating Horn. By this process horn is converted into a substance resembling whalebone. It consists in first cutting the horn into strips, then softening and pressing flat, and next boiling in a closed boiler in a decoction of sage leaves to which has been added a little potash. Horn so treated can be rolled into long strips by passing through rollers, and the ends of the strips can be joined together by the pressure of the rollers; or large sheets may be made by joining the strips at the sides, the rolling firmly uniting the edges so as to form one piece.

To Dye Horn so as to Resemble Tortoise Shell. I. Make a dough of 2 parts of unslacked lime, and 1 of litharge, by adding a sufficient quantity of soap boiler's lye. Cover with this all parts of the horn which are to be dyed. By placing a brass plate under the horn so treated, the imitation will be still more perfect.

II. To produce semi-transparent spaces upon horn, mix with the above dough a substance, for instance chalk or fine sand, which will decrease the caustic power of the dough. This treat-

* For this purpose nothing equals celluloid. (W.)

ment produces red stains upon the surface of the horn, which enhances the beauty of the article, and its resemblance to genuine tortoise-shell.

III. Mix orpiment with filtered lime-water, and apply the solution with a brush. Repeat the application if necessary.

IV. Mix 1 ounce of litharge and 9 drachms of unslacked lime to a paste with a sufficient quantity of wine. This composition is applied to the horn, and removed in 3 or 4 hours.

V. By using a solution of gold for dyeing the horn, red stains are produced upon it.

VI. A solution of silver in nitric acid dyes horn black.

VII. A brown color is obtained by brushing the horn over with a solution of nitrate of mercury.

Buttons from Waste of Horn. The waste is pulverized by cylindrical graters, and the powder brought into cylindrical moulds, and subjected to high pressure, the temperature being increased at the same time. The cylinders of horn thus obtained, as soon as they come from the moulds, and while still hot, are cut into disks of the desired thickness.

BRONZING AND COLORING OF METALS.

Green Bronze for Brass. No. 1. Mix 80 parts of strong vinegar, 1 of mineral green, 1 of red umber, 1 of sal-ammoniac, 1 of gum Arabic, and 1 of green vitriol, and add 4 of Avignon berries (fruit of *Rhamnus infectorius*). Boil the mixture, and strain when cold. The articles to be bronzed should be cleansed with weak aquafortis, then rinsed, and the fluid applied with a brush. Should the color not be dark enough, heat the article until it cannot be held in the hand, and then give a coat of spirit of wine mixed with a little lamp-black. Finally apply a coat of spirit varnish.

No. 2. Add to a solution of $8\frac{1}{2}$ drachms of copper in 1 ounce of strong nitric acid $10\frac{1}{2}$ fluid ounces of vinegar, $3\frac{1}{2}$ drachms of sal-ammoniac, and $6\frac{3}{4}$ drachms of aqua-ammonia. Put the liquid in a loosely corked bottle, and allow it to stand in a warm place for a

few days, when it may be used. After applying it to the articles, dry them, by exposure to heat, and, when dry, apply a coat of linseed oil varnish, which is also dried by heat.

Chinese Bronze. Small articles bronzed by this process possess a peculiar beauty, and lose none of their lustre, even when exposed to atmospheric influences and rain.

Powder and mix thoroughly 2 parts of crystallized verdigris, 2 of cinnabar, 2 of sal-ammoniac, 2 of bills and livers of ducks, and 5 of alum. Moisten the mixture with water or spirit of wine, and rub it into a paste. Cleanse the article to be bronzed thoroughly, and polish it with ashes and vinegar. Then apply the paste with a brush. Heat the article over a coal fire, and wash the coating off. Repeat this operation until the desired brown color is obtained. By adding blue vitriol to the mixture, a chestnut brown color is produced, while an addition of borax gives a yellowish shade.

Bronzing Process used in the Paris Mint. Powder and mix 1 pound each of verdigris and sal-ammoniac.

Take a quantity of this mixture, as large as a hen's egg, and mix into a dough with vinegar. Place this in a copper pan (not tinned), boil in about 5 pints of water for 20 minutes, and then pour off the water.

For bronzing, pour part of this fluid into a copper pan, place the medals separately in it upon pieces of wood or glass, so that they do not touch each other, or come in contact with the copper pan, and then boil them in the liquid for a quarter of an hour.

Oxidized Silver. (*Argent oxydé.*) Place the silver, or plated, articles in a solution of liver of sulphur diluted with spirit of sal-ammoniac. They are then taken out, washed, dried, and polished.

The above process produces a blue black tint, while a solution of equal quantities of sal-ammoniac and blue vitriol in vinegar gives a brown shade.

Antique Green. This can be imitated upon new articles by the following process: Dissolve 1 part of sal-ammoniac, 3 of powdered tartar, and 3 of common salt in 12 of boiling water. Then add 8 parts of a solution of cupric nitrate, and coat the articles with the liquid.

Fire-proof Bronze upon Copper and Brass. Dissolve 1 drachm of crystallized verdigris and a like quantity of finely-powdered sal-ammoniac in 14 ounces of rain-water. Cover the vessel containing the solution, and allow it to stand quietly for 3 to 4 hours, and then add $1\frac{1}{2}$ pints of water.

In bronzing, hold the copper or brass article over a coal fire and heat to a uniform heat and color. Then brush it over with the above mixture and dry carefully. In case the article is tinned it must not be heated enough to melt the tin. By thus heating copper 5 or 6 times it acquires a brassy color, and after 6 to 10 applications a beautiful yellow tint. If it is desired to give a copper article a color shading from yellow into brown, it must be very hot when the mixture is applied; for light brown the operation must be repeated 20 to 25 times. When the copper has acquired the desired color place it at once into clean water, but do not cleanse or dry it immediately after taking it out. In fact the greatest care is here required. It is best to dry the article over a moderate coal fire, when the bronze will become durable and fire-proof.

Commercial Bronzes. The colors are prepared by beating bronze to thin leaves similar to those of gold. They are then rubbed upon a stone with a pestle, an inspissating agent being added during the process.

Samples analyzed by *Koenig* contained:

COLORS.	PARTS.			
	Copper.	Zinc.	Iron.	Tin.
Pale yellow . . .	82.33	16.69	0.16	
Bright yellow . .	84.50	15.30	0.07	
Orange	98.93	0.73	0.08	
Green	84.32	15.02	0.03	trace.
Copper red	99.90	...	trace.	
Reddish yellow . .	90.00	9.60	0.20	
Violet	8.22	0.50	0.30	trace.
White	2.39	0.56	96.46

The permanent tone is produced by heating. All bronzes contain a small percentage of fat, the *English* more than the *German*. The object of the

fat is to obtain a uniformly low temperature during the superficial oxidation of the bronzes. One-half per cent. of wax or paraffine is, for this reason, frequently added to bronzes.

Bronze for Plaster-of-Paris Figures. The mass used in *France* for this purpose is prepared as follows: Linseed oil is boiled to a soap with soda lye, common salt being added until the soap separates. This soap is then dissolved in rain-water and compounded with a solution of 4 parts of blue and 1 of green vitriol until a precipitate is no longer formed. The soap is washed out and used for preparing the antique green in connection with a varnish prepared from $12\frac{3}{4}$ ounces of litharge and $3\frac{1}{2}$ pounds of linseed oil and wax. Now melt together 1 pound of varnish, $8\frac{3}{4}$ ounces of bronze soap, and $5\frac{1}{4}$ ounces of white wax. Apply this to the figure, previously heated to 190° F., by means of a brush. If necessary place the figure in a heated box until it is thoroughly permeated with the color. The raised parts are rubbed with bronze powder.

Bronze Powders. Melt together in a crucible over a bright fire equal parts of sulphur and the white oxide of tin. Stir them continually with a glass rod until they acquire the appearance of a yellow flaky powder. An iron rod must not be used in stirring any mixture of sulphur when melted, as the sulphur and iron will unite.

Another way to prepare it is to take equal parts of mercury, tin, sulphur, and sal-ammoniac. First melt the tin, then pour the quicksilver into it. When the amalgam thus formed has become cold rub it together with the sulphur and sal-ammoniac. Place the mixture in a crucible and heat until the powder in the crucible becomes gold colored and fumes of mercury cease to arise.

Copper-colored Bronze Powder. This is prepared by dissolving copper in aquafortis until it is saturated and then placing in the solution some small pieces of iron, when the copper will be precipitated in a metallic state. The fluid is then poured off and the impalpable powder carefully washed, dried, and put away for use.

Moiré Metallique. Cleanse sheet iron with diluted sulphuric acid, rinse in

water, and dip it several times in melted tin, covered with melted tallow. Now heat the iron and cool it off quickly in water, and pour over it a mixture of 1 part of nitric acid, 2 of hydrochloric acid, and 3 of water. Then cleanse it with water, dry, and coat it with lacquer. The tinned sheet iron prepared in this manner has the appearance of mother of pearl. [The surface of commercial tin plate may be given this spangled appearance by the use of the same acid liquor. The acid may be applied with the end of a sponge or pad of tow, and followed always by a thorough rinsing in water. The spangled appearance is produced by the solution of the smooth surface of the tin and the exposure of the crystalline structure of the underlying metal. The beauty of the moiré may be enhanced by covering the surface with transparent colored varnish. W.]

Black Bronze for Brass (R. Wagner). Brush the brass with a diluted solution of nitrate of mercury and then several times with a solution of liver of sulphur.

Walker's Chemical Bronze. Boil 1 ounce of ammonium carbonate and a like quantity of blue vitriol in 1½ pints of vinegar until the latter is nearly evaporated. Then add 1½ pints of vinegar in which has been dissolved ½ drachm of oxalic acid and a like quantity of sal-ammoniac. Place the mixture over the fire until it commences to boil, then allow it to cool, filter, and put by in well-closed bottles.

If a medal, etc., is to be bronzed, it is first thoroughly cleansed, then heated, and the liquid applied by means of a badger's hair brush. In a short time boiling water is poured over the medal, and, when dry, it is rubbed with a cotton rag dipped in oil and then with dry cotton.

Blue Bronze. Prepare a sand bath as large as the article to be bronzed. Cleanse the metal from all grease by dipping in boiling potash lye, and treat it with white wine vinegar. Wipe and dry the surface thoroughly and rub it with a linen rag moistened with hydrochloric acid. Allow the coating to dry for a quarter of an hour and then heat the article on the sand bath until it has assumed the desired color, when it should be removed.

Brown Bronze. Observe the same process as in the foregoing. The blue bronze is finally rubbed over with a linen rag saturated with olive oil, which will change the blue color into brown.

Gold Bronze of Great Lustre on Iron. Dissolve 3 ounces of finely-powdered shellac in 1½ pints of spirit of wine. Filter the varnish through linen and rub a sufficient quantity of Dutch gold with the filtrate to give a lustrous color to it.

The iron, previously polished and heated, is brushed over with vinegar and the color applied with a brush. When dry the article may be coated with copal lacquer to which some amber lacquer has been added.

Steel-blue on Brass. Dissolve 1½ drachms of antimony sulphide and 2 ounces of calcined soda in ½ pint of water. Add 2¾ drachms of kermes, filter, and mix this solution with another of 2¾ drachms of tartar, 5½ drachms of sodium hyposulphite, and ¾ pint of water. Polished sheet brass placed in the warm mixture assumes a beautiful steel-blue.

Black on Brass. Dissolve, with constant stirring, 1 ounce of copper carbonate in 8½ fluid ounces of spirit of sal-ammoniac and add 1 pint of water to the solution. Suspend the articles by brass or copper wires in the solution for a short time. It is recommended not to polish the articles with very fine emery paper, as the coating adheres much better if coarser paper has been used. The coating is very durable in the open air.

Red Copper-bronze on White Sheet Tin and Tinned Articles. Dissolve 9 drachms of copper sulphate in rain water until this is saturated; then add 40 to 80 drops of sulphuric acid and brush the tin, previously cleansed with onion juice, with the fluid. When dry rub the article with chalk and rinse with water.

To Give Copper a Durable Lustre. Place the copper articles in a boiling solution of tartar and water for 15 minutes. Remove, rinse off with cold water, and dry.

New Method of Coloring Metals. Metals may be colored quickly and cheaply by forming on their surface a coating of a thin film of a sulphide.

By an immersion of 5 minutes brass articles may be coated with colors varying from gold to copper-red, then to carmine, dark red, and from light blue to a blue-white, and at last a reddish-white, according to the thickness of the coat, which depends on the length of time the metal remains in the solution used. The colors possess a very good lustre, and if the articles to be colored have been previously well cleansed by means of acids and alkalis, they adhere so firmly that they may be operated upon by the burnisher. To prepare the solutions dissolve $1\frac{1}{2}$ ounces of sodium hyposulphite in 1 pint of water and $1\frac{1}{2}$ ounces of acetate of lead previously dissolved in 1 pint of water. When this clear solution is heated to about 190° to 200° F. it decomposes slowly and precipitates sulphide of lead in brown flakes. If metal is present, a part of the sulphide of lead is deposited thereon, and, according to the thickness of the deposit, the above colors are produced. To produce an even coloring the article must be evenly heated.

Iron treated with this solution takes a steel-blue color, zinc a brown color. In the case of copper objects the first gold color does not appear.

If, instead of the acetate of lead, an equal weight of sulphuric acid is added to the sodium hyposulphite, and the process carried on as before, the brass becomes coated, first, with a very beautiful red, which is followed by a green, and changes finally to a splendid brown, with green and red iridescence. This last is a very durable coating and may be especially recommended.

[It will be found very difficult to obtain by this process the precise shade of color desired, unless the operator has had much experience in its use. The thorough cleansing of the articles from grease by immersion in boiling potash lye and rinsing is absolutely necessary to success. W.]

Graham's Bronzing Liquids. These are used by simple immersions and have a wide range of application, as will appear from the three following tables:

I. FOR BRASS (BY SIMPLE IMMERSION).

*No.	Water.	Nitrate of Iron.	Perochloride of Iron.	Nitrate of Copper.	Tersulphide of Arsenic.	Potash solution of Sulphur.	Pearlash solution.	Cyanide of Potassium.	Ferrocyanide of Potassium solution.	Sulphocyanide of Potassium.	Hyposulphite of Soda.	Nitric Acid.	Oxalic Acid.	REMARKS.
	pt.	dr.	dr.	oz.	oz.	dr.	dr.	oz.	pt.	dr.	dr.	dr.	oz.	
1	1	5	Brown, and every shade to black.
2	1	..	5	Brown, and every shade to black.
3	1	16	16	Brown, and every shade to red.
4	1	16	1	..	Brown, and every shade to red.
5	1	1	1	Brownish-red.
6	1	3	..	Brownish-red.
7	1	1	4	..	Dark brown.
8	1	$\frac{1}{4}$..	6	Yellow to red.
9	1	1	Orange.
10	2	..	2	Olive-green.
11	1	..	5	2	Slate.
12	1	20	Blue.
13	1	1	Steel-gray.
14	1	..	4	..	10	Black.

[*Liquid No. 6 must be boiled and cooled. No. 13 must be used at 180° F. or over. No. 6 is slow in action, sometimes taking an hour to give good results. The action of the others is usually immediate. W.]

II. FOR COPPER (BY SIMPLE IMMERSION).

No.	Water.	Nitrate of Iron.	Sulphate of Copper.	Sulphide of Antimony.	Sulphur.	Muriate of Arsenic.	Pearlash.	Sulphocyanide of Potassium.	Hyposulphite of Soda.	Muriatic Acid.	REMARKS.
	pt.	dr.	oz.	dr.	dr.	dr.	oz.	dr.	oz.	dr.	
15	1	5	Brown, and every shade to black. Dark-brown drab.
16	1	5	2	
17	1	..	1	1	2	Dark-brown drab.
18	1	2	1	Bright red.
19	1	1	..	1	Red, and every shade to black.
20	1	1	Steel-gray (at 180° F.)

III. FOR ZINC (AS ABOVE).

No.	Water.	Nitrate of Iron.	Protochloride of Tin.	Sulphate of Copper.	Muriate of Iron.	Muriate of Lead.	Pearlash.	Sulphocyanide of Potassium.	Hyposulphite of Soda.	Gum Arabic Infusion.	Logwood Infusion.	REMARKS.
	pt.	dr.	dr.	dr.	dr.	oz.	oz.	dr.	dr.	
21	1	5	Black.
22	1	..	1	Black.
23	1	..	1	1	Dark gray.
24	2	1	1	*	Dark gray.
25	Dark gray.
26	2	1	Green-gray.
27	*	..	Red (boil).
28	1	4	4	Copper color.
29	1	8	8	Copper color (with agitation).
30	*	Purple (boil).

* Made to the consistency of cream. (W.)

Dead-black on Brass Instruments. Place about a thimbleful of lampblack on a smooth surface of glass or porcelain; drop 4 or 5 drops of gold size on it, and thoroughly incorporate the same with a spatula. It should form a stiff paste. Use as little of the size as possible, as an excess will give the coating a glossy, instead of the desired dead finish. Add about double the volume of turpentine; mix with a camel's hair brush, and apply to the surface to be coated. (W.)

Substitute for Gum Arabic in Manufacturing Bronze Colors. The coarsely-powdered metallic dust used in manu-

facturing bronze colors was formerly rubbed fine with a concentrated solution of gum Arabic. By using a concentrated aqueous solution of 5 parts of dextrine and 1 of alum, instead of solution of gum, a far more beautiful and cheaper article is obtained.

Preservation of Bronze Monuments. The unsightly, dark coating with which most new monuments of bronze become covered, giving them the appearance of cast iron, does not consist, as has been frequently assumed, of sulphide of copper, but of a mixture of soot and atmospheric dust with the oxides of the bronze metals. It is impossible to re-

move this coating by mechanical means, or by diluted sulphuric acid, but it can be done very quickly and efficaciously by washing the surface with a concentrated solution of carbonate of ammonium. By this means a layer of patina is formed, which protects the surface of the monument against a renewal of the formation of the black coating. But as this operation requires skilled and experienced workmen, *Magnus* has devised the following treatment for attaining the same object. The surface of the monument is brushed over, at intervals of a few weeks, with a mixture of 20 parts of acetic acid in 100 of neat-foot oil. The acetate and oleate of copper produced thereby form a thin green layer, which prevents an accumulation of dirt and dust, and also causes the formation of a patina.

BUILDING MATERIALS, ARTIFICIAL BUILDING STONE, MORTARS, ETC.

Various Formulæ for Artificial Stone.

Artificial Building Stone. No. 1. Mix 100 parts of hydraulic lime, which has fallen to a powder, with water to form a paste. To this add 250 parts of gravel and 50 of coal ashes, or lixiviated wood ashes. The mass is then thoroughly mixed, and a sufficient quantity of water added to make the volume of the mass equal to 500 parts. It is then poured into moulds made of pine boards, where it is allowed to remain until set.

No. 2. One hundred and twenty-five parts of hydraulic lime, which has fallen to a powder, are mixed with a sufficient quantity of water to form a paste. To this are added 250 parts of ground oyster shells and 150 of ground peat ashes, and a sufficient quantity of water to make the bulk of the mass equal to 500 parts. It is then poured into moulds as above and dried.

Artificial Building Stone Prepared with Cork. A very light building stone which does not absorb moisture, and does not rot, is prepared according to the following process:

Comminuted cork, or cork waste, is mixed with cement, sand, clay, lime, and solution of water-glass, by adding

sufficient water to form a plastic mass, which is pressed in moulds and dried in the air.

The most advantageous plan is to combine the comminuted cork with a mixture of clay, lime, solution of water-glass, and a small quantity of hair.

The addition of clay is necessary to prevent the calcium carbonate which is formed from becoming detached from the surface of the comminuted cork wood. The water glass is added in order to form calcium silicate, which contributes to the solidity of the stone. The hair is added to keep the formed stones together while drying.

Artificial Stone from Quartz Sand and Plumbic Oxide. Ground quartz sand is mixed with 2 to 10 per cent. of finely-ground plumbic oxide. The harder the stones are to be the more plumbic oxide must be used. The mixture is moistened with water-glass, again thoroughly mixed, and then pressed firmly into moulds. The resulting stone is dried and then burned.

E. Schaffèr's Artificial Stone (Elizabeth, N. J.). A mixture of 1 part of cement and 3 of sand is made into a dough with diluted sulphuric acid (100 parts of water to 2 of the acid) and subjected to a strong pressure. The stones are then dried in the air for 2 days, when they are again placed for 12 hours in diluted sulphuric acid (100 parts of water to 3 of acid), and finally dried.

E. Westermeyer's Artificial Stone (Chicago). Two parts of Portland cement, 1 of sand, and 1 of cinders are mixed together dry and then moistened with an aqueous solution of sulphate of iron. The resulting mortar is pressed in moulds, dried for 2 weeks in a warm place, then placed for 24 hours in water, and finally dried for 4 weeks.

F. Coignet's (Paris). Ten parts of unslaked lime are carefully ground with 3 to 4 parts of water and then mixed with 40 to 60 parts of dry sand and 2½ to 10 parts of hydraulic cement. The mixture is again ground and pressed into moulds.

A. Quesnot's (Bloomington, Ill.). Dissolve 1 part of alum in 15 parts of water, and add 2 parts of hydraulic lime, 10 of sand, and 1 of cement to the required consistency; press into moulds

and allow to remain 24 hours. The blocks are fit for use in 14 days, but only become thoroughly hard after longer drying.

J. Shellinger, of New York, mixes 4 parts of coarse sand, 1 of cement, with gravel, pebbles, etc., in lime-water to a paste, which is pressed in moulds and the surface covered with a composition of 2 parts of fine sand, 1 of cement, and 1 of dry metallic coloring matter. If the surface of the stone is to be ornamented the design is laid upon the bottom of the mould, and on the top of this is placed the layer of the last-mentioned mixture. When the stone is nearly dry its surface is brushed over with a thin solution of water-glass. Sidewalks of such flags have been laid in several streets of New York, and found to do excellent service.

J. Ordway, of Jamaica Plains, N. Y. Thirty parts of quartz sand and 1 of plumbic oxide are mixed to a dough with 10 of water-glass. Suitable coloring substances, if necessary, are added to the mass, which is then pressed into moulds and exposed for 2 hours to a red heat.

S. Sorel, of Paris. Natural carbonate of magnesia is heated in a furnace to a red heat for 24 hours; it is then powdered, mixed with sand, gravel, marble waste, etc., or with cotton, wool, and other fibrous substances, in the proportion of $\frac{1}{2}$ to 20 and more to 1, according to the results to be obtained. The mass is moistened with solution of chloride of magnesium, pressed into moulds, or worked and rolled into slabs.

Adolph Ott, New York. A mixture of hydraulic cement with lime, soluble siliceous earth, or water-glass is stirred into a stiff dough with a mixture of hydraulic cement and heated dolomite. The mass is pressed into moulds and dried without the use of heat. The dolomite should only be heated to about 750° F., to prevent the carbonate of lime from losing its carbonic acid, and then powdered. Stones manufactured in this manner resemble the Portland stones, and, it is claimed, are harder.

"*Victoria*" Stone (Highton's Process). The refuse of the granite quarries is broken up into pieces of suitable size,

and 4 parts of the fragments thus obtained are mixed with 1 part of Portland cement, with the addition of sufficient water to bring the mass to the consistency of dough. The mass is run into moulds, in which it is allowed to remain for several days, or until it has set solid. The blocks are then immersed in a solution of silicate of soda. (W.)

Ransome's Artificial Stone. Clean and dry sand and other suitable siliceous and earthy ingredients are thoroughly incorporated in a mixing mill with silicate of soda. The resulting pasty mass is then pressed into moulds of any required pattern or size, and when set sufficiently, immersed in a solution of chloride of calcium. In the case of large pieces the saturation with chloride of calcium is facilitated by the use of the air-pump. The resulting reaction is the formation, by double decomposition of the ingredients, of an insoluble calcium silicate and of sodium chloride. The first named forms a solid and indurate binding material for the stone, and the sodium chloride is removed by a subsequent thorough washing with water. This last operation is important, since if not completely removed from the stone it will make its appearance subsequently in the form of a white efflorescence on its surface. (W.)

Apenite (Ransome's Patent). To avoid the difficulty encountered in washing out the soluble sodium chloride in the process just described, Mr. Ransome devised a process whereby the insoluble calcium silicate should be formed without the simultaneous production of a soluble salt—thus dispensing with the washing process. This he accomplishes by incorporating with the foregoing mixture a material capable of yielding silica in form susceptible of dissolving freely in the presence of free alkali. Such a material is found in the earth known variously as infusorial earth, diatomaceous earth, fossil meal, etc., and which is made up largely of the siliceous coverings of microscopic plants which are readily soluble in caustic soda or potassa.

Mr. Ransome introduces some of this earth into his mixture of lime, sand, and silicate of soda solution. When

intimately mixed, the mass is introduced into moulds and allowed to harden gradually. Calcium silicate is formed by the interaction of the ingredients present, and the mass gradually becomes indurated, forming a compact stone, which improves in strength and hardness as it ages. The action of the siliceous earth introduced is as follows: The free lime and alumina of the mixture seize on the silica of the sodium silicate, forming calcium and aluminum silicate and free soda. This last reacts promptly on the silica of the infusorial earth to form a fresh portion of sodium silicate, and so on, the soda acting as the carrier of silica to the lime, until it is all combined. A portion of the soda appears also to combine at each operation, so that this is gradually united with the lime as a double silicate, leaving nothing to be removed by washing. (W.)

Frear's Artificial Stone. A mixture of Portland cement and sand is moistened with a solution of shellac, then reduced to the consistency of dough by the addition of water, and formed by pressure into moulds of any desired shape. After a short time the mass acquires considerable tenacity, and may be removed from the moulds without injury. The "Frear" stone was at one time quite largely used in Chicago and other cities of the West and Northwest. (W.)

Building Stones, Pipes, etc.

Sand	4000 parts.
Limestone	528 "
Burned clay (brickdust)	60 "
Water-glass	130 to 250 "

are mixed together.

Artificial Millstones.

Coarsely-broken quartz or flint	4000 parts.
Chalk or limestone	500 "
Calcium phosphate	45 "
Feldspar	60 "
Fluorspar	10 "
Water-glass	250 "

Grindstones.

Quartz sand or emery	235 parts.
Limestone	75 "
Calamine	30 "
Calcium phosphate	30 "
Feldspar	4 "
Fluorspar	1 part.
Water-glass	75 parts.

are mixed and the mass treated in the

same manner as indicated for artificial marble.

New Plastic Water-proof Grindstones. Melt 100 parts of caoutchouc and add to this 25 parts of sulphur mixed with 450 to 1050 parts of emery or some other abrading substance. Knead the mass thoroughly, press it into moulds, and subject it first in the moulds, and then after it has been taken out, to a temperature of 572° F.

To Imitate Variegated Marble. Mix hydraulic lime and ground marble, and incorporate with the mixture a solution of alum and suitable coloring substances. Differently colored masses are then mixed together and cut into slabs.

A. Garvey, of Memphis, Tenn., prepares "lithomarlite" by adding to 3 gallons of water, ½ pint of glue water, and 4½ ounces of powdered borax, a sufficient quantity of plaster of Paris to form a dough. An imitation of marble is produced by stirring the coloring substances into the mass.

Artificial Marble. The following mixtures have been recommended for making artificial marble. Grind and thoroughly mix:

	PARTS.	
Comminuted stone	280	280
Limestone or chalk	140	140
Burned calamine	5	6
Calcined feldspar	3	3
Fluorspar	2	1.5
Calcium phosphate	2	
Water-glass	40	40

On the addition of the water-glass the ingredients are quickly mixed and thereupon pressed into moulds. The finished pieces are dried at a temperature gradually rising to 125° F.

Cement from Blast-furnace Slag. Mr. Ransome has lately wrought out an important invention by which he is enabled to convert blast-furnace slag into a hydraulic cement having even greater strength than Portland, and besides being much lighter in color.

In this process granulated slag is mixed and ground with chalk or lime, or, in his latest practice, with the spent lime of the gas works. The resulting mixture is then calcined and again ground. The resulting cement is found to possess high qualities both as regards quick setting and strength.

When spent gas lime is used; Mr.

Reasome gets rid of the sulphur with which it is saturated by mixing a certain proportion of powdered coke with the slag and lime, which, in the furnace, reduces the sulphate of lime present to sulphide, and passing a jet of steam through the mass, by which the sulphur is carried off as sulphuretted hydrogen, leaving pure lime behind. He has also devised a revolving retort for the calcination of his materials, by which they are prevented from caking, and a subsequent grinding rendered unnecessary. This cement exhibited considerably greater strength than Portland. (W.)

Very Hard and Durable Cement. The following mixtures give three qualities of a very hard and durable cement capable of resisting the action of the weather. It is very suitable for cementing fractures in marble or stone statues, monuments, or ornamental work which are exposed to atmospheric influences:

	PARTS.		
	I.	II.	III.
Portland cement	12	6	9
Chalk paste	6	12	6
Fine sand	6	6	6
Siliceous earth	1	1	1

The above ingredients are made into a thick paste with soda water-glass. No. II. gives the hardest cement.

To Manufacture Cement from Blast-furnace Slag.

Blast-furnace slag	2 parts.
Lime	5 "
Clay	2 "

are mixed, calcined, and ground.

To Prepare White Cement, which hardens under water, stir 25 parts of fossil meal (infusorial earth), free from iron, and 75 of chalk, free from iron, into a solution of 2.5 parts of potash or soda, and form the mass into bricks, which are dried, burned in a white heat, and then ground.

To Prepare Artificial Cement. Schöttler's artificial cement consists of:

Plaster of Paris (best freshly ground)	6 parts by weight.
Brickdust	3 "
Finery cinders	4 "

The substances are ground or

pounded fine, then sifted through a wire sieve (so fine as not to allow mustard seed to pass through), mixed with water, and, shortly before the cement is to be used, mixed thoroughly with 2 parts of sifted iron filings. The mixture should be used as thin and soft as possible—in all other respects like ordinary mortar.

To Harden Cement, Lime, and Similar Materials. Solutions of sulphate of zinc, sulphate of iron, or sulphate of copper are used for this purpose. The plastering of cement or lime mortar may be brushed over with these solutions or the mortar mixtures may be stirred together with them. In the latter case the percentage of lime or cement in the mortar can be considerably decreased.

Oil Cement Paint for Felt Roofing.

Washed graphite	2 parts by weight.
Red ochre	2 " "
Cement	16 " "
Barium sulphate	16 " "
Plumbic oxide	6 " "

are ground in an oil varnish prepared in the following manner: One hundred parts by weight of good linseed oil are boiled for 8 hours in a copper boiler with 5 per cent. of pyrolusite. Ten parts by weight of flowers of sulphur and 20 parts by weight of French pitch are then dissolved in the mixture and the mass filtered before it becomes cold. Twenty-five pounds of oil cement color and 1½ gallons of linseed-oil varnish or linseed oil for reducing the paint are sufficient to give 2 coats to 1000 square feet of roof surface. The first coat, while still wet, is uniformly covered with fine dry sand by means of a sieve. The sanding should be done during the progress of the painting, so that the workman is not obliged to step into the wet paint. The free sand is removed with a broom before the second coat is given, and it is best to apply this 8 days after the first. The second coat need not be sanded; its purpose being to combine with the first to an insoluble mass hard as stone and to give to the roof a neat, finished appearance.

Requisites for Good Mortar. To obtain a good mortar as much depends on the character of the ingredients and the manner of mixing them as on the qual-

ity of the lime. It does not necessarily follow that because a lime is good the quality of the mortar will be good also. The best lime ever burned would be spoiled by the custom, common among some builders, of mixing with it earth and rubbish taken from the foundations of intended buildings. The sand should be hard, sharp, gritty, and, for purposes of construction, not too fine; it should be free from all organic matter. Good sand for mortar may be rubbed between the hands without soiling them. The water should also be free from organic matter, and, on this account, should never be taken from stagnant ponds. The presence of salt in sand and water is not found to impair the ultimate strength of most mortars; nevertheless it causes an efflorescence of white, frothy blotches on the face of the structure. It also renders the mortar liable to retain moisture, and for these reasons should never be present in mortar intended for architectural purposes, although for dock and sea walls it may generally be used with advantage and economy.

Sand is used to increase the resistance of mortar to crushing, to lessen the amount of shrinking, and to reduce the bulk of the more costly material, lime. Water is the agent by which a combination is effected, and, as sand does not increase in volume by moisture, it necessarily follows that no more of the diluting element should be employed than is absolutely necessary to fill the interstices between the sand and render the whole into a paste convenient for use, and the greater strictness with which this is adhered to the more compact and durable will be the mortar.

Hydraulic Mortar from Lime and Alum Shale. Alum shale, which is very abundant and cheap in some localities, mixed with lime, gives to the latter all the properties of hydraulic mortar. It dries quickly, becomes very hard and impermeable. To prepare it add $\frac{1}{3}$ to $\frac{1}{2}$ part of alum shale to the lime.

To Prepare Bitumen Mortar. One part of bitumen, gained as a by-product in the manufacture of paraffine oil and mineral oil, and thoroughly cleansed by means of acids and alkalies, is mixed with 2 to 6 parts of lime mortar. The latter is prepared from 1

part of good slaked lime and 2 parts of sharp quartz sand. After it is mixed and has become hard it is brought into the bitumen, which has been previously melted and heated to 140° F.

To Prepare Hydraulic Mortar. Burned lime is changed into dry calcium hydrate as fine as dust by moistening it with water and allowing it to decompose. It is then mixed with infusorial earth, which has also been reduced to an impalpable powder by washing, drying, gentle heating, and pulverizing the lumps which may have been formed. For mortar to be used for work under water, equal parts by weight of the two powders are mixed together; while for work not so much exposed to the action of water, 1 part by weight of infusorial earth to 2 parts by weight of calcium hydrate is sufficient.

Water-proof Mortar. The lime is slaked with a solution of green vitriol instead of ordinary water. The necessary quantity of green vitriol is dissolved in warm water, the lime slaked in the usual manner, and then mixed with fine quartz sand.

To Prepare Clay Plaster. Stir gradually 1 part of rye flour into 26 parts of water. Boil and the mixture will give 24 parts of paste. Take 1 part of this to 8 parts of dry clay, and mix with as much water as necessary to apply it.

Plaster for Damp Walls. Two coats of ordinary lime mortar are applied to the wall. The last coat is smoothed with a steel float. Upon this is applied a third coat of very fat lime, and this is glazed with pure lime compounded with some alumina and $\frac{1}{6}$ part of alum.

Treatment of Asphaltum for Paving Purposes. The asphaltum should not be softened by heat, but, in a powdered state, partly dissolved by impregnating it with bisulphide of carbon, naphtha, or benzine.

Marbleizing Sandstone. By impregnating sandstone with a solution of sulphate of alumina and next with one of water-glass, it acquires a marble-like appearance and can be polished. It resists the action of fire and atmospheric influences and is especially adapted for hydraulic works. By treating the impregnated sandstone at a very high tem-

perature it acquires a kind of vitrification, to which any desired color can be given.

To Make Sandstone and other Porous Stones Tough and Impermeable. The stones are dried at 350° F. and then immersed for 8 hours in coal tar heated to 350° F. Stones treated in this manner become so tough that they can scarcely be broken with a hammer. Bricks become hard and impermeable by allowing them to lie for 4 hours in tar heated to 235° F.

To Repair Worn-down Sandstone Steps. This can be very well accomplished with good cement mortar. The steps are first thoroughly moistened with water before applying the mortar, consisting of 1 part of cement and 1 of fine quartz sand. The cement and sand must be mixed dry, some water is then gradually added, while the mass is constantly stirred, so that the result will be as plastic a mortar as possible, in which every grain of sand is enveloped in a coating of cement.

For repairing broken sandstone steps, the fracture should first be cut as ragged as possible and soaked with water. Finely-sifted cement and sand should be used, or, instead of the latter, finely-powdered and washed sandstone as near the color of the steps as possible. The mortar is prepared from 1 part of cement and 2 of sand.

Concrete Marble. Mix milk of lime with finely-powdered marble or limestone, or, what is still better, with chalk, until the mixture acquires the consistency of paste. A certain quantity of coarsely-powdered limestone may be added to the mixture to give it more cohesion. The mortar should be applied at once, as it dries very quickly and becomes hard.

To Make Wood Almost Incombustible. Well-seasoned wood is steeped for 24 hours in a solution of water-glass in three times its volume of water. It is then dried in the air for a few days, and the soaking for 24 hours in the same solution and drying repeated several times. It is finally thoroughly dried and given a coat of a mixture of 1 part of fresh cement and 4 parts of the above solution of water-glass. Not too much of this last mixture must be prepared at one time, as it would become solid

and therefore useless. The first coat is allowed to dry for 24 hours. The wood receives then a second but somewhat thicker coat of cement and water-glass, and, when dry, a final coat of ordinary water-glass, which gives a smooth, glassy appearance to it. Wood treated in the above manner will not ignite even in a strong fire, as has been proved by experiments on a large scale. This treatment protects it also against the attacks of insects and rotting.

To Dry Damp Walls. The old plaster is first removed from the walls and the joints. Slabs consisting of:

Rosin	3 parts.
Tar	2 "
Asphaltum	5 "
Quartz sand	6 "

are then prepared. The smooth surfaces of these slabs are coated with a lacquer consisting of:

Oil of turpentine	2 parts.
Shellac	1 part.
Spirit of wine	4 parts.

and then strewed with sharp sand, while the rough surface of the plates is fastened to the wall with a mortar consisting of:

Sand	4 parts.
Hydraulic lime	2 "
Portland cement	1 part.

The joints are filled in with a putty, consisting of:

Rosin	6 parts.
Asphaltum	1 part.
Powdered lime	2 parts.

They receive then a coat of the above-mentioned varnish and are also strewn with sharp sand. The wall is then plastered.

Lyons Asphaltum.

Bitumen	15 parts by weight.
Coal cinders	35 "
Powdered coke	10 "
Lime	130 "
Fine gravel	160 "

The bitumen and coal cinders are mixed in a boiler, heated, and skimmed until the formation of froth has ceased. The powdered coke and lime are then intimately mixed and heated to 575°

F. in order to dry them, when they are mixed with the ingredients in the boiler, and finally the gravel is added.

To Make Glass Roofs Water-tight. It is very difficult to keep glass roofs with iron frames water-tight, as the iron contracts by cold and expands by heat more than the glass. To remedy this it is necessary to use an elastic putty which will follow the variations in the iron. This is prepared in the following manner: Two parts of rosin and 1 of tallow are melted together and intimately mixed with some red lead. This putty, while hot, is spread upon both sides of strips of linen or cotton cloth, and these, while the putty is still warm, are pasted, one-half upon the iron riles and the other upon the glass. The strips should be about $\frac{1}{2}$ inch wide.

To Preserve Wood. The following is a new process to protect wood from rotting: Boil in an iron boiler 4 to 8 parts of linseed oil with 50 parts of rosin, 40 parts of pulverized chalk (whiting), and 2000 to 3000 parts of sharp white sand. When the paste is thoroughly boiled add 1 part of cuprous oxide and finally 1 part of sulphuric acid. The mass is then thoroughly stirred together and applied, while hot, to the wood with a stiff brush. If the mass is too thick it should be thinned with linseed oil.

Bricks (Size and Weight). Trautwine gives the usual size of bricks in Eastern cities as $8\frac{1}{2}$ by $4\frac{1}{2}$ inches, equivalent to 66 cubic inches, or 26.2 bricks to the cubic foot, or 707 to the cubic yard.

The weight of a good common brick of the above dimensions will average about $4\frac{1}{2}$ pounds, or 118 pounds to the cubic foot, or 3186 pounds (nearly $1\frac{1}{2}$ tons) to the cubic yard.

A good pressed brick of the same size will average about 5 pounds, or 131 pounds to the cubic foot, or 3537 pounds (somewhat over $1\frac{1}{2}$ tons) to the cubic yard. (W.)

Making Brick Masonry Impervious to Water. Sylvester's process, used with success on the Croton Reservoir in Central Park, consists in the successive application to the walls of two washes, one composed of Castile soap and water and the other of alum and water. The

proportions are $\frac{2}{3}$ of a pound of soap to 1 gallon of water, and $\frac{1}{2}$ pound of alum to 4 gallons of water. The walls should be quite dry and clean and the temperature of the air should not be below 50° F. The soap wash should be laid on first: it should be laid on with a flat brush and at a boiling heat. After 24 hours the wash will be dry and hard, and the alum wash should be applied at a temperature of 60° to 70° F. This is allowed to remain for 24 hours, when the whole operation is repeated until the wall has become impervious to water. The number of applications required will depend on the water pressure to which the wall will be subjected. In the case of the Croton Reservoir above named 4 coatings were found to render the reservoir free from leakage under 40 feet head. (W.)

COCOA AND CHOCOLATE.

Cocoa and chocolate are prepared from the cocoa bean. This is characterized by the presence of more than half of its weight of a fatty substance, known as cocoa butter, consisting of oleine and stearine, and does not become rancid like the natural fats generally.

The beans, carefully cleansed and selected, partly by sifting, and partly by picking out the injured and unripe ones, are allowed to ferment in heaps for a short time (which improves their flavor), and then roasted like coffee. The drums used for this purpose should be of such a size that about 450 pounds of the seeds will fill them about $\frac{3}{4}$ full. Inside of the drum are 4 blades, the object of which is to stir and mix the seeds while roasting. The beans should be roasted not quite as much as coffee; they must not have an empyreumatic odor, but a peculiar, agreeable aroma. The roasted beans having been crushed and winnowed, are ground in warm mills, in which the fatty matter melts and unites with the ground beans to a paste. The mill for grinding (Fig. 4) consists of 3 large granite rollers, A, B, C, the surfaces of which must be smooth. The centre roller B runs in brasses, while A and C rest upon the blocks r , r , and r' , r' . Each of these can be uni-

formly pushed forward upon the iron rails *x x* by the action of an endless

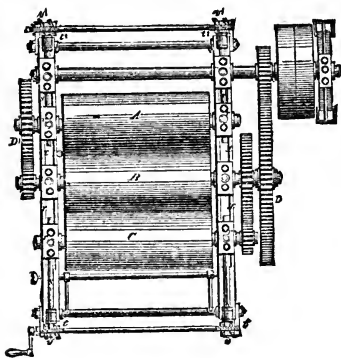

Fig. 4.

screw *v, v'*, and thus are brought nearer to, or removed from, the centre roller B. The rollers are geared to turn at different speeds. The centre roller B generally makes 2 revolutions, while C makes 6, and A 1. The effect of this is that every roller grinds upon the surface lying behind it, and that the cocoa between the first pair is transferred from one roller to the other. The paste is scraped from the roller C by a blade of hardened steel, and conveyed into a tin mould placed under the machine. To keep the fatty matter in a melted state, a copper box, into which steam is introduced, is placed under the rollers. When the machine has worked for some time, sufficient heat is generated by friction to allow of the steam being shut off.

For the manufacture of chocolate 3 machines are required: The mixing boiler, roller, and moulding tables. The mixing boiler consists of a round trough of granite provided with a mixing apparatus. The cocoa is intimately mixed with a corresponding quantity of sugar and other ingredients, the warm, soft mixture divided into lumps of a determined weight, and placed in tin moulds upon a shaking table. The soft mass, by this motion, spreads out uniformly in the moulds, and the air bubbles enclosed in it escape. The

chocolate in cooling off contracts and detaches itself from the sides of the mould. Good chocolate forms a brown homogeneous mass of great density. The surface of the cake should have a dull lustre, and, when broken, the fracture, in cool weather, must be sharp and show no lustrous or white granules.

Starch, either 2 to 3 per cent. of arrow-root or other starch, or 4 to 6 per cent. of kiln-dried wheat or barley flour is added to almost every kind of chocolate. (This adulterant is frequently added in much larger proportion. W.) Vanilla, spices, and other flavoring substances are also added.

We give in the following a number of receipts for manufacturing different varieties and qualities of chocolate:

Ordinary Chocolate. I. Mix 2 pounds each of roasted and ground cocoa and pulverized sugar, and $\frac{1}{2}$ ounce of powdered cinnamon.

II. Mix $6\frac{1}{2}$ pounds of roasted and ground cocoa, a like quantity of sugar, 1 ounce of powdered cinnamon, a like quantity of rice roasted light brown, $\frac{1}{2}$ ounce of cardamons, and $\frac{1}{4}$ ounce of cubebs.

Spiced Chocolate. Twelve hundred and fifty parts of roasted cocoa and a like quantity of sugar.

The cocoa is ground very fine, at a moderate heat, until it forms a thin paste. It is then mixed with the sugar and the following ingredients, all finely powdered:

Fine cinnamon	18 parts.
Cloves	9 "
Cardamon	4 "

The mass is then pressed in moulds.

Other Receipts for Spiced Chocolate.

	PARTS.		
	I.	II.	III.
Roasted cocoa	2000	5000	5000
Sugar	1750	5000	5000
Ceylon cinnamon	50	166 $\frac{1}{2}$	200
Cloves	1 $\frac{1}{2}$	83	66 $\frac{1}{2}$
Vanilla ground with sugar	50		
Cardamon	11 $\frac{1}{3}$	16 $\frac{1}{2}$	
Mace	1 $\frac{1}{2}$		8
Coriander		8	
Sugar ground with		133	
Oil of lemon		1 $\frac{1}{2}$	

Fine Spanish Spiced Chocolate.

Cocoa	1500	parts.
Fine white sugar	1500	"
Ground vanilla	16½	"
Cloves	16½	"
Cardamon	33	"
Cinnamon	50	"
Mace	16	"
Cedrat oil	30	drops

Vienna Chocolate. Mix :

	PARTS.	
	I.	II.
Cocoa mass	5000	1500
Powdered sugar	5000	750
Powdered cinnamon	200	
Powdered cloves	100	
Powdered cardamon	25	
Peruvian balsam ground with sugar	25	
Vanilla		25
Ambergris		½

Paris Chocolate. Milan Chocolate.

Cocoa mass	1000 parts.	1500 parts.
Sugar	1000 "	1500 "
Vanilla	33 "	16 "
Ambergris	1 part.	
Peruvian bal- sam		1½ "
Fine cinna- mon		33 "

Hygienic Chocolate. This consists either of cocoa formed into cakes, or equal quantities of cocoa and white sugar, or 1 part cocoa to 1½ parts sugar, but contains no spices whatever.

Iceland Moss Chocolate consists of:

Cocoa	250 parts.
Sugar	250 "
Finely-powdered Iceland moss	125 "
Finely-powdered salep	10 "

Other Receipts for Iceland Moss Chocolate. One quart of hot water in which ½ ounce of potash has been dissolved is poured over 5½ ounces of selected Iceland moss. This is allowed to stand quietly for 1 hour; the fluid is then strained off through a cloth, the moss squeezed out with the hands, and thoroughly washed 3 or 4 times with fresh water. It is again squeezed, dried in a warm place, powdered, and sifted. Four and three-quarter ounces of this powder are mixed with ½ ounce of powdered salep root and 1½ pounds of powdered sugar. One and one-half pounds of cocoa mass are added and the whole thoroughly mixed.

Doliar's Moss Chocolate.

Roasted and finely-ground cocoa	1	pound.
Finely-powdered white sugar	13½	ounces.
Dried and finely-powdered moss	½	ounce.
Powdered salep root	¼	"

Chocolate with Meat Extract. One-half ounce of meat extract is dissolved in the same quantity of lukewarm distilled water and mixed, while still warm, with 8½ ounces of cocoa. The ingredients must be very intimately mixed. The mass is then formed into cakes like ordinary chocolate.

Iron Chocolate. Mix :

Chocolate	1000	parts.
Cloves	5	"
Cardamon	2½	"
Ethereal oil of cinnamon	1	part.
Peruvian balsam	2	parts.
Iron in an impalpable powder	10	"

Chocolate with Carbonate of Iron. Mix :

Chocolate	1000 parts.
Carbonate of iron	10 "
Vanilla	4 "

Chocolate Lozenges with Carbonate of Iron. Five ounces of pure crystallized ferrous sulphate, or, what is still better, freshly precipitated with alcohol, are dried at a moderate heat until the residue weighs 4½ ounces. Add to this 4½ ounces of dried and powdered sodium bicarbonate and 4 ounces of powdered sugar. Four ounces of cocoa, melted at a moderate temperature, are then gradually incorporated with the mixture and 60 lozenges formed from the resulting mass.

Racahout des Arabes. Mix :

	PARTS.	
	I.	II.
Fine oatmeal	500	
Powdered chocolate	500	500
Powdered vanilla sugar	125	
Powdered starch		250
Fine wheat flour		250
Powdered sugar		125
Powdered cinnamon		⅙ to ⅙

Dr. Koeben's Nourishing and Healing Powder.

	PARTS.	
	I.	II.
White Sugar	65	Chocolate 60
Prepared cocoa	30	Sugar 35
Finest flour	25	Finest flour 25
Roasted acorns	10	Roasted acorns 10

Vakaka Indorum. This consists of:

Roasted cocoa	117	parts.
Sugar	320	"
Cinnamon	14	"
Vanilla	3.5	"
Gray anbergris	$\frac{1}{10}$	part.
Musk	$\frac{1}{10}$	"

Palamaud or Palmgrène, or Allataim du Harem. This consists of:

Roasted cocoa	8	parts.
Finest starch	32	"
Rice	32	"
Powdered red sandal wood	1	part.

According to other formulæ ground acorns are substituted for starch.

White Chocolate. The following mixture is kneaded into a dough by adding a sufficient quantity of boiling water. The resulting paste is then formed into small cakes or lozenges:

White sugar	3 $\frac{1}{2}$	pounds.
Powdered rice	1 $\frac{1}{2}$	"
Arrowroot	5 $\frac{3}{4}$	ounces.
Tincture of vanilla	5 $\frac{3}{4}$	drachms.
Cocoa butter	5 $\frac{3}{4}$	ounces.
Gum Arabic	2 $\frac{3}{4}$	"

CELLULOID, CAOUTCHOUC, GUTTA-PERCHA, AND SIMILAR COMPOSITIONS.

Preparation of Celluloid. Any substance containing cellulose, or vegetable fibre free from incrusting components, as unsized paper, cotton, wool, linen, hemp, white rags cut fine and perfectly clean, certain varieties of white wood, may be used as material in the manufacture of celluloid. They are dried at 212° F., ground up, and stored in a place free from moisture. Three vessels of glass, or any other material not liable to be attacked by acids, are required for converting the cellulose into pyroxyline. The cellulose is first soaked in one of the vessels for 10 to 15 minutes in acid; it is then pressed out, transferred to the second vessel containing fresh acid, consisting of a mixture of 3 parts of sulphuric acid of 1.834 specific gravity and 2 of concentrated commercial nitric acid. The acids in the first and second vessels may be used in subsequent operations by raising the temperature to about 86° to 95° F., and keeping the material in the bath for a

few hours. When the conversion is complete, the pyroxyline is pressed out and freed from adhering acid by washing it in the third vessel. It is again pressed out and further washed in tanks resting on an inclined plane and fed with running water. To convert the pyroxyline into celluloid, 42 to 50 parts of camphor are intimately mixed with 100 of pyroxyline, wrapped in a strong tissue capable of great resistance, then enclosed in bags made of horse-hair cloth, and placed between the plates of a warm press, and subjected to pressure for 1 hour or longer. The cakes remaining in the bags can then be brought into a heated cylinder press, and next into an apparatus in which a vacuum prevails, while the cylinder jacket contains such substances as chloride of calcium, concentrated sulphuric acid, etc., for the absorption of moisture. Resinous or other substances and coloring matter may be incorporated with this product, to obtain uniformly colored or marbled masses. Celluloid made by this and similar processes becomes plastic when heated, and may be cast. The celluloid is made incombustible by washing the pyroxyline in a solution of silicate of soda, and incorporating with it phosphate of ammonia or soda, borate of lead, or fluxes used in porcelain and glass painting.

G. Magnus & Co., of Berlin, dissolve 50 parts of gun-cotton in a mixture of 100 parts of ether and 25 of camphor, and evaporate the solvent from the resulting transparent, jelly-like mass until it is plastic. It is then exposed in thin plates to the air until it is hard and capable of taking a polish. Billiard balls, etc., are prepared by rolling several plates together, and rasping the new-formed plate into a coarse powder. This is dried at 222.8° F., pressed in metallic moulds, and heated for 1½ or, at the utmost, 1¾ hours at 248° F.

Treatment of Pyroxyline in the Manufacture of Plastic Masses. Pyroxyline is prepared by saturating some form of cellulose, linen, cotton, starch, dextrine, etc., in a mixture of nitric and sulphuric acids.

After a sufficient soaking the acid is drawn off, the material thoroughly washed and allowed to dry for 12 to 24 hours. The resulting product, while

still moist, is treated with a solvent, as methyl alcohol, ethyl alcohol, sulphuric ether, etc., to which gum, balsam, resins, coloring matter, etc., have been added. The solvent may be used in the proportion of $\frac{1}{2}$ gallon to $2\frac{1}{2}$ pounds of pyroxyline, but may vary according to circumstances. The proportion of gums and pigments depends on the color, tenacity, and degree of hardness desired. The mass is now heated in a suitable vessel from 150° to 220° F., whereby it becomes plastic; it is then ground, thoroughly mixed, and dried at a temperature not exceeding 150° F., when it is brought, while still plastic, into the desired moulds.

How to Work and Treat Celluloid.

Celluloid is worked and treated in the same manner as all other horn-like substances. The same instruments may be used for turning, boring, and planing it. By heating it to 165° F. it becomes sufficiently plastic to assume all desired forms by pressing. It is necessary to heat the mould, which should be of brass, before pressing, and the article of celluloid should be cooled off in the mould by means of cold water. If the heat is raised above 165° F. the material should remain in the mould only a few minutes. For polishing, it is best to use very fine pumice stone and powdered emery mixed in equal parts, and kneaded into a dough with hot soap, which must be free from rosin. The mixture is then dried and spread upon the polishing instrument. To cement celluloid upon wood, leather, etc., a solution of 1 part of shellac in 1 part of spirit of camphor and 3 to 4 parts of alcohol 90 per cent. strong is required. The best cement is pure, very finely-scraped celluloid dissolved in spirit of wine 90 per cent. strong. When the material is cut with iron instruments, moving quickly to and fro, creating considerable heat, it is recommended to allow water to trickle upon the cutting or sawing tool. When articles are to be punched or pressed from the material, it should be heated in lukewarm water to 100° F., as this will prevent it from tearing and splintering. In case it has become brittle, it is dipped into spirit of camphor, but must not remain in it too long. Finished articles should not be kept in air-tight

boxes, since these will prevent the evaporation of the camphor.

New Celluloid. Pared potatoes are treated for 36 hours with a mixture of 8 parts of sulphuric acid and 100 parts of water. The mass is then washed and dried between sheets of blotting-paper and pressed. Tobacco pipes, closely resembling meerschaum, are manufactured from this mass in France, and it is claimed that a strong pressure imparts sufficient hardness to it so that it can be used as a substitute for ivory and for the manufacture of billiard balls, etc. By using sodium hydrate 3 per cent. strong instead of sulphuric acid, the mass becomes more elastic, but acquires a dirty white color. By using soda lye 19 per cent. strong a horn-like mass is obtained which can be worked in the same manner as horn. The action is far more energetic if white turnips are treated in the same manner. To obtain a mass closely resembling buck's horn, the turnip is bored through in the centre of the conical end, but the upper, larger end is left uninjured. It is then stuck upon a stick, dipped in hot tallow, and placed near a warm stove, when, in a few days, it will assume a form closely resembling a buck's-horn handle, which requires only to be colored by coating it with Paris polishing lacquer. A variety of articles can be manufactured in the same manner. The mass is principally used for veneering. It can be colored in any manner desired, and by moistening with diluted glycerine water it becomes as pliable as leather and well suited for coating various articles. By using yellow turnips instead of white, forms resembling buck's horn, but of the color of coral, are obtained. They are used for knife, umbrella, and whip-handles, and walking-sticks. This substance has been called coral celluloid, or corallin.

Manufacture of Rubber Stamps.

For this a vulcanizing apparatus with lamp and thermometer, as used by dentists, is required, and an iron chase, in which the types are firmly held. The types are oiled in the usual manner, and the vulcanite poured over them. The matrix is not allowed to become dry, but a plate of vulcanized caoutchouc is laid upon it. The caoutchouc is forced into the matrix by

pressing between two iron plates; a few sheets of paper being placed between them to prevent the caoutchouc from sticking to the matrix. The whole is then placed in the water of the vulcanizing apparatus, and heated to 305° F. After it has become cold the mould is taken out and the caoutchouc detached.

To Soften Rubber Hose after it has become Hard. Dip the hose in petroleum, and hang it up for 2 days to allow the oil to drip off, and repeat the operation once or twice.

Metallized Caoutchouc. Mix non-vulcanized caoutchouc with powdered lead, zinc, or antimony, and vulcanize the product in the usual manner.

To Remove all Stickiness from the Surface of Dried Caoutchouc. Pour 11 parts of oil of turpentine over 1 part of caoutchouc. This will give a thin paste. Stir into this a small quantity, about $\frac{1}{2}$ part, of hot, concentrated liver of sulphur. This gives a yellow emulsion, which, in drying, leaves the caoutchouc entirely elastic and without the slightest stickiness.

Cement for Vulcanized Caoutchouc:

Stockholm pitch	3 parts.
American rosin	3 "
Crude caoutchouc	6 "
Oil of turpentine	12 "

are heated and stirred together. Should the mass be too thick for desired purposes, add some more oil of turpentine. The surfaces to be cemented should be roughened with pumice-stone or emery before the cement is applied.

Utilization of Vulcanized Caoutchouc Waste. The waste is comminuted as much as possible and exposed to a temperature of 570° F. until a plastic mass is formed. The heating is done by passing steam through a cylinder containing the comminuted waste. Ten pounds of the mass are then mixed with

Palm oil	2 ounces.
Sulphur	$5\frac{1}{4}$ "
White lead or magnesia, lime, zinc oxide, or clay	3 pounds.

If necessary the articles manufactured from this mass are exposed to heat.

Gutta-percha Composition. The following compositions are suitable for

ornaments, mouldings, tea-trays, picture frames, etc.:

	I.	Parts.	II.	Parts.
Gutta-percha	4		Gutta-percha	4
Bone-black	2		Powdered whale-	
White arsenic	$\frac{1}{8}$		bone or horn	
			shavings	2

A hard composition of a light color consists of:

Gutta-percha	3 parts.
Ivory or bone dust	1 part.
Pipe-clay	$\frac{1}{2}$ "

To Color Caoutchouc and Gutta-percha Black. Boil the material in a solution of 1 part of blue vitriol in 10 parts of water, and compounded with 1 part of caustic ammonia, or in a solution of 1 part of potassium bisulphate and $\frac{1}{2}$ part of blue vitriol in 10 parts of water.

Green. Boil:

Sal-ammoniac	1 part.
Blue vitriol	$\frac{1}{2}$ "
Burned lime	2 parts.
Water	10 "

The dark or light shade of the color can be regulated by adding more or less of the substances.

Solution of Gutta-percha for the Use of Shoemakers. Waste of gutta-percha is soaked in boiling water and cut into small pieces. The pieces are placed in a tin or sheet-iron vessel with a close-fitting cover, and covered with coal-tar oil, and allowed to stand quietly from 12 to 18 hours. They are then heated in hot water until they melt, and the mass is thoroughly stirred for some time. As the solution congeals on becoming cold, it must be placed in boiling water until it is to be used.

Caoutchouc Compositions for Sharpening and Polishing Knives, etc. Mix:

PARTS BY WEIGHT.

	I.	II.	III.	IV.	V.
Caoutchouc	280	280	280	280	280
Powdered emery	1120				1120
Graphite		512	488		
Zinc white				1120	
Yellow ochre				56	
Sulphur					84
Lampblack	$6\frac{1}{8}$	$6\frac{1}{8}$	$6\frac{1}{8}$		

Nos. I. and V., containing emery, are the hardest and best suited for

grinding compositions, while Nos. II., III., and IV. are used for polishing purposes.

Caoutchouc Cements. For Glass.

	PARTS.	
	I.	II.
Caoutchouc	1	12
Mastic	12	120
Dammar	4	
Chloroform	50	500
Benzine	10	

The cement, on being applied to the glass, adheres at once, and when dry possesses a high degree of elasticity.

Transparent Caoutchouc Cement for Glass.

Caoutchouc	2 parts.
Mastic	6 "
Chloroform	100 "

The solution is effected by allowing the ingredients to stand for a few days in a cold place. The cement, which is quite transparent, must be applied at once, as it becomes viscid in a very short time.

Cement for Rubber Shoes and Boots.

To repair holes in rubber shoes the following cement is used:

A. Caoutchouc	10 parts.
Chloroform	280 "
B. Caoutchouc	10 "
Rosin	4 "
Gum turpentine	2 "
Oil of turpentine	40 "

The solution A is prepared by allowing the caoutchouc to dissolve in the chloroform. For the solution B the caoutchouc is cut into small pieces and melted with the rosin. The turpentine is then added, and the mass is finally dissolved in the oil of turpentine. Both solutions are then mixed together.

To repair a hole in a rubber shoe or water-proof garment a piece of close linen is dipped in the cement and laid upon the place to be repaired, which has been previously brushed over with the cement. As soon as the linen adheres the cement is applied and smoothed. With some skill the shoe can be repaired so that it cannot be detected.

Gutta-percha Cements. For Glass.

Gutta-percha	100 parts.
Black pitch or asphaltum	100 "
Oil of turpentine	15 "

This cement, which should be used hot, is well suited for every purpose, but adheres particularly well to leather.

For Leather. A solution of gutta-percha in bisulphide of carbon of the consistency of syrup, and sufficiently diluted with petroleum, does excellent service. A thin layer of the cement is applied and the pieces of leather are tightly pressed together.

Cement for Rubber Combs. A. A very thick solution of gutta-percha in bisulphide of carbon is prepared.

B. Dissolve sulphur in bisulphide of carbon.

The parts to be cemented are brushed over with the solution A and pressed together. When dry the solution B is applied.

Elastic Gutta-percha and Linseed-oil Cement.

Gutta-percha	10 parts.
Benzine	100 "
Linseed-oil varnish	100 "

Dissolve the gutta-percha in the benzine, and when the solution is clear mix it with the varnish. This cement is very elastic, serviceable for making tissues water-proof and for cementing shoe soles to uppers, as it does not break when bent.

Gutta-percha Cement for Horses' Hoofs. To fill cracks and fissures in the hoofs of horses a cement is required which resists the action of water and possesses great elasticity combined with solidity. The following compound answers all demands:

Gum ammoniac	10 parts by weight.
Purified gutta-percha	20 to 25 "

The gutta-percha is heated from 195° to 212° F., and the powdered gum kneaded into it until a homogeneous mass is formed. The place to be cemented should be thoroughly cleansed. The cement is heated until it becomes soft, and the crack in the hoof filled with it by means of a heated knife. It becomes hard when cooled off to the ordinary temperature, and acquires in a short time such a degree of solidity that nails may be driven into it.

Substitute for Caoutchouc. Chloride of sulphur is mixed with bisulphide of carbon and naphtha, or any suitable

volatile solvent. Some fat oil, for instance rape-seed oil, is added to the mixture, which is allowed to stand quietly until the greater part of the volatile materials has evaporated. The vapors are condensed for future use. The color of this substitute for caoutchouc is yellowish-brown, and can be colored by adding suitable pigments.

Substitute for Gutta-percha. This is prepared by boiling the external part of the bark of the birch tree in water over an open fire. A black fluid substance remains in the evaporating vessel, which, when exposed to the air, becomes hard and very compact. The mass possesses all the properties of gutta-percha and may be used for the same purposes.

Composition for Ornaments, Busts, Toys, etc. The mass consists of isinglass or any other animal glue, vegetable or beeswax or rosin, and glycerine. The proportions depend on the degree of hardness the composition is to have. Fifty of glue, 35 of wax or rosin, 15 of glycerine, and the necessary quantity of a metallic oxide as a coloring substance, give a composition as hard as horn. For a soft composition 50 parts of glue, 25 of wax or rosin, and 25 of glycerine are required. The glue is dissolved in the glycerine by means of steam, and the wax or rosin added to the solution. When this is melted and mixed with the ingredients, the mineral color is added, and the mass, while in a liquid state, poured into moulds of plaster of Paris, wood, or metal. By adding 30 to 35 per cent. of zinc white, or another mineral pigment according to the color the article is to have, the hardness of the composition can be much increased.

Composition for Rollers of Wringers and Wash Machines. This consists of a mixture of sulphured linseed oil or other oil, fibrous materials (comminuted linen or cotton rags), and rosin or pitch. The materials are kneaded or passed between hot rollers until all parts are intimately mixed together. The mass is then poured around the spindle of the roller, which has been placed in a suitable mould.

Asbestos and Rubber Packing. Equal parts by weight of asbestos and caoutchouc are mixed together, forming an

elastic mass capable of resisting heat. As it contains no metallic oxides or foreign substances, it does not attack the piston-rods, and as it resists even caustic agents, it is very useful in chemical manufactories, etc.

Composition for Billiard Balls. Allow 80 parts of Russian glue and 10 of ordinary glue to swell up in 10 parts of water. Heat the mass in a water bath and add 5 parts of heavy spar, 4 of chalk, and 1 of boiled linseed oil. Take out part of the mass and when sufficiently cool form it into small sticks. Dip these sticks into the remaining mass, allow what adheres to them to dry, and repeat the dipping and drying until a crude ball has been formed. When this has become quite dry, which will require from 3 to 4 months, it is turned in the usual manner, then placed for 1 hour in a bath of acetate of alumina, dried, and polished in the same manner as an ivory ball.

Picture-frame Composition. Mix:

Glue previously soaked and melted in water	13 parts.
Pulverized litharge	4 "
White lead	8 "
Plaster of Paris	1 part.
Very fine sawdust	10 parts.

The mixture is poured into moulds consisting of 2 parts, which should be first brushed over with oil.

A Mass for Toys, Vessels, etc., consists of a mixture of clay and absorbent substances such as infusorial earth, cellulose, fibrous substances, etc., stirred into a paste with water and cast in plaster-of-Paris moulds. When hard the mass is taken out and dipped into a solution of water-glass, which is entirely absorbed by the composition. The articles are then dried at 212° F. If they are to be colored outside a thin layer of colored clay is first placed in the mould and on top of this the above-mentioned mass; the further treatment being the same as above. Dolls' heads, boxes, etc., are manufactured in this manner. By using metallic moulds, instead of those of plaster of Paris, the ingredients may be mixed with solution of water-glass before they are brought into the moulds.

Mass for Dolls' Heads. Clay slate is ground fine and 50 per cent. of it

stirred into a fluid paste with 20 per cent. of paper pulp and 30 per cent. of plaster of Paris and a sufficient quantity of water. The mass is then cast in moulds.

Marmorin. Heat, grind, and wash some magnesite and mix it intimately with an equal amount of solution of sulphate of magnesia, 1.190 specific gravity. The mass is cast in oiled moulds. When hard it can be washed with soapsuds.

New Mass for Hollow Articles. These articles are manufactured by bringing a frame of the article, made of fibrous substance or paper, into a mould with a composition, and pressing both together.

The best composition consists of 32 parts of solid (oxidized) oil, a like quantity of finely-ground cork, 2 parts each of minium and unslaked lime, and 3 of paraffine wax.

Papier Maché from Flour. The mass is prepared by stirring either wheat, oat, rye, barley, or bean flour into a thick paste with linseed-oil varnish. It is then pressed in moulds or rolled out in plates and dried in the usual manner. The articles, when entirely dry, are saturated with linseed oil, then treated with colored lacquers, and finally polished.

Fine Pasteboard Mass for Moulding Large Figures. Boil 4 parts of waste paper in water and mix them thoroughly with 6 of whiting. The mass is then kneaded, rolled out upon a board, and cut in pieces, which are pressed into the separate parts of the mould and then taken out and dried. The pieces are then joined together with the same mass and glue water, and when they are dry the uneven places are smoothed by means of a knife, file, and shave-grass, and finally the figure is coated with a composition consisting of French chalk and decoction of Brazil wood, and when dry is painted, gilded, etc.

Composition for Razor Straps. Mix 18 parts of fine paper pulp with 3 of powdered emery and 2 of starch. Ferric oxide or stannic oxide can be substituted for the emery.

CEMENTS, PASTES, AND PUTTIES.

To Cement Iron to Iron. Mix:

Powdered cast iron bore chips	60 parts.
Sal-ammoniac	2 "
Flowers of sulphur	1 part.

and stir the mixture into a stiff paste by adding water. The cement must be used while fresh.

Mastic Cement. Powder:

Slaked lime	60 parts.
Sand	35 "
Litharge	3 "

and knead them to a stiff mass with 7 to 10 parts of old linseed oil, or linseed-oil varnish. It is best to do this in a mortar with a pestle, and the mass should be thoroughly worked.

Cement for Steam-pipes. Rub as fine as possible:

Litharge	2 parts.
Powdered slaked lime	1 part.
Sand	1 "

and mix the mass with a sufficient quantity of hot linseed-oil varnish to form a stiff paste. This cement must be used while fresh and warm.

Cement for Glass Retorts. Mix:

Iron filings	13 $\frac{1}{2}$ pounds.
Cement	2 $\frac{1}{4}$ "
Plaster of Paris	1 pound.
Sal-ammoniac	2 $\frac{1}{8}$ ounces.
Powdered sulphur	1 $\frac{1}{8}$ "
Vinegar	1 $\frac{3}{4}$ pints.

and stir the mass into a paste with water. The cemented articles must not be exposed to moisture.

English Cement for Porcelain. Soak 1 drachm of isinglass in water; pour upon this a sufficient quantity of alcohol to cover the isinglass, and allow it to dissolve, placing it in a warm room. Next dissolve $\frac{1}{2}$ drachm of mastic in 1 fluid drachm of rectified spirit of wine; mix both solutions together, add $\frac{1}{2}$ drachm of powdered gum ammoniac, and evaporate the mixture in a water-bath until it has acquired the requisite consistency. Keep the cement in a glass bottle, and when it is to be used place the bottle in hot water, when the cement will become soft so that it can be conveniently applied to the fragments of porcelain to be cemented, which should be previously heated.

Water and Fire-proof Cement, available for Metal, Porcelain, and Earthenware. One and three-quarter pints of sweet milk are curdled with the addition of some wine vinegar. The whey is taken and the whites of 4 to 5 eggs stirred into it. Finely-pulverized quicklime is added, and the mass thoroughly

mixed together with a spatula. This cement will stand fire and water if it is first dried in the air and then over a fire.

Cements for Fastening Metal Letters upon Glass, Marble, Wood, etc. No. 1. Mix:

Copal varnish	15 parts.
Linseed-oil varnish	5 "
Oil of turpentine	5 "
Glue	5 "

The glue is dissolved by placing the mixture in a water-bath. When the solution is complete, 10 parts of slaked lime are added to it.

No. 2. Fifteen parts of a varnish prepared from sandarach and white pine rosin are mixed with 5 parts of linseed oil boiled with litharge, and 5 parts of oil of turpentine. To this add 5 parts of marine glue, and, after this mixture has been dissolved by placing it in a water-bath, add 10 parts of flake white and white lead.

No. 3. Mix 15 parts of copal varnish prepared with an addition of rosin, and 5 parts of oil of turpentine, with:

Powdered isinglass	2 parts.
Sifted iron filings	5 "
Washed clay or ochre	10 "

No. 4. Mix 15 parts of copal varnish prepared with gum-lac, 5 of linseed oil boiled with litharge, 8 of solution of caoutchouc in tar oil, 7 of tar oil with 10 of Roman cement and plaster of Paris.

Cement for Fastening Iron Articles in Stone. Mix:

Good plaster of Paris	7 parts.
Iron filings	1 part.

and stir the mixture into a paste with water. This cement dries very quickly.

Cement for Stone Troughs and Wooden Vats. Melt:

Rosin	2 parts.
Yellow wax	2 "

in an iron ladle. Then add 2 parts of very finely-pulverized and calcined ochre, and keep the mass for a short time in a fluid state. By pouring the mass into the joints and cracks of the stone or wood, it forms a cement as hard as stone.

Cement for Repairing Articles of Sandstone. Mix:

Dry, clean, fine sand	20 parts.
Pulverized plumbic oxide	2 "
Pulverized lime	1 part.

and form a thick paste by adding linseed oil or linseed-oil varnish.

Davy's Universal Cement. Melt:

Common pitch	4 parts.
Gutta-percha	4 "

in an iron vessel, mix intimately together, and keep the resulting cement either fluid under water, or in a dried and hard condition.

This cement holds equally well upon wood, stone, glass, porcelain, ivory, leather, parchment, paper, feathers, wool, cotton, linen, etc.

Cement for Joining Leather Driving Belts. Mix 10 parts of bisulphide of carbon and 1 of oil of turpentine, and dissolve in it a sufficient quantity of gutta-percha to form a paste. The pieces of leather to be joined are cleansed from oil and grease by laying a rag upon their surfaces and placing a hot iron upon it. Both pieces are then spread with the cement and subjected to pressure until the cement has become dry.

Cement for Fastening Rubber upon Metal. This cement is prepared by soaking pulverized shellac in ten times its weight of strong ammonia. The result will be a transparent mass which becomes fluid in 3 to 4 weeks without the use of water. This fluid makes the rubber soft, but after the evaporation of the ammonia it becomes hard and impermeable to gases and fluids.

Cement for Aquaria, etc. Two and one-quarter pounds each of litharge, fine white sand, plaster of Paris, and 1 pound of boiled linseed oil are mixed to a paste and drying oil added. This cement can only be used after it has stood for a few hours, but then does excellent service for salt and fresh-water aquaria, reservoirs, etc. It becomes very hard, but acquires its greatest degree of hardness when in salt water.

Cement for Repairing Defective Places in Castings. One part of black pitch and 1 of rosin are melted in a crucible and a sufficient quantity of fine iron filings added to form a stiff mass, and allowed to become cold. The defective place is heated, a piece

of the cement laid upon it and pressed into the defective place with a hot iron.

Cement for Leather. Ordinary glue and isinglass are soaked for 10 hours in sufficient water to cover them. It is then brought to the boiling point and pure tannin added until the solution becomes sticky and has the appearance of white of egg.

Glycerine Cement. This cement is prepared by moistening litharge with glycerine. It forms a cement which becomes very hard in 10 minutes. The cement is well suited for vessels containing benzole, ether, oils, acids, etc., and also for iron and stone.

Cement for Petroleum Lamps.

Rosin	12 parts.
Strong lye	16 "
Water	20 "
Plaster of Paris	20 "

The rosin is boiled with the lye until it is entirely dissolved and, when cold, forms a tenacious solid mass. This is sufficiently diluted by adding the water, and the plaster of Paris is then carefully worked in. This cement is insoluble in petroleum, and can be recommended for fastening the metal parts upon glass lamps.

Best Cement for Tortoise Shell.

Mastic	30 parts.
Shellac	90 "
Turpentine	6 "
Spirit of wine 90 per cent. strong	350 "

Cement for Ivory and Bone. White wax, rosin, and oil of turpentine are melted together at a moderate heat so as to form a thick fluid mass. If the cement is to be colored, finely-powdered coloring substances, as red lead, ultramarine, etc., are added to the mass.

Caseine Cements. Caseine can be used for preparing a number of cements. It is best to prepare an entirely pure caseine, although that found in old cheese may be used; but this always contains some fat, salt, and free acids, which exert an injurious effect upon the hardness and solidity of the cement. Pure caseine is prepared in the following manner: Milk, carefully skimmed so that not a trace of cream remains, is allowed to curdle by letting it stand in

a warm place. The curdled milk is then poured through a paper filter, and the caseine remaining upon the filter is washed with rain water until the latter shows no trace of free acid. To remove the last traces of fat the caseine is tied in a cloth and boiled in water. It is then spread out upon blotting-paper and allowed to dry in a moderately warm place, when it will shrivel up to a horn-like mass. This pure caseine, when properly dried, can be kept for a long time without injury.

Caseine Cement for Metals. Mix:

Washed quartz sand	10 parts.
Caseine	8 "
Slaked lime	10 "

Caseine Cement for Meerschaum. Dissolve caseine in water-glass, stir quickly finely-powdered burned magnesia into the solution and use at once, as the cement rapidly becomes hard. By mixing genuine meerschaum powder with the magnesia, a mass closely resembling genuine meerschaum is obtained.

Ordinary Caseine Cement.

Caseine	12 parts.
Slaked lime	50 "
Fine sand	50 "

This cheap cement is well adapted for filling large holes in freestone and joints between building stones.

Best Caseine Cement. Fresh cheese is boiled in water until it has been dissolved to a mass which will draw into threads between the fingers. Slaked lime and very finely-sifted wood ashes are then stirred into the solution. Take:

Cheese	100 parts.
Water	200 "
Slaked lime	25 "
Wood ashes	20 "

Chinese Blood Cement. This cement is in general use in China to make wooden and pasteboard vessels, willow-ware, etc., water-proof. Mix:

Slaked lime	100 parts.
Beaten bullocks' blood	75 "
Alum	2 "

Blood and Ash Cement.

Slaked lime	100 parts.
Sifted coal ashes	50 "
Beaten bullocks' blood	15 "

This cement is used for filling joints between bricks and building stones.

Jewellers' Cement.

Isinglass	100 parts.
Mastic varnish	50 "

The isinglass is dissolved in as small a quantity of water as possible, with the addition of some strong spirit of wine. The mastic varnish is prepared by pouring highly-rectified spirit of wine and benzine over finely-powdered mastic and dissolving this in a small quantity of the solvent as possible. The two solutions are then poured into a porcelain dish and intimately worked together.

Armenian Glue. This preparation possesses about the same properties as the diamond glue and is used for the same purposes:

Isinglass	600 parts.
Gum ammoniac	6 "
Mastic	60 "

The isinglass is allowed to swell up in water to which some spirit of wine has been added. The gum ammoniac and mastic are dissolved in as little spirit of wine as possible, and both solutions are then intimately mixed together.

Cement for Quickly Closing Leaky Places in Barrels.

Tallow	25 parts.
Wax	20 "
Lard	40 "
Sifted wood ashes	25 "

are mixed together by heating and applied to the defective place by means of a heated knife blade.

Cement for Iron Stoves.

Wood ashes	10 parts.
Clay	10 "
Burned lime	4 "

are mixed with sufficient water to form a stiff paste.

To Prepare Liquid Glue. Dissolve $3\frac{1}{2}$ ounces of ordinary gelatine in a mixture of 1 pint of water and $\frac{1}{4}$ ounce of crude oxalic acid, and keep the solution 5 or 6 hours in a flask on a water-bath. It is then poured in a porcelain dish, diluted, neutralized with calcium

carbonate, filtered, and evaporated at a moderate temperature. The quantity of glue obtained by this process will be about double the quantity of the gelatine used. It is very clear, slightly colored, and very tenacious.

Liquid Glue. Soak the glue in water, then melt it at a moderate heat, and add strong vinegar until the solution remains a thick fluid when cool. Add a small quantity of acetic or nitric acid, which will keep it fluid at an ordinary temperature until the acid evaporates.

Glue for Labels, etc. Dissolve at a moderate heat 2 parts of white gelatine and 1 of rock candy in 3 of water. Or, dissolve at a moderate heat 9 ounces of ordinary glue, $4\frac{1}{2}$ ounces of rock candy, and $1\frac{1}{2}$ ounces of gum Arabic in 1 part of rain, or distilled, water.

Glue for Fancy Articles, Fine Leather Goods, etc. Compound 1 pint of rye whiskey with the same quantity of water. Add to this $4\frac{1}{2}$ ounces of powdered starch, and stir the mass into a paste. Then dissolve $1\frac{1}{4}$ ounces of good glue in the same quantity of water, add $1\frac{1}{4}$ ounces of thick turpentine, mix thoroughly, and finally combine this mixture, constantly stirring, with the above paste.

Water-proof Glue for Wooden Utensils. Boil for 10 minutes a mixture of:

Thick solution of glue	10 parts.
Linseed-oil varnish	5 "
Litharge	1 part.

and use the compound while hot.

Glue for Ivory and Bone. Colorless isinglass is boiled with water until a thick solution has been formed. Add to this a sufficient quantity of washed zinc white to form a liquid of the consistency of honey.

Glue for Joining Glass to Wood. A solution of ordinary glue is made very fluid by bringing it to the boiling point. Add to it, with constant stirring, a sufficient quantity of very finely-sifted wood ashes to form a mass of the consistency of syrup. It should be used while hot. This cement, which resists the action of water, adheres remarkably well and can also be used for joining stone and wood.

Diamond Glue of the Best Quality. The following preparation is highly valued by jewellers for cementing gems and corals and can also be advanta-

geously used for fastening colored pastes upon white glass. It can be exposed for some time to the action of water without becoming soft. It adheres most tenaciously to glass or gems:

Isinglass	8 parts.
Gum ammoniac	1 part.
Galbanum	1 "
Spirit of wine	4 parts.

The isinglass is allowed to swell up in water to which some of the spirit of wine has been added. The resins are dissolved in the remaining spirit of wine and added to the isinglass. The cement, before it is used, should be sufficiently heated to make it soft.

Chromium Glue. Glue, when combined with chromates and exposed to the light, loses its solubility in water, and can therefore be used for repairing valuable glass or porcelain articles. It is prepared in the following manner: Pure white glue is dissolved in boiling water, potassium bichromate is added to the solution and intimately mixed with it by stirring, and immediately poured into tin boxes, where it is allowed to congeal. The following proportions are used:

White glue	5 to 10 parts.
Water	90 "
Potassium bichromate	1 to 2 "
Dissolved in water	10 "

When the glue is to be used a sufficient quantity of it is melted, spread uniformly upon the fractured surfaces of the glass, and the article exposed for a few hours to the sun.

Good Mouth Glue. No. I. Pieces of ordinary glue are soaked for 2 days. The water is then poured off and the glue melted over a moderate fire. To 1 pound of glue add $\frac{1}{2}$ pound of white sugar, mix thoroughly, and then pour the mass into suitable moulds and allow it to stand quietly for a few days. In using the glue it is moistened with the tongue.

No. II. Soak for 2 or 3 days 1 part of isinglass, $\frac{3}{4}$ of parchment shavings, $\frac{1}{4}$ of rock candy. Then boil the whole in an earthen pot, stirring constantly to prevent the mass from burning. When it is boiled down to about one-half the quantity, strain the fluid through a coarse cloth, and when about half cold

pour a thin layer of it upon a stone slab.

Excellent Mouth Glue. Isinglass, to which some sugar has been added, is boiled until it forms a yellow transparent mass. This glue may also be used for joining torn pieces of paper.

Lime Putty for Wood.

Powdered slaked lime	1 part,
Rye flour	2 parts,
Linseed-oil varnish	1 part,

and a sufficient quantity of umber to color it.

French Putty for Wood.

Gum Arabic	1 part.
Water	2 parts.
Potato starch	3 to 5 "

Powdered Wood and Oil Putty. Very fine sawdust is formed into a dough by moistening it with linseed-oil varnish and continued kneading. This very plastic mass forms an excellent putty.

Powdered Wood and Glue Putty.

Water	20 parts.
Glue	1 part.
Finest sawdust as much as may be required.	

The glue is first entirely dissolved by boiling it in the water, and the sawdust is then gradually stirred in.

Putty for Floors of Soft Wood.

No. I. *For Floors which are to be Scrubbed.*

Caseine	1 part.
Water	7 parts.
Spirit of ammonia	$\frac{3}{4}$ part.
Burned lime	$\frac{1}{2}$ "

No. II.

Glue	2 parts.
Water	14 "
Cement	7 "
Sawdust	3 to 4 "

Both putties should be prepared immediately before they are to be used.

Putty for Floors which are to be Lacquered.

Glue	2 parts.
Water	14 "
Plaster of Paris	4 "
Litharge	2 to 4 "

Paste for Wall Paper.

Flour paste	100 parts.
Alum water	3 "
Solution of dextrine	5 "

The object of adding solution of dextrine is to give more adhesive power to the paste; that of alum water to prevent the paste from spoiling and the wall paper from becoming mouldy in case the wall is not entirely dry.

Paste for Microscopic Objects.

A thick fluid paste which dries quickly, does not crack, and adheres tenaciously to the glass, is required for fastening the glasses covering microscopic objects. A paste or cement prepared from solutions of dammar resin, asphaltum, or caoutchouc, or a mixture of the last two in very volatile solvents, is best adapted for the purpose. After the object to be preserved has been placed in the right position upon the glass, a ring of the paste is formed around it and the cover pressed down and held there until the paste has become hard.

Benzine, petroleum, or bisulphide of carbon may be used as a solvent for dammar resin, caoutchouc, or asphaltum. If the enclosure is to contain a fluid besides the microscopic preparation it is best to prepare the paste from a mixture of caoutchouc and asphaltum, as this resists fluids far better than a solution of dammar resin.

The paste prepared from dammar resin has a yellow color; that from caoutchouc and asphaltum is black. A white paste is made by rubbing Canada balsam with zinc white, and adding a sufficient quantity of benzine to give a syrupy consistency to the mass.

Glycerine Glue for Enclosing Microscopic Preparations. One part by weight of white glue (gelatine) is placed in a porcelain vessel, 6 parts by weight of water are poured over it, and it is allowed to swell up for 24 hours. It is then heated at 175° to 200° F. until it is entirely dissolved. Seven parts of concentrated, colorless glycerine are added to the solution and intimately mixed with it by stirring. The mixture is then heated for 10 to 15 minutes and filtered, while warm, through cotton.

Paste for Postage Stamps, etc.

Dextrine	2 parts.
Acetic acid	1 part.
Water	5 parts.
Alcohol	1 part.

The foregoing mixture is used for United States postage stamps.

Sugar and Lime Paste.

White cane sugar	12 parts.
Water	36 "
Slaked lime	3 "

The sugar is dissolved in water, the solution heated to the boiling point, the lime poured in, and the fluid allowed to stand for several days in a covered vessel and stirred once in a while. When it has settled the thick fluid is poured off from the excess of lime.

The solution obtained in this manner has all the properties of a solution of gum Arabic, possesses great adhesive power, and dries to a lustrous mass.

Fluid Paste. I. Ten pounds of potato starch are placed in a porcelain vessel and 5 quarts of water and $\frac{1}{2}$ pound of nitric acid poured over it. The mixture is allowed to stand for 24 hours in a warm place, being several times stirred, and is then boiled until it becomes thickly fluid and very transparent. If necessary it is diluted with water and filtered through a close cloth.

II. Dissolve 10 pounds of gum Arabic and 2 pounds of sugar in 1 gallon of water; add $1\frac{3}{4}$ ounces of nitric acid, heat to the boiling point and mix both fluids I. and II. The resulting paste is liquid, does not mould, and dries to a transparent layer upon paper. It is especially well adapted for flaps of envelopes, fine bookbinders' work, etc.

Dry Pocket Paste.

Glue	6 parts.
Sugar	$2\frac{1}{2}$ "

The glue is dissolved by boiling in water, the sugar added to the hot solution, and the mass evaporated until a test sample congeals on becoming cold. The hard mass dissolves quickly in lukewarm water, and furnishes a paste adapted especially for paper.

Good Cement for Filling Teeth. The following preparations furnish cements for filling teeth:

I.		II.	
	Parts.		Parts.
Zinc oxide	200	Zinc oxide	500
Silica	8	Powdered amber	1.5
Borax	4	Yellow ochre	1.5
Powdered glass	5	Borax	10
		Powdered glass	100

III.		IV.	
	Parts.		Parts.
Zinc oxide	500	Zinc oxide	500
Powdered pyro-lusite	1.5	Powdered pyro-lusite	1.5
Yellow ochre	3.5	Yellow ochre	4
Powdered glass	100	Powdered glass	100
Borax	10	Borax	10

The ingredients are well mixed, sifted through a hair sieve, and preserved in well-corked bottles.

When any of the cement is to be used, it is mixed with concentrated solution of zinc chloride to form a paste, and the hollow tooth filled with it. In ten minutes the paste becomes hard, and remains unchanged for years.

Nos. I. and II. furnish the lightest colored cement, and No. IV. the darkest.

Cement for Injured Trees. Mix :

Sifted wood-ashes	5 parts,
Yellow ochre	10 "
Ordinary white lead	50 "
Venetian turpentine	10 "

with a sufficient quantity of linseed oil to give to the mixture the consistency of an electuary. It should be applied twice to the injured part of the tree.

German Tree Wax. Mix :

Finely powdered lime	3 parts,
Finely powdered charcoal	1 part,

with a sufficient quantity of linseed oil to form a homogeneous dough. It should be kept in a pot hermetically closed. It is applied to the injured parts of the tree by means of a large brush.

Grafting Wax.

Pine rosin	50 parts.
Tallow	10 "
Oil of turpentine	5 "
Spirit of wine	5 "

The resin is melted in an iron vessel, the turpentine added, next the tallow, and finally the spirit of wine, and the ingredients are thoroughly stirred together.

Durable Paste. Four parts by weight of glue are allowed to soften in 15 parts of cold water for some hours, and then moderately heated until the solution becomes quite clear. Sixty-five parts of water are now added, with constant stirring. In another vessel 30 parts of starch paste are stirred in 20 of cold

water, so that a thin milky fluid is obtained without lumps. Into this the boiling solution of glue is poured, with constant stirring, and the whole kept at the boiling temperature. After cooling, 10 drops of carbolic acid are added to the paste. This paste is of extraordinary adhesive power, and may be used for leather, paper, or card-board with great success. It must be preserved in closed bottles to prevent evaporation of the water, and will in this way keep good for years.

Paste for Fixing Printed Labels on Machines. Labels are often required to be affixed to parts of machines; but the paste, etc., used for this purpose often becomes damp, and the label falls off. A paste to resist damp is made as follows: Prepare a paste of good rye flour and glue, to which linseed oil varnish and turpentine have been added in the proportion of ½ ounce of each to the pound.

Safety Paste for Post-Office Packages. The postal wrappers and envelopes in common use can be easily opened by loosening the gum with moisture. Postage stamps can, in the same way, be dishonestly detached. The following compositions will meet this evil: Two adhesive compounds are used—one is applied to the flap of the envelope, the other to the part against which it is pressed, or the first to the stamp, and the other to the place on the envelope where it is to be affixed :

I. *Upon the Letter.*

Chromic acid	2.5 parts.
Caustic ammonia	15 "
Water	15 "
Sulphuric acid	½ part.
Cupro-ammonium solution	30 parts.
Fine white paper	4 "

II. *Upon the Flap or Stamp.* Dissolve isinglass or glue in a mixture of 7 parts of water and 1 of acetic acid.

The chromic acid forms with glue a combination insoluble in water. When the parts of the wrapper, envelope, etc., are fastened together, the union is so firm as to resist all loosening influences, acids, alkalis, hot or cold water, or steam. The wrapper can only be opened by tearing or cutting.

CHEMICAL AND TECHNO-CHEMICAL
EXPEDIENTS, PREPARATIONS.

Johnson's Process and Apparatus for Manufacturing Potassium Ferrocyanide. Potassium carbonate 65 parts, wood charcoal, or coke, 115 parts, water 65 parts, are heated until the coal is entirely dry. It now contains in its pores the decomposed potassium carbonate, which, together with 5 parts of iron filings, are placed in cylindrical cast-iron retorts. Fig. 5 represents the vertical section of the furnace and retorts, and Fig. 6 the horizontal section in the direction of 1 2. In

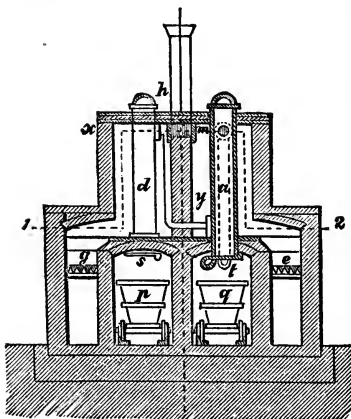

Fig. 5.

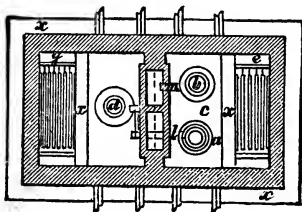

Fig. 6.

Johnson's Apparatus for Manufacturing Potassium Ferrocyanide.

Fig. 5 *a b* are the retorts standing alongside each other in the furnace *x*.

They are connected by the pipe *c*, which passes from the upper part of the retort *a* to the lower part of *b*. The mass in the retorts is heated to a white heat to expel all moisture; ammoniacal gas is then passed through it. This is produced by heating equal parts of ammonium sulphate and burned lime in the cast-iron retort *d*. As less heat is required for developing the gas, the retort *d* is provided with a special fire-place *g*, while the other two retorts are heated from *e*. The retort *d* is separated by a brick wall from *a* and *b*. *h* is the chimney for both fire-places. The ammoniacal gas passes from the retort *d* through the pipe *l* into the lower part of the retort *b*, and the part not fixed here escapes through *m* into the chimney. When the mass in *d* ceases to generate gas, the residue is removed through *s*, falls into the wagon *p*, and is carted away. The retort *d* is then charged anew. The retorts *a* and *b* are emptied in the same manner, after the gas has sufficiently acted upon the mass. This falls into sheet-iron boxes standing upon the wagon *q*, which, like the wagon *p*, runs upon rails. The retorts are opened and shut by the valves *s* and *t*. The mass taken from the retorts *a* and *b* is treated with water in the usual manner, and lixiviated, and the potassium ferrocyanide allowed to crystallize from the fluid. The grate bars in the retorts *a* and *b* must be so arranged that they can be easily removed. By omitting the iron, potassium cyanide can also be prepared with this apparatus.

Phosphorescent (Illuminating) Powder. Mix 100 parts each of calcium carbonate and phosphate (obtained by burning shells, especially those of tridama and sepia), add unslaked lime 100 parts, calcined salt 25 parts, and 25 to 50 per cent. of the entire mass of sulphur. This powder illuminates barometers, compasses, etc., and becomes especially phosphorescent when acted upon by an electric current. [The well-known "luminous paint" is composed of substantially the same materials. It remains faintly luminous for some time after being exposed to the light, and is used for match-safes, etc. (W.)]

To Thaw Frozen Ground. If there is snow on the ground, place alternate

layers of unslaked lime and snow over the spot to be thawed. Slaking of the lime generates heat, and in a few hours will soften the ground so that it can easily be dug up even at a temperature of zero F.

Artificial Sandstone for Filtering.
Mix:

	PARTS.		
	I.	II.	III.
Clay	10	10	15
Chalk	1	1	1
Glass-sand, coarse	55		
“ fine		25	65
Flint		30	5

The mixture is kneaded with water, shaped into the desired form and strongly burned.

mus, which is nearly insoluble in water free from alkali. In the usual manner of preparing tincture of litmus, the substances passing into the filter remain in it, and this frequently injures the sharpness of the reaction.

When a solution is to be prepared from the powder obtained in the above manner, place the necessary quantity of it upon a filter, pour hot water and a few drops of ammonia upon it, and wash out until the sand is exhausted, which can be accomplished in a few minutes. The filtrate is then acidulated with a few drops of sulphuric acid, and again neutralized.

New Method of Extracting Tannin.
 With this new apparatus the lixiviation

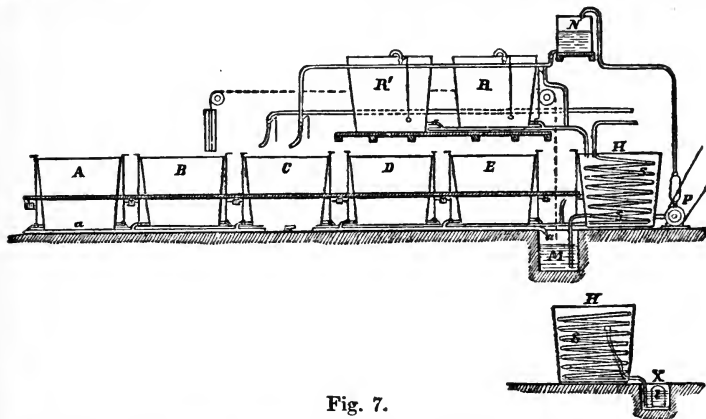

Fig. 7.

To Prepare Tincture of Litmus. A quantity of commercial litmus is powdered as fine as possible and extracted with cold water until exhaustion just commences; fine sand is then added and the solution evaporated. During evaporation a sufficient quantity of hydrochloric acid is added, that the fluid, after the evaporation of the carbonic acid, may have a deep red color. The brown-red and perfectly dry powder obtained in this manner is rubbed as fine as possible, washed upon large, smooth filters, first with hot and then with cold water, and the residue dried on the water-bath. This contains, precipitated upon the sand, the actual constituent of lit-

mus, which is nearly insoluble in water free from alkali. In the usual manner of preparing tincture of litmus, the substances passing into the filter remain in it, and this frequently injures the sharpness of the reaction. When a solution is to be prepared from the powder obtained in the above manner, place the necessary quantity of it upon a filter, pour hot water and a few drops of ammonia upon it, and wash out until the sand is exhausted, which can be accomplished in a few minutes. The filtrate is then acidulated with a few drops of sulphuric acid, and again neutralized. *New Method of Extracting Tannin.* With this new apparatus the lixiviation of the materials containing tannin is carried on systematically. The first vat A (Fig. 7) of a battery of five lixiviating vessels is filled with the wood, the alkaline sulphite (1 of the latter to 250 of the former), and water. This is boiled by steam and the fluid allowed to pass through the pipe a into the reservoir M. From here it is brought by the pump P into the vat N, and then drawn off into the reservoirs R and R'. The contents of the vat A are once more lixiviated, and the entire process is repeated. The third time the fluid from A through N does not pass into R, but into the vat B, which has in the meanwhile been filled with fresh

material. The lixiviating water traverses the same course as before for the fourth time. The same process is gone through with the vats C, D, and E, so that every vat participates in two operations. In the vats R and R' the decoction is slightly acidulated with sulphuric acid. From here it is brought into the clarifying vat H. The temperature of the cover is lowered to about 100° F. by cold water passing through the coil pipe S. Albumen (blood) is then added, which is coagulated by steam passing through the pipe S'. The precipitate settles and the fluid passes through the perforated float F, and the filter *t* filled with lixiviated wood-shavings, into the cistern X.

The solution of tannin obtained in this manner shows 2° B. It can be used for tanning without further preparation. For transportation the extract is still further concentrated.

Process and Apparatus for Purifying Water with a Mixture of Caustic Magnesia or Carbonate of Magnesia and Sawdust. The purifying battery consists of several cylinders containing boxes *e* (Fig. 8) with perforated bottoms.

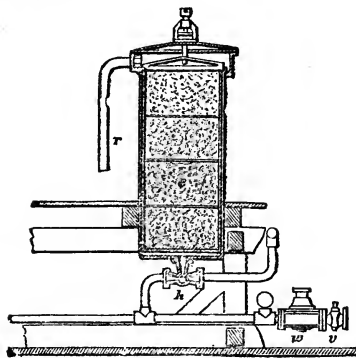

Fig. 8.

Upon these are placed an intimate mixture of equal parts of magnesia and sawdust. The water to be purified enters through the cock *v*, the cataract *w*, and the cock *h* from below into the first cylinder. From here it is conveyed through the pipe *r* into the second

cylinder and so on. The finely powdered magnesia absorbs the carbonic acid of the water, and, in consequence, precipitates the calcium carbonate of the water in crystalline form upon the mass. From the last cylinder the purified water reaches the discharge pipe. The apparatus works continuously.

Caustic Potash. Take 1 part of potassium carbonate and 4 of water, add 1 part of fresh-slaked powdered lime, boil for a few minutes and add gradually 6 parts of water.

Caustic Soda (Soda Lye). Fill a vat of a capacity of 555 gallons half-full of water, and bring this to the boiling point by introducing steam. Dissolve in this 120 pounds of the best calcined soda. Have ready 165 pounds of freshly burned lime. Add this gradually to the soda lye, and as soon as one portion is dissolved add another. As a strong effervescence takes place, water must be kept ready to prevent the fluid from running over. When all the soda has been added the boiling is continued until everything has been dissolved. The clear liquor, when the lye has settled, is brought into an iron boiler at least half as large as the vat, and heated over a fire. Water is poured upon the residue of soda and lime in the vat, steam introduced and it is boiled once more. The clear liquor is added to that in the boiler. Water is again poured upon the sediment in the vat in order to lixiviate it entirely, and this liquor also added to that in the boiler. This liquor is then evaporated until the desired degree, 30° to 35° B., has been obtained.

To Prepare Pure Chlorine Gas. Put 1 part by weight of powdered potassium bichromate in a retort or matrass, compound it with 6 parts by weight of hydrochloric acid, and heat gently over a spirit lamp until a vigorous reaction takes place. The chlorine gas will now develop itself continually and quickly without the necessity of continuing to heat the mixture.

Chloride of Zinc. Heat in a glass vessel 6 ounces of hydrochloric acid, and compound this with 2½ ounces of carbonate of zinc. The fluid, when cold, is filtered through powdered glass, and finally evaporated to dryness over a moderate fire, with constant stirring.

The mass, while still warm, is powdered, and placed immediately in heated vessels, which should be tightly closed. By this process a white powder is obtained which deliquesces easily on exposure to the air.

Chloride of Gold. This is prepared by dissolving small pieces of gold free from copper in aqua regia (formed of 2 parts of pure hydrochloric acid and 1 part of pure nitric acid) until, even when the acid is boiling, no more gold is dissolved. As some gold always remains undissolved, the solution is filtered from the residue, and gradually evaporated to dryness, in order to expel the excess of acid. The residue is dissolved in distilled water, and the solution of gold obtained in this manner kept for future use.

To Prepare Pure Oxalic Acid. Potash lye of 36° Baumé is brought to the boiling point in a strong iron boiler, and sawdust of pine wood added until the mass becomes thick. By continuing the heating, and after the water has evaporated, the mass, while being constantly stirred, becomes again thin fluid, homogeneous, and assumes a turmeric-yellow color. The heat is kept up for 2 to 2½ hours; the fire is then drawn, and the mass allowed to cool off. Water is now slowly poured into the mass while still hot, until the solution shows 40° Baumé when, after stirring thoroughly, it is allowed to cool off. The yield of oxalate of potassium, which is entirely insoluble in the lye of 40° Baumé, is considerable. This method of preparing oxalate of potassium is not new, though considerably improved, but the following process of preparing *pure oxalic acid* from this oxalate of potassium is entirely new:

The non-crystallized oxalate of potassium is washed and dissolved, while hot, in a large quantity of water and, after clarifying, is precipitated with a solution of chloride of magnesium or a solution of sulphate of magnesia. The resulting magnesium oxalate is thoroughly washed, heated in a wooden vat by introducing steam, and concentrated hydrochloric acid added until it is completely dissolved. The clarified solution is drawn hot into a clay vessel, and, when cold, the oxalic acid separates

in fine white crystals. These should be dried by placing between the folds of absorbent paper.

To Prepare Purified Oleic Acid. Dissolve 60 parts of oil-soap in 240 parts of water, compound the solution with 10 parts of sulphuric acid, let it come to a boil, wash the oleic acid with 60 parts of hot water, and then introduce 4 parts of plumbic oxide. The lead soap, while still hot, is mixed with 60 parts of spirit of wine of 0.82 specific gravity, heated to 150° F., and the oleate of lead, after settling, is decomposed with hydrochloric acid, when the oleic acid, which separates, is repeatedly washed with water.

Cream of Tartar. Digest for several hours 10 parts of purified powdered tartar with 10 of water and 1 of crude hydrochloric acid. Stir the solution frequently, and allow it to stand for one day. Then filter through linen, and wash first with ordinary and then with distilled water, to free the fluid from the hydrochloric acid. The residue is dried and forms the cream of tartar of commerce.

Lunar Caustic. Dissolve 6 parts of pure silver in 14 of nitric acid, evaporate the fluid to dryness at a moderate heat, and melt the residue in a porcelain vessel. The mass, when cooled off, is dissolved in water and evaporated to dryness with the addition of a drop of nitric acid. The residue is melted and run into moulds.

Pure Acetic Acid. Distil 5 parts of anhydrous fused sodium acetate with 6 of pure concentrated sulphuric acid. The distillate is a colorless fluid, boiling at 244.4° F., and solidifying, on cooling, into large transparent plates (glacial acetic acid).

Sulphocyanic Acid is prepared for analytical purposes by precipitating 2 parts of sugar of lead with 1 of ammonium cyanide, washing the precipitate with water, decomposing with sulphide of hydrogen and filtering. The resulting sulphocyanic acid is freed from the sulphide of hydrogen by introducing a current of air, and then diluted to 1.01 specific gravity.

Molybdic Acid from Molybdenum Disulphide. Melt in a Hessian crucible 4 parts of potassium nitrate, and add gradually 1 of molybdenum disulphide

finely powdered. The fused mass with the residue remaining in the crucible is dissolved in water, the solution filtered, evaporated to one-tenth of its volume and allowed to crystallize. Crystals of potassium nitrate and sulphate form in a short time, which are removed from the fluid. This is again filtered and compounded with pure nitric acid as long as a snow-white precipitate is obtained, but in doing this any excess of nitric acid must be avoided. This precipitate forms the molybdic acid, which is collected upon a filter and dried in the open air. Eight parts of molybdenum disulphide give about 5 parts of molybdic acid.

Potassium Acetate. Compound 7 ounces of pure potassium carbonate with 1 pint of concentrated vinegar, or add such a quantity of vinegar as is necessary for complete saturation. The fluid is filtered, brought into a porcelain vessel and evaporated to dryness over a steam-bath. The salt, while still warm, is placed in a glass vessel, and this is kept closed hermetically.

To Prepare Sulphate of Copper. The solution much used in electrotyping is prepared by making a saturated solution of blue vitriol in water, and adding 8 to 10 per cent. of sulphuric acid to the solution. (W.)

Liver of Sulphur. Mix 1 pound of purified sulphur with 2 pounds of pure potassium carbonate. Place the mixture in a melting pot, cover it and apply a moderate heat until all effervescence ceases, and the mass is changed into a homogeneous fluid. Then pour it upon a sheet-iron plate or marble slab, and, when cool, pulverize it. This has a yellowish green color, and can be completely dissolved in 2 parts of water.

Schiel's Apparatus for Testing the Percentage of Nicotine in Tobacco. The apparatus, Fig. 9, consists of two glass flasks with narrow necks connected by a glass tube bent at right angles.

The tobacco, cut in pieces, is placed in the flask A, standing in a saucer containing cold water, and extracted with ammoniacal ether. By taking after a short time the flask A out of the cold water, placing B in its place, and putting A in a saucer with warm water, the ether vapor which is formed forces

the solution of nicotine through the tube reaching to the bottom of the flask, and over the end of which is tied a

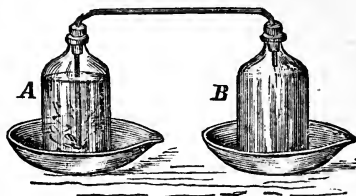

Fig. 9.

small, fine woollen rag, into B. By changing the position of the flasks, so that A stands again in the cold water and B in the warm, the ether is redistilled into A, the nicotine remaining in B. By repeating this operation—changing the position of the flasks—several times the tobacco will be exhausted, and the nicotine can be determined by volumetric analysis. Before connecting the tube with the flask B it is advisable to put some ether into the flask and expel the air by the vapor of the ether. The corks are tied in the same manner as champagne corks. Other substances may be also extracted by this simple apparatus.

Wilson's Process of Preparing Glycerine. Palm-oil is placed in a distilling apparatus and high-pressure steam of 500° to 600° F. introduced. The palm-oil is decomposed and two layers are obtained in the receiver; one watery, containing the glycerine, and one upon which float the fatty acids. Care must be exercised during this operation that there is a constant supply of steam and that the temperature does not rise too high, as, if this is the case, acrolein may be formed. By concentrating, and, should the product not be entirely colorless, repeated distillation, the glycerine can be obtained pure of 1.26 specific gravity.

To Restore Faded Manuscripts. I. Prepare a moderately concentrated watery solution of tannin (gallotannic acid); apply the solution with a brush, remove the excess by a current of water, and dry the document at a temperature of 150° to 165° F. The writing developed in this manner is clear and very

black, remaining so after the lapse of many months.

II. Add a few drops of ammonium sulphide to clear water and apply the solution to the manuscript, proceeding as above. Both of these formulæ are based on the supposition that the ink used on the faded characters was an iron ink, which will commonly be the case. (W.)

CLEANSING, POLISHING, AND RENOVATING AGENTS.

To Remove Ink Stains from Wood. Prepare a mixture of 8 ounces of concentrated sulphuric acid and $1\frac{1}{2}$ pints of water. Scour the stain thoroughly with water and sand, then pour some of the mixture upon it and rub until the stain has disappeared.

To Remove Ink and Rust Stains from Clothes. Instead of using oxalic acid, which attacks the fibre of the texture, prepare a mixture of 2 parts of tartar and 1 of powdered alum. This does not injure the clothes; it may also be used for removing other stains.

To Remove Mildew, Wine, or Fruit Stains from Silk or Linen. Cut 1 pound of ordinary good soap into shavings and boil them into a stiff paste with rain water. Apply this to the stain and scatter upon it some finely-powdered potash. Then spread the goods upon a grass plat and allow them to remain there for 24 hours. When dry sprinkle some rain water upon the stain and wash, when the stain will have disappeared.

To Remove Tar, Grease, Oil, and Varnish from Silk. Rub the stain with a white cloth moistened with a mixture of equal parts of oil of turpentine and ether, until no impure matter adheres to it. Cover the stain about the thickness of a knife blade with pulverized white bole, upon which place blotting-paper and press a hot iron. Repeat until the stain has disappeared.

To Remove Ink Stains from Silk. Moisten the stain with strong white wine vinegar and rub some warm beech-wood ashes upon it, and finally wash with soap water. Should the color suffer from the vinegar, mix some beef gall and water and wash the stain with it.

To Remove Wax from Velvet. Lay the velvet upon a table, cover the stain with a linen cloth soaked in soft water and rub several times with a medium hot iron. The stain will disappear.

To Remove Grease Stains from Paper. Warm the stained paper, lay blotting-paper upon the grease spot, and press it gently with a hot iron. Or, heat rectified oil of turpentine to the boiling point and cover both sides of the stain until it can no longer be seen. Then dip a small brush in strong spirit of wine and brush the spot several times where the stain has been. This restores the original whiteness of the paper, and, when ironed, gives it smoothness and lustre.

Scouring Water for Removing Grease Stains. Put 4 parts by weight of rectified oil of turpentine, 1 part by weight of anhydrous spirit of wine, and 1 part by weight of ether, free from acid, into a clean, dry bottle; shake thoroughly and close the bottle hermetically. When the water is to be used, place blotting-paper under the stained places, moisten a cotton rag with the fluid, and rub until the stains have disappeared. Dry the goods in the shade, but exposed to the air.

One application will be sufficient for fresh stains, but old spots require several.

Le François' Scouring Fluid. This is prepared from the root and dried leaves of soap-wort, of each 64 parts, clarified juice of lemons 45 parts, spirit of wine 185 parts, soft water 1700 parts. The root is coarsely powdered, boiled in the water for $\frac{1}{4}$ of an hour, the leaves cut fine are added, and the boiling is continued for 24 hours. It is then strained, filtered, and allowed to become cold, when the spirit of wine is added.

The fluid is used either cold or luke-warm by dipping the stained place into it, rubbing it with the hand to a lather when silk goods are to be cleansed, or with a brush for linen or cotton goods. Rinse in clean water and iron nearly dry.

"Gantein" for Cleansing Gloves. The preparation sold under this name is prepared in the following manner: Dissolve 6 parts of soap in 2 of water. Add 4 parts of bleaching liquor and $\frac{1}{2}$

of aqua ammonia. Rub the gloves with this fluid until they are clean.

To Cleanse Glasses and Saucers. Moisten the places to be cleansed with concentrated sulphuric acid, scatter finely-powdered potassium bichromate upon them, and let the vessel stand in a warm place for several hours. All vessels to which organic substances adhere can be cleansed in this manner.

Lougel's Polishing Powder for Gold Workers. This powder, used by Belgian gold and silversmiths, gives an excellent lustre to the articles. It consists of:

	Parts.		Parts.
White lead . . .	4 $\frac{3}{10}$	Alumina . . .	4 $\frac{3}{10}$
Chalk	17 $\frac{3}{10}$	Silica	2 $\frac{6}{10}$
Carbonate of magnesia . . .	1 $\frac{7}{10}$	Ferric oxide . .	1 $\frac{7}{10}$

To Cleanse Glass Vessels. Animal charcoal is the best agent for cleansing glass vessels from rosins and ethereal oils. Pour a small quantity of alcohol into the vessel, swing it to and fro to moisten the inner surfaces, put in the animal charcoal, add water, and shake thoroughly.

To Cleanse Manilla Indigo. Pulverize the indigo and make it into a paste with water, upon which gradually pour hydrochloric acid until the effervescence ceases. Allow the mass to settle, filter, and wash the precipitate several times with pure or alkaline hot water; then press and dry.

To Cleanse Files. Pour a few drops of benzole upon a scratch brush, or upon the file, and remove the accumulated impurities by brushing.

To Cleanse Paint Brushes from Dried-in Paint. Suspend the brush in a tumbler containing a solution of 1 part of crystallized sodium carbonate in 3 of water, in such a manner that it hangs several inches from the bottom of the tumbler. Let it stand from 12 to 24 hours in a moderately warm place (140° to 150° F.). The dried paint will be softened so much that it can be easily washed out with soap and water. Brushes which have become as hard as stone can be restored by this process.

To Cleanse Fine Steel and Iron Articles from Rust. 1. Mix 10 parts of tin putty, 8 of prepared buck's horn, and 25 of spirit of wine to a paste. Cleanse

the articles with this and finally rub with soft blotting-paper.

2. If the iron is very rusty pour a mixture of 1 part of diluted hydrochloric acid and 1 of water over it, rub with it, wash, dry, brush it with oil, and allow it to lie for a few days. It is then cleansed in the manner indicated in No. 1.

To Cleanse Barrels. Bring a few pounds of unslaked lime into the barrel, add water and close it. After a little while add more water and roll the barrel. Then rinse out with clean water.

Polishing Powder for Glass and Metal. Ferric oxide obtained from ferrous oxalate by heating can be recommended as an excellent polishing agent for lenses of optical instruments, metals, etc.

To Cleanse Straw Hats. Straw hats, not very yellow, are first rubbed with flowers of sulphur and a cloth moistened with whiskey. When dry they are brushed and coated on the wrong side with gum water.

Very yellow straw hats are cleansed by making a lather of fine French soap upon a flannel rag moistened with lukewarm water. This is applied to the hat, and the latter rubbed with it until all dirt has been removed. The hat is then rinsed off with clean water, wiped off with a clean cloth, and sulphured, which can generally be done in a quarter of an hour. It is then covered with a sheet of fine paper and pressed.

Excellent Scouring Soap. Dissolve 4 $\frac{3}{4}$ ounces of Castile soap in spirit of wine, add the yolks of 4 eggs and 4 fluid drachms of oil of turpentine.

Scouring Soap for Wine and Vinegar Stains. Mix 2 $\frac{1}{2}$ ounces of white soap, 1 fluid drachm of oil of turpentine, and 25 grains of sal-ammoniac.

Scouring Soap for Cotton and Silk Goods. Mix 1 pound of ordinary soap, $\frac{1}{2}$ pound of beef-gall, and 1 $\frac{1}{2}$ ounces Venetian turpentine.

Black Scouring Soap for Removing Stains from Silk, Cloth, and Hats. Cut $\frac{1}{2}$ ounce of Venetian soap into fine shavings, moisten them with fresh rain water, and add 10 to 12 drops of oil of tartar. The mass is intimately kneaded together and formed into balls.

Green Scouring Soap. Knead 2 $\frac{1}{4}$

ounces of Venetian soap into a dough with the hand, add 20 grains of powdered verdigris, the same quantity of cream of tartar, and finally 15 drops of filtered lemon juice. Mix the ingredients intimately together, form balls from the mass, and allow them to dry at a moderate temperature.

The stains are moistened with water, rubbed with the soap-ball, and when the spots are again dry are washed with soft water. The process must be repeated twice or three times, and the goods rubbed with the nap with a linen cloth.

Brown Scouring Soap. Cut 2½ ounces of Venetian soap into shavings, moisten them with a little water, and work the mass into a dough with the hand. Then add 20 grains of powdered white vitriol, the same quantity of powdered red bole, 7 grains of lampblack, and 10 drops of spirit of sal-ammoniac. Form the mass in balls of the desired size, and dry them at a moderate heat.

To remove stains the soap is used in the same manner as the foregoing.

To Purify Bisulphide of Carbon. This can be conveniently and quickly done by the following process: Cover the bisulphide of carbon with water and add gradually small quantities of concentrated solution of potassium permanganate. Shake every time after adding the solution. If the water standing over the bisulphide of carbon retains a violet color, no more potassium permanganate is added. Wash now with water until the potassium salt has been removed, separate the bisulphide of carbon from the water by decantation or other means, and filter it.

Polishing Powder for Plate-glass, Mirrors, etc. Calcined magnesia is moistened with pure benzine, so as to form a paste sufficiently wet, that, when pressed, a drop will exude from it. Pure benzine being very volatile (it boils at 177.8° F.) the mixture must be kept in glass bottles with ground stoppers. The articles are cleansed by taking some of the mixture upon raw cotton and rubbing.

Polishing Rags for Metals (called "*Serviette Magique*"). These consist of calico prepared with Castile soap and rotten stone and dyed with a solution of coralline in alcohol.

English Polishing Paste for Metals. Take finely-powdered rotten stone, sift it through muslin or a hair sieve, and knead with a sufficient quantity of soft soap to form a stiff paste. To ½ pound of this mass add 1½ fluid ounces of oil of turpentine. Put in boxes or form into balls, which soon become hard.

The articles to be polished must be entirely free from grease and dirt. Moisten some of the paste with water, apply it to the metal, and rub with a dry rag, when a beautiful lustre will be the result. This is well adapted for household purposes.

French Polishing for Metals. Mix 1 part of washed ferric oxide with 50 parts of magnesium carbonate. Moisten a rag with water or alcohol, dip it into the powder, rub the articles thoroughly, and dry them with soft leather.

Polishing Paste for Metal, Glass, etc. Mix 1 part of olive oil, 1 of spirit of sal-ammoniac, 2 of lime, and 1 of water to a thick paste.

Wabek's Polishing Wax. Melt 4 parts of yellow wax and 1 of rosin; stir the mass vigorously, and when taken from the fire stir in 2 parts of the best oil of turpentine. Pour the mass into moulds. Apply a little of it on a woollen rag and rub the wood, furniture, etc.

Fine Jewellers' Rouge. Saturate a solution of sulphate of iron (green vitriol) with a solution of oxalic acid. Filter and dry the resulting precipitate of pale-yellow oxalate of iron; place it in an iron dish and expose it to a moderate heat, whereby the oxalic acid will be decomposed and expelled, and a pure sesquioxide of iron will be left. This is very fine and can be used for producing a very brilliant polish upon the finest jewellers' work.

To Remove Stains from Books. A solution of oxalic acid, citric acid, or tartaric acid may be used without danger, as these acids do not attack printing ink, but will remove marginal notes in writing ink, stains, etc.

To Free Paper from Fatty Substances. Photographic paper can be cleansed from all impurities by the following treatment: Dissolve 1 part of nitric acid in 20 of distilled water, pour the solution into an earthen dish, and soak the sheets of paper for 1 hour in the

fluid, when they are placed in water made alkaline with 5 per cent. of ammonia, and are finally washed in pure water and dried.

To Cleanse Gloves without Wetting Them. Put the gloves upon a clean board, make a mixture of dried fuller's earth and pulverized alum, and apply the powder to both sides of the glove with an ordinary stiff brush. Then wipe the powder off, cover the glove with dry bran and brush this off. The gloves, if not very badly soiled, will, by this process, become entirely clean.

Should there be grease stains, remove them with crumbs of toasted bread and powdered animal charcoal, and then rub the glove with a clean woollen rag dipped into the powder of fuller's earth and alum.

To Cleanse Tea and Coffee Trays. Do not pour hot water upon them, especially if they are lacquered, but wipe them with a sponge dipped into tepid water, and then rub with a cloth. Should they have a smeary appearance dust a little flour over them, and then rub them with a dry cloth.

To Cleanse Marble Busts. First free them from all dust, and then wash them with very weak hydrochloric acid. Soap injures the color of the marble.

To Cleanse Alabaster. Rub the alabaster carefully with shave-grass, and then with Venetian soap and chalk, stirred into a paste with water.

To Cleanse Precious Stones. Apply precipitated sulphur moistened with spirit of wine, and rub with a very soft brush.

To Cleanse and Beautify Old Oak Furniture. I. Wash the furniture, in case it has any grease stains, with warm beer.

II. Boil wax and sugar in beer and rub the furniture with this by means of a brush. When dry rub until the article shows the desired lustre.

Brass is cleansed by rubbing it with spirits of ammonia and vinegar, and then with blotting-paper soaked in spirit of wine.

Silver is cleansed by placing the articles for a few minutes in a boiling hot solution of tartar, and then rubbing them with soft leather.

Polishing Powder for Silver-ware, etc.

Mix intimately 4 parts of washed pipe-clay, and 1 of purified tartar.

Gold is cleansed with Paris red and soft leather.

To Polish Slate (Magnus' Patent). Mix intimately 7 parts of linseed oil, 1 of ground ochre, 3 of tar oil, and 1 of asphaltum. Apply the mixture to the surface of the slate by means of a brush, then submit the article to a heat of about 200° F., when it is cooled off and polished with pumice stone and tripoli.

COLORED CHALKS (CRAYONS), PENCILS, AND INKS FOR MARKING LINEN, ETC.

Colored chalks (crayons), besides beauty of color, must possess a certain degree of solidity, *i. e.*, they must be neither too hard nor too soft.

In choosing the white or ground body the chemical nature of the coloring substances to be mixed with it must be taken into consideration. For instance, Paris and Berlin blue, lakes, chrome yellow, etc., must not be mixed with chalk, as this would injure the color.

Plaster of Paris, alabaster, alumina, and chalk are most suitable for the white ground mass. White lead, zinc white, bones burned white, and pearl white may also be used, but as a general rule are too expensive.

Oil, wax, and fats serve as agglutinants. The finished and dried chalks are dipped in oil, by which they become softer and color better.

Gum tragacanth is much used as an agglutinant. Soap water is used for many colors, as also yeast from beer which has not been hopped. Glue and gum are best for cinnabar; and, for pigments which become hard in drying, oatmeal gruel.

The pigments are made into a paste with water and divided into three equal portions. The first portion is mixed with agglutinants for finest crayons. The second portion is mixed with white substances for lighter colors, and the third mixed with other desired pigments.

Small boards covered with 5 or 6 sheets of waste paper, and on the top of this a sheet of white printing paper,

are used in making chalks from the first portion of the pigment. The process is as follows: The ground pigment is spread upon the board, and, as the paper with which this is covered absorbs much of the moisture, it will acquire considerable consistency. When it has become sufficiently dry to allow of it being treated with the hand without sticking, a piece of the size of a hazel-nut is formed into a ball and rolled out between the hands into a cylinder pointed on both ends. The cylinder is then rolled between smooth boards to make the surface smooth and even. It is then laid upon another board, covered with paper, and dried in the shade.

The second portion is rubbed with half the quantity of a white body and formed into cylinders of a lighter color.

The last part of the pigment is used for mixing with other colors.

Blue Chalks. Paris blue gives the dark shades. To prevent the chalks from becoming too hard the following process is used: Paris blue, finely pulverized, is treated with concentrated sulphuric acid, which decolorizes it. Washing it in water restores the color and deposits a fine sediment, which is mixed with equal parts of alumina and calcareous earth.

Cobalt Blue and Nürnberg Ultramarine give excellent crayons.

Brown Crayons. Brown ochre with lampblack, terra japonica, umber with chalk, liquid gum and beer yeast, etc.

Crimson Crayons. 1. These are prepared from madder lake, round lake, and alumina, with beer yeast, oatmeal gruel, milk, or gum water as agglutinants. 2. Mix 4 parts of chalk with 1 of calcareous earth, and color with a decoction of cochineal and alum. Very beautiful crayons are manufactured from 2 parts of scarlet ochre and 1 of carmine mixed together with milk, oatmeal gruel, and gum tragacanth. Carmine and pearl white also furnish very fine crayons. Ordinary crayons are prepared from red chalk, red bole, colcothar, etc.

Yellow Crayons. Yellow ochre, chrome yellow, or turpeth mineral are used, either by themselves or rubbed with chalk and mixed with gum water or beer yeast.

Green Crayons are prepared from green earth (mountain green) with chalk and beer yeast; or mixtures of Berlin blue and chrome yellow, or yellow lake and Schweinfurt green, or green ultramarine.

Red Crayons. Red crayons are made from cinnabar, red lead, and beer yeast. The ingredients are boiled until a viscous mass has been formed; then add gum tragacanth.

Black Crayons. These are prepared from willow-wood charcoal, finest quality of lampblack or boneblack, with an addition of a small quantity of Paris blue and an agglutinant.

White Crayons. Pure white chalk is cut into crayons, or they are made from white lead, zinc white, or zinc oxide stirred into a dough with milk.

Pencils for Writing Upon Glass. Melt in a saucer:

Spermaceti	4 parts.
Tallow	3 "
Wax	2 "

Add to this, with constant stirring:

Red lead	6 parts.
Potash	1 part.

Continue to heat the mass for half an hour and then pour it into small glass tubes the size of a lead-pencil. When the compound has become cold it is forced into small wooden tubes and sharpened with a knife.

Pencils for Marking Linen. Eight parts of alumina are thoroughly dried and mixed with 2 parts of very finely powdered pyrolusite. Add to these a solution of 3 parts of nitrate of silver in 5 of distilled water, and mix the mass intimately by rubbing and kneading. Pencils are formed from this mass and dried, and used for marking linen, either in this form or enclosed in wood like a pencil.

The alumina is prepared by precipitating a solution of alum with ammonia. But pure clay may also be used instead of alumina.

Marking Ink for Linen. To use this ink it is necessary to soak the linen with a fluid consisting of 1 part of sodium hypophosphite, 2 of gum Arabic, and 16 of distilled water. When the linen is dry it is smoothed and marked with an ink consisting of 1 part of silver

nitrate, 6 of gum mucilage, and 6 of distilled water.

New Marking Ink. An excellent marking ink can be obtained from the anacardium nut (*Anacardium orientale*). The juice contains an oily matter which becomes black on exposure to the air, is proof against all known detergents; decolorizes acids, alkalis, cyanide of potassium, and chlorine. If linen is marked with this natural ink and then moistened with a little ammonia, the black becomes very intense and is perfectly permanent.

Red Indelible Marking Ink. Equal parts of green vitriol and cinnabar are powdered as fine as possible, bolted, carefully mixed with good linseed oil, and finally strained through a cloth. The resulting thickish fluid is used for marking. It is best to do this with a quill.

Brown Indelible Ink. Brush the linen with a solution of 2 parts of yellow prussiate of potash and 3 of gum Arabic in 12 parts of water. When dry mark it with a mixture of equal parts of manganous hydrate and water.

Blue Indelible Ink. Mix together:

Sesquioxide of molybdenum	5 parts.
Oxalic acid	6 "
Gum Arabic	6 "
Powdered licorice	2 "
Water	9 ounces.

Mark the linen with this and moisten the writing with solution of tin salt.

Black Indelible Ink. Mix together 2.5 parts of lunar caustic and a like quantity of tartar with 10 parts of spirits of sal-ammoniac, and add to the mixture a solution of 0.6 part of sugar, 1 of gum Arabic, and 0.1 of lampblack in 10 of water.

No. 2. Dissolve 5 parts of lunar caustic in 10 of spirit of sal-ammoniac. Add to the solution 7 parts of pure soda, 5 of gum Arabic, and 12 of water.

No. 3. Dissolve 1.7 parts of chloride of copper, 2.1 of sodium chlorate, and 1.1 of sal-ammoniac in 12 of water. Next dissolve 24 parts of aniline hydrochlorate in 40 of water, and add to this 24 parts of gum mucilage and 12 of glycerine. When the ink is to be used 1 part of the first solution is mixed with 4 of the second.

Blue Stamp Color. *Bleu de Lyons*

is dissolved with the aid of gentle heat in concentrated glycerine; some of Thenard's blue added, and the liquid thickened with finely-powdered gum Arabic.

CONFECTIONERY.

The sugar used in the manufacture of all kinds of confectionery must be boiled until it "breaks;" that means until a sample, when taken from the boiler and dropped on a plate of glass, breaks off when cold.

To Prepare Elaeosaccharum, or Oil Sugar. This is generally prepared by thoroughly mixing in a porcelain mortar $\frac{1}{2}$ ounce of sugar with 12 drops of any ethereal oil; for instance, the oil of anise seed, lemon, fennel, peppermint, etc.

Malt Sugar. Boil for half an hour over a moderate fire, 2 pounds of brown sugar and 2 pounds of sugar-house molasses; then add $1\frac{1}{2}$ ounces of extract of malt and 60 drops of tincture of vanilla. Allow the mixture to boil up once more, and then pour it, while in a liquid state, upon a marble slab, mixed with a moderate quantity of oil of almonds. When half cold the sugar is cut into strips and these twisted into spirals.

Orange Sugar. Dissolve 2 ounces of tartaric acid or citric acid in $12\frac{1}{2}$ ounces of fresh orange juice, and drop the solution upon a sugar-loaf weighing 10 pounds placed with the pointed end downward. The sugar-loaf is left in this position until the solution has soaked through to the pointed end, which can be easily recognized by the darker color of the moistened places. This simple method of impregnation can of course be also used for the preparation of many varieties of finely flavored sugars, for instance vanilla, rose, strawberry sugar, etc., by employing either watery or alcoholic extracts of spicy substances or solutions of ethereal oils in spirit of wine.

Pectoral Troches, prepared according to the following receipt, can be highly recommended: Mix $\frac{1}{2}$ ounce of sal-ammoniac, 80 grammes ($2\frac{3}{4}$ ounces) of pulverized licorice, 1 ounce of sugar, 30 grains of gum tragacanth, and $1\frac{1}{2}$ fluid drachms of glycerine, with a sufficient quantity of water to form a paste. Roll

this upon a marble slab rubbed with oil into tablets $\frac{1}{4}$ to $\frac{1}{2}$ inch thick, cut these into rhombic troches from $\frac{1}{4}$ to $\frac{1}{2}$ inch square, and allow them to dry. If desired the troches can be wrapped in silver foil. Confections are now wrapped in a glycerine paper or paraffined paper. They should be kept in tin boxes.

Pectoral Bon-bons. Take 2 parts of Iceland moss, 2 of common red poppy flowers, 2 of endive, and 1 of marsh mallow, and boil them once up in water. Let the decoction stand for half an hour; then press it out, and boil it to a caramel with 90 parts of sugar; then it is treated in the same manner as other bon-bons.

Raspberry Bon-bons. Take 3 tablespoonfuls of juice of preserved raspberries, then boil about 2 pounds of sugar until it "breaks," pour the juice and 4 drops of essence of raspberry into it, and let it boil up once more.

Carrot Bon-bons. Scrape 4 large carrots, grate them, and strain through a cloth. The juice pressed out is added to 2 pounds of sugar and boiled to caramel.

Cream Bon-bons. Boil 3 pounds of sugar until it "breaks," and then add 1 cupful of good cream. Let the sugar boil up repeatedly, and add 2 drops of fine oil of cinnamon.

Malt Bon-bons. Boil 1 pound of roasted barley malt with $1\frac{1}{2}$ pounds of water until it is reduced to half the quantity; strain the infusion, and clarify with it 1 pound of sugar boiled until it "breaks." Then pour it upon a marble slab rubbed with olive oil or unsalted butter, and, before it becomes cold, cut it with a knife into square pieces.

Cream Walnuts. Take the white of 1 egg, stir into it powdered sugar to make it stiff enough to handle, and flavor with vanilla. Dip the walnuts into a syrup made of two tablespoonfuls of sugar and 1 of water, boiled for 3 or 4 minutes. The cream must be moulded between the fingers, and then placed between the two halves of a walnut. To make *chocolate cream walnuts*, stir 2 tablespoonfuls of dissolved chocolate into the cream.

To Prepare Bon-bons of Caramel Sugar with Soft Filling. Pour the

melted caramel sugar upon a marble slab and place the filling upon it. Then fold the sugar over the filling and join the two sides by pressing. A package is formed which, by drawing out, is made into a roll. This is placed at once upon the board A (Fig. 10), covered

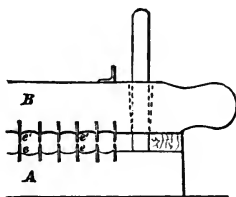

Fig. 10.

with steel plates *e*. Then the board B, covered with steel plates *e'* analogous to *e*, is vigorously pressed against A, by which the roll is divided into bon-bons, which, shortly after the pressing, are broken apart.

SWEETMEATS (CONSERVES).

Chocolate Sweetmeat. Boil 2 pounds of sugar. Then rub $4\frac{1}{2}$ ounces of vanilla chocolate, put it into a small vessel, sprinkle some of the boiled sugar over it, stir them thoroughly together, and add to the other sugar, mixing thoroughly with it. The mass is done as soon as a crust is formed on the surface of the sugar, or when no bubbles arise; a ladleful of sugar is then taken from the boiler and allowed to flow back into the mass. It is then poured into capsules about $\frac{1}{2}$ of an inch deep. The mass after having been allowed to cool for a short time is marked off with a knife into sticks about $\frac{1}{2}$ inch wide, and when entirely cold the capsules are turned over and moistened with a sponge, when the paper will be easily detached.

Orange Sweetmeat. Two pounds of sugar and 2 oranges. Treat in the same manner as above.

Another Receipt. Bring 2 pounds of pulverized loaf-sugar into a scoop, pour orange-blossom water over it, and stir

to a thick paste. Place this over a moderate coal-fire and, with constant stirring, make it quite hot, but do not allow it to boil. Then pour the mass into paper capsules and mark it into square or oblong pieces.

Orange-Blossom Sweetmeat. Clear and boil 3 pounds of loaf-sugar, add a good handful of selected orange blossoms somewhat cut up, and let it boil up once. When the sugar has settled, rub it with the ladle on the edge of the boiler until it becomes white; scrape this white sugar from the edge, stir it up with the rest of the sugar, and continue this operation until all the sugar is white and thickish, but not more so than that it can be conveniently poured out. It is then poured into capsules of paper and treated as above.

Rose Sweetmeat. Convert powdered sugar into a thick mass by adding rose-water; dilute a little carmine or cochineal with rose-water, and add a sufficient quantity of it to give a rose-color to the mass. The further treatment is the same as above.

Jasmine Sweetmeat is prepared in the same manner as rose sweetmeat, with the exception that no color is used, and distilled jasmine water instead of rose-water.

Carnation Sweetmeat. Take the flowers of dark red carnation, which generally have a strong odor, and place them with a few cloves or some essence of cloves in a tin box. Pour sufficient hot water over them to cover the leaves, close the box with a cover, and let it stand on a warm stove for 6 to 8 hours. Then press the contents through a napkin, and proceed in the same manner as given for orange-blossom sweetmeat. If essence of cloves is used it is added after the carnations have been pressed.

Vanilla Sweetmeat. Pound 2 vanilla beans into small pieces and place them in a tin box or earthen pot. Now pour $\frac{3}{4}$ pint of hot water over them, close the box as tight as possible, and let it stand over night. Then strain the contents through a napkin, add 2 pounds of loaf-sugar, and proceed as above.

Filbert Sweetmeat. Pound $4\frac{1}{2}$ ounces of peeled filbert kernels with sufficient water to prevent them from becoming oily; boil 1 pound of sugar, stir the nuts into it gradually, so as to prevent

their lumping together, and pour the mass into paper capsules; after cooling make it into strips and remove the paper.

Heliotrope Sweetmeat. Pour a cup of boiling water over a handful of rinsed heliotrope blossoms placed in an earthen pot. Close the pot tight, and let it stand for 2 hours in a moderately warm place. Strain the liquor of the heliotrope blossoms over pulverized sugar, and add a few drops of lemon juice and enough water to make a medium thick paste, and proceed as above.

Angelica Sweetmeat. Cut the young stems and shoots of angelica into finger-lengths and powder them in a mortar, and pass through a fine sieve. Flavor pulverized sugar with the angelica powder, and add water to make a medium thick paste, and treat as above.

Another Receipt. Put pulverized loaf-sugar in a pan, add a few table-spoonfuls of angelica seeds and form the mixture into a thin paste. For the rest proceed as above.

Lemon Sweetmeat. Mix pulverized loaf-sugar with a sufficient quantity of lemon juice to form a stiff paste, and proceed as above.

Another Receipt. Rub 2 to 3 lemons with 2 pounds of sugar, boil this, and treat the mass as above.

Cinnamon Sweetmeat. Boil 2 pounds of sugar, add powdered cinnamon; stir in the sugar uniformly in the manner indicated above, until it forms a quite thick mass, and then pour it out.

Cherry Sweetmeat. Pulverize 2 pounds of sugar, add sufficient fresh cherry juice to form a thick mass, and make it hot without allowing it to boil, stirring constantly in the meanwhile; then pour the mass out, and, when cooled off somewhat, mark it with a pointed knife into sticks about half an inch wide.

Peppermint Sweetmeat. Pulverize 2 pounds of loaf-sugar, stir it with water to a thick paste, and heat this over a gentle coal fire, stirring it constantly. When hot, take it from the fire, add 6 drops of oil of peppermint, stir it up several times, then pour it out and mark it into oblong sticks.

Love Sweetmeat. Pulverize 3 pounds of loaf-sugar, 2 ounces of ginger, $\frac{1}{2}$ ounce

of oriental saffron, $4\frac{1}{2}$ grains of musk, $1\frac{1}{2}$ grains of ambergris, $7\frac{1}{2}$ grains of cloves, and a like quantity of cubebs. Then put 1 ounce of apricots in a glass, pour boiling water over them and let it stand for 3 hours, then strain it through a cloth, and add to the liquor 3 grains of tincture of mastie. With this mixture stir the ingredients given above into a thick paste.

Sweet-Smelling Sweetmeat. Mix 2 pounds of pulverized sugar with 10 drops of essence of mignonette, 10 drops of essence of tuberose, 10 drops of essence of jasmine, 4 drops of essence of ambergris, and 4 drops of essence of musk. Stir this mixture into a paste with orange-blossom water and pour it out.

Violet Sweetmeat. Pour 1 pound of boiling water over a handful of cleansed violet leaves in a porcelain pot, which close tight and let it stand in a warm place over night. Then filter and pour the filtrate upon 2 pounds of pulverized sugar, and proceed as above.

All these sweetmeats are poured into paper capsules and marked in sticks with a pointed knife, as indicated above, or are dropped in round drops upon metal plates.

MEDICINAL SWEETMEATS.

Spoonwort (Scurvy Grass) Sweetmeat. Convert 1 part of fresh spoonwort into paste by rubbing it with a wooden pestle in a marble mortar, and then work 2 parts of sugar into it.

Water Cress Sweetmeat. 1 part of fresh leaves of water cress and 2 parts of white sugar. The manner of preparation is the same as above.

Antiscorbutic Sweetmeat. Take equal parts of spoonwort, water cress, leaves of feverfew, juice of Spanish radish, juice of oranges, add the necessary quantity of pulverized sugar, and proceed as above.

Crème du Café. One ounce of roasted Mocha coffee is made into coffee in the ordinary manner with $\frac{1}{2}$ pint of boiling water, and poured upon 3 pounds of boiling sugar. Then add 2 cupfuls of rich cream, and boil the sugar to caramel. Now add 2 ounces of fresh butter, let the mass boil up

several times, and then treat it in the same manner as other bon-bons.

Crème du Chocolade. Boil 3 pounds of sugar and add 1 cupful of ordinary boiled chocolate. Then add 1 cupful of rich cream, boil the sugar to caramel, and add 2 ounces of fresh butter. Let the mass boil up several times, and then treat it in the same manner as other bon-bons.

Coated Filberts. Remove carefully the kernels of large filberts from the shells, put them on small wooden sticks, dip them into caramel sugar, and then treat them in the same manner as other filled bon-bons.

Roasted Almonds. Boil $1\frac{1}{2}$ pounds of sugar with $\frac{1}{2}$ pint of water until it draws threads. Then add 1 pound of selected almonds, and stir the mixture over the fire until the almonds begin to crack. Now take the boiler from the fire, and stir until the sugar becomes white and mealy, then pour it out upon a metal plate and pick out the almonds. The remaining sugar is put back into the boiler, stirred with water into a thin paste, and a trifle of cinnamon and a few drops of cochineal are added. Then boil the sugar, pour the almonds into it and stir them quickly, so that all become coated with the sugar, when they are poured out upon a metal plate and allowed to cool.

Roasted Filberts. The kernels of large filberts are carefully taken from the shell. Two pounds of sugar are added to 2 pounds of kernels, and they are then treated in the same manner as given for roasted almonds.

Coated Chestnuts. Make an incision with a penknife into the shell of the chestnuts, and roast them in an oven until they begin to crack and the shell becomes detached. The chestnuts are then taken out, shelled, put on small wooden sticks, and dipped into hot sugar, and turned around in the hand for a few minutes until they are entirely cold. They are then placed upon a clean metal plate, the sticks are taken out and the chestnuts wrapped in paper.

Candied Cherries. Drain preserved cherries through a strainer, and place them for 2 days in a drying oven, when two of them are placed on a wooden stick and dipped in hot sugar caramel,

and worked for a few minutes in the hand and laid upon metal plates. The sticks are removed and the candied cherries wrapped in white paper. The same directions hold good for all other fruits, such as apricots, nuts, peaches, etc., with the exception that these are put singly on the wooden sticks.

Glazed Almonds. Boil 1 pound of sugar. Then place 1 pound of small selected almonds in the sugar, and boil until the latter is mealy, when the boiler is taken from the fire, its contents poured upon a metallic sheet, and the almonds are picked out. The remaining sugar is brought back into the boiler, stirred into a thin paste with water, and boiled until it draws threads, when the boiler is taken from the fire. Now pour the almonds into the sugar, stir them quickly, and, before the sugar congeals, pour them back upon the metal plate, so that they lie flat and at some distance from each other. Put the plate for a few minutes into a hot oven, and then for 6 hours in the drying oven.

Coated Orange Blossoms. Place $8\frac{3}{4}$ ounces of dried orange blossoms, 4 pounds of sugar, and $\frac{1}{2}$ pint of water on the fire, and for the rest treat in the same manner as given for roasted almonds.

Candied Oranges. Peel the oranges down to the fine white skin and then divide them carefully in 8 or more parts, so that the separate parts remain uninjured and the juice does not escape. Then put them on small wooden sticks, dip into caramel sugar, place them upon a metal plate, and when cold remove the sticks.

Peppermint Drops. Stir 2 pounds of pulverized sugar into a stiff paste, with very little water, and then dissolve it in a well-tinned copper pan provided with a spout and a handle. Stir constantly, and let it become hot without boiling. Then add a few drops of oil of peppermint and pour small drops from the spout of the pan upon a well-oiled metal plate. Should the mass in pouring out prove too liquid, place it again on the fire and add more sugar. If it is desired to have the drops very strong, they are placed in a box, sprinkled with oil of peppermint, and the box closed as tightly as possible.

Punch Drops. The sugar is stirred into a thin paste with equal parts of rum and lemon juice, so that the mass need not be heated as much, or else the rum would evaporate. They are dropped in the same manner as peppermint drops.

LOZENGES. Spice for Lozenges. Comminute to a coarse powder $1\frac{1}{2}$ ounces of cinnamon, $1\frac{3}{4}$ ounces of ginger root, $1\frac{3}{4}$ ounces of cloves, and $\frac{1}{2}$ ounce each of galanga, mace, and nutmeg, and sift the fine powder out. Keep this spice in well-closed bottles.

Chinese Lozenges. Make a syrup of 1 pound of white sugar with $\frac{1}{2}$ pint of water, and then stir quickly into it, while hot, $3\frac{1}{2}$ ounces of powdered China root, 1 ounce of comminuted preserved orange peel, and $\frac{1}{2}$ ounce of lozenge spice. Pour out and cut into lozenges.

Lemon Lozenges. Boil 1 pound of white sugar with $4\frac{3}{4}$ ounces of water; then stir into it 1 ounce of comminuted preserved lemon peel, 1 ounce of the yellow part of the peel of fresh lemons, 20 drops of oil of lemon, and 1 fluid ounce of lemon juice. Pour the mass out and cut it into lozenges. They have a very agreeable and refreshing taste and quench thirst.

Peppermint Lozenges. Make a syrup of 1 pound of fine white sugar with $\frac{1}{4}$ pint of peppermint water; stir into it while hot $1\frac{1}{4}$ ounces of finely powdered peppermint, $\frac{1}{4}$ ounce of lozenge spice, 1 ounce of peeled sweet almonds cut in thin pieces, and 1 fluid drachm of oil of peppermint, and form the mass into lozenges.

Ginger Lozenges. Make a syrup of 1 pound of fine white sugar with 1 gill of water, then stir into it $\frac{1}{4}$ ounce of powdered cinnamon, 1 drachm of powdered nutmeg, $\frac{3}{4}$ drachm of powdered mace, and 7 drachms of powdered ginger root, and cut lozenges from the mass.

Stomachic Lozenges. Make a syrup of 1 pound of white sugar with 1 gill of best rose-water. Then stir into it 1 ounce of preserved orange peel cut in pieces, a like quantity each of lemon peel and candied lemon peel cut in small pieces, and $1\frac{3}{4}$ ounces each of peeled sweet almonds and lozenge spice, and cut the mass into lozenges.

Cherry Marmalade. Boil, with fre-

quent stirring, for 8 hours 20 pounds of white cherries, 4 pounds of black cherries, and 8 to 12 pounds of sugar syrup. This will give a marmalade of excellent taste and preferable to the best jelly.

Iceland Moss Jelly. Soak and wash 2 ounces of Iceland moss and dissolve it in a like quantity of water in order to obtain a strong solution. Boil this for 1 hour, then strain, add 1 drachm of isinglass, and boil the whole until it has the proper consistency, and flavor with sugar and lemon juice. This jelly is used for coughs and asthma.

Isinglass Jelly. Soak $\frac{1}{2}$ ounce of isinglass in $1\frac{3}{4}$ pints of cold water for 12 hours; then add a like quantity of water and heat the mass gently, constantly stirring it, until all the isinglass is dissolved. If it is desired to obtain an entirely clear jelly, add the white of 1 egg before removing it from the fire.

Gelatine Jelly. Soak 1 ounce of gelatine in $\frac{1}{2}$ pint of cold water for 12 hours; then add a like quantity of water, and boil, while constantly stirring, until all is dissolved. Flavor with 2 cut lemons and sugar and wine.

Buck-horn Jelly. Wash thoroughly $8\frac{3}{4}$ ounces of rasped buck's horn, then boil it in $2\frac{1}{2}$ quarts of water until but $1\frac{1}{4}$ quarts remain, and strain it. Then add 2 ounces of sugar, the juice of 1 lemon, and the white of 1 egg beaten previously to a froth, with some water. The mixture is then boiled until it has the proper consistency, when the yellow part of the peel of 1 lemon is added.

Sago Jelly. Soak 1 ounce of sago for 1 hour in water; then boil it in $1\frac{3}{4}$ pints of fresh water until a clear solution has been obtained. Flavor with wine, sugar, lemon peel, and spices. The sago may also be boiled in milk instead of water.

Tapioca Jelly. Wash thoroughly $10\frac{1}{2}$ ounces of tapioca and then soak it for 5 to 6 hours in $1\frac{1}{4}$ pints of fresh water; add the peel of 1 lemon and place the whole on the fire. Boil slowly until a clear solution is obtained, and then flavor it with lemon juice, wine, and sugar.

Irish Moss Jelly. Wash the moss thoroughly and soak it in a suitable quantity of water. Then boil and strain it, and flavor with licorice, rock

candy, and lemon juice. It is used as a remedy in coughs and asthma.

Ground Mass for Crème (Crème Fondant). To a solution of 2 pounds of grape sugar add $\frac{3}{4}$ drachm of tartaric acid and a like quantity of bicarbonate of soda. The solubility and lightness of the mass is increased by an addition of some cream of tartar, but this is not absolutely necessary. The resulting thickly-fluid mass is worked in the usual manner for confectionery purposes.

Red Color for Coloring Sweetmeats, Jellies, etc. Syrup of cochineal is generally used. But a far more beautiful color, which is not affected by acids and alkalies, is obtained by preparing a syrup from kermes berries (*Phytolacca decandra*). It may also be used for coloring table vinegar, wine, liquors, etc.

Innoxious Green Color for Candies, etc. Digest $7\frac{3}{4}$ grains of saffron for 24 hours in $\frac{1}{4}$ ounce of distilled water. Dissolve, on the other hand, $3\frac{3}{4}$ grains of indigo carmine in $\frac{1}{2}$ ounce of distilled water. By mixing the 2 solutions together an intensely green color will be obtained. By boiling the coloring matter, compounded with sugar, to a syrup, it can be kept for months, or it may be evaporated to dryness in a porcelain or glass vessel.

Receipts for Preparing Bandoline or Ficauteur. I. Boil Iceland or Irish moss in water, strain, and perfume the fluid.

II. Boil $\frac{1}{2}$ teaspoonful of quince seed, 1 tablespoonful of flaxseed, and a pinch of white mustard seed in 1 pound of water until it is reduced to half the quantity, and perfume with oil of almonds.

III. Boil for 5 minutes 1 tablespoonful of flaxseed in $1\frac{3}{4}$ pints of water.

IV. Dissolve by heating $1\frac{1}{2}$ ounces of isinglass in 1 pound of water. Then add 2 ounces of proof spirit of wine and perfume with oil of almonds.

V. Digest 1 part of powdered gum tragacanth for 3 days in 30 parts of rose-water, then strain, and perfume the fluid with essential oil of rose or oil of almonds.

The above mixtures, if necessary, can be dyed with cochineal.

Baking Powders. I. Mix 9 parts of

bicarbonate of soda, 8 of tartaric acid, and 10 of pulverized orris root or rice flour.

II. Mix $2\frac{1}{2}$ parts of bicarbonate of soda, $\frac{1}{2}$ of bicarbonate of ammonia, 5 of alum, and 4 of arrowroot.

III. Mix 56 parts of carbonate of soda, 28 of tartaric acid, 112 of potato flour, and $\frac{1}{2}$ of turmeric.

A New Baking Powder consists of 180 parts of crude alum, 75 of bicarbonate of soda, and 50 of less basic phosphate of lime.

By *less basic phosphate of lime* is meant a product obtained by pouring an equal quantity by weight of hydrochloric acid of 10 per cent. over bones calcined white and ground to flour. By pouring water over this baking powder, carbonic acid and sulphate of potash and of soda are formed, while alumina is separated. As the alum is entirely decomposed the inventor of the powder considers it innocuous. Three-quarters of an ounce of powder suffice for 1 pound of flour. It is added dry to the ready dough.

COPYING AND PRINTING.

New Method of Copying Engravings, Drawings, and Designs. Place the sheet of paper on which the drawing is made on the top of a sheet of cardboard which has previously been exposed to vapor of hydrochloric acid, and on the top of the drawing spread a sheet of paper sensitized with an oxygen salt of silver. The double nitrate of iron and silver is one of the best for this purpose. The vapors of the hydrochloric acid rising from the pasteboard beneath pass through the paper at all points, except those at which the lines of the picture are found. The oxy-salt in the sensitized paper quickly becomes converted into chloride of silver; but those points at which the hydrochloric acid has not penetrated remain in their first condition. When the paper, treated in this manner, is laid on a plate of copper, or exposed to hydrogen, or vapor of phosphorus, the unchloridized parts blacken, and a perfect copy of the design is obtained, which may be afterwards fixed in the regular way.

Gelatino-graphy. A Cheap, Quick,

and Simple Process of Duplicating Drawings by means of the Printing-press. Cleanse the surface of a smooth zinc plate, and coat it with a paste of plaster of Paris and water, using a camel's-hair brush. When the coating is nearly dry, scratch the drawing upon it with a sharp-pointed instrument, cutting down through the plaster to the metal, so that all the lines and points shall show clear and sharp on the zinc plate. A rim of ordinary glazier's putty is then made around the zinc plate, and a gently heated mass prepared from bone glue and glycerine, such as is used for printers' rollers, is poured to about a thickness of $\frac{1}{4}$ to $\frac{1}{2}$ of an inch upon the matrix of gypsum. When entirely cold it is removed from the matrix, which is readily accomplished.

This gelatine plate reproduces the entire drawing in relief, like a wood-cut or zinc etching. It is attached to a smooth surface of glass or metal, placed in a frame with raised rim, and a plaster-cast is made of it, from which a stereotype plate or an electrotype may be made in the usual way, and made ready for the press. (W.)

Autographic Method of Printing.

The writing in autographic ink is transferred in the usual manner on a copper plate, and this is treated with a solution of salts of mercury, and then with metallic mercury. By this all the points left free by the automatic ink receive an amalgamated surface which does not take printing ink.

To Duplicate Writings and Drawings. A mass consisting of gelatine, glycerine, and water is spread upon water-proof paper. The original writing or drawing is executed with a solution of 100 parts of water, 10 of chrome alum, 5 of sulphuric acid, and 10 of gum Arabic, and transferred by placing it upon the water-proof paper. Solution of aniline color is then poured over this, and the excess removed with tissue paper. By placing clean paper upon the prepared paper, negative impressions of the original are obtained.

Solution of water-glass, or of astringent salts, may be used in place of the above ink.

Printing in Colors. In ordinary color printing as many plates or stones have to be used as there are varieties

of color. *Mr. Goeth*, of *Zurich*, has recently invented a process in which all the colors are printed at once with one stone. The colors used are fusible by heat. The most prominent color is first poured on a perfectly smooth marble slab, and the parts not to be covered with this color are cut out with a knife down to the surface of the marble. A second color is now poured in, and the parts not to be covered with it are cut out, and so on until the colors required are complete. The thickness of the coloring matter is determined by the number of impressions, and after each impression the plate is very slightly raised. The paper is moistened with turpentine, and the impressions may be made with nearly the same rapidity as those with one color only. The number of colors has a quite insignificant influence on the price of the prints, whereas the number of stones in the ordinary method raises the price enormously.

To Copy Drawings in Black Lines on White Ground. The following process has recently been patented by *A. Colas*, of *Neuilly, France*. Paper is prepared with the following solution: $\frac{1}{2}$ ounce each of sulphate of iron, sesquichloride of iron, gelatine, and tartaric acid in $10\frac{1}{2}$ ounces of distilled water. The paper, kept flat, is stored in a dark closet. When exposed to the light beneath a transparent drawing, the parts influenced by the light lose their greenish-yellow color. It is afterward dipped into a bath made of 7 ounces of gallic acid, $\frac{3}{4}$ fluid ounce of alcohol, and 1 quart of water. The greenish-yellow lines turn black at once, and the sheet requires only to be rinsed in water.

Cyanotype (Blue Prints). In a manual distributed by the *Department of Public Works*, of *France*, among the officials occupied with producing and copying plans and drawings, the following cyanotype processes are recommended:

I. Dissolve in 100 parts of water, 10 of sesqui-chloride of iron, and 5 of citric or tartaric acid. Paper dipped in this bath and exposed, after drying, under a transparent drawing gives, on development with yellow prussiate of potash, a blue negative.

II. Dissolve 10 parts of ferric-am-

monium citrate in 100 of water, and 10 parts of red prussiate of potash in 60 of water, and mix the two solutions. Paper dipped in this and, after drying, exposed to the light, gives a blue negative, which is fixed by simply washing it. The prepared paper should be kept in a dry place.

Atmography. *Garnier* coats a polished copper plate with solution of sugar and bichromate of ammonium, and, when dry, exposes it to the light under a diapositive and powders the plate with the finest dust of albumen. The plate is then exposed to vapors of fluoric acid, which are absorbed by the albumen, adhering only to the points of the copper plate which have not been exposed to the light. The plate treated in this manner is then quickly laid, with the picture side down, upon a glass plate which has been previously coated with solution of sugar and borax in water, and dried. The coating on the points touched by the absorbed fluoric acid becomes fluid and is dusted over with fusible color. The action is almost instantaneous, and the operation can be repeated several times with the same copper plate without subjecting it again to vapors of fluoric acid. Magnificent burned-in pictures are obtained in this manner.

Polygraphic Method. A solution of $\frac{1}{2}$ ounce of aniline color and 8 drops of glacial acetic acid in $3\frac{1}{2}$ fluid ounces of water is used as an ink in this process. Japanese paper, a copying press, and a smooth, polished zinc plate are used for producing copies. The paper, after the corners have been moistened, is spread out upon the zinc plate. On the top of the paper is placed a linen cloth first soaked in water and then wrung out, and on the top of this a sheet of water-proof paper. A cushion formed of ordinary paper by folding it several times together is pressed upon the zinc plate thus prepared. The side of the sheet written on is placed upon the sheet fastened on the zinc plate, and on the top of this a sheet of paper of the same size. The sheets of paper which are to receive the copy must be dampened. It is now pressed; in a few minutes the impression will be ready, which can be used at once for 20 to 25 copies. After the impression is drawn off the

Japanese paper is removed and the zinc plate washed and cleansed. If 4 pages of a sheet have to be copied the pages must be enveloped in sheets of paper, which will prevent the ink from one page depositing itself on the other.

The *Callograph*, an instrument invented by *Jacobsen*, of *Berlin*, for duplicating manuscripts, supplies a greater number of copies than by any other process, and in printers' ink, which makes them accepted by the Post Office, as printed matter, at cheaper postage than when written. The callograph printing plates are composed of gelatine, glycerine, and soap, and before using are washed with a mixture of tannin and glycerine, leaving a kind of tanning on the surface.

The manuscript is written with a fluid ink prepared from salt of alumina, which forms upon the plate a sebate of aluminous substance similar to that in lithography, capable of taking printers' ink. The plate should be moistened like a lithograph stone.

The *Hektograph*. A composition is made as follows: Best gelatine or glue, 1 part, is soaked over night in cold water and the excess of water poured off. The glue is then warmed in a water-bath with the addition of from 10 to 12 parts of glycerine, to which may be added 4 to 6 parts of finely-ground heavy spar and 1 part dextrine, thoroughly mixed with constant stirring. (In summer less glycerine should be used.)

This melted mixture is poured into a shallow metal pan or box of tin or zinc and allowed to cool, when it should have the tough, elastic consistency of a printers' roller.

The letter or sketch to be duplicated is then written or traced on a sheet of heavy paper with an aniline ink (which has great tinctorial qualities). When dry this is laid, inked side down, on the gelatine plate above described and subjected to moderate and uniform pressure for a few minutes. It may then be removed, when a copy of the original will be found on the gelatine plate, which has absorbed a large quantity of the ink.

The blank sheets to receive the copies are now laid one by one on the gelatine plate, subjected to moderate pressure

over the whole surface with a wooden or rubber roller, or with the hand, and lifted off by taking hold of the corners and stripping it gently with an even movement. If this is done too quickly or roughly the composition may be torn. Each succeeding copy thus made will be a little fainter than its predecessor. From 40 to 60 legible copies may be made in this manner. When the operation is finished the plate should be gone over gently with a wet sponge and the ink remaining on its surface soaked out. The superfluous moisture is then carefully wiped off, when the plate will be ready for another operation. A good purple hektograph ink is made as follows: Dissolve 1 part methyl-violet in 8 parts water and add 1 part glycerine. Gently warm the solution for an hour, and add, when cool, $\frac{1}{4}$ part alcohol. Or, take methyl-violet 1 part, water 7 parts, glycerine 2 parts. (W.)

Edison's Electric Pen. This ingenious method of duplicating written copy is the invention of Mr. Thos. A. Edison. The pen is a slender tube of metal within which is a steel needle which is slightly driven forward out of the tube many times per second by means of a small electro-magnetic engine carried at the other extremity, which engine is actuated by a voltaic battery. The operator slowly directs the pen by hand over a sheet of prepared paper laid on a smooth metal plate. At every blow of the armature the needle punctures the paper, and the result is, finally, the production of a stencil of the letter, design, etc., in which the words or lines are made up of dots so close together that at a little distance they appear to the eye as continuous lines. The sheets to be printed are overlaid by this stencil and an inked roller passed over it—the result being an impression of the letter, design, etc. A great number of copies may thus be produced from a single stencil. The apparatus comprises a compact and convenient printing frame. (W.)

The Cyclostyle. This new duplicating process is a substitute for the "Edison Pen," and does away with the use of a battery and other electrical appliances. The process is purely a mechan-

ical one. The essential feature of this invention is the pen. This consists of a suitable holder, carrying at one extremity a very small disk of hardened steel (or other suitable metal), with serrated edge and so mounted as to revolve freely. A sheet of prepared paper is laid on a smooth metal surface, and the letter, design, etc., to be duplicated is traced thereon with the cyclostyle. The fine serrations of the wheel, passing over the paper, produce an infinite number of minute punctures, identical with those produced with the "Edison Electric Pen." A stencil is thus produced from which any desired number of copies can be made by placing sheet after sheet beneath it and going over the stencil with an inked roller. Several thousand duplicates, it is claimed, may thus be obtained from a single stencil. This apparatus comprises a convenient printing frame. (W.)

DAMASKEENING STEEL.

Genuine Damask. Cut 8 sheets of steel 12 inches long, 1 inch wide, and $\frac{1}{2}$ inch thick. Now prepare 5 sheets of soft iron and 4 of brittle iron, of equal dimensions with the steel sheets. These are then joined together in the following manner: A sheet of steel is laid upon one of soft iron, upon this one of brittle iron, then one of steel, and so on to the seventh sheet, which should be one of soft iron. This bundle is placed in the fire and, without heating it over much, welded together. It is then squared and worked smooth under the hammer and brought to a white heat. One end is then placed in a vise, the other is grasped with a pair of tongs and the mass strongly twisted into the shape of a screw. It is then smoothed and wrought into a bar $\frac{1}{2}$ to $\frac{3}{4}$ inch wide and $\frac{1}{8}$ to $\frac{1}{4}$ inch thick. This is cut into 2 equal parts. A sheet of steel $\frac{1}{8}$ inch thick and as long and as wide as 1 of the 2 parts of the prepared bar is cut and placed between the 2 parts. The mass is placed in the fire and then beaten under the hammer to the thickness required for the articles to be manufactured. A pickle consisting of 1 $\frac{1}{2}$ pints of water, 1 ounce of aqua-fortis, 1 ounce of sal-ammoniac, and 4 $\frac{1}{2}$ drachms

of blue vitriol is now prepared in a copper vessel. Paint the places which are not to be damaskened with some kind of varnish, and place the articles manufactured from the prepared bar into the bath. When the pickle has taken effect they are taken out, rinsed off with cold water, and dried.

Imitation of Damask. Prepare a mixture of equal parts of good linseed-oil varnish, white rosin, and wax. Coat with this the iron, which should have been previously cleansed and polished, and draw with a pen the pattern usually used in damaskeening. Make a rim of wax around the pattern and pour nitric acid mixed with an equal quantity of lemon juice upon the pattern. As soon as the nitric acid assumes a brownish color pour it off, wash the iron thoroughly with water, and remove the varnish by melting. If the article is small, round, or has an uneven surface, place it for a few minutes in a mixture of 8 parts of water, 1 of nitric acid, and 1 of lemon juice, and allow it to remain until the fluid assumes a brownish color, when it is taken out and cleansed.

Damaskeening with Gold or Silver. There are two methods of practising this process. By one method the surface of the metal to be damaskened is roughened with a file; the artist, by his skill, causes to adhere to the roughened surface threads of gold or silver, which are applied and burnished down. Broad surfaces are produced by working the threads or wires side by side. Heat is applied, but the necessary degree requires great judgment. In the other method the surface to be damaskened is incised or cut into, the incision at the bottom being expanded. Into this channel gold or silver is introduced and beaten down.

DECORATION, ORNAMENTATION, ETC.

To Gild Glass. Make a paste of fine bole, burned ochre, umber, and copal varnish, and, to make the mass as fine as possible, strain it through a cloth.

Cleanse the glass to be gilded by rubbing it with pulverized chalk and a rag, and, when clean, avoid touching it with the naked hand. Then by means of a brush draw or paint the desired

decoration upon the glass with the above mass, fill it with water to prevent it from cracking, and expose it to a moderate heat. Protect the glass from dust and other contaminations. When it is sufficiently dry to allow of the gold leaf being applied, cut this with a finely-polished knife into the necessary shape and press it gently upon the glass. The glass is then protected against dust in the same manner as before, but heated somewhat stronger to burn the gold in. This gilding will adhere as well as fire gilding.

Gold for Illuminating. Procure a book of leaf gold; gently take out some of the leaves and grind them in a mortar with a little honey until it is thoroughly intermixed with the gold, then add a little water and work it again. Put the whole into a vial and shake it well. Let it stand quietly for an hour or two and the gold will deposit at the bottom of the vial. Pour off the liquid standing over the gold and add weak prepared gum in its stead, sufficient to make it flow freely from the pen or camel's-hair pencil. When required for use shake it occasionally.

To Gild Porcelain. Dissolve 1 ounce of gold in a mixture of $4\frac{1}{2}$ ounces each of nitric acid and hydrochloric acid; then add $18\frac{1}{2}$ grains each of tin and butter of antimony, and when the whole is dissolved dilute the fluid with 1 pint of water.

The solution of gold is decomposed by a peculiar balsam prepared in the following manner: Dissolve at a moderate heat $\frac{1}{2}$ ounce each of sulphur and Venetian turpentine in $2\frac{3}{4}$ fluid ounces of oil of turpentine, until the solution has acquired a thick consistency and a dark-brown color, and, when cold, add $1\frac{1}{4}$ ounces of oil of lavender. Pour the solution of gold upon this balsam, heat it moderately, and stir. The solution of gold will be decolorized, and the gold, entirely dissolved, passes into the oily fluid, which, when cold, resembles rosin. The liquid standing over it, which contains the acid, is poured off, the oily fluid washed with warm water, and when the last traces of moisture have been removed, $2\frac{1}{2}$ ounces of oil of lavender and $3\frac{1}{2}$ ounces of oil of turpentine are added, and the mixture is heated until the whole is dissolved,

when it is poured over $1\frac{1}{2}$ drachms of subnitrate of bismuth and allowed to settle. The clear portion is poured off and concentrated. An auriferous balsam consisting of a thickish fluid with a light greenish lustre is obtained in this manner.

The Venetian turpentine is added as a drier. The auriferous resins remaining after the evaporation of the volatile oils become decomposed when exposed to heat, and, without melting, produce at a low temperature a residue of carbon and gold having the appearance of a very thin leaf.

To Gild an Ornamental Frame. Cleanse the frame from all impurities. Then boil $4\frac{1}{2}$ ounces of fine glue with $1\frac{1}{2}$ pints of water. Saturate the cleansed frame with this by means of a brush until the wood is thoroughly permeated and has acquired some lustre.

Applying the First Coat. Take $8\frac{1}{2}$ ounces of Spanish chalk and $4\frac{1}{2}$ ounces of French chalk and triturate both with the glue water; bring the mass into a pot, heat it somewhat, and dilute it to the consistency of syrup, but avoid making it too thinly fluid. Now spatter the mass upon the frame with a brush so that it assumes a rough appearance, and as soon as the coat is dry repeat the application 5 or 6 times; but the mass, after the second application, should be spread instead of being spattered. When the frame thus prepared is dry, the surface is first rubbed with pumice stone and then finished with shave-grass (horse-tail), when it is set aside in a clean, dry place to receive later on the gilding size.

Preparation of Gilding Size. Melt $\frac{1}{2}$ ounce of beeswax and 1 ounce of Venetian soap, then add $8\frac{1}{4}$ ounces of Armenian bole, and roast the whole thoroughly. When this has been done add the whites of 16 eggs, rub the whole together upon a rubbing stone, and from the resulting mass form balls of the size of a hazel-nut; dry these upon a glass plate and put them by in a dry place.

Applying the Gilding Size. Take a piece of gilding size, triturate it with water, place it in a clean glass, and dilute with water. Brush the frame slightly with the dissolved gilding size 5 or 6 times, allowing one application

to dry before laying on the next. If the frame is to be gilded with a bright lustre a stiff brushing is required to remove the dust which may have settled upon the gilding size; but if a dead lustre is wanted, the gilding size is coated with a very thin parchment size; and if the dead lustre is to be very characteristic it is first smoothed with a burnisher.

Bright Lustre. A palette is required for this. The gold sizing is moistened with very pure white fruit brandy by means of a camel's-hair pencil, the gold leaf cut with a knife and placed upon the moistened spot with the palette. It is then allowed to dry, and those places intended to show a bright lustre are smoothed with the burnisher. By this a gilding is produced which closely resembles fire-gilt work. All dust should be avoided during the work.

Dead Lustre. After the gold leaf has been applied to those places which are to show a dead lustre, apply lukewarm fruit brandy and parchment size. Then take some dragon's blood and orpiment, rub them very fine, and make a simple gold glazing with water and a little parchment size, and apply this 2 or 3 times. For lemon-colored gold take saffron instead of dragon's blood.

Silvering. Preparation of the Silver Size. Thoroughly roast in a pan $4\frac{1}{2}$ ounces of finely-pulverized fat pipe-clay, $2\frac{1}{4}$ ounces of Spanish chalk, $\frac{1}{4}$ ounce each of Venetian soap and bees-wax. Rub these fine with the whites of 20 eggs, and apply in the same manner as the gold sizing.

Silvering with a Dead Lustre. Rub $3\frac{1}{2}$ ounces of white lead and $\frac{1}{2}$ ounce of white litharge with linseed-oil varnish; mix the mass with an oil varnish and apply in the same manner as indicated above under gilding.

To Silver Wooden Figures with Bismuth. Paint the figure over with light glue, make a fine white chalk priming of glue and chalk, and apply this two or three times. Melt the bismuth in a crucible, and pour it out carefully so that the impurities remain behind. Triturate the melted bismuth upon a hard stone, and stir it into a paste with light-colored glue. Lay this on the chalk priming, and, when dry, polish with a burnisher.

To Gild and Silver Visiting Cards. Make a small matrice of pasteboard, and surround this with a low edge of the same material, so that the cards can be firmly held during the printing. Then coat the plate twice with thick white of egg, and dry the coating until it shows not the slightest trace of moisture. Now place the gold or silver leaf upon the plate, and press. The plate should not be too hot; it is better to use it almost cold. The gold or silver in excess is removed with cotton.

To Gild or Silver Morocco Paper. Wash the paper with urine, and paint it over *but once* with white of egg. A moderate heat only should be used.

To Gild Cotton. Spread the cotton over with glue, dry it, and then apply a thick solution of parchment size and dry it again entirely. The gilding will adhere to this very well.

Gilding and Silvering on Parchment and Paper. Triturate Venice glass upon a hard stone with gum water, write or paint with this upon the parchment or paper and allow it to dry. Then rub the places written over or painted with a gold coin, which will gild them, or if they are to be silvered, with a piece of fine silver, and burnish them.

Italian Method of Gilding Wood. Paint the wood over several times with hot, but not too strong, glue water, so that the pores of the wood become thoroughly permeated. If the surface of the wood is flat, apply the glue water with a flat brush. When the glue water is dry, a priming of chalk is laid on the wood. For this as much whitening as necessary is rubbed very fine upon a stone with glue water. This is laid on the wood twice or three times, allowing each application to dry before applying the next. The ground is then smoothed with shave-grass (horse-tail) until the surface is entirely even. It is then polished with a coarse cloth wrapped around a piece of soft wood, square on one end and pointed on the other. During the polishing, which is continued until the ground shows some lustre, the work must be frequently dampened with a moist brush.

The gilding size is prepared as follows: $1\frac{1}{2}$ ounces of graphite, 1 pound of French white bole, and $3\frac{1}{4}$ pounds of Armenian bole are pulverized as finely

as possible in a mortar, then passed through a sieve, intimately mixed together, and brought into a well-lined crucible. Eight and three-fourth ounces of shavings of white beeswax are then added; the mixture is placed over a moderate fire, and allowed to remain there until the mass has become entirely homogeneous. It is then poured upon a stone slab, and allowed to cool, when the whites of 24 to 28 eggs are added, and the whole rubbed to an impalpable powder upon a hard stone. This powder is placed upon paper and dried, when it is stored away for future use. Every time it is to be used it is triturated with water.

The gilding is done in the following manner: Take a vessel filled with ordinary whiskey, and a few brushes of different sizes; also a cushion stuffed with cotton and edged with parchment, which is placed upon a board covered with leather. The gold leaves are placed upon the cushion, and cut into the required size with a knife. A broad, flat camel's-hair pencil is used for applying and fastening the gold leaf. The parts to be gilded are first moistened with whiskey by means of the brush, and the gold leaf is then laid on. When the work is finished, it is allowed to dry for a few days, and the parts which are to be polished are then rubbed with the burnisher until the required lustre is produced. Those parts which are to have a dead lustre are brushed over with a solution of saffron in spirit of wine.

Burot's Process of Silvering and Gilding Silk, Cotton, and Woollen Yarns. Arrange the cords to be silvered in proper order, and immerse them for 2 hours in a solution of nitrate of silver mixed with caustic ammonia until it is clear. Dry the cords and expose them to a current of pure hydrogen. As the threads, by this process of silvering, have become good conductors, they can be easily electroplated with gold.

To Make Glass Opaque or Frosted. First cleanse the glass. If only portions of it are to be frosted, leave those bare and protect the others by a coating of wax or other impermeable substance. Then rub some fluorspar to a fine powder, and mix it with concentrated sulphuric acid, so as to make a

thin paste. Rub this by means of a piece of lead upon those parts of the glass which are to be rendered opaque. A fine frosted outline of the design may thus be produced upon a sheet of smooth, transparent glass. To finish the operation the glass is gently heated in an iron vessel placed beneath a chimney flue, to carry off the noxious fumes that are thrown off. The plate, when cool, is washed with a diluted solution of soda or potash, to remove the last traces of acid, and is then rinsed in water. Focusing glasses for the photo-camera, and development-glasses for pigment printing, can be prepared in this way at very little expense.

Ornamenting Metal Surfaces. A new process for ornamenting metal surfaces consists in plating, electroplating, or otherwise covering a plate, bar, or ingot of soft metal with a thin film of harder metal, and then rolling out or pressing the ingot or bar into a sheet; whereby the coating is broken into irregular forms, and a marbled appearance produced on the surface of the sheet.

Aubriat's New Process of Decorating Glass. The present methods employed to render glass opaque are likely to fall into disuse when this new process becomes better known, for *muslin glass*, as it is termed, can be produced in a variety of colors and in a number of pleasing designs which will compare favorably with the dull monotony of the present ground glass, and even with etched or embossed glass. A sheet of the material to be covered is floated with a vitrifiable pigment dissolved in gum water, and, when dry, the stencil pattern is laid on, and the exposed parts are cleaned with a stiff brush. The sheet of glass is then placed in a furnace and the remaining color burned in. When simple opaque glass is desired, a plate is covered with gum water and dried; it is then placed in a frame, and a piece of tulle, muslin, or other suitable material stretched over it in close proximity to the gummed surface. The frame is then placed in a box containing a quantity of the powdered pigment, which is forced against the muslin by an air-blast, and, passing through the interstices, adheres to the gummed

glass. In this way the patterns of the lace or muslin are reproduced, and the powder being first caused to adhere firmly by placing the plate in a steam chamber for a few moments, is burned in, as before described, in a special furnace. By means of stencil plates of different designs, and muslin and lace of different patterns, together with pigments of various hues, very beautiful glass screens can be produced, which for many purposes will be preferred to the plain opaque glass at present manufactured.

Artificial Wood for Ornamental Purposes. Mix very fine sawdust with bullocks' blood and subject the paste to hydraulic pressure. Great varieties of articles, having the appearance of the most beautiful ebony carvings, can be thus pressed in strong, suitable moulds. This process may also be used in the manufacture of brushes. The horse-hair is set into the paste while it is still soft. This is then covered with a perforated plate to allow the passage of the hair. Pressure is now applied whereby brushes of one piece are produced which are more durable and cheaper than those manufactured by the old process. [A composition of this character, called by its inventor "hamosite," is largely utilized in this country for the production of door-knobs and other articles. W.]

Use of Wood Tar for Architectural Decorations. Prepare a mass by melting together 80 parts of wood tar, 20 of pine rosin, and 5 of caoutchouc. Add to this a sufficient quantity of chalk, marl, burned clay, or a mixture of these earths, to give it the necessary consistency. The moulds employed for shaping the mass into such architectural ornaments for which formerly plaster of Paris and stone were used, must be oiled or greased before the mass, which should be somewhat heated, is pressed into them. Flags for sidewalks or tiles for roofs may also be produced from this mass. It can be readily painted with any desired color.

To Produce Ornaments from Wood Mass. A cheap composition for moulding mirror and picture-frames, rosettes, arabesques, etc., is made of sawdust and glue with the addition of other suitable substances. The sawdust

should be sifted to remove coarse particles. Boil 5 parts of good furniture glue and 1 of isinglass in such a quantity of water that the fluid in cooling does not form an actual jelly. Strain it through a cloth and, while hot, mix it with a sufficient quantity of sawdust to form a quite stiff paste. Press this carefully with the fingers into the moulds, which should be greased with oil, place an oiled plate or plunger over it, load this down with weights, or place the whole under a press. When the mass in the moulds is about half dry, remove the moisture which has been pressed out, take the ornaments out by inverting the moulds upon a board, and allow them to become entirely dry, when they may be gilded or bronzed. If the ornaments are to be fastened upon oblique surfaces they must be bent and laid on before they are entirely dry.

The mass may be made of various components. Gum tragacanth may be added to the glue, and pulverized chalk and similar substances to the sawdust. Mixtures containing very little or no sawdust are also used for the same purpose. We give in the following a few receipts for such compositions:

I. Dissolve 13 parts of glue in the necessary quantity of water; then stir into it 4 parts of pulverized litharge, 8 of white lead, 1 of fine sawdust, and 10 of plaster of Paris.

II. Mix plaster of Paris and sawdust and form a paste of the required consistency by adding glue water.

III. Liquefy 2 parts of glue in 2 of linseed-oil; then melt 1 part of black pitch in 2 of oil of turpentine; mix the two solutions together and add 2 parts of sawdust, 2 of whiting, and 2 of colcothar.

IV. Mix 8 parts of whiting, 4 of fine sifted sawdust and 1 of pulverized linseed-oil cake, and knead the mixture into a paste with a strong solution of glue.

V. Melt together 4 parts of turpentine and 1 of white pitch, and mix it, while hot, with 4 parts of glue boiled thick. To this mixture add gradually 8 parts of whiting, 4 of fine shavings of sanders wood, and 1 of copal varnish, and knead the whole thoroughly. A thick solution of asphaltum in turpen-

tine may be used instead of the copal varnish.

The two masses given under III. and V. must be kneaded before they are pressed.

VI. Knead 5 parts of chalk with 1 of glue, and add oil of turpentine to the mixture. In working the mass a sufficient quantity of linseed-oil varnish is added to prevent it from sticking to the hands.

VII. *The potato paste* consists of potatoes boiled in water or by steam until done. They are then mashed fine and mixed with sawdust, peat dust, or pulverized tan, and worked into a pliant dough.

To Fasten Leather Ornaments, etc., upon Metal. Digest 1 part of crushed nut-galls for 6 hours with 8 of distilled water and strain the mass. Soak glue in its own weight of water for 24 hours and then dissolve it. The warm infusion of galls is spread upon the leather and the glue solution on the roughened surface of the warm metal; the moist leather is pressed upon it and then dried, when it adheres so that it cannot be removed without tearing.

To Decorate Tin with Copper Plates and Lithographs. Prepare a printing-ink of linseed oil and lampblack and apply it to the etched parts of the plate after it has been heated. The superfluous ink is wiped off and the plate cleaned with lye. Dampened paper is laid upon the plate and covered with a cloth folded several times and pressed. The paper is carefully removed, moistened, and laid upon the tin, upon which the picture is imprinted by means of a small cloth-covered roller, and the paper removed. The same process is used for lithographs. The decorated plates are heated in an oven to 183° F., and remain from 12 to 18 hours, when they are coated with a solution of copal lacquer, varnish, oil of turpentine, and alkanet (coloring matter obtained from the roots of *Anchusa Tinctoria*), and placed in an oven (280.4° F.) and kept for 12 hours.

By properly regulating the temperature of the oven, every desired color of silver-white, brass, gold, tombac, etc., can be obtained by the use of alkanet.

Impressions of Flowers on Glass.

Gum the articles and fasten them on

the glass. The glass is then coated with a warm mixture of oil, tallow, and wax, and when this is dry the articles are removed and the glass exposed to the action of hydrofluoric gas. Solution of hydrofluoric acid in water may also be poured over the glass, or the plate may be covered with a paste of fluor-spar and sulphuric acid. The designs may then be colored by burning the colors in a furnace.

DENTIFRICES AND MOUTH WASHES.

American Tooth Powder. Mix the following ingredients, which should be finely powdered:

Coral	250 parts.
Cuttle bone (<i>ossa sepia</i>)	250 "
Dragon blood	250 "
Burnt alum	120 "
Red sanders wood	120 "
Orris root	250 "
Cloves	15 "
Cinnamon	15 "
Vanilla rubbed with sugar	4 "
Rosewood	15 "
Pinks	250 "

Asiatic Dentifrice. Powder and mix:

I.		II.	
	Parts.		Parts.
Prepared corals	120	Bole	3
Venetian red	9	Chalk	2
Ochre	15	Ochre	1
Pumice stone	15	Pumice stone	1
Musk	1/100	Musk	trace.

Cartwright's Tooth Powder. Powder and mix:

Prepared chalk	30 parts.
Orris root	20 "
Castile soap	2 "

Deschamp's Alkaline Tooth Powder. Powder as fine as possible and mix:

Sugar	30 parts.
Wood charcoal	30 "
Peruvian bark	15 "
Cream of tartar	5 "
Cinnamon	1.5 "

Deschamp's Acid Tooth Powder. Powder and mix:

Venetian talc	120 parts.
Sodium bicarbonate	30 "
Carmine	1/10 part.

And add:

Oil of mint	15 drops
-----------------------	----------

Charcoal Tooth Powder. Powder and mix:

Willow-wood charcoal	120 parts.
Peruvian bark	120 "
Cloves	2 "

Circassian Tooth Powder. Powder and mix:

Prepared buck's horn	60 parts.
Potassium sulphate	60 "
White cuttle bone	250 "
Orris root	250 "
Yellow sanders wood	30 "
Florentine lac	90 "

And add:

Oil of rosewood	1 part.
---------------------------	---------

Red Tooth Powder. Powder and mix:

Round lake	5 parts.
Ordinary alum	24 "
Pumice stone	33 "
Prepared cuttle bone	33 "
Magnesia alba	16 "

Hufeland's Tooth Powder, which may be especially recommended for diseased gums, is prepared by mixing and powdering:

Sanders wood	200 parts.
Peruvian bark	25 "
Oil of cloves	1 part.

Paris Tooth Powder. Convert the following ingredients into an impalpable powder and mix:

Dragon blood	16.5 parts.
Cuttle bone	125 "
Cream of tartar	61.5 "
Orris root	125 "
Prepared buck's horn	66.5 "

And add:

Oil of cloves	15 drops.
-------------------------	-----------

Mouth Wash for Strengthening the Teeth and Hardening the Gums. Powder and mix myrrh, camphor, Peruvian bark, each 1 ounce, and digest them for a few days in 1 pound of spirit of wine. Then strain through a cloth and filter. Use a teaspoonful daily for rinsing the mouth.

Mouth Wash against Toothache. Cut in pieces and rub fine 4½ drachms of the root of Spanish camomile (*anthemis pyrethrum*) and 2¼ drachms of sal-ammoniac. Pour 2½ ounces each of vinegar and lavender water over the above mixture, in a glass flask, and let it digest for 12 hours, and filter. Hold

a teaspoonful in the mouth as long as possible.

Antiseptic Mouth Paste. Salicylic acid* 30 grains, purified honey 1 ounce.

Kolbe's Mouth Wash.

Salicylic acid	12 parts.
Alcohol (96 per cent.)	315 "
Distilled water	60 "
Oil of wintergreen (<i>ol. gaultherie</i>)	10 to 15 drops.
Essence of orange flowers	15 "

Color with tincture of cochineal.

Hager's Red Tooth Powder. Sodium salicylate 2¾ drachms, sugar of milk, sodium bicarbonate, orris root, red sanders wood, each 11¼ drachms, and oil of peppermint 15 drops.

Hager's Tooth Paste. Two and three-quarter drachms sodium salicylate, 30 grains sodium bicarbonate, 1½ ounces each of powdered talc and powdered Castile soap, carmine 4½ grains, 20 drops peppermint, 5½ drachms glycerine, and 5¼ drachms diluted spirit of wine are made into a paste.

Quillaya Dentifrice. The following is one of the best of modern dentifrices, as it not only cleanses the teeth thoroughly, but also refreshes the mouth:

Quillaya saponaria	4 ounces.
Glycerine	3 "
Diluted alcohol	33 "
Oil of wintergreen (<i>ol. gaultherie</i>) .	20 drops.
Oil of peppermint	20 "

The *quillaya saponaria* is macerated in a mixture of the glycerine and alcohol, and then filtered over a small quantity of magnesia which has been mixed with the oils. A finer preparation is obtained in this manner than by macerating the quillaya in alcohol and then adding the glycerine.

DYEING WOOLLEN AND COTTON GOODS AND YARNS, SILK, STRAW HATS, FELT HATS, KID GLOVES, HORSEHAIR, ETC., ETC. MORDANTS.

SILK. Cleansing of Old Silk to be Dyed. Boil 2 pounds of the silk in 3½ ounces of crystallized soda dissolved in

* Benzoic or boracic acid, being more soluble in water than salicylic acid, is preferred by many as a substitute in all tooth powders and pastes in which salicylic acid is prescribed.

a sufficient quantity of water, and next in soap and water.

Black. Let the material remain in a mordant of solution of nitrate of iron of 40° Beaumé for $\frac{1}{2}$ hour; then rinse and dye it in a decoction of 3 $\frac{1}{2}$ pounds of logwood and 1 pound of fustic. It remains in the dye-bath for $\frac{1}{2}$ hour.

Blue (Raymond's). Mordant with solution of nitrate of iron of 1° to 2° Beaumé, rinse the material, place it in a hot soap bath, and rinse again; then it is dyed with prussiate of potash and sulphuric acid. It is then rinsed, brightened in cold water containing some spirit of sal-ammoniac, and finally rinsed.

Brown (Fast with Madder). Mordant in a mixture of 3 parts of acetate of alumina and 2 of acetate of iron, each 5° Beaumé. Then rinse and dry the material and dye with madder.

Crimson (Dark, with Cochineal and Brazil Wood). Mordant with acetate of alumina of 6° Beaumé, to which 1 to 1 $\frac{3}{4}$ ounces of blue vitriol dissolved in water have been added; then winch and dry the material, cleanse it in a bath of bran and chalk, and dye it in a hot, but not boiling, decoction of 3 $\frac{1}{2}$ pounds of Brazil wood, 13 ounces of cochineal, and 1 pound of wheat bran. It remains in the bath for 1 hour, when it is rinsed in a bath of spirit of sal-ammoniac.

Drab (Fast). Mordant with a cold decoction of 3 $\frac{1}{2}$ pounds of sulphuric acid, 8 $\frac{3}{4}$ ounces of blue vitriol, a like quantity of common salt, and 4 $\frac{1}{2}$ ounces of purified tartar. Squeeze and rinse and then dye in water not hotter than the hand can bear, which contains a decoction of fustic (for yellowish gray), or decoction of gall-nuts (for dark gray), or of bablah (for greenish gray).

Gray. Place the silk in a solution of 2 pounds of alum, and let it remain in it for 6 to 8 hours. Then rinse it, and dye in a bath containing indigo extract and decoction of logwood, allowing it to remain for $\frac{1}{2}$ hour.

Red (Fast with Madder). Mordant with acetate of alumina of 5° Beaumé. Winch, dry, and cleanse the silk with bran and chalk. Then dye in a bath of 6 $\frac{1}{2}$ pounds of madder, 8 $\frac{3}{4}$ ounces of sumach, and 1 $\frac{1}{2}$ pounds of bran, allow-

ing it to remain for 1 $\frac{1}{2}$ hours, when it is brightened by boiling gently for $\frac{1}{2}$ hour with 3 $\frac{1}{2}$ pounds of Castile soap, 1 pound of bran, and 2 ounces of solution of nitro-muriate of tin.

Rose-red (with Carthamine). Trurate $\frac{1}{2}$ drachm of carthamine with 1 $\frac{3}{4}$ ounces of alum free from iron, and dye with the mixture dissolved in water. The silk is worked for 15 minutes in the bath, and then in a bath acidulated with wine vinegar.

Rose-red (with Cochineal). Prepare a mordant of 2 pounds of alum, let the silk remain in this for 6 to 8 hours, then rinse it and dye (as hot as the hand can bear) with 1 ounce of cochineal, and rinse.

Scarlet (with Cochineal and Brazil Wood). Mordant with acetate of alumina of 6° Beaumé; winch and dry. Then work the silk in a hot, but not boiling, decoction of 3 $\frac{1}{2}$ pounds of bran and 8 $\frac{3}{4}$ ounces of chalk; rinse, and dye with 3 $\frac{1}{2}$ pounds of Brazil wood and 8 $\frac{3}{4}$ ounces of cochineal. An addition of 1 pound of bran makes the dye more brilliant, but somewhat lighter.

Violet (Fast). Mordant with a cold solution of 3 $\frac{1}{2}$ pounds of sulphuric acid, 8 $\frac{3}{4}$ ounces of blue vitriol, a like quantity of common salt, and 4 $\frac{1}{2}$ ounces of purified tartar. Winch, dry, and cleanse with bran and chalk. Then dye in a nearly hot bath of 6 $\frac{1}{2}$ pounds of madder and 1 $\frac{1}{2}$ pounds of bran, allowing the silk to remain for 1 hour.

WOOLLEN GOODS AND YARNS.

Blue (Dark). Boil the material for 1 hour in a solution of 2 $\frac{1}{2}$ ounces of alum in hot water, then take it out and throw away the bath. Now boil in the same boiler 5 $\frac{3}{4}$ ounces of logwood in pure water for $\frac{1}{2}$ hour; then lift the bag which contained the logwood out, and place the material, which has been previously washed, into the decoction, work it for $\frac{1}{2}$ hour, and then let it boil for $\frac{1}{2}$ hour longer. The bath is now cooled off by adding cold water, the material lifted out, and 2 $\frac{1}{2}$ ounces of potash are dissolved in the bath, when the material is worked in it until it has assumed a beautiful blue color.

Blue (Dark Fugitive Color). The goods are mordanted pale blue and washed. Boil clear water, and add $5\frac{3}{4}$ ounces of blue vitriol, $1\frac{3}{4}$ ounces of green vitriol, 1 pound of alum, $13\frac{1}{4}$ ounces of crude tartar, $2\frac{1}{4}$ ounces of tin salt, and 1 ounce of crude nitric acid. Boil the goods in the mixture for 1 hour. They are then lifted out, allowed to stand for 1 day, and washed. Clean water is then heated in a boiler, $2\frac{1}{2}$ pints of extract of logwood added, and the goods worked in this for $\frac{1}{2}$ hour, during which the heat is raised to the boiling point. From $27\frac{1}{2}$ to 33 pounds of woollen goods can be dyed by the above process.

Gens d'Armes Blue on loose Wool, Yarns, and Piece Goods. Boil for $1\frac{1}{2}$ hours 440 pounds of wool with 88 pounds of alum, $8\frac{3}{4}$ pounds of chromate of potash, $8\frac{3}{4}$ pounds of tin salt, and $6\frac{1}{2}$ pounds of sulphuric acid. The next day dye with 65 pounds of indigo-carmin, 22 to 26 pounds of logwood, and 13 pounds of common salt. Let the wool boil for $1\frac{1}{2}$ hours in the bath.

Brown (Chestnut). Boil in pure water for 5 minutes $\frac{1}{2}$ ounce of madder, a like quantity of sumach or $\frac{1}{4}$ ounce of gall-nuts, $\frac{1}{2}$ ounce of tartar, and $1\frac{3}{4}$ to $2\frac{1}{4}$ ounces of sanders wood. Place the goods in the bath, and let them boil for $1\frac{1}{2}$ hours. Then lift them out, cool the bath by adding cold water; then dissolve $\frac{1}{2}$ ounce of green vitriol in it, and work the wool in this for $\frac{1}{2}$ hour longer.

Brown (Coffee). Boil in pure water for 5 minutes $4\frac{1}{2}$ ounces of sanders wood $2\frac{1}{4}$ ounces of sumach or gall-nuts, and 1 ounce of green vitriol. The bath is cooled off by adding cold water, when the goods are placed in it and boiled slowly for half an hour, when they are taken out and the fire is extinguished; $2\frac{1}{2}$ ounces of green vitriol are then dissolved in the bath, in which the goods are worked for $\frac{3}{4}$ of an hour, when they are cooled off and rinsed.

Brown (Dark). Boil in water $4\frac{1}{2}$ ounces of sanders wood and $2\frac{1}{4}$ ounces of logwood, add $2\frac{1}{4}$ ounces of sumach or gall-nuts, and 1 ounce of green vitriol. Cool the mixture by adding cold water, then place the goods in it and let them boil slowly for $\frac{1}{2}$ hour, when they are taken out. Should the dye not

be dark enough, add 1 ounce more of green vitriol, and repeat the operation.

Brown (Grayish). Boil 1 ounce of sanders wood, a like quantity of madder, and $1\frac{1}{2}$ ounces of gall-nuts, or 3 ounces of sumach. Place the goods in the decoction and boil them for 1 hour. Then lift them out, dissolve 1 ounce of green vitriol in the bath, replace the goods in it, and work them, without allowing them to boil, until they are dyed sufficiently dark.

Brown (Nut). Fill a small bag with $4\frac{3}{4}$ ounces of fustic and $1\frac{1}{4}$ ounces of logwood, and boil them. When the coloring matter has been extracted lift the bag out and add $1\frac{1}{4}$ ounces of madder and a like quantity of sanders wood; then place the goods in the bath and let them boil for $1\frac{1}{2}$ hours, when they are lifted out. The bath is now cooled off with cold water and $\frac{1}{4}$ ounce of green vitriol is added. The wool is worked in it until it is sufficiently dyed.

Brown (Olive). Treat the following ingredients in the same manner as for nut brown: Seven ounces of fustic, $2\frac{1}{4}$ ounces of logwood, 1 ounce of gall-nuts, $2\frac{1}{4}$ ounces of madder, and $3\frac{1}{2}$ ounces of tartar. As soon as the tartar is dissolved place the goods in the bath, and, later on, when it is somewhat cooled off, add $1\frac{3}{4}$ ounces of green vitriol and work the wool in the vat until it has assumed the desired shade.

Brown (Sanders Wood, Fast). Thoroughly extract $4\frac{1}{2}$ pounds of rasped sanders wood in water. Place the wood, together with the extract, in a boiler, add $2\frac{1}{4}$ pounds of sumach and $2\frac{1}{4}$ pounds of fustic liquor, and let the bath boil for $\frac{1}{4}$ hour. Then place the wool in the bath, work it thoroughly, and let it boil for $1\frac{1}{2}$ hours. The wool is then lifted out, the bath cooled off by adding cold water, and 1 pound of green vitriol added, when the wool is placed back into the bath, thoroughly worked in it, and boiled for $\frac{1}{2}$ hour more. It is then lifted out, $4\frac{1}{2}$ ounces more of green vitriol and a bucketful of urine are added, and the wool worked in this without allowing it to boil.

Chamois. Triturate $\frac{1}{2}$ ounce of annatto with water and add to this fluid $\frac{1}{4}$ ounce of potash. Let the bath boil for 5 minutes and then work the wool

in it. Now dissolve in warm water $1\frac{1}{2}$ ounces of alum, and work the wool for a few minutes in this solution.

Gray (Ash). Boil $\frac{3}{4}$ ounce of gall-nuts in a suitable quantity of water for $\frac{1}{4}$ of an hour. Then dissolve in it $\frac{1}{4}$ ounce of tartar, place the wool in the bath and let it boil for 1 hour, frequently stirring it in the meanwhile, when it is lifted out. The bath is then thoroughly cooled, $1\frac{1}{2}$ ounces of green vitriol are added, and the wool worked in it until it has assumed the desired shade of color.

Gray (Bluish). Boil $1\frac{1}{2}$ ounces of gall-nuts, $4\frac{1}{2}$ ounces of tartar, and $\frac{1}{4}$ fluid drachm of indigo tincture. Place the cloth, previously moistened, in this mixture and let it boil for $1\frac{1}{2}$ hours, with frequent working. It is then lifted out and the bath compounded with $4\frac{1}{2}$ ounces of green vitriol and the cloth worked in it for $\frac{1}{2}$ hour longer.

Gray (Dark). Put 1 pound of logwood and $13\frac{1}{4}$ ounces of sumac in a small bag and boil them for $\frac{1}{2}$ hour in a boiler full of water. Then take the bag out, place 13 pounds of cloth, previously moistened with hot water, in the bath, and let it boil for 1 hour, when it is lifted out. The bath is then cooled by adding cold water; $8\frac{3}{4}$ ounces of green vitriol are added, and the goods worked in it for $\frac{1}{2}$ hour, and then boiled until they have acquired the desired shade.

Gray (Fast Dark). The cloth is first grounded blue with indigo and then boiled in a solution of $8\frac{3}{4}$ ounces of blue vitriol, $4\frac{1}{2}$ ounces of tartar, and some indigo tincture.

Gray (Light). Rub 1 ounce of verdigris as fine as possible with $3\frac{1}{2}$ pounds of good vinegar; let the fluid stand over night and boil it the next day with water. Add to the solution 1 ounce of gum Arabic and work the goods in it until they have acquired the desired shade.

Gray (Silver). Boil for 10 minutes $\frac{1}{2}$ ounce of tartar, $\frac{1}{4}$ ounce of gall-nuts, and 1 drachm of blue vitriol. Work the wool in this bath and then let it boil until the desired color has been obtained.

Green (Olive). The goods are first grounded light blue. One pound of fustic is then tied in a small bag, placed in a boiler, and boiled for 1 hour, when

it is taken out and $3\frac{1}{2}$ ounces of blue vitriol, $2\frac{1}{2}$ ounces of tartar, $3\frac{1}{2}$ ounces of madder, and $1\frac{1}{2}$ ounces of logwood liquor are dissolved in the bath. The goods are then placed in the bath and boiled for 1 hour, when they are lifted out. Four and one-half ounces of crushed gall-nuts are now added to the liquor and the goods boiled in this for $\frac{1}{2}$ hour more, when they are taken out. The bath is now compounded with $1\frac{1}{2}$ ounces of green vitriol and some urine, and the goods are worked in this until they are sufficiently dyed.

Green (Brownish-olive). Boil $2\frac{1}{2}$ ounces of fustic and 1 ounce of madder, then add to the fluid $2\frac{1}{2}$ ounces of tartar and 1 drachm of gall-nuts. Place the goods in the bath, let them boil for $1\frac{1}{2}$ hours, take them out and cool them off in the open air. The bath is cooled by adding cold water, and compounded with $\frac{1}{2}$ ounce of green vitriol, when the goods are placed back in it, worked for $\frac{1}{2}$ hour, cooled off, and rinsed.

Lilac. Dissolve $\frac{3}{4}$ ounce of crystallized tartar and $2\frac{1}{2}$ ounces of alum in hot water, add $\frac{1}{2}$ ounce of pulverized cochineal to the solution, work the goods in the bath for $\frac{1}{2}$ hour, and then boil them for $\frac{1}{2}$ hour.

Orange. Put 1 pound of quercitron bark in a small bag and boil it for $\frac{1}{2}$ hour in a boilerful of water. Then add to the fluid 1 pound of alum, $\frac{1}{2}$ ounce of tartar, and $2\frac{1}{2}$ ounces of tin salt. Boil the cloth in the bath for $\frac{1}{4}$ hour; cool the bath off, work the cloth once more, let it again boil for half an hour, and then wash it out. Now boil $8\frac{3}{4}$ ounces of madder with water, and work the cloth in the bath with constantly increasing temperature.

Yellow (Dark). Place $3\frac{1}{2}$ pounds of quercitron bark in a bag, boil it in a tin boilerful of water for $\frac{1}{4}$ hour. Then add 2 pounds of alum, 1 ounce of tartar, and $8\frac{3}{4}$ ounces of tin salt. Now boil the goods in the bath for 8 to 10 minutes, when they are taken out. Cool the bath by adding cold water, work the wool once more in it, and then let it boil for $\frac{1}{2}$ hour.

Yellow (Sulphur). Go through the same process as for dark yellow, but add, when that is finished, quercitron bark and solution of tin to the bath and let the wool boil in it for $\frac{1}{2}$ hour.

Yellow (with Weld). Dissolve 5½ pounds of alum in a corresponding quantity of water and boil the woollen goods in this for 2 hours, when they are put in a cool place, where they remain for 1 day and are then washed. Now sew 3¼ pounds of good French weld in a bag, boil it in a boilerful of water, cool the liquor, and work the wool thoroughly in this, without allowing it to boil.

COTTON GOODS AND YARNS.

Black. For 10 pounds of yarn. Prepare a lukewarm bath of 1 pound of dry extract of logwood and 1½ quarts of water. Dissolve further 2 pounds of dry extract of logwood in 2 gallons of water. Now dye 2 pounds of the yarn in this dye-bath, take it out, wring it, and let it dry in the open air. One-quarter of the first solution is then added to the bath, and the second ½ of the yarn treated therein. The same process is repeated with the remaining yarn until all the solution has been used.

No. II. Prepare a bath by dissolving 8¾ ounces of bichromate of potash and 2½ ounces of crystallized soda in 2 gallons of water. After the first ½ part of the yarn has been taken from the dye-bath, ¼ of the solution is added to it; the next portion of the yarn is dyed, and so on.

Brown (Chocolate). For 10 pounds. Boil the material for 1 hour with 1½ pounds of sanders wood, 8¾ ounces of gall-nuts, 1¾ ounces of extract of logwood, 5¼ ounces of prepared catechu, and 3½ ounces of tartar. After boiling let it remain in the bath for 1 hour, then add a solution of 8¾ ounces of green vitriol and 1¾ ounces of blue vitriol; mix them intimately with the bath and place the material in it for 1 hour longer, when it is taken out and rinsed.

Chamois. For 10 pounds. Treat the materials, after they have been prepared for dyeing, in a warm decoction of 4½ ounces of annotto and 1½ ounces of potash; lift them out, rinse, and then work them in fresh water mixed with sulphuric acid, and rinse.

Crimson. For 10 pounds. Red yarns are boiled in clean water. Place them in a bath of 2 pounds of sumac. Let

them remain for 12 hours, then place them in a bath of tin salt of 3° Beaumé. Allow them to remain for 1 hour, when they are winched and brought into a bath of 3¼ pounds of Brazil wood. Here they remain for several hours, when they are winched and dried.

Gold Color (Cotton for Fringes, etc.). Boil, with constant stirring, 8¾ ounces of sugar of lead and 1 pound of litharge in 3 gallons of water. After the fluid has boiled for 5 to 10 minutes allow it to stand quietly until a precipitate is deposited, then pour the fluid off and mordant the yarn in this. When thoroughly permeated it is dried at a uniform heat, and then, without being washed, dyed in a bath of bichromate of potash. For the above-mentioned quantities a bath is used of 8¾ ounces of bichromate of potash, to which 4½ ounces of nitric acid have been added. To produce a perfectly pure chrome yellow the bath must be entirely clear. If it has been used the clear liquor must be drawn off from the sediment. As soon as the yarn is taken from the bath it is washed for ¼ hour in a stream of running water to remove all traces of chrome yellow adhering mechanically to it. To produce a beautiful golden lustre dissolve ¼ ounce of saffron in 2 pounds of spirit of wine of 20° Beaumé, and add to the solution a sufficient quantity of fruit brandy to produce the desired shade. As a general rule 2 minutes are sufficient for the yarn to remain in this solution. The excessive moisture is wrung out and the yarn dried in the shade at a moderate heat. The yarn, as it comes from the saffron bath, must not be washed, as the color becomes dull in hard water containing lime and the yarn rough.

Gray (Silver). Boil the yarn in clean water and bring it into a wooden vat containing hot water and 8¾ ounces of catechu boiled in 3½ quarts of clean water. Work the yarn in this bath for ½ hour and wring it. Now fill a vat with clean cold water; add to this 2 ounces of green vitriol dissolved in hot water. Work the yarn in this until it has acquired the desired color, then rinse and dry it.

Green (Dark). Boil 5½ pounds of fustic in pure water for ¾ of an hour, and add 5½ ounces of verdigris dissolved in

water. Treat the material in a bath of 11 pounds of sumac, and place it for $\frac{1}{2}$ hour in the liquor heated to 190° F. and boil for a few minutes; then lift out and wring. The dyed material is brought into a vat containing hot water and extract of logwood and worked for $\frac{1}{2}$ hour at 190° F. and rinsed.

Mineral Green. Prepare a lye of caustic potash by dissolving in a wooden vat $1\frac{1}{2}$ parts of potash in water and gradually adding $2\frac{1}{2}$ parts of burned lime to the solution. The liquor is then thoroughly stirred, and allowed to stand quietly for 12 hours, when the clear fluid is drawn off into a vat filled with cold water. Twenty-five parts of the material to be dyed are worked in the liquor for $\frac{1}{2}$ hour, when it is winched, and dyed in a hot bath to which have been added $1\frac{1}{2}$ parts of sulphate of copper dissolved in hot water; here it remains for $\frac{1}{2}$ hour, when it is winched and dried.

Yellow. Dissolve 1 ounce of sugar of lead and $\frac{1}{2}$ ounce of alum in warm water; place 1 pound of material in this bath, work it for some time, and finish the dyeing process in a solution of chromate of potash.

Yellow (Chrome). For 15 pounds of yarn or cloth. I. Slack 6 pounds of freshly burned lime in 50 gallons of water, and then dissolve 3 pounds of sugar of lead in the liquor.

II. Stir 3 pounds of acetate of lead into 2 gallons of water and slake 6 pounds of freshly burned lime in the liquor. The plumbiferous lime formed in this manner is brought into 50 gallons of water and the fluid allowed to become clear by standing, when it is ready for use.

The cotton material is then moistened twice in succession with one of the above fluids, and, while still moist, brought into a bath of chromate of potash. This gives a beautiful chrome yellow color.

A beautiful green is obtained by dyeing indigo-blue cotton goods in the above manner.

TO DYE WOOL, SILK, AND COTTON
WITH ANILINE COLORS.

Fuchsine on Wool. In using aniline

colors it is of the greatest advantage to transform them by dissolution into a very much diluted fluid. For instance fuchsine, soluble in water, is dissolved with gradual stirring in boiling water in the proportion of 2 pounds of crystallized fuchsine in 60 gallons of water. The resulting solution is filtered and used for dyeing. The wool, uniformly moistened, is dyed without any further preparation in a very clean, tepid bath of 85° F. to which some solution of fuchsine is added from time to time, and the temperature raised to 120° F. Two pounds of fuchsine, soluble in alcohol, is gradually dissolved in 4 to $4\frac{1}{2}$ gallons of good spirit of wine of 90 per cent., previously heated to 100° to 120° F., and the solution used for printing and dyeing. For printing on silk and wool the ordinary inspissations are used, such as gum, etc., but on cotton it is necessary to use albumen, which should always be preferred to its substitutes.

Fuchsine on Silk, Bluish Shade. One of the above-mentioned solutions of fuchsine is added to a cold bath acidulated with acetic or tartaric acid, and the silk dyed in this, with slow addition of color, until the desired shade has been obtained. If less bluish shades are desired, no acid is added to the bath.

Fuchsine on Cotton. Only thoroughly mordanted cotton can be well and uniformly dyed with fuchsine. An oil mordant, as for Turkish red, is excellent, but, instead of this, an acid mordant consisting of 1 part of sulphuric acid and about 3 parts of olive oil may be advantageously used. A tannic acid mordant can also be recommended. The yarn is then brought into a solution of sumac of 120° F., then into a bath of stannate of soda, and finally into a bath containing sulphuric acid, when it is washed and dyed as given above.

Eosine on Wool. Eosine, soluble in water, is dissolved in hot water, and that, soluble in alcohol, in spirit of wine, in the same manner as fuchsine.

Prepare a water bath of 85° F., add a sufficient quantity of the eosine dissolved in water, place the thoroughly moistened wool in it and heat to 105° F. Then add alum in the proportion of $1\frac{1}{2}$ to $2\frac{1}{2}$ ounces to 2 pounds

of wool, bring the bath slowly to the boiling point and let it boil for about $\frac{1}{2}$ hour. The wool is then finished by thorough washing.

The following receipt has been thoroughly tried and found to be excellent: For 80 pounds of wool take 3 pounds of tartar and 2 pounds of eosine dissolved and filtered through a cloth. Enter the moist wool and let it boil slowly for $\frac{3}{4}$ hour. The wool is then lifted out, 2 pounds of chloride of tin is dissolved in the same bath and thoroughly stirred. The wool is again placed in the bath, and slowly boiled for $\frac{1}{2}$ hour longer. It is best to allow the wool to cool in the boiler.

Eosine on Silk. Dye in a boiling soap bath with an addition of an organic acid.

Eosine on Cotton. For bluish shades, the cotton is placed in a bath of castile soapsuds of 120° F. and allowed to remain in it for $\frac{1}{2}$ hour. It is then mordanted for $\frac{1}{2}$ hour with nitrate of lead of 3° Beaumé, then thoroughly washed, and finally dyed in a bath of eosine of 120° F. For a yellowish shade more or less alum, according to the tint desired, is added to the bath of nitrate of lead. Very pure, soft water should be used for all baths.

Scarlet and Erythrosine on Wool. Dissolve the color in hot water. Then prepare a bath of 120° F., which contains 10 pounds of alum to 100 pounds of wool, and place the wool in it. After the lapse of $\frac{1}{4}$ hour add the coloring matter, bring the bath slowly to the boiling point, and let the wool boil for $\frac{1}{4}$ hour, when it is taken out and thoroughly washed.

Violet on Wool. Two pounds of aniline violet is dissolved with slow stirring in 6 to 8 gallons of spirit of wine, 90 per cent. strong, the solution heated to 105° F., and then filtered. The wool is dyed in a weak sulphuric acid bath of 105° to 125° F., to which the dye-stuff is added. The bath is slowly brought to the boiling point. A more or less reddish tint can be given by an addition of sulphuric acid.

Violet on Silk. The silk is placed in a bath of 105° to 125° F., slightly acidulated with sulphuric acid, and the desired shade is obtained by slowly adding the dye-stuff.

Aniline Blue (Blue, Light Blue, and Soluble Blue). The color is dissolved in the same manner as violet, but it is advisable to take more spirit of wine. The soluble blue is dissolved in boiling water.

On Wool and Silk. The same directions hold good as for violet, but more alum is added and generally more sulphuric acid. A clearer and more beautiful color on wool is obtained by boiling the wool first with chloride of tin and alum. Of all the colors mentioned here, blue is the most difficult to dissolve in water, and as the fibres do not absorb it uniformly it is requisite that the coloring matter should be added very gradually.

Cotton is dyed in a bath to which acetate of alumina has been added as a mordant. The acetate of alumina is obtained by boiling 15 parts of sugar of lead and 20 of sulphate of alumina with 100 of water. The resulting clear solution is used as a mordant.

Alkali Blue. Two pounds of this is dissolved in at least 4 gallons of boiling water, and when the solution is complete 15 gallons more of hot water are added to it.

For 100 pounds of Wool. Prepare a bath with 8 $\frac{1}{2}$ pounds of borax, heat it to 105° F., then add the solution of coloring matter, and gradually heat to the boiling point. The wool is then washed in cold water, placed in a lukewarm bath acidulated with sulphuric acid, and heated to the boiling point. To dye according to sample, dissolved coloring matter is added to the first bath until a sample of the wool, taken from this bath and worked in a boiling hot acid bath, has assumed the desired color.

A bath of waterglass is now generally preferred to that of borax, 15 pounds of it being required for 100 pounds of wool. The further treatment is the same as with borax.

Light Blue on Cotton. For 100 pounds. The cotton is soaped and dried. A solution of 2 pounds of alum, 2 pounds of tartar emetic, and 6 pounds of dissolved calcined soda is used as a mordant. After mordanting the cotton it is dyed in a fresh bath, to which diluted sulphuric acid has been added the temperature being gradually raised

from 75° F. to 140° F. The cotton should be cooled off in the bath.

China-blue on Cotton. The color is dissolved in the same manner as the blue soluble in water. Some alum is added to the tepid water-bath, and the cotton dyed by heating the bath to the boiling point and allowing it to cool in it.

Dahlia and Primula. These colors are soluble in water and in alcohol. Those soluble in water are dissolved in the same manner as fuchsine, but those soluble in alcohol, like the aniline violet. The wool is dyed with these solutions, without any further preparation, at 85° to 105° F., and, when finished, worked several times in the boiling bath. Silk is dyed with the dissolved and filtered coloring matter in a bath heated to 85° to 105° F., to which a very small quantity of tartaric acid or some sulphuric acid has been added, until it has acquired the desired shade, and is then frequently turned over in the boiling bath. For dyeing cotton, acetate of alumina is added, and the goods treated in the same manner as given for blue.

Methyl-violet. This is soluble in water. The dyeing is accomplished by adding acetic acid, or some other organic acid.

Methyl and Emerald-green. Dissolve 2 pounds of green powder in 7 to 8 gallons of lukewarm water; add, with constant stirring, some acetic acid, and heat the solution to 140° F. Boiling must be strictly avoided. Then dissolve 2 pounds of concentrated green paste in 3 gallons of alcohol of 90 per cent., and, with constant stirring, add water and some acetic acid, noting that the temperature must not be allowed to rise above 95° F. This solution, as well as that of green powder, is filtered and then used for dyeing.

For 20 pounds of Wool (Dyed in the Wooden Vat). Dissolve 6 pounds of hyposulphite of sodium, and add 3 pounds of hydrochloric acid. Heat the liquor to 105° F., place the wool in the bath, and, with vigorous stirring, heat it to the boiling point. The wool is then lifted out and washed in a fresh, cold bath. Now prepare a fresh, lukewarm bath, and add to it 10 ounces of acetic acid and 2 pounds of oil soap

dissolved at 85° F. The wool is placed in this bath, dyed with the above solutions at 120° to 140° F., and then thoroughly washed.

For dyeing *silk*, a little acetic acid is added to the bath, and the dyeing accomplished at a temperature of 110° F.

Cotton is first brought into a sumach bath, wrung out, and then into a bath of stannate of sodium. It is then placed in the dye-bath heated to 105° F. and weakly acidulated with acetic acid. To obtain yellowish tints on cotton, add picric acid to the bath, or, what is still better, it is dyed with picric acid in a special bath, which can be used again.

The following receipt for 35 to 45 pounds of woollen yarn has been thoroughly tried and found to be excellent: Add 10 pounds of hyposulphite of sodium and 5 pounds of hydrochloric acid to a lukewarm bath, enter the wool at 120° F., and raise the heat to 160° F.; then let the yarn stand in the bath for 1 hour, when it is thoroughly rinsed. In the wooden vat, the feed pipe of which should be if possible of rubber or glass, as metal must be avoided wherever possible, 9½ ounces of methyl-green dissolved and filtered are added, and according to requirement from 3½ to 7 ounces of picric acid, and the dyeing is finished at 105° to 120° F.

Malachite-green. Dissolve 2 pounds of malachite-green (Ia.) in about 35 gallons of water; heat, with constant stirring, to the boiling point, and, after boiling, filter for 15 minutes.

Malachite-green on *wool* is treated in the same manner as given for methyl-green, namely, with hyposulphite of sodium and hydrochloric or sulphuric acid.

Silk is also dyed in the same manner as given for methyl-green; but as malachite-green is of a more yellowish tint, considerable picric acid may be saved. If that shade is desired, but a very small quantity of the acid need be added.

Cotton is mordanted with sumach, then placed in the dye-bath containing tartaric or acetic acid, and dyed at a lukewarm temperature.

Malachite-green may be highly recommended for *printing on cottons*, the more so as this color can stand any degree of heat and the hottest steam with-

out changing or losing its shade. To 10 pounds of solution of coloring matter add $3\frac{1}{2}$ ounces of tannin, and heat to 140° F.

The same remarks hold good for *printing on woollens*. Two pounds of malachite-green (Ia.) dissolved in 7 gallons of boiling water are generally used. The solution is filtered, and 7 gallons of gum-water and about $6\frac{1}{2}$ pounds of glycerine are added to it.

Naphthaline Colors. *Ponceau, Orange, and Bordeaux.* These colors are dissolved in boiling water.

For 100 pounds of Woollen Yarn. Prepare a bath containing $2\frac{3}{4}$ pounds of tartar, heat to 105° F., place the yarn in it, turn it 5 times, and then add the quantity of coloring matter required. After turning it several times add very slowly $5\frac{1}{2}$ pounds of the composition of tin given below, bring the yarn to a boil, and let it boil for $\frac{1}{2}$ hour, when it is taken out, cooled off, and thoroughly washed. The color takes quickly after the composition of zinc is added and becomes very brilliant.

For 100 pounds of Piece Goods. The goods are placed in the vat at 105° F. The bath should contain from 2 to 3 per cent. of tannin. The coloring matter and $2\frac{1}{2}$ per cent. of composition of tin are then added; then the goods are strongly boiled for $\frac{1}{2}$ hour, allowed to cool, and thoroughly washed. Even the thickest goods are thoroughly dyed in this manner.

Composition of tin is prepared in the following manner: Mix 3 parts of hydrochloric acid, 1 of nitric acid, and 1 of water. The mixture is moderately heated and 1 pound of English granulated tin is then added for every $6\frac{1}{2}$ pounds of the mixture.

Silk is dyed with these magnificent colors in the soap bath, with an addition of some acetic acid and the quantity of coloring matter required.

Cotton is first soaped and then dried. It is then strongly mordanted for 1 hour in acetate of alumina which must be "free from lead," wrung out, and directly dyed in a fresh water-bath to which the dissolved coloring matter has been added. The temperature is raised to the boiling point, and the cotton allowed to cool in the bath. The baths, once prepared, can be used again.

Acetate of alumina free from lead is prepared as follows: Dissolve 4 parts of sulphate of alumina and $3\frac{1}{2}$ of crystallized soda in 7 parts of water. Then dissolve 5 parts of sugar of lead in $3\frac{1}{2}$ of water. Boil each solution by itself, mix them slowly while lukewarm, and filter this mixture; then the alumina is ready for use.

The naphthaline colors, ponceau, Bordeaux, and orange, should be used in a wooden vat or in a well-tinned boiler, and this especially for wool and woollen goods, as unsatisfactory results are obtained by using a copper boiler, as is evident to every practical dyer. The colors will wash and are not changed by atmospheric influences or light.

To Dye Felt Hats with Aniline Colors. For the dyeing of felt hats aniline colors can be used in every case. The coloring matter is used repeatedly to make the shade satisfactory. If the dyeing follows the fulling, the felt is not penetrated so easily, but the hair can be directly dyed, and the dyed hair fulled. For this purpose a solution of the dye is made in boiling water, then allowed to cool, and filtered. A pan with water heated to 85° F. is prepared, the necessary quantity of coloring matter added, the mixture thoroughly stirred up, and the hair, moistened and enclosed in a basket, is placed in the bath. The bath is heated to 140° F. and the basket agitated continually. Fresh coloring matter is introduced when the hair has absorbed a certain amount, the basket being for the time removed.

When the hair is fully dyed, the basket is lifted out and the hair allowed to cool and well rinsed. Mixtures of aniline colors may be used for particular tints. For *brown, cerise, merron, etc.,* are used. These give with indigo-carmine and picric acid, with addition of a little sulphuric acid, beautiful brown shades. For the preparation of the favorite "*Bismarck*" a solution of Manchester brown can be used, which is toned down by addition of indigo-carmine, picric acid, and fuchsine.

To Dye Felted Fabrics with Aniline Colors. In making felted fabrics of a mixture of animal and vegetable fibres, it is found difficult to dye them

evenly, as the vegetable fibre does not take the dye equally with the animal. To overcome this difficulty the vegetable matter is neutralized by subjecting the felted fabric to an acid bath of from 6° to 12° Beaumé, and then washing to remove the acid, after which the fabric will dye an even tint.

To Dye Mother-of-Pearl with Aniline Colors. Wash the thin plates with lukewarm solution of potash, then place them in a concentrated aqueous solution of the coloring matter, and let them stand in a warm place, frequently stirring them. If the dye is to penetrate to some depth the plates must remain in the coloring matter for two weeks, then be rinsed and dried.

To Dye Straw and Straw Hats. Black. For 25 Straw Hats. Prepare a boiling bath, and add to it 4½ pounds of logwood, 1 pound of gall-nuts or sumach, and 4½ ounces of turmeric, or fustic. Let the hats boil in this bath for 2 hours. Then place them in a bath of ferric nitrate of 4° Beaumé and rinse them carefully in water, and dry and brush them.

Chestnut-brown. For 25 Straw Hats. One and one-half pounds of ground red sanders wood, 2 pounds of ground turmeric, 6½ ounces of gall-nuts or sumach, and ¾ ounce of rasped logwood are boiled for at least 2 hours in a boiler of sufficient capacity to hold the hats without being pressed against each other. The hats, after being boiled for 2 hours in this bath, are rinsed out and allowed to remain over night in a bath of ferric nitrate of 40° Beaumé, when they are carefully rinsed out several times to remove the acid. For a darker chestnut-brown the quantity of sanders wood is increased. When the straw is dry the hats are brushed with a brush of dog's (or couch) grass to give them lustre.

Silver-gray. For 25 Straw Hats. The whitest straw should be selected for this color. The hats are first soaked in a bath of crystallized soda to which a little of a clear solution of lime and 4½ pounds of alum and 3½ ounces of tartaric acid have been added. The hats are then allowed to boil in this bath for 2 hours, when they are rinsed with slightly acidulated water.

Violet. For 25 Straw Hats. Two

pounds of alum, 1 pound of tartaric acid, and a like quantity of chloride of tin. Let the hats boil in this bath for 2 hours and then add, according to the shade to be produced, decoction of logwood and indigo-carmine, and rinse them with water with a slight addition of alum.

To Dye Kid Gloves. The dye solutions are brushed over a glove drawn smoothly over a wooden hand. In order to dye *black*, the glove is first washed with alcohol and dried, and then brushed with a decoction of logwood, left for 10 minutes, and then brushed over once more with logwood. After 10 minutes, the glove is dipped into a solution of sulphate of iron, and brushed afterward with warm water. If the color is not dark enough, add a little fustic or decoction of quercitron in the logwood bath. In place of the sulphate of iron, the nitrate may be advantageously employed. When the glove begins to dry, it is rubbed with a little Provençe oil and talc, laid between flannel, and pressed. It is again rubbed with oil and talc, and drawn on a wooden hand. The glove must not get black on the inside, consequently none of the coloring matter should reach the inside of the glove. *Brown* is dyed by brushing the glove with a decoction of fustic red and logwood with a little alum. The quantities of the dyestuff to be used are regulated according to the shades desired. For darkening the color a small quantity of solution of sulphate of iron is used.

Morocco-red is produced by brushing the glove with a decoction of cochineal, to which a little tin salt and oxalic acid are added. The shade is easily made darker by adding a little logwood. *Gray* is produced by brushing the glove with a decoction of sumach, and then treating it with a weak solution of sulphate of iron; a greenish-gray shade is obtained by the addition of fustic and logwood, or fustic and indigo-carmine, to the decoction of sumach.

The aniline colors all fix themselves without any further addition by brushing their solutions on the gloves. In place of the brush a sponge may be used where it seems suitable. In order to give black a pleasing bluish appearance, after the dyeing, it may be washed

with a little sal-ammoniac. Should the seams in the gloves remain white after dyeing, they are coated with a paste to which a little fat is added.

To Dye Kid Gloves Orange-yellow. Take a good pinch of saffron, 1 drachm of annatto, and a like quantity of isinglass; pour $1\frac{1}{4}$ pints of boiling water over these ingredients, and let them stand over night. Cleanse the gloves with alcohol, draw them over wooden hands, and apply the solution with a brush. The isinglass gives durability and a beautiful lustre to the color.

To Dye Horsehair. The hair is kept in a soap bath of 120° F. for 24 hours, and frequently stirred, taken out and washed, and is then ready for the dye.

Black. Boil the hair with milk of lime, then place it for several hours in a decoction of logwood, and finally treat it with acetate of iron.

Blue. Mordant the hair in a warm solution of alum and tartar, and then dye it in a bath of indigo-carmine compounded with alum, or in a solution of indigo in sulphuric acid.

Brown. Place the hair in a decoction of logwood prepared with lime-water, raise the temperature of the bath to 120° F., allow the hair to remain in it for 12 hours, and then wash it in water.

Red. Place the hair for $\frac{1}{2}$ hour in a solution of tin salt to which some warm water has been added. Then wring it out and bring it into a decoction of logwood compounded with alum. Allow it to remain in this for 24 hours, and then rinse and dry it.

To Dye Imitation Corals. Alabaster is generally used for making imitation corals. For the purpose of dyeing them, prepare a bath of 1 part of tartar, $\frac{1}{2}$ part of composition of tin, and 70 of water. The composition of tin is prepared from 8 parts of nitric acid, 1 of sal-ammoniac, 1 of tin, and 25 of water.

Saturate this bath with cochineal and bring it to the boiling point. Then allow it to cool and decant it. The alabaster is placed in this clear fluid, boiled for 1 hour in it, then dried in the open air, and finally put for 2 or 3 hours in a bath composed of equal parts of stearic acid and wax. When the articles are taken from this bath they are wiped off with paper and pol-

ished with a substance which should not be too hard.

Animalizing of Hemp, Jute, etc. Every dyer who handles these articles knows how difficult it is to mordant and dye hemp and jute. To overcome this difficulty place these fibrous substances in a steam boiler, and let them boil for 1 hour in a sufficient quantity of soda; then rinse and subject them in a well-closed vessel to the action of chloride of lime. The substances animalized in this manner can be easily bleached or dyed.

MORDANTS. *Olivier's Mixtures as Substitutes for Tartar in Dyeing Wool.*

I. Dissolve 100 parts of common salt in 300 parts of water; add to the solution 1 part of white arsenic, 10 of sulphuric acid, and 3 of nitric acid.

II. Mix 100 parts of Glauber's salt with 1 of sulphuric acid, 3 of nitric acid, and 6 of vinegar.

III. Mix 100 parts of Glauber's salt with 6 of sulphuric acid and 2 of nitric acid.

IV. Mix 100 parts of Glauber's salt and 3 of powdered tartar with 6 of sulphuric acid.

Huilard's Substitute for Tartar in Dyeing Wool Black, without an addition of alum, is composed of 16.5 gallons of water, 55 pounds of common salt, and 11 pounds of nitric acid of 36° Beaumé. The common salt is dissolved in the water, the nitric acid is then added, and the solution filtered. If tartar and alum have been used as a mordant, 33 pounds of sulphate of alumina are gradually added in small portions to the solution of common salt with nitric acid. It is necessary to add some tartar and alum to the bath to be used for the first piece of goods, or a little tartar is added to the dye-bath.

Mordant for Dark Red on Cottons. One and three-quarter gallons of soft water, 2 pounds of cream of tartar, 11 pounds of good alum, 1 pound of sal-ammoniac, $8\frac{1}{2}$ ounces of solution of tin, $3\frac{1}{4}$ pounds of crystallized soda, and 2 pounds of spirit of wine.

Mordant for Light Red on Cottons. One and one-half gallons of water, $2\frac{1}{2}$ ounces of cream of tartar, $7\frac{1}{2}$ pounds of good alum, $13\frac{1}{4}$ ounces of sal-ammoniac, 2 pounds of crystallized soda, $8\frac{1}{2}$ ounces

of solution of tin, and 2 pounds of spirit of wine.

Mordant for Scarlet on Cottons. One and three-quarter gallons of soft water, 11 pounds of alum, $1\frac{1}{2}$ pounds of sal-ammoniac, $3\frac{1}{4}$ pounds of crystallized soda, $8\frac{3}{4}$ ounces of solution of tin, 1 quart of spirit of wine, and 1 pound of sugar of tin.

Mordant for Light Scarlet on Cottons. One and one-half gallons of soft water, $5\frac{1}{2}$ pounds of alum, $8\frac{3}{4}$ ounces of sal-ammoniac, 1 pound of crystallized soda, $13\frac{1}{4}$ ounces of solution of tin, 1 quart of spirit of wine, and 1 pound of sugar of tin.

Mordant for Crimson on Cottons. One and one-half gallons of soft water, 2 pounds of lime, $5\frac{1}{2}$ pounds of alum, 1 pound of sal-ammoniac, $4\frac{1}{2}$ ounces of potash, $8\frac{3}{4}$ ounces of liver of sulphur, 1 quart of spirit of wine, 1 pound of sugar of tin, and 1 pound of spirit of sal-ammoniac.

Mordant for Rose-red on Cottons. One and one-half gallons of soft water, $1\frac{3}{4}$ ounces of cream of tartar, $3\frac{1}{4}$ pounds of alum, $8\frac{3}{4}$ ounces of sal-ammoniac, $8\frac{3}{4}$ ounces of solution of tin, $4\frac{1}{2}$ ounces of liver of sulphur, $8\frac{3}{4}$ ounces of sugar of tin, and 2 pounds of spirit of sal-ammoniac.

Mordant for Fiery Red on Cottons. One and one-half gallons of soft water, $1\frac{1}{2}$ pounds of verdigris, $4\frac{1}{2}$ pounds of alum, $3\frac{1}{4}$ pounds of blue vitriol, and 1 quart of spirit of wine.

Mordant for Purple on Cottons. One and one-half gallons of soft water, $8\frac{3}{4}$ ounces of cream of tartar, $8\frac{3}{4}$ pounds of alum, $4\frac{1}{2}$ pounds of lime, $8\frac{3}{4}$ ounces of potash, $1\frac{1}{2}$ pounds of solution of tin, $4\frac{1}{2}$ pounds of sugar of tin, and 2 pounds of iron liquor.

Mordant for Violet on Cottons. One and one-half gallons of soft water, $8\frac{3}{4}$ ounces of cream of tartar, $2\frac{1}{2}$ pounds of alum, $4\frac{1}{2}$ pounds of crystallized soda, $6\frac{1}{2}$ pounds of sugar of tin, and $3\frac{1}{4}$ pounds of spirit of sal-ammoniac.

Manner of Preparing the Mordants. First dissolve the alum in hot water, then add the coloring matter, for instance cochineal and solution of tin, etc.; next the sal-ammoniac and the alkalies, as soda, potash, liver of sulphur, and finally the spirit of wine and gum Arabic,

Use of Metallic Sulphides as Mordants in Dyeing Cottons with Aniline Colors. For the purpose of mordanting with sulphide of zinc the cottons are dipped for a short time into a solution of 15 parts of sulphate of zinc in 10 parts of water. They are then dried and placed for 2 minutes in a solution of sulphite of soda of 15° Beaumé. To mordant with sulphide of tin the cottons are immersed for a short time in a bath containing $\frac{1}{2}$ pint of stannate of soda, of 20° Beaumé, and $\frac{1}{2}$ pint of sulphide of ammonium. They are then placed, while still moist, in sulphuric acid of 2° Beaumé. In both cases the mordanted cottons are dyed hot in a watery solution of aniline colors. The coloring matter forms a combination with the metallic sulphide which cannot be washed out with hot water.

Practical Directions for Dyeing Cotton Yarn Turkey-red with Alizarine. Six hundred and fifty pounds of yarn are boiled with $18\frac{1}{2}$ pounds of calcined borax, in a high-pressure boiler, for 10 to 12 hours, at a pressure of 1.5 atmospheres. It is then passed through a mixture of 45 pounds of sheep or cow dung and 10 gallons of solution of potash of 1.1598 specific gravity and the necessary quantity of water. After it has been dried at 130° to 145° F. it receives the first oil mordant. This is composed of 55 pounds of oil, $7\frac{3}{4}$ gallons of the above solution of potash, and the residue of a former lot. It is first dried in the air and then thoroughly in the drying room at 145° F. It now receives the second oil mordant, composed as the first. This is succeeded by a clear mordant containing $4\frac{3}{4}$ gallons of solution of potash, 40 gallons of the rinsing water, and the residue of both oil mordants. The yarn is then immediately dried in the drying room at 130° F. When dry the second clear mordant, composed like the first, is applied and the yarn again dried. It is then placed over night in a solution of 2 to 3 pounds of tannin, and galled. After it has been wrung out it is placed in the alum mordant, which contains either 165 pounds of sulphate of magnesia dulled with 22 pounds of calcined soda, or 165 pounds of alum dulled with 23 pounds of chalk. The yarn is then again dried, mordanted with soda, and washed. In

dyeing, 8½ pounds of alizarine, 4½ gallons of blood, and, according to the quality of the water, 1½ ounces of tannin and chalk are used for 88 pounds of yarn. After the yarn is dyed it is brightened for 10 hours in the high-pressure boiler with 25 pounds of calcined soda; then acidulated with 3½ pounds of tin salt, 1 pound of nitric acid, and 8½ ounces of alum; next soaped with 22 pounds of soap, 5½ pounds of soda, 2 pounds of tin salt, 11½ ounces of nitric acid, and 1 pound of annotto, and finally washed, oiled, loaded, and soaked.

To Prepare the so-called Turkey-red Oil. The following process furnishes a Turkey-red oil which, when dissolved in water, gives a clear fluid well adapted for dyeing and printing with alizarine. Add in a thin stream and with constant stirring 1½ pounds of sulphuric acid of 66° Beaumé to 6¾ pounds of castor-oil. Heating during the process should be carefully avoided, but should it occur, the adding of sulphuric acid must be interrupted until the mass has entirely cooled off. The greater the quantity worked at one time the greater is the danger of heating and the consequent spoiling of the product. If the work is carried on on a large scale it is best to use vats lined with lead. The mixing of the sulphuric acid with the oil requires from 2 to 4 hours; 3 hours suffice for the above-mentioned quantity. The mass is now allowed to stand quietly for 12 hours, when it is diluted with 1 gallon of water. Calcined soda in small portions is now added until litmus paper is no longer colored red. About 1½ pounds of pure soda will be required. This operation must be carried on very slowly, as, on account of the escape of carbonic acid, a strong foaming will take place. The mass gives now a white emulsion with water. To obtain a clear solution ammonia is added until a sample gives a clear solution with water. It is then allowed to settle for about 12 hours, when the now finished Turkey-red oil is drawn off by means of a siphon. The sodium sulphate which has been formed by the re-neutralization will be found as a crystallized residue on the bottom of the vessel.

English Alizarin oil (Patent Oil) is composed of 48.69 per cent. of water,

4.67 per cent. of castor-oil, 43.90 per cent. of ricinoleic acid, and 3.685 per cent. of ash. Such oil is prepared by a complete saponification of castor-oil with caustic soda. The resulting soap is decomposed with diluted acid. The separated fatty acids are removed by water and then compounded with a like quantity of water and a sufficient amount of caustic soda, that about ⅓ of the castor-oil used is again saponified. After boiling the mixture it is allowed to cool and is then converted into an emulsion by stirring.

A New Dye. The young shoots of the poplar tree yield a dye which can be extracted as follows: The young twigs and branches are bruised and boiled for 20 minutes with a solution of alum—10 pounds of wood requiring 1 pound of alum—in 3½ gallons of water. The solution is filtered hot and allowed to cool, and after standing some time is again filtered from a resinous deposit. On exposure to air and light it develops a rich gold color and may be used directly for dyeing orange and yellow shades upon all classes of goods.

ELECTRO-PLATING, GALVANOPLASTY, GILDING, NICKELLING, SILVERING, TINNING, ETC.

Nickel Plating. The double sulphate of nickel and ammonium, which is the salt that is generally used, may now be had in commerce almost pure. The anodes should considerably exceed in size the articles to be covered with nickel. Any common form of battery may be used. Three *Daniell's* cells, or two *Bunsen's*, connected for intensity, will be found to be sufficient. The battery power must not be too strong, or the deposited nickel will be black. A strong solution of the sulphate is made, and placed in any suitable vessel; a glazed stoneware pot answers very well if the articles to be covered are small. Across the top of this are placed two heavy copper wires, to one of which the articles to be covered are suspended, to the other the anode. The wire leading from the zinc of the battery must then be connected with the wire from which the articles are suspended, the other battery-wire being connected with the anode.

To prepare the articles for coating, they must be well cleansed by scrubbing them, immersing in boiling potash, to remove any grease, then dipping them for an instant in muriatic acid, and afterwards washing thoroughly in water, taking care that the hand does not come in contact with any part of them. This is accomplished by fastening a flexible copper wire around them and handling them by means of it. The wire serves afterwards to suspend them in the bath.

If the articles are made of iron or steel, they may be first covered with a thin coat of copper. This is best done by the cyanide bath, which is prepared by dissolving precipitated oxide of copper in cyanide of potassium. A copper plate is used as an anode. After they are removed from the copper bath, they must be washed quickly with water and placed in the nickel bath. If allowed to become dry, or to tarnish, the nickel will not adhere. Great care must be observed during the whole process to keep all grease, dust, or other dirt from the articles to be coated, or else the result will be unsatisfactory. The whole process is one of the most difficult that is used in the arts, it being far easier to gild, plate, or copper an article than to nickel it; but if due care is taken the results will amply pay for the trouble.

Improvement in Nickel Plating. E. Weston, of Newark, N. J., has found that an addition of boracic acid adapts the different salts of nickel better for electrolytic separation than any other substance, and especially prevents the formation of sub-salts of nickel on the cathode. The following mixtures can be especially recommended: Five parts of nickel chloride and 2 of boracic acid; or 2 of nickel sulphate and 1 of boracic acid. The nickel precipitated from these solutions adheres very tenaciously.

Sheet metal plated by this process can be polished, stamped, and fashioned into various shapes without injury to the coating.

Martin and Delamotte's Process of Nickel Plating. Prepare a bath of:

Water 3.3 gallons.
Citric acid 2¼ pounds.

Ammonium chloride or ammonium sulphate 1 pound.
Ammonium nitrate 1 "

The bath is heated to 175° F., and gradually saturated with freshly precipitated nickel hydrate. It is then removed from the fire, saturated with ½ gallon of ammonia, and diluted with water to a bulk of 5½ gallons. It is now allowed to become cold. One pound of ammonium carbonate is then added, the fluid is allowed to settle, and is finally filtered.

It is blackish-blue, and shows 11° B. A white layer of nickel of great density and brilliancy is deposited by electrolysis. The temperature of the bath, when used, should be about 120° F. A thicker coating can be obtained by adding hydrate of potassium or of sodium.

Latest Improvements in Nickel Plating. The double salts of nickel and ammonia, generally used in nickel plating, have not given entirely satisfactory results. After many experiments *Powell, of Cincinnati,* has found that an addition of benzoic acid to 1 of the nickel salts (especially when a decidedly alkaline solution is used) suffices to produce a beautiful silver-white coating, which is very hard, uniform, and adhesive. The solution is at the same time more durable, the anodes dissolve freely, and the specific gravity of the fluid remains unchanged. The addition of benzoic acid may vary from ¼ ounce to 1½ ounces to the gallon, according to the nature of the solution. Instead of benzoic acid one of its salts, for instance benzoate of nickel, may be used, and such addition may also be advantageously employed for solutions of cobalt and other metals. The inventor recommends the following proportions for a bath of 1 gallon:

I.

Nickel sulphate 4¼ ounces.
Nickel citrate ¾ "
Benzoic acid 1 ounce.

II.

Nickel chloride 2 ounces.
Nickel citrate 2 "
Nickel acetate 2 "
Nickel phosphate 2 "
Benzoic acid 1 ounce.

III.

Nickel sulphate	3¼ ounces.
Nickel citrate	3¼ "
Nickel benzoate	1 ounce.
Benzoic acid	¼ "

IV.

Nickel acetate	3¼ ounces.
Nickel phosphate	1 ounce.
Nickel citrate	3¼ ounces.
Sodium pyrophosphate	2 "
Sodium bisulphide	1 ounce.
Ammonia	5½ ounces.

As benzoic acid is difficult to dissolve in water it is best to heat the nickel salts in a sufficient quantity of water, and to add the benzoic acid during the boiling. It will thus dissolve much easier with the nickel salts than in pure water.

The great advantage of these solutions is that the manufacturer is no longer restricted to the use of certain chemically pure salts. For preparing the acetate, citrate, and sulphate of nickel, respectively, the ordinary acids of commerce can be used, as the injurious influences of the impurities, always present in these salts or acids, are entirely neutralized by the benzoic acid. These solutions are also adapted for electrotyping purposes, where the metal is deposited upon surfaces rendered conductive by a thin coating of graphite, bronze powder, etc. The deposit, as soon as the desired thickness has been obtained, can also be detached in the same manner from the surface or the metal. In case the solutions to be used contain alkaline salts, it is best to prevent a possible incomplete decomposition of the fluid by an addition of sodium pyrophosphate. Finally salicylic, gallic, or pyrogallic acid may be substituted for a part or the whole of benzoic acid.

Receipts for Ordinary Nickel Baths.

I. Boil, with constant stirring, for ¼ hour, 1 pound of the double sulphate of nickel and ammonium and ½ pound of hydrochlorate of ammonia in 1½ gallons of water, and let the fluid cool over night.

II. Boil for ¼ hour 1 pound of the double sulphate of nickel and ammonium and 1½ ounces of citric acid in 2 gallons of water. Then allow it to cool and add from ¼ to ¾ ounces of

carbonate of ammonia in small pieces until the fluid is neutralized.

III. Boil for ¼ hour 10½ ounces of the double sulphate of nickel and ammonium, a like quantity of sulphate of ammonia, and 1½ gallons of water, and let the fluid cool.

IV. Dissolve 10½ ounces of the double sulphate of nickel and ammonium by boiling in 3½ quarts of water, and allow the fluid to cool. The solution is neutralized with spirit of sal-ammoniac, and diluted with water, until it is concentrated to 20° to 25° B.

V. Dissolve 2½ pounds of the double sulphate of nickel and ammonium, 1½ pounds of hydrochlorate of ammonia by boiling in 8½ gallons of water, and make the fluid slightly alkaline so that it shows 3° to 4° by the hydrometer, by adding 3¼ pounds of caustic ammonia.

VI. Dissolve 1 pound of the double sulphate of nickel and ammonium, 10½ ounces of hydrochlorate of ammonium, and 7 ounces of sulphate of ammonium by boiling in 1½ gallons of water, and allow the fluid to cool.

American Nickelling. The following baths are in use in a number of large American manufactories:

I. *Bath for Iron, Cast-iron, and Steel.* Dissolve 2 pounds of the double sulphate of nickel and ammonium and 5¼ ounces of sulphate of ammonia by boiling in 5½ gallons of water.

II. *Bath for Brass, Copper, Tin, Britannia Metal, Lead, Zinc, and Tinned Sheet Metal.* Dissolve 2 pounds of the double sulphate of nickel and ammonium and 7 ounces of sulphate of ammonium by boiling in 6½ gallons of water, and let the fluid cool. In case any acid should still be present a little hydrochlorate of ammonia must be added, so that red or blue litmus paper remains unchanged.

Latest Anglo-American Nickelling. The best nickel-plating, for the excellence of which we can vouch, is accomplished by using the following bath: Two pounds of the double sulphate of nickel and ammonium and 1 pound of refined boracic acid are boiled for ¼ hour, when the fluid is allowed to cool. This bath gives a silver-white plating, and all parts of the article receive a uniform nickelling and remain unchanged even if con-

tinuously used, which is not the case with other nickel baths. In nickelling large articles, several nickel anodes must be suspended on each of the four sides. In nickelling plates, cups, etc., a plate of nickel must be suspended in the centre of the hollow, but should be, if possible, kept at a distance of 2 to 4 inches from the article to be nickelled. A strong Bunsen battery of 4 to 8 elements, or, what is still better, a dynamo-electric machine, is used.

Preparation of the Metals to be Nickelled. The treatment of iron and steel requires no further explanation. We advise to first immerse the articles for some time in a boiling hot solution of caustic soda or potash, next to rub them thoroughly with a brush, then to rinse with cold water, and finally to dip them into an acid pickle consisting of 1 part of sulphuric acid and 2 of hydrochloric acid to 10 of water, after which they are again rinsed, thoroughly rubbed with fine, washed pumice-stone or Vienna lime, rinsed off, and at once brought into the bath. Fine polished instruments of iron and steel for surgical, dental, and other purposes, scissors, knives, and telegraphic instruments are treated in the same manner, but in place of the washed pumice-stone they should be brushed with whiting or tripoli, or, what is still better, with infusorial earth. Brass, bronze, Britannia metal, etc., are also treated with a hot solution of caustic soda or potash, then rubbed and brushed, rinsed with water, and at once placed in a solution of cyanide of potassium. They are then cleansed with a bristle brush kept for that purpose, carefully rinsed in water, and at once brought into the bath. The variegated colors produced upon brass by the action of the solution of caustic soda disappear almost instantaneously in the solution of cyanide, and a bright surface of the metal is sure to be obtained. Special attention must be paid to the careful rinsing of the articles, especially if they have hollow places and depressions, after they have been treated in the solution of cyanide of potassium, to prevent the nickelling bath from being contaminated by the cyanide. For many articles of brass having more or less matt and polished places, it is sufficient to dip them (after

having been freed from all fatty substances by boiling potash and subsequently rinsing in water) into the mixture of acids, then to rinse them again, and to bring them at once into the bath. For iron articles the use of finely sifted pumice-stone or chalk is absolutely necessary. Copper wire should be tightly wound around all articles of metal, and two or more wires around large articles. In articles consisting of two metals, for instance iron with steel or with brass, the wire must be wound around both metals. Smaller articles are suspended from copper hooks. The articles should not be immersed in the nickelling bath until the battery or machine is in action. The suspended articles remain in the bath until they have acquired a white color, which, according to the strength of the electric current and the number and size of the articles suspended, will require from 5 to 30 minutes. Large articles of steel or iron require longer than brass, copper, etc., and, if they fill the entire bath, must remain in it, according to circumstances, for several hours or an entire night. In case the article to be nickelled assumes a gray or black color, or feels gritty or rough, the current is too strong. The article, after its removal from the bath, should immediately be dipped for a few seconds in boiling hot water, then allowed to drain off, dried in warm sawdust free from rosin, and, if necessary, polished. Fine articles are rubbed with a polishing brush or with soft leather and whiting. Polishing the articles with a burnishing steel after they have been nickelled is not admissible, as the coating is too hard and brittle for such usage. The better they have been polished *before* plating, the more beautiful will be the nickelling.

To Nickel Iron without the Use of Electricity. To a solution of chloride of zinc 5 to 10 per cent. strong add enough nickel salt to give the usual color of nickel baths. Cleanse the articles and put them in the solution for $\frac{1}{2}$ to 1 hour.

Doumesnil's Process of Platinizing Metal. The precipitate obtained by treating a solution of platinum chloride with sal-ammoniac is intimately mixed with finely pulverized borate of lead by adding water. The articles, which should

first be thoroughly cleansed, are coated with this mixture and then subjected to a strong heat in a sheet-iron muffle.

Platinizing of Metals. Optical instruments, etc., are platinized by boiling them in a solution of $\frac{3}{4}$ ounce of ammonio-chloride of platinum and 3 ounces of sal-ammoniac in 14 ounces of water. This solution may also be used for copper and brass articles. Platinum plating is a subject about which very little has been said or written, as electro-platers who have actually obtained good results have kept the process a profound secret. We give below receipts received from acknowledged authorities and from private sources. There are two methods of platinum plating: by dipping without the use of a battery (boiling), and by electrolysis. Copper and its alloys are best adapted for platinizing, as the platinum adheres well to them, but not very well to iron, zinc, tin, and lead. The following solution is recommended for platinizing by boiling: One part of pure chloride of platinum in solid form and as neutral as possible and 10 of entirely pure sodium hydrate are separately dissolved, each in 50 parts of water, and the platinum solution is then carefully poured into the sodium lye. When the two solutions have been thoroughly mixed add ammonia until the mixture shows a perceptible odor of it. The bath is heated to the boiling point, the articles, which should first be thoroughly cleansed, are dipped into it, and, as soon as they have acquired a white, brilliant coating, rinsed in hot water, dried in sawdust, and, if necessary, again dipped. This coating, no matter how well it may look, will necessarily be very thin and not capable of resisting acids, scouring, etc. Electroplating is necessary for most purposes. A skilled and experienced operator, by accurately observing the following directions, can obtain a deposit of any desired thickness and showing the same lustre as pure platinum: Dissolve 10 drachms of pure chloride of platinum in 7 ounces of water. Then dissolve $1\frac{3}{4}$ ounces of ammonium phosphate in 7 ounces of water. Mix this with the solution of platinum, disregarding the precipitate which is formed. In the meanwhile bring $10\frac{1}{2}$ ounces of water

and $3\frac{1}{2}$ ounces of sodium phosphate to the boiling point, and add, while this is boiling, the thoroughly shaken solution above described. Continue to boil the mixture until the fluid has become entirely clear and the odor of ammonia entirely disappears, and the solution, at first alkaline, ceases to impart a blue color to reddened litmus paper. When this bath is cold and has been filtered it is ready for use. It requires a strong, constant current and a large anode.

According to *Jewreinoff*, copper and brass can be electroplated with platinum to any desired thickness by taking the articles from time to time from the solution of platinum and scouring them with whiting. The salt of platinum used is prepared in the following manner: One hundred parts of potassium hydrate dissolved in water are added to a solution in water of the chloride of platinum obtained from 100 parts of metallic platinum. The minute yellow crystals of platino-chloride of potassium which are formed are heated with 20 parts of oxalic acid in a porcelain vessel until they disappear, and, when the solution is complete, 300 parts more of potassium hydrate, dissolved in water, are added.

To Electroplate Metals with Cobalt. The same formulæ as have been described under nickel plating will be found to answer also for cobalt by simply substituting cobalt salts for those of nickel where these are named. The deposit is even more brilliant than that of nickel. (W.)

Plating with Aluminium. Dissolve any desired quantity of salt of aluminium, such as the sulphate, muriate, nitrate, acetate, cyanide, etc., in distilled water, and concentrate the solution to 20° Beaumé in a suitable vessel to hold the articles to be plated. The battery to be used should be 3 pairs of Bunsen's zinc-carbon, with the elements connected for intensity, and an anode of aluminium attached to the negative wire. The solution should be slightly acidulated with its appropriate acid, heated to 140° F. and kept at that temperature during the operation.

Gilding Copper by Boiling. Take a liquid amalgam consisting of 4 parts of mercury, 2 of zinc, and 1 of gold. Mix this amalgam with 8 parts of hydro-

chloric acid and add 1 of salt of tartar. Cleanse the copper thoroughly with *aqua-fortis*, and then boil it in the fluid until it has assumed a bright gold color.

To Impart a more Brilliant Gold Color to Gilded or Gold-plated Articles. Reduce the following ingredients into an impalpable powder :

Sulphur	5 parts.
Alum	2 "
Arsenic	2 "
Turneric	1 part.
Native antimony	1 "

Boil and skim urine, put the powder in this, and boil for $\frac{1}{2}$ hour. Then place the articles in the fluid and boil until the color is sufficiently brilliant.

Instead of urine the following fluid may be used :

Sal-ammoniac	3 parts.
Common salt	1 part.
Vinegar	6 parts.
Water	23 "

To Silver Articles of Bessemer Steel. Bessemer sheet steel is now much used, instead of brass or German silver, for manufacturing all kinds of utensils—soup tureens, tea and coffee-pots, spoons, knives and forks, etc. *C. Satori*, of Vienna, has obtained a patent for coating these articles with silver by the following process: The articles are first cleansed from all adhering grease by washing them in hot lye. They are then pickled with diluted hydrochloric acid and scoured with sand. Solution of mercury in nitric acid is dropped into water slightly acidulated with hydrochloric acid until a cleansed strip of copper dipped into the fluid becomes covered with a white coating. But as iron does not amalgamate, like other metals, by dipping it simply into the fluid, it is connected with the zinc pole of a Bunsen cell and submerged in the solution of mercury. The Bessemer steel will thus accept a coating of mercury, when it is taken out, thoroughly washed, and silvered in the usual silver bath. The articles are taken from the silver bath, thoroughly washed, and heated upon a coal fire until they hiss when touched with the wet finger. They are then allowed to cool off, scratch-brushed, and, if necessary, polished.

Adrielle's Process of Silvering Metals. Dissolve $3\frac{1}{2}$ ounces of silver in double that quantity of nitric acid. Next dissolve 2 pounds of cyanide of potassium in $2\frac{1}{2}$ gallons of water. Filter and mix the 2 solutions. Then add $6\frac{1}{2}$ ounces of whiting, and put the fluid in green bottles. When articles are to be silvered, prepare a bath of 1 part of the fluid and 3 of water. Shake the bottle and pour the fluid into the bath. The article, after it has been silvered, is polished with chalk.

Piffard's Galvano-plastic Silvering. The cleansed surfaces of the articles to be silvered are first washed with a solution of nitrate of silver, so that a thin film is formed. When dry, the article is exposed to a current of sulphide of hydrogen. The coating thus produced is very conductive, and a deposit of silver adheres very firmly to it when the article is brought into the electroplating bath.

Silvering Tincture. Experiments have shown the following receipt for a silvering tincture to be excellent. Prepare the following solutions:

A. 2 parts of burned lime, 5 of grape sugar, 2 of tartaric acid, 650 of water.

The solution is filtered and put in bottles which should be filled entirely full and well corked.

B. Dissolve 20 parts of nitrate of silver in 20 of aqua-ammonia, and then add 650 of water.

Just before the tincture is to be used mix solutions A and B together, shake well and filter. Metals and dry vegetable substances, such as wood tissues, horn-buttons, ivory, etc., can be silvered with this fluid.

Cold Silvering of Copper. The amalgam consists of 1 part of the finest tin filings and 2 of mercury, which are intimately rubbed together in a porcelain mortar. When a semi-liquid amalgam has been obtained, add 1 part of silver precipitated from a nitric acid solution by metallic zinc and thoroughly washed. When the mixture has been made homogeneous by rubbing, mix it thoroughly with about 8 parts of bone-dust. The process of silvering is carried on by means of a moist cloth. The silvering is accomplished at once, and is both beautiful and durable. The article should finally be rubbed with a

dry cloth. If many and large pieces are to be silvered, it is better to amalgamate the surfaces first by an instantaneous dip into a saturated solution of mercury in nitric acid. This process is technically called "quicking."

New Process for Making Silvered Telescopic Mirrors. Telescopic reflecting mirrors can be cheaply and easily produced by the electroplating process. Take a mould of a convex surface made of a mixture which is either an electrical conductor itself or else a non-conductor metallized by the aid of nitrate of silver and phosphorus dissolved in sulphide of carbon. In either case the mould is plunged in an electroplating bath of silver, where the current conducted very slowly to the mould determines a deposit of excellent quality.

When the silver has the thickness of an ordinary sheet of paper, the bath of that metal is replaced by one of copper to obtain a solid backing. The mould is then dissolved or melted, and the mirror removed, nothing further being necessary than a light polishing. Perfect mirrors 4 inches in diameter have been produced in this manner.

New Process for Silvering Iron and Steel. Pierre de Villiers, of St. Leonards, in England, has devised the following process of silvering: he uses an alloy of 80 parts of tin, 18 of lead, and 2 of silver; or 90 parts of tin, 9 of lead, and 1 of silver. The tin is first melted, and when the bath has acquired a white lustre the granular lead is added, and the mixture thoroughly stirred with a pine stick. The partly melted silver is then added, and again stirred. The fire is now urged until the surface of the bath assumes a light yellow color, when it is vigorously stirred, and the alloy poured out in ingots. The process of silvering steel is carried on in the following manner: The article, for instance a knife-blade, is dipped in a solution of hydrochloric or sulphuric acid consisting of 1 to 10 parts of acid in 100 parts of distilled or rain water. When taken from this acid bath it is at once rinsed off in clean water, then dried and rubbed with a piece of soft leather or a dry sponge. It is then placed in a muffle and exposed for five minutes to a temperature of 150° to 175° F. The object of this operation is to prepare

the steel for the reception of the alloy, making it, so to speak, porous. The article, while still retaining a heat of 120° to 140° F., is dipped in the above-mentioned alloy, which has been melted in a crucible of graphite or refractory clay over a moderate fire. The bath must be entirely liquid, and stirred with a stick of pine or poplar wood. The surface of the bath should have a beautiful white silver-color. To coat a knife-blade 2 minutes suffice for dipping. Larger articles must be immersed up to 5 minutes.

After the article has been taken from the bath it is dipped in cold water, or treated otherwise as may be necessary for hardening it, if required, but it must not be left too long in the water as this frequently renders it brittle. Nothing further is now necessary than drying the article, without the aid of heat, by rubbing, and subsequently polishing.

The articles thus treated have an appearance resembling silver and a similar ring, and resist oxidation when exposed to the air. To protect them against acids they are dipped into a bath of 60 parts of mercury, 39 of tin, and 1 of silver. While warm they are then dipped in melted silver, or plated by the electrolytic process.

The silvering is extraordinarily durable. It is claimed that this process is comparatively cheap. Should this be the case, this process of silvering might frequently be preferable to nickelling, as a coating of nickel is apt to flake and nickelled articles soon lose their lustre by handling.

Tinning of Cast-iron. Dissolve 1 part of chloride of tin in 10 of water, and 2 parts of caustic soda in 20 of water, and mix the two solutions. The fluid will become turbid, but this exerts no influence whatever upon the process of tinning. The articles to be tinned are heated before they are dipped into the fluid. A fragment of metallic tin should be placed in the bath during the process, and the liquid must be frequently stirred.

Another Receipt. Boil three parts by weight of rye flour in 100 of water for 30 minutes, and strain. Add to the resulting fluid, which should be clear but thickly fluid, 106 parts of sodium phosphate, 17 of crystallized stannous

chloride, 67 of solution of stannous chloride, and 25 of sulphuric acid. The articles are first thoroughly cleansed and then dipped into the bath, where they remain for a short time.

To Tin Cooking Utensils. The articles are placed in a bath of 8 parts of stannous chloride, 16 of tartar, and 2 of stannic chloride, the presence of the latter accelerating the process. The articles are connected by a wire with the positive pole of a Bunsen's battery, while the negative pole communicates with a piece of tin dipping into the fluid.

Cold Tinning. The articles are freed from adhering grease by immersion in boiling potash lye, then pickled in an acid bath (15 to 20 per cent. of sulphuric acid), carefully scoured with sand, and brought into the tinning bath. This consists of 7 to 10½ ounces of tin salt, 10½ ounces of alum, 7 ounces of tartar, in 22 gallons of water. A strip of tin is wrapped around the different articles before dipping them into the bath, where they remain for 8 or 10 hours or longer, according to the thickness of the coating they are to receive. The articles are taken from the bath, rinsed off, and placed in water in which from ¼ to ½ ounce of carbonate of magnesia per quart has been dissolved.

New Process of Galvanizing Iron. The article to be galvanized is first cleansed with diluted acid, next rinsed off, then placed in a solution of zinc salt, and connected with the positive pole of a dynamo-machine. Zinc plates connected with the negative pole are suspended in the fluid, and the machine is set to work. The surface of zinc produced in this manner is provided with a metallic lustre by quickly moving the articles over a fire, or placing them in a chamber sufficiently hot to melt the zinc. If at the instant that this takes place a shock is given to the articles, the coating will assume the spangled appearance so much sought after.

Gourlier's Salt Mixtures for Galvanic Coppering, Bronzing, etc. The following bath is used for coppering: One thousand parts of distilled water, 40 of yellow prussiate of potash, 20 of subsulphide of copper, and 20 of potassium carbonate.

For a *Coating of Brass* add 25 parts of sulphate of zinc to the coppering fluid, and filter the solution.

The bath for *Bronzing Wrought and Cast-iron* consists of 1000 parts of distilled water, 58 of yellow prussiate of potash, 15 of chloride of copper, 40 of tin salt, and 40 of sodium hyposulphite. Pour the above-mentioned bath in a cast-iron boiler and heat over a moderate fire. The metal to be coated with copper, brass, or bronze is connected with the cathode of the galvanic battery and submerged in the bath, using as an anode a piece of the metal that is to be deposited. The metals to be coated must first be thoroughly cleansed or polished.

To Coat Wire with Brass. A warm bath contained in an oval iron boiler lined with sheet brass is used for depositing a coat of brass upon wire by galvanic means. The sheets of brass are connected with the copper pole of the battery and dipped into the fluid. The bundles of iron wire are first opened, dipped into sulphuric acid, then suspended to a strong wooden peg, and scoured with a brush and sharp sand. They are next placed over a strong copper or brass rod resting upon the edge of the boiler and insulated therefrom by means of rubber tubes; and connected with the zinc pole of the battery. The wires now receive a coating of copper, and then the deposit of brass. As they are only partly submerged in the bath, they must be turned from time to time. They are finished by washing, and drying in sawdust. For other articles a cold bath is prepared in a box lined with gutta-percha.

The baths are prepared in the following manner:

Warm Bath. Four and three-quarter ounces of blue vitriol, 4½ to 5½ ounces of sulphate of zinc are dissolved in 1 gallon of water. The solution is precipitated with 2 pounds of crystallized soda, decanted and washed. A solution of 1 pound of soda and 8½ ounces of sodium bisulphate in 1 gallon of water is poured over the precipitate. The mixture is stirred and commercial potassium cyanide added until the fluid becomes clear. The fluid is then filtered off from the suspended ferric oxide.

For the cold bath mix :

Calcium carbonate, freshly prepared	2¼ ounces.
Carbonate of zinc	2¼ "
Sodium carbonate	4½ "
Monosodium hydrogen sulphite	4½ "
Potassium cyanide	9 "
Arsenious acid	¼ drachm.
Water	1 gallon.

Coppering Bath for Wrought and Cast-iron or Steel Articles. Melt in a crucible 1 part of dry chloride of copper and 5 or 6 parts of eryolite, combined with chloride of barium to make it more fusible. This mixture will give a permanent coating of any desired thickness to the articles, according to duration of their immersion.

Simple Fire-plating for Iron. A metallic surface washed with sodium amalgam will take up a concentrated solution of gold poured upon it, and after driving off the mercury by the heat of a lamp will present a gilded surface capable of being polished, and will also show any design drawn upon the first metal.

Method and Apparatus for Preparing Paper Matrices for Stereotype Plates. The separate layers of the matrix are pasted together with a paste of starch, glue, glycerine, turpentine, and water. The matrix, while still moist, is taken from the types, and dried in a wire frame by hot air.

The wire frame *b* (Fig. 11) is placed in the muffle *c*, which is provided on

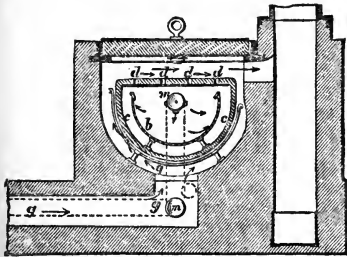

Fig. 11.

the top with holes *d* for the escape of the moisture, and heated by the furnace gases conveyed to it through the flue *g*. In the muffle is another heating pipe

mx provided with openings through which the air heated in the flue *g* is conveyed into the interior of the muffle.

Composition for Moulds for Galvanoplastic Deposits. Melt together 6 parts of white wax, 2 of asphaltum, 2 of stearine, and 1 of lard, and add sufficient lampblack to color the mass deep black. To give more body to the mixture, and to prevent it from sticking to the model, add some plaster of Paris. The model is then oiled, and the melted composition poured over it at as low a temperature as possible. When cold it will form a durable mould.

Elastic Moulds for Galvanoplastic Copies in very high relief can be prepared from 20 parts of glue and 2 of brown rock-candy. Both substances are dissolved in sufficient hot water to form, on cooling, a stiff jelly. After the elastic moulds have been prepared, they are used as a matrix for the stiff moulds by pouring into them a tepid mixture of 12 parts of yellow wax, 12 of nutton suet, and 4 of rosin. This mass, on cooling, becomes very solid.

ENAMELS AND ENAMELLING.

To Enamel Cast-iron Utensils. This is done in Lower Silesia by means of two masses, one for a ground, and the other for a surface coat. For the ground mass 110 pounds of quartz, 50 pounds of borax, and 16½ pounds of fluorspar are ground as fine as possible, and fused together in clay crucibles. Thirty-five pounds of the resulting mass are then mixed with 14 to 27½ pounds of quartz, 9 to 14 pounds of gray clay and 1 pound of borax. This mixture is ground, and during the grinding there should be added 5½ pounds of clay and 1½ pounds of borax. The composition is then formed into a paste with water, applied to the vessels and burned in.

For the surface coat the following ingredients are mixed together:

Fluorspar	5½ pounds.
Zinc oxide	2¼ "
Stannic oxide	10½ "
Bone flour	1½ pound.
Smaltine	1 to 1½ ounces.

To this are added:

Fluorspar	35¼ pounds.
Borax	20 to 21½ "

Sodium carbonate 7 pounds
Nitro $2\frac{3}{4}$ to $3\frac{3}{4}$ "

and the mixture fused in refractory crucibles with a hole in the bottom through which the liquid mass escapes into a vessel placed beneath the furnace. The mass, when cold, is pounded and ground, and 4 ounces of washed white clay and $\frac{1}{2}$ pound of zinc oxide added, during the grinding process, to every 66 pounds of the mass. The composition is then applied like the first, and burned in.

Enamel for Sheet-iron Vessels.

Cleanse the vessels by "pickling" in diluted sulphuric acid, rinse off with water, and scour with fine sand. Then apply a solution of gum Arabic in water; dust upon this, while still moist, the enamelling powder, and dry at 212° F. When the vessel is dry, knock the excess of powder gently off with the hand, and observe whether there are any places which have not been dusted. Should this be the case, they must be again treated in the same manner. The enamel is prepared in the following manner: Sixty-five parts of powdered crystal glass, 10 of calcined soda, and 6 of boracic acid are mixed, ground and sifted several times to make them homogeneous. This powder, after being liquefied upon the sheet-iron vessel in a red hot muffle, forms the ground for the actual enamelling, which is not quite so refractory. This consists of 65 parts of crystal glass, 10 of calcined soda, 2 of boracic acid, and 4 of litharge.

To Enamel Iron. Powder and mix $3\frac{1}{2}$ ounces of crystal glass, 1 ounce of purified potash, 1 ounce of saltpetre, $\frac{1}{2}$ ounce of borax, and $5\frac{1}{2}$ ounces of minium. Heat the ingredients in a clean covered crucible, whereby a strong effervescence will at first take place, and the mass will finally fuse to clear liquid glass. This is poured upon an iron plate previously moistened, cooled off with water, and rubbed to a thin paste upon a glass plate. Pour this paste over the article to be enamelled, allow it to dry very slowly, and then place the article in a hot muffle furnace. The enamel will in a few minutes fuse very uniformly without bubbles and form a lustrous, transparent surface.

To impart an agreeable tint to this

enamel, mix with the above $1\frac{1}{2}$ drachms of a preparation of cobalt obtained by saturating nitric acid with cobalt, decomposing this with common salt and evaporating the mixture to dryness. This gives a pale blue color to the enamel.

To Enamel Copper Cooking Utensils.

Powder and mix 12 parts of white fluor-spar, 12 of unburned gypsum, and 1 of borax, and fuse the mixture in a crucible. Pour the mass out and when cold rub it into a paste with water. Apply this with a brush to the inside of the vessel, and place this in a moderately warm place, so that the paste will dry uniformly. When dry, heat the vessel to such a degree in a muffle furnace that the paste, which has been applied, liquefies. When cold, the result will be a white, opaque enamel.

Another Process of Enamelling Cast-iron. Keep the articles at a red heat in sand for $\frac{1}{2}$ hour, cool off slowly, and cleanse them with hot diluted sulphuric or hydrochloric acid; then rinse with water, and dry. Coat them with a mixture composed of 6 parts of flint glass, 3 of borax, 1 of minium, 1 of oxide of zinc, finely powdered and roasted for 4 hours at a red heat, then rendered semi-fluid by increased temperature, then cooled in cold water, and 1 part of it mixed with 2 parts of bone meal and made into a paste with water. When the coating on the article is dry, apply a mixture composed of 32 parts of calcined bones, 16 of kaolin, 14 of feldspar, 4 of potash, mixed with water, dried, cooled, and, when powdered, made into a paste with 16 parts of flint glass, $5\frac{1}{2}$ parts of calcined bones, and 3 of calcined quartz with sufficient water. When this second coat is dry, apply a mixture composed of 4 parts of feldspar, 4 of pure sand, 4 of potash, 6 of borax, 1 of oxide of zinc, 1 of saltpetre, 1 of white arsenic, and 1 of pure chalk, mixed, calcined and cooled, and rubbed to a fine powder with $3\frac{1}{2}$ parts of calcined bones and 3 of quartz. The coated articles are heated in a muffle in a furnace, which fuses the last two coatings, and forms an adhesive and brilliant white enamel.

To Enamel and Cement Metals and Other Substances. Cleanse the surface

of the metal and coat it with water-glass. Then treat it with a mixture of waterglass and pulverized asbestos, to which lime or gypsum can be added, and heat it strongly.

This mixture may also be used to join metallic and other substances.

Enamel for Watch Dials. The dials are prepared with a backing of sheet-iron having raised edges to receive the enamel in powder, which is fused. After cooling, the lettering and figuring are printed on the plate with soft black enamel by transferring. The dial is again placed in a muffle to fuse the enamel of the lettering or figuring. The enamel used is composed of white lead, arsenic, flint glass, saltpetre, borax, and ground flint, reduced to powder, fused, and formed into cakes.

Colored Enamels. The ingredients are pounded to a fine powder in a stone mortar and then placed in a heated crucible.

To prepare the fluxes a suitable furnace is used, which must be entirely free from rust and lined up to the cover with fire-bricks set in clay so that only the opening for the door remains free. Through a hole in the centre of the cover, which is also provided with a cover, the ingredients in the crucible are stirred with an iron rod.

To secure the crucible a piece of brick is laid upon the grate. The firing is done either with charcoal alone or with charcoal mixed with coke.

Preparation of Fluxes. I. Fuse: Eight parts of minium, $1\frac{1}{2}$ of borax, 2 of ground flint, and 6 of flint glass.

II. Fuse: Ten parts of flint glass, 1 of white arsenic, and 1 of saltpetre.

III. Fuse: One part of minium and 3 of flint glass.

IV. Fuse: Nine and one-half parts of minium, $5\frac{1}{2}$ of borax, and 8 of flint glass.

V. Fuse: Six parts of flint glass, 7 of the flux prepared according to No. II., and 8 of minium.

VI. Fuse: Six parts of the flux prepared according to No. IV., with 1 of colcothar.

VII. Fuse: Six parts of minium, 4 of borax, and 2 of powdered flint.

The fluxes prepared as above are cooled off in water, then dried and finally powdered in a stone mortar.

Blue Enamel. Powder and mix 4 parts of black oxide of cobalt, 9 of flint, and 13 of saltpetre. Fuse them thoroughly over a charcoal or coke fire, pulverize, wash in cold water, and triturate 1 part of this powder with 1 of flux No. V.

Another Receipt. Fuse together 1 part of black oxide of cobalt and 1 of borax. Then mix by melting over a good fire 2 parts of this, 10 of blue pot metal glass, and $\frac{1}{2}$ of minium.

Brown Enamel. Fuse together $2\frac{1}{2}$ parts of pyrolusite, $8\frac{1}{2}$ of minium, and 4 of pulverized flint. Take $1\frac{1}{2}$ parts of this mixture and triturate it with 1 part of flux No. IV., and $1\frac{1}{2}$ of iron filings.

Reddish-Brown Enamel. Triturate in water 1 part of brown sulphate of iron and 3 of flux No. I.

Vandyke-Brown Enamel. Fuse together in a crucible 3 parts of flux No. IV., and 1 of iron filings, and lift it out by the tongs. Take 5 parts of this and 1 of black oxide of cobalt, and rub to a paste with water.

Yellow Enamel. Mix in a stone mortar 8 parts of minium, 1 of antimony oxide, and 1 of white oxide of tin. Place the mixture in a crucible, bring it to a red heat, then cool it off, and rub 1 part of this and $4\frac{1}{2}$ of flux No. IV. to a paste with water.

Orange Enamel. Mix and heat without fusing 12 parts of minium, 1 of red sulphate of iron, 4 of antimony oxide, and 3 of pulverized flint. Triturate with water 1 part of this and $2\frac{1}{2}$ of flux No. VII.

Green Enamel. Triturate with water 5 parts of green frit, $\frac{1}{2}$ of flux No. II., and $2\frac{1}{2}$ of flux No. VI. *The green frit* is prepared by fusing together 3 parts of pulverized flint, 3 of flux No. I., $1\frac{1}{2}$ of green pot metal glass, $7\frac{1}{2}$ of minium, $7\frac{1}{2}$ of borax, and $1\frac{1}{2}$ of green oxide of copper. Pound the mixture to a fine powder in a stone mortar.

Dark Red Enamel. Triturate with water 1 part of brown sulphate of iron and $2\frac{1}{2}$ of flux No. VII.

Pale Red Enamel. Triturate with water 1 part of red sulphate of iron, 3 of flux No. I., and $1\frac{1}{2}$ of white lead.

Black Enamel. Triturate with water 1 part of black calcined umber, $1\frac{1}{2}$ of black oxide of cobalt, $1\frac{1}{2}$ of black oxide

of copper, and 3 of flux No. IV. Allow it to dry thoroughly, then heat it in a fire upon a brick covered with pulverized flint, and add $\frac{1}{2}$ part of flux No. III.

Very Beautiful Black Enamel for Inlaying and Ground. Mix and triturate with sufficient water 1 part of black oxide of copper and 2 of flux No. IV.

Black Enamel for Painting and Mixing with Other Colors. Heat small pieces of umber in a crucible until they become black; then wash in boiling water and dry.

Fuse together 10 parts of this prepared umber, 10 of black oxide of cobalt, $10\frac{1}{2}$ of blue flint glass, $7\frac{1}{2}$ of borax, and 12 of minium. For use, triturate 2 parts of this mixture and 1 of flux No. IV.

Opaque White Enamel. Calcine in a crucible 1 part of buck's-horn shavings until they are entirely white, and rub them to a paste with 1 part of flux No. I. Then triturate with water 1 part of Venetian white enamel in cakes, and 1 of flux No. VIII., and fuse the two mixtures together.

Glass Enamel for Iron. The articles, kitchen utensils, signs, etc., coated with this enamel, are not affected by atmospheric influences, nor destroyed by an ordinary fire, and do not rust.

Intimately mix 4 parts of powdered glass, 2 of spar, 1 of saltpetre, $\frac{1}{4}$ of a part of zinc oxide. Fuse them in a crucible, and pour into moulds to become cool. For use, the necessary quantity is triturated with water. Heat the iron utensil to a red heat in a muffle furnace and apply the enamel, which will present a brilliant glass appearance. To color the enamel *blue*, add cobaltic oxide; for *red*, ammonium; for *black*, manganic oxide; for *yellow*, uranic oxide; for *brown*, ferric oxide; for *green*, a mixture of 2 parts of stannic oxide and 1 of manganic oxide; for pure *white*, stannic oxide.

Niello. This metallic enamel is composed of 4 parts of fine silver, 9 of pure copper, 9 of pure lead, 2 of borax, and 48 of flowers of sulphur. The silver is first melted, the copper is then added and, when both are liquid, the lead. The melted metals are stirred with stick charcoal to insure homo-

geneity. The mixture is then poured into a large crucible containing the sulphur. The crucible is placed again upon the fire for a few minutes to keep the mass liquid. It is then poured over brushwood into water so that granules are formed. These granules are collected, dried by exposure to the air, and then pulverized in a mortar. This powder is mixed with spirit of sal-ammoniac to a paste, applied by heating the object to be decorated and rubbing the paste into the lines. The design is engraved on the metal object to be ornamented, the lines being more pronounced and stronger than on an ordinary copper plate for printing. When skilfully applied the paste adheres firmly. An excess of it is removed by files, the surface is then stoned and polished. Niello is undoubtedly the best means for decorating, in a quiet, rich manner, surfaces exposed to friction or wear; it is tougher than enamel.

FEATHERS, OSTRICH, MARABOUTS, ETC. HOW TO WASH, RESTORE, AND DYE.

Ostrich feathers, as is well known, are used most for ornamental purposes. The most beautiful ostrich feathers come into the market from *Algiers*, *Barbary*, and the *Cape of Good Hope*; inferior qualities from *Senegal*, *Madagascar*, and by way of *Alexandria*. The next prominent are the *cock feathers*.

Heron plumes from different varieties of herons are dearer and scarcer. The black feathers, which come mostly from *Crete*, are very highly valued, the white less so. The latter come from *Crete*, *Canada*, and the *East Indies*; the gray mostly from *East Prussia*.

Falcon plumes are the feathers of the gerfalcon.

Bird of Paradise plumes are the tail and wing feathers of a species of bird inhabiting *New Guinea* and *New Holland*.

Marabouts. These come mostly from *South America*, especially from the American ostrich. According to others from a species of stork inhabiting the *East Indies*, *Java*, etc., where it is frequently raised for the sake of its

feathers. Imitations of marabouts are produced from the white down of the turkey.

To Wash Feathers and Marabouts. Take a piece of white soap of the size of a walnut and dissolve it in a pint of water by heating over a fire. When the soap water has become tepid pour it into a wash bowl and dip the feather into it. Then take the feather into the left hand and, with the thumb and index finger of the right hand, squeeze carefully from the top down to the bottom of the vane. After having cleansed the feathers in this manner dip them in fresh, clean water, rinse them off carefully, and starch them by dipping in water in which a tablespoonful of raw starch has been dissolved, and colored with a few drops of liquid wash-blue. Feathers which have been frequently washed especially require this starching. After the feathers have been starched lay them upon a clean linen cloth and allow them to dry—in summer in the sun, in winter near a fire. Before they are entirely dry rub them between the hands until they have regained their former appearance. As the paper wrapped around the wire softens during the washing it must be renewed. For this purpose cut long and narrow strips of paper. Fasten the strip where the wire joins the feather, and wrap the paper obliquely around the wire by turning the latter between the fingers.

To Bleach Feathers. Feathers turned yellow are bleached, according to one process, by soaking them for a few hours in a warm soap bath (175° to 185° F.), which should not be too strong, rinsing, and exposing them, strung upon a thread, for some time to the sun, frequently moistening them in the meanwhile.

According to another process, the feathers, after having been treated in the warm soap bath, are rinsed off and brought into a bath of water acidulated with sulphurous acid. Here they remain for 20 to 30 hours, are then washed, drawn through a weak, lukewarm soap bath, and dried in the sun, or left in the sun for 1 or 2 days, being frequently moistened.

According to *Döbereiner* a solution of carbonate of ammonia is the best

means of bleaching feathers, as it effects the same purpose in a much shorter time than sulphurous acid.

To Restore Crushed and Bent Feathers. Expose the feathers for a few moments to steaming, or dip them for *one minute* into boiling water. Then take them out and let them lie for some time in water of medium temperature. To be convinced of the extraordinary effect of this simple process it is only necessary to crush an ordinary goose-quill lengthwise and to treat it in this manner, when it will come from the water-bath in a condition which will not show in the slightest degree that it ever had been bent or crushed.

To Dye Feathers. The dyeing of feathers is not very difficult; it can be done either warm or cold. All colors, except black, take the more brilliantly the whiter the feathers were before dyeing.

The quill is first made as porous as possible without injuring its lustre. This is done by rubbing it with a piece of carbonate of ammonia without allowing the thumb of the hand to touch the quill. By this the horn-like skin upon the quill is softened and the oil removed from the surface. The feather is next placed in a warm soap bath and then rinsed in cold water until all traces of soap have been removed. The feathers are then prepared for dyeing.

To remove the oil, *Reimann* recommends baths of carbonate of ammonia or a weak solution of soda, in which the feathers are carefully placed so that they cannot bend or break. After they have been dyed they must be kept in constant motion while drying, so that the down will raise up and the feather assume its natural shape and form.

To Dye Feathers Black. This is the most important and at the same time most difficult color. A warm bath (85° F.) of 10 gallons of water in which 1 pound of soda has been dissolved is used for 8 ounces of feathers. The quills are rubbed with a piece of carbonate of ammonia, and the feathers placed in the bath and allowed to remain for 24 hours. Instead of soda, twice the quantity of carbonate of ammonia may be used and the feathers allowed to remain in the bath over night. They are then taken out, rinsed

off with warm water, and placed for 5 to 6 hours in a bath of ferric nitrate 7° Beaumé strong, when they are taken out and rinsed in cold water. Now make an infusion of 2 pounds of logwood and 2 pounds of quercitron; place the feathers in the tepid bath, work them while in it, and heat the latter gradually until it is hot, but not to the boiling point. Finally dissolve 3½ ounces of potash in 1½ gallons of water, and stir 8 ounces of oil into the solution until it is uniformly distributed in it. Draw the feathers separately through this bath, allow them to drain off, and swing them. For this purpose the quills of all the feathers are fastened to a long cord and this is put up in a drying chamber. Several such cords are connected in the centre by a cord drawn across them, the end of which is moved to and fro for some time. By this means a constant swinging motion is imparted to the feathers suspended to the cords while they are drying, and they thus regain their natural lustre. If but few feathers are to be dyed, take each feather by the quill and swing it before the open door of a stove until it is dry. Many dyers, after the feathers have been dyed and rinsed, place them in layers in a box, dusting each layer with gypsum. They are taken out, while still moist, and dried by swinging, when the last traces of gypsum are removed with a soft brush. In this case no oil bath is used. The quills are then rubbed smooth and the feathers curled with a suitable iron.

Other Receipts for Dyeing Feathers Black. I. A mordant is prepared by dissolving:

Green vitriol	1	pound.
Blue vitriol	4	ounces
Alum	4	"
In water	1½	gallons.

The feathers to be dyed are kept in this solution for 3 days, being frequently turned during the time, when they are taken out and rinsed in clean, cold water. Now prepare an infusion of:

Ground logwood	1	pound.
Ground fustic	1	"
In water	½ to ¾	gallon.

When it has been thoroughly boiled, filter the decoction, place the mordanted

feathers in it, and allow them to remain until they are entirely black. Take them out and rinse them in cold water until this runs off entirely clear. They are then dried and rubbed between the hands with a very small quantity of oil, and finally curled.

II. Mix 2 pounds of a solution of ferric nitrate of 60° Beaumé with 1½ gallons of cold water. Keep the feathers in this mixture for 12 hours. Then take them out, rinse in cold water, and finish the dyeing in a mixture of 6½ pounds of an infusion of logwood and a like quantity of an infusion of fustic, not hotter than the hand can bear. Place the cold feathers in this bath and heat gradually in a water-bath. When the feathers have absorbed the coloring matter take them out and add to the bath ¼ ounce of turmeric. Place the feathers in this for ½ hour. After they are dyed black bring them successively into 3 lukewarm baths of soap and water and then dry them. When dry rub them between the hands with a little oil and curl them.

To Dye Feathers Brown. Prepare the feathers in the same manner as for dyeing black, and treat them in an infusion of 2 pounds of catechu in the same manner as given under black. After they have been taken from this bath place them in a warm bath 120° to 140° F. of 4 ounces of potassium chromate in 1½ gallons of water, and work them until they are dyed. If a

Dark Brown Color is desired, put the feathers, after they have been taken from the catechu bath, into a cold bath of acetate of iron of 2° Beaumé, and then into the potassium chromate bath.

Puce-colored. Dissolve 4½ ounces of alum in 3½ quarts of water. Soak the feathers in this for 12 hours, take them out, rinse with cold water, and place them in a lukewarm bath of 4½ pounds of infusion of logwood, and a like quantity of infusion of Brazil wood until they have acquired the desired color. Then take them out, wash, and place them repeatedly in a quite hot bath of logwood and Brazil wood, when the puce-color will be obtained. The color may also be produced by placing the feathers in a bath of ¾ gallon of cold water and a like quantity of decoction of logwood, and heating

this. The feathers are then taken out, 3½ ounces of hydrochlorate of tin are added to the bath, the feathers replaced in it, and allowed to remain until the bath is cold. They are then taken out and rinsed off with cold water.

To Dye Feathers Blue. Prepare a solution of 1 pound of finely ground indigo in 4½ pounds of sulphuric acid. Of this solution stir 10 drops into ¾ pint of boiling water, and fix the color contained in this fluid on a close white woollen cloth of about 2 square inches. Then remove every trace of acid by washing with clean cold water. After the cloth has been wrung out place it in a solution of 1 ounce of crystallized soda in 3½ pints of boiling water, draw off the fluid, and dissolve in it 2½ ounces of tartaric acid. If the feathers are to be dyed pearl blue, dissolve 1 ounce of alum in 2 gallons of water, add to this 55 gallons of indigo solution, place the feathers in the bath, and heat by placing the tub in boiling water. As soon as the feathers have acquired the desired color they are dried without washing. For darker colors take more indigo solution.

To Dye with Indigo Red. A light blue color is produced by placing the feathers in a solution of ½ ounce of tartaric acid, and 1 ounce of indigo red in 1½ pints of water. By adding a little alum to the solution the color becomes more durable.

Bleu de France. Dissolve 4½ ounces of tin salt in 2 gallons of water, then add 3 pounds of ferric nitrate of 50° Beaumé, and stir 1 pound of sulphuric acid into the fluid. Then prepare a mordanting bath by taking 1 pound of the above fluid and 1 gallon of cold water. Mordant the feathers in this, rinse them thoroughly, and dye by placing them in a solution of 2 ounces of red phosphate of iron in water, and heating the bath. The feathers must be dipped alternately into the mordanting and the dyeing bath. After they have passed through the last bath, which should be that of phosphate of iron, they are drawn through a bath acidulated with tartaric acid.

Crimson and Ruby-Red. Dissolve 1 pound of alum in 1½ gallons of water, soak the feathers in this solution for a

few days, take them out and rinse in cold water. To dye the feathers *crimson*, place them in 13 pounds of a decoction of Brazil wood and heat the bath. For *ruby red*, add to the above bath 1 pound of blue archil liquor, place the feathers in it and, when dyed, rinse them in cold water. By adding 4½ ounces of ground turmeric to this bath the feathers can be dyed *chestnut brown*. The decoction of Brazil wood used is prepared by boiling 1 pound of ground Brazil wood in 1½ gallons of water, and straining the liquor.

Rose-color. A fine rose-color is produced by dyeing the feathers with carthamine. Put the carthamine in warm water, place the feathers in the fluid until they have absorbed the dye-stuff, and then take them out. Now compound the bath with some tartaric acid, place the feathers repeatedly in this, rinse them out in cold water acidulated with tartaric acid, dry, and curl them.

For Dark Rose-color use the same baths of carthamine and of tartaric acid, but each by itself. It is best to dip the feathers alternately into the acid bath and the carthamine bath, but they must be finished in the acid bath.

Yellow. Mordant the feathers with alum or a solution of acetate of alumina, and then rinse them with water. Now prepare a decoction of quercitron bark freed from tannin, by precipitating it with a solution of animal glue, or an infusion of fustic, and finish dyeing the feathers in this.

A yellow color can also be produced by pouring boiling water over powdered turmeric, placing the feathers in the warm fluid for 5 minutes, when they are taken out. Some tartaric acid is now added to the bath, the feathers are again placed into it and allowed to remain for 5 minutes longer, then rinsed with cold water, and dried.

Garnet-Brown. The dye is obtained by adding to the bath for ruby red (see above) 4½ ounces of finely ground turmeric, heating the bath and dyeing the feathers in it.

Gray is produced by dyeing the feathers in a sumac bath and passing them afterwards through a solution of sulphate of iron.

Green. Boil 2 pounds of fustic twice, each time in $1\frac{1}{2}$ gallons of water, and dissolve $2\frac{1}{2}$ ounces of alum and 1 ounce of tartaric acid in the decoctions. Place the feathers for a short time in this solution, then take them out, add solution of indigo, or indigo-red, to the bath; and dip the feathers repeatedly in it. When the feathers have assumed a light green color rinse them with acidulated water. For a dark green color add more blue.

Chestnut-brown. The feathers are first dyed ruby-red and then garnet-brown, next washed, and placed for 5 minutes in a solution of $4\frac{1}{2}$ ounces of sulphate of iron in $3\frac{1}{2}$ pints of water. They are then rinsed, replaced in the dye bath, and heated.

Lilac. This color is produced with archil, and the different shades by means of indigo-red and alum. A weak solution of logwood and hydrochlorate of tin may also be used.

Orange. Boil 1 pound of the best annatto with $4\frac{1}{2}$ ounces of potash in $1\frac{1}{2}$ quarts of water until they are dissolved. Then let the fluid cool off to a hand heat, when the feathers are placed in the bath and allowed to remain in it until they have acquired the desired shade of color, then they are rinsed with lukewarm soap water and passed through a weakly acidulated bath.

Ruby-red. Distribute 1 pound of cudbear in $1\frac{1}{2}$ gallons of water, place the feathers in the bath and heat it to a hand heat. When the feathers have acquired a ruby-red color they are washed in clean water, dried, and then curled.

Violet is produced by soaking the feathers in a solution of alum, dyeing in a simple decoction of logwood, rinsing, drying, and finishing.

To Dye Feathers with Aniline Colors.

Feathers may be dyed without preliminary preparation in a lukewarm bath of aniline colors. For lighter shades of color they are placed, after having been freed from oil, in the sulphuring chamber and sulphured. The dyeing bath is prepared by adding the filtered solution of the aniline color to lukewarm water. The feathers, after having been prepared in the manner as mentioned in the commencement of this article, are worked in the bath until

they have assumed the desired color. The further treatment in rinsing and drying is the same as mentioned under *black*.

Rose-color. Use a weak solution of fuchsine, and a strong solution for *ma-genta*.

Reddish-blue. Use *Bleu de Lyons*, which will dissolve in water.

Greenish-blue. Use *Bleu de lumière*, soluble in water.

Genuine Alkali-blue (*Nicholson's blue*) can also be used for dyeing feathers by dissolving 1 ounce of soda in the dyeing bath, and adding the solution of alkali-blue. The feathers are then placed in the bath and dyed a light blue; then they are brought into a bath of 1 ounce of sulphuric acid.

Green is produced by dyeing the feathers in a solution of aniline green;

Orange in a solution of yellow coralline;

Puce in a solution of red coralline. By adding ammonia to a solution of yellow coralline it changes from *orange* to *red*, and the red solution is changed back into orange by an addition of acetic acid. Therefore, by adding aqua-ammonia to a solution of yellow coralline, every shade of color can be obtained and used for dyeing.

A bronze-lustre can be given to the tips of the down by using the following process: Blue or red patent-violet is dissolved in alcohol 90 per cent. strong by placing it in the water bath. The places which are to be bronzed are brushed over with this solution after the feathers have been dyed and oiled. The alcohol evaporates quickly and a beautiful bronze remains behind. Only the violet dissolvable in alcohol should be used for the purpose, as that soluble in water rubs off on the fingers.

FIRE-EXTINGUISHING AGENTS AND MEANS OF MAKING TISSUES, WOOD, ETC., INCOMBUSTIBLE.

Such substances as ammonium sulphate, borax, sodium phosphate and tungstate, and, last but not least, water-glass, which were recommended years ago by Gay-Lussac, Fuchs, and others, form essentially the staple of most of the means recommended at the present

time, although other substances have also been used with more or less success. In the following we give the results of analyses and experiments made in the laboratory of the "Chemiker Zeitung."

Munich Fire-extinguishing Powder is composed of: Common salt 43 per cent., alum 19.5, Glauber's salt 5.1, soda 3.5, water-glass 6.6, water 22.3 per cent.

A mixture composed of 4½ pounds of alum, 10 pounds of common salt, 1 pound each of glauher's salt and soda, and 1½ pounds of water-glass was given to the *Cæthen* fire-brigade and tried in extinguishing a fire in a distillery. It did excellent service. The following mixture can also be recommended: Four parts of common salt, 3 of sodium bicarbonate, and 1 each of Glauber's salt, water-glass, and calcium chloride. This mixture cannot be used for impregnating tissues, as from the chloride of calcium are formed sulphates, carbonates, and silicates which are insoluble in water. Such a mixture might be used for painting the backs of scenes for theatres, etc. If the calcium chloride is omitted—as for instance in the following mixture: 10 pounds of common salt, 6 pounds of sodium bicarbonate, and 2 pounds each of water-glass and sodium sulphate—it would be possible to dissolve it completely in water, but its effect in making the tissues incombustible would not be sufficient to recommend it.

Experiments indicate that a mixture of water-glass and ammonium sulphate acts very well. While water-glass forms a protecting coat which excludes the air, the high value of ammonium sulphate lies in the fact that it becomes decomposed at a high heat, developing vapors, which, like the water-glass, prevent the access of air. But it is found impossible to combine the two agents in a permanent mixture, as the water-glass, which is always alkaline, expels ammonia from the dry ammonium sulphate.

Sal-ammoniac in the following mixtures gives partially satisfactory results:

I.		II.	
	Per cent.		Per cent.
Common salt	30	Sodium sulphate	30
Sodium bicarbonate	40	Sodium bicarbonate	20
Sal-ammoniac	30	Sal-ammoniac	50

Although the impregnated substances do not ignite in an ordinary flame, they cannot resist the more intense heat of a *Bunsen* burner.

If tissues are to be dyed and impregnated it can be done in one bath, provided aniline colors are used. Some aniline color is dissolved in the solution of an impregnating agent, and the tissue, previously mordanted, is drawn through it. The sizing can also be combined with the impregnating agent. The starch is boiled to a paste in the mixture, and the goods are drawn through it in the usual manner. Muslin curtains, filtering paper, and other loose tissues can be made fire-proof without much trouble, but it is more difficult to so impregnate heavier and closer goods, as linen and flannel, so that absolutely no flame is formed.

Vienna Fire-extinguishing Powder consists of a solution of 4 parts of green vitriol and 16 of ammonium sulphate in 100 of water. It is sold at the rate of about 6 cents per pound, while its actual value is about 1¼ cents. A brown precipitate of ferrous hydrate is formed when the fluid which is at first clear is exposed to the air, and for this reason the mixture is not adapted for impregnating fine colored tissues. For all other purposes it does excellent service.

Fluids for Making Tissues Incombustible. I. A solution of sodium tungstate of 28° Twaddle compounded with 3 per cent. of sodium phosphate.

II. Six parts of alum, 2 of borax, 1 of sodium tungstate, 1 of dextrine, dissolved in soap water.

III. Five parts of alum, 5 of ammonium phosphate, 100 of water.

IV. Three parts of borax, 2½ of Epsom salt, 20 of water.

V. Eight parts of ammonium sulphate, 2½ of ammonium carbonate, 3 of boracic acid, 2 of borax, 2 of starch, and 100 of water.

To Make Tissues Incombustible. The *Société d'Encouragement* of Paris has recently awarded a prize of 2000 francs to *J. A. Martin* of Paris for the following preparations for making tissues fire-proof. The conditions under which the award was offered were as follows: The ingredients constituting the preparations must be cheap and easily ap-

plied, must neither injure the tissues themselves nor their colors, must be neither of a poisonous nor caustic nature, must not change in a very moist nor very dry atmosphere, and finally the impregnated tissues and wood must remain incombustible after they have been exposed for one month to a temperature of 100° to 120° F. It was found that *Martin's* fluids made the tissues and the surface of wood incombustible, that they do not attack the tissues and their colors, and that they remained incombustible after having been exposed for several months in a drying chamber to a temperature of 97° F. The experiments were made by the society and at the same time in the different Paris theatres.

I. *For all Light Tissues.* Ammonium sulphate 8 parts, pure ammonium carbonate 2½ parts, boracic acid 3 parts, starch 2 parts, water 100 parts; ¾ part of dextrine (or the same quantity of gelatine may be substituted for the 2 parts of starch).

The fluid is heated to 85° F. and the tissues immersed in it until they are thoroughly permeated. They are then slightly wrung and dried sufficiently for ironing. The quantity of the starch or dextrine or gelatine may be changed according as the tissues are to be more or less stiff.

II. *For Painted Decorations and Wood.* Sal-ammoniac 15 parts, boracic acid 5 parts, glue 50 parts, gelatine 1½ parts, water 100 parts, and sufficient powdered talc to give the mass the necessary consistency. For use it is heated to 120° or 140° F. and applied with a brush. For decorations already painted it suffices to apply it to the back and wooden frames.

III. *For Coarse Linen, Ropes, Straw, and Wood.* Sal-ammoniac 15 parts, boracic acid 6 parts, borax 3 parts, water 100 parts. The fluid is heated to 220° F. and the articles are submerged in it for 15 to 20 minutes, wrung out slightly, and dried.

Cartridges for Extinguishing Fire. Make the shells of parchment paper or sheet lead, and fill them with 4 parts of a salt obtained by mixing 343 parts of sulphate of alumina and 142 parts of sodium sulphate with 432 of water; and 1 part of sodium sulphide, separated

from the 4 parts of the salt by a disk of parchment paper. The cartridge is broken and its entire contents are poured into the water to be used for extinguishing the fire.

To Make Paper Incombustible. The paper, as it comes from the machine and before it is brought upon the drying rollers, is drawn through a solution of 8 parts of ammonium sulphate, 3 of boracic acid, 2 of borax, and 100 of water. The fluid should be heated to 120° F.

To Make Theatre Scenes, Wood, etc., Incombustible. A mixture recently recommended for this purpose consists of the following ingredients: Boracic acid 5 parts, sal-ammoniac 15 parts, potash-feldspar 5 parts, gelatine 1.5 parts, paste 50 parts, water 100 parts. It is applied with a brush. Other mixtures of the same ingredients, with a slight change in their proportions, serve for impregnating sail-cloth, straw, ropes, and wood.

Bucher's Fire-extinguishing Powder, the value of which has been shown at several fires, consists of 30 parts of powdered sulphur, 60 of purified saltpetre, and a small quantity of coke and bole.

Hand-grenades. These consist of glass vessels of various shapes—usually spherical—containing various fire-extinguishing liquids. They are hermetically sealed to prevent the evaporation of their contents. They are designed, as their name indicates, to be thrown into the fire, and by the breaking of the glass to liberate the fire-extinguishing solution on the burning object. (W.)

FIREWORKS.

Bengal Lights. Besides the combustible and coloring components, the fireworks known under this name contain substances which, by yielding oxygen, aid combustion. The principal ingredients used for this purpose are charcoal, lampblack, sulphur, stearine, linseed oil, colophony, sugar, etc. For coloring the lights the following substances are made use of: Sulphide of antimony, arsenical sulphides, nitrate of barium, nitrate of strontium, sulphate of potassium, carbonate of sodium, cupric oxide, boracic acid, chlorate of

potassium, saltpetre, etc. In preparing colored lights the greatest attention should be paid to the absolute purity of the ingredients used, and that they are powdered as finely as possible and very intimately mixed with a spatula after pulverization. Every mixture containing chlorate of potassium must be treated and handled with the utmost care and caution, as such mixtures are liable to spontaneous ignition and even to explosion. For preparing a very fine powder of it, it is best to allow a supersaturated hot solution of chlorate of potassium to become cold, with constant stirring, when the salt will be separated in the form of a very fine crystallized flour, which should be dried without exposing it to direct heat. To secure uniformity the ready mixtures should be sifted. It is advisable to use dry materials only in manufacturing them, not to prepare large quantities at one time, and to store the mixtures in a dry place in hermetically closed vessels.

Colored lights are best used by pressing the mixture into cases (cartridges) of paper twice as long as wide and igniting it by means of a quick match.

Quick Matches are made of 4 parts of saltpetre, 2 of gunpowder, 2 of charcoal, and 1 of sulphur. Quick matches made of this composition never miss fire and are not extinguished by rain or wind.

White Fire. This excellent light, on account of its brilliant whiteness, is especially adapted for night signalling and also for festive occasions. It is produced by mixing 24 parts of saltpetre, 7 of flowers of sulphur, and 2 of realgar.

In mixing the saltpetre with the flowers of sulphur sulphurous vapors are developed which form moist lumps in the mass. To secure a good ignition and quick combustion of the mass it is necessary to dry it thoroughly in an iron pan with gentle heat, as, if this precaution is neglected, it frequently misses fire or ignites and then goes out. The mixture is cheaper than gunpowder, as less labor is required in preparing it and very little danger incurred.

Mohr's White Fire, which is very effective and scarcely ever misses fire, is composed of 24 parts of saltpetre, 7 of sulphur, and 1 of fine charcoal. The

charcoal increases the inflammability of the mixture and shortens the length of time during which the light burns, but adds to its intensity. It is not permissible to use a larger amount of charcoal than that given, as the composition would then approach that of gunpowder.

White Fire for Theatres, etc. I. Forty-eight parts of saltpetre, 13.25 of sulphur, 7.25 of sulphide of antimony.

II. Twelve parts of saltpetre, 4 of sulphur, 1 of sulphide of sodium.

III. Sixteen parts of saltpetre, 12 of mealed powder, 12 of cast-iron filings, 8 of powdered charcoal.

IV. One part of charcoal, 3 of sulphur, 7 of saltpetre, 1 of chlorate of potassium, 4 of sulphide of antimony.

V. Thirty-two parts of saltpetre, 12 of sulphur, 8 of sulphide of sodium, 1 of gunpowder.

VI. One hundred to 133 parts of pulverized antimony, 48 to 206 of pulverized sulphur, 375 to 500 of saltpetre.

VII. Sixty-four parts of pulverized saltpetre, 21 of pulverized sulphur, 15 of gunpowder.

VIII. One hundred parts of potassium carbonate, 10 of sulphide of antimony, 15 of boiled linseed oil.

IX. Eleven parts of chlorate of potassium, 4 of nitrate of potassium, 1 of stearine, 1 of carbonate of barium, 5 of milk sugar.

X. Forty-five parts of sulphide of antimony, 15 of washed flowers of sulphur, 96 of saltpetre, 15 of stearine.

The stearine is either grated or cut in shavings and then rubbed with some pulverized saltpetre into as fine a powder as possible. The other powdered ingredients are then mixed with it and the mixture passed through a fine sieve.

XI. Eighteen parts of saltpetre, 3 of sulphide of antimony, 10 of sulphur, 4 of burned lime (unslaked).

Greenish-white Fire. I. Two parts of sulphur, 1 of oxide of zinc, 2 of sulphide of antimony, 1 of powdered charcoal.

II. Fifty parts of saltpetre, 25 of sulphur, 5 of sulphide of antimony, and 0.5 of alum.

Bluish-white Fire. *Uden* has made experiments in regard to the availability of sulphide of cadmium for pyrotechnic purposes. In the following

mixture the sulphide of cadmium burns with a brilliant white flame surrounded with a magnificent blue border: Mix 20 parts of saltpetre, 4 of sulphide of cadmium, 5 of sulphur, and 1 of pulverized charcoal. This mixture may be used for fire-balls.

Red Fire. I. Forty parts of nitrate of strontium, 15 of sulphur, 5 of chlorate of potassium, and 2 of charcoal.

II. Fifty parts of chlorate of potassium, .50 of nitrate of strontium, 5 of charcoal, and a sufficient quantity of linseed oil to knead the mass together.

Red Fire according to Braunschweiger. Nine parts of nitrate of strontium, 3 of shellac, 1.5 of chlorate of potassium. The shellac need only be coarsely powdered. The above 3 mixtures for red fire possess the advantage of not emitting injurious vapors, and can therefore be used in rooms, etc.

Holtz's Red Fire, which was so much used in Berlin during the festivities in celebration of the victories in the French war, contains no chlorate of potassium, but is simply composed of 1 part of shellac and 4 of nitrate of strontium. The absence of chlorate of potassium makes it possible to store such mixtures without any danger, though the light produced is less intense and brilliant in color. The mixture is not very inflammable, burns better if slightly moistened, develops but little smoke, and, as it burns very slowly, is without doubt the cheapest material for red lights. A very small addition of chlorate of potassium improves the color of the flame very much.

Receipts for other Red-fire Mixtures. I. Fifty-six parts of nitrate of strontium, 24 of sulphur, 20 of chlorate of potassium.

II. Twenty-three parts of carbonate of strontium, 16 of sulphur, 61 of chlorate of potassium.

III. Mix 40 parts of pulverized nitrate of strontium, 6 of pulverized chlorate of potassium, 13 of washed flowers of sulphur, and 2 of pulverized charcoal.

Instead of the rather expensive precipitated chalk, salts of strontia, carbonate of calcium, and the native sulphate of strontium (coelestine), may be used for preparing red fire according to the following receipts:

I. Mix carefully 3 parts of powdered coelestine, 2 of sulphur, and 5 of chlorate of potassium.

II. Three parts of precipitated chalk, 2 of sulphur, 6 to 8 of chlorate of potassium.

III. Twelve hundred and fifty parts of sulphate of strontium, 375 of purified sulphur, 166 of chlorate of potassium, and 133 of antimony.

IV. Seven hundred and fifty parts of carbonate of strontium, 500 of purified sulphur, 1750 of chlorate of potassium.

V. Rub fine and mix 195 parts of nitrate of strontium, 45 of chlorate of potassium, 45 of washed flowers of sulphur, 7.5 of powdered charcoal, and 22.5 of stearine.

VI. Eleven parts of chlorate of potassium, 4 of nitrate of potassium, 5 of milk sugar, 1 of earth-moss seed, 1 of oxalate of strontium.

Purple Fire. Powder and mix 61 parts of chlorate of potassium, 16 of sulphur, 23 of chalk.

Rose-red Light. I. Rub fine and mix 61 parts of chlorate of potassium, 16 of sulphur, 23 of chloride of potassium.

II. Pulverize and mix 20 parts of sulphur, 32 of saltpetre, 27 of chlorate of potassium, 20 of chalk, 1 of charcoal.

Red-orange Fire. Pulverize and mix 52 parts of chlorate of potassium, 14 of sulphur, 34 of chalk.

Dark-violet Fire. Rub fine and mix 60 parts of chlorate of potassium, 16 of sulphur, 12 of carbonate of potassium, and 12 of alum.

Pale-violet Fire. Rub fine and mix 54 parts of chlorate of potassium, 14 of sulphur, 16 of carbonate of potassium, and 16 of alum.

Blue Fire. I. Eighteen parts of chlorate of potassium, 24 of saltpetre, 14 of sulphur, 6 of cupric oxide.

II. Four parts of mealed gunpowder, 3 of sulphur, 3 of powdered zinc, 2 of saltpetre.

III. The following mixture gives a loudly detonating compound: Two parts of saltpetre, 1 of sulphur, 2 of carbonate of potassium, 6 of common salt.

IV. Mix 27 parts of pulverized saltpetre, 28 of triturated chlorate of potassium, 15 of pulverized sulphur, 15 of pulverized sulphate of potassium, and 15 of powdered cupro-ammonium sulphate.

The dark-blue color will gain intensity by adding potassium sulphate to the mixture.

V. Seventeen hundred and fifty parts of chlorate of potassium, 500 of sulphur, 575 of carbonate of copper, and 375 of burned alum.

VI. Twenty-one parts of chlorate of potassium, 23 of copper precipitated with chlorate of potassium, 12 of sulphate of copper, 12 of calomel, 4 of milk sugar, and 3 of stearine.

Dark-blue Fire. Mix 60 parts of chlorate of potassium, 16 of sulphur, 12 of carbonate of copper, and 12 of alum.

Pale-blue Fire. I. Mix 61 parts of powdered chlorate of potassium, 16 of pulverized sulphur, and 25 of strongly heated and pulverized alum.

II. Mix 61 parts of powdered saltpetre, 17½ of pulverized sulphur, 20 of powdered anhydrous soda, and 1½ of pulverized charcoal.

Blue Fire with a Bluish-green Flame. Rub fine and mix 12 parts of nitrate of barium, 5 of chlorate of potassium, and 4 of sulphur.

Green Fire. I. Rub fine and mix 433 parts of purified sulphur, 2250 of nitrate of barium, 166 of chlorate of potassium, 66 of arsenic, and 100 of charcoal.

II. Fifty parts of chlorate of potassium, 50 of nitrate of barium, 5 of charcoal, and a sufficient quantity of linseed oil to knead the mass.

Green Fire according to Braunschweiger. Three parts of shellac, 9 of nitrate of barium, 1½ of chlorate of potassium.

Other Receipts for Green Fire. I. Sixteen parts of nitrate of barium, 4 of sulphur, and 16 of chlorate of potassium.

II. Forty-five parts of nitrate of barium, 10 of sulphur, 20 of chlorate of potassium, 2 of calomel, 1 of lampblack.

III. Mix very carefully 12 parts of nitrate of barium dry as dust, 4 of sulphur, and 6 of chlorate of potassium.

IV. Powder and mix 6 parts of nitrate of barium, 1 of sulphur, 2 of chlorate of potassium, and ½ of charcoal.

Pale-green Fire. I. Rub fine and mix 60 parts of chlorate of potassium, 16 of sulphur, and 24 of carbonate of barium.

II. Sixty parts of nitrate of barium,

14 of washed flowers of sulphur, and 40 of chlorate of potassium.

III. Thirty-eight parts of nitrate of barium, 10 of chlorate of potassium, and 8 of charcoal.

IV. Six parts of nitrate of barium, 1 of sulphur, 2 of chlorate of potassium, and ½ of charcoal.

Dark-green Fire. One hundred and twenty parts of nitrate of potassium, 60 of washed flowers of sulphur, 45 of chlorate of potassium, 37½ of anhydrous carbonate of sodium, 2 of pulverized charcoal, and 22.5 of stearine.

Yellow Fire. I. Mix carefully 48 parts of sodium nitrate, 16 of sulphur, 4 of sulphide of antimony, and 1 of charcoal.

II. Rub as fine as possible and mix 20 parts of sodium nitrate, 3 of sulphur, and 1 of sodium sulphide.

III. Two thousand parts of chlorate of potassium, 500 of purified sulphur, and 750 of sodium carbonate.

IV. Fifteen hundred and sixty-six parts of saltpetre, 625 of sodium carbonate, and 400 of gunpowder.

V. Six parts of chlorate of potassium, 6 of potassium nitrate, 5 of sodium oxalate, and 3 of shellac.

VI. Sixty-one parts of chlorate of potassium, 16 of sulphur, and 23 of anhydrous soda.

VII. One hundred and twenty parts of potassium nitrate, 30 of flowers of sulphur, 45 of chlorate of potassium, 37½ of anhydrous sodium carbonate, 2 of charcoal powder, 22½ of stearine.

VIII. Sixty-one parts of saltpetre, 17½ of sulphur, 20 of soda, and 1½ of charcoal.

OTHER COLORED FIREWORKS.

White Stars. Mix 32 parts of pulverized saltpetre, 12 of pulverized sulphur, 8 of powdered sodium sulphide, and 1 of gunpowder.

Red Stars. Rub fine and mix 40 parts of nitrate of strontium, 10 of chlorate of potassium, 13 of sulphur, 2 of charcoal, 5 of sodium sulphide.

Green Stars. Thirty parts of chlorate of barium, 10 of flowers of sulphur, and 1 of mastic.

Blue Stars. Rub fine and mix 20 parts of chlorate of potassium, 11 of

sulphur, 14 of cupric oxide, and 1 of mastic.

Bluish-green Stars. I. Rub fine and mix 24 parts of nitrate of barium, 56 of chlorate of potassium, 30 of sulphur, and 1 of mastic.

II. Twenty parts of nitrate of barium, 18 of chlorate of potassium, 10 of sulphur, 1 of mastic, and 3 of sodium sulphide.

Yellowish-green Stars. I. Rub fine and mix 60 parts of chloride of barium, 30 of nitrate of barium, 20 of sulphur, and 1 of mastic.

II. Twenty parts of chlorate of potassium, 5 of sulphur, 1 of mastic, and 1 of carbonate of barium.

Yellow Stars. Rub fine and mix 16 parts of sodium nitrate, 5 of sulphur, 2 of sodium sulphide, and 1 of charcoal.

White Candles. Powder and mix 4 parts of saltpetre, 1 of sulphur, and 1 of sodium sulphide.

Red Candles. Rub fine and mix 26 parts of nitrate of strontium, 15 of chlorate of potassium, 12 of flowers of sulphur, 2 of charcoal, 2 of sodium sulphide, and 1 of mastic.

Green Candles. Mix 20 parts of chlorate of barium, 30 of nitrate of barium, and 10 of sulphur.

Blue Candles. Rub fine and mix 18 parts of chlorate of potassium, 6 of saltpetre, 10 of sulphur, and 6 of cupric oxide.

Bluish-green Candles. Rub fine and mix 20 parts of chloride of barium, 30 to 42 of nitrate of barium, 40 of chlorate of potassium, 10 to 22 of sulphur and of sodium sulphide.

Yellow Candles. Rub fine and mix 80 parts of sodium nitrate, 7 of sulphur, 3 of sodium sulphide, and 2 of mastic.

Japanese Matches. One part of powdered charcoal, $1\frac{1}{2}$ of sulphur, and $3\frac{1}{4}$ of saltpetre.

According to another receipt they consist of 5 parts of lampblack, 11 of sulphur, and 26 to 30 parts of gunpowder. The mixture is made into a paste with alcohol, formed into small dice, and dried. When dry one of the little squares is fixed into the cleft of a lavender stalk, lighted on a candle, and held stem downward. After the first blazing off, a ball of molten lava will form from which the curious and very beautiful *corruscations* will soon appear.

Prof. Böttger says about *Japanese matches*: The mixture consists either of 3 parts by weight of lampblack, 8 of flowers of sulphur, and 15 of saltpetre (dry as dust); or 2 parts by weight of finely sifted lime-wood charcoal, 4 of flowers of sulphur, and 7 of saltpetre (dry as dust). The mode of preparing the matches is as follows: Cut the finest commercial tissue paper into strips about $6\frac{1}{4}$ inches long, 1 inch wide on one end, and running into a point at the other. By rolling these small strips of paper tightly together, commencing at the pointed end, and filling the lower part with from 30 to 45 grains of one of the above mixtures, a close imitation of the genuine Japanese matches will be the result.

Fireworks for Use in Rooms, according to Perron. Mix 12 parts of saltpetre, 15 of flowers of sulphur, and 30 of gunpowder. Then dissolve 2 parts of camphor in 8 of spirit of wine, and 4 of gum Arabic in water. Knead the whole into a dough, and form small cornered pieces from it which are dried. When ignited they give a beautiful light.

Pharaoh's Serpents. This curious chemical toy is prepared as follows: Dissolve mercury, with the aid of heat, in dilute nitric acid, being careful that there shall always be an excess of mercury present. When the action of the acid has ceased, decant the solution, and pour into it a solution of sulpho-cyanide of potassium or ammonium, which may be procured at any druggist's. Use about equal quantities of the two solutions. A precipitate of sulpho-cyanide of mercury falls out, which should be filtered off, washed, and dried. Then take for every pound of this substance 1 ounce of gum tragacanth, which should be soaked in water. When the gum is completely softened it is transferred to a mortar, and the dried precipitate is gradually rubbed up with it into a homogeneous paste, with the addition of a little water. This mass is filled into moulds of conical or other shape, made of silvered paper, and dried. When these are ignited by the application of a match at the conical end they form an enormous volume of ash, which proceeds in great coils from the body of the mass,

and which by its serpentine movements, as it is formed, has suggested the name. (W.)

Harmless Substitute for Pharaoh's Serpents. The above-named experiment, though curious and interesting, is not altogether free from danger, because poisonous mercurial fumes are evolved during the combustion of the mass. On this account several substitutes have been suggested. One of these, which is almost as good as the original, and is not poisonous, is prepared in the following manner:

Take

Bichromate of potassium	2 parts.
Sulphur	1 part.
White sugar	3 parts.

Pulverize each of the ingredients separately, and then mix them thoroughly. Make small paper cones of the desired size, and press the mixture into them. When quite dry they are ready for use. They should be kept away from moisture and light. (W.)

FOOD AND FOOD PREPARATIONS.

Soup Extract. Vegetables are gently boiled in a steam apparatus for 6 hours, and then pressed. In the resulting liquor beef and bones are boiled for 6 hours longer. The fluid is then pressed out, and, after it has become cold, the fat is skimmed off, a part of which is afterward added again, with 30 per cent. of common salt. The whole is then evaporated to the consistency of syrup.

Meat Flour. Meat free from fat is covered with 2 to 3 per cent. of salt, dried first at 120° to 140° F., then completely at 212° F., and ground.

Pressed Feed for Horses. One hundred and fifty parts of cut hay, 400 of crushed oats or corn, 50 of crushed horse beans or pease, and 20 of wheat bran or flour, are mixed with 1 of rock-salt. The mixture is then moistened with water, wrapped in press-cloths, and subjected to a high pressure in a heated hydraulic press for $\frac{1}{4}$ hour. The mixture is converted into a solid cake of gluten which is dried at 85° F., and divided into suitable pieces.

Strengthening Food Known as "Dicitamia." Mix 14 parts of sugar, 8 of

arrowroot flour, 6 of wheat flour, 2 of Trinidad chocolate, 2 of Granada chocolate, and $\frac{1}{2}$ of vanilla.

Strengthening Food Known as "Palamoud." Mix 2 parts of chocolate, 8 of rice flour, 8 of arrowroot flour, $\frac{1}{4}$ of finely powdered red sanders wood, and add some Indian arrowroot.

Soup Tablets. Mince 9 pounds of perfectly lean beef, make it into a paste with water, then press it out and evaporate the resulting fluid to $\frac{1}{2}$ pint. Now put in a pot 6 $\frac{1}{2}$ pounds of calves' feet, and a like quantity, each, of roasted onions, carrots, celery, and water, with the addition of a small quantity of cloves. Boil the whole thoroughly, strain the fluid, and evaporate it to two-thirds of the quantity. Now add the strained fluid to the meat liquor, mix all with a solution of 2 ounces of gum arabic, and evaporate the whole to a thick mass, which is formed into small tablets.

Stilton Cheese as Prepared in England. A tin cylinder open at both ends is required, 6 inches long and 12 inches in diameter, with perforated sides to allow the escape of the whey. Lamb's maw is used as a rennet, and a lemon filled with cloves is placed in the curd. Nine gallons of fresh milk and the cream from 2 to 3 gallons of milk are used for 1 cheese. The milk is heated to its natural temperature before adding the rennet. When the mass is curdled, it is strained through a cloth, broken short and allowed to remain quiet, wrapped in the cloth, until it is fit to be cut. The tin cylinder is then placed upon a board and filled with alternate layers of curd and salt and covered with another board.

The cylinder with the cheese is turned over every 2 or 3 hours for the first day, and 2 or 3 times a day for the succeeding 3 or 4 days, after which the cheese is taken out, wrapped in a cloth wet with boiling water, and pressed until it is dry. It is turned twice a day, and protected from flies and insects. Considerable time is required to make it fit for the table.

Honey from Beets and Carrots. This is generally prepared from 2 parts of sugar beets and 1 of carrots. The roots are washed clean and scraped. They are then placed about a foot

deep in a boiler, covered with water, and boiled until soft, being frequently stirred to prevent scorching. The boiled mass is pressed out, and the juice boiled down to the consistency of a syrup, and filled in well-closed earthenware vessels. Its flavor improves with age.

To Prepare Potato Flour for Soups, etc. Cleanse good potatoes, boil, peel, and cut them in slices. Now add to 100 parts of potatoes 4 of salt; then dry thoroughly, and grind them to flour, which should be kept in well-closed tin boxes.

Meat Biscuit. Fresh meat is thoroughly boiled, and the liquor concentrated by evaporation until it has acquired the consistency of thick syrup. It is then mixed with the best wheat flour and made into a dough. This is rolled out, cut into biscuits, and baked in an oven at a moderate heat. Perfectly dry biscuits, easily broken and resembling the finest ship biscuit, are obtained by this process. They contain no fat, and can be used for the preparation of soups and puddings. They contain 5 times as much nutriment as an equal volume of good fresh meat, and will keep for a long time.

Apparatus and Method for Preparing a Substitute for Coffee. A substitute for coffee is prepared in England, which has been patented by Bolanachi, of West Dulwich. The fruit of the carob tree (*Ceratonia siliqua*) is roasted and ground, and mixed with roasted and ground vetches and coffee. Some chicory, or gentian root, and a little carbonate of potassium are also added.

The roasting apparatus (Fig. 12) consists of the cylindrical drum A, the interior of which is provided with spiral flues *a a*. The outer cylinder of the drum forms with the inner narrower cylinder E, and the spiral flues, a series of divisions which communicate with the interior of the cylinder E through openings in the wall of E. Upon the face of E is placed the ventilating pipe *c*. This, with the perforated cylindrical wall of E, forms a chamber for charging the apparatus through the funnel *b'*. D is a double jacket en-

closing A; *ee* are hot water pipes arranged around A and heated from *f*. *c' c'* are openings in the back of the cylindrical wall of A, through which the roasted mass, pressed backward by the turning of the spiral flues *a a*, falls down upon *d*. The roasting gases escape through the ventilating pipe *c*, reaching this from the divisions *a' a'* through openings in the inner cylinder E. The substances to be roasted are introduced through *b'* into *a' a'*, where they remain until pushed forward by the turning of the spiral flues, and finally fall through *c' c'* upon *d*.

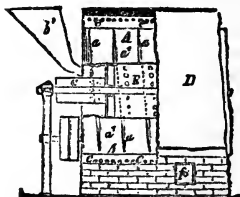

Fig. 12.

Bread for Horse Feed. Crushed wheat, rye, oats, barley, and corn, are mixed with cut straw and a little yeast, the mixture is formed into loaves of about 5 pounds each, and baked.

Pudding Powders (Vanilla). Five hundred parts of corn starch, 25 of vanilline, and 50 of egg conserve.

Almond Pudding. Five hundred parts of corn starch, 50 of almond flour (with some bitter almonds), 50 of egg conserve, and 12 of vanilline.

Chocolate Pudding. Five hundred parts of corn starch, 250 of powdered cocoa free from oil, 35 of vanilline, and 150 of egg conserve.

Manufacture of Artificial Butter. Fresh beef suet is one of the principal materials required in the manufacture of artificial butter. It should be entirely free from blood and particles of meat, and is especially prepared for the manufacture of margarine and oleomargarine by cutting it up and rendering, with an addition of water and crystallized soda. To 300 parts of suet take 100 of water and 1 of crystallized soda. The mass is heated

over a moderate fire and frequently stirred, until the suet separates as a clear golden-yellow fluid on the top of the water. It is then skimmed off, poured through a sieve, and preserved for use.

Margarine is an imitation of butter made from beef suet after it has been treated as just described. The suet is melted and allowed to cool, then put in tin moulds lined with linen cloths and submitted to powerful pressure. From 50 to 60 per cent. of margarine is obtained, the residue being used in the manufacture of candles. The lumps of margarine should not exceed 2 or 3 pounds each.

Mège's Process for Oleomargarine.

The process, as carried on in American manufactories working under the Mège patents, is substantially as follows: The selected beef fat, which is received a few hours after killing, is first carefully worked free from adhering blood and other impurities by first soaking in warm water and afterwards thoroughly washing in cold water. Only the pieces appearing richest in oil are reserved for butter making, these being cut off by an experienced workman; the other parts being thrown into tubs that find their way to the tallow factory.

The selected fat, after another washing, is next introduced into a hashing machine, which is an iron cylinder provided with a number of revolving knife-blades, which cut up and completely disintegrate the fat as it is fed in at one end and forced out through a perforated plate at the other. This process is important, as thereby the cellular tissue is thoroughly broken up, and the oil separates from the material in this condition at a low temperature, and the prolonged application of heat to effect this, as is necessary in the melting of tallow, and which will develop a rank and tallowy flavor, is avoided.

The disintegrated fat is then melted in caldrons, which are provided with a water jacket and heated by steam. By this means the melting of the fat takes place at a temperature of 122° to 124° F. When the fat is completely melted the contents of the caldrons are permitted to stand until they deposit the floating fragments of membrane, which collect

on the bottom, forming "scrap." On top there is formed a layer of a white emulsion of oil and water which is removed, and the clear, yellow oil is drawn off into suitable vessels and removed to the "press" room. Here the melted fat is allowed to remain quietly for about 24 hours, at a temperature of about 85° F., to allow the oil to granulate by the crystallization of the stearine.

The granulated mass is next filled into bags, set in moulds, and placed on galvanized plates in a series of presses. When these are filled with the bags they are subjected to a gradually increasing pressure, under which the fluid oil is separated, leaving the hard cakes of stearine in the cloths.

The resulting oily product is a clear, sweet, yellow oil, substantially similar in composition to the oil of butter, and in this condition it forms an excellent oil for cooking, and is largely consumed for this purpose.

The next step is the conversion of this oil into butter substitute, or "oleomargarine" butter. For this purpose it is churned with fresh milk for about 20 minutes, in which operation it is thoroughly emulsified or broken up into minute globules. A small quantity of annatto is added at this stage, to impart a richer color to the product. The emulsified oil is then drawn off into tubs containing pounded ice, in which it cools suddenly without granulation. Here it remains for several hours, when it is thoroughly "worked" by hand and the fragments of ice removed.

To impart the peculiar butter flavor the solidified product must be provided with more of the butyric elements which impart to natural butter its rich odor and flavor, and, for this purpose, it is again churned with fresh milk. After this second churning the product goes through the same series of operations, of working by hand, salting, and packing, as ordinary butter. The finished product, known as "oleomargarine," made in this way, while not equal in flavor to the best grades of dairy butter, is really preferable, in taste, smell, and wholesomeness, to much of the butter sold in the shops, and is substantially identical in composition to butter made from cream. (W.)

Composition of the best-known Milk Foods for Children.

A. CONDENSED MILK.	Water.	Salts.	Fats.	Albuminoids.	Milk Sugar.	Cane Sugar.
1. American Condensed Milk Co., N. Y.	27.72	1.81	8.61	9.92	51.84	
2. Anglo-Swiss Co., Switzerland	26.14	2.05	9.92	11.90	50.80	
3. Austria Condensed Milk Co., near Vienna	24.26	2.16	9.63	11.82	53.13	
4. Gerber & Co., of Thun, Switzerland	26 10	2.12	9.46	11.73	50.59	
5. Hooker's Cream Milk Co., London	25.56	1.87	9.90	12.39	10.18	40 10
6. Italian Condensed Milk Co., Milan	25.21	2.03	9 21	14.65	13.42	35 48
7. Keppel Bros., Kempten	31.3	2.56	10 19	12.53	43.42	
8. H. Nestle, Vevey, Switzerland	24.75	2.17	11.53	12.67	11.19	37.69
9. New York Condensed Milk Co., N. Y.	25.43	1.89	7.01	11.34	10.11	42.22
10. Norwegian Condensed Milk Co., Norway	32.80	3.01	9.8	13.13	41.25	
11. West of England Condensed Milk Co.	24.89	2.61	10.64	13.08	13.31	35.47
12. Waterloo Dairy Co., Waterloo, Belgium	21.67	2.61	9.15	15.86	13.48	36.23

B. INFANTS' FOOD.	Water.	Salts.	Fats.	Albuminoids.	Carbo-Hydrates.	
					Soluble.	Insoluble.
1. Anglo-Swiss Co.	5 to 6	2 to 2.5	5 to 6	14 to 15	54 to 55	15 to 16
2. Faust & Schuster, Göttingen	6.29	1.76	5.03	10.71	48.62	27.59
3. Dr. Gerber	6.43	1.85	4.75	10.96	39.12	34.7
4. Gerber & Co., Thun	5 to 6	2 to 3	5 to 6	17 to 18	45 to 50	15 to 20
5. Gieffey, Schiele & Co., Rohrbach, Baden	5.52	1.35	4.42	12.33	44.32	31.56
6. Labb, London	4.22	1.78	4.34	12.86	47.68	29.94
7. Oetli Montreux Tablet Powder	9.47	1.53	6.81	11.29	35.81	34.59
8. H. Nestle, Vevey	7.72	1.85	4.93	9.21	42.60	33.39
	6.07	1.65	5.39	11.0	42.0	28.5
	5.1	2.2	5.4	11.8	47.0	32.75
	5.78	1.52	4.49	9.96	45.0	32.75
	6.36	1.85	4.70	10.96	76.08	

Ordinary artificial butter is made from cotton-seed oil; better qualities from peanut oil and olive oil.

I. *Ordinary Oleomargarine.* Two hundred and fifty parts of suet and 350 of good cotton-seed oil are melted and compounded with 5 of palm oil in order to color the mixture. The fat, while still warm, is poured through a fine sieve or cloth into a wooden vat and, with constant stirring, allowed to congeal.

II. *Better Quality of Oleomargarine.* Two hundred and fifty parts of ordinary suet, 350 of good cotton-seed oil, 50 to

100 of lard, and 6 of palm oil; or, 250 of ordinary suet, 350 of good cotton-seed oil, 50 to 100 of margarine, and 6 of palm oil.

III. *Very Fine Quality of Oleomargarine.* Two hundred and fifty parts of ordinary suet and 350 of good cotton-seed oil are melted together. Into this are stirred 1 part of coarsely powdered cloves, 1 of coarsely powdered orris root, and 12 anchovies cut very fine. The mass is then again gently heated for 2 to 3 hours, and colored with 5 parts of palm oil.

Other Varieties of Oleomargarine.

I. Two hundred and fifty parts of suet, 350 of oil of sesame seed, or peanut oil, 5 of palm oil, or butter color, and 200 of genuine butter.

II. Two hundred and fifty parts of suet, 350 of oil of sesame seed, or peanut oil, 200 of margarine, 7 of palm oil, or butter color, 300 of genuine butter.

III. Two hundred and fifty parts of suet, 350 of oil of sesame seeds, or peanut oil, and 200 of margarine are treated with cloves, orris root, and anchovies as given under the first No. III., and then compounded with 7 parts of butter color and 200 of genuine butter.

IV. Four hundred parts of margarine, 100 of genuine butter, and 4 of butter color.

Vienna Economical Butter. Margarine is melted at a very moderate heat, 20 per cent. of sour whey is added, and the mixture thoroughly worked together until the whole is formed into a white froth. This is then beaten in a large vat until it congeals, by which the whey is separated and drawn off by a cock. The butter is then salted, if necessary, and pressed into prints.

Another Receipt. Two hundred parts of perfectly fresh beef suet, 100 of lard, 100 of water, and 1 of crystallized soda are treated in the same manner as the suet for oleomargarine, and to 50 to 60 parts of the mixture is added a like quantity of oil of sesame seed, or peanut oil.

Ambrosia, a new nourishing flour food, is composed of the following ingredients: Four hundred and fifty-five parts of pulverized chestnuts, 305 of potato flour, 125 of lentil flour, a like quantity of bean flour, and 91 parts of powdered vanilla. It is claimed that this flour is very strengthening and can be used as a substitute for coffee and chocolate.

Hydroleine, which is much advertised in American and English papers, and claimed to be very strengthening, contains, according to the statements of the manufacturer, in 2 teaspoonfuls (120 drops) 30 drops of the purest cod-liver oil, 35 drops of distilled water, 6 grains of soluble pancreaticine, $\frac{1}{2}$ grain of soda, $\frac{1}{4}$ grain of boracic acid, and $\frac{1}{8}$ grain of glycocholic acid.

FREEZING MIXTURES.

Freezing Salt. The mixture introduced under this name can be especially recommended to confectioners, beer brewers, and consumers of ice in general. It is inexpensive, and a temperature of 5° to -22° F. can be produced with it. It is composed of 20 per cent. of calcium chloride, a like quantity of magnesium chloride, 6 per cent. of sodium chloride, 13 per cent. of potassium chloride, and 41 per cent. of water. By mixing this salt with equal volumes of snow of 32° F. a freezing mixture of 5° to -4° F. is obtained. By using equal volumes of snow or pounded ice of 23° F. the temperature of the mixture falls to below -22° F.

Other Mixtures. In the following we give a number of other mixtures, with the degree of temperature obtained with them:

1. Mix 1 part of ammonium nitrate with 1 of water. -5° F.
2. Mix 4 parts of ammonium nitrate with 3 of water. -13° F.
3. Mix 3 parts of pounded sal-ammoniac, 1 of saltpetre, 6 of potassium chloride with 10 of water. -21.2° F.
4. Mix 5 parts of pounded sal-ammoniac, 5 of powdered saltpetre, 8 of crystallized Glauber's salt with 16 of water. -5° F.
5. Mix 10 parts of water, 6 of saltpetre, 6 of sal-ammoniac, $4\frac{1}{2}$ of crystallized Glauber's salt. -23° F.
6. Mix 16 parts of crystallized Glauber's salt with 5 of crude hydrochloric acid and 5 of cold water. -3.2° F.
7. Mix 8 parts of crystallized Glauber's salt with 5 of hydrochloric acid. -1.4° F.
8. Mix 1 part of crude hydrochloric acid with 1 of water, and add 3 of crystallized Glauber's salt. -5° F.
9. Mix 4 parts of crystallized Glauber's salt and 3 of sulphuric acid of 41 per cent. 23° to -17.6° F.
10. Mix 2 parts of pounded ice or snow with 1 of common salt. -5° F.
11. Mix 1 part of pounded ice or snow with 1 of common salt. -1.4° F.
12. Mix 3 parts of pounded ice or snow with 4 of crystallized calcium chloride. -13° F.
13. Mix 2 parts of pounded ice or

snow with 3 of crystallized calcium chloride. —13° F.

14. Mix 3 parts of snow and 2 of diluted sulphuric acid. 32° to —22° F.

FRUIT AND OTHER SYRUPS.

American Syrups for Mineral Waters and Lemonades.

Lemon Syrup. Peel fresh lemons and grate the peel with a sufficient quantity of granulated sugar. Press the peeled lemons, and compound each pint of juice with 1 pint of water and 3½ pounds of granulated sugar, inclusive of that treated with the peel. Heat until the sugar is dissolved and strain.

Another Receipt. One gallon of white syrup, 25 drops of oil of lemon, and 10 drachms of citric acid.

Compound the oil with the acid, add the syrup gradually, and mix.

Another Receipt. Dissolve 6 drachms of tartaric acid and 1 ounce of gum Arabic in a gallon of white syrup, and give it the necessary flavor by adding 1½ drachms of the best oil of lemon, or, instead of this, a sufficient quantity of tincture of lemon peel prepared with eau de Cologne.

Mulberry Syrup. Six parts of not entirely ripe mulberries and 6 of granulated sugar. Boil them with constant stirring until the juice shows 30° Beaumé; then strain.

Vanilla Syrup. One ounce of fluid extract of vanilla, ½ ounce of citric acid, 1 gallon of white syrup.

Dissolve the acid by rubbing it with a small quantity of the syrup, add the extract, and mix.

Vanilla Cream Syrup. One ounce of fluid extract of vanilla, 3 pints of white syrup, 1 pint of cream or condensed milk. May be colored, if desired, with carmine.

Cream Syrup. Half pint of fresh cream, ½ pint of fresh milk, and 1 pound of powdered sugar. Mix by shaking, and keep in a cold place. By adding a few grains of sodium bicarbonate it will keep longer.

Ginger Syrup. Tincture of ginger 2 ounces, white syrup 4 pints. Mix.

Pineapple Syrup. Cut up pineapples of good quality, let them stand

for 24 to 36 hours, and then press out the juice. This is allowed to stand over night; then add for each pound 1 ounce of eau de Cologne or alcohol free from fusel oil, mix, let it again stand over night, and filter. For each pound of filtered juice take 1½ pounds of sugar, let it boil up once, skim, and put the syrup in bottles, which must be perfectly clean and previously rinsed out with a little eau de Cologne. This syrup, as well as all others prepared in the same manner, is strong enough to allow of being mixed with 2 to 3 parts of white syrup, especially for effervescing waters.

Strawberry Syrup. Use only very fine and aromatic berries, as otherwise the syrup will not be of excellent quality. Especially avoid rotten fruit. Mash the strawberries, and let the paste stand for 12 to 24 hours, at a temperature of 70° to 80° F. Then stir it once more and press. The further treatment is the same as for pineapple syrup.

Peach, Raspberry, and Currant syrups are prepared in the same manner as strawberry syrup.

Cherry Syrup. A sufficient quantity of cherries are pounded in a porcelain or stone mortar in order to comminute the stones also. Press out the juice, let it stand for 3 days, to allow it to ferment, filter, and then treat in the same manner as strawberry syrup.

Orange Syrup. Oil of orange 30 drops, tartaric acid 4 drachms, white syrup 1 gallon. Rub the oil with the acid, dissolve and mix.

Sherbet Syrup. Vanilla syrup 3 pints, pineapple syrup 1 pint, lemon syrup 1 pint. Mix.

Nectar Syrup. Five pints of vanilla syrup, 1 of pine-apple syrup, 2 of strawberry, raspberry, or lemon syrup.

Coffee Syrup. Ground roasted coffee ½ pound and sufficient boiling water to filter off ½ gallon of infusion. Dissolve in it 7 pounds of granulated sugar without using heat.

Another Receipt. Two ounces of roasted coffee, 2 of white syrup. Mix, and bring the mixture into a filter and add a boiling solution of 12 ounces of sugar and 8 of distilled water.

Wintergreen Syrup. Twenty-five drops of oil of wintergreen, 5 pints of

white syrup, and as much sugar color as is required for coloring.

Maple Syrup. Four pounds of maple sugar and 2 pints of water. Dissolve like white syrup.

Chocolate Syrup. Eight ounces of the finest chocolate, 2 pints of water, 4 pounds of sugar. Mix the chocolate with the water at a moderate heat, strain, and dissolve the sugar in it.

Another Receipt. Pound 2 ounces of roasted cocoa shells to a coarse powder, mix this with 2 ounces of white syrup, bring the mixture into a strainer and exhaust it with a boiling solution of 12 ounces of sugar and 8 of water. Then add 2 drachms of vanilla extract.

White or Red Wine Syrup. Mix 1 pint of red or white wine with 2 pints of white syrup.

Coffee Cream Syrup. Mix 2 pints of coffee syrup with 1 of cream.

Solferino Syrup. Mix 1 pint of cognac and 2 pints of white syrup.

Ambrosia Syrup. Mix 2 pints of raspberry syrup with 2 of vanilla syrup and 4 ounces of white wine.

Orgeat Syrup. Eight ounces of sweet almonds, $2\frac{1}{2}$ of bitter almonds, 3 pounds of sugar, 26 ounces of water, and 4 ounces of orange-flower water. Peel the almonds and pound them to a smooth paste with 2 ounces of water and 12 of sugar. Mix the paste gradually with the remaining water, subject it to a strong pressure, and dissolve the remaining sugar at a moderate heat. When cold, add the orange-flower water.

Milk Punch Syrup. Mix 1 pint of white syrup, 8 ounces of cognac, 8 ounces of Jamaica rum, and 1 pint of cream syrup.

Champagne Syrup. Two pints of Rhine wine, 2 ounces of cognac, 1 ounce of sherry, 3 pounds of granulated sugar. Dissolve the sugar by macerating it without the use of heat.

Sherry Cobbler Syrup. One pint of sherry and $1\frac{1}{2}$ pints of white syrup. Cut one lemon into thin slices, macerate for 12 hours, and strain.

Orange-flower Syrup. One pint of orange-flower water, 28 ounces of granulated sugar. Dissolve without the use of heat.

Cinnamon Syrup. Thirty drops of

oil of cinnamon, 60 grains of carbonate of magnesia, 2 pints of water, 56 ounces of granulated sugar. Rub the oil together with the magnesia, next with the water, and filter. Dissolve the sugar in the cold filtrate.

Ginger Beer Syrup. Two pints of ginger syrup, 1 of lemon syrup, 3 grains of tincture of Spanish cress. Mix.

To make the syrups sparkle add 2 to 4 ounces of gum Arabic, dissolved in equal parts of water to each gallon.

How to Clarify Sugar Syrups. It happens sometimes that the syrup does not turn out sufficiently clear notwithstanding the use of a clear infusion and the best sugar. This is sometimes caused by a small percentage of lime in the sugar, or by the coloring substance which has been added to increase the whiteness of the sugar. To clarify the syrup with white of egg increases the cost of preparing it and contributes nothing to its keeping quality. The best means of clarifying is by the use of a pulp of good filtering paper. The pulp of $1\frac{1}{2}$ drachms of paper will, in most cases, suffice for 1 pint of syrup. It is added to the fluid which is to be made into syrup with the sugar. The paper pulp is prepared by picking the paper to pieces, placing it in a capacious flask, pouring distilled water over it, shaking it vigorously several times, and collecting it upon a strainer. The moist pulp, which should not be squeezed out, is used.

Other Fruit Syrups. *Marsh-mallow Syrup.* Peel and cut in pieces 2 ounces of marsh-mallow root and pour $1\frac{1}{2}$ pints of hot water over it. Strain when cold, and dissolve in it $4\frac{1}{2}$ pounds of white sugar. Beat the white of two eggs, pour this into the mass, boil, skim, and strain it.

Balsam Syrup. Digest in a glass vessel 1 ounce of black Peruvian balsam with 1 pound of water. Let it stand for a few hours. Filter the fluid, and dissolve in this by boiling $1\frac{1}{2}$ pounds of loaf sugar, and strain through a woollen cloth.

Barberry Syrup. Pound and press ripe barberries, and allow the obtained juice to stand until it is clear. Add to $1\frac{1}{2}$ pounds of this juice $3\frac{1}{2}$ pounds of white sugar, and boil the mass to a thin syrup, which must be strained through a woollen cloth.

Blackberry Syrup. Pound ripe blackberries, press the juice out, and allow it to clear. To 1 pound of this juice add 3 pounds of white sugar, boil the mass to syrup, and strain it, while hot, through a cloth.

Lemon Syrup. Press the juice from fresh lemons and let it stand until it has become clear. Then add to 1 pound of this juice 3 pounds of white sugar and boil the mass to a thin syrup.

Camomile Syrup. Pour hot water over 4 ounces of camomile flowers, strain, and in 1 pound of this decoction dissolve at a moderate heat 3 pounds of white sugar. Strain, while hot, through a woollen cloth.

Manna Syrup. Dissolve in boiling water $\frac{1}{2}$ part of picked manna, add to the solution 2 parts of white sugar, and allow the mass to boil up once.

Rhubarb Syrup. Pour 2 pounds of boiling water over 3 ounces of rhubarb root cut in pieces, 6 drachms of cassia bark, and 4 drachms of carbonate of potassium. Let it stand for 24 hours, then strain the fluid. To 1 pound of the strained fluid add 3 pounds of white sugar and boil the mass to a thin syrup.

Saffron Syrup. Digest for several hours 1 part of saffron with 30 of French white wine. Strain the fluid and dissolve in 20 parts of it 45 of white sugar. Then filter through a cloth.

Senna Syrup. Place 8 parts of senna leaves and 1 of pounded anise seed in a porcelain vessel, and pour 60 of boiling water over them. Let the mass stand for a few hours, squeeze it out, and strain the fluid. Then dissolve in 45 parts of it 90 of sugar, boil it up once, and strain through a cloth.

Seneca Root Syrup. Boil 2 parts of Seneca root, cut in pieces, in 45 of water. To 20 parts of this add 45 of white sugar, and boil it to a thin syrup.

Licorice Syrup. Boil for $\frac{1}{4}$ hour at a moderate fire 15 parts of licorice root, cut in pieces, in 90 of water, pour the liquid off, and evaporate it to 56 parts. Add to this 60 parts of white sugar and 60 of purified honey, and allow it to boil up once.

Violet Syrup. Place 15 parts of fresh

violets from which the calix has been removed and 60 parts of water in a vessel, and close it hermetically. Let it stand for 12 hours, strain the fluid, add 90 parts of white sugar, and boil to a thin syrup.

Cinnamon Syrup. Digest in a closed vessel for 2 days 4 parts of cassia bark, with 30 of vinous cinnamon water, and 4 of rose-water. Strain it, and in 24 parts of the strained fluid dissolve at a moderate heat 45 of white sugar. Then strain through a cloth.

Egg Syrup. This, according to Payen, is prepared by beating the yolks and whites of 1 pound of eggs (about 10 eggs) with the same volume of water, until the mass is sufficiently fluid to allow of it being strained through a cloth. What has passed through is then beaten to a froth, and $1\frac{3}{4}$ pounds of pulverized sugar are added to it, and then 20 drops of orange-blossom water. In order to make it keep better, it is advisable to add $\frac{1}{2}$ ounce of common salt. The mixture is thoroughly stirred for $\frac{1}{4}$ hour, and when it is quite fluid the scum is removed and the syrup filled into 4 ounce bottles. When used it is mixed with 10 times its volume of water.

Cochineal Syrup. One and a half drachms of powdered cochineal, $1\frac{1}{2}$ pounds of boiling distilled water, $3\frac{1}{2}$ pounds of sugar, and $2\frac{1}{2}$ ounces of rectified spirit of wine. The cochineal is boiled in water in a closed vessel for 15 minutes, and then strained. To this fluid is added double its weight of sugar, and when this is dissolved, and after the fluid has become cool, $\frac{1}{2}$ fluid drachm of spirit of wine is added to 1 ounce of it. This syrup is used for coloring medicines.

Syrup of Ferrous Nitrate. Take 2 parts of iron wire in small pieces, 3 of nitric acid of 1.42 specific gravity, 13 of water, and 25 of sugar. Pour 3 parts of the water upon the iron, mix the rest of the water with the acid, and pour this gradually upon the iron until the acid is saturated, which may be recognized with the aid of litmus paper. The fluid is then filtered over the sugar, and the syrup, if necessary, is increased to 30 parts by pouring water upon the filtrate. The syrup should be kept in well-closed bottles.

FUEL AND HEATING. HEAT INSULATION (NON-CONDUCTING COVERINGS).

Necker's Kindling Compound. Knead melted rosin with sawdust until the mass does not draw threads between the fingers, and then form long pieces of it.

Economical Fuel. I. Take $\frac{2}{3}$ of soft, moist clay containing no stones, knead it thoroughly with $\frac{1}{3}$ coal dust, form small balls of the mass, and dry them.

II. Take equal parts of pulverized charcoal or coal, pulverized coke, and moist clay, and form the mass into balls the size of a hen's egg. Some sawdust, finely cut straw, etc., may be added to the mass.

III. Instead of the clay and coal, cow or horse dung, sawdust, peat, spent tan, or straw, can be used, and mixed with pulverized glass, pitch, tar, oil-cake, etc. The quantity of coal to be added depends on the size of the stove in which the fuel is to be burned; the larger the stove the more coal.

Fuel from Coal and Rosin. The coal and rosin are comminuted, heated, and mixed with pitch, coal-tar, and fat, by means of a mixing machine, when the mass is pressed into cakes. Coke is used in a similar manner.

King's Patent Fuel. Peat is mixed with coal-tar, pitch, asphaltum, limestone, common salt, and borax, in varying proportions according to the purposes for which the fuel is to be used.

Coal-dust Fuel (Loiseau's Patent). Dust of bituminous coal, or anthracite, is mixed with about 7 per cent. of plastic clay, and made up into bricks, which are dipped into ordinary benzole containing rosin in solution. They are then exposed to a current of air, whereby the benzole is evaporated, and a coating of rosin is left on the surface which renders the coal bricks watertight.

Blair's Patent Fuel. Slate and coal waste are pulverized and mixed with coal-tar, schist oil, petroleum, or paraffine oil and intimately impregnated with them by using steam. The entire mass is then formed into bricks by subjecting it to strong pressure.

Insufiorial Earth for Insulating Steam-pipes, though one of the best

non-conductors, is too expensive to be used by itself as an insulating material. But by enveloping the pipes first with a layer of about 1 inch in thickness of ordinary insulating material, such as straw and clay, etc., and coating this with a thin layer of a mixture of insufiorial earth with soda water-glass, good results will be obtained. In applying the mixture care must be had to lay on a fresh quantity only when the first layer is entirely dry, which may be readily recognized by the white appearance of the coat. To make the 1 year more durable a light coat of oil should finally be given.

Heat-insulating Coverings for Steam-pipes, etc. Felt, cork waste, mineral wool, or asbestos pulp, either made into suitable forms and attached to the pipe, or filled into a casing surrounding the pipe, and with or without an air-space about the pipe, are much used for the above purpose. (W.)

FUSIBLE COLORS USED IN PORCELAIN PAINTING.

Brianchon's Peculiar Process of Painting Glass, Porcelain, etc. Preparing the Flux. Melt in a saucer 30 parts of rosin, and add, during the melting, 10 parts of baric nitrate of bismuth in small portions with constant stirring. When the mixture begins to assume a brown color pour 40 parts of oil of lavender into the saucer and stir until the ingredients are intimately combined. Now take the saucer from the sand-bath, allow the contents to cool, and then add 35 parts of oil of lavender, when the flux is ready for use. The salts and oxides of antimony, chromium, cobalt, copper, iron, iridium, palladium, platinum, rhodium, silver, uranium, zinc, etc., are used as coloring substances; and gold, if the colors of mother-of-pearl or a prismatic play of colors is to be produced.

Ador and Abbadie's Zinciferous Metallic Colors. Solution of Zinc Salt. A solution of zinc salt is prepared by mixing 100 parts of zinc salt with a solution of another metallic salt of known specific gravity. The mixture is evaporated to the consistency of dough and heated in a refractory clay

retort. As soon as the residue assumes the desired color it is time to withdraw the heated product from the furnace.

This solution of zinc is requisite for producing the zinciferous metallic colors.

Bronze Color. Add to the zinc solution 3 parts of solution of nitrate of cobalt of 15° to 16° Beaumé, 3 of solution of nitrate of nickel, and 1 to 1½ of solution of nitrate of copper.

Chamois Color (Leather Yellow). Add to solution of zinc salt 1½ to 2½ parts of solution of ferrous sulphate of 28° to 30° Beaumé.

Gray Color. Add 2½ parts of solution of blue vitriol to solution of zinc salt.

Green Color. Add 2½ parts of solution of nitrate of cobalt of 20° Beaumé to solution of zinc salt.

Rose-red Color. Add 2 to 3 parts of solution of ferric nitrate of 20° to 25° Beaumé to solution of zinc salt.

Yellow Color (Golden). Add 2½ parts of solution of nitrate of manganese of 12° to 14° Beaumé and a few drops of saturated solution of silver to solution of zinc salt.

Yellow Color (Roman). This is obtained by heating sulphate of zinc in clay retorts.

Yellowish-green Color. Add 2½ parts of solution of nitrate of nickel of 15° to 16° Beaumé to solution of zinc salt.

OTHER COLORS.

Black (Cobalt and Manganese). Mix 2 parts of anhydrous sulphate of cobalt, 2 of anhydrous manganous sulphate, and 5 of saltpetre. Heat the mixture to complete decomposition. By boiling the mass a residue of a deep black color is obtained, consisting of cobalt and manganese. One part of this black, dry residue is then triturated with 2½ of lead glass (for the preparation of this see Iridium, Black).

Black (Iridium). Mix 1 part of metallic iridium with 1 of decrepitated salt, place the mixture in a porcelain tube, introduce a current of chlorine gas, and bring it to a gentle red heat. The resulting product is extracted from the non-decomposed iridium with water. By evaporating this watery solution of

the double salt to dryness with sodium carbonate and extracting it with water, a black sesquioxide of iridium is obtained. One part of this, mixed with 2 of lead glass and rubbed fine upon a glass plate, gives a very beautiful black color.

The lead glass is obtained by fusing together 12 parts of minium, 3 of fine white sand, and 1 of calcined borax.

Black (Refractory). Triturate upon a glass plate 5 parts of violet-blue (obtained from gold-purple), 1½ of sesquioxide of cobalt, and 1½ of stannic oxide.

Blue (Azure). Triturate upon a glass plate 2 parts of dark blue (which see), 1 of stannic oxide, and 4 of lead glass (consisting of 4 parts of minium and 1 of sand).

Blue (Dark). Mix 1 part of chemically pure sesquioxide of cobalt, 1 of stannic oxide, 1 of lead glass (composed of 2 parts of minium, 1 of sand, and 1 of calcined borax), and 4 of lead glass (consisting of 2 parts of minium and 1 of sand). Fuse these substances for 3 hours at a white heat, when the mass is poured out, comminuted, and rubbed fine upon a glass plate.

Blue (Shading). Mix and fuse in the manner given under dark blue 10 parts of sesquioxide of cobalt, 9 of stannic oxide, 25 of lead glass (consisting of 2 parts of minium and 1 of sand), and 5 parts of lead glass (composed of 2 parts of minium, 1 of sand, and 1 of borax).

Blue (Turkish). Dissolve 3 parts of chemically pure sesquioxide of cobalt and 1 of stannic oxide in sulphuric acid; dilute the solution with water and add 40 parts of ammonia alum. The mixed solutions are now evaporated to dryness, then powdered and exposed in a crucible to a red heat for several hours. The Turkish-blue color is obtained by mixing 1 part of the residue with 2 of bismuth glass, which is produced by fusing together 5 parts of teroxide of bismuth and 1 of crystallized boracic acid.

Bluish-green. Mix 10 parts of protochloride of mercury and 1 part of chemically pure sesquioxide of cobalt. Triturate the mixture upon a glass plate and then heat it in small portions in a glass tube open on both ends until all mercury has been expelled. A

beautiful bluish-green color is obtained in this manner. This is then placed in a porcelain crucible with a luted cover and subjected to the strongest heat of a porcelain furnace as long as the burning of the porcelain continues. When cold the crucible is broken up, the contents taken out and washed with water to remove the last traces of the adhering potash. A combination of chrome green with sesquioxide of cobalt, having the color of verdigris, is obtained.

Bluish-red. Heat sulphate of iron until it has acquired a loose structure and a bluish-red color. The fusible color is then prepared by mixing and rubbing fine, upon a glass plate, 2 parts of purple-colored ferric oxide and 5 of lead glass (prepared by fusing together 5 parts of minium, 2 of sand, and 1 of calcined borax).

Brown (Bistre). No. I. Mix 1 part of anhydrous manganous sulphate, 8 of anhydrous sulphate of zinc, 12 of anhydrous ferrous sulphate, and 26 of saltpetre. Heat the mixture in a Hessian crucible until the saltpetre is completely decomposed. The crucible, when cold, is broken up, the residue taken out, and the soluble parts extracted by boiling in water. The brown powder obtained is then mixed with $2\frac{1}{2}$ times its weight of lead glass, prepared as above indicated.

No. II. Mix 1 part of anhydrous manganous sulphate, 4 of anhydrous ferrous sulphate, 4 of anhydrous sulphate of zinc, and 12 of saltpetre.

This color is prepared in the same manner as No. I.

Brown (Dark). Mix 1 part of anhydrous sulphate of cobalt, 4 of anhydrous sulphate of zinc, 4 of anhydrous ferrous sulphate, and 10 of saltpetre, and treat in the same manner as bistre brown No. I.

Brown (Pale). No. I. Mix 6 parts of anhydrous ferrous sulphate, 4 of anhydrous sulphate of zinc, and 13 of saltpetre, and treat in the same manner as bistre brown No. I.

No. II. Mix 2 parts of anhydrous ferrous sulphate, 2 of anhydrous sulphate of zinc, and 5 of saltpetre. Fuse and treat the mixture in the same manner as given for bistre brown No. I. Then mix 2 parts of the residue with 5 of lead glass, prepared as above.

Brown (Sepia). Mix 1 part of anhydrous ferrous sulphate, 1 of anhydrous manganous sulphate, 1 of anhydrous sulphate of zinc, and 5 of saltpetre, and fuse and treat the mixture in the same manner as bistre brown No. I.

Brownish-red. Heat sulphate of iron until the sulphuric acid has been entirely expelled and a sample taken from the crucible shows a dark red color. The ferric oxide is freed from undecomposed salt by washing with water and then dried. To produce the fusible color 2 parts of this ferric oxide are mixed with 24 of lead glass, prepared as above, and rubbed fine upon a glass plate.

Chamois. Mix and rub fine 1 part of ferric hydrate, produced by precipitating it with aqua ammonia from solution of ferric oxide, and 4 parts of lead glass, prepared as above. This color is laid on very thin and produces a yellowish-brown ground.

Flesh Color. Mix and rub fine 1 part of red ferric oxide, 1 of dark yellow color, No. II. (which see), and 10 of lead glass, prepared as above.

Gray (Chrome). Mix 1 part of ferric hydrate with 2 of protochromate of mercury. Triturate the mixture upon a glass plate and heat it, by placing the saucer containing it into an open muffle, until all the mercury is expelled. The dark red combination of sesquioxide of chromium and ferric hydrate is mixed with 3 times its weight of above-described lead glass. The mixture is then rubbed fine upon a glass plate.

Gray (Iridium). Mix 1 part of sesquioxide of iridium, 4 parts of oxide of zinc, and 22 of above-described lead glass, and rub the mixture fine upon a glass plate.

Green (Dark). Heat protochromate of mercury in a porcelain tube, open on both ends, until all the mercury has been expelled, and mix 1 part of the resulting sesquioxide of chromium with 3 parts of above-described lead glass.

Green (Grass) is obtained by mixing 1 part of bluish-green with 6 of lemon color (which see).

Green (Shading). Mix 8 parts of protochromate of mercury with 1 of sesquioxide of cobalt. Place the mixture in a flat saucer and subject it to the full heat of a porcelain furnace. Mix the

residue with double its weight of lead glass, prepared as above described. The result will be a beautiful black-green color.

Lustre Colors. Gold. Melt in a saucer in a sand-bath 30 parts of colophony, and add 10 parts of uranic nitrate and, with constant stirring, 35 to 40 parts of oil of lavender. When the mixture is entirely homogeneous take it from the sand-bath and add 35 to 40 parts more of oil of lavender,

By intimately mixing the mass thus obtained with a like quantity of bismuth glass, prepared by fusing together 4 parts of oxide of bismuth and 4 of crystallized boracic acid, a brilliant yellow color will be the result.

Orange-red. Melt in a saucer 15 parts of colophony, and mix with it gradually and with constant stirring 15 parts of ferric nitrate and 18 of oil of lavender. When the mixture is homogeneous take it from the fire, and, when cool, add 20 parts more of oil of lavender. By mixing $\frac{1}{3}$ part of this mass with $\frac{2}{3}$ of bismuth glass (see Gold), orange, red, and all intermediate colors can be obtained according to the quantity of bismuth glass used.

Orange. Mix and rub fine upon a marble slab 2 parts of uranic oxide, 1 of chloride of silver, and 3 of bismuth glass (see Gold).

Prismatic Colors. Rub upon a plate cyanide of gold with mercuric cyanide, so that a paste is formed. This, after drying, is triturated with oil of lavender. The auriferous combination is mixed with 1, 2, 3 to 10 times its quantity of bismuth glass (see Gold). Laid on biscuit and coating it with solution of uranium, light and dark iridescent colors are obtained. The colors may all be mixed together or applied one on top of the other. Mother-of-pearl colors can be easier produced upon glass than upon porcelain. For these it is necessary to mix the bismuth glass with lead glass, and frequently chloride of antimony mixed with rosin must be added.

Purple (Dark). Dilute a clear solution of $1\frac{1}{2}$ drachms of gold in *aqua regia* with 20 pounds of distilled water, and add, with constant stirring, $1\frac{1}{2}$ drachms of solution of protochloride of tin. The fluid will assume a deep brown-red color, and precipitation will take place

by adding a few drops of sulphuric acid. The fluid is now poured off, the precipitate washed 5 or 6 times with water, and is then collected upon a filter, where it is allowed to drain off, and then, while still moist, is placed with a silver spatula upon a glass plate, where it is intimately mixed with 3 drachms of very fine lead glass, obtained as above. The mixture is dried, then mixed with $1\frac{1}{2}$ drachms of carbonate of silver, and rubbed fine. About $\frac{1}{2}$ ounce of dark purple will be obtained in this manner.

Purple (Pale). Dissolve $1\frac{1}{2}$ drachms of shavings of tin in boiling *aqua regia*, and concentrate the solution in a water-bath until it becomes solid. In this manner chloride of tin is obtained containing hydrochloric acid in excess, which is dissolved with a little distilled water and mixed with $\frac{1}{2}$ drachm of protochloride of tin of 1.7 specific gravity. The solution of tin is then gradually mixed in a large beaker glass with $2\frac{1}{2}$ gallons of water, but the solution should contain a sufficient quantity of acid to prevent a separation of stannic oxide. A solution of 8 grains of gold in *aqua regia*, which has been previously evaporated nearly to dryness in a water-bath, then diluted with water, and filtered in a dark room, is now added to the solution of tin, which has also been diluted with water.

The fluid will assume a deep red color without a precipitate being formed. The precipitate is immediately formed by adding $1\frac{3}{4}$ ounces of aqua ammonia. Sometimes it happens that the precipitate does not entirely settle after adding the aqua ammonia; in this case the addition of a few drops of concentrated sulphuric acid will suffice to bring about the desired result. The fluid must then be poured off as quickly as possible and the precipitate washed 5 or 6 times with fresh water. It is then collected upon a filter, allowed to drain off thoroughly, and then, while still moist, placed with a silver spatula upon an opaque glass plate with 6 drachms of lead glass, previously rubbed fine. The mixture is dried upon the glass plate, upon which the gold-purple has been rubbed with the lead glass, by placing it in a room free from dust, and, when dry, is mixed with 50 grains of carbonate of silver.

By this process a little over 1 ounce of pale purple should be obtained with the use of 8 grains of gold.

Purple (Rose-red). Dissolve 16 grains of gold in *aqua regia* and compound the solution with a solution of $1\frac{1}{2}$ ounces of alum in 5 gallons of water. Add to this, with constant stirring, $\frac{1}{2}$ fluid drachm of solution of protochloride of tin of 1.7 specific gravity, and then pour *aqua ammonia* into the fluid as long as a precipitate of alumina is formed. When the precipitate has settled pour the fluid off, replace it with 10 times the quantity of water, wash the precipitate with this, and then dry it at a moderate heat. About $\frac{1}{2}$ ounce of dry precipitate will be obtained, which is mixed with 40 grains of carbonate of silver and $2\frac{1}{2}$ ounces of lead glass, prepared in the same manner as given under pale purple, and the mixture triturated upon a glass plate.

The gold colors here mentioned can only be fused upon porcelain glaze, as, when subjected to a higher temperature, the gold and silver are separated in metallic form and assume a dirty brown and leather-like appearance.

Yellow (Dark). I. Mix intimately 48 parts of minium, 16 of sand, 18 of anhydrous borax, 16 of potassium antimoniate, 4 of oxide of zinc, and 5 of ferric oxide. Fuse the mixture in a Hessian crucible until the mass is entirely homogeneous, when it must immediately be removed or the color will become dirty yellow.

No. II. consists of 20 parts of minium, $2\frac{1}{2}$ of white sand, $4\frac{1}{2}$ of potassium antimoniate, 1 of ferric oxide, and 1 of oxide of zinc. The ingredients are fused in a Hessian crucible until the mass is entirely homogeneous.

Yellow (Lemon Color). Mix intimately 8 parts of potassium antimoniate, $2\frac{1}{2}$ of oxide of zinc, and 36 of lead glass. Heat the mixture in a porcelain crucible until it forms a flux. It is then taken out and, when cold, rubbed fine upon a glass plate. The mass must not be fused longer than stated or the color will become decomposed.

Yellow (Pale). First prepare a lead glass by fusing together 8 parts of minium and 1 of white sand. Pulverize and dry this. The color is then prepared by intimately mixing together 4

parts of potassium antimoniate, 1 of stannic oxide, and 36 of the above lead glass. The mixture is fused in a Hessian crucible and allowed to cool, when it is comminuted and rubbed fine.

Yellow (Uranium). Mix 1 part of uranic oxide and 4 parts of lead glass, prepared by fusing together 8 parts of minium and 1 of white sand. This color is only mixed and triturated upon a stone.

Yellowish-red. Heat anhydrous sulphate of iron by placing the saucer containing it in an open muffle furnace. Stir it constantly until the greatest part of the sulphuric acid has escaped. Then take it out and, when cool, wash the ferric oxide with water to remove all traces of undecomposed salt, and then dry it. To produce a fusible color mix 7 parts of the yellowish-red ferric oxide and 24 of lead glass, produced by fusing together 12 parts of minium and 1 of calcined borax, and triturate the mixture upon a glass plate.

Yellow for Figures and Landscapes. Add to the dark yellow colors I. and II. some Naples yellow, which is prepared by placing 1 part of tartar emetic, 2 of nitrate of lead, and 4 of decrepitated common salt in a Hessian crucible and subjecting the mixture to a continued strong heat. The residue is comminuted, washed, dried, and rubbed fine.

Yellow for Landscapes. Mix 8 parts of Naples yellow and 6 of lead glass, prepared by fusing together 2 parts of minium, 1 of white sand, 1 of calcined borax.

White (Covering). Mix and fuse in a porcelain crucible 1 part of minium, 1 of white sand, and 1 of crystallized boracic acid. This color is used for marking the lightest places of the design which cannot be produced by leaving bare the porcelain, and also for mixing—but only in small quantities—with yellow and green colors to make them cover better.

GLASS. COMPOSITION OF THE VARIOUS KINDS OF, COLORS FOR, AND PROCESSES FOR ENAMELLING, ENGRAVING, GILDING, SILVERING, PULVERIZING, FILING, BENDING, ETC.

Dark Green Bottle Glass is prepared from 20 parts of Glauber's salt, 18 of

soap ashes, 90 parts of lixiviated wood ashes, 39 parts of glass flown into the hearth, 179 of broken glass, and 45 of basalt.

Jühkel's Glass for Champagne Bottles consists of 100 parts of feldspar, 10 of lime, $7\frac{1}{2}$ of common salt, and 63 of iron slag.

Elli's Cryolite Glass. A composition of 1 part of cryolite and 2 to 4 parts of pure quartz furnishes a beautiful glass, which can be easily shaped and ground.

Bohemian Crystal Glass (free from lead) is composed of 100 parts of sand, 30 of potash, and 18 of lime.

Plate Glass of the Mirror Manufactory at Aix la Chapelle consists of 100 parts of sand, 38 of sulphate, 38 of carbonate of lime, 2.5 of charcoal, and 0.5 of arsenious acid.

French Mirror Glass. One hundred parts of sand, 24 of chalk, 33 of soda or 38 of sulphate, 2.5 to 2.75 of pulverized coke, and 1 to 2 of arsenious acid.

Belgian Window Glass. One hundred parts of sand, 41 of calcareous spar, 34 of sulphate, 1.5 of pulverized coke, and 0.5 of arsenious acid.

Bohemian Window Glass. One hundred parts of sand, 30 of chalk, 24 of soda, and 1 of arsenious acid.

English Window Glass. One hundred parts of sand, 38 of limestone, 28 of sulphate, 1.3 of pulverized coke, and 1 of arsenious acid.

French Window Glass. One hundred parts of sand, 36 of sulphate, 35 of chalk, 1.75 of pulverized coke or 5 of charcoal, and 1.25 of arsenious acid.

Prussian Window Glass. One hundred parts of sand, 37 of calcareous spar, 34 of sulphate, 5 of soda, 2.25 of pulverized coke, and 1 of arsenious acid.

Stein's Receipts for Compositions of Glass as actually used in Various Glass Works. Potash Crystal Glass. I. One hundred and ten pounds of quartz or very fine and pure white sand, 55 pounds of potash, $4\frac{1}{2}$ ounces of arsenious acid, and $16\frac{1}{2}$ pounds of slaked lime.

II. One hundred and ten pounds of quartz, 66 pounds of potash, 22 pounds of slaked lime, $8\frac{3}{4}$ ounces of arsenious acid, and 1 pound of saltpetre.

III. One hundred and ten pounds of

quartz, 55 pounds of potash, 22 pounds of chalk, $1\frac{1}{2}$ pounds of saltpetre, $1\frac{1}{2}$ pounds of arsenious acid, and $\frac{3}{4}$ ounce of pyrolusite.

IV. One hundred and ten pounds of quartz, $37\frac{1}{2}$ pounds of purified potash, $16\frac{1}{2}$ pounds of slaked lime, and $5\frac{3}{4}$ ounces of pyrolusite.

Bohemian Mirror Glass. I. One hundred and ten pounds of quartz, $73\frac{1}{2}$ pounds of purified potash, $36\frac{1}{2}$ pounds of marble, $7\frac{1}{2}$ pounds of saltpetre, $1\frac{1}{2}$ pounds of arsenious acid, $3\frac{1}{2}$ ounces of pyrolusite, and $\frac{3}{4}$ ounce of smalt.

II. One hundred and ten pounds of quartz, 77 pounds of purified potash, 22 pounds of slaked lime, $7\frac{1}{2}$ pounds of saltpetre, $1\frac{3}{4}$ pounds of arsenious acid, $3\frac{1}{2}$ ounces of potash, and $\frac{3}{4}$ ounce of smalt.

Bohemian Chalk Glass (Ground Glass, White Concave Glass). I. One hundred and ten pounds of white sand, $71\frac{1}{2}$ pounds of potash, $6\frac{1}{2}$ pounds of burned lime, 1 pound of arsenious acid, and $5\frac{3}{4}$ ounces of pyrolusite.

II. One hundred and ten pounds of white sand, 55 pounds of potash, $24\frac{1}{2}$ pounds of chalk, $1\frac{3}{4}$ pounds each of saltpetre and pyrolusite, and $4\frac{1}{2}$ ounces of arsenious acid.

To make the glass produced by these compositions easily fusible, add to each composition $2\frac{3}{4}$ pounds of minium and $5\frac{1}{2}$ pounds of borax.

Bohemian Window Glass. One hundred and ten pounds of white sand, $46\frac{1}{2}$ pounds of potash, and $19\frac{1}{4}$ pounds of limestone.

French Mirror Glass. One hundred and ten pounds of white sand, $36\frac{1}{2}$ pounds of soda, $15\frac{3}{4}$ pounds of slaked lime, and $2\frac{1}{2}$ ounces of pyrolusite.

French Soda Glass. I. One hundred and ten pounds of white sand, $68\frac{3}{4}$ pounds of soda, $8\frac{1}{2}$ pounds of carbonate of lime, $4\frac{1}{2}$ ounces of pyrolusite, $3\frac{1}{2}$ ounces of arsenious acid.

II. One hundred and ten pounds of white sand, $37\frac{1}{2}$ pounds of soda, 16 pounds of carbonate of lime, and $4\frac{1}{2}$ ounces of pyrolusite.

III. One hundred and ten pounds of white sand, 33 pounds of soda, $38\frac{1}{2}$ pounds of chalk, $4\frac{1}{2}$ ounces of pyrolusite, and $3\frac{1}{2}$ ounces of arsenious acid.

IV. One hundred and ten pounds of white sand, $38\frac{1}{2}$ pounds of soda, 44

pounds of chalk, $4\frac{1}{2}$ ounces of pyrolusite, and $3\frac{1}{2}$ ounces of arsenious acid.

Composition No. I. gives a soft glass, No. II. a hard, and No. III. a very hard glass.

White Soda Window Glass. I. One hundred and ten pounds of sand, $48\frac{1}{2}$ pounds of Glauber's salt, $3\frac{1}{2}$ pounds of pulverized wood charcoal, $4\frac{1}{2}$ pounds of burned lime.

II. One hundred and ten pounds of sand, 55 pounds of Glauber's salt, $3\frac{1}{2}$ pounds of pulverized charcoal, and 22 pounds of limestone.

III. One hundred and ten pounds of sand, $49\frac{1}{4}$ pounds of Glauber's salt, $3\frac{1}{2}$ pounds of pulverized coke, and 20 pounds of limestone.

IV. One hundred and ten pounds of sand, $35\frac{1}{4}$ pounds of Glauber's salt, $2\frac{1}{2}$ pounds of coal, and $49\frac{1}{2}$ pounds of limestone.

V. One hundred and ten pounds of sand, 33 pounds each of Glauber's salt and limestone, and $3\frac{1}{2}$ pounds of charcoal.

VI. One hundred and ten pounds of sand, $38\frac{1}{2}$ pounds of Glauber's salt, $6\frac{1}{2}$ pounds of soda, 33 pounds of limestone, and $3\frac{1}{2}$ pounds of charcoal.

Compositions Nos. V. and VI. furnish window glass of established excellence.

Semi-white Potash Window Glass. I. One hundred and ten pounds of sand, $126\frac{1}{2}$ pounds of lixiviated wood ashes, $36\frac{1}{2}$ pounds of potash, and $24\frac{1}{4}$ pounds of limestone.

II. One hundred and ten pounds of sand, 132 pounds of lixiviated wood ashes, $38\frac{1}{2}$ pounds of potash, $19\frac{1}{2}$ pounds of limestone, and $4\frac{1}{2}$ ounces of pyrolusite.

III. One hundred and ten pounds of soda, 33 pounds of potash, $24\frac{1}{4}$ pounds of limestone, and $16\frac{1}{2}$ pounds of common salt.

All the compositions for window glass given above may also be used for hollow glassware.

Bottle Glass. I. One hundred and ten pounds of sand, 22 pounds of Glauber's salt, $2\frac{1}{2}$ pounds of coal, $49\frac{1}{2}$ pounds of basalt, and 22 pounds of carbonate of soda.

II. One hundred and ten pounds of sand, 176 pounds of wood ashes, and 55 pounds of basalt.

III. One hundred and ten pounds of

sand, $27\frac{1}{2}$ pounds of Glauber's salt, $3\frac{1}{2}$ pounds of coal, $37\frac{1}{2}$ pounds of limestone, and $4\frac{1}{2}$ pounds of basalt.

The last two compositions furnish a good glass for champagne bottles.

Lead Crystal Glass. I. One hundred and ten pounds of quartz, $73\frac{1}{2}$ pounds of minium, and $36\frac{1}{2}$ pounds of purified potash.

II. One hundred and ten pounds of sand, 66 pounds of minium, and 22 pounds of potash.

III. One hundred and ten pounds of sand, $49\frac{1}{2}$ pounds of minium, $39\frac{1}{2}$ pounds of purified potash, and 1 pound of arsenious acid.

IV. One hundred and ten pounds of sand, 77 pounds of minium, $28\frac{1}{2}$ pounds of purified potash, $5\frac{1}{2}$ pounds of saltpetre, and $4\frac{1}{2}$ pounds of borax.

V. One hundred and ten pounds of sand, $46\frac{1}{4}$ pounds of minium, $36\frac{1}{2}$ pounds of purified potash, $18\frac{1}{2}$ pounds of saltpetre, and $\frac{1}{2}$ pound of pyrolusite.

It is advisable to add broken glass to all the above compositions.

Crown Glass (according to Bontemps).

I. One hundred and ten pounds of white sand, $45\frac{3}{4}$ pounds of purified soda, $24\frac{3}{4}$ pounds of carbonate of lime, and $1\frac{1}{2}$ pounds of arsenious acid.

II. One hundred and ten pounds of white sand, 33 pounds of potash, $18\frac{1}{2}$ pounds of soda, $13\frac{3}{4}$ pounds of chalk, and $13\frac{1}{2}$ ounces of arsenious acid.

Crown Glass (according to Guinaud). One hundred and ten pounds of white sand, 44 pounds of American potash, $5\frac{1}{2}$ pounds of minium, $5\frac{1}{2}$ pounds of borax, and $4\frac{1}{2}$ ounces of pyrolusite.

Flint Glass. One hundred and ten pounds each of quartz and minium and 33 pounds of purified soda.

Flint Glass (according to Bontemp).

I. Two hundred and eighty-seven and one-quarter pounds of sand, a like quantity of minium, 66 pounds of potash, and 20 pounds of borax.

II. Forty-seven and three-quarter pounds of sand, a like quantity of oxide of lead, 11 pounds of carbonate of potash, and $3\frac{1}{2}$ pounds of saltpetre.

Compositions for Strass (according to Donault-Wieland). I. Three hundred parts of rock crystal, 470 of minium, 163 of potash purified with alcohol, 22 of borax, and 1 of arsenious acid.

II. Three hundred parts of rock crystal, 462 of minium, 163 of potash purified with alcohol, 18 of borax, and $\frac{1}{2}$ of arsenious acid.

III. Three hundred parts of the whitest sand, 514 of pure white lead, 96 of potash purified with alcohol, 27 of borax, and 1 of arsenious acid.

IV. One hundred parts of rock crystal, a like quantity of minium, 66 of borax, 22 of saltpetre, and 5 of arsenious acid.

Compositions for Opaque Glass. Tin Enamel. The percentage of tin in this enamel varies very much. To obtain the oxide of tin, either equal parts of lead and tin as a maximum are fused together, or a smaller quantity of tin, as low as 15 parts, to 100 of lead. Two hundred parts of this mixture of oxides are combined with 100 parts of sand and 80 of pure potash to form the enamel.

Arsenical Enamel. I. One hundred parts of sand, 16 of potash, 6 of lime, 130 of minium, $\frac{1}{2}$ of saltpetre, and 10 of white arsenic.

II. One hundred and ten pounds of sand, 73 $\frac{1}{2}$ pounds of minium, 36 $\frac{1}{2}$ pounds of potash, 5 $\frac{1}{2}$ to 10 pounds of saltpetre, 1 $\frac{1}{2}$ to 4 $\frac{1}{2}$ ounces of pyrolusite, 4 $\frac{1}{2}$ pounds of white arsenic, and 1 $\frac{1}{2}$ pounds of teroxide of antimony.

III. One hundred parts of sand, 200 of minium, 60 of potash, and 30 of white arsenic.

Bone Glass. Take an ordinary composition for potash, soda, or lead glass, and add, according to the degree of transparency desired, from 10 to 20 per cent. of bone-ash. Besides bone-ash, oxide of tin or arsenious acid is added in some glass works. We give a few receipts:

I. One hundred parts of sand, 40 of potash, 25 to 30 of oxide of tin, 12 of air-slaked lime, 10 of minium, and 2 of arsenious acid.

II. One hundred parts of sand, 45 of calcined soda, 16 of air-slaked lime, 6 of bone-ash, and 3 of arsenious acid.

III. One hundred parts of sand, 23 of potash, 15 of soda, 12 of borax, 30 of bone-ash, and 1 $\frac{1}{2}$ of arsenious acid.

Opal Glass. This differs from bone-glass only in containing a smaller percentage of bone-ash, of which 2 to 4 per

cent. only are added to a suitable white-glass composition.

Alabaster Glass. One hundred parts of sand, 43 of potash, 4 $\frac{1}{2}$ of saltpetre, 6 of bone-ash. This glass must be fused at as low a temperature as possible.

Compositions for Colored Glass. The basis of these compositions is generally lead crystal, or potash crystal-glass, to which a small quantity of oxide of lead is sometimes added; although soda-glass is also frequently colored. But the composition depends always on the purpose for which the colored glass is to be used. As colored glass is mostly worked in combination with plain glass, its basis of crystal or soda-glass must be constituted in accordance with the quality of the glass to be combined with it. In other words it must be as hard, or as soft, in fact must possess the same expansion coefficient as the glass with which it is to be combined, or else changes of temperature will produce cracks and separation of the layers.

Aventurine Glass (according to Clément). Three hundred parts of pulverized glass, 40 of cuprous oxide, 80 of iron scales. The following composition seems to us more suitable: One hundred parts of sand, 13 of lime, 18 of soda, 2 of minium, 3 of oxide of tin, 6 of iron scales, and 6 of copper scales.

Blue Glass, No. I. Fifty parts of sand, 16 $\frac{1}{2}$ of soda, 10 of chalk, and 5 of zaffre.

No. II. One hundred parts of sand, 150 of minium, 35 of potash, 10 of borax, and 4 of cobaltic oxide.

No. III. One hundred parts of sand, 50 of potash, 6 of air-slaked lime, and 1 of cobaltic oxide.

Sapphire Blue is obtained by adding from $\frac{1}{4}$ to 3 per cent. of cobaltic oxide.

Azure Blue is produced with an addition of 1 per cent. of cupric oxide.

Golden Topaz Glass is produced by adding $\frac{1}{2}$ per cent. of uranic oxide to a crystal-glass composition.

Green Glass, No. I. Fifty parts of sand, 15 of soda, 5 of chalk, 1 of saltpetre, 5 to 10 of ferric oxide, and 3 to 10 of cupric oxide.

No. II. Thirty-seven and a half parts of sand, 12.5 parts of soda, 6 of chalk, 2 of saltpetre, 2 to 5 of ferric oxide, and 2 to 5 of cupric oxide.

No. III. Sixty parts of sand, 20 of soda, 6 of chalk, 1 of saltpetre, 0.8 to 1 part of chrome green.

No. IV. One hundred parts of sand, 50 of potash, 8 of air-slaked lime, and 2 of chrome green.

No. V. One hundred parts of sand, 85 of minium, 38 of potash, 4 of oxide of antimony, and 2 of cobaltic oxide.

Hyalite Glass, No. I. One hundred parts of sand, 66 of potash, 8 of air-slaked lime, 6 of arsenious acid, 5 of cobaltic oxide, 5 of pyrolusite, and 5 of ferric oxide.

No. II. One hundred parts of sand, 82 of minium, 38 of potash, 8 of saltpetre, 4 of cobaltic oxide, 4 of pyrolusite, 6 of iron scales, and 6 of copper scales.

Orange Glass is obtained by adding 2 per cent. of ferric oxide and $\frac{3}{4}$ per cent. of pyrolusite to the composition for yellow glass, which see.

Red Glass. The following color serves for flashing the glass: One hundred parts of sand, 200 of minium, 6 of copper ashes, and 6 of tin ashes.

Red with Copper is produced by adding 1 per cent. of cupric oxide and 1 to $1\frac{1}{2}$ per cent. of iron scales to a composition of white or crystal glass. We give two receipts:

No. I. One hundred parts of sand, 160 of minium, 7 of copper scales, and 7 of tin ash.

No. II. One hundred parts of sand, 200 of minium, 6 of copper ashes, and 6 of tin ashes.

Red with Gold. One hundred parts of silica, 10 of best potash, 80 of minium, and $12\frac{1}{2}$ of saltpetre. Fuse this composition, and add for every 10 pounds of the composition a dollar gold piece dissolved in *aqua regia*.

Turquoise Glass. One hundred parts of pulverized quartz, or sand free from iron, 40 of best potash, 11 of saltpetre, and $\frac{1}{2}$ to $\frac{3}{4}$ of cupric oxide.

Violet Glass. I. Fifty-five parts of sand, 15 of soda, 2 of saltpetre, 5 of chalk, 10 of pyrolusite, and 2 of ferric oxide.

II. Fifty-eight parts of sand, $16\frac{1}{2}$ of soda, 2 of saltpetre, 10 of chalk, and 2 to 10 of pyrolusite.

Yellow Glass. I. Sixty-five parts of sand, 25 of soda, 3 of chalk, 1 of alderwood charcoal.

II. Fifty-five parts of sand, 15 of soda, 5 of chalk, 2 of saltpetre, 16 of pyrolusite, and 13 of ferric oxide.

III. One hundred parts of sand, 50 of potash, 8 of air-slaked lime, 6 to 10 of lead antimoniate. This composition furnishes the yellow used for Rhine wine bottles.

New Combination of Materials for the Production of Glass. Seventeen parts of sand or silica, 4 of sodium carbonate, and 2 of borax. It is claimed that the glass produced from this composition equals flint or crystal glass in transparency, clearness, and lustre, and can be produced at half the cost.

Iridescent Glass. The moment when the glass which is to be made iridescent has been given the highest degree of heat the following mixture is introduced into the annealing chamber through an aperture: One part of carbonate of baryta, $\frac{1}{2}$ part of strontium, and 2 of tin salt. The vapors which are developed produce the lustre. Strontium gives *red*, baryta *blue*, and tin salt various colors.

Engraving on Glass. Grind the glass until it is opaque and draw the design upon it with a mixture of anhydrous boracic acid, gum, and water. When the drawing is dry, heat the glass sufficient to melt the boracic acid. The acid gives the glass its original transparency, and the design is fixed. Colored designs are produced by adding different metallic oxides to the boracic acid.

Colored Designs upon Glass. Coat the glass with shellac varnish, oil of turpentine, or mucilage. Cover with the pattern and dust the pulverized colors over the cut places in the pattern. When dry, place the glass in a closed muffle to burn in the colors.

Glass Engraving. Coat the glass with wax and engrave the design so that it shows through. Pour 2 parts of sulphuric acid over 1 part of pulverized fluorspar in a leaden basin, and over it place the prepared glass, drawing down. The design will be etched into the glass in about an hour or two. The wax is removed with oil of turpentine.

A simpler process is to apply an aqueous solution of hydrofluoric acid to the design with a soft brush. By repeating this operation several times

the design or scale will be found engraved upon the glass. [Etching with the aqueous solution is much inferior in sharpness and opacity to that done with the vapor. W].

To Pulverize Glass. Heat the glass to a red heat, and while in this condition plunge it into cold water; then dry and pulverize it. It becomes more friable by the sudden cooling.

To Bend Glass Tubes. If a sharp bend is required, heat only a small portion of the tube to a dull red heat, at the same time turning it in the flame, so that it shall be softened uniformly all around, and bend with the hand held at the opposite ends, applying pressure gradually. If the bend is to be gradual, heat an inch or two of the tube before bending it. If a gradual bend on the one side is wanted and a sharp one on the other, as in retorts, a little management of the tube in the flame, moving it to the right and left alternately, at the same time turning it around, will easily form it into the desired shape. In bending glass, the part which is to be concave must be heated most.

An ordinary gas flame can be used for bending glass, but that of a Bunsen burner is to be preferred.

[If the tube is of large diameter it will be impossible to get sufficient heat to soften it enough for the purpose, except with the glass blower's lamp. To avoid the "kinking" of the bend on the inside, which will contract the area of the tube at the bend, it is necessary with large tubes to fill them first with sand, closing the ends with corks. The sand will give the necessary support to the walls of the tube in bending.]

The secret of success in all these manipulations lies chiefly in the art of heating the portion of the tube to be bent *uniformly*, and this is only accomplished by keeping the tube, while in the flame, constantly and evenly turning. W.]

GLAZES FOR EARTHEN-WARE.

Glazing for Common Earthen-ware. Water-glass (potassium or sodium silicate) of 35° Beaumé, either alone or with the addition of 20 per cent. of red

lead and 5 per cent. of silicic acid, is used. The thick solution is laid upon the half-burned ware by means of a brush. It is also used for glazing crockery, being quite indestructible when well burned.

English Glaze for Earthen-ware. The glaze is fixed on light yellow ware of great uniformity and porosity and of a fire-proof clay. It is of a dark violet-brown color and somewhat translucent, of extraordinary lustre and free from flaws. It consists of 28 parts of quartz sand, 40 of silver litharge, 18 of pipe-clay, 9 of best manganese oxide, and 5 of chalk.

In order to produce uniformity and beauty of color the materials are fused into a frit and then ground finely. The burning of the frit can be easily accomplished in a potter's oven furnished with a cover.

Glazes free from Lead for Earthen-ware. Pulverize a mixture of 4 parts of calcined soda and 5 of white sand free from iron, and place the powder in a crucible which has been chalked in the inside and expose it to the full heat of a potter's oven, where it is melted into a spongy glass, which, in a pulverized state, is used for glazing.

The following mixtures are treated in the same manner:

I. Thirty-two parts of pulverized glass, 16 of borax, and 3 of tartar.

II. Fifty parts of soda and 90 of flint.

III. Eighty parts of soda, 70 of sand, and 10 of clay.

IV. Three parts of calcined soda and 4 of quartz sand.

New Glazing free from Lead for Kitchen Utensils. Melt together 100 parts of borax, 50 of feldspar, and 50 of clay. The hot, fluid mass is diluted with water until it has a temperature of 120° F., when the previously heated utensils are dipped into it and then burned in a good oven.

Another glaze, which is very solid and resists acids almost as well as glass, consists of 100 parts of powdered quartz, 80 of purified potash, 10 of saltpetre, and 20 of air-slaked lime. The ingredients are melted, powdered, mixed, and heated.

Very Fine Composition for White Glaze, which is used in *Feilmer's* manufactory in *Berlin*, is obtained by mix-

ing 36 parts of ash, 27 of sand, and 15 of salt, and ashing over with 20 parts of lead and 10 of tin.

White Glazes. I. Mix intimately 100 parts by weight of white glass, 50 of white sand, 40 of dry, common salt, 120 of plumbic oxide, and 60 of tin ashes.

II. One hundred parts of plumbic oxide, 50 of tin ashes, 100 of white sand, 50 of glass, 10 of common salt, 10 of heavy spar, and 5 to 10 of dry soda. This is more fusible than No. I. Both mixtures furnish a whiter coating the freer the clay is from iron with which the articles are manufactured.

III. Melt together 24 to 25 parts of red lead, 15 to 16 of tin ashes, 36 to 38 of quartz sand, 12 to 14 of potters' clay-free from iron, 7 of carbonate of lime, 3 of carbonate of magnesia, and 18 to 20 of calcined soda. The mass, when cold, is comminuted, ground, and sifted.

To Give Earthen-ware or Porcelain a Marbled or Granite Appearance. Dissolve gum tragacanth in water to the consistency of a thick syrup, which will require 3 to 4 days, and add about 10 times its bulk in water to reduce its specific gravity to 1.003. Now prepare a decoction of $\frac{3}{4}$ ounce of seeds of fleabane (*Psyllium pulicaria*) in 1 gallon of water and mix 1 part of this decoction with 5 of solution of gum tragacanth. On account of the high specific gravity of the coloring substances used in the process it becomes necessary to add 1 pound of very thin solution of clay in water to each pound of the mixture, as without this precaution the pigments would not float on the surface of the preparation. The pigments—colors used under glaze are mostly employed—are triturated with water and kept in special pots until used, when they are mixed with beef gall. To prevent the beef gall from spoiling some carbolic acid is added. Now spatter by means of a brush the different colors mixed with beef gall upon the surface of the mixture of the gum tragacanth, decoction of fleabane seed, and solution of clay. Marbled veins will immediately be formed, which can be worked into imitation of any desired variety of marble by stirring the mass with a horse comb or similar instrument. The articles, which should be rather porous, are dipped into this solution, then

washed to remove the shiny preparation, heated in a muffle, glazed, and treated like common ware. Any variety of decoration can be prepared by painting parts on the surface of the articles with round lake or white lead mixed with gum Arabic, marbling the unpainted spots, and washing of the reserved places; or by impressing copper prints, covering them with round lake, and marbling. If glazed articles are to be marbled pigments rubbed with oil are used. The article must first be coated with dammar resin dissolved in oil of turpentine ($1\frac{3}{4}$ ounces of resin dissolved in 1 pound of oil of turpentine). After the coating is perfectly dry the article is treated in the same manner as the unglazed. With skill in the manipulation very beautiful articles can be prepared by this process.

GLASS AND OTHER SIGNS.

The following directions for making glass signs are by *W. Arrenbrecht*:

I. *To Etch Glass (Fine-grained).* Paint the entire glass, except the parts to be etched, with asphaltum or, best, with ordinary iron lacquer which covers well, and allow it to dry, but not entirely hard, as otherwise the acid is apt to find its way under the iron lacquer. Place a rim of putty, prepared with wax and starch, around the design, care being had that it laps over upon the iron lacquer. Then pour hydrofluoric acid upon the surface, let it stand for 5 minutes, pour it back into the flask, and wash the entire surface with water. Then remove the asphaltum with oil of turpentine and wash again with white soap and water.

II. *To Etch Glass (Coarse-grained).* Proceed in the same manner as above, but throw emery into the acid immediately after it has been poured upon the surface; let it remain for 5 minutes, then pour it back into the flask and wash and cleanse as above.

III. *Gilding Glass.* Polish the glass thoroughly with whiting and then with a linen rag dipped in alcohol. Prepare a size by boiling 2 ounces of isinglass in sufficient water to cover it, and, when dissolved, add 1 quart of alcohol, and then dilute to 2 quarts with water, and

filter. Flood the surface to be gilded with the size, lay the gold leaf flat on it, and scatter elutriated chalk (whiting) previously warmed over the whole. Should the chalk form lumps in heating; rub it fine, but the dusting over with chalk must be delayed until the gold leaf is dry. When the gold leaf is entirely dry dust it off with a fine brush and then polish it with a piece of silk velvet. Repeat the gilding once more, and then back all the gold which is to remain with copal or dammar lacquer. When this is dry remove the superfluous gold by rubbing with the moistened finger.

IV. *Silvering on Glass* is done in the same manner as gilding, but somewhat more isinglass is used, as the silver leaf being softer than gold leaf requires a stronger agglutinant.

V. *Gilding on Show Windows*. The same solution of isinglass given under III. is used. Cover the surface to be gilded with the mixture and lay on the gold obliquely. When dry, polish the gold with a rag of silk velvet and repeat the operation.

VI. *Correcting the Isinglass Mixture*. If, after the second polishing, stains should make their appearance in the gold, the solution contains too much isinglass and must be diluted by adding distilled water and rectified alcohol. But if the gold cannot be polished the mixture contains too little isinglass. It is therefore advisable to first test the solution upon a piece of glass.

VII. *Backing the Inscription on Show Windows*. After rubbing off the superfluous gold with the finger apply to the entire inscription a coat of good oil paint mixed with some hemp oil and English carriage lacquer, which will preserve the inscription even upon panes covered with sweat, and its durability can be guaranteed for years.

VIII. *Backing Glass Signs without Shades*. After rubbing off carefully the superfluous gold with the finger apply 2 coats of Frankfort black rubbed up in oil to the entire back of the glass and inscription.

IX. *Backing Glass Signs with Shades*. Apply 2 coats of the same black, but leave the shades free. When the black is dry, paint the places left for the shades with red, green, blue, etc., oil paint.

X. *With Mother-of-pearl Insertions*. Gild in the manner given above. When the gold is dry, coat only the outlines of the inscription with copal or dammar lacquer. After carefully removing the superfluous gold apply 2 coats of the mentioned black oil paint, leaving free the inner part of the inscription, etc., for the mother-of-pearl. If the inscription is to be shaded proceed in the same manner as given under IX.

XI. *Mother-of-pearl Insertions*. Very thin laminae of mother-of-pearl of different colors are used. Select suitable pieces, and, if too large, break them in two. Then coat first the places left free in the inscription with dammar lacquer, and then one side of each of the pieces of mother-of-pearl; lay them on the inscription and press them gently down with the handle of the brush, continuing thus until the entire surface is covered. Do not place the pieces close together, but leave small interstices between them, which are afterward filled up with lacquer and pulverized oyster shells or other shells dusted in.

XII. *Backing with Tin foil* is done in the same manner as with mother-of-pearl, except that the oil paint is not allowed to dry entirely, but to remain just sticky enough to fasten the tin foil by a gentle pressure, care being had to place the glossy side of the tin foil upon the glass.

Transparent Glass Sign (Child's American Patent). Coat a glass plate with paint so that the places to be transparent remain free. Back this glass plate with a second, and fill the space between them with pieces of colored glass of irregular sizes. By illuminating the sign from the back a wonderful effect is produced. Further, the filling of such a sign could be set in motion by a suitable apparatus, thus producing a kaleidoscopic effect.

Sign Painting. It may be laid down as a general rule for all Roman capitals, except I, J, M, and W, that the extreme breadth should equal the height; the breadth of I and J is equal to half the height, and that of M and W to $1\frac{1}{2}$ times the height. Gilt letters are written with Japan size, a substance which soon acquires such a state, between dryness and wetness, that leaf gold laid

on it adheres perfectly. The gold leaf should be gently dabbed over with a pad of cotton wool, which will smooth the surfaces of the gilding and remove all superfluous pieces of gold leaf.

Japan Gold Size. Boil 2½ gallons of linseed oil for 2 hours, then add gradually and in small portions at a time 1½ pounds each of litharge and minium and 9½ of sulphate of iron, keeping the oil boiling all the time and stirring from the bottom of the pot. It is advisable to have a large iron ladle ready to cool the mass down, if it should appear to rise too high, by ladling a part of it into an empty pot. After boiling the oil for about 3 hours melt 2½ pounds of gum anime and heat ½ gallon of raw linseed oil. When the gum is melted pour in the oil; let it boil until clear, then cool for a few minutes and add it to the first oil. Wash out the pot in which the gum has been melted and melt 2½ pounds more of gum anime and heat ½ gallon more of oil in the same manner as before and add that also to first oil. Now urge the fire in the furnace, but keep it well in front, so that it can be drawn at a moment's warning. The gold size will soon throw up a frothy scum on the surface, which must be constantly kept down by stirring with the ladle, and never be allowed to rise higher than 4 inches below the edge of the pot. After boiling for about 5 hours it will commence to become stringy, but boiling must be continued until it hangs to the ladle and drops in lumps. Now take the size from the fire and cool it as quickly as possible, and when cool enough mix it with 8 gallons of turpentine, but do not stir until all the turpentine is in and the froth on the surface has disappeared, and then strain as quickly as possible.

GLUE, MANUFACTURE OF.

Glue, as is well known, is manufactured from the parings of skins and hides steeped in lime-water. The waste of calf and sheepskins gives the best glue; that from horse-hides is dark and of a poor quality. In buying the waste, it frequently occurs that particles of flesh are mixed with them. This is not actually injurious, as in manufacturing the glue they are regained as fat.

The materials from which glue is boiled are called "glue stock," and consist of:

- a. Waste of tanneries, yielding as much as 44 to 46 per cent. of glue;
- b. Waste obtained in preparing the skins of sheep, goats, and kids;
- c. The scarf-skin of bullocks' hides and waste in fleshing the hide, giving about 30 per cent. of glue;
- d. Waste of Buenos Ayres skins, yielding 50 to 60 per cent. of glue;
- e. The tendons, buttock pieces, and generative organs of cattle with 35 per cent. of glue;
- f. Horse sinews with 15 to 18 per cent. of glue;
- g. Old gloves, rabbit skins from which the hair has been removed by hatters, also dog and cat skins;
- h. Bullocks' feet and parchment shavings with 62 per cent. of glue;
- i. Waste of tanneries, as foot, head, and buttock pieces, which tanners cut off before tanning, ear-laps of sheep and cows, sheeps' feet with the tendons, small bones and waste of skins. Good material of this kind yields 38 to 42 per cent. of glue;
- k. Skins unfit for tanning, or such as have been used for packing purposes; for instance those in which indigo is brought from South America. This stock yields from 50 to 55 per cent. of glue;
- l. Cartilages and other waste of fish.

The yield of glue from waste, as will be seen from the above, varies very much. From 500 pounds of good material, 250 pounds of glue may be obtained, while 650 to 1200 pounds of poor stock may be required for the same quantity.

Steeping the Stock in Lime. The glue stock is generally steeped in lime-water in order to preserve it, but before boiling it into glue it must be again steeped, and this becomes especially necessary when, after being washed in pure water, the waste assumes a bluish color and becomes very soft. This is a sure sign that it contains too little lime, and it must then remain for a few days in thin lime-water, when it is dried. The best manner of doing this is as follows: Steep the waste in clear water for 24 hours, then place it in a basket to drain off the water; after draining steep it for

Duffell

several days in thin lime and replace it in the basket to drain, and wash off with clean water and dry. This steeping in lime-water is of the utmost importance, as the quality of the glue is mainly dependent upon it. Too much steeping yields a *small* quantity of glue, but of an excellent quality, while that obtained from glue stock steeped only for a short time is dark.

It is best to store fresh or undried glue stock during the winter in wooden or brick vats containing dilute lime-water, well stirred when putting in the waste.

The glue boiling, which is best done in the open air, is commenced in spring, as soon as the weather permits. This can be done with *wet* and with *dry* waste.

Boiling with wet waste is done by covering glue stock in a vat with water and allowing it to soak for 12 hours, then drained, and all signs of lime washed off. It is then piled in heaps and exposed to the air for 12 to 24 hours to evaporate the acrid constituents. It is now boiled, the work being commenced as early in the morning as possible.

be sufficiently steeped in lime, washed, and dried.

The actual boiling is done in a copper or iron boiler (Fig. 13), which, if 250 pounds of glue are to be manufactured, should be large enough to hold at least 275 gallons of water. It should be somewhat shallower than its width, and should have a double bottom bent inwards in order to offer greater resistance to the fire. It should be further provided with a discharge pipe and cock, through which the fluid glue is drawn off. Upon the bottom of the boiler is a perforated bottom of sheet iron or copper, to prevent the waste from lying immediately upon the bottom, and burning.

It is an easy matter to procure all the warm water which may be required by utilizing the waste heat for heating water in a reservoir erected in the direction in which the gases of combustion escape. It is placed higher than the boiler so that the warm water can be readily drawn from it into the latter (see Fig. 13).

When everything is in proper shape,

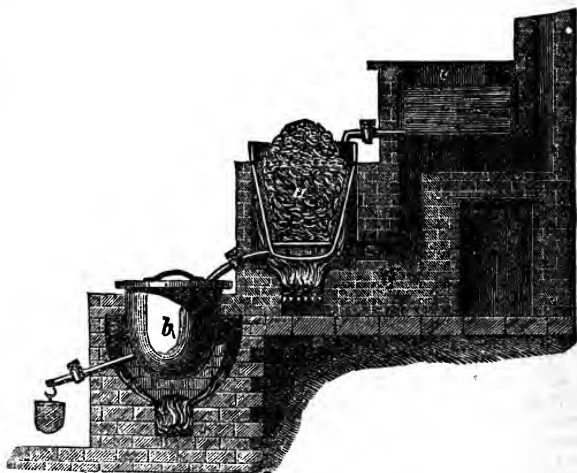

Fig. 13.

For boiling with dry waste nothing further is required than that it should the bones, sinews, and other constituents are placed in the boiler, and on

the top of this a sufficient quantity of waste to fill the boiler. If this holds 275 gallons, about 125 gallons of clean water are added, if wet material is used, and about 225 gallons to dry stock. The mass is now boiled until a sample taken from the boiler cools to a jelly. This, for wet material, requires generally 1 hour; for dry stock, 2 hours. The glue will be ready for cutting when a sample, poured into a cup, can be conveniently taken out when cold. The fluid is then drawn off into the cooling vat (clarifying vat). This is also provided with a discharge pipe and cock and placed high enough to allow of a bucket being conveniently put under it. When the glue has become clear it is drawn off and poured into boxes (moulds).

A fresh quantity of waste is added to the material remaining in the boiler, and boiled. This is called the *second boiling*, and is treated in the same manner as the first.

The residue remaining in the boiler after the second boiling is boiled until the fluid forms glue. This is called the *third boiling*. The product is treated in the same manner as the foregoing.

The residue from the third boiling is used for preparing the so-called *glue-water*. This is made by pouring in enough water to cover the residue in the boiler from 2½ to 3½ inches deep, and boiling about 2 hours, until all glutinous substances have been dissolved. This fluid is too weak to form glue. It is added to the next boiling of glue stock, to accelerate the process.

Clarifying the Glue. This is done either with alum or white of egg. Pulverize 2½ to 4½ pounds of alum for every 200 pounds of glue, and dissolve it in 50 pounds of boiling glue taken from the boiler. Add this solution to the mass in the boiler, and let the whole boil for 10 minutes longer, when the clarified glue is drawn off into the cooling vat. The glue may also be clarified by dissolving for every 100 pounds of glue ¾ pound of purified borax finely powdered and 3 ounces of purified potash in boiling glue, and pouring this into the fluid in the boiler.

To Color the Glue Yellow. For every 100 pounds of glue to be colored dissolve 1 to 2 pounds of finely-powdered

crystallized soda in boiling glue, and stir this into the boiler until a uniform yellow color is obtained.

To Whiten the Glue. For every 100 pounds of glue add 2 pounds of sugar of lead completely dissolved in a hot solution of glue. Mix it thoroughly with the glue in the boiler, and then add 2 pounds of pulverized white vitriol (sulphate of zinc) also dissolved in boiling glue.

Pouring into the Boxes (Moulds). This is done as soon as the glue has

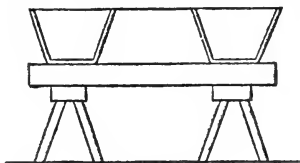

Fig. 14.

been boiled, sufficiently cooled, and clarified. The boxes (Figs. 14, 15) are

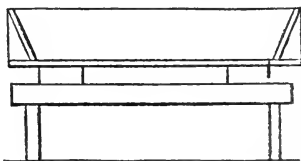

Fig. 15.

made of pine, and are generally 4 feet long, 8½ inches wide, and 6 inches high. They should be very smooth inside and water-tight. Before the glue is poured into them they should be kept filled for 1 day with fresh milk of lime. This is called *freshening* the boxes. In the spring the boxes should be given a coat of pure linseed oil, which will facilitate the removal of the congealed glue.

The operation of pouring the glue into the moulds is a very simple one: A funnel (Fig. 16) with a flat bottom reaching over the edges of the mould sits so firmly upon them as to need no support from the workman. In the funnel is a small sieve (Fig. 17) of horsehair, which keeps back any impurities in the glue. When the first



Fig. 16.

mould is filled, place the funnel upon the next, and so on until the vat is empty.

Taking the Glue from the Moulds.

Twelve hours are generally required for the glue to con-

geal, but in warm weather 24 hours may be necessary. In taking the mass from the mould dip the blade of a large knife (Fig. 18) in cold water, and with it loosen the glue from the sides of the box, which must be done skilfully and quickly.

The box is then emptied on a table and the glue quickly cut into pieces of desired shape and thickness with a copper knife dipped in water.

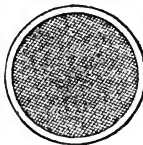

Fig. 17.

When a few cuts have been made the knife is again dipped in water, in order to give to the pieces a smooth surface and prevent them from becoming full of cracks. The hand is now dipped into water, and the pieces of glue laid upon hurdles strung with cord similar to a net (Figs. 19, 19a) which are then carried into the drying-room and placed upon frames provided with strips set $2\frac{1}{2}$ to 3 inches apart (Fig. 20). In the course of a few hours the glue upon the hurdle is turned. It is then allowed to dry gradually, and when nearly dry is



Fig. 18.

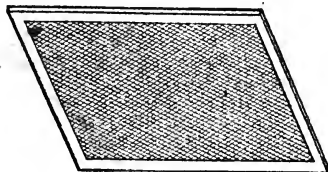

Fig. 19.

strung upon cord by means of a needle, and dried completely in the air, and is then ready for the market.

Ruthay's New Process of Making Glue from Waste of Hides and Skins

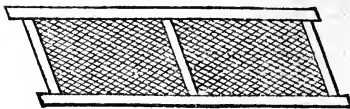

Fig. 19a.

in Tanneries. The waste is placed in water until it begins to smell, and then

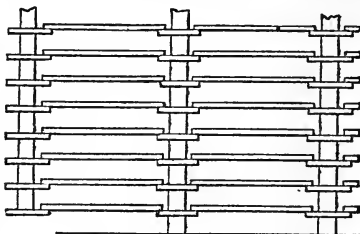

Fig. 20.

washed in running water. Two and a half parts of sulphuric acid of 1.035 specific gravity to every 11.2 parts of the waste, while it is still moist, are then poured over it, and it is allowed to stand in a covered vessel for 24 hours. The acid is then poured off, the waste washed in clean water, and the same amount of sulphuric acid to the same quantity of waste again poured over it. After allowing it to stand quietly for some time, it is thoroughly washed to remove all traces of acid, pressed out, and placed in a vat of such capacity that it will be filled about $\frac{2}{3}$ by it. The vat is then filled with water of 110° F., covered, and the mass allowed to stand quietly for 24 hours. The liquid is then drawn off, and, on cooling, congeals to a colorless gelatine. Water of a higher temperature is poured upon the residue in the vat. After 24 hours this fluid is drawn off and allowed to congeal to gelatine, and the process is repeated until everything has been dissolved. This gelatine can be kept for a long time in well-closed jars.

Glue from Waste of Tanned Leather.

Place the waste in soda lye of 1.025

specific gravity for 6 to 12 hours, and then press out. To extract all the tannin, which is absolutely necessary for the gaining of glue, the waste must be again treated with soda lye. It is then thoroughly washed, placed in dilute acid for 24 hours; then, to neutralize the acid, in a weak solution of soda, and finally thoroughly washed with water, when it is ready to be worked into glue in the ordinary manner.

Maclagan's Apparatus and Process for Manufacturing Glue and Gelatine. The apparatus is intended for the extraction of gelatine from bones by the aid of steam. Fig. 21 represents a side

and in the evaporating pan *e* to the boiling point; *m* cocks for the escape of condensed steam; and *n* a crank which moves a driving gear catching into a wheel, by which the extracting pan is revolved.

Extracting the Gelatine. First Operation. The bones are brought in contact with lime in order to free them from all fleshy parts. They are then thrown into the box *d*, to extract the fat, which is done by boiling them by the introduction of steam through the pipes *b* and *c* into the serpentine pipe *l*. The fat swimming on the top is skimmed off. The bones are then taken from *d* and

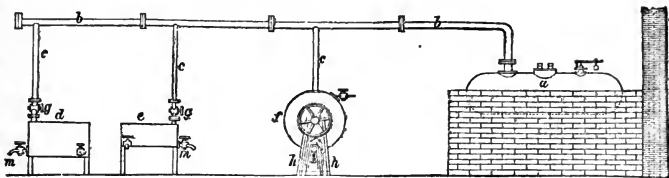

Fig. 21.

view of the apparatus, and Fig. 22 the ground-plan; *a* is the steam-boiler; *b* a pipe conducting the steam to all parts

placed in the extracting vessel *f*, which is carefully luted, and steam at a pressure of $\frac{2}{3}$ atmosphere then introduced.

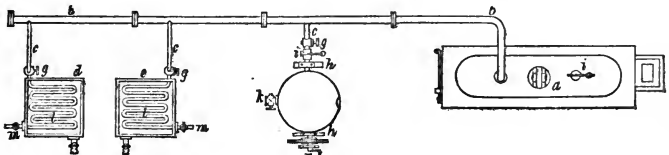

Fig. 22.

of the apparatus; *c* pipes conducting the steam to the box *d*, serving for extracting the fat from the bones, then to the evaporating pan *e*, and finally to the extracting pan; *f, g* are cocks for regulating the introduction of steam; *h* a pedestal upon which the extracting pan can be revolved; *i* are valves for the escape of steam; *k* cocks through which the steam leaves the extracting vessel; another cock is placed beneath the extracting vessel, through which the liquid gelatine is drawn off; *l* are serpentine pipes through which steam passes to bring the fluids in the box *d*

After exposing the bones to the action of the steam for 2 hours the gelatine is drawn off through the cock on the bottom of the extracting pan, and after filtering, is brought into the evaporating pan *e*.

Second Operation. Some of the fluid in the box *d* is brought into the extracting pan *f*, steam is again introduced, and after 3 hours the gelatine is drawn off, filtered, and added to the first.

Third Operation. All the gelatine obtained having been brought into the evaporating pan *e*, it is evaporated to the proper consistency and then treated in the same manner as glue.

To Make Gelatine from Glue. Soak 5 pounds of good glue for 2 days in $1\frac{1}{2}$ gallons of strong vinegar, with 1 ounce of which saturate 40 to 45 grains of potassium carbonate. Then pour off the vinegar and place the glue in a sieve suspended in a vat of cold water, and allow it to remain 12 hours to remove the acetates adhering to the glue, which is now clear as glass, with a yellow tint. Glue thus prepared gives, when poured upon glass plates, white sheets of gelatine. They are somewhat more brittle than those obtained from bone glue, but this difficulty is overcome by adding more or less glycerine, according to the season of the year. In this manner gelatine can be produced which binds better than that obtained from bones, and at less cost.

Liquid Steam Glue. The Russian steam glue is prepared in the following manner: Soak 100 pounds of good glue in 12 to 14 gallons of water, and add 5 to 6 pounds of aqua-fortis. The peculiar white color of Russian glue is produced by mixing 6 pounds of finely-powdered sulphate of lead with the solution.

Heller's Steam Glue consists of 100 parts of good glue, 200 of water, and 12 of aqua-fortis.

Cold Liquid Glue. Dilute 2 to $2\frac{1}{2}$ parts of crude nitric acid with 40 to 50 of water. Soak in this 25 parts of glue for 24 hours and then heat the mixture until it is homogeneous. The quantity of acid used depends on the quality of the glue. All other receipts have given unsatisfactory results.

To Prepare Excellent Glue which will hold in Water. Powder and dissolve 1 part of glue in 1 of thick linseed-oil varnish boiling hot, and mix thoroughly. In using it heat the 2 planed sides of the wood, apply the glue warm, and press the pieces together.

Good Furniture Glue. Boil the desired quantity of glue with water. When sufficiently boiled pour it into a porcelain dish and rub with a pestle into a thick paste free from lumps. Then pour it into an earthen-ware dish, let it cool, and cut it into pieces of desired size. When it is to be used dissolve 2 parts of the prepared glue in 1 of ordinary whiskey diluted with 2 of water, and let it boil up once. The glue is now ready for use and can be kept for

some time. It possesses extraordinary adhesive power.

Glue for Books. Dissolve over a moderate fire 12 parts of glue in 8 of water, add 8 parts of shavings of white soap, and, when all are dissolved, 6 of powdered alum, stirring the mass constantly. The sheets of paper may be either dipped into this fluid or it is applied with a sponge.

Glue Resisting Wet and Moisture. Soak any desired quantity of glue in clean water for 11 hours, then pour the water off and stir the glue into a paste. On the other hand, take $\frac{1}{4}$ part of the glue used of isinglass, cut it in small pieces, soak for 12 hours in ordinary whiskey, and then rub it into a paste. Place an earthen pot on the fire and put in gradually portions of the glue and of the isinglass; stir constantly, add a few drops of linseed-oil varnish, strain through a clean cloth, and put the glue in bottles for future use.

New Liquid Glue. This glue, which can be used for joining together all imaginable articles, even porcelain, glass, mother-of-pearl, etc., is prepared as follows: Pour 8 parts of water over 3 of glue cut in small pieces, and let it stand for a few hours. Then add $\frac{1}{2}$ part of hydrochloric acid gas and $\frac{2}{3}$ part of sulphate of zinc, and expose the mixture to a temperature of 175° to 190° F. for 10 to 12 hours. The glue does not again congeal, and if necessary can be still further clarified by allowing it to settle and then filtering.

Bone Glue is manufactured from bones comminuted to the size of peas, or from waste in the manufacture of bone flour. The material is first moistened with a solution of oxalic acid in water, then piled in heaps and left to itself, whereby spontaneous heating takes place. It is then steamed in a glue boiler, the manhole being left open during the process. When the ammoniacal combinations have been expelled the material is subjected to a pressure of 2 to 3 atmospheres, and boiling water pumped in from time to time in order to completely dissolve the gelatine. The concentrated solution of glue, containing from 25 to 30 per cent. of dry substance, is finally pressed into a wooden vat, where it can be further concentrated, if necessary, by heating a

steam-pipe. The whole process requires from 5 to 6 hours.

Dupasquier's Process of Preparing Bone Glue as a Substitute for Isinglass. Selecting and Bleaching the Bones. Remove all decayed and spongy parts of the bones and boil the sound portions for 1 hour to remove the fleshy and foreign substances. Potash lye is added near the end of the boiling to effectually clean the bones of fat. This lye consists of 1 pound each of potash and lime to every 100 pounds of bones. After remaining in the lye for 2 hours the bones are placed in baskets and set in running water to wash off the potash and foreign substances.

Comminuting the Bones. Remove the bones from the baskets, dry, and grind them in a power mill. The mill used by the inventor is 6½ feet in diameter and driven by horse-power, a strong horse being able to crush 150 pounds of bones to the size of beans in an hour. But it is better to grind the bones in an ordinary flour-mill, as the smaller the particles are the better the acid acts upon them.

Immersing the Comminuted Bones in Hydrochloric Acid. The bone-dust is divided into 2 parts by sifting in a cylinder sieve. One part will be impalpable powder, while the other will be about as coarse as snuff. The reason for this division of the bone flour is that experience has taught that less acid is required for the fine powder than for the coarse. The following are the proportions: For every 100 parts of fine powder take 25 of hydrochloric acid and 75 of water; for 100 parts of coarse powder 50 of hydrochloric acid and 75 of water. The process is as follows: Pour the mentioned proportion of water over the bone flour in a large vat of white wood, and stir with a wooden shovel until every particle of flour is thoroughly moistened. Let it stand for 1 hour, then add $\frac{1}{4}$ of the mentioned proportion of acid, and, in intervals of 1 hour, the other $\frac{3}{4}$. Let the acid act for 12 hours, stirring the mixture every hour with wooden shovels. Then draw off the liquor which contains hydrochlorate of lime, free phosphoric acid, and a certain quantity of free hydrochloric acid. The residue is filled into bags of a loose material and placed in running

water for 24 hours. The bags are then shaken in running water until, on taking a sample from the bag and placing it upon the tongue, no acid or any other taste is perceived. The bone-dust is now brought into a boiler with a hermetically fitting cover and 200 parts of water added to every 150 parts of bone flour weighed before immersion. The

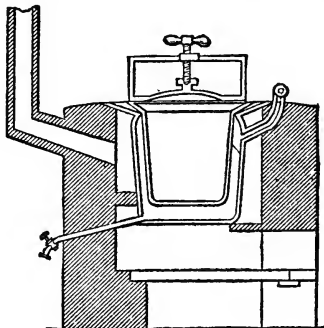

Fig. 23.

whole is now boiled until all gelatine is entirely dissolved, which may be recognized by the sediment on the bottom becoming pasty and containing no particles offering resistance to pressure with the finger. Fig. 23 represents the

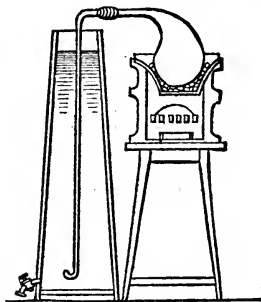

Fig. 24.

form of boiler used for the operation. The liquor is then drawn off and filtered through a bag, the residue pressed out,

and the liquor obtained thereby added to the first.

Bleaching. Pour the liquor into a tall barrel (Fig. 24) and introduce a very vigorous current of sulphurous gas produced by decomposing sulphuric acid by charcoal. By the action of this acid the dark color of the liquor is converted into a bluish-white resembling that of a solution of good isinglass. Let the liquor settle and then draw it off through a faucet placed 3 inches above the bottom of the barrel.

Pouring the Gelatine into Moulds. The liquor is carried in wooden buckets to another room where the moulds are arranged. They are made of white pine, are 5½ feet long and 1½ feet wide, and stand in a horizontal position alongside each other upon a wooden frame. Around the edge they are provided with a rim 1½ inches high. They are painted with a coat of drying oil and white lead. The liquor is poured ½ inch deep in them. A gelatine of firm consistency is soon formed, which is lifted out with wooden knives and laid upon loosely-woven cloths stretched out in a room through which a strong current of air passes. It remains here for 6 to 10 days, when it is sufficiently dry to be packed.

Isinglass (Fish Glue). Genuine isinglass is yellowish-white or grayish-yellow to brown, transparent, very tough and flexible, can be easily torn only in the direction of the grain, has no taste or odor, and when chewed it becomes sticky. A solution of 1 part of isinglass in 50 of warm water is colorless and cools to a jelly. It consists of:

Animal glue	70	per cent.
Osmazome	16	"
Water	7.5	"
Insoluble particles of skin	2.5	"
Acid and salts of soda, potash, and lime	4	"
	100	"

It is principally manufactured in Russia from the bladders of the sturgeon and other fishes belonging to the same family. The bladders, after being placed in hot water, are cut open, washed, and exposed to the air with the inner, silvery skin upward. This is then removed by rubbing, placed in moistened cloths, pressed, and then

taken from the cloth and laid either in serpentine windings between 3 small blocks or placed together in sheets like a book and dried.

Printers' Rollers from Glue and Glycerine. Let good cabinet-makers' glue stand with water until a jelly has been formed, heat this in a water-bath, and, when melted, add as much glycerine as glue, stir, and then heat carefully until the water is evaporated. The product is an elastic substance well adapted for printers' rollers, moulds for galvanoplastic purposes, etc.

Another process is as follows: Clean waste of skins by soaking in water for several days, then cut them in small pieces and cover them with glycerine. Boil the whole for some time at 212° to 235° F. When all the waste is dissolved pour the solution into another vessel, and, when cold, pour into moulds.

Birdlime is a thick, soft, tough, and sticky mass of a greenish color, has an unpleasant smell and bitter taste, melts easily on heating, and hardens when exposed in thin layers to the air. It is difficult to dissolve in spirit of wine, but easily in hot alcohol, oil of turpentine, and fat oils, and also somewhat in vinegar. The best quality is prepared from the inner green bark of the holly (*Ilex aquifolium*), which is boiled, then put in barrels, and submitted for 14 days to slight fermentation until it becomes sticky. Another process of preparing it is to mix the boiled bark with juice of mistletoe berries and burying it in the ground until fermented. The bark is then pulverized, boiled, and washed. Artificial birdlime is prepared by boiling and then igniting linseed oil, or boiling printing varnish until it is very tough and sticky. It is further prepared by dissolving cabinet-makers' glue in water and adding a concentrated solution of chloride of zinc. The mixture is very sticky, does not dry on exposure to the air, and has the advantage that it can be easily washed off the feathers of the birds.

The following mixtures give a good fly glue:

I. Melt together 6 parts of colophony, 4 of rapeseed oil, and 3 of rosin.

II. Eight parts of rosin, 4 each of turpentine and rapeseed oil, and ¼ of honey.

III. Boil to a thick paste 1 pound of rosin and $3\frac{1}{2}$ ounces each of molasses and linseed oil. Apply either of the above mixtures to a thick stick and plant it in a pot filled with sand.

HOUSEHOLD AND RURAL ECONOMY.

How to Construct a Table Fountain.
To a glass tube about 2 feet long is fused a glass funnel capable of holding about $\frac{1}{2}$ cubic inch of fluid. The lower end of the tube passes through a perforated cork into a wide-necked bottle about 4 inches high. A glass tube a few inches long and running somewhat to a point (Fig. 25) is inserted in a perforated cork in another neck of the same bottle.

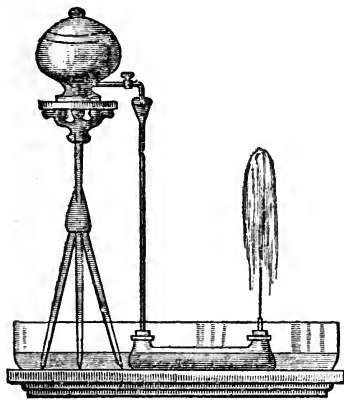

Fig. 25.

Sufficient water to entirely fill the bottle is now poured through the funnel tube, this being also filled up to the rim of the funnel, while the aperture of the short tube is closed by placing a finger over it. As soon as the finger is removed a jet of water will spurt from the small tube, a constant supply being kept up from an urn or basin provided with a cock and standing over the funnel. By a suitable arrangement of flowers upon the table it is easy to conceal the bottle as well as the funnel tube and water urn.

Pine Leaves or "Needles" may be

made a very suitable substitute for hair, feathers, etc., for upholstery purposes, by boiling them with lime, soda, potash, or similar chemicals until reduced to a fibrous state. One of the advantages claimed for this material is that it is an effectual repellent of moths, bed-bugs, fleas, and other insect pests.

To Keep Milk from Souring, and to retard the separation of cream, add a small quantity of boracic acid to it. By this means it can be kept for several days.

Moss for Artificial Flowers and Fruits is prepared from bread crumbs, magnesia, and finely-powdered starch, which, as soon as it is fermented, can be formed and colored to any desired pattern.

Indigo-carmin, saffron, or the various lakes are used as coloring substances, and as a varnish a solution of gamboge in alcohol.

Simple Process for Preparing Potato Flour. Boil the potatoes and then allow them to freeze, which will facilitate the pressing out of the water and drying of the substance of the potato.

Roasted Malt as a Substitute for Coffee. Mix 2 parts of ground malt, 1 of ground coffee, and 1 of chicory; or use equal parts of coffee and chicory or malt. When boiled in water, or steeped in boiling water, these mixtures furnish a nourishing beverage of agreeable taste and flavor.

Lemonade Powder. Rub together 1 drachm of tartaric acid and $1\frac{1}{2}$ ounces of sugar with 3 drops of oil of lemon. Lemonade prepared with this powder is refreshing, cooling, and wholesome.

II. Mix $1\frac{1}{2}$ pounds of sugar, 5 ounces of oil of lemon, and $\frac{1}{2}$ ounce of crystallized tartaric acid. Preserve the powder in glass bottles hermetically closed.

Champagne Powder. To convert any wine, at a moment's notice, into champagne, take 30 grains of dry, pulverized bicarbonate of sodium, 23 grains of dry, powdered tartaric acid, and 2 ounces of pulverized sugar. Put the powder into a strong champagne bottle containing the wine and cork immediately. Then turn the bottle up and the champagne will be ready in one minute.

Champagne Mixture. Add to 5 quarts of must wine 1 pound of white sugar, and a little alcohol. One glass of this

mixture will convert any young wine into champagne.

Currant Champagne. Boil pure currant juice to the consistency of syrup and preserve in well-corked bottles. When to be used add a cupful of this syrup to $\frac{1}{2}$ gallon of French wine and stir the mixture thoroughly.

English Champagne. To 10 pounds of gooseberry juice add 5 quarts of water and allow it to stand for 3 days; then press out and add 3 pounds of sugar and let it stand for 5 or 6 weeks, with occasional skimming, and add a small quantity of brandy and fill into bottles.

Fruit Champagne. Peel and grate juicy pears and press out the juice, which pour into a cask and cover the bung-hole with a linen cloth, and let the cask stand in a moderately warm room. Fermentation will begin in a few days, when the scum must be carefully removed. When the scum ceases, fill the cask with clear fermented pear juice (which has been fermented in a closely-corked bottle) and allow the cask to rest for 5 or 6 weeks in a cellar. Put a faucet in the cask about 4 inches above the chime, and draw the wine off into bottles and secure their corks with wire covered with pitch or wax. In about 2 weeks the wine will be fit for use, closely resembling champagne. It improves with age.

FRUIT WINES. *Apple Wine (Cider).*
English Process. Store the apples for 10 to 14 days in an open shed and carefully reject the rotten ones. Then macerate the sound apples, enclose the pulp in a hair cloth, and place under a press, from which the juice is conveyed into barrels. If the apples are pressed without the hair cloth the bung-holes of the barrels must be covered with a brick until spring. The juice is then racked off into other barrels and $\frac{1}{2}$ pound of hops and some burnt sugar are added and the bung-holes closed. The wine will not be fit to drink before a year.

Apple Wine (Normandy Process). The apples are crushed and pressed in the usual manner and the juice conveyed into barrels; but instead of allowing fermentation to take its course the juice, as soon as fermentation has commenced, is poured into other barrels, and again into others as soon as fer-

mentation recommences. This is generally done 3 times.

The scum and precipitation of the 3 fermentations are then placed in woollen bags and suspended over a vat. The very clear apple wine draining from them is added to the rest. This wine has a very agreeable taste and can be kept for a long time.

Apple Champagne (Champagne Cider). To a champagne bottle full of apple wine take 2 to 3 ounces of sugar, dissolve it in the wine, add as quickly as possible $\frac{3}{4}$ ounce of finely-powdered tartaric acid and 1 drachm of finely-powdered bicarbonate of sodium, cork the bottle, secure the cork with wire, and let it lie for 8 days, when the champagne cider is ready for use.

Birch Wine. Bore holes in birch trees in the spring before the leaves appear and insert tubes to drain off the sap or juice. Branches of elder bush are often used for tubes. Large trees can be tapped in several places without injury. If a sufficient quantity of juice is not obtained in 1 day, it should be kept in bottles hermetically closed by covering the cork with wax or pitch.

Boil the juice, after a sufficient quantity has been collected, and carefully remove the scum as it arises. Then add 4 pounds of sugar and the rind of 1 lemon to every gallon of juice, and boil for $\frac{1}{2}$ hour longer, carefully removing the scum. When cold the juice is fermented by adding yeast spread upon toasted bread, and is then allowed to stand for 5 to 6 days, being stirred occasionally. Now take a clean barrel holding exactly the quantity of wine prepared, suspend in it a piece of ignited sulphur, close the bung until the sulphur is extinguished, and then bring the wine into the barrel. As long as fermentation continues the bung is placed loosely in the bung-hole. When fermentation ceases the bung is driven in tight and the barrel allowed to lie for 3 months, when the wine is drawn into bottles.

Blackberry Wine. Cover ripe blackberries with boiling water in an earthen or wooden vessel and, when cool enough to admit the hand, crush the blackberries; cover the vessel and allow it to stand until the berries are forced to the top, requiring generally 2 or 3 days.

The clear juice is then drawn off into a similar vessel and 1 pound of sugar added to every 3 gallons of fluid, when the whole is thoroughly stirred together and allowed to stand for 8 to 10 days. The wine is then filtered through a bag into a capacious vessel. The next morning 4 ounces of isinglass, previously soaked for 12 hours, are slowly boiled in 1 pint of white wine. When all is dissolved the above quantity is added to every gallon of the wine, the whole allowed to boil up once, and then poured into a cask.

Cherry Wine. Free perfectly ripe cherries from the stems, crush, and press them through a hair sieve. Then add to every gallon of juice 2 pounds of sugar and place it in a vessel just large enough to be entirely filled with it. When fermentation has run its course and no noise can be detected in the barrel, drive in the bung and allow the barrel to lay for 3 months, and then fill the wine into bottles.

Currant Wine. To every gallon of currant juice add 1 pound of sugar. When the sugar is dissolved put the juice in a cask, which should be entirely filled with it. Put this in a cellar until fermentation has run its course, then fill it up with juice previously fermented and close the bung-hole. The wine remains in this barrel for 6 months, when it is drawn off into another barrel or into bottles.

Another Receipt. A beverage resembling Madeira wine is obtained by using equal parts of gooseberry and currant juice, dissolving in it 1 pound of sugar for every gallon of juice, and allowing the whole to ferment. The clear wine is then drawn off into another barrel and 1 pint of French brandy added to every gallon of it, when the bung-hole is closed as tight as possible and the barrel allowed to lie in a cellar for 5 to 6 months, when the wine is drawn off into bottles.

Damson Wine. Ten pounds of damsons, when quite ripe, are crushed and boiled in $1\frac{1}{2}$ gallons of water. Then press out the juice, add 3 pounds of sugar, let it ferment in a barrel, and add, after a fortnight, a little good brandy to it, when it will be fit to fill in bottles.

Elderberry Wine. Remove the stems

from 100 pounds of elderberries, crush and boil them; then add 50 pounds of sugar, 2 pounds of cream of tartar, and 35 gallons of water, and let the mixture ferment. By adding a little ginger, cloves, raisins, and yeast, it will yield at the termination of the fermentation a wine similar to Cyprus wine.

Ginger Wine. Add 20 pounds of sugar to 12 gallons of water and boil to a syrup. Then boil in a separate vessel 1 pound of white Jamaica ginger in $2\frac{1}{2}$ gallons of water and add, while boiling, a few lemon peels. Then mix both liquids, add a little yeast and 4 pounds of seeded raisins. Let it ferment for several weeks, and then add 1 pound of tartaric acid and 2 gallons of elderberry juice.

Honey Wine. To 2 pounds of honey add 1 gallon of water. Boil the mixture for 1 hour, continually skimming it; then add some yeast and let the liquid ferment, hanging into the barrel a bag containing bruised spices, such as coriander seeds, cloves, ginger, and calamus, of each 1 ounce. The fermented liquor will be clear after 1 month, when it can be drawn into bottles.

Orange Wine. Boil 40 pounds of sugar for $\frac{1}{4}$ hour with $13\frac{1}{2}$ gallons of water. At the same time press out and filter the juice of 75 oranges and mix it, together with the rinds, with the sugary fluid after the latter has been cooled off to about 85° F. The mixture is then poured into a cask and frequently stirred during 3 or 4 days, when the cask is bunged and placed in a cellar for 6 months, when the wine is drawn off.

Orange Wine with Lemon. Dissolve $6\frac{1}{2}$ pounds of sugar in $1\frac{1}{2}$ gallons of water at a temperature about 105° F. Add to this the juice of 5 good lemons and 3 table-spoonfuls of beer yeast, and let the mixture ferment for 48 hours. In the meanwhile grate the rinds of the lemons and those of 25 oranges upon 1 pound of loaf sugar, add this to the fermenting liquid and immediately afterwards the juice of the 25 oranges, and then let the whole ferment for 48 hours longer. Then pour the fluid into a cask, add 1 pint of wine, bung the cask, and let it lie for 6 months, when the wine can be drawn off into bottles.

Raisin Wine. To $6\frac{1}{2}$ pounds of

raisins add 20 pounds of water, 2 pounds of sugar, 8½ ounces of cream of tartar, and sufficient yeast to bring the mass into fermentation. If the wine is to be consumed at once it is not necessary to add yeast.

Another Receipt. Pour 30 gallons of ordinary wine over 20 pounds of raisins previously picked over, freed from stems and stoned, and stir the mass thoroughly. Next prepare a solution of 8½ pounds of fine loaf sugar in 1 gallon of water by boiling, and when this is cold add it to the raisins and wine; then add a saturated solution of ¼ ounce of bicarbonate of potassium and immediately afterwards a solution of ¼ ounce of tartaric acid in a little water. Bung the cask loosely, shake it thoroughly, place it in a moderately warm place, and then remove the bung. After 4 weeks add 4½ pounds of loaf sugar and a like quantity after 6 weeks. Fermentation will cease in 8 to 10 weeks. The wine can then be fined with gelatine, isinglass, or white of egg, and drawn off into bottles. It has an agreeable taste resembling very much that of Spanish wine.

Raspberry Wine. Crush the berries with a spoon and filter the juice through flannel into an earthen pot. To each quart of the juice add 1 pound of fine sugar, stir the mass thoroughly, and let it stand for 3 days. Then pour off the clear fluid, add to every quart of juice 2½ gallons of white wine, and fill the liquor in bottles. The wine can be used in 6 to 8 days.

Remedy for Warts. Mix 1 part of carbonate of potassium, 1 of burned lime, and 2 of soap. Stir the mixture into a thick paste with a sufficient quantity of spirit of wine, and apply this to the warts. This should be done very carefully, so that the caustic mass does not touch the healthy skin of the hand.

Remedy for Chilblains. Apply tannin, which will adhere to the respective parts of the body by gently breathing upon the skin. This is an excellent remedy, frequently preventing the appearance of chilblains if used in time, and does not disturb the transpiration of the hand.

Remedy for Corns. Mix ¾ drachm of salicylic acid, 8 grains of extract of Indian hemp, and ¾ ounce of collodion.

Apply once a day to the hard skin by means of a small brush. The skin contracts to a horn-like crust and becomes detached from the parts underneath it, so that it can be easily removed without the slightest pain.

Ginger Beer. To 3 gallons of water add 4½ ounces of bruised ginger root, 2 ounces of cream of tartar, and 4½ pounds of sugar. Boil for a few minutes, and after cooling add about 1 table-spoonful of fresh yeast. Cover up the vessel with a thick flannel cloth and let it stand over night. Then add a little essence of lemon, strain it, put the fluid in clean bottles, and secure the corks with twine or wire. The beer will be fit to drink after standing 4 days.

English Ginger Beer. Boil 3 ounces of pulverized ginger, 2 ounces of cream of tartar, and 2 pounds of sugar with 1½ gallons of water. When cold add a table-spoonful of yeast to the fluid, let it stand over night, then filter, and draw into bottles which should be well corked.

Spruce Beer. Put into a common soda bottle about 30 grains of bicarbonate of sodium, 10 drops of essence of spruce, and about 30 grains of crystallized tartaric acid. Fill the bottle quickly with spring water, cork, and secure the cork with twine or wire.

Another Receipt. Commintute the young sprouts of the spruce tree, then boil them with water until they turn yellow and the bark peels off easily. Add some toasted bread and malt, let the fluid ferment in the ordinary manner, and bottle. The proportions of the materials used are as follows: Ten gallons of water, 1½ quarts of young spruce sprouts, ¼ pint of syrup (or, instead of the syrup, 1 pint of malt or ¾ pint of carrots), and some toasted bread and yeast.

English Spruce Beer. Commintute the young spruce sprouts, press out the juice, and boil it down to the consistency of syrup. Put the syrup in well-closed bottles, where in the course of time it will lose all taste of resin. When it is to be used dilute the necessary quantity with water and ferment with yeast.

Root Beer is prepared by boiling various roots, such as sarsaparilla, comfrey, licorice root, and sassafras

blossoms and bark, in the same manner as given for ginger beer. Then add 1 pound of sugar to every gallon of the decoction, and when the sugar is dissolved add 1 table-spoonful of yeast to the same quantity of liquid, let it ferment over night, and the following day the beer will be fit for drinking.

To Prepare Fly Paper. Thoroughly saturate stout unsized paper with a solution of 1 part of arseniate of potassium or arseniate of sodium and 2 of white sugar in 20 parts of water, and then dry it. When the paper is to be used moisten it with some water and place it in saucers. It is advisable to be very careful with this paper as it is poisonous.

Fly Paper Free from Poison. Pour $\frac{1}{2}$ gallon of water over 1 pound of quassia wood and let it stand over night, then boil the strained fluid down to 1 quart. The wood is again boiled with 1 quart of water until 1 pint remains, when the 2 infusions are mixed together and $\frac{1}{2}$ to $\frac{3}{4}$ pound of sugar dissolved in it. Pass the paper through this fluid, let it drain off, and hang it up to dry. Red blotting-paper is generally used.

Persian Insect Powder is prepared from the leaves and blossoms of *Pyrethrum caucasicum*. An alcoholic extract can also be prepared by digesting 2 parts of the powder with 12 of spirit of wine for 8 days and then pressing and filtering.

To Destroy Insects and Worms Infesting Wall Paper, etc. Mix 2 pounds of starch paste with 1 ounce of finely-pulverized colocynt.

To Preserve Animal Skins. Wicke recommends to pulverize sulphate of copper as finely as possible and to stir the powder into a paste with water. The flesh side of the skin is brushed with this as quickly as possible, in order to prevent evaporation of the water. The paste permeates the skins in a short time, securing them against all attacks by insects.

According to another receipt 1 part of sulphate of copper is mixed with 2 of alum. This mixture forms insoluble combinations with the organic tissues.

To Preserve Stuffed Animals. Mix 2 parts of air-slaked lime, sifted through a fine sieve, and 1 part of sifted tobacco

ashes, with $\frac{1}{2}$ part of alum. Rub the mixture thoroughly into the flesh side of the skins to be stuffed.

Another Receipt. Pulverize and mix 1 ounce of sal-ammoniac, $\frac{1}{2}$ ounce of burned alum, $3\frac{1}{2}$ ounces of tobacco ashes, and 25 ounces of aloes, and proceed as above.

Another Receipt. Pulverize and mix thoroughly 1 part of cobalt and 2 of alum, and rub the mixture thoroughly into the flesh side of the skin previously brushed with pine oil.

The following receipts are principally used for skins of mammalia:

I. Boil $\frac{1}{2}$ part of alum and $\frac{1}{4}$ part of pulverized cobalt in 4 parts of water; strain the fluid and brush it over both sides of the skin.

II. Dissolve $\frac{1}{4}$ part of tar formed from the grease on the iron axle of a wagon in 1 part of strong soap-boilers lye, and coat the flesh side of the skin uniformly with the resulting thick paste.

To Destroy Insects Infesting Herbaria, and Collections of Insects. Weiss recommends a solution of corrosive sublimate in sulphuric ether.

To Protect Woollen Goods and Furs. Fumigation with sal-ammoniac and also laying stems of wormwood and blooming hearts clover between the articles have been proposed as excellent remedies for destroying moths. Dusting the articles with pulverized sulphate of iron is said to be good for keeping away moths.

Formerly a mixture was used consisting of 4 parts of oil of lavender, 4 of ethereal oil of wormwood, and 1 of oil of turpentine, well shaken together. Strips of blotting-paper were soaked in the mixture and placed in the pockets or seams of the clothes.

Hager recommends the following mixtures:

I. *For Cloth.* One and a half fluid ounces of pure carbolic acid, 2 fluid drachms each of oil of cloves, lemon peel, and nitro-benzole, dissolved in $\frac{1}{2}$ gallon of spirit of wine.

II. *For Furs.* Six fluid drachms of pure carbolic acid, 3 fluid drachms each of oil of cloves, lemon peel, and nitro-benzole, dissolved in 1 quart of spirit of wine.

The articles are moderately sprinkled with the fluid. One sprinkling will

suffice for the summer, provided they are stored in closed boxes or closets, but cloth in storerooms will require to be sprinkled twice.

Other Receipts for Destroying Moths.

I. Soak blotting-paper in a mixture of equal parts of oil of camphor and spirits of turpentine, and lay the paper among the clothing or furs.

II. Use a mixture of alum, cayenne pepper, oil of camphor, and calcined plaster of Paris.

For the Destruction of Bedbugs and other Insects. According to *Hirzel*, watery sulphurous acid is an excellent agent for destroying bedbugs and their eggs, as well as other noxious insects. It is sufficient to sprinkle a few drops of the acid upon the places or into the joints and holes infested by the insects, and to repeat this several times.

Wild thyme is also an infallible means of destroying bedbugs. Lay it in the beds and corners of the room, and then close the doors and windows. It is advisable to heat the room in winter. In 48 hours all traces of bedbugs will have disappeared.

For the Destruction of Fleas on Dogs, Horses, and Cattle. Take equal parts of beef gall, oil of camphor, oil of pennyroyal, extract of gentian, and spirits of wine.

To Destroy Cockroaches. Mix equal parts of Persian insect powder and powdered Levant wormseed, and scatter the mixture about the places which the cockroaches frequent.

To Destroy Mosquitoes and Gnats. A solution of beef's gall in spirits of camphor and spirits of turpentine does excellent service.

To Drive away Ants from Closets, Pantries, etc. Chalk the shelves upon which the provisions are put; or apply moistened fly paper, and lay about the pantry; or soak bread crumbs in tincture of quassia, and lay them about the closet.

Rats will be completely driven away from any building by smearing the rat holes which are found near the walls, in the cellar, with tar. In 24 hours there will not be found a rat about the house; nor will they return while fresh supplies of tar are kept about the holes.

Phosphorus Paste for Destroying Rats and Mice. Melt 8 ounces of phos-

phorus in 1 gallon of hot water and add 10 pounds of corn meal; then rub up gradually and add 10 pounds of butter and 5 pounds of sugar.

To Destroy Field Rats and Mice. Take equal parts of burnt lime, powdered cicuta, calcined plaster of Paris, powdered hellebore, and oil of aniseed. Mix and form into small pills, and scatter them about the places the mice and rats frequent.

London Purple for the Destruction of Insects. London purple, which is a waste product of the fabrication of rosaniline, comes into commerce as a fine powder of a violet color. It is soluble in water, and is composed of:

Rosaniline	12.46 per cent.
Arsenious acid	43.65 "
Calcium oxide	21.82 "
Impurities	14.57 "
Ferric oxide	1.16 "
Water	2.27 "
Loss	4.07 "

Prof. C. V. Riley, of Washington, recommends this substance as a means of destroying insects, especially the potato bug, army worm, cotton worm, locusts, and caterpillar. It has the advantage of being cheaper than Paris green, which has been almost exclusively used thus far, and of being easily detected by its peculiar color, while Paris green cannot be detected upon plants, this having frequently caused poisoning. It is claimed that, if sufficiently diluted, it is entirely harmless if applied to vegetables.* Eight ounces of the London purple are sufficient for about 50 gallons of water. The retail price per pound may be given as from 8 to 12 cents.

Hager's Universal Composition for the Destruction of Vermin is prepared as follows: Pulverize and mix 100 parts of *Sumatra benzoin*, 50 of aloes, and 25 of an inferior quality of salicylic acid; then pour over the powder 50 parts of inferior oil of lavender (from *Lavandula spica*), 10 of badian-seed oil, and 1000 of spirit of wine, and let the whole stand for 1 day, stirring it frequently. Then add 100 parts of oleic acid and a solution of 60 parts of

* We are inclined to doubt this claim for a substance containing 43.65 per cent. of arsenious acid. W. T. B.

crude caustic soda and 25 of borax in 500 of water. Allow the whole to stand again for 1 day, stirring frequently, and then add 3000 parts of crude carbohc acid of 90 to 95 per cent.; place the composition in a cool place for 1 week and then pour off the clear, supernatant fluid. It should be carefully handled, and its spurting into the eyes or upon the lips must be especially avoided. *This direction, when prepared for sale, should be printed upon the label.* This composition, strongly diluted with water, is principally used for cattle. For young animals dilute it with 120 times its volume of water, and for older with 100 times. This is best done by pouring some of the composition into a capacious flask, then adding twice the volume of water, and shaking vigorously. Then pour the strongly foaming liquid into a barrel or boiler and then add water sufficient to dilute 100 times, stirring constantly. In using, stir it frequently and apply it with a brush to the skin and other infected parts of the animal, rubbing it thoroughly in. Avoid as much as possible spurting the fluid into the eyes, anus, and sexual parts. To destroy the eggs of the insects repeat the operation the third day. Animals with white hair must the next day be washed with warm water. The following are the principal advantages of this composition: 1. It is the best and safest means of destroying the eggs of vermin infesting animals, while it is entirely innoxious. 2. It is the best and simplest remedy for mange in dogs and scab in sheep and cattle. For horses and cattle dilute the composition with 30 times its volume of water, for sheep with 40 times, and for dogs 50 times its volume. Apply twice daily, forenoon and afternoon, to the places infected with scab or mange, and rub in with a brush. If the odor of the composition does not occasion any inconvenience it is also, diluted with 30 times its volume of water, an excellent remedy for itch in the human being. Apply it once daily to the infected parts. 3. For wounds, especially for those emitting a bad smell, dip linen, cotton, or lint into the composition diluted with 100 times its quantity of water. For deep wounds inject the fluid. 4. To protect animals from flies

and other annoying insects, moisten the skin moderately with the composition, strongly diluted, repeating the operation once or twice daily, if necessary. 5. The universal composition may be used everywhere where the vitality of insects or cryptogamous plants is to be destroyed. Seed corn is kept sound and protected from birds, mice, snails, etc., by soaking it, half an hour before sowing, in the composition diluted with 40 times its volume of water, taking it out of the fluid with a sieve, and allowing it to dry in the air.

For the Destruction of Phylloxera (Vine Grub, Vine Fretter), Armand Boyreau, of La Rochelle, France, recommends the following composition, for which he has obtained a patent in France and Germany: Mix 30 pounds of sodium phosphate, 10 pounds of ammonium phosphate, 40 pounds of sal-ammoniac, 30 pounds of potassium sulphate, 50 pounds of soda, 60 pounds of flowers of sulphur, and 1900 pounds of sulphate of iron. The composition is mixed with the soil.

Papasogli applies a mixture of 30 parts of nitrobenzole, 50 of sulphuric acid, and 900 of water to the roots of the vine. To kill the eggs on the trunk he uses a paste prepared from $\frac{1}{2}$ ounce of nitrobenzole, 2 pounds of lime, and 89 pounds of earth. This mixture adheres tightly to the trunk and is not washed off by long-continued rain, the odor of the nitrobenzole remaining for a long time.

Simple Disinfectant. Pulverize 1 pound of fresh sulphate of iron of a yellowish-green color and mix it with 1 pound of plaster of Paris; bring the mixture into a vessel and pour over it, constantly stirring, 1 gallon of rain water heated to the boiling point. After stirring the mixture for 2 minutes pour it down the privy well or over the place to be disinfected. In the meanwhile place in another vessel $\frac{1}{2}$ gallon of rain water, $\frac{3}{4}$ pint of petroleum, and $\frac{1}{2}$ pint of soda water-glass, and bring the mixture to the boiling point. Then stir it for 2 minutes and pour it after the first mixture.

Disinfecting Powder of Max Friedrich consists, according to an analysis made in the laboratory of the *Chemischer Zeitung*, of:

Sand and silica	4.30	per cent.
Ferric oxide and alumina	1.60	"
Plaster of Paris	48.13	"
Calcium hydrate	32.65	"
Chlorine	0.82	"
Magnesia	traces.	"
Alkalies and carbonic acid	0.62	"
Extract of ether	3.16	"
Naphthaline, carbolic acid, and moisture	7.72	"
	<hr/>	
	100.00	"

Efficacious Disinfectants. Sulphate of aluminium and hydrochlorate of aluminium are very powerful disinfectants and antiseptics. Their solubility and harmlessness render their use admissible under all circumstances. The chloride and sulphate of iron have the same action as the above, and, further, they absorb the sulphuretted products of decomposition. For this reason these salts are the most efficacious of disinfectants. But there is one objection to their use, namely, that the iron would injure any vegetation with which the disinfected matter might come in contact. The best disinfectant for general use is a solution containing hydrochlorate of aluminium with a small quantity of chloride of iron. The hydrochlorate will do all the work of a disinfectant and antiseptic, while the chloride will absorb the sulphuretted compounds.

To Cleanse Lacquered and Stained Articles of Wood use a lye prepared from 3 parts of potash and 1 of calcined tartar dissolved in 24 of soft water. The surface of the article to be cleansed is moistened with the lye diluted with water. In the course of 3 or 4 minutes the adhering dirt will be loosened, when the article should be thoroughly washed with soft water.

It has also been recommended to cleanse lacquered articles by applying olive oil to the surface, dusting flour, prepared buck's horn, or infants' powder upon this, and rubbing off with a soft cloth. By this not only all stains and dust are removed, but the lustre of the article is also restored without injury to the colors and gilding.

To Cut and Pierce Rubber Corks. This can be easily accomplished by dipping the instrument used in potash or soda lye.

To Protect Stone and Brick Walls from Moisture. Brush the wall over

with a hot solution of $\frac{1}{2}$ pound of Castile soap in 1 gallon of water; let it dry for 24 hours and then apply a solution of $\frac{1}{2}$ pound of alum in 4 gallons of water.

Rosin as a Protection against Moisture in Walls. Heat 5 parts of turpentine and stir in 10 parts of pulverized common glue and 1 part of finely-sifted sawdust. Cleanse the wall and heat it by means of a soldering lamp or other flame, and apply the rosin composition, which can be run into every crack and joint by keeping the wall warm. Smooth by use of a hot iron. An addition of boneblack to the composition will give a dark color, or if the wall is to be painted a light color can be had by using light-colored rosin and woody fibre. This composition is also good for wood buried in the ground or exposed to moisture.

To Prevent Rust on Iron. Rub 1 ounce of graphite to a fine powder, add 4 $\frac{1}{2}$ ounces of sulphate of lead, 1 ounce of sulphate of zinc, and 1 pound of linseed-oil varnish; heat the whole to the boiling point and stir thoroughly. This paint can be used for all metallic articles exposed to the action of the weather.

To Prevent Wooden Posts from Rotting. I. Melt together in an iron boiler 50 parts of rosin, 40 of powdered chalk, and 4 of linseed oil; then add 1 part of natural cupric oxide and stir very carefully into the mixture 1 part of sulphuric acid. Apply with a stiff brush. When dry the mass forms a coating as hard as stone.

II. Melt 1 $\frac{1}{2}$ parts of rosin, then mix with it 48 parts of fish oil and 1 $\frac{1}{2}$ of sulphur. When the mixture is thoroughly combined and liquid add sufficient ochre, rubbed up with linseed oil, to give the desired shade of color. Then apply the mass, while still warm, in as thin a coat as possible, and in a few days, when the first coat is dry, repeat the operation.

Excellent Wash for Wood and Stone. The following receipt has been thoroughly tested and found to do excellent service: Slake 30 pounds of burnt lime in a suitable vessel by covering it with water. Dilute the resulting milk of lime and add first 2 pounds of sulphate of zinc and then 1 pound of common salt. A beautiful cream color is

obtained by adding 3 pounds of yellow ochre, pearl color by the addition of some lampblack, and stone color by adding 4 pounds of umber and 2 pounds of lampblack. The whitewash is applied in the usual manner with a brush.

Brilliant Whitewash Closely Resembling Paint. Slake $\frac{1}{2}$ bushel of lime with boiling water, covering it during the process to keep in the steam. Strain the liquid through a fine sieve or strainer, and add to it 8 quarts of salt previously dissolved in warm water, $2\frac{1}{2}$ pounds of ground rice boiled to a thin paste and stirred in boiling hot, $\frac{1}{2}$ pound of powdered Spanish whiting, and 1 pound of clean glue which has been previously dissolved by soaking it well, and then hang the whole over a slow fire in a small kettle within a large one filled with water. Add 5 gallons of hot water to the mixture, stir it well, and let it stand a few days covered from the dust. It should be put on quite hot; for this purpose it can be kept in a boiler on a portable furnace. It answers as well as oil paint for wood, brick, or stone, and is cheaper. It retains its brilliancy for many years. Colored matter, with the exception of green, may be put in it and made of any desired shade.

Utilization of Chicken Feathers. Cut the plume portions of the feathers from the stem. The former are then placed in quantities in a coarse bag, which, when quite full, is closed and subjected to a thorough kneading with the hands. At the end of five minutes the feathers become disaggregated and felted together, forming a down perfectly homogeneous and of great lightness. It is even lighter than natural eider down, because the latter contains the ribs of the feathers, which give extra weight. The material thus prepared is worth and readily sells in Paris for about 20 francs (\$4.00) a kilogramme (2.2 pounds). About $1\frac{1}{2}$ ounces of this down can be obtained from an ordinary-sized chicken. Through the winter children can collect all the feathers about a farm and cut the ribs out as has been stated. By spring time a large quantity of down could be prepared, which could be sold to upholsterers or employed for domestic uses. Goose and turkey

feathers may be treated and utilized in the same manner.

The chicken down forms a beautiful cloth when woven. For about a square yard of the material about $1\frac{1}{2}$ pounds of down are required. The fabric is said to be almost indestructible, as, in place of fraying or wearing out at folds, it seems to felt the tighter. It takes dye readily and is thoroughly water-proof.

Preservation of Wooden Labels. Wooden labels that are to be used on trees or in exposed places may be preserved by the following process: Thoroughly soak the pieces of wood in a strong solution of sulphate of iron; then lay them, after they are dry, in lime-water. This causes the formation of sulphate of lime, a very insoluble salt, in the wood. The rapid destruction of the labels by the weather is thus prevented. Bast, mats, twine, and other substances used in tying or covering up trees and plants can be treated and preserved in the same manner.

Collodion for Plant Slips. Dip the end of the plant slips in collodion before setting them out. The collodion should contain twice as much of cotton as the ordinary article used in photography. Let the first coat dry and then dip again. After planting the slips the roots will develop very rapidly. This method is especially efficacious with woody slips, as geraniums, fuchsias, and similar plants.

To Destroy Stumps of Trees. In the autumn bore in the centre of the stump a vertical hole of 1 to $1\frac{1}{2}$ inches in diameter and about 18 inches deep; put in 1 to $1\frac{1}{2}$ ounces of saltpetre and fill with water and then plug the hole tight. In the ensuing spring take out the plug and pour in about 10 ounces of petroleum and ignite it. The stump will smoulder away without blazing to the very extremities of the roots, leaving nothing but ashes. [In the United States clearing of lands of stumps on an extensive scale is done rapidly and effectively by the employment of dynamite cartridges. W.]

To Prepare Beef Tea. Take a thin rump steak of beef, lay it upon a board and with a case-knife scrape it. In this way a red pulp will be obtained which contains all the nutritious portion of the steak. Mix this pulp thoroughly

with 3 times its bulk of cold water, stirring until the pulp is completely diffused. Put the whole upon a moderate fire and allow it to come slowly to a boil, stirring all the time to prevent the pulp from caking. In using this do not strain it, but stir the settlings thoroughly into the fluid. One to 3 ounces of this may be given at a time.

To Disguise the Taste of Cod-liver Oil. Mix with each table-spoonful of oil 12 drops of the following compound: Two ounces of essence of lemon, 1 ounce of sulphuric ether, and $\frac{1}{2}$ ounce each of oils of caraway, peppermint, and cloves.

Remedy for Hoarseness. Borax is an excellent remedy for hoarseness or loss of voice common among public speakers and singers. A few minutes before any continuous exercise of the vocal organs dissolve a small lump of borax in the mouth and gradually swallow the solution. This acts upon the orifice of the glottis and the vocal cords precisely as "wetting" acts upon the notes of the flute. Five grains of nitre taken in a glass of water, the body being wrapped in extra clothing, will excite a gentle perspiration for an entire night; and this treatment will break up a cold, if employed at its first onset.

Extract of Elder Blossoms. Take 1 ounce of tincture of benzoin and add gradually $1\frac{1}{2}$ quarts of elder-blossom water.

Belladonna Ointment is used to allay pain in cases of rheumatism, boils, etc. It is prepared by mixing $\frac{1}{2}$ part of extract of belladonna with 1 of lard.

Cantharides Ointment is used to keep blisters open. Boil 1 part of cantharides in 12 of distilled water to $\frac{1}{2}$ its bulk. Then strain and add 15 parts of rosin cerate to it. Evaporate the mixture to the desired consistency.

Compound Chloride of Sulphur Ointment. Mix 8 parts of chloride of sulphur, $\frac{1}{2}$ of carbonate of potash, 30 of purified lard, and $\frac{1}{2}$ of essential oil of almonds.

Compound Lead Ointment is used for dressing inflamed ulcers. Take 6 parts of prepared chalk, 6 of diluted acetic acid, 36 of lead plaster, and 18 of olive oil. Melt the plaster in the oil at a moderate heat, add the chalk and then the acid, and stir the mixture until it is cold.

Creosote Ointment is used in skin affections. Mix 1 part of creosote with 8 of lard.

Elderberry Ointment is used as a soothing and healing application. It is prepared by boiling 1 part of elder blossoms with 1 of lard until the blossoms become pulpy, and then pressing through a linen cloth.

Elemi Ointment is stimulating, and is used for ulcers and to promote suppuration. Take 3 parts of elemi, $3\frac{1}{2}$ of oil of turpentine, 6 of lard, and $\frac{1}{2}$ of olive oil. Melt the elemi and lard together; take the mixture from the fire, stir in immediately the turpentine and the oil, and strain through linen.

Gall-nut Ointment is used for hæmorrhoids; it is astringent and soothing. Mix 6 parts of pulverized gall-nuts, 50 of lard, and $\frac{1}{2}$ of powdered opium.

Hemlock Ointment. Boil 1 part of fresh hemlock leaves and 1 of lard until the leaves are soft, and then strain through linen.

Iodide of Lead Ointment is applied in cases of swollen joints and scrofulous glands. It is prepared by mixing 1 part of iodide of lead with 8 of lard.

Iodide of Mercury Ointment is used for dressing scrofulous ulcers. Melt 2 parts of white wax and 6 parts of lard together, and mix with it 1 part of iodide of mercury.

Iodide of Potassium Ointment is used for scrofulous glands and ulcers. Dissolve 2 parts of iodide of potassium in 2 of boiling distilled water, and mix in 15 of lard.

Iodide of Sulphur Ointment is used for the cure of itch and other cutaneous diseases. It is prepared by mixing $\frac{1}{2}$ part of pulverized iodide of sulphur and 8 of lard.

Lead Ointments are applied to external inflammations wherever a remedy containing lead in the form of an ointment is admissible.

a. *Litharge Ointment.* One part of litharge, 1 of strong vinegar, and 3 of olive oil.

b. *Prussian Lead Ointment.* Six parts of wax, 24 of olive oil, 3 of lead vinegar, and 6 of distilled water.

c. *Saxon Lead Ointment.* Twelve parts of lead vinegar and 2 of olive oil; or, four parts of lard and 1 of lead vinegar.

d. White Lead Ointment consists of lard, mutton suet, white lead, and camphor.

e. Lead Cerate. Mix 6 parts of wax with 24 of olive oil to which have been added 3 parts of lead vinegar and 6 of distilled water.

Mercury Ointment. Take 12 parts of mercury, 11½ of lard, and ½ of suet. Rub the mercury with the suet and a little lard until no more globules of mercury can be detected; then add and mix with it the remaining lard. The ointment is used in all cases where an application of mercury is admissible.

Opium Ointment is used as a soothing dressing. It is prepared by mixing 1 part of pulverized opium and 24 of lard.

Pitch Ointment is used as a stimulating application, promoting suppuration. Melt together equal parts of black pitch, wax, and rosin, and press through a linen cloth.

Savin Ointment is used for keeping open blisters and issues (fontanels).

Spermaceti Ointment is applied as a cooling dressing. It is prepared by melting together 5 parts of spermaceti, 1½ of white wax, and 14 of olive oil, constantly stirred until it is cold.

Sulphur Ointment is used for the cure of itch. Rub the affected parts with it in the morning and evening. It is prepared by mixing ½ part of sulphur with 1 of lard.

Sulphur Ointment (Compound) is also used for itch and other cutaneous diseases. Apply twice a day, morning and evening, by rubbing thoroughly into the affected parts. It is prepared by mixing together 4 parts of sulphur, 1 of pulverized white hellebore, ½ of saltpetre, 4 of soft soap, and 12 of lard.

Tar Ointment is also used for the cure of itch, scab, etc. Melt 1 part of tar and 1 of lard, and press through a linen cloth.

Tartar Emetic Ointment is used for producing eruptions on the skin and as a counter-irritant. It is prepared by mixing 1 part of pulverized tartar emetic with 4 of lard.

Zinc Ointment is used for inflamed eyelids, sore nipples, and also for ring-worm, etc. It is prepared by intimately mixing 1 part of oxide of zinc with 6 of lard.

Ammonia Liniment is used as a stimulating application on ulcers and contusions, and can be made painless by adding a little extract of belladonna. It is prepared by shaking 1 part of aqua ammonia with 2 of olive oil until they are emulsionized.

Camphor Liniment, used as a stimulating application in sprains, contusions, or rheumatism, is prepared by rubbing 1 part of camphor in 4 of olive oil until the first is dissolved, then adding 3 parts of aqua ammonia, and thoroughly shaking the mixture.

Compound Camphor Liniment is more active than the simple liniment. Dissolve 2½ parts of camphor in 17 parts of rectified spirit of wine, add ½ part of oil of lavender and 3 of aqua ammonia, and shake until they are intimately mixed. In case the pain is very severe, ¼ part of its volume of tincture of opium may be added.

Lime Liniment is often used for alleviating pain caused by burns and scalds. Mix 10 parts of lime-water with 10 of olive oil.

Opium Liniment is used as an external means of soothing when opium cannot be administered internally. It is frequently mixed with the compound camphor liniment. Mix 2 parts of tincture of opium with 6 of soap liniment.

Soap Liniment is used for the same purposes as compound camphor liniment, but is not as active. Take 2½ parts of soap, 1 of camphor, 18 of spirit of rosemary, and 2 of distilled water. Mix the water and the spirit, then add the soap and camphor, and macerate until the solution is complete.

Turpentine Liniment, a stimulating application used for burns. Mix 2 parts of soft soap, 1 of camphor, and 6 of oil of turpentine.

Verdigris Liniment acts as a stimulant on indolent venereal and other ulcers. Dissolve 1 part of pulverized verdigris in 7 parts of vinegar, and strain through linen; add 14 parts of honey, and evaporate the mixture to the requisite consistency.

Betton's Celebrated Cattle Liniment (Critical Oil). Mix 1 part of oil of rosemary, 8 of tar, and 16 of oil of turpentine.

Turkish Balsam for Fresh Wounds.

Pulverize and mix 2½ ounces of benzoin, 1½ ounces of tolu balsam, 1 ounce of storax, a like quantity of frankincense and myrrh, and 1½ ounces of aloes. Pour 1 pint of rectified spirit of wine over the mixture and let it digest for 3 days at a moderate heat, and then quietly settle for 6 days, when the fluid is filtered off and kept in well-closed glass bottles.

To Soften Hard Water. Pulverize 2 parts of calcined soda, 1 of bicarbonate of soda, and mix them with 2 parts of a solution of silicate of soda. Let the mixture stand for 24 hours, during which time it becomes generally so hard that it can be rubbed into a powder. One to 1½ pounds of the mixture will, as a general rule, suffice for 25 gallons of hot water, which can then at once be used for washing, etc.

To Keep Tallow and Lard from becoming Rancid. The tallow or lard is first treated with carbonate of soda in the proportion of 2 pounds of soda to every 1000 pounds of lard, and is then subjected to a digestion with alum in the following manner: Ten pounds of alum are dissolved in 500 pounds of water and 1 pound of slaked lime added to the solution, which is then boiled. This solution is stirred well with 1000 pounds of lard, at a temperature of 150° to 195° F., for about ½ hour. The liquor is then separated from the lard and the lard treated with the same amount of pure water. This lard will keep for an exceedingly long time. This treatment has also the advantage of restoring the original flavor and of producing a lard of greater whiteness.

Rancid Butter may be purified by melting it and removing any deposit; then boiling it with lime-water and allowing it to settle; and finally, treating the liquor thus clarified by suddenly cooling.

Another Process of Purifying Rancid Butter is as follows: Melt the butter over a moderate fire and add to every 10 pounds of butter 5½ ounces of fresh, pulverized wood charcoal, ½ ounce of pulverized chalk, 1 table-spoonful of honey, and a few carrots cut up in pieces. Keep this mixture in a melted state for ½ hour, constantly stirring it and removing the scum. Then pour the liquid butter through a fine strainer.

Butter thus treated is, when cold, inodorous and has an agreeable taste. The charcoal absorbs the badly-smelling gases, the chalk neutralizes the acid which may be present, the honey improves the taste, and the carrots impart a yellow color to the butter. When the butter is cold take it from the vessel and cut off the sediment on the bottom, sprinkle with fresh water and keep it in a cool place. It is recommended to place the vessel containing the butter in another filled with fresh water, or, what is still better, in a trough through which runs a current of fresh water.

To Purify Rancid Fat. Heat to the boiling point 10 pounds of the fat to be purified, 1 gallon of water, and 1 ounce of sulphuric acid; let the mixture boil for ¼ hour and then remove it from the fire. Now add 4½ ounces of pulverized chalk and let the mixture cool. The purified fat separates from the gypsum water and the sulphate of lime (gypsum) which has been formed, and can be again used.

Douglas's Powder for Purifying the Air in Stables is much used in England. It keeps the stables wholesome by preventing the putrefaction of excrement and urine. It is prepared by treating magnesian lime with sulphuric acid and adding 5 per cent. of carbolic acid. The powder obtained in this way is scattered upon the manure and in the stalls.

The Removal of Foul Air from Wells is easily accomplished by fastening a line to the handle of an umbrella and lowering it open, handle upwards, into the well and quickly drawing it up again. By repeating this several times the foul air will be removed.

How to Keep Ice without an Icehouse. Select a dry, shady spot. Dig a ditch for carrying off the waste water and over it place a lath-work. Upon this lay a thick layer of moss, pine leaves, or sawdust. Now pile upon this the cakes of ice, the larger the better and cut or sawed square, in such a manner as to leave as few spaces as possible, filling up those which may occur with fine sawdust, in order to prevent the air from penetrating into the interior of the pile. It is best to build the stack in the form of a pyramid. When completed it is covered with straw, moss,

leaves, etc., as thick and close as possible, a layer of earth being thrown upon it to secure the covering and as further protection of the ice.

How to Keep Fruits in Icehouses. Lay the fruits upon cotton in tin boxes without any packing about them, shut down the lid and set them upon the ice, not buried in it. After the fruits have been long on the ice they should not be brought out long before they are used, as they do not keep long afterward without showing specks. This process is of course only intended for tender fruits, as peaches, nectarines, etc. Peaches have been kept in this way more than a month after they were dead ripe, and nectarines nearly 2 months. Tender-fleshed melons, which will not keep a week in the fruit room in summer, will keep a month in an icehouse.

Substitute for Coffee. A substance resembling coffee in appearance and taste can be made by separating the seeds from the pulp of persimmons, cleansing them, and afterward roasting and grinding them in the same manner as coffee.

To Preserve Canvas, Cordage, etc. Dissolve 1 pound of sulphate of zinc in 40 gallons of water and then add 1 pound of sal-soda. After these ingredients are dissolved add 2 ounces of tartaric acid. The canvas, etc., should be soaked in this solution for 24 hours and then dried without wringing.

Store-polishing Compound. Mix 2 parts of copperas, 1 of boneblack, 1 of black lead with sufficient water to form a creamy paste. This will produce a very enduring polish on a stove or other iron article, and after 2 applications it will not require polishing again for a long time, as the copperas will produce a jet-black enamel and cause the black lead to permanently adhere to the iron.

Wiggin's Process of Purifying Lard and Tallow. Heat the melted fat with some sulphuric acid of 1.3 to 1.45 specific gravity, when the fat will separate itself in a pure condition from the impurities and membranous substances.

Manure Salt from Urine. By compounding urine with hydrochlorate of magnesia a precipitate of phosphate of ammonia and magnesia is formed in a few days, which increases considerably

in 4 weeks, when it is separated from the fluid and dried. In this way 7 per cent. of manure salt is obtained.

Solution of Guano for Flowers. Dissolve 1 pound of Peruvian guano in 5 gallons of rain water and wet the plants with it twice a week.

Substitute for Guano. Mix 350 parts of bone-dust, 97 of sulphate of ammonia, 19 of pearl ash (or 78 of wood ash), 78 of rock or common salt, 19 of dry sulphate of soda, and 40 of crude sulphate of magnesia.

Manure from Coal Ashes. Place 1 part of fresh unslaked lime in the centre of a heap of 100 parts of coal ashes and let it remain until it is entirely slaked. After 12 hours work the heap through thoroughly and then store it in a dry place for future use.

Manure for Turnips, Rutabagas, etc. Mix 100 parts of common salt with 300 of lime and let the mixture lie for a few months. When sowing the seed strew the mixture into the furrows.

Stockhard's Manure Mixture for Vegetable Gardens. Mix 300 parts of peat waste, 30 of burned lime, 30 of pulverized brick, 30 of wood ashes, 2 of common salt, 36 of horn shavings, and 45 of leaves. The above mixture suffices for 250 square yards and produces excellent results.

Manure Powder from Blood. Pulverize 20 parts of plaster of Paris and 12 of calcined sulphate of soda and mix them in 100 parts of blood in a large boiler, and add 5 parts of sulphuric acid at 60° Beaumé in small portions. The product will be a spongy mass which is dried and ground to powder.

Manure from Waste Animal Substances. Chop 100 parts of solid animal substance and treat with 18 parts of a solution made of 1 part sulphuric acid at 66° Beaumé and 2 of water, and grind the mixture for an hour, and after standing 6 hours treat it with 8 per cent. of pulverized quicklime. Sulphate of lime is thus formed in which the animal matter remains inclosed. After standing for 6 hours the whole is moulded into brick-shaped masses, which are drained in the perforated moulds in which they are prepared and then dried and pulverized.

Liquid and semi-liquid masses like brains or blood are treated with 9 per

cent. of sulphuric acid at 66° Beaumé and 12 per cent. of quicklime, the rest of the process being the same.

ILLUMINATING MATERIALS.

Incombustible Wicks. Alumina, kaolin, quartz, or combinations of calcium, magnesium, or aluminium are ground fine and intimately mixed with dragon's blood and colophony or other resins in connection with saltpetre, permanganate of potash, or other combinations rich in oxygen. The mixture is then compounded with water until the mass is plastic and capable of being kneaded. From this composition, which should be as homogeneous as possible, the wicks are formed, then dried in the air, and gradually exposed to a moderate red heat for 1 or 2 hours.

The wicks may also be intermingled with fibres of asbestos, or surrounded with a tissue of the same material. In the latter case it is not necessary to expose the wicks to a red heat, as this is done in using them.

Metallic Wicks are prepared by adding 1 or more threads of zinc wire to the ordinary wick of silk, cotton, linen, or asbestos. The purpose of this is to increase the vigor and intensity of the flame without a larger consumption of fuel, or to obtain equal light with a considerable saving of fuel. It has been known for many years that zinc, when heated, is consumed with a brilliant white flame, but this is the first time, to our knowledge, that this property of zinc has been used for this purpose. Suppose a wick has an illuminating power of 1, and one or more threads of zinc wire, which are brought to a red heat, have been added, they are consumed at the same time with the wick, increasing the illuminating power by 2, 3, etc.; it is therefore self-evident that with the same expense of wick and fuel an increase in illuminating power must be the result. In fact, experiments we have made have shown that with 7 cotton and 1 zinc thread an illumination equal to that from 20 cotton threads was obtained. Wicks for all kinds of candles and lamps may be prepared in this manner.

Material for Preparing Incombustible

Torches. Mix 3 parts of alumina, 1 of bauxite, 4 of sawdust, and 4 of wheat chaff with water into a stiff dough, and mould into any desired shape. Surround this core with a jacket made of 3 parts of alumina, 1 of bauxite, 2 of sawdust, and 2 of wheat chaff, and provided with draught holes. A small saucer of fat clay impervious to petroleum is placed around the foot of the torch to catch any falling drops of petroleum, with which the torch is saturated before being ignited. A small cylinder of the same kind of clay and lined with sheet iron is inserted in the centre of the torch for the reception of the handle. When entirely dry, the torch is subjected to a red heat for 16 hours, whereby the sawdust and wheat chaff are completely consumed, leaving the mass full of pores and adapted for a greedy absorption of oil. When the torch is entirely dry, and is to be used, it is soaked, as stated, in petroleum and ignited. It will last for an indefinite time.

Gas from Cork. Illumination by gas prepared from waste of cork has been successfully tried in the *Theatre National de l'Opera* in Paris. The waste is heated in retorts, and the product of distillation purified by being conducted through a water reservoir. The gas possesses great illuminating power, and is free from sulphuretted hydrogen and other objectionable admixtures.

Naphtha Ether. A new *Illuminating Material.* By mixing benzole with alcohol or wood spirit, a body is formed which burns without forming soot.

Air-tight and Flexible Tissue for Dry Gas Meters. Any kind of tissue is brushed over with a fluid prepared in the following manner: A solution obtained by boiling 500 parts of gelatine, 750 of glycerine, and 1500 of water is compounded with 40 parts of bichromate of potash and 4 of an alcoholic solution of salicylic acid, and the whole stored in a dark room until it is to be used. After the tissue has been painted with the fluid so that all pores are closed, it is exposed to the light until it has become entirely white. Samples of such material have been entirely indifferent to the action of sulphide of hydrogen, bisulphide of carbon, glycerine, alcohol,

ammonia, creosote, etc., for more than a year, and have lost nothing in elasticity.

To Detect a Leak in a Gas Pipe it is recommended to bring a little soap water upon the suspected place; the formation of soap bubbles will show where and how large the leak is.

Improvement in Dry Meters. The diaphragms used in dry gas meters are usually made of leather, but these are acted upon by the gas in course of time and do not register correctly. To remedy this, diaphragms made from parchment paper are substituted for the leather. The parchment paper is obtained by treating cotton or linen paper with equal parts of sulphuric acid and water for a few minutes, washing thoroughly with water, and then saturating with equal parts of glycerine, acetate of potassium, and water.

Apparatus for Manufacturing Illuminating Gas from Ligroin and Air by the Cold Method. The ligroin is introduced through the tube Z (Fig. 26), and gets under the sieve c through the valve o provided with the float r, by passing the plates f, which are covered with porous substances. When the ligroin has reached a corresponding high level it lifts the float r, whereby the valve o is closed and the supply stopped. The air enters through the tube m provided with the valve x, gets under the bell C, and lifts the latter up until it has reached the highest admissible point. When this is the case the valve x is closed by the self-acting hinge-joint arrangement S, and the supply of air shut off. As both the valves o and x are automatic, the apparatus works with great regularity. The air introduced reaches the ligroin through the tube k, passes over the plates f, where it is carburetted and passes out through the tube g.

The machine may, if necessary, be connected with a heating apparatus.

Purification of Illuminating Gas. The process of freeing gas from ammonia by the dry method consists in conducting the gas through a porous mixture of sulphate of lime and phosphate of lime with or without a percentage of phosphate of iron. The substance is produced by treating superphosphate with aqua ammonia and drying the mixture.

Preparation of Wicks for Stearine Candles. The following process has

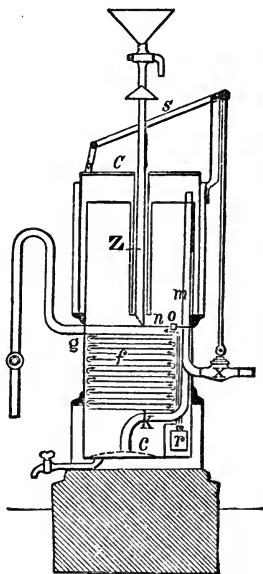

Fig. 26.

always given satisfactory results. The wick is laid for 4 hours in warm water acidulated with sulphuric acid, when it is wrung out and dried by means of hot air for 24 hours. It is then placed in a bath consisting of 1000 parts of rain water, $4\frac{1}{2}$ of boracic acid, and 186 of crystallized sulphate of ammonia, and should be frequently turned. After it has been taken from the bath it is dried for 72 hours.

"Melanyl" Candles consist of equal parts of stearine and hard paraffine. This candle combines the pleasantness of the stearine and paraffine candle without the disagreeable features of the latter.

To Coat Tallow Candles with a Hard Substance which will not crack. The candles are coated by successive dip-pings into the following 3 mixtures:

1. Melt 1 part of dammar resin, 2 of

white rosin, 10 of stearic acid, 44 of good tallow, and 3 of camphor.

II. Melt 5 parts of dammar resin, 2 of white pitch, 10 of stearic acid, 24 of tallow, and 3 of camphor.

III. Melt 2 parts of white wax, 10 of stearic acid, 5 of tallow, and 3 of camphor.

To *Color Paraffine, Wax, Stearic Acid, etc., Black*. The materials are melted and digested for some minutes with coarsely powdered or bruised anacardium nuts (the fruit of *Anacardium orientale*). This nut contains a black, fluid, vegetable fat, which combines intimately with the fused candle material and does not injure the illuminating power of the candles.

Coloring Tallow. Grohdaus rejects as a general rule the coloring of tallow to be used for candles, with the exception of giving the candles a bluish-white tint. He claims that the coloring of candles is only advisable if they are to be used shortly after being manufactured. For this he gives the following receipts: To color tallow *blue*, rub it up with the finest ultramarine at a temperature of from 120° to 145° F. The most common method of coloring it *green* is with sulphate of copper dissolved in water and stirred through the tallow; this serves also for clarifying. If the tallow will not take the color, some older tallow must be added. For 100 pounds of tallow 4½ ounces of sulphate of copper are generally taken. It may also be colored green with verdigris treated in the same manner as ultramarine. To color *red*, the boiling hot tallow is poured over heuna (al-canna root, whereby it assumes a dark red color. All possible tints can then be produced by adding white tallow. The tallow is colored *yellow* by adding unbleached palm oil having a reddish tint, and also with annotto.

Junemann's Process of Producing White and Hard Tallow Candles Burning with a Large Flame and Consuming the Wick. Add an equal quantity by weight of water to the tallow and melt it in a vat by introducing steam. Then add gradually and in very small portions at a time, the milk of lime prepared from 14 to 20 per cent. of quicklime and the requisite quantity of water, and keep the mass in constant motion by stirring.

After 4 hours' saponification will have progressed so far that the stirring implement can no longer be moved, but the introduction of steam is continued for 1 or 2 hours longer until the mass has the appearance of grits. The steam is then shut off, and the yellowish, sweetish water, which remains on the bottom of the vat and contains the glycerine, is drawn off. The soap, when cold, is pulverized between 2 iron fluted rollers, and the powder brought into another vat also heated by steam and containing 28 to 30 per cent. of concentrated sulphuric acid of 66° B., reduced with water to 25° B. In this the soap powder is boiled for 4 hours, whereby the lime contained in the soap combines with the sulphuric acid and is precipitated as gypsum. The sebatic acids are then brought into one or several smaller vats and, when nearly cool, 3 per cent. of nitrous acid is added, and the compound constantly stirred until the sebatic acids are entirely congealed. The nitrous acid is obtained as follows: Add water to concentrated nitric acid until it shows 22° B., and then bring it into Woulff's bottles connected by a gas tube with a cast-iron retort. Place in the retort 5 per cent. of finely-pulverized sugar and 20 per cent. of dilute sulphuric acid, and heat until no more red vapors pass over, whereby the acid in the bottles, which should be kept cool, by absorbing nitrous acid gradually assumes a blue, then a green to dark green color, this being the right moment of interrupting the operation and adding the acid to the fat. After thoroughly mixing and adding a few strips of zinc, the fat is brought into another vat and boiled for 1 to 2 hours by introducing steam, the process being interrupted 3 or 4 times during the operation by shutting off the steam for 5 to 6 minutes each time. Finally, when a sample taken from the vat indicates that the fat has assumed a dark yellow color and a considerable degree of hardness, add a few bucketfuls of water, let it boil for ½ hour longer, and then allow it to stand quietly to settle.

The sebatic acids are finally brought into a distilling apparatus and distilled by the action of an abundant current of superheated steam, and are then washed

several times in water acidulated with $\frac{1}{4}$ of 1 per cent. of oxalic acid in a vat heated by steam, when they are left standing quietly and finally filtered through a thick woollen cloth or felt.

The sebacic acids treated in this way have lost their original appearance and present now a white and very hard mass, feeling but slightly greasy.

To prepare candles of the finest quality, the distilled sebacic acids must first be pressed cold and then hot. The press-cakes contain 70 per cent. of the tallow used, and as regards external qualities are equal to stearic acid, differing from the latter only in their melting point being a few degrees lower.

The moulds should be slightly heated and the tallow stirred until it has assumed a milky appearance before being poured into the moulds. No wax is added. The three-cord plaited wicks used are first boiled for 10 minutes in a solution of $11\frac{3}{4}$ ounces of glassy phosphoric acid and $1\frac{3}{4}$ ounces of boracic acid to every 100 pounds of water, and then slowly dried.

Fabrication of Stearine Candles without the Use of Presses and other Expensive Machinery. Heat 10 to 20 per cent. of good candle tallow in a thoroughly cleansed boiler. When melted extinguish the fire and allow the tallow to stand until a thin film is formed upon the surface. Then add 2 per cent. of soda lye of 30° B., and stir until the mass has acquired the consistency of soap prepared in the cold way. The fire is now rekindled and the compound brought to the boiling point. The soap by boiling is again decomposed and a flaky precipitate, containing the impurities which must be removed from the tallow, is formed. By allowing the tallow to settle for some time it becomes clear and nearly colorless. In this state it can be advantageously used for lubricating machinery. But for the manufacture of candles it requires further treatment, as it still contains traces of soap, which are as injurious as impure tallow. For this purpose it is brought into a copper boiler and clarified with acidulated water of 1° to 2° B. As long as it contains traces of soap, a froth, which does not dissolve, appears on the surface. The addition

of acidulated water is continued until the froth has entirely disappeared, when it may be assumed that the soap is decomposed. But it is best to make sure of it by a test. For this purpose draw off some of the fluid from the bottom of the boiler and test it with litmus paper; if this is not reddened the boiling must be continued with a further addition of acidulated water. When litmus paper is reddened by a sample the tallow is allowed to settle; the acid water is then drawn off and the fat boiled again with fresh water.

The oleine and stearine are then separated in the following manner: A vat is required, which is provided with a false bottom having holes $\frac{1}{2}$ inch in diameter, and placed about 4 inches above the bottom of the vat, and with a faucet between the two bottoms. Place in it equal quantities of the tallow and boiling water, and cover the vat to prevent rapid cooling. The mass is allowed to stand for 2 or 3 days according to quantity, until a thermometer dipped into the upper layer of the tallow shows a temperature of 70° to 75° F. When this is the case the faucet is opened, the water in the lower part of the vat running off first, then the oleine, while the crystallized stearine remains upon the false bottom and is ready for moulding. This is done in the same manner as tallow candles, but at a higher temperature. The mass, which should have a milky appearance, must be constantly stirred. Three-cord plaited wicks are used.

New Automatic Gas-lighter. This consists of a film of collodion incorporated with platinum black (finely-divided metallic platinum). It is prepared as follows: Pour a somewhat concentrated solution of gun-cotton upon a glass plate and, as soon as the collodion film has acquired some consistency, scatter upon it not too thin a layer of platinum black, and to prevent the latter from becoming heated in consequence of the evaporation of the solvent, quickly cover the whole with another glass plate. By inserting a small piece of the film, when thoroughly dried out, in the upper part of an ordinary gas burner, and turning on the gas, the latter will be immediately ignited.

IMITATIONS, SUBSTITUTES, ETC.

Artificial Leather for Lithographers' Rollers. The following mass, previously melted in a water-bath, is poured around a core about $\frac{1}{2}$ inch less in diameter than the mould:

Syrup	20 parts.
Glue	20 "
Saltpetre	3 "
Sugar	3 "
Water	5 "
Oil of almonds	1 part.
Chrome yellow	1 "

The mass, when cold, is taken from the mould, placed for 10 hours in a solution of 1 part of sulphate of alumina and 1 of potash in 10 of water, when it is dried in the air for 4 to 6 days.

Vegetable Ivory is obtained in large quantities from the kernel of a nut of a variety of palm (*Phytelephus makrocarpa*) indigenous to Central and South America and Africa. The green hull of the unripe nut encloses a watery fluid having a bitter taste, which, gradually thickening, forms the kernel. The semi-liquid fluid, mixed with water and sugar, is used in South America as a favorite, refreshing, and wholesome beverage.

Substitute for Horn, Hard Rubber, Ivory, etc. By stirring starch into a thick paste with a little water, and heating this from 212° to 265° F., it is converted into a transparent, elastic mass, which is then dried and worked into combs, buttons, etc. For certain purposes pigments, glue, sugar, wool, silk, fish scales, asbestos, and similar substances are mixed with the starch paste.

Vegetaline. This new substance, claimed by its inventor to be incombustible, impervious, and unchangeable, serves as a substitute for ivory, coral, caoutchouc, leather, etc. It is prepared by treating cellulose derived from any source with sulphuric acid of 58° Beaumé, at a temperature of 60° F., and then washed with cold water to remove any excess of sulphuric acid, dried, and pulverized. The powder is mixed with resinous soap, as sodium resinate, and the soda separated by sulphate of alumina. The mass is again dried and pressed into cakes in a hy-

draulic press. The cakes are cut into thin slices and moulded into desired shapes by strong pressure. To make the substance entirely incombustible, the cellulose, after having been treated with sulphuric acid, is washed with chloride of ammonia, silicate of lime, or the borates of soda and potash. To make it transparent, castor-oil or glycerine is added to the dry powder, vegetable coloring matter being used for coloring it. Its opaqueness is increased by adding linseed oil converted into a siccativ with litharge; mineral colors being in this case used for coloring.

Substitute for Linseed Oil and Oil of Turpentine in Preparing Paints. Mix 100 parts of colophony and 20 of crystallized soda with 50 of water, and dilute the mixture with 250 parts of water and 24 of caustic ammonia. The product thus obtained is of a syrupy consistency and can be mixed with the pigments in the usual manner. It dries and quickly becomes hard, covers well, can be coated with varnish, and is not affected by moisture and changes of temperature.

Substitute for Bristles. The fibrous bark of the sugar palm (*Arenga saccharia*) is a good substitute for bristles and animal and human hair. The bark is first immersed in water and boiled for some time in an alkaline solution. The fibres are then soaked in an emulsion of fat, alkali, and water for about 12 hours, after which time they are sufficiently hard and elastic to be used.

Artificial Chalk. In preparing soda water, gypsum results from the action of the oil of vitriol on the limestone used. This is mixed with lime-mud obtained in making soda-ash caustic. The whole is then elutriated, and the liquid containing the finer portions in suspension is run off and allowed to settle; the powder is then pressed into moulds and dried.

Artificial Leather. The following new article of vegetable leather has been invented and patented by X. Kar-chesky, of Belleville, N. J. It is composed of a web of paper having one or both of its surfaces converted into vegetable parchment. This is dyed by a process which produces an even and perfect diffusion of color throughout the material, and then embossed to imi-

tate leather. The process is as follows: Paper of any desired thickness is immersed in a weak solution of sulphuric acid, the thickness of the paper or the sizing upon the paper determining the strength of the acid solution. The object of this is to reduce only the surface of the paper to pulp without dissolving the entire fabric, so that the result will be a paper web retaining its fibrous quality, but enclosed within 2 films of vegetable parchment. After the surface of the paper has been reduced by the action of the acid to a pulpy state it is taken from the acid bath and lightly scraped by being drawn over stationary scrapers, care being taken not to scrape hard enough to remove the pulp or tear the sheet. The sheet is then passed over a series of hard, smooth rollers, which compress and spread the pulp evenly over the surfaces of the sheet, thus producing a fabric smooth and glossy on both sides. It is then placed in a water-bath for the purpose of diluting and partially washing out the sulphuric acid in it, a small quantity of the acid being allowed to remain. After being removed from the water-bath the fabric is submitted to a series of dye-baths, more or less in number, according to the depth of color required. The dyes are either alkaline or an alkali is added if necessary. The sulphuric acid left in the fabric acts as a mordant, and the energy and avidity with which the alkaline dyes seek the acid cause a uniform and complete diffusion of color throughout the fabric. It is then washed with water to remove any sulphates or excess of coloring matter lying upon its surfaces, and again drawn over the scrapers to remove the excess of water. It is then passed through a warm bath of glycerine, which, as the water remains in the fabric, penetrates it throughout. It is then carried to hot drying cylinders, over which it is kept passing until the water has been completely expelled, care being had not to subject it to a high enough heat to evaporate the softening material. It is then passed through cold calender rollers until it is thoroughly cooled off, when it is wound upon a reel and is ready for embossing. This is done in the usual manner by subjecting the

fabric to hot pressure from engraved rollers.

When it is desired to convert only one surface of the paper into vegetable parchment, the process is modified by substituting in place of the acid bath a roller or rollers of smooth lead or rubber revolving in acid, over which the paper is carried and upon which it is pressed by another roller or rollers. By this means only one side of the paper absorbs the acid, the remainder of the process being the same as when both sides of the paper are converted into vegetable parchment.

Artificial Leather (Stierlin's German and French Patent). A loosely-cohering fleece of flax, cotton, or hemp is prepared on the carding engine and immersed in a solution prepared as follows: Dissolve 25 parts of animal or vegetable glue, which has been exposed to the action of tannin, in 75 parts of water, and compound the solution with 20 parts of pipe-clay and 5 to 10 of any kind of tannin. The fleece is then passed through rollers heated by steam, which press out the excess of material, and is next brought into a bath containing a decoction of oak bark with 5 per cent. of glycerine. By this solution color, softness, and density are imparted to the fabric. After remaining here for 12 to 24 hours the fabric is taken from the bath and dried by means of hot or cold air, after which the leather is ready for use.

Artificial Wool is prepared by mixing vegetable fibrous substances, as jute, hemp, nettle, flax, etc., with wool. The fibrous substances are boiled with caustic lye, at 350° F., for ½ hour, then washed, and repeatedly boiled in another boiler, 2 ounces of ammonio-sulphate of copper and 2 pounds of soda being added to every 100 pounds of material during the boiling. The material is then washed, dried, and mixed with the wool.

Substitute for Meerschaum, Ivory, etc. A material which can be carved is prepared by treating peeled potatoes for 36 hours with a solution of 8 parts of sulphuric acid in 100 of water. The mass is then dried between blotting-paper and pressed. Pipes closely resembling meerschaum and other articles can be manufactured from it. By the use of a

very strong pressure a close imitation of ivory billiard balls has been made of this material.

Porous Substance as a Substitute for Felt for Trays for Beer Glasses. The felt generally used in trays for beer glasses is replaced by a porous mass of clay consisting of 54 parts of Meissen clay, 27 of porcelain earth, 13 of feldspar, and 6 of chalk. The materials are moistened with water and finely ground, when they are dried until sufficiently plastic to be moulded. The moulded pieces are then moderately burned in a potter's oven.

Substitute for Cast Iron, Stone, Clay, and Cement. Sixty to 80 parts of blast-furnace slag, 10 to 20 of soda waste or alkalies, and 1 to 20 each of lime, pyrolusite, and greenstone (diabase) are melted together in a small blast furnace or cupola, so that the mass has about the following composition:

Silica	60 per cent.
Lime	10 "
Alumina	10 "
Ferric and manganic oxide	8 "
Alkalies	12 "
	100 "

The mass is so hard and tough that it can be turned like steel, and resists the action of the atmosphere, water, and acids to such a degree that it can be used for gas and water pipes, building purposes, steps, etc.

Heels of Boots and Shoes, Buttons, etc., can be prepared from pulverized leather without the use of an agglutinant. Place thoroughly cleansed leather waste in a water-bath of about 150° F. for 1 hour, then carefully dry it in a revolving drum at about 150° F., and grind it to a fineness according to use intended. The ground material is pressed into moulds heated to about 240° to 250° F., and subjected for about 10 minutes to a pressure of not less than 800 pounds to the square yard. For boot heels the powder is left in the moulds until the exterior parts become hard, but the interior remains comparatively elastic. If substances are added which do not combine with the leather waste at the above heat, the moulds must be heated from 290° to 300° F. to make the leather semi-fluid.

Hall's Substitute for Leather. Mix in a suitable vessel 4 parts of wax, 2 of caoutchouc, 1 of resin, 2 of bone-black, and 1 of lampblack, and apply the mixture while warm to cloth or other fabrics by means of a brush. Let it dry thoroughly and repeat the coating several times, allowing the previous coating to become entirely dry before applying the next. This material, after having been lacquered, is principally used for shields for caps.

Preparation of Leather Cloth. Heat for 1 hour over a moderate fire 15 parts of powdered litharge, 15 of pulverized brown umber, and 2 of manganic hydrate with some linseed oil; then add 500 parts of linseed oil to the mixture and let the whole stand for a few days to settle. It is then thoroughly mixed with an equal volume of water, and applied to linen, cotton, or woollen tissues, and allowed to become dry. Now mix clear linseed oil with lampblack to a stiff paste and spread it on the tissue. If the latter is very thin, or the coating required to dry quickly, the linseed oil must be boiled with the above-named substances for 2 or 3 hours to acquire the proper consistency. A paste made of 15 parts of plumbic salt and some turpentine and lampblack to 1000 parts of linseed oil is spread over the first coating and allowed to dry. Successive applications of raw linseed oil follow until the surface is suitable, when it is smoothed with pumice. Mix linseed oil with lampblack or other coloring matter, and paint the surface, allow it to dry, and pumice. Coat with a varnish of 1000 parts of linseed oil, 57 of umber, 5 of litharge, and 5 of Berlin blue, boiled for 24 hours, and when cold mixed with turpentine. After the coat of varnish is dry the appearance of Morocco is given to the fabric by subjecting it to pressure from engraved rollers. The material, which is already manufactured in large quantities, is soft, pliable, perfectly water-proof, and particularly well adapted for saddler and trunk-maker's work, fancy articles, etc.

Micoud's Artificial Leather. Knead boiled rye flour, pulverized Spanish chalk, some kind of coloring matter, and linseed oil into a uniform dough, and apply this to woollen or cotton tis-

uses with a suitable instrument. Pumice the coat, when dry, and then brush it over with an oil varnish to which the desired color has been added. After an even and perfect diffusion of the color, the fabric is again pumiced and coated with fine lacquer. The flesh side of the leather is prepared in the same manner by using an oil or aqueous mixture, according to the purpose for which the fabric is to be used. The first is prepared by adding white lead ground in linseed oil of the consistency of syrup, and reducing this with oil of turpentine, so that it can be conveniently applied to the tissue, coating it several times. The aqueous mixture consists of gelatine, gum paste, solution of gutta-percha, or of caoutchouc. Whatever the mixture applied, dust of cotton, silk, woollen, or leather is sifted over it and allowed to dry, when the particles not adhering are removed by brushing.

Artificial Slating for Blackboards and School Slates. Mix 16 parts of ground pumice-stone and 21 of pulverized animal charcoal with 10 parts of purified caoutchouc and 5 of sulphur. Roll out the mixture in thin sheets and cut it into the desired sizes, which are then formed into packages in the following manner: First a sheet of tin plate, next 1 of paper, on the top of this a layer of the above composition, then again a sheet of tin plate, a sheet of paper, a layer of composition, and so on, are pressed together, brought into a boiler, and there submitted to a temperature of 266° to 285° F. for 2½ hours. The packages are then taken from the boiler, and each plate, with the paper covering it on both sides, is tightly compressed by passing it through 2 plates heated by steam, and then again submitted to the above temperature for 2 hours. The plates, when cool, are pumiced, and are then ready for use.

Artificial Ebony. This is prepared on a large scale by grinding to powder 60 parts of charcoal obtained from seaweeds, previously treated with dilute sulphuric acid and dried, and mixing it with 10 parts of liquid glue, 5 of gutta-percha, and 2½ of caoutchouc, the latter two substances having been previously mixed with coal-tar to render them gelatinous. Then 10 parts of coal-tar, 5 of

pulverized sulphur, 2 of pulverized alum, and 5 of powdered resin are added, and the mixture heated to 300° F. After having been cooled a substance is obtained which is equal in many respects to genuine ebony wood, but far less expensive, and capable of receiving a finer polish.

Leather, Soap, and Glue from Seaweeds (Algæ). The plants are dried and powdered, and extracted with warm water in a heated boiler, with or without the addition of alcohol, soda, milk of lime or other salt. The solution is allowed to settle at a temperature of 120° to 140° F. When cold it congeals to a jelly, which is used for various purposes.

1. *Transparent Sea-weed Leather* is obtained by pouring the jelly upon a plate and allowing it to dry out, after other substances and various quantities of alcohol, according to the thickness and desired pliability, have been added.

2. *Opaque Sea-weed Leather* is produced in the same manner, except the adding of substances which give to it greater power of resistance and the desired opacity and color. Both varieties may also be spread upon muslin, or paper, or other substances, whereby, in the first case, a substitute for gutta-percha, parchment, etc., is obtained, and, in the latter case, one for wall paper, book covers, etc.

3. *Sea-weed Soap.* In this soap the jelly takes the place of the fats or resins. According to the degree of concentration it can be obtained in soft or solid form, or as a powder. It is used for linen, cotton, silk, or wool.

4. *Sea-weed Glue* can advantageously be substituted for animal glue.

Artificial Stone for Sharpening Lead and Slate Pencils. Boil 1 part of linseed-oil varnish in 5 parts of glue dissolved in water, and add with constant stirring 1 part of cement dissolved in water, and sufficient fine sand or ground glass to make a plastic dough. This is spread upon curved blocks of wood as being better suited than flat surfaces for sharpening pencils.

To Convert Ordinary Agate into Onyx. Place the polished stones in a solution of iron in aqua-fortis. Then impregnate that part of the stone which is to be white or yellowish-white for

some length of time with a solution of caustic soda in water. The stones are then dried for about 8 days on the top of a stove, and finally burned in a closed earthen pot, when the coloring will make its appearance.

Substitute for Opaque Window Glass. Chardon recommends for this a layer of gelatine mixed with very finely powdered sulphate of baryta. For this purpose he mixes the two following solutions: *a.* 1.5 parts of hydrochlorate of baryta and 5 of gelatine in 100 of water; *b.* 2.15 parts of sulphate of baryta and 5 of gelatine in 100 of water. The chloride of sodium formed is removed by washing the gelatinous mass.

Porous Substance as a Substitute for Blotters. Mix 7 parts by weight of gypsum with 1 part by weight of potato-flour and pour the mass into a mould. After becoming hard the blotter is ready and may be used for years.

Flexible Mirrors capable of being bent into any desirable shape can be made by the following process: Coat paper or tissue with white of egg and apply several layers of transparent varnish to the thickness of mirror glass. Coat a sheet of tinfoil with several layers of varnish impervious to water, and, when dry, glue the tinfoil upon paper, tissue, wood, or any other substance. Spread mercury on the other side of the tinfoil, which forms an amalgam with the tin, upon which lay the varnished surface of the paper and subject them to a strong pressure as long as is necessary, and remove the paper by moistening the back with water, as this dissolves the white of egg and detaches the paper. The result of the operation will be an actual mirror, the beauty of which will of course largely depend upon the clearness and transparency of the varnish used. The mirror may be made in such a form as to fit the place it is to occupy, but this is not absolutely necessary, since the finished mirrors can be bent into any desired shape, the inventor, for this reason, having given them the name of *flexible mirrors*.

Beautiful effects can be produced by using colored mirrors, which can be readily produced in the same manner.

Artificial Whalebone for Umbrella and Parasol Ribs, Busks for Corsets, etc. Knead and soften 2 pounds of caoutchouc, then mix with it 8½ ounces of flowers of sulphur, 7 ounces of shellac, a like quantity of magnesia, and 8½ ounces of roll sulphur. The pieces formed from the mixture are heated in a furnace at 250° to 300° F.

Buffalo Skin as a Substitute for Horn. According to Rohn, buffalo skins can be softened by steam and pressed into any desired shape, and when dry resemble transparent horn, capable of being turned, ground, and polished. This prepared material is well adapted for pump pistons.

Substitute for Tinfoil. Make a thin paste with zinc dust and albumen, and spread it with a brush or roller upon cotton or linen tissue. When dry the albumen is coagulated by steam and the fabric immersed in a solution of chloride of tin. The tin is deposited in a fine powder on the zinc. Beautiful effects can be had by burnishing the whole or parts. Tissues thus prepared are a good water-proof substitute for tinfoil in many cases.

Zeidelite. The material known by this name is prepared as follows: Melt 19 parts of sulphur, and stir in 42 parts of pulverized fragments of stoneware or glass, and when thoroughly mixed pour into moulds. Sheets of this prepared material can be substituted for lead in the construction of sulphuric acid chambers, as they resist the action of the highest concentrated acids and, though the plates are ½ inch thick and lead plates only ¼ inch thick, their cost is but ¼ of the latter, and the sulphuric acid is entirely free from lead. They retain their solidity in boiling water, and do not melt under 250° F., making them a good substitute for asphaltum in many cases, and also for hydraulic cement for stone work.

To join the plates in constructing sulphuric acid chambers, they are set about 1 inch apart, and the joints filled in with melted zeidelite heated to 390° F.

Imitations of Mother-of-pearl and Marble with Glue. The following process, which is to a large extent based upon laboratory experiments, may be divided into 5 principal operations: 1.

Preparation of the plates; 2. Preparation of the glue solutions; 3. Pouring the colored glue solutions upon plates; 4. Transferring the layer of glue to a layer of gelatine; 5. Drying the veneers and detaching them from the plates.

1. *Preparation of the Plates.* Both marble and glass plates are used for imitations of marble, but only glass plates are employed for imitations of mother-of-pearl. The glass plates must be ground, but need not exceed $\frac{1}{8}$ to $\frac{1}{4}$ inch in thickness, and only require careful washing and drying for imitations of mother-of-pearl. For imitations of marble they should be rubbed with an oiled linen rag. Other glass plates, after being washed, are polished with pure colcothar and water, and wiped with a soft rag to remove any particles of the polishing powder. The polished surface is then gently rubbed with a rag dipped in pure Spanish chalk (soapstone), and the excess of chalk carefully dusted off.

2. *Preparation of the Glue Solution.* For 1 dozen plates, each 1 square yard, soak 2 pounds of good, colorless glue for 24 hours in water, pour off the water, and melt the glue in a water-bath, and stir in $3\frac{1}{2}$ ounces of glycerine. For imitating marble with 2 colors, compound 1 to $1\frac{1}{4}$ pints of this glue solution with the quantities of thoroughly ground mineral colors given below; the rest of the glue solution is mixed with $6\frac{1}{2}$ ounces of zinc white ground very fine. For imitating marble with 3 colors, mix $\frac{2}{3}$ pint of the glue solution with one coloring matter, and $\frac{2}{3}$ pint with the other coloring matter, and the remainder with zinc white. For imitating marble with 4 colors, take $\frac{1}{2}$ pint of the glue solution to each of the 3 coloring matters, and mix the rest with $4\frac{1}{2}$ ounces of zinc white.

The proportions by weight of the mixtures for 10 different varieties of imitations of marble and enamel, are as follows:

a. Mix 1 pint of glue solution with $1\frac{1}{2}$ ounces of colcothar and $2\frac{1}{2}$ ounces of zinc white, and the rest of the glue solution with $6\frac{1}{2}$ ounces of zinc white.

b. Mix 1 pint of glue solution with $1\frac{1}{2}$ ounces of colcothar, and the rest with $5\frac{1}{4}$ ounces of zinc white.

c. Mix $\frac{2}{3}$ pint of glue solution with $1\frac{1}{4}$ ounces of zinc white and 1 ounce of colcothar, $\frac{2}{3}$ pint of the glue solution with 1 ounce of yellow ochre, and the rest with $5\frac{1}{4}$ ounces of zinc white.

d. Mix $\frac{1}{2}$ pint of the glue solution with 1 ounce of colcothar, $\frac{2}{3}$ pint of the glue solution with $\frac{2}{3}$ ounce of sepia, and the rest with $5\frac{1}{4}$ ounces of zinc white.

e. Compound 1 pint of the glue solution with 1 ounce of quite concentrated and filtered solution of aniline black, and the rest with $6\frac{1}{4}$ ounces of zinc white.

f. Mix $\frac{1}{2}$ pint of the glue solution with $\frac{2}{3}$ ounce of colcothar, $\frac{1}{2}$ pint of the glue solution with $\frac{2}{3}$ ounce of yellow ochre, $\frac{1}{2}$ pint of the glue solution with $\frac{2}{3}$ ounce of sepia, and the rest with $4\frac{1}{2}$ ounces of zinc white.

g. Mix 1 pint of the glue solution with $1\frac{1}{2}$ ounces of lampblack. For gray add sufficient zinc white to produce the desired shade. The rest of the glue solution is mixed with $6\frac{1}{2}$ ounces of zinc white.

h. Mix $\frac{1}{2}$ pint of the glue solution with $\frac{2}{3}$ ounce of umber, $\frac{1}{2}$ pint of the glue solution with $\frac{2}{3}$ ounce of bole, $\frac{1}{2}$ pint of the glue solution with $\frac{2}{3}$ ounce of ochre, and the rest with $4\frac{1}{2}$ ounces of zinc white.

i. For *Enamels* mix 1 pint of the glue solution with 1 ounce of ultramarine, and the rest with 6 ounces of zinc white.

k. Mix 1 pint of the glue solution with $1\frac{1}{2}$ ounces of chrome green, and the rest with $6\frac{1}{4}$ ounces of zinc white.

For imitating *mother-of-pearl veneers* $\frac{1}{2}$ ounce of silver bronze, which need not be genuine, is ground with a little glue or water and intimately mixed with the above solution of glue. The bronze powder must not be in a dry state when stirred into the glue, as lumps would be formed and the veneers become spotted. In place of bronze, essence of fish scales, which is of course a great deal more costly, can be used. The solution of glue thus prepared is then compounded with different aniline colors, according to the coloring desired.

a. For preparing yellowish veneers the glue solution is used without an

addition of some coloring matter, or with an addition of some solution of picric acid.

b. For colorless veneers, or those of slightly reddish tints, a smaller or greater number of drops of a concentrated solution of fuchsine are added, which counteracts the yellowish tint of the glue. For these imitations of mother-of-pearl veneers a concentrated solution of gelatine compounded with 15 per cent. of glycerine can be employed, especially when essence of fish scales is used.

c. For *Blue* the glue solution is compounded with "*bleu de Lyons*," but the greatest care must be exercised not to use too much, as otherwise the imitation becomes indistinct. The right degree of coloring can be tested by allowing a few drops of the colored glue solution to fall upon a glass plate.

d. For *Red*, solution of fuchsine or carmine is used. The latter is obtained by dissolving commercial carmine powder in alcohol.

e. *Orange colors* are produced by an addition of a solution of vesuvine; *violet* by adding dahlia violet. For these, as well as for the solution colored with fuchsine, the plates must *not* be rubbed with oil, as even the smallest trace of oil discolors these colors in drying, or at least the veneers will show colorless spots. The different shades of gray are obtained by adding more or less of solution of aniline black which has been previously filtered.

3. *Pouring the Colored Glue Solutions upon the Plates.* For imitations of marble and enamel the glass plates, rubbed with oil, are placed in a horizontal position with the rubbed surface up. The proper portion of the white ground mass, after it has become somewhat thickish, is then poured upon the plates, and the gaps left free in pouring filled in and smoothed with an instrument resembling a knife made of horn or bone. Upon this white ground the respective colored solutions of glue are then poured in zigzag form, parallel veins, or spots, and, according to the desired design, drawn through the ground with a glass rod. If several differently colored glue solutions are to be applied, as given, for instance, under *2 f*, they should be poured out in quick

succession, so that the succeeding color runs into the preceding, or that a white strip or spot remains between each color. The whole is then intermingled with the glass rod according to the design. If the latter is to have sharply defined lines and spots, the respective glue solution is used somewhat thicker; but if, on the other hand, the design is to be somewhat blended, the glue solutions are used somewhat warmer. The plates, when the glue has become solid, are placed, until further treatment, in a cool place for 2 or 3 hours.

Imitations of *malachite* are prepared in a similar manner. Four glue solutions, with different shades of green to the lightest tint, are prepared, and these solutions poured upon a slightly greenish-colored ground in imitation of the curves and veins peculiar to malachite, and these curves and veins are then traced with a comb with teeth which stand at unequal distances from each other.

The glass plates set aside to be used for imitations of mother-of-pearl are now taken in hand. The glue solutions must be kept warm in a water-bath and thoroughly stirred every time before pouring them upon the plates, and the formation of a skin on the surface of the glue must be strictly avoided. For pouring out the solutions it is best to use a porcelain dish with a spout and a handle, and having a capacity of about 12 cubic inches. The portion of glue solution required for each plate (1½ fluid ounces) is now measured into the porcelain dish and, after allowing it to stand a little while, is poured upon the plate and uniformly distributed. The production of the mother-of-pearl design requires some skill and practice. A comb with teeth set ½ inch apart is used for the purpose. It is held in a somewhat oblique position, the teeth are gently pressed upon the glass plate, and with frequent turnings of the comb at a right angle cycloidal motion executed. The treatment is commenced from the front to the back edge of the plate, and when the glue begins to thicken on the edges, continued at the softer places until the desired design is produced. The places, after the glue has acquired the necessary degree of solidity, must not be retouched with the

comb. When all the plates have been treated in this manner they are then set aside in a cool place for 2 or 3 hours.

4. *Transferring the Layer of Glue to a Layer of Gelatine.* For each dozen of veneers soak $2\frac{1}{2}$ ounces of gelatine, and then melt them in a water-bath and add glycerine equal to 10 per cent. of the gelatine and let the mixture settle.

The glass plates treated with colcothar and Spanish chalk (soapstone) are now placed in a horizontal position; 1 gill of the gelatine solution is poured upon them and the gaps filled in by means of the glass rod. The front edge of the plate covered with the colored layers of glue is now, glue side down, laid exactly upon the front edge of the gelatine plate, while the back edge of the former is gradually lowered until the glue plate lies firmly upon the gelatine plate. We will here remark that the gelatine solution must only be cooled off so far that the glue will not melt on touching it; if it is cooler the veneers will be blistered. It must further be looked to that, before placing the first plate upon the gelatine plate, no gelatine escapes, but that any excess of the latter only runs off after the back edge of the first plate touches that of the latter.

The plates are now allowed to rest quietly until the gelatine is congealed, when they are removed to a cool place, where they remain 5 or 6 hours.

The imitations of mother-of-pearl are treated in the same manner with the exception that the gelatine solution is colored with the same coloring matter as the glue solution. For the colorless or yellowish veneers the gelatine solution is not colored.

After 6 hours the first glass plate is detached from the layer of glue by loosening the latter around the edge with a knife blade, and the plate gradually lifted off, commencing at one corner. With some care this is easily accomplished without detaching the gelatine layer.

5. *Drying and Detaching the Veneers.* The veneers, with the gelatine layers still adhering to the glass plates, are now dried. This is effected in a heated room, in which the veneers are ar-

ranged upon frames, so that they stand almost perpendicularly. The hot air enters near the ceiling of the room, while the moist air is sucked away near the floor. The temperature of the lowest zone, where the fresh plates are placed, should not exceed 68° F. The plates are moved higher up every day until, on the third or fourth day, they have become entirely dry. The veneers, before removing them from the room, must be tested in regard to their dryness. They are sufficiently dry when, on pressing the finger nail upon the glue, no impression is made.

The plates, after removal from the room, are allowed to cool off for at least 2 hours before the veneers are detached from the glass plates. The operation begins by detaching the gelatine layer on the edges with a very thin knife blade. The operator then takes hold of one corner of the veneer and draws it gradually and carefully from the glass plate. The edges of the veneers are then trimmed and they are ready for use.

If the veneers are to resist the action of water, mix with the solution of gelatine, compounded with glycerine, $\frac{1}{2}$ fluid ounce of a solution of 5 parts of chrome alum in 100 parts of water to every plate, and immerse the veneers for a short time after they have been detached from the first plate in a similar solution of chrome alum.

The veneers prepared by these methods can be used for various purposes in architecture and in the manufacture of furniture, also for coating columns, for inlaid work, etc. It is recommended to add some glycerine to the glue with which they are to be fastened to the articles, as this will prevent them from blistering and coming off.

Gelatine Foils are variously colored leaves of gelatine about as thick as a sheet of paper. Their production forms a special branch of industry in France and England, where large quantities of them are produced, either simply colored or painted with neat designs in gold or silver. If but one side of the foil is to be glossy, the solutions are poured upon a glass plate and dried, but if both sides are to be glossy they are dried between two glass plates.

The manufacture is quite simple. Al-

low pure gelatine to swell up in water, then pour off the water and dissolve the remaining jelly over the water-bath. Allow the solution to cool somewhat, and then add the coloring matter previously dissolved in water.

In place of pure gelatine a solution of ordinary bone glue may be used. Add to every 6 pounds of glue $\frac{1}{4}$ ounce of oxalic acid dissolved in water, which will clarify the solution. To make the foil more pliable add also $\frac{1}{2}$ pint of spirit of wine and $\frac{1}{4}$ ounce of rock candy, or a small quantity of glycerine.

For coloring the solutions it is best to use the aniline colors soluble in water; for red, fuchsine; for blue, *Bleu de Parme*; for violet, *Hofmann's violet*; for green, aldehyde green; for yellow, picric acid, and for the various shades mixtures of the above colors.

The gelatine solutions are poured upon ground-glass plates which have been previously cleansed with elutriated colcothar and rubbed with Spanish chalk. The foils become so smooth upon the glass side that they can be drawn off without much difficulty. In many respects their manufacture resembles that of "Imitation of Veneers," to which we refer the reader.

Gelatine foils are used for printing sacred images, visiting cards, and labels, for fancy articles, and in the manufacture of artificial flowers.

Sorel's Substitutes for Gutta-percha and Cioutchouc. I. Mix colophony 2 parts, pitch or asphaltum 2, rosin oil 8, calcium hydrate 6, water 3, alumina 10, and gutta-percha 12. Heat the colophony, pitch, and rosin oil in a boiler and stir until the resin and pitch are dissolved. Then stir the calcium hydrate into a thin paste with water, add it to the above mixture and heat the mass again, stirring constantly. When all are intimately mixed add the gutta-percha cut in small pieces. Then continue heating and stirring until the gutta-percha is liquefied, and then add the alumina previously pulverized and mixed with water. As soon as this is equally distributed in the mixture, remove the excess of water and bring the whole to the boiling point. If any more water separates remove it, then knead the composition with fresh water, and finally pass it through rollers. To

make the composition entirely water-proof, add 5 per cent. of stearic acid.

II. Pitch 8 parts, rosin oil 4, calcium hydrate 6, and gutta-percha 16.

III. Pitch 12 parts, calcium hydrate 6, gutta-percha 16.

IV. Coal-tar 12 parts, calcium hydrate 6, gutta-percha 16.

The above compositions are used for manufacturing water-proof articles, tubes, machine belts, water-proof boots and shoes, etc. If greater tenacity is to be imparted to the compositions add fibrous substances, as cotton, wool, hemp, etc.

To Give to Various Articles the Lustre of Mother-of-pearl. Take solution of copal 2 parts, sandarac 2, solution of dammar 4, rosin 1, and absolute alcohol 1. Mix the ingredients with $\frac{1}{2}$ their volume of oils of bergamot or rosemary, and reduce it by distillation to the consistency of castor-oil. By applying this varnish with a feather or brush to the surface of water, a beautiful iridescent film will be formed, which is laid on the articles to be made iridescent. The vessel filled with water, upon which the film is produced, must be as large or larger than the article to be coated. Add to the water about 5 per cent. of pure glue solution, and keep it at a temperature of about 70° F.

Substitute for Slate. Convert black slate into a fine powder, sift the powder and rub it with water upon a stone. When dry rub it again with the muller and then add to 8 parts of the slate-powder 1 part of lampblack, mix thoroughly with glue water, and boil the whole over a moderate fire. Then apply a thin and uniform layer of the composition to bristol-board or thick paper, let it dry, and repeat the process until the coat has the proper thickness; then pumice it and finally apply a coat of infusion of gall-nuts.

Bertolio's Substitute for Meerschaum. Cut carbonate of magnesia in small pieces, place them for a few days in a hot solution of silicate of potash, and then dry them. Repeat this operation several times, using in place of silicate of potash, fresh, hot solution of water-glass, and finally expose the pieces to the air for a few months. Pieces treated in this way will become hard enough in 6 to 7 months to be worked, and are

a close imitation of the genuine meerschäum.

To Prepare Ratan to be used in the Manufacture of Corsets. Ratan is much used as a substitute for whalebone in the manufacture of corsets. To prevent the material from staining the corset when washed, boil the ribs before inserting them in a solution of 1 part of calcium chloride in 30 of water for $\frac{1}{2}$ hour, stirring constantly. Then add 1 part of alum, boil again with constant stirring for $\frac{1}{2}$ hour, and then wash and rewash them in water, and finally bleach them in the sun.

Composition for Cane Heads, Gun and Pistol Stocks, etc. To 2 pounds of caoutchouc, previously soaked and kneaded, add 1 pound each of magnesia, coal-tar, and roll sulphur, and $8\frac{3}{4}$ ounces of flowers of sulphur. Press the mixture in moulds and heat to 250° to 265° F.

Sören-Sörensen's Imitations of Leather are prepared from waste of caoutchouc and leather. The leather waste is freed from all foreign substances and then converted by machinery into a homogeneous fibrous material. By treating this with ammoniacal liquor a gelatinous compound is formed which, after pressing in moulds or rolled out in plates, gives a very hard and stiff product of considerable cohesiveness but without elasticity, and soluble in water. To make the material elastic and capable of resisting the action of water it is mixed with caoutchouc. The latter is washed, dried, then cut up in small pieces and dissolved in oil of turpentine or other suitable solvent. The leather treated with ammoniacal liquor and the solution of caoutchouc are mixed, the mixture made homogeneous by kneading, and the product pressed in moulds or rolled into plates. The proportions depend on the kind of material to be produced. Thus:

For Soles. Twenty-five parts of solid caoutchouc, 67 of leather waste, and 67 of ammoniacal liquor.

For Heels. Twenty-five parts of solid caoutchouc, 80 of leather waste, and 80 of ammoniacal liquor.

For Insoles. Twenty-five parts of solid caoutchouc, 90 of leather waste, and 75 of ammoniacal liquor.

Imitation of Marble for Plastic Or-

naments and Picture Frames. Boil $1\frac{1}{2}$ pounds of good glue into a thick solution, stir into it 10 ounces of rosin or, still better, Venetian turpentine. Mix finely-ground mineral color in a dry state with powdered French chalk to the color of the marble to be imitated, and stir enough of it into the above glue solution to make a stiff paste, and then add a few drops of pure olive oil. Press the mass in stone or gypsum moulds, or roll into thin plates. Cut the plates to the desired patterns, glue them on, and allow them to dry. The mass becomes hard as stone. Any porous places which may be found are filled in with the same composition diluted, and the whole is finally coated with natural or white polish. By wrapping the composition in a damp linen cloth, it can be kept for a long time. When it is to be used, place it in a pot heated by steam, when it will become again plastic. Imitations of marbles of 2 or more colors can be produced by mixing differently colored compositions together.

To Dye Hard-wood Shell Buttons. Sort the buttons, selecting the whitest for light fancy colors and the more yellowish and yellow ones for brown and black. Then cleanse the buttons thoroughly by washing with hot water, and mordant them with acetate of iron, copper, or lead, or aluminium. They are then dyed.

Coal Black. Dissolve by boiling 10 pounds of extract of logwood in 25 gallons of water, place the buttons in the bath, and work them in it for $\frac{1}{2}$ hour at 190° F. Then take them out, place them in a bath of iron liquor, work them $\frac{1}{2}$ hour, expose to the air for 2 to 3 hours, then bring them in a bath consisting of 2 ounces of potassium chromate and 6 gallons of water, and finally rinse them thoroughly with water.

Brown. Dissolve $5\frac{1}{2}$ pounds of prepared catechu in 2 gallons of water, and when the solution is clear, add to every gallon of it 6 gallons of water, heat the mixture in a boiler to 100° F., throw the buttons in, and heat the bath for $\frac{1}{2}$ hour to 190° F., stirring constantly. Then allow them to cool, work them for $\frac{1}{2}$ hour in a bath of $8\frac{3}{4}$ ounces of potassium chromate dissolved in 6 gallons of water, and finally rinse them thoroughly with water.

Dark Brown. Add more or less of logwood liquor of 4° B.

Gray and Fancy Colors. Boil 10 pounds of gall-nuts converted into a coarse powder or sumach, with 8 gallons of water, and pour 3 quarts of this infusion into the dye boiler and add 1½ gallons of water. Heat the bath to 120° to 145° F., stir the buttons in it for ½ hour, and then place them in a bath of iron liquor of 4° B. for 20 to 30 minutes. After taking them from the bath spread them out in the air. By treating the buttons with the different mordants mentioned above, and adding a little liquor of logwood, Brazil wood, fustic, or other liquors, all possible fancy colors can be produced.

Olive Colors are produced by dyeing with a strong infusion of quercitron with a mordant of alum, then passing them through a strong iron mordant, and finally again through the dye bath. For producing *shell colors*, place 5 to 6 dozens of buttons flat upon a board and sprinkle them with spirit lacquer by means of a watering-pot. When the lacquer is dry, dye the buttons in the manner indicated above, but the temperature of the bath must not exceed 95° to 110° F., since at a higher temperature the lacquer would dissolve. When dyed, bring the buttons in a warm soda bath, which dissolves the lacquer, and the places formerly covered by it will appear white upon a colored ground. In this manner any design can be executed in all colors.

For Coloring with Aniline Colors, place the buttons first in a mordant consisting of a solution of 1 ounce of tannin in 6½ gallons of hot water, allow them to remain for ½ hour, and then bring them into the aniline dye-bath, heated to 120° to 145° F.

Blue. Use aniline blue soluble in water.

Red. Fuchsine.

Scarlet. Fuchsine or, better, saffronine after the buttons have been dyed pale yellow with fustic and tin mordant.

Green. Use methyl or malachite green, with an addition of fustic liquor or picric acid if more or less yellowish-green colors are to be produced. The buttons dyed with aniline colors need not be rinsed with water. They are then thor-

oughly dried in a warm place, and finally polished in a drum with chalk and bore chips.

INDIGO, INDIGOTINE, AND ALIZARINE.

Crystallized Indigo. In preparing this the oxidation of sugar is made use of in the following manner: Place in a suitable small flask, with a well-ground stopper, ½ ounce of finely-pulverized indigo, 1½ ounces of a strongly concentrated solution of caustic soda in spirit of wine; then fill the flask with boiling spirit of wine 0.880 specific gravity, previously saturated with glucose or honey. Shake the mixture thoroughly and let it rest. Then draw off the supernatant clear fluid with a siphon into an open glass vessel and expose it to the action of atmospheric air. The change of color which takes place is remarkable and interesting. A precipitate of pure indigo is formed which is at first red, then becomes violet, and finally is transformed into blue. This, after filtering and washing with spirit of wine and hot water, is dried, and yields about ¼ of 1 per cent. of crystallized indigo blue. By this process the foreign substances remain either undissolved, or, if dissolved, remain in solution while the indigo is precipitated.

Indigo-carmine. Place in a porcelain or earthen pot 1 part of best indigo, finely pulverized, and 1 part each of fuming and ordinary sulphuric acid, and stir constantly to avoid too strong heating. Then cover the vessel and let it stand for 24 hours. When all the indigo has been dissolved, which may be recognized by a drop taken from the pot and thrown into a glassful of water, coloring the latter blue without forming a precipitate, pour the solution into water, dilute it to 18° B., filter and precipitate the indigo-carmine with carbonate of potash or soda; collect the precipitate upon a filter of wool or felt and let it drain off. Pure blue-carmine is soluble in pure water, but not in water containing salt.

Acetate of Indigo. Dissolve 1 pound of indigo in sulphuric acid, mix the solution with ½ gallon of water, then add a solution of 7½ pounds of sugar of

lead, stir thoroughly, add $\frac{1}{2}$ pound of quicklime slaked in 1 quart of water, filter when cold, and wash. The addition of lime removes the free sulphuric acid from the mixture, which is too strong for many fabrics, especially fine cotton goods.

Indigo-violet. Indigo gives a beautiful pure violet color by mixing 1 part of pure indigo with 5 of sulphuric acid and heating the mixture from 88° to 100° F. Dilute the resulting fluid with 10 parts of water, and by filtering it the violet-indigo will remain upon the filter. By washing this with a concentrated solution of carbonate of soda a durable and beautiful violet color is obtained, while a dirty, greenish fluid runs off.

all parts are subjected to an equal temperature, which would not be the case if steam was only conducted into the cylinder containing the garancine.

The steam passes from the boiler through a cast-iron pipe placed in a furnace, and before coming in contact with the garancine is conducted through a globular reservoir divided into 2 parts by a perforated division and provided with a thermometer. On the steam-pipe are placed cocks, by means of which the progress of the operation is regulated and, what sometimes may be come necessary, the steam conducted directly to the product. Some alizarine is carried away with the condensed water, which can be used in dyeing.

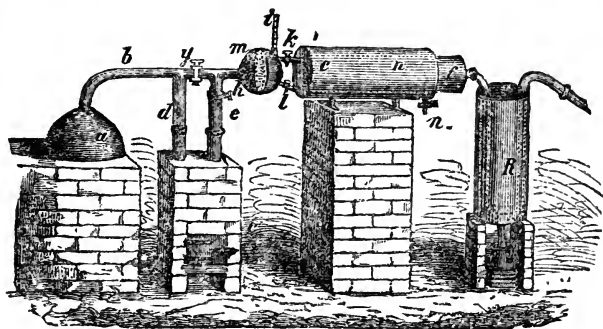

Fig. 27.

Indigo-carminé in the Form of Extract. Pour 4 parts of concentrated sulphuric acid over 1 of the best dry indigo finely pulverized, stirring constantly; let the mixture stand for 24 hours, dilute with water, and filter through a flannel cloth. Precipitate the blue fluid with 4 parts of common salt and collect the precipitate.

Kopp's Process of Gaining Indigotine and Alizarine. By treating madder with sulphuric acid garancine is produced. This is used for the production of alizarine. It need not be as carefully washed as when used for dyeing. The garancine is placed in a metal cylinder surrounded by another cylinder into which superheated steam is conducted, while ordinary steam is passed through the garancine. By these means

By this process the alizarine is not gained in prisms but in grains. Indigo, when heated, volatilizes in purple vapors condensing in prisms having a deep blue color with a purple lustre. This is the *indigotine*. Indigotine can also be obtained synthetically by heating the syrupy modification of methyl nitro-phenyl ketone until it is converted into a solid mass, which, when carefully heated with soda lime and zinc dust, yields a small quantity of indigotine.

The Apparatus. Fig. 27 represents Kopp's apparatus for preparing indigotine and alizarine. *a* is the steam-boiler, *b* the steam-pipe, *c* the furnace for superheating the steam, which passes into the furnace from the pipe *b* through the pipe *d*, and passes out through the pipe *e*. *g h* are cocks for regulating the

current of steam. When the cock *g* is closed and the cock *h* open, the steam passes from the boiler into the superheating apparatus and acquires there a temperature of 570° to 660° F., but, when the cock *g* is open and *h* closed, passes directly to the chambers *m*, and finally, when both cocks are half open, half of the steam is superheated while the other half remains in the ordinary condition, and both enter the chamber *m*, where they mix. The globular cast-iron chamber *m* is divided into 2 parts by a perforated division indicated in the illustration. The object of this is to mix the superheated and ordinary steam. In one of the partitions of the chamber is placed a thermometer, *i*, which indicates the temperature of the mixed steam. The pipes must be all covered with non-conductors. The copper cylinder *f* contains the dry garancine in pieces as large as a nut, and is placed between 2 partitions. It communicates with the chamber *m* by a pipe provided with the cock *k*. *n* is a cylinder surrounding the cylinder *f* and connected with the chamber *m* by a pipe provided with the cock *l*, through which the steam is introduced into the cylinder *f*. The excess of steam is conveyed into the open air through a pipe provided with the cock *n*. *R* is the cooling apparatus into which pass the products of distillation through the pipe *p*, which communicates with the cylinder *f*.

The Operation. After the furnace for superheating the steam has acquired a temperature of 660° F., and the cylinder *f* has been filled with garancine, superheated steam, the temperature of which is gradually raised to 356° F., is allowed to circulate in the cylinder *n*. The cylinder *f* and the garancine soon acquire both a uniform temperature, when by opening the cock *k* the superheated steam is admitted to this cylinder. The temperature of the steam is then raised to 392° F., next to 445° F., and finally to 465° F. The sublimation and distillation of the alizarine commences at 390° F. It volatilizes in orange-yellow vapors condensing to a powder of the same color. The cooling apparatus may be divided in 2 parts, 1 of which is kept at a temperature of nearly 212° F., while the other is entirely cooled off. The greatest part

of the alizarine condenses in the first. When distillation is finished the alizarine is collected upon a filter.

The property of alizarine to form insoluble colored metallic compounds is made use of in dyeing and printing. To produce madder colors on calico the desired pattern is printed on the cloth as mordant. For pinks and reds a solution of aluminium acetate which is thickened with gum or starch is used, and for purples and blacks, ferrous acetate (iron liquor) is employed, while a mixture of the 2 salts produces brown or chocolate colors. The mordanted cloth is next hung up in a warm, airy room, whereby the acetic acid is expelled and the oxides are fixed in the fibre. The cloth is now brought into the dye-bath, consisting of boiling water and old ground madder root; the alizarine is gradually dissolved and absorbed by the oxides.

Artificial Alizarine is chiefly used for "topical" printing; for this purpose it is printed together with the mordant on the cloth, which is then steamed or heated to 212° F.; the alizarine dissolves in the free acetic acid, which soon volatilizes, while the alizarine combines with the oxides. The colors thus produced are more brilliant than those obtained by dyeing with madder.

As artificial alizarine is now brought into commerce in a pure state, and in a paste of 10 per cent. concentration, we give in the following a few receipts for printing colors based upon a 10 per cent. paste of alizarine, which have been tested and given excellent results:

Dark Red. Alizarine 5½ pounds, inspissation (see below) 17½ pounds, aluminium acetate of 10° B. 1 pound, calcium acetate of 16° B. 8¾ ounces.

Rose Color is obtained by brightening the above with the inspissation for red. Articles, the first print on which is dark red, must, before smoothing, be steamed for 1 hour. After over printing they are again steamed for 1 hour, hung up for 24 hours, and then drawn for 1 to 1½ minutes through one of the following baths: Water 220 gallons, chalk 66 pounds, tin salt 3½ pounds. Or, water 264 gallons, chalk 44 pounds, and sodium arseniate 11 pounds. The bath should have a temperature of 120° to 145° F. The pieces are then washed

and brightened. For 10 pieces of 50 yards: 1. Soap: 3 pounds of soap, 4 ounces of tin salt at 122° F. for $\frac{1}{2}$ hour. 2. Soap: 3 pounds of soap without tin salt at 167° F. for $\frac{1}{2}$ hour. 3. Soap: 3 pounds of soap without tin salt at 167° to 176° F. for $\frac{1}{2}$ hour. The fabrics, after passing through 1 soap bath, must be washed before placing them in the next.

Inspissation for Red. Boil thoroughly 13 pounds of wheat starch, 5 gallons of water, 3 quarts of acetic acid of 6° B., 2½ gallons of gum tragacanth mucilage, and 3 pounds of olive oil.

The gum tragacanth mucilage is prepared by dissolving 10 ounces of the gum to every gallon of water.

Aluminium Acetate. Mix 3 pounds of aluminium hydrate with 1½ gallons of acetic acid, heat the mixture and filter, and dilute it afterwards to any desired degree.

Aluminium Hydrate. Dissolve 80 pounds of alum in 100 gallons of water and precipitate it with a solution of 68 pounds of soda in 100 gallons of water. Wash the precipitate 8 times by decantation, then collect it upon a filter and finally press it out. A 10 per cent. paste generally requires an addition of 20 per cent. of its weight of aluminium acetate of 12° B.

Solution of Calcium Acetate of 16° B. contains 25 per cent. of calcium acetate. For alizarine paste thoroughly washed out, 10 per cent. of its weight of the solution will be required, but it is advisable to ascertain by a test the necessary addition of calcium acetate to every portion of alizarine.

Printing Colors for Red and Violet Articles by using a Paste containing 10 per cent. of dry Dyestuff. Eight and three-fourth pounds of alizarine, 2 gallons of inspissation (see above), 10 ounces of aluminium nitrate of 15° B., 1½ pounds of aluminium acetate of 10° B., and 14 ounces of calcium acetate of 10° B.

Very Dark Red. Ten pounds of alizarine, 2 gallons of inspissation (see above), 14 ounces of aluminium nitrate of 15° B., 1½ pounds of aluminium acetate of 10° B., and 1 pound of calcium acetate of 16° B.

Aluminium Nitrate. Three and a half ounces of lead nitrate, 2 pounds of

alum, and $\frac{1}{2}$ gallon of water. By using aluminium nitrate the red becomes more yellow than when aluminium acetate is employed, the former requiring also more calcium acetate than the latter.

Another Red without Oil. Boil thoroughly alizarine 9½ pounds, acetic acid of 8° B. 10½ pounds, flour 4 pounds, water $\frac{1}{2}$ gallon; stir until cold and then add calcium acetate of 16° B. 17 ounces, aluminium nitrate 2 pounds, and calcium hyposulphite of 9° B. 3 pounds.

Violet Printing Color. Alizarine 3 pounds, inspissation (see below) 2½ gallons, methyl acetate of iron of 12° B. 7 ounces, and calcium acetate of 16° B. 13 ounces.

Violet Inspissation. Boil thoroughly 10 pounds of starch, 4 gallons of water, 2 gallons of mucilage of gum tragacanth, 2½ ounces of gum to every quart of water, 2½ quarts of acetic acid of 6° B., and 2 pounds of olive oil, and stir until cold.

The printed fabric is steamed for 1 to 2 hours at a pressure of half an atmosphere and hung up for 24 to 36 hours. It is then passed for 1½ to 2 hours through the following bath at a temperature of 120° to 145° F.: Water 220 gallons, chalk 44 pounds, sodium arseniate 11 pounds. It is then washed and soaped at 145° to 167° F. for 1 hour, with 3½ pounds of soap for every 10 pieces, each 50 yards long. It is then washed, dried, and finally, if necessary, slightly chloridated.

Geitner's Alizarine Liquor. Pour over $\frac{1}{2}$ part of madder root cut up in a matrass, 6 parts of alcohol of 94 per cent., and let it digest for 24 hours at an ordinary temperature, shaking it frequently. By filtering through blotting-paper a clear brownish-yellow tincture is obtained which is known as "*Alizarine Liquor.*"

INKS. LITHOGRAPHIC, PRINTING AND WRITING.

Good printing-ink possesses the following properties: A homogeneous mass of a glossy black color, unchanged by exposure for a considerable time to the air, and quickly drying after print-

ing; of a consistency sufficient to prevent its penetrating too deep into the paper to blur the appearance of printing on the other side. Linseed oil is the principal ingredient in the manufacture of printing-ink. The oil should be of good quality, as an inferior article gives a bad smell and rusty shade of color. The oil is refined by being mixed with a small percentage of concentrated sulphuric acid and heated for a few hours at a temperature not exceeding 212° F., and allowed to settle, after which it is drawn off from the sulphuric acid and repeatedly washed with warm water until every trace of the acid is removed. The oil, if treated in the right manner, should have a light yellow color and be entirely free from smell. It must be protected from the air, as in this condition it will dry very quickly.

The refined oil is then heated to such a degree that a part of it becomes decomposed. Specially constructed vessels must be used for this purpose, as the volume of the oil increases in an extraordinary degree in consequence of the many bubbles which are formed. The most suitable apparatus used for this purpose is represented in Fig. 28. It consists of a cylinder of sheet iron. A rim bent upwards like a shell is placed about half way up on the sides of the cylinder. The top of the cylinder is surrounded by a strong iron ring on which are fastened the chains of a tackle which enables the attendants to lift the cylinder quickly from the fire-place. A helmet or cover of sheet iron, fitting as air-tight as possible, completes the apparatus, which should be erected in a fire-proof room. A flue connected with a well-drawing chimney is placed in the roof of the building to carry off the injurious vapors arising from the boiling linseed oil. The workman should be provided with a stool high enough to enable him conveniently to take samples out of the cylinder. The chains of the tackle are fastened to a movable crane so that at the word of command an assistant can lift the cylinder immediately from the fire and move it aside. The cylinder is filled only half full with oil, a strong fire being kept under it at the commencement of the work. The oil will

soon commence to bubble, making a crackling noise. This is caused by the

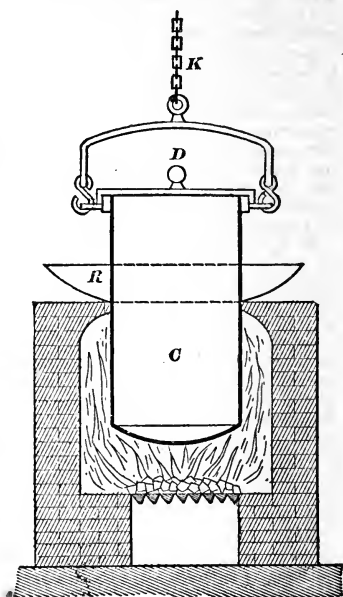

Fig. 28.

escape of water vapors which are developed from the oil, and originate from water mixed mechanically with it. It ceases in a short time, and as the temperature rises, the oil, having now become entirely black, swims quietly and uniformly in the cylinder.

From this moment on the oil rises constantly in the cylinder, and throws out small bubbles where it comes in contact with the walls of the cylinder. As soon as vapors of a pungent odor commence to rise from the oil, the attendant must observe the strictest vigilance. The moment the entire mass of the oil commences to bubble up, and vapors are also evolved from the interior, the fire must be quickly moderated or the fluid will surely boil over, be the vessel never so capacious. If the oil should continue to rise notwithstanding the fire having been moder-

ated, the cylinder must at once be lifted from the hearth, and only replaced when the oil has subsided.

The best plan is to keep the oil at such a temperature that the developed vapors ignite on coming in contact with a lighted candle, but will go out when the flame is removed, or can be at least easily extinguished by placing the cover upon the cylinder. The firing is then regulated in such a manner that the vapors will be developed quietly and uniformly without a further rising of the contents, and the condition of the oil is tested by the "thread-test."

To make this test, a small quantity of the oil is taken from the cylinder with a wooden spatula. This is cooled off by swinging it to and fro, and a drop of it is then squeezed between the fingers and drawn out. In doing this a viscid thread $1\frac{1}{2}$ to 2 inches long before breaking should be formed from one finger to the other. If the thread breaks before reaching that length, the boiling must be continued. If the sample is of the requisite quality, the cylinder is at once lifted from the fire and the varnish allowed to cool off; or it is subjected to what is technically called "burning." This consists in igniting the vapors and allowing the varnish to burn for about five minutes, when the fire is extinguished by placing the cover upon the cylinder.

Burning the varnish makes it very dark. This, of course, is of no consequence when it is to be used for black printing-ink, but it is best to omit the burning if the varnish is to be used for colored inks; in fact, for delicate shades of color, burned varnish cannot be at all used.

Hemp oil being much cheaper than linseed oil is sometimes used in place of the latter. It produces a tolerably good ink, but the disagreeable odor of the oil adheres to it, and for this reason varnish prepared with this oil should never be used for fine colors.

The consistency of a printing-ink depends upon the purpose for which it is to be used; the more elegant the printing is to be, the more the varnish must be boiled down, and the greater will be the expense of producing the ink. For newspapers and, generally speaking, for matter which must be printed

quickly, a more fluid varnish is used than for printing books. The thickest varnish is used for copper plate and lithographic printing.

Sometimes rosin is added to the varnish so that it will not be required to be boiled down so much. It is best to use the ordinary, pure, brown pine rosin for black printing-ink, but the light-colored American rosin is more suitable for printing colors. The rosin should be refined by melting and filtering to prevent pebbles or plant-parts, frequently mixed with the rosin, from getting into the varnish. The rosin is added to the oil when the latter has been heated so far that its boiling is plainly noticeable on the edge of the cylinder. For 120 parts of linseed oil, 40 to 50 of rosin, and also 12 to 14 of soap, are used. The purpose in adding soap is to facilitate the cleansing of the forms, which then can be accomplished by washing them with a brush. The scap to be used must be entirely dry. Yellow rosin soap answers for ordinary printing-ink, but white tallow soap must be used for fine colors.

For black printing-ink, lampblack prepared in a special apparatus is generally used; for printing colors the varicous mineral and lac colors. All substances used for coloring must be rubbed very fine and the coloring matter mixed with the varnish in the most careful manner, so as to obtain an absolutely uniform color.

We give a number of receipts for preparing printing-inks.

I. Mix between rollers 16 pounds of prepared linseed oil, 3 ounces of pulverized indigo, or a like quantity of Berlin blue, and 8 pounds of finest lampblack. The linseed oil is used hot.

II. Dissolve a small quantity of black rosin or melted amber in 30 parts of old linseed oil; boil it to a thick lacquer and let it cool. Allow the mixture to stand for a few months for the impurities to settle, and then mix it with at least 15 parts of fined lampblack, and grind the whole fine in a suitable mill.

III. Boil down 100 parts of old linseed oil or nut oil to the consistency of syrup; then, in order to clean it from impurities, add 2 parts of bread and a

few onions, and ignite the compound several times, so that it is reduced to $\frac{1}{2}$ of its weight. Now boil 30 to 35 parts of turpentine until a sample taken from the boiler and placed upon paper appears, when cold, clear, and breaks off without crumbling. Then mix both the fluids, which should be cold and of the consistency of syrup, boil up once more, add the necessary quantity of lampblack, and grind the whole.

IV. Rub fine upon a marble slab 10 ounces of rosin, 3 ounces of lampblack, $\frac{1}{2}$ ounce of Berlin blue, a like quantity of indigo, $\frac{1}{4}$ ounce of indigored, and a like quantity of dry, yellow rosin soap.

V. Melt together, with constant stirring, 1 pound of rosin oil, 13 ounces of rosin, and 3 ounces of soft yellow soap, until a homogeneous mixture is formed. The consistency is regulated by an addition of rosin oil. Lampblack and other coloring substances are added after the varnish is cold.

VI. The heavy tar oil remaining in the manufacture of anthracene is boiled with about 10 per cent. of chloride of copper. The oil assumes a black-brown color, and requires then but a small quantity (about 2 per cent.) of aniline-violet sebate.

Printing-ink from Coal-tar. Heat coal-tar with 6 to 15 per cent. of colophony and 10 per cent. of paraffine oil. Treat the varnish with chloride of soda or chloride of lime and hydrochloric acid, to remove the odor of the tar and paraffine oil. Heat the purified varnish and compound it with 20 to 25 per cent. of glycerine and 18 per cent. of lampblack, and then grind.

By another process the coal-tar is heated with sulphuric acid, the mass neutralized with soda, and then treated with chlorine. The varnish is boiled with $2\frac{1}{2}$ to 3 per cent. of lard and 4 to 5 per cent. of glycerine, or in place of the latter, with 8 to 10 per cent. of soap, when it is filtered and rubbed up with $\frac{1}{10}$ to $\frac{1}{16}$ pound of lampblack. For finer colors a dark aniline color is dissolved in the glycerine, or 2 to 5 per cent. of extract of logwood, besides chromate of potash, alum, or tartar is added to the varnish.

Thick Printer's Varnish with Coal-

tar Varnish Oil. Boil 55 pounds of linseed oil with $6\frac{1}{2}$ pounds of fine litharge until the oil, on cooling, thickens; then allow it to settle quietly. Now melt 22 pounds of light American rosin, add it to the thick linseed-oil varnish, and continue boiling for some time, and finally add 11 pounds of coal-tar varnish oil, continue heating for some time and then stir until cold. The varnish should be thickly fluid and of the consistency of honey.

Fine Printer's-ink with Coal-tar Varnish Oil. Rub 22 pounds of semi-calcined lampblack very fine upon a stone slab, and add gradually some rectified spirit of turpentine until a thick paste is formed; continue rubbing until the compound acquires a gloss. Now rub 22 pounds more of semi-calcined lampblack to the same consistency but with an addition of coal-tar varnish oil, and intimately mix both compounds. Then rub upon a stone slab $4\frac{1}{2}$ pounds of Parisian blue, add $8\frac{1}{2}$ ounces of dryer, then the above mixture of lampblack, and mix all together.

This printing-ink is specially adapted for fine lithographic work, cards, and artistic printing.

Black Printing Colors patented in Germany are prepared from 45 parts of anthracene oil (green oil) previously boiled with 5 per cent. of chloride of copper, 40 parts of pitch or asphaltum, 12 parts of soft soap, 5 to 8 parts of train oil, and 3 to 15 parts of aniline colors soluble in alcohol. To remove the unpleasant smell of the anthracene oil treat it at a temperature of above 212° F. with nitric acid.

New Process of Preparing Printing-inks. In place of linseed-oil varnish solutions of 40 to 50 parts of rosin or other resins in 25 of paraffine oil are used.

Printing and Stamping Ink containing Iron. Add to inks prepared from linseed-oil varnish, combinations of ferric or ferrous oxides or metallic iron. These form an intimate combination with the cellulose and sizing of the paper, in which, even if the black of the ink is entirely destroyed for fraudulent purposes, the iron can be accurately pointed out.

Bronze Color for Direct Printing

upon Paper, Oil-cloth, etc. The gold and silver designs on wall papers, oil-cloth, etc., were formerly produced by applying gold leaf or silver leaf to the design, printed with thick linseed-oil varnish, or some other agglutinant, or dusting it with bronze powder. In the new process the bronze powder is mixed with the agglutinant and printed directly upon the paper. Water-glass is an excellent agglutinant for this purpose. By rubbing up 1 part by weight of bronze powder with 2 parts by weight of water-glass, a printing color is obtained, which, on being applied to the blocks or rollers, can be at once transferred to paper, oil-cloth, or tissue, and wood or metal surfaces. The bronze print prepared in this manner dries very quick, cannot be removed by water or oil (if not boiling), and is insensible to heat and light. If, in printing, the bronze color dries too quickly, dilute it with 10 to 12 per cent. of water, or 5 to 10 per cent. of sugar syrup, the latter giving, besides, more body to the color.

Black Printing-ink which may also be used as Etching Ground. Heat and mix intimately 40 parts of pitch or asphaltum, 28 of rectified tar oil, 8 of aniline-violet sebate, 24 of residue of the distillation of black rosin oil.

Preparation of Tannin Black and its Use for Printing-ink and other Purposes. Chips and all kinds of waste of leather, animal waste containing glue and gelatine, and substances containing tannic acid serve as raw material in manufacturing tannin black.

I. One thousand pounds of the material are heated with about 350 gallons of water. After the liquid is drawn off, water is again poured upon the mass. About 50 pounds of caustic soda are then added, the whole is boiled for a few hours, and the liquid then drawn off and added to the first liquid, to which 90 pounds of sulphate of iron have been added. After the second liquid has been added, 30 pounds more of sulphate of iron with some alum are added to complete precipitation. The mass, after being sufficiently stirred, is then filtered. To prevent subsequent moulding 3 gallons of heavy tar oil are added to each of the liquids drawn off.

II. According to another process, the

same proportions of material and water are brought into a steam boiler, and 30 pounds of caustic soda and 3 gallons of heavy tar oil added. The whole is evaporated for a few hours and then drawn off into a pan. Here the same quantity of sulphate of iron as given in I. is added, with 350 gallons of water, 40 pounds of caustic soda, and 3 gallons of tar oil. The whole is then boiled, the fluid drawn off, 30 pounds of sulphate of iron are added, and the precipitate treated as above. For printing-ink, the black, to which some prussiate of potash, or some decoction of logwood has been previously added, is evaporated to $\frac{1}{2}$ its weight, and then mixed with linseed-oil varnish. For shoe-blackening the black is mixed with rosin soap and decomposed with hydrochloric acid, and then syrup, sugar waste, chloride of potash, non-drying oil, and crude glycerine are added in suitable proportions.

Lithographic Inks. I. Melt 10 ounces of wax, 8 ounces of shellac, 5 ounces of mastic, 4 ounces each of pure tallow and hard tallow soap, and $\frac{1}{2}$ ounce of Venetian turpentine, and mix with this $2\frac{1}{2}$ ounces of lampblack. This ink is rubbed up with water like water-colors and forms an emulsion.

II. consists of a mixture of 2 ounces of suet, $3\frac{1}{2}$ ounces each of white wax and of soap, $\frac{1}{2}$ ounce of shellac, $1\frac{3}{4}$ ounces of mastic, $\frac{1}{2}$ ounce of butter, and $\frac{1}{4}$ ounce of caoutchouc dissolved in oil of lavender, and $1\frac{1}{2}$ ounces of lampblack.

The solid ingredients are triturated and melted, the solution of caoutchouc is then carefully added, the mass being constantly stirred. It is then ignited and allowed to burn for 2 minutes, when it is extinguished by placing the lid upon the vessel containing it. It is then mixed with the lampblack by rubbing on a stone, again melted and poured out, and allowed to become cold.

III. Heat 40 parts of yellow wax until the vapors emitted become ignited. Then take it from the fire and add gradually 10 parts of mastic, 28 of gum lac, and 22 of Castile soap, and mix it with 9 parts of lampblack; then ignite the compound, remove it from the fire, extinguish the flame, pour the mass upon a stone, and, when cold, divide it into disks.

IV. Another kind consists of 3 parts of shellac, 4 of soap, 6 of white wax, 2 of tallow, and 6 of a strong solution of sandarac, and sufficient lampblack to color the mixture black.

Autographic Ink consists of 10 parts of dry soap, 10 of wax, 5 each of shellac and mastic, and 3 each of mutton tallow and fine lampblack.

Lithographic Printing-ink is prepared by melting together 8 parts each of tallow, soap, and wax, 6 of shellac, and 4 of mastic, and adding the necessary lampblack. It is used to make imprints upon paper from engraved plates, which are then transferred to the lithographic stones.

English Lithographic Ink. Pulverize and mix together 12 parts of shellac, 8 of mastic, and melt in 1 of Venetian turpentine. Remove the vessel from the fire, add 16 parts of wax and 6 of tallow, and when they are melted add 6 parts of hard tallow soap cut into shavings, and 11 parts of lampblack.

The mass, after having been intimately mixed by boiling, is allowed to cool off somewhat, and is then, while still in a liquid state, poured upon a marble slab, and, when cold, cut into square pieces.

The principal property of a good lithographic ink is that it does not penetrate into the stone, so that the most delicate lines of a drawing will stand a great number of impressions. It must therefore be capable of resisting the acid, with which the stone is prepared, to such a degree that not even the smallest particle of the fatty substances is attacked by it.

Writing-ink. Although there is perhaps no other chemical preparation in such general use as writing-ink, but few inks answer all requirements. This may be explained by the circumstance that receipts for ink cannot be calculated according to a chemical formula, but largely depend on experiments, and that we are forced to use the collected results of such experiments. A good black writing-ink must readily flow from the pen, show either at once or in a short time a deep black color, and must not attack the pen or the paper. When kept in a hermetically closed vessel no sediment of any account should be formed, although such will

always be found in ordinary inkstands, and this the quicker the more the ink comes in contact with atmospheric air. An ink available for documents must not be so much obliterated by water or absolute alcohol as to render the writing indiscernible.

Ink may be either a clear solution of any coloring matter, or, as is generally the case with ordinary writing-ink, consist of a finely-divided insoluble precipitate, held in suspension in water. The principal materials used in preparing this kind of ink are gall-nuts, sulphate of iron, and gum, used in various proportions. The gall-nuts are converted into a coarse powder and boiled with water, or, what is better, digested for several hours in water of a temperature near the boiling point; the decoction is then filtered and the dissolved sulphate of iron and gum are added. In the following we give a few receipts:

I. 12 parts of gall-nuts, 5 of sulphate of iron, 5 of gum-Senegal, and 120 of water furnishes a very useful ink for ordinary purposes.

II. The following gives a beautiful writing-ink: 11 parts of gall-nuts, 2 of sulphate of iron, $\frac{1}{2}$ part of solution of indigo, and 33 of water.

The quantities in the above receipt being proportionally larger, allow of the omission of the gum, while the solution of indigo imparts a deeper, brilliant black. Although the writing executed with this ink can be removed from the paper by diluted acid, it can be restored by chemical means.

III. Boil 2 pounds of pulverized gall-nuts in 3 gallons of water, strain the decoction through a linen cloth and filter it, and add 1 pound each of sulphate of iron and gum-Arabic dissolved in 3 quarts of water.

The mixture is stirred from time to time and exposed to the air until it has assumed a bluish-black color. It is then allowed to settle, when the clear ink is drawn off and bottled. This ink is sold under the name of "*Double Ink*;" the "*Simple Ink*" is obtained by adding an equal volume of water.

To prevent the ink from moulding an addition of creosote or carbolic acid is highly recommended. One drop of creosote thoroughly stirred in suffices for 1 quart of ink. A slight addition of

salicylic acid will prevent the formation of mould even in open inkstands.

The sediment remaining in the storing barrels is used for marking boxes, barrels, etc.

As ink prepared from gall-nuts and sulphate of iron has but a dull color, a small quantity of sugar or sulphate of copper is added to give it lustre, though the latter attacks steel pens.

It frequently happens that an ink which is black at first assumes, in the course of time, a yellowish tint. This is prevented by adding 2 ounces of caustic aqua ammonia to every pound of sulphate of iron used.

Other substances containing tannin, as sumach, logwood, the bark of oak or alder, are frequently substituted in part or entirely for gall-nuts; but the ink prepared in this way is not as fine, it flows badly from the pen and soon changes. In the following we give a few of these modified receipts :

	According to Lewis.	According to Ribbeaucourt	According to Robinson.
	Parts.	Parts.	Parts.
Gall nuts	100	85	100
Logwood	25	30	30
Sulphate of iron	30	30	30
Sulphate of copper	30	10	
Gum-Arabic	30	30	60
Sugar		10	
Water	2000	2000	2000

An ordinary writing-ink can be prepared by boiling 1½ pounds of logwood with sufficient water to leave a residue of 2½ quarts. When cold, add 1½ drachms of yellow bichromate of potash and stir thoroughly, and the ink is ready for use without the addition of gum. This ink is cheap and suitable for steel pens, but becomes thick, which defect, according to *Stein*, can be avoided by adding a few drops of solution of mercury salt. It flows then freely from the pen, and its color, first of a dark indigo-blue tint, changes soon into black.

The majority of the so-called *indestructible inks* contain a certain quantity of finely-divided carbon. The writing executed with these inks resists ordinary

reagents; but they are much thicker than ordinary ink, soon form a thick sediment, and do not penetrate the fibre of the paper, so they can be readily washed off or effaced by scratching

Traille prepares an indestructible ink by dissolving gluten in pyroligneous acid. A soap-like fluid is obtained which is diluted to the strength of ordinary vinegar. To every pint of this fluid there should be added ¼ ounce of lampblack and 20 grains of indigo. This ink possesses a beautiful color, flows readily from the pen, and dries quickly. It cannot be effaced by water or scratching, and reagents which destroy ordinary ink have no effect on it whatever. The fibre of the paper must be destroyed before the ink can be removed.

P. A. Gaffard, of *Paris*, prepares an indestructible ink from 1 part of lampblack, 12 of potash water-glass of the consistency of syrup, 1 of aqua ammonia, and 38 of distilled water.

Stark, who has devoted a great deal of time and labor to experimenting with ink, prefers for his own use the following composition: ¾ pound of gall-nuts, ½ pound of sulphindigotic acid, a like quantity of sulphate of iron, a few cloves, and ¼ pound of gum-Arabic to every gallon of ink.

Stark's Patent Copying-ink is made as follows: Dissolve 250 parts of extract of logwood, 17 each of sulphate of iron and sulphate of copper, and 50 of sugar in 1000 of boiling water; strain the solution, and add a solution of 16 parts of neutral chromate of potash, 100 of glycerine, and finally 200 of sulphindigotic acid, obtained by dissolving 2.5 parts of indigo in 50 of fuming sulphuric acid, and diluting with 200 of water.

Böttger's Copying-ink is prepared by dissolving 1 ounce of extract of logwood and ¼ ounce of crystallized carbonate of soda in 1 pint of water and adding to the solution 1 ounce of glycerine of 1.25 specific gravity, 15 grains of yellow chromate of potash dissolved in a little water, and ¼ ounce of pulverized gum-Arabic converted into a mucilage with a little water. This ink does not attack the pen, does not mould, and acquires a deep black color. If it is to be used as a writing-ink use 1 ounce of extract of logwood dissolved in 1 pint

of water, but leave out the gum and glycerine. It is well to add 15 grains of sulphate of copper to the above quantities, as this will considerably enhance the blackness of the ink.

Solid Inks (Ink Powders and Ink Stones). Various qualities of ink in the solid state are prepared as a convenience for travellers, so as to avoid the necessity of carrying bottles and the risk of breaking them. They are mostly composed of finely-pulverized constituents of gall-nut ink, over which cold water is poured, but such ink is as a general rule pale and poor. The best substance for preparing a good ink powder is aniline black, which can be readily dissolved in 80 parts of water, and furnishes at once an excellent writing-fluid.

We add a few of the innumerable receipts for ink. Many of them have been tried and found to be excellent.

Karmarsch's Black Ink. Eighteen parts of pulverized gall-nuts, 7 each of gum-Arabic and sulphate of iron, and 150 of water.

Reid's Black Ink consists of 1 pound of pulverized gall-nuts, $\frac{1}{4}$ pound of sulphate of iron, and 3 quarts of water.

Lipowitz's Process of Preparing Black Ink. Pulverize 6 $\frac{1}{2}$ pounds of the best black gall-nuts, pour as much water over them as they will absorb, and place them upon a perforated bottom in a barrel provided with several layers of cut straw. A sufficient quantity of soft water is now gradually poured over the moistened gall-nuts to give 6 gallons of a clear decoction of a dark-brown color. A corresponding quantity of dissolved sulphate of iron is brought at the same time to the boiling point in a suitable earthen vessel, and oxidized with nitric acid during the boiling. The oxidized solution of iron is then precipitated with crystallized carbonate of soda dissolved in the necessary quantity of water. The precipitate is placed in a linen bag, washed out, and pressed with a gradually increasing pressure until it is of such a consistency that the cake, after the press-cloth has been removed, will cling together and not moisten blotting-paper. Three pounds of this pressed ferric oxide is then stirred together with 4 $\frac{1}{2}$ pounds of good crude wood spirit, and added, with con-

stant stirring, to the 6 gallons of decoction of gall-nuts. The mixture is allowed to stand for a few days, being frequently stirred, and then 2 $\frac{1}{2}$ pounds of gum Senegal is added, and the mixture stirred until the gum is dissolved.

Brand's Black Ink consists of 20 parts of pulverized *Aleppo* gall-nuts, 250 parts of water, 10 parts of crystallized sulphate of iron, and 12 $\frac{1}{2}$ parts of gum-Arabic.

Booth's Excellent Black Ink. Take 6 parts of *Aleppo* gall-nuts, 2 parts of sulphate of iron, 1 $\frac{1}{2}$ parts of gum, and 90 parts of water. Pulverize the gall-nuts and boil them 3 times, and after each boiling add sufficient water to replace the loss by evaporation. Then strain the decoction and add to it the sulphate of iron and gum previously dissolved in the required quantity of water. The mixture is allowed to stand quietly for a few weeks, the supernatant liquid is then poured off, and a few drops of creosote added to prevent moulding.

Van Moos' Good Black Ink. I. To 150 parts gall-nuts converted into a coarse powder add 85 parts of sulphate of iron. Pour 4000 parts of cold water over the two ingredients and let them digest for 24 to 48 hours; then strain through a cloth and dissolve in the filtrate 48 parts of gum-Arabic.

II. Take 150 parts of coarsely-powdered gall-nuts, 50 parts of sulphate of iron, and 16 $\frac{1}{2}$ parts of gum-Arabic. Pour 650 parts of rain water over these ingredients, let them stand for 24 hours in a place not too warm, stir frequently, and finally filter through a cloth.

III. Boil for $\frac{1}{4}$ hour 100 parts of gall-nuts converted into a coarse powder and 30 parts of sulphate of iron in 4000 parts of ordinary wine or fruit vinegar, and when cold filter off the fluid.

Geissler's Black Ink. Convert into a coarse powder 1 pound of gall-nuts, $\frac{3}{4}$ pound of sulphate of iron, and 3 $\frac{1}{2}$ ounces of gum-Arabic. Pour over these ingredients 1 quart of vinegar and 1 $\frac{1}{2}$ gallons of water. Let the mixture stand for 8 to 14 days, stirring it frequently, and then pour off the ink.

Jahn's Black Ink. Boil down to $\frac{1}{4}$ its volume 25 parts of ground logwood, and 150 parts of bablah with 1500 parts of water. Strain the decoction through linen and then add 12 $\frac{1}{2}$ parts

each of pulverized gum-Arabic and pulverized sugar, and $37\frac{1}{2}$ parts of finely-pulverized sulphate of iron. Moulding is prevented by adding a very small quantity of a solution of chloride of mercury in water.

Lewis' Black Ink consists of 1 ounce each of pulverized sulphate of iron and logwood, $3\frac{1}{2}$ ounces of pulverized gall-nuts, 1 ounce of gum-Arabic, and 1 quart of white wine or acetic acid.

Ure's Black Ink. I. Place 600 parts of bruised gall-nuts in a cylindrical copper vessel and boil them for 3 hours in 4500 parts of water, replacing always the water lost by evaporation. Then pour the decoction into a vat, and after a short time strain it through a linen cloth. Now dissolve 250 parts of gum Senegal in a small quantity of water, and add the mucilage thus formed, after it has been filtered, to the clear decoction. Finally, dissolve 250 parts of sulphate of iron, add this to the ink, and expose the latter to the air. As soon as it has assumed a medium black color bottle and cork it tightly.

II. This ink consists of 100 parts of pulverized gall-nuts, 250 parts of sulphate of iron, 200 parts of gum-Arabic, 6000 parts of water, and a few drops of creosote.

The following receipts for the preparation of black inks are especially recommended:

I. Crush 600 parts of small gall-nuts into a coarse powder and boil in a copper boiler with 4500 parts of water for 3 hours, the loss by evaporation being replaced by fresh water. The decoction is placed in a vat and drawn off when clear, and the sediment strained through a cloth. Dissolve 250 parts of gum Senegal in 1500 parts of hot water and add it to the decoction of gall-nuts, and dissolve 250 parts of sulphate of iron in 1500 parts of hot water and add this to the same decoction. The ink obtained in this way is exposed to the air until dark enough to be used.

II. Digest for 8 days 16 parts of bruised *Aleppo* gall-nuts, 16 of sulphate of iron, 5 of gum Senegal, and 1 of alum in 216 of vinegar; then add to the whole 36 parts more of vinegar and 200 of water.

III. Boil repeatedly 160 parts of logwood with water. Pour the different

decoctions together and reduce them by evaporation to 1000 parts by weight. Dissolve in this liquid 1 part of neutral yellow chromate of potash, let it clear by standing, and draw the clear ink into bottles, which should be hermetically closed. This is a cheap and good ink, which flows freely from the pen, but spoils quickly if allowed to stand in open vessels.

Schmidt's Ink for Steel Pens. I One ounce of calcined sulphate of iron, $1\frac{1}{2}$ ounces of gall-nuts, and $\frac{1}{2}$ ounce of vegetable gum are digested in 1 pint of distilled water.

II. Boil down 2 pounds of pulverized gall-nuts with 3 quarts of water to $\frac{1}{2}$ its bulk, and compound this with 7 ounces of sulphate of iron previously dissolved in hot water. The whole is then boiled for a few minutes and filtered through linen. A part of the decoction is poured over $\frac{1}{2}$ ounce of Chinese ink, rubbed very fine, and to this is added $\frac{1}{2}$ ounce of solution of protochloride of manganese of 60° Beaumé. The Chinese ink, which will swell up in about 24 hours, is then rubbed very fine upon a stone, the clear fluid of the decoction of gall-nuts is poured off from the sediment and mixed with the Chinese ink. A few drops of oil of cloves dissolved in acetic acid are then added, the mixture thoroughly shaken in a closed bottle, and is then allowed to stand for a few days, and the ink is finally poured off from the sediment into another bottle.

Runge's Ink for Steel Pens consists of 500 parts of decoction of logwood and $\frac{1}{2}$ part of yellow chromate of potash.

The decoction of logwood is prepared by boiling $67\frac{1}{2}$ parts of logwood with the quantity of water named above.

The liquid is filtered and then compounded, with constant stirring, with $\frac{1}{2}$ part of yellow chromate of potash. The ink is then ready; it is of a bluish-black color, and gives no sediment. To prevent the ink from becoming too thick add a few drops of solution of chloride of mercury.

Haenle's Ink, which does not Corrode Steel Pens. Boil 250 parts of pulverized gall-nuts, 125 parts of gum, and a like quantity of sulphuric acid in 4000 parts of distilled or rain water, and add a few grains of chloride of mercury.

English Inks. The following is a receipt recommended by *Penny*, of Anderson University: Macerate 12 ounces of bruised gall-nuts in 1 gallon of cold water for one week, add 6 ounces of dissolved sulphate of iron, 6 ounces of gum mucilage, and 5 or 6 drops of creosote. In this receipt *Penny* makes use of the fact well known to chemists that tannin is more soluble in cold than in warm water, and for this reason recommends cold maceration, which, in fact, is used in the principal ink factories.

Duncan, Clockhart & Co.'s, of Edinburgh, Celebrated Bluish-black Ink is prepared by cold maceration according to the following receipt: 4½ ounces bruised Aleppo gall-nuts, not gnawed by insects, 1 drachm of pulverized cloves, 40 ounces of cold water, 1½ ounces of purified sulphate of iron, 35 grains of purified sulphuric acid, and ¼ ounce of sulphindigotic acid in the form of a thin paste, and either entirely neutral, or nearly so.

The gall-nuts are placed together with the cloves into a flask capable of holding about 4 gallons, water is poured over them and they are allowed to digest, being frequently shaken. The fluid is then filtered into another flask of the same size. The iron is now added, and, when entirely dissolved, the acid is poured into the mixture and the whole quickly shaken; finally, the indigo is added and mixed with the compound by shaking, and the whole filtered.

For *Copying Ink* 5½ ounces of gall-nuts are used.

This ink has several peculiarities: 1. The use of the cold process. 2. Entire absence of gum. 3. The use of sulphindigotic acid. 4. The small quantity of iron, which may be explained by the fact that pure protosulphate containing no sesquioxide is used, so that all the iron can combine with the tannin. 5. The use of free sulphuric acid, which has generally been considered as injurious to inks.

Ink for Steel Pens. The ink obtained by the following process becomes black at once, does not corrode the pen, and, when thick, can be diluted with water: Convert into a coarse powder ½ ounce of gall-nuts, add ¼ ounce of gum-Arabic,

and ¾ pint of rain water. Let the whole stand in a flask for 24 hours, shaking it several times. Then add 7 grains of ferric oxide prepared in the following manner: Place 4 ounces of sulphate of iron in an earthen-ware pot, and heat it over a strong fire until it forms a red mass, when it is allowed to cool and stored away for future use. To prevent moulding of the ink, add a few drops of creosote or a few grains of corrosive sublimate.

Vanadium Ink. *Berzelius'* receipt for this ink calls for 350 parts of a decoction obtained from 250 parts of gall-nuts, to which are added 1 part of ammonium meta-vanadate and 25 of gum Senegal.

A good black ink flowing readily from the pen is also obtained in a short time by rubbing together 1 part of pyrogallic acid with 3 of finely-pulverized and sifted gum-Arabic, and 3 of neutral ammonium meta-vanadate.

Alizarine Ink. Sulphate of iron perfectly free of oxide is the first requisite in preparing this ink. A decoction of gall-nuts 5 to 6 per cent. strong is first prepared, and then a solution of indigo in fuming sulphuric acid. To the latter, carefully diluted with water, are added iron filings. The acid remaining free after the formation of sulphate of iron is dulled by means of chalk or marble, so that only a small quantity of free acid remains in the fluid. The clear solution of indigo and sulphate of iron is poured from the gypsum which has been formed and added to the decoction of gall-nuts. Gum-Arabic is used to render the liquid viscous.

Elsner's Alizarine Ink. Extract 1½ pounds of bruised gall-nuts with 3 quarts of water. On the other hand pour 8 ounces of sulphuric acid over 4 ounces of powdered indigo, and let it stand for 24 hours. Then dilute the blue fluid with 3 quarts of water, and add to it 7½ ounces of iron filings free from rust and 5 ounces of pulverized chalk. After the fluid has stood for some time it is filtered and the filtrate added to the decoction of gall-nuts, also previously filtered. The writing executed with this ink is first greenish, but soon assumes a blue-black color.

Dubell's Alizarine Ink has a pleasant green color, flows freely from the pen,

and becomes black in a short time. It is prepared as follows: Convert into a coarse powder $\frac{1}{2}$ ounce of Turkish gall-nuts, pour $1\frac{1}{4}$ pints of tepid water over them, and allow them to digest for 24 hours at a moderate heat. Then strain the fluid and add 2 ounces of wood spirit, next $1\frac{1}{2}$ drachms of gum-Arabic, and 2 ounces of neutralized solution of sulphindigotic acid, and shake the mixture thoroughly.

Winternitz's Alizarine Ink. One hundred parts by weight of pulverized nut-galls are digested in 1200 parts of crude wood spirit, allowed to stand for a few days in a moderately warm place, filtered, and the residue in the filter washed with crude wood spirit until the filtrate amounts again to 1200 parts. In this clear brown extract dissolve 12 parts of sulphate of iron and 30 of gum-Arabic; let the mixture again stand for a few days, stirring it frequently, and finally add sufficient solution of indigo so that the whole makes 1500 parts by weight. The solution of indigo used is prepared by dissolving 1 part of indigo in 4 of fuming sulphuric acid, diluting the fluid with water, precipitating it with carbonate of potash, collecting the blue precipitate upon a filter, and washing with water.

Another Receipt. Five hundred and twenty-five parts of the best bruised gall-nuts are digested for 2 days in 7000 parts of water. Then add 700 parts of solution of indigo and dissolve in the liquid 190 parts of sulphate of iron, 175 of sugar, and a like quantity of gum Senegal, and finally 20 drops of creosote dissolved in 14 parts of alcohol.

Receipt with Oxalic Acid. Three hundred and fifty parts of the best gall-nuts are bruised and digested for 2 days in 3500 parts of water, and the fluid strained. In this dissolve 115 parts of sulphate of iron and 25 of crystallized oxalic acid; then add 225 parts of solution of indigo, and finally dissolve 100 parts of sugar, a like quantity of gum Senegal, and 10 drops of creosote in the fluid.

COPYING INKS. *Beau's French Copying Ink* consists of 1650 parts by weight of beer, 95 of gall-nuts, 30 of gum-Arabic, 40 of calcined sulphate of iron, 20 of tormentil root (*Potentilla*

tormentilla), 10 of lampblack, 10 of rock candy, 60 of white sugar, and 5 of honey.

Black Copying Inks. I. Boil 33 parts each of coarsely-powdered gall-nuts, extract of logwood, and bruised tormentil root in 500 parts of vinegar and a like quantity of water, and strain the fluid. Next dissolve 180 parts of sulphate of iron and 33 parts of alum in 250 parts of water; add this solution to the above fluid, and dissolve in it by boiling 1 drachm of indigo-carmin, 1 ounce of gum-Arabic, and $2\frac{1}{4}$ ounces of white sugar.

II. Boil 1 ounce of extract of logwood with 1 quart each of vinegar and water, $\frac{3}{4}$ ounce of sulphate of iron, $\frac{1}{2}$ ounce of alum, a like quantity of gum-Arabic, and 1 ounce of sugar.

III. Boil for 2 hours $4\frac{3}{4}$ ounces of rasped logwood in 3 gallons of water, replenishing from time to time the evaporated water. To the liquid, while still warm, add 1 pound of best gall-nuts converted to a coarse powder, $4\frac{3}{4}$ ounces of sulphate of iron, $\frac{1}{2}$ ounce of sulphate of copper, and $3\frac{1}{2}$ ounces each of white sugar and gum-Arabic. It is best to place the mixture in an earthenware pot of a capacity of 7 gallons, and allow it to stand in this for 14 days, stirring it at least twice a day; the ink is finally filtered through a coarse woollen cloth.

Excellent Black Copying Ink. Boil 9 ounces of coarsely-powdered gall-nuts and $4\frac{3}{4}$ ounces of ground logwood with $1\frac{3}{4}$ gallons of water until $\frac{3}{4}$ gallon of fluid remain, and filter through a cloth. Then dissolve $4\frac{3}{4}$ ounces of ordinary sulphate of iron, 3 ounces of sulphate of copper, $3\frac{1}{2}$ ounces of gum-Arabic, and 1 ounce of rock candy in $1\frac{3}{4}$ quarts of water; add this solution to the above decoction, stir it thoroughly, let it stand for 24 hours, and filter the ink from the sediment through a felt bag.

Excellent Black Copying Ink. Convert into a coarse powder 8 parts of Turkish gall-nuts, 4 of sulphate of iron, 2 of gum-Arabic, 1 of alum, and 1 of indigo. Place the ingredients in a flask, pour 12 parts of vinegar over them, and let them digest in a moderately warm place for 24 hours. Then add 60 parts of beer, let it again stand

in a warm place for a few days, when the ink is ready for use.

Another Receipt. By dissolving 1 part of rock candy in 3 of ordinary good ink, a fluid is obtained which permits the transfer of writing to another paper.

Alkaline Copying Ink which preserves the steel pen from oxidation is produced from 5 parts of decoction of logwood, of 8° Beaumé, 3 of sugar, 2 of gum Senegal, and 5 of glycerine. The fluid is colored violet by adding a solution of 20 parts of potash and 3 of flowers of sulphur in 100 of water. The substances are mixed in an iron boiler, 10 parts of leather waste added, and, with constant stirring, boiled down to dryness. Two hundred parts of water are then poured over the residue, the fluid is pressed out, and then filtered.

ANILINE INKS are true solutions; the coloring matter does not precipitate; they are very fluid, flow readily from the pen, and dry quickly. They must not be made too concentrated. If the writing, when dry, has a metallic lustre the ink should be diluted. The inks do not mould, and, when thick, can be restored by adding water. They do not require an addition of gum, but if desired, 1 part of dextrine may be added to 100 parts of ink; gum-Arabic should not be used. Some of the inks, especially the violet parlor ink, are very easily affected by other inks, so that a pen used for the latter must not be dipped into the former.

Blue Aniline Ink. Dissolve 1 part of *bleu de nuit* (*bleu de Paris*) soluble in water in 200 to 250 of hot water.

Black Aniline Ink. Dissolve 1 part of aniline black soluble in water in 80 of water.

Green Aniline Ink is very beautiful, but costly. Dissolve 1 part of iodgreen in 100 to 110 of hot water. Writing executed with this ink has a brilliant bluish-green color; for a more yellowish-green tint add some picric acid.

Red Aniline Ink. Dissolve 1 part of fuchsine soluble in water in 150 to 200 of hot water.

Violet Aniline Ink (Parlor Ink). Dissolve 1 part of aniline violet soluble in water in 200 of water.

Yellow Aniline Ink cannot be recommended. It is prepared by dissolving

1 part of picric acid in 120 to 140 of water.

INDESTRUCTIBLE OR PERMANENT INKS. *Bosse's* indestructible ink is prepared by boiling 33 parts of logwood with 400 of water for $\frac{1}{2}$ hour, then adding 16.5 parts of alum, filtering the fluid down to 266.5 parts, and adding a mixture of 33 parts of very fine elutriated pyrolusite and 16.5 of pulverized gum-Arabic.

Kindt's Indestructible Ink for Documents, etc. Mix 1 part of honey, 14 of water, 2 of sulphuric acid, and enough indigo, dissolved in fuming sulphuric acid, that the fluid seems to be sufficiently colored to furnish legible writing on paper. The writing executed with this ink, which, of course, must not be done with a steel pen, becomes perfectly black by heating the paper. To prevent the writing from being destroyed by free acids, it is, after the paper has been heated, moistened with spirit of sal-ammoniac, or the document is placed in a box and there subjected to vapors of carbonate of ammonia. It is claimed that this ink answers all demands.

Bossin's Indestructible Ink. Mix $\frac{1}{2}$ ounce of pulverized verdigris, 1 ounce of sal-ammoniac, $\frac{1}{2}$ ounce of lampblack with $5\frac{3}{4}$ ounces of water. Keep the mixture in a well-closed flask, and shake thoroughly before using it.

Braconnot's Indestructible Ink. Ten parts of good potash dissolved in boiling water, 4 parts of comminuted leather-waste, and 2 parts of flowers of sulphur are boiled to dryness in a cast-iron vessel. The dry substance is then heated, with constant stirring, until it becomes soft, care being had to prevent it from igniting. Sufficient water is gradually and carefully added until the liquid assumes a very dark color, which is strained through a cloth and kept in well-closed bottles. Writing on paper executed with this ink is not affected by concentrated caustic lye nor by concentrated nitric acid.

Excellent Blue Ink, of a beautiful and deep, pure blue color, is prepared as follows: Dissolve $16\frac{1}{2}$ parts of yellow prussiate of potash in 500 parts of water. Filter the solution and mix it with a filtered solution of $16\frac{1}{2}$ parts of pure sulphate of iron in 500 parts of distilled

water, and then add 1000 parts of distilled water. The water standing over the nearly white precipitate is then carefully removed with a siphon, and the precipitate filtered to remove the water, when it is placed by means of a horn spatula in a porcelain dish, which is put into a water-bath, and the precipitate oxidised by stirring into it a mixture of 8 parts of nitric acid of 1.225 specific gravity, and $6\frac{3}{4}$ ounces of sulphuric acid, care being had to avoid inhaling the vapors evolved. After the acids have acted upon the precipitate for 24 hours it assumes a dark-blue color; it is then placed in a wide-mouthed flask and thoroughly washed with water until a sample taken from the flask shows no reaction upon sulphuric acid; that means, until a few drops of a solution of chloride of barium no longer give a white precipitate. The precipitate is then rinsed from the flask upon a paper filter and allowed to drain off, when the filter is carefully taken from the funnel and spread out upon several sheets of filtering paper which have been placed upon porous bricks. The jelly-like precipitate is then rubbed up in a mortar with 3 parts of oxalic acid, and diluted with an equal volume of water. An addition of gum is not required, but, if desired, 150 parts of best white gum may be added to the ink.

RED INKS. *Carmine Ink* consists of 6 parts of carmine, 15 of spirit of sal-ammoniac, and 2 of tartaric acid. Dissolve the carmine in the spirit of sal-ammoniac previously diluted with 15 parts of water, and then add the tartaric acid. Let the mixture stand for 2 or 3 days, then pour off the supernatant red fluid, filter the sediment, and drain off the ink adhering to it.

Winckler's Durable Red Ink. Four parts of red carmine are rubbed very fine with 50 parts of ordinary liquid water-glass. The resulting compound is diluted with 450 parts of rain water and allowed to stand quietly for a few days, when the fluid forming the red ink is poured off.

The water-glass in which the carmine is dissolved is at the same time an excellent means of detecting an adulteration of carmine with cinnabar. In diluting the solution of carmine with water, the cinnabar is at once precipitated.

VIOLET INKS. *Violet Copying Ink.* Thirty-eight parts of extract of logwood, 550 of water, 20 of alum, $1\frac{1}{4}$ of cream of tartar, 15 of gum-Arabic, and $\frac{1}{2}$ of crystallized verdigris. Dissolve the extract of logwood in the boiling water. Then in 4 different vessels dissolve the alum, cream of tartar, gum, and verdigris in some of the solution of extract of logwood, and add the solutions to the liquor of logwood in the order as given. The ink is then ready and is kept from moulding by an addition of creosote.

Violet Writing Ink. Eight parts of logwood and 64 of water are boiled down to 30 parts. In this fluid dissolve, with constant stirring, $2\frac{1}{2}$ parts of alum and $1\frac{1}{2}$ of gum Senegal.

Encre Violette de Rouen is obtained by boiling 750 parts of logwood, 32 parts of alum, a like quantity of gum-Arabic, and 16 parts of sugar in 6000 parts of water for 1 hour. The mixture is allowed to stand for 2 or 3 days and is then strained through linen. This ink, it is claimed, is much improved by age.

SOLID INKS. (CAKES AND POWDERS.) *Platzer's Ink Powder.* Pulverize and mix intimately 100 parts of extract of logwood and 1 of bichromate of potash, and $\frac{1}{10}$ of the weight of the whole of indigo blue.

Ink Powder in Capsules. To avoid soiling the fingers and spilling some of the powder in taking it from the boxes in which it formerly was brought into the market, *G. J. Collins, of Brooklyn, N. Y.*, encloses a small quantity of powder in a capsule of gelatine, which, when dissolved in water, serves also to give the necessary consistency to the ink. The basis of the powders is generally an aniline color. For *Carmine* 40 parts of eosine, 3 of lunar caustic, and 7 of gelatine. For *Green* 44 parts of aniline green, 4 of gelatine, and 2 of lunar caustic. For *Purple* 40 parts of aniline violet, 4 of gelatine, and 2 of lunar caustic. The substances are separately converted into fine powder, mixed, and the mixture placed in the capsules. Each capsule contains about 15 grains of powder. It is dissolved in a corresponding quantity of pure water, requiring about 1 hour for solution.

Ink Cake. Extract 42 parts of *Aleppo*

gall-nuts and 3 of madder with sufficient water; then filter the fluid and dissolve in it $5\frac{1}{2}$ parts of sulphate of iron, and compound it with 2 parts of solution of methyl acetate of iron and $1\frac{1}{2}$ of solution of indigo. Evaporate this mixture to dryness at a moderate heat and form into cakes of desired size. One part of this ink dissolved in 6 of hot water gives an excellent writing and copying ink, while a beautiful ordinary writing ink is obtained by dissolving 1 part in 10 to 15 of water.

Marking Ink, especially adapted for laboratory use, as it resists the action of all acids and caustic fluids, and which is highly recommended for marking articles exposed to any degree of moisture, is prepared as follows: Dissolve, with the assistance of heat, 20 parts of brown shellac in a solution of 30 parts of borax in 300 to 400 parts of water, and filter the solution while hot. Then add to the filtrate a solution of $7\frac{1}{2}$ to 10 parts of aniline black (nigrosine) soluble in water, $\frac{2}{3}$ part of tannin, $\frac{1}{2}$ part of picric acid, 15 parts of spirit of sal-ammoniac, and $\frac{1}{4}$ ounce of water. More aniline black may be used, but the quantity given suffices for the production of a beautiful black ink, flowing freely from the pen.

Ink for Writing on Glass. By rubbing up equal parts of lampblack and iron scales (hammer scale) with strong gum mucilage, an ink is obtained which can be used for writing on glass.

Indestructible Ink for Writing on Glass. An ink has recently been brought into the market in the United States with which writing can be etched on bottles, etc. With the exception that it corrodes the pen, it answers the purpose very well. The ink, according to an analysis by Prof. Maisch, consists of ammonium fluoride, heavy spar, and sulphuric acid. The sulphate of baryta seems to act as an absorbent and to prevent the running of the ink.

Red and Black Ink, not acted upon by Acids, for Marking Glass and Metal Labels. Dissolve with the aid of heat 15 parts of finely-sifted copal in 120 parts of oil of lavender; then rub up with this solution 2 parts of thoroughly calcined lampblack and keep the mixture in a well-closed bottle. Before

using the ink shake it thoroughly and, if too thick, reduce it with some oil of lavender or rectified oil of turpentine.

For *Red Ink* use cinnabar instead of lampblack and prepare the ink according to the following proportions: One part of copal, 8 of oil of lavender, and $3\frac{1}{2}$ of cinnabar.

Stamping Ink, which does not dry quickly upon the cushion, but is nevertheless rapidly absorbed by the paper without blurring, is prepared according to the following receipt: Sixteen parts of fast aniline colors (blue, red, etc.), 80 of boiling distilled water, 7 of glycerine, and 3 of syrup. The aniline color is dissolved in hot water and the other ingredients then added, with constant stirring.

Sympathetic Ink. Boil some gall-nuts in aqua-fortis, and add to the infusion some gum-Arabic and a little sulphuric acid. However plain the writing executed with this ink may be at first, it will entirely disappear from the paper in a few days.

Incombustible Ink and Paper. This ink, which can be used either in writing or painting, is an English invention, and is made according to the following receipt: Twenty-two drachms of finely-ground graphite, 12 grains of copal or other resinous gum, 2 drachms of sulphate of iron, a like quantity of tincture of gall-nuts, and 8 drachms of sulphate of indigo are thoroughly mixed and boiled in water. The graphite can be replaced by an earthy mineral pigment of any desired color.

The pulp for the paper is composed of 1 part of vegetable fibre, 2 of asbestos, $\frac{1}{2}$ of borax, and $\frac{1}{2}$ of alum.

Indestructible Ink for Stamping Cotton and Woollen Goods which are to be Bleached with Chlorine. I. Dilute 1 part of coal-tar with 1 of benzine, and stir into it $\frac{1}{2}$ part of lampblack. Mix into a homogeneous paste which is used for stamping. By adding more or less benzine it can be given any consistency desired.

Changing Writing executed with Pale Ink immediately into Black. Rub fine 4 parts of dry sulphate of iron and then mix it with 8 parts of fine white sand. Strew the mixture on the ink while still wet, and allow it to remain for some time.

Colored Sand. Sift fine white sand from the coarser particles and color it.

I. *Blue.* Boil 106 parts of sand and 4 of Berlin blue with a small quantity of water, stirring constantly, and dry as soon as the sand is thoroughly colored.

II. *Rose-colored Sand* is obtained by mixing 100 parts of white sand with 4 of vermilion.

III. *Dark Brown Sand.* Boil white sand in a decoction of Brazil wood and dry it over a fire.

IV. *Black Sand.* Heat very fine quartz sand, previously freed from dust by sifting, and add to every $\frac{1}{2}$ pound of it 6 to 8 spoonfuls of fat. Continue the heating as long as smoke or a flame is observed on stirring. The sand is finally washed in water and dried. This black sand will not rub off.

Brush for Marking Boxes, etc. (Fig. 29). *M* is a sheet-brass reservoir closed on the top by the cover *N*. This reservoir forms the handle of the brush; the lower part is open and provided with the box *O*, enclosing the hollow screw *P*, and at the same time strengthening *M*. Through *P* runs a channel *p*, the upper part of which is protected by the cross-piece *n*, this being provided with a projection *o* by which the flow of the color is regulated. On *P* is fastened a tube *Q*, and a bunch of bristles forming the brush is fastened outside around a small tube at the end. By pressing down, the bristles are compressed and the color flows out.

Chemical Test of Written Documents.
Wm. Thompson, in a discourse before the *Manchester Literary and Philosophical Society*, recommends the following reagents: 1. Dilute sulphuric acid. 2. Strong hydrochloric acid. 3. Ordinary dilute nitric acid. 4. Sulphurous acid in solution. 5. Solution of caustic soda. 6. Solution of oxalic acid saturated with lime. 7. Solution of calcium chloride. 8. Solution of stannous chloride. 9. Solution of stannic chloride. The process is as follows: Moisten different written characters, successively, with each of the mentioned reagents, allow them to act a few seconds, and then carefully remove the excess of fluid with blotting-paper. According to *Mr. Thompson's* statement, the phenomena appearing in the dif-

ferent inks show such marked anomalies that it is even possible to dis-

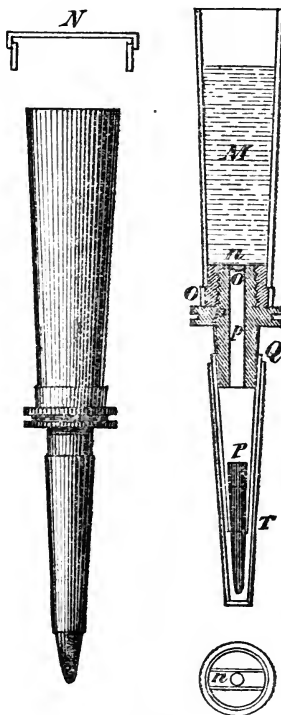

Fig. 29.

tinguish characters written with ink prepared in the same manufactory at different times, while characters executed with the same ink show such a corresponding action that no difference can be observed even if the ink, in case of drying in, had been diluted with water, beer, tea, coffee, or whatever may have been handy to the writer.

Printers' Rollers are made of molasses and glue. Break $\frac{1}{2}$ part of glue in pieces and cover with rain water and allow it to stand until all the water is absorbed, and then dissolve the glue in a water-bath. When froth begins to

rise, remove from the fire and add 1½ parts of heated molasses. Mix the compound well by stirring on the water-bath over the fire without allowing it to boil. After heating it for ½ hour take it from the fire and allow it to cool somewhat previous to pouring it into a cylindrical mould, made of tin, tinned sheet iron, or copper, having an inking roller previously supported in its centre by means of its end pivots or gudgeons. After remaining in the mould at least 8 to 10 hours in winter, and a longer time in summer, the roller is taken out of the mould by means of a cord fastened to one of the pivots and passed over a strong pulley fixed to the ceiling; but care must be had to draw the cylinder slowly from the mould.

Old rollers are recast in the same manner. They are first washed with strong lye, and a small quantity of water and molasses is then added. But the best plan of making use of old rollers is to mix them with some new material consisting of 1 part of glue and 2 of molasses.

JEWELLERS' FOILS.

Foils are very thin sheets of metal, analogous in substance to a sheet of paper. Tinfoil is used on the back of looking-glasses to form an amalgam with the quicksilver, for packing purposes, and as a useful aid in electrical machines. Jewellers' foils, made of copper, tin, silver, or combinations of two of them and colored, are used at the back of transparent gems, especially artificial stones, to heighten the brilliancy and lustre. Some kinds of foil are made by rolling sheet metal to the requisite thickness, others by forming a solid cylinder of the metal and then slicing off a film while the cylinder rotates. Jewellers' foils are further prepared by coloring, varnishing, and polishing. If the color of the stone requires modifying, a foil of lighter or darker color is used. The white foil is colored in the following manner:

Blue. *Turnbull's blue* is rubbed up with very pale, quick-drying oil, until the desired shade is obtained. This blue is used to impart a darker color to sapphires.

Green. Dissolve shellac in alcohol,

and add sufficient verdigris to the solution to produce the desired tint.

Red. A solution of carmine in ammonia or lacquer, or carmine rubbed up with isinglass, may be used. The tint, in either case, can be modified by mixing, and the lustre augmented after the color has been applied by lacquering.

Yellow. Solution of mastic and turmeric in alcohol, or a solution of saffron and isinglass may be used.

To prepare a Crimson Fluid for Dutch Gold or Paper. Boil seed lac in solution of soda, let it stand for 24 hours, pour off the clear fluid and mix it with glue or isinglass and a little sugar. Apply with a brush.

Yellow Fluid for Foils. Heat saffron in five times its weight of distilled water. As soon as it has assumed the desired color pour off the clear fluid and mix it with gum or isinglass. The fluid, after it has been applied and is dry, must be lacquered.

Green Fluid for Dutch Gold. Convert into an impalpable powder 15 parts each of cyanide of iron and bichromate of potassium and 60 parts of mastic, mix them with the requisite quantity of wood spirit, and apply the solution with a brush.

Process of producing Cameos. Stir marble cement into a thin paste with a mixture of yolk of egg and water. The paste can be colored as desired, and is then brought into moulds by means of a brush. The moulds should be silvered, and before using them, oiled. The figure of the mould is first filled in with the paste, and when this is cold the mould is filled up with a paste of a different color. When all is hard the cameo is dried, figure side up, then dusted with soapstone, and brushed with a soft brush. It may also be impregnated with stearine.

LACQUERS AND VARNISHES.

Manufacture of Fat Copal Varnish. *Violette*, who has thoroughly studied the action of copal subjected to high temperatures, and its solubility, recommends the following process for the manufacture of copal varnish: The copal is first heated at 680° F. until it has lost 20 to 25 per cent. of its weight,

when a suitable mixture of linseed oil and oil of turpentine is dissolved in the melted copal at 212° F.

The melting and distillation of copal is an operation which, as a definite

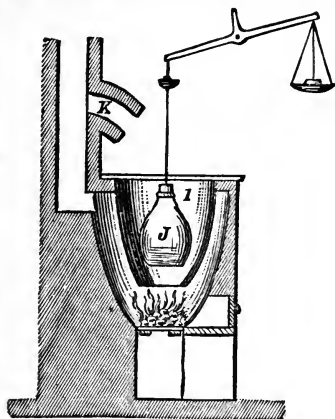

Fig. 30.

temperature must be kept up, is very difficult to execute on a large scale. The following apparatuses have been tested and approved by *Violette*. The arrangements represented by Fig 30 consist of a clay crucible *I* about 8 inches in diameter and 12 inches deep,

$\frac{3}{4}$ pound of copal and is suspended from a balance, the right scale pan of which contains the tare of the balloon and the copal, while upon the left scale pan is placed a quarter of the weight of the copal. The vapors from the copal escape through the opening in the chimney *K*. When 25 per cent. of the

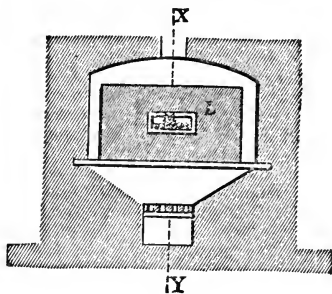

Fig. 31.

copal has been distilled off, the beam of the balance assumes a horizontal position, and the balloon is lifted from the crucible, the distillation being finished. The melted copal is distributed on the sides of the balloon by swinging the latter, when it is allowed to cool off somewhat, and then 1 pint of oil of turpentine and 5 ounces of linseed oil are added.

Figs. 31 and 32 are respectively cross

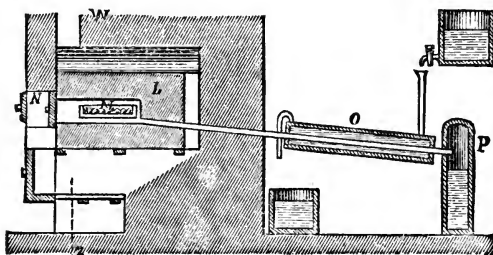

Fig. 32.

resting in a furnace. The crucible is heated to such a degree that zinc will just melt in it. The balloon *J* is then brought into the crucible. It contains

and longitudinal sections of another distilling apparatus. *L* is a cast-iron block weighing about 300 pounds, which can be easily kept at a definite temper-

ature. It is heated to 750° F., and then a little box *M*, containing 1½ ounces of copal, is placed in the hollow space. having a diameter about 20 inches, which can be turned by means of a handwheel around a horizontal shaft.

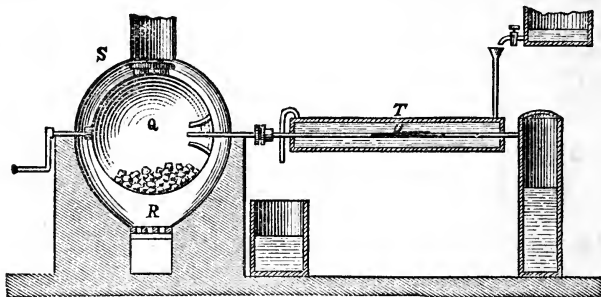

Fig. 33.

A moderate fire is kept up to prevent the block from becoming cool. The vapors evolved from the copal escape | represents the furnace, *S* a movable helmet, *T* the cooling apparatus, *U* the gas conductor which is connected with

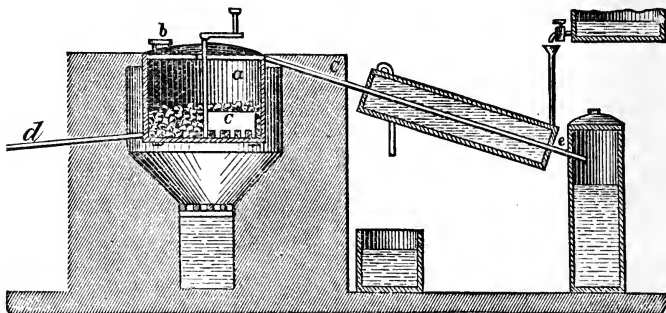

Fig. 34.

from the space closed with the cover *N* through a pipe, are condensed by the cooling apparatus *O*, and collected as a yellow, clear fluid in the vessel *P*. The operation is interrupted as soon as a quantity, corresponding to the fourth part of the copal, has been collected, when the box is taken from the cavity in the block and the copal poured out.

Another modification of the distilling apparatus is represented by Fig. 33. *Q* is a copper sphere silvered inside and

R the hollow axle of the globe. After 10 pounds of copal have been placed in the globe and the opening closed, a moderate fire is started and the globe slowly turned.

In the apparatus represented by Fig. 34, the globe in Fig. 33, is replaced by a fixed still in which the melted copal is moved about by means of a stirring apparatus. The still, silvered inside, is 40 inches in diameter, and 28 inches high. It is bricked in up to the cover, and capable of holding 200

pounds of copal; *b* is the opening for charging the still with copal, *c* the stirring apparatus, *d* the pipe for drawing off the melted copal, *e* the pipe for carrying off the oil of copal. A thermometer reaching into the still is used for ascertaining the temperature.

The apparatus represented by Fig. 35 serves for dissolving the copal, *f* is a

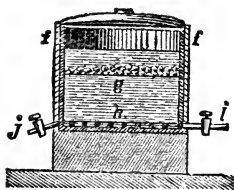

Fig. 35.

cylindrical vessel of tinned sheet iron 40 inches in diameter and 40 inches high. It is closed by a lid to prevent the evaporation of the oil of turpentine, and surrounded with a wooden jacket to keep it from cooling off; *g* is a grate of tinned iron wire placed 8 inches above the bottom. Upon this are placed 200 pounds of copal, a like quantity of linseed oil, and 650 pounds of oil of turpentine, previously introduced. This will give 1000 pounds of varnish. By opening the cock *i* on the serpentine pipe *h*, lying on the bottom of the vessel *f*, steam can be introduced to heat the solvent. The varnish is drawn off through the pipe *j*.

Varnish prepared in this manner is soluble in ether. *Violette* recommends the following proportions for copal: One pound of copal and 2 pounds of sulphuric ether. The resin is powdered, placed in a flask, and the ether gradually added with vigorous shaking, and the flask hermetically closed. Solution takes place readily. The varnish thus prepared is cleared by allowing it to stand, and before using it, filtered through paper or linen.

Spirit Lacquers are especially adapted for polishing fine woods and coating maps, book-covers, etc. The only objectionable point in using them for metal is that they do not adhere tightly. This can be remedied by using crystallized boracic acid, $\frac{1}{2}$ part

of which is dissolved in 1000 parts of the respective lacquer. When this is applied to a bright metal surface it forms a hard, glassy coating which cannot be scratched off with the finger-nail.

Iron Lacquers are all prepared in a very simple manner by melting pitch with various products of the distillation of tar. The pitch is melted, with an addition of the oil, in an open iron boiler heated from the outside. The oil accelerates the melting of the pitch and prevents it from congealing too rapidly.

After the pitch has become liquid it is advisable to allow it to cool somewhat before adding the oil, to prevent the latter from boiling. Add the oil gradually, and stir each portion thoroughly into the pitch before adding the next. To see whether the varnish has the right consistency take occasionally a sample from the boiler, allowing it to cool. An exact statement as to the quantity of oil to be used cannot be given, since the consistency of the varnish depends on the purpose for which it is to be used and the demands of the consumer.

Clarifying Varnish. A method of clarifying varnishes and other liquids and removing impurities in 48 hours is as follows: Mix with every 10 gallons of varnish 8 ounces each of powdered marble dust and burnt oyster-shells. All the impurities in the varnish will be attracted by and adhere to the oyster-shell dust, and the weight of the marble dust mixed therewith precipitates every floating particle to the bottom of the vessel containing the varnish. This process may also be applied to the clarification of turpentine, oils, and molasses.

Filtering Varnishes. The apparatus represented by Fig. 36 prevents a loss of solvent, as spirit of wine, benzole, etc., by evaporation. It consists of a large flask, *F*, either of glass or tin, closed by a doubly perforated stopper. In one of the holes is placed the neck of the glass funnel *T*, the upper rim of which is ground smooth, and the other is fitted with a glass tube, *r*, bent at a right angle. A thick wooden cover, with a ring of rubber on the lower side, is placed upon the funnel, closing it air-tight. In the centre of the lid is fitted a glass tube,

also bent at a right angle, and connected with the tube *r'* by a rubber hose *k*.

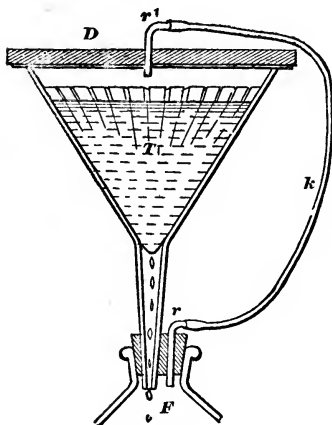

Fig. 36.

Either filtering paper or fine cotton is used as a filtering substance, of which a plug is formed in the lower part of the cone of the funnel and lightly pressed into the tube of the funnel. The air in the bottle, *F*, is displaced by the fluid dropping into it, and escapes through *r k* and *r'* dropping into the funnel, where it absorbs the vapor of the fluid, but absorbs nothing after it is once saturated. While evaporation goes on constantly when an open funnel is used, it is entirely checked by using this apparatus. When it is observed that the pores of the filter become very much choked up, the contents of the filter are allowed to run off and the filtering material is changed.

Spirit Gold-Lac Varnishes. I. Pulverize 66 parts of shellac and 133 parts of gamboge. Rub up the powder with 8 parts of dried saffron and dissolve the whole in 266 parts of alcohol in a flask tied up with a piece of perforated bladder, by placing it in a water-bath.

II. Treat the following ingredients in the same manner as above: Thirty-three parts of shellac, 16 parts of dragon's blood, a like quantity of turmeric,

and 8 parts of gamboge dissolved in 200 to 266 parts of alcohol.

III. Thirty-three parts of shellac, 4 parts of dragon's blood, and 2 parts of saffron are digested in 800 to 1200 parts of alcohol for 8 days in the sun, and then filtered.

Gold-Lac Varnish with Shellac and other Resins. I. Mix 133 parts of seed lac, a like quantity of sandarac, 66 parts of turpentine, 16 parts of dragon's blood, and 2 parts each of gamboge and turmeric with 133 to 166 parts of pulverized glass, and digest the whole in 1600 parts of alcohol.

II. Pour 500 to 600 parts of alcohol over 30 parts of seed lac, 60 parts of sandarac, a like quantity of elemi, 30 parts of dragon's blood, 20 parts each of turmeric and gamboge, 1 part of saffron, and 60 to 100 parts of pulverized glass.

III. Take 133 parts of shellac, 50 parts of sandarac, 33 parts of mastic in grains, 100 parts of yellow rosin, 33 parts each of yellow amber and dragon's blood, 24 parts each of gamboge and turmeric, and if a deeper color is desired, 30 parts of aloes, and pour 2000 parts of alcohol over the whole.

Gold Varnish without Lac. Dissolve 33 parts of copal, 16 parts of white boiled turpentine, and 4 of camphor in alcohol. Then prepare a solution of 33 parts of sandarac, 16 parts of mastic, 8 parts of dragon's blood, 16 parts of gamboge, 8 parts of annotto, and 4 parts of aloes in spirit of wine, and mix the two solutions together.

*Gold-Lac Varnishes with Oil of Turpentine and Oil of Lavender (from *Lavandula spica*).* I. *Without Linseed-oil Varnish.* Boil 66 parts of mastic, a like quantity of sandarac, and 4 parts of turpentine with 100 parts of oil of lavender over a coal fire; then add 33 parts of aloes and some rosin, and heat the whole until a small feather dipped into the mixture ignites.

II. *With an Addition of Linseed-oil Varnish.* 1. Dissolve with the aid of a water-bath 16 parts of amber, 33 parts of shellac, 16 parts of sandarac, 33 parts of aloes, 4 parts of gamboge, and 2 parts of dragon's blood in 266 parts of oil of turpentine, and then add a few drops of strong linseed-oil varnish.

2. Pulverize 266 parts of amber and 66 parts of stick lac. Dissolve the pow-

der in 266 parts of hot linseed-oil varnish and 400 to 533 parts of hot oil of turpentine, previously colored with 66 parts each of gamboge, dragon's blood, and annotto, and 16 parts of saffron.

3. Mix 133 parts of stick lac, a like quantity of sandarac, 16 parts of dragon's blood, 2 parts of gamboge, and 166 parts of pulverized glass, and digest the mixture in 500 parts each of oil of turpentine and linseed-oil varnish.

All the foregoing receipts have been tested and can be highly recommended.

Walton's Process of Preparing Linseed-oil Varnish consists mainly in exposing the linseed oil to the action of air, whereby it is converted into a resinous mass which, dissolved in wood spirit or alcohol, furnishes a quickly drying varnish. The apparatus represented by Fig. 37 is used. Clear linseed oil is mixed with a siccative, 5 to 10 per cent. of acetate of lead being the

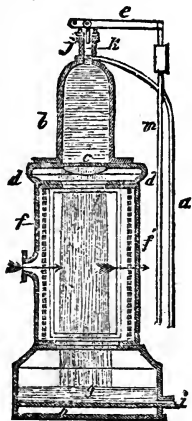

Fig. 37.

most suitable. The mixture is then passed through the apparatus. *a* is a tube through which the oil is conveyed by means of a force-pump into the reservoir *b* provided with a perforated bottom *c*. The oil passes down through this bottom, and falls in jets or drops through the column *d*, whereby it comes in contact with air forced in at *e* by means of a blower. Two sides of the

column are constructed of glass to allow the entrance of light, which exerts also a bleaching effect upon the oil; *f* and *f'* are perforated zinc plates. The object of *f* is to distribute the air in the apparatus over the hollow column, while that of *f'* is to allow the air to pass out and to retain particles of oil. The current of air need not be very strong, but a constant renewal of the air in the apparatus is absolutely required. The oil falls into the reservoir *g*, beneath which is a space *h*, which is heated from 212° to 300° F. by the introduction of steam; the higher the temperature the quicker will be the conversion of the oil; *i* is a pipe through which the oil is re-conveyed to the pump, by which it is again forced into the reservoir *b*, drops down through *d*, and so on until it has become sufficiently changed. On the upper end of *b* is a small cylinder, *j*, containing a valve *k*, which is connected with a lever, *l*, loaded in proportion to the pressure which is to be exerted in *b*. The rod *m* is connected in such a manner with a cock on the pipe *i*, that, when the valve *k* rises too high, in consequence of too strong a pressure, communication between the pump and the reservoir *g* is interrupted.

Several Universal Furniture Varnishes. I. Dissolve 240 parts of sandarac, 60 parts of seed lac, and 120 parts of rosin in 1500 parts of spirit of wine, and compound the solution with 180 parts of Venetian turpentine.

II. Compound 180 parts of naphtha with 30 parts of virgin wax. Apply the varnish warm and polish with a woollen rag.

III. Boil 500 parts of white wax in a solution of 750 parts of potash in warm water for $\frac{1}{4}$ hour, and, when the lye has become cold, skim off the wax which floats on the surface. Apply the wax to the furniture, and by rubbing it an hour afterwards with a woollen cloth, a beautiful lustre will be the result.

IV. Melt 120 parts of yellow wax and a little pulverized rosin, and compound this with 60 parts of warm oil of turpentine or spirits of turpentine. Rub the furniture with this by means of a woollen rag, which will give it a beautiful lustre.

Balloon Varnish. Cut up 500 parts

of caoutchouc, and let it digest in 3000 parts of oil of turpentine for 7 days, putting the vessel in a warm place; then heat the mixture in a water-bath until it is entirely homogeneous, add 2000 parts of warm drying oil previously boiled, mix intimately, and strain the compound as soon as it is cold. The above receipts have been tested and can be highly recommended.

Copal Varnish with Spirit of Sal-ammoniac. Convert copal into a coarse powder and gradually pour spirit of sal-ammoniac over it until the whole is swelled up to a thick, transparent mass. Heat this to 100° F., then mix it gradually with alcohol 75 to 80 per cent. strong, shake it thoroughly, and finally add more alcohol to give the mixture the requisite consistency.

Chinese Varnish. Dissolve 60 parts of shellac and a piece of camphor the size of a hazel-nut in 1000 parts of spirit of wine, by placing the vessel containing it in the sun or in hot ashes for 24 hours, shaking the bottle from time to time; then strain the fluid. Let the varnish stand quietly for 24 hours, and then pour it off carefully from the sediment; the latter may be used for the first coat.

Incombustible Varnish for Wood. An application of a solution of equal parts of alum and isinglass to the place exposed to the flame prevents ignition, but not the transmission of heat. By coating wooden vessels with this varnish fluids may be boiled in them over an ordinary fire.

Varnish for Wood not acted upon by Boiling Water. Boil in an untinned copper boiler 750 parts of linseed oil. Suspend in this, in a bag which must not touch the bottom, 150 parts of litharge and 90 parts of pulverized minium. Let the oil boil until it has assumed a dark-brown color; then remove the bag and replace it by one containing 7 to 8 bulbs of garlic. Now melt 500 parts of pulverized amber in 60 parts of linseed oil over a strong fire, add it while boiling to the prepared linseed oil and let it boil for 2 to 3 minutes longer, stirring it vigorously. Then take it from the fire, allow it to settle, pour off the clear liquid, and when cold put it in bottles, which should be hermetically closed.

To use this varnish, polish the wood first and give it the desired color, for instance, nut brown, by laying on a thin coat of a mixture of lampblack and oil of turpentine. When the stain is dry apply four coats of the varnish with a fine sponge, allowing one coat to dry before laying on the next.

Varnish for Earthen-ware Vessels. Mix equal parts of pulverized glass and soda, dry the mixture over a strong fire and spread it upon the surface of the burnt vessels while they are still hot.

Japanese Transparent Lac Varnish. Dissolve 30 parts of copal and 2 parts of camphor in 120 parts of oil of turpentine and 30 parts of oil of lavender.

Japanese Black Lac Varnish. I. Take 120 parts of burnt umber, 60 parts of genuine asphaltum, and 3000 parts of boiled oil. Dissolve the asphaltum in a small portion of the oil with the aid of heat, then add the umber, previously rubbed up with oil, and finally the remaining oil; mix the whole thoroughly, allow it to cool, and thin with oil of turpentine. This varnish is very elastic.

II. Dissolve 1 part of shellac in 4 of wood spirit, and color with lampblack.

Varnish for Fans, Fancy Boxes, etc. Dissolve 60 parts of mastic and 240 parts of sandarac in 1500 parts of spirit of wine, and compound the solution with 120 parts of Venetian turpentine.

Varnish for Umbrellas. Boil 2 parts of turpentine and 1 of pulverized litharge in 2 to 3 of linseed oil. This varnish is applied with a brush and dried in the sun.

Black Varnish for Tinsmiths. Mix fine lampblack or Frankford black with a solution of shellac, or with a solution of 1 part of asphaltum in 3 of oil of turpentine, and then add some linseed oil and minium.

Gold Varnish on Iron. Boil in an earthen-ware pot 90 parts or more of linseed oil, 60 parts of tartar, 60 parts of hard-boiled yolk of egg, 15 parts of aloes, $\frac{1}{2}$ part of saffron, and $\frac{1}{8}$ part of turmeric, and apply the fluid to the iron.

Pitch Varnish for Buildings. One pound of linseed oil, 150 parts of pitch, and 120 parts of litharge are boiled over a coal fire and stirred until they are intimately mixed. Apply one or, if

necessary, several coats of this varnish to the weather side of the buildings, which will render them impervious to moisture. The above quantity suffices to give 4 coats to 18 square feet of surface. Shingle roofs coated with this varnish last at least twice as long as ordinary.

Spirit Varnish for Violins and other Musical Instruments. Dissolve over a moderate fire 120 parts of sandarac, 60 parts of shellac, a like quantity of mastic, and 30 parts of elemi in 1500 parts of highly rectified spirit of wine, and after the solution has boiled up several times, add 60 parts of Venetian turpentine.

Black Varnish for Zinc. Equal parts of chlorate of potassium and blue vitriol are dissolved in 36 times as much warm water, and the solution allowed to cool. If the sulphate of copper used contains iron, it is precipitated as a hydrated oxide and can be removed by decantation or filtration. The zinc castings are then immersed for a few seconds in the solution until quite black, rinsed off with water, and dried. Even before it is dry the black coating adheres to the article so that it may be wiped dry with a cloth. If copper-colored spots appear during the operation, the solution is applied to them a second time, and after awhile they turn black, when the article is washed and dried. On rubbing, the coating acquires a glittering appearance like indigo, which disappears on applying a few drops of linseed-oil varnish or "wax-milk," and the zinc then has a deep-black color and gloss. The "wax-milk" is prepared by boiling 1 part of yellow soap and 5 of Japanese wax in 21 of water until the soap dissolves. When cold it has the consistency of a salve, and will keep in closed vessels for an indefinite time. It can be used for polishing carved wood and for waxing ball-room floors, as it is cheaper than the solution of wax in turpentine, and does not stick or smell disagreeably like the latter.

Parisian Wood Varnish. This celebrated varnish is prepared by dissolving 1 part of shellac in 3 or 4 of alcohol of 92 per cent. on the water-bath, and cautiously adding distilled water until a curdy mass separates, which is col-

lected and wrapped in linen. The liquid is filtered through paper, all the alcohol removed by distillation from the water-bath, and the resin removed and dried at 212° F. until it ceases to lose weight. It is then dissolved in double its weight of alcohol of at least 96 to 98 per cent., and the solution perfumed with lavender oil.

Furniture Varnish. Heat gently, with constant stirring, 8 parts of white wax, 2 of rosin, and $\frac{1}{2}$ of Venetian turpentine; pour the mixture into a glazed stone pot and add, while it is yet warm, 3500 parts of rectified oil of turpentine. After standing for 24 hours the mass forms a soft, buttery substance, and is ready for use. The articles to be varnished must be carefully cleansed with soap and water and then dried before applying the varnish. The polish obtained is not quite as brilliant as that obtained by shellac varnish, but has a peculiar, chaste appearance.

To Lacquer Flowers. Pulverize 40 parts of sandarac, 15 parts of mastic, and 2 parts of camphor, and put the powder into a long-necked flask; then pour 1000 parts of rectified spirit of wine over it, and place the flask in a moderately warm place, shaking it at first frequently, and then allowing it to stand quietly so that the fluid may settle. Flowers, plants, and herbs may be coated with this varnish. Flowers retain not only their beautiful colors, but are also protected against the ravages of insects. This varnish is also adapted for coating maps, playing-cards, copper prints, and pictures.

White Unchangeable Lacquer for Leather. Artificially prepared carbonate of baryta is rubbed up with very light linseed-oil varnish and the compound applied to the leather. On this is laid a coat prepared from carbonate of baryta and white copal varnish. When dry the lacquer is pumiced with elutriated pumice-stone and a piece of felt, and then polished with elutriated bone-ash. The white color of this lacquer is not changed in the least by sulphuretted or other exhalations, which, as is well known, darken white lead.

To Polish Carved Work. Dissolve 1 part of seed lac and 1 of transparent resin in 9 of spirit of wine. This polish must be applied warm, and the article

to be polished must also be heated if possible.

A beautiful *French polish* is obtained by using the following ingredients: 700 parts of spirit of wine, 15 parts of copal, 7 parts of gum-Arabic and 30 parts of shellac. The resins are first pulverized and bolted through a piece of muslin. The powder is placed in a flask, the spirit of wine poured over it, and the flask corked. By putting the flask in a moderately warm place, the solution will be accomplished in 2 or 3 days. It is then strained through a piece of muslin and kept in hermetically closed bottles. This polish gives a beautiful appearance to the carvings, and a gloss and richness of color which cannot be obtained by any other means. It is especially adapted for polishing fine furniture, and for this purpose is to be preferred to all other polishes. To give to articles polished with this lacquer the finest finish possible, the following preparation is used: Put 8 parts of shellac and a like quantity of benzoin, and 350 parts of rectified spirit of wine into a flask, keep this in a warm place until all the gum is dissolved, and shake it vigorously. To the cold solution add a small portion of the best poppy-seed oil, which should be as clear as water; mix all intimately together and keep it for use.

Parisian Bronze Lacquer. Dissolve 1 part of shellac in 8 to 10 of alcohol and add to the solution $\frac{1}{2}$ part of camphor rubbed up with a few drops of lavender oil.

Black Polish on Iron and Steel. A beautiful black polish is obtained by boiling 1 part of sulphur with 10 of oil of turpentine, but it has a disagreeable odor. A coat as thin as possible is laid on the article to be polished, which is then held over the flame of an alcohol lamp until the black polish makes its appearance.

A New Varnish (patented in Germany), which serves as substitute for linseed oil or oil of turpentine, is prepared in the following manner: 100 parts of rosin free from oil of turpentine, 20 of crystallized soda, and 50 of water are heated together and then intimately mixed with 250 parts of water containing 24 of aqua ammonia. The coloring substances are rubbed

up with this preparation without an addition of linseed oil, or oil of turpentine; they dry easily without a siccativ, and can be coated with lacquer. This varnish becomes very hard, resists the action of water and atmospheric influences, and is about $\frac{1}{2}$ cheaper than ordinary varnish.

Parisian Bookbinders' Lacquer. Dissolve on the water-bath 360 parts of shellac and 2 parts each of camphor and loaf sugar in 3000 parts of alcohol of 66 per cent. Filter the solution through blotting-paper, distil off $\frac{1}{2}$ of the alcohol, and add to the residue, while yet warm, a trace of oil of cinnamon.

Excellent Glass-like Varnish. Dissolve at a moderate heat 4 parts of camphor, 60 parts of sandarac, 15 parts each of Venetian turpentine and oil of turpentine, and 4 parts of white sugar in 400 parts of spirit of wine of 96 per cent., and clarify the solution by allowing it to stand for some time. In using the varnish expose the article to be coated to a gentle heat, and then apply the solution, which, when it becomes dry, will form a beautiful, glass-like coat.

Varnish for Wood Naturally Colored or Stained. Pulverize and dissolve 3 parts of light-colored shellac, 2 of sandarac, 2 of white rosin, and $\frac{1}{2}$ of camphor in 24 of alcohol of 80 per cent. Put, first, the shellac, sandarac, and camphor in the alcohol, tie up the vessel with a piece of wet bladder and shake it for half an hour; then add the rosin, and let the mixture boil up several times in a suitable vessel. Filter the ready varnish, while yet warm, through cotton or felt, and to clarify it let it stand for 12 hours in a well-closed bottle. No more varnish than is to be used in 2 or 3 days should be prepared at one time, since age impairs its beauty and hardness.

Colorless Varnish. Boil 500 parts of linseed oil with 1000 of water for 2 hours; then add 60 parts of silver litharge, 45 of sugar of lead, one onion, and a small piece of pumice-stone, and then heat the mixture for some time longer.

French Leather Lacquer. Boil 15 parts of logwood shavings in 120 of ordinary water until but half the quantity remains; dissolve in this 2 parts

of sugar and 12 of gum-Arabic and compound the mixture with solution of ferric sulphate until the previously brown-red color of the decoction has changed into a violet-blue tint, and finally add some spirit of wine.

Cheap Lacquer for Harnesses and Carriage Tops. Soak 2 parts of glue and then liquefy it over a moderate fire. Then dissolve 3 parts of ordinary soap over a moderate fire and add this to the solution of glue. About 120 parts of water are used for dissolving both ingredients. After the two solutions have been intimately mixed add 3 to 4 parts of spirit varnish, and finally stir into the mixture 2 parts of good wheat starch previously triturated with some water. Now place the pot containing the mixture over a moderate coal fire, and let it evaporate, although it may also be used before evaporation. The evaporated mass, when to be used, is liquefied by adding beer or water. The thinner the coat the more beautiful will be the gloss.

Lacquer for Drawings. Dissolve 30 to 40 parts of dammar in 180 parts of acetone and then mix 40 parts of this solution with 30 parts of thickly-fluid collodion.

Transparent Lacquer for Closing Bottles. A process of closing bottles, which is more elegant and effectual than with tinfoil, has recently been introduced in France. The neck of the bottle is dipped into a tenacious mass and quickly withdrawn with a rotary motion. It is in this manner covered with a transparent mass, which can be given a still more beautiful appearance by placing the monogram of the firm or other label on the neck of the bottle or on the cork. The preparation consists of 20 parts of rosin, 40 of ether, 60 of collodion, and any desired coloring matter.

Tar Varnish. Tar is intimately mixed with equal parts of hydraulic lime and Roman or Portland cement, by heating the ingredients to 158° F. The mixture remains thinly fluid and, when dry, soft and flexible. This varnish is not acted upon by acids and protects wood from rotting. It is especially adapted for wood under water, shingles, and water-pipes.

Polishing of Wood. The former

practice of pumicing furniture with oil is now supplanted by *Rosbach's* patent (now expired) of pumicing dry and coating with a mixture of 285 parts of copal, 57 of oil of turpentine, 628 of infusorial earth, and 28 of umber, principally used for walnut and chestnut; for rose-wood, carmine is used in place of umber, for oak, ochre, etc. A solution of 3 parts of shellac, 2 of copal, and $\frac{1}{4}$ of oil of rosemary in 10 of alcohol is used as a ground lacquer.

Elastic Lacquer. Slake 15 parts of lime with 20 parts of water, and add, while the lime is yet warm, 50 parts of melted crude caoutchouc. When cold the lacquer is in the form of a paste. It is best applied warm.

Black Harness Lacquer. Dissolve 40 parts of best shellac, 10 parts of sandarac, and 5 parts of mastic in 500 parts of spirit of wine. To prevent the lacquer from becoming brittle add to the solution 20 to 30 parts of pure Venetian turpentine, and finally sufficient aniline-black (nigrosine) dissolved in water or spirit of wine.

Parchment Fluid is prepared from gutta-percha soaked and swelled up in ether. It is used for coating pictures, maps, etc. The coat, if stained, or soiled, can be washed with a moist sponge. Crayon and charcoal drawings can be fixed by coating them with this lacquer.

To provide Bars of Spring Steel with a Coating not acted upon by Acids, Alkalies, Chlorine, and Steam. The bars are first coated with copal or asphaltum lacquer and dried at a high temperature. They are then wrapped in several layers of strongly-pressed paper impregnated with chromium glue, and subjected to a very strong pressure, and finally receive a coat of the following compound: Fifty parts of China clay, 10 of shellac, 8 of sandarac, 3 of elemi, 2 of gun-cotton, 0.5 of camphor, and 5 of oil of lavender (from *Lavendula spica*) dissolved in 100 parts of alcohol. When half dry the bars are again subjected to pressure, and when entirely dry, ground.

Aluminium Palmitate and its Uses in different Branches of Industry. Aluminium palmitate, a combination of alumina and palmitic acid, is a resinous substance of remarkable properties,

making it useful for many purposes. It melts at a higher temperature than dammar and copal resin, and is easily soluble in oil of turpentine and benzine. A solution of 1 part of it in 5 of a solvent retains a lacquer-like, thickly-fluid consistency. The lacquer obtained in this manner does not soak through paper, never becomes brittle, but remains flexible and dries quickly. It has a beautiful silky gloss, bears an addition of any amount of dammar and copal, obtaining thereby greater gloss and depriving the latter two resins of their brittleness. Aluminium palmitate will without doubt be of great importance in the manufacture of wall paper, lacquers, artificial leather, water-proof substances, etc. Lacquer prepared from it will be of great value in manufacturing gold wall papers and for coating genuine and imitation leather hangings, giving to the latter the characteristic gloss of stamped leather and preserving it in the first. It furnishes also an excellent vegetable glue which does not spoil, is, and remains, entirely neutral, and consequently exerts no injurious influence upon the shades of the colors. This makes it especially useful in the manufacture of velvet wall papers. If used as a sizing on cotton fabrics, it imparts to them a silky gloss which does not entirely disappear even after frequent washings. This sizing, on account of its neutrality and entire indifference, can be used for fabrics printed with the most critical colors without injuring them in the least. Palmitate lacquer is not acted upon by water and can therefore, as it remains perfectly flexible, be advantageously used in the manufacture of artificial leather, rubber tissues, and water-proof fabrics, its property of being entirely inodorous when dry deserving special commendation.

New Method of Preparing Fat Lacquer and Varnish, Patented in Germany by Zimmermann and Holtzwick. The resins are melted by a current of air heated above the melting point of the resins and circulating in the melting apparatus. The products escaping in melting are collected in a cooled and closed receiver. The warm current of air, after it leaves the melting apparatus, serves to convert the linseed oil

into varnish. The addition of litharge is saved by the use of lead vessels or lining them with sheet lead. The linseed oil flows slowly down in an apparatus through several boxes placed above each other, from whence it reaches a reservoir (a kind of montejus), is pumped up by compressed air into another vessel, and flows from this again through the boxes, the operation being repeated until it is converted into varnish. With this apparatus a light-colored fine varnish of excellent consistency, equal to the best English varnish, is prepared in about one quarter of the time used in the ordinary process.

Light Copal Varnish with Coal-tar Varnish Oil. Light copal 2 parts, light rosin 1, sandarac and Venetian turpentine each $\frac{1}{2}$, varnish oil 10. Pulverize and melt together the copal and rosin, then add the sandarac, and finally the turpentine; stir until all are dissolved, let it cool somewhat and then add the varnish oil, first in small portions and finally the remainder. Filter the varnish through cotton.

Light Parisian Varnish with Coal-tar Varnish Oil. Light sandarac 3 parts, light rosin and mastic each 1, Venetian turpentine $\frac{1}{2}$ camphor and oil of lavender each $\frac{1}{2}$, varnish oil 12, absolute alcohol 2. Melt the sandarac, rosin, and mastic together and then add the turpentine. Dissolve the camphor and oil of lavender in the absolute alcohol, and add finally to the varnish.

Light Varnish for Lacquering Photographic Negatives. Dammar 1 part, mastic $\frac{1}{2}$, sandarac $\frac{1}{2}$, chloroform and varnish oil each 10. Pulverize the resin, pour the chloroform over them, then add the varnish oil, and digest the whole in a sand-bath until all are dissolved. Filter the varnish through clean cotton and keep it in well-closed bottles. It dries very easily.

English Method of Varnishing Coaches. The superiority of English work is largely due to the fact that, though the same materials are used, more care is exercised in preparing the varnishes, and greater attention paid to preparing the wood-work for the reception of the varnish.

Pumicing. Grind a smooth face on a

piece of pumice-stone, then sift some pulverized pumice-stone through a hair sieve, and dipping the ground face of the stone into this powder, pumice the panels of the coach; then cleanse thoroughly with a brush, and finish them with a cloth.

Puttying. Before laying on the ground color, all holes, cracks, and indentations must be puttied up. The putty used is prepared by mixing white lead, red lead, umber, and a little silver litharge with thick boiled linseed-oil varnish and adding a little amber varnish. Press the putty into the holes and cracks by means of a wooden spatula. When the putty is dry dip a piece of pumice-stone in water and grind the puttied places down so that they become even with the panels.

Saturating the Panels with Oil. For this purpose a mixture of equal parts of linseed oil and linseed-oil varnish is used. Pour both into a pot, mix thoroughly, make the mixture boiling hot, and then saturate the panels. When the first coat is thoroughly soaked in, repeat the operation, and then allow it to dry thoroughly.

Laying on the Ground. The ground color is prepared by rubbing 1500 parts of white lead, 66 parts of red lead, 16 parts of litharge, and 33 parts of burnt umber with oil of turpentine, and diluting it with amber lac varnish. Do not lay on the ground color too thick at one time, but apply several thin coats. Care should also be had that the color shows no lustre; should this be the case add some oil of turpentine.

Pumicing the Ground. Moisten two pieces of pumice-stone with water, and rub them against each other until they have a smooth surface; use one of them for pumicing, dipping it frequently in water. The pumicing must be done in a circular direction, so that no place remains untouched. The color adhering to the pumice-stone is removed by rubbing with the other piece after both have been dipped in water. While pumicing wash the panels frequently with a large, wet sponge, and finally dry them with a white linen cloth.

Laying on the Paint. Proceed in the same manner as for ground, with the exception that, if the color is

light, pale amber lac varnish must be used.

First Pumicing of the Paint. Pulverize some pumice-stone and pass the powder through a hair sieve. Roll a piece of well-filled felt and tie it to prevent its unrolling during pumicing. Then, with the felt moistened with water and dipped into the sifted pumice-stone powder, pumice the paint as smooth as possible, rubbing always with a circular motion.

Second Pumicing of the Paint. Calcine pumice-stone by placing it on a coal fire, then rub it to a fine powder with water upon a stone, and allow it to dry. Then rub it very fine once more, and with a piece of felt, but not rolled together as before, moistened and dipped into the powder, rub in every direction until a glossy surface results.

Third Pumicing of the Paint. For this purpose white prepared buck's horn is used. The work is done with a piece of felt moistened and dipped in in the same manner as for the second pumicing. The paint is then cleansed by washing with a sponge and water, dried with a soft linen cloth, and finally rubbed with a piece of chamois, until the paint has a mirror-like lustre.

Laying on the Lac Varnish. In doing this the following rules must be observed:

1. Use only the best brushes, and apply the lacquer in long, perpendicular strokes, taking care that the coat is everywhere of equal thickness.
2. The lacquer must be applied cold, and the second coat only laid on after the first is thoroughly dry.
3. Lacquering should only be done in a room protected from dust and vermin; when the lacquer is no longer sticky the carriage may be brought into the air.
4. When the carriage has been placed in the sun, it must be frequently turned, so that the sun does not beat too steadily against one place.
5. The lacquer should be contained in a wide-mouthed vessel so that the brush can be dipped into it without hindrance. Do not take too much of it on the brush; after dipping in, turn the brush several times, and strike it against the side of the vessel.

6. Prepare your own lacquer, for which several tested receipts will be found below, or buy it only from a well-known firm.

Polishing the Lacquer. Use a piece of very soft, clean felt. Dip it first in a little olive oil and then in prepared white buck's horn, and rub the lacquer until it has a lustre equal to a ground mirror plate; and finally rub it with a soft linen or silk cloth dipped in fine starch flour.

Ordinary Body Carriage Lacquer. Boil for 4 hours 2 parts of the best African copal, 7 parts of clarified linseed oil, and 8 parts of turpentine. Mix thoroughly and strain. On the other hand, boil as usual, 2 parts of the best gum anime, 5 parts of clarified linseed oil, and 7 parts of turpentine. Strain while hot, and put it into the pot used for preparing the copal varnish. Mix 2 parts of the anime varnish with one of copal varnish; it will dry quicker and harder than the best body copal varnish, and will polish very soon.

Quick-drying Body Copal Varnish. Boil 200 parts of best copal, 500 parts of clarified linseed oil, 6 parts of dry sugar of lead, and 800 parts of turpentine until viscid, and then strain. Boil in another pot 200 parts of gum anime, 500 parts of clarified linseed oil, 6 parts of sulphate of zinc; strain while hot, and mix equal parts of the two varnishes. This varnish will dry in 6 to 7 hours in winter, and in 3 to 4 in summer.

Neil's Carriage Lacquers. I. Melt 2 parts of best copal, add gradually 10 parts of clarified linseed oil, boil until viscid, then reduce it with 6 parts of oil of turpentine, and filter.

II. Melt 2 parts of gum anime, add 5 parts of clarified linseed oil, boil until viscid, reduce with 7 parts of oil of turpentine, and filter. The two lacquers can be used either by themselves or, in case a quick-drying lacquer is required, mixed in equal parts.

LEATHER: TANNING, AND DYEING, INCLUDING FURS, ETC.

New Tanning Process. According to the process patented by J. & C. Bal-latschano, and H. Trenck, of Berlin, the

hides are treated with the following fluids: For solution No. 1, 20 to 30 parts of chromate of alumina are dissolved in 20 to 30 of wood vinegar, and diluted with water to 1000 parts. For solution No. 2, a concentrated solution of tartar is compounded with some ammonio-nickel chloride dissolved in ammonia. The skins, carefully freed from lime, are then placed in a mixture of 2 parts of the first and 1 of the second solution, 18 to 21 days being sufficient for thick bullock hides.

Quick Tanning Process. The hides are subjected to the ordinary treatment in running water, and then placed in a fulling trough hermetically closed. The water in the trough contains to every 100 pounds of hides weighed as taken from the water, a solution of 30 pounds of divi-divi, 20 pounds of bark of oak root, 30 pounds of alum, 65 pounds of acidulated barley meal, and 1 pound of sulphate of copper. The hides in the fulling trough are frequently turned for 24 hours, and then brought together with the tanning fluid into an ordinary vat, where for 15 to 20 days they are taken out daily and then put back again. After the expiration of this time they are put in tan in an ordinary pit, where they remain 15 to 30 days, when they are finished. In place of divi-divi and bark of oak root other materials containing tannin may be used, and sulphate of alumina may be substituted for alum, and sulphate of zinc, sulphate of ammonia, or other sulphates for sulphate of copper, the characteristic feature of this process being the use of the tannin and alum at the same time and in presence of the sulphate of copper.

Manufacture of Calf Kid in Philadelphia. Choice skins only can be used. From 6 to 10 pounds is the most suitable weight, although some manufacturers turning out a heavier article, use skins weighing as much as 18 pounds. The skins, whether green or salted, are soaked, according to the season of the year, for 12 or 14 hours, a few hours more in winter and less in summer, this depending entirely on the condition of the skins and the temperature of the water. They are then "stretched," when they are again soaked for 1 to 2 hours, and are then

ready for liming. The skins, as a general rule, are first placed in old lime for at least 1 to 2 days, and then in fresh lime for about 6 days. For preparing the fresh lime-bath 3 bushels of lime are taken to 12 dozen of skins. The skins, when coming from the lime-bath, are depilated and thrown into fresh water in order to wash out the lime. They are then fleshed. The well-known ooze, consisting of dog dung mixed with pigeon dung, is then prepared. Opinions differ as regards the quantity of ooze to be used, every manufacturer being guided by his own experience and judgment. The skins remain in the ooze from 30 minutes to 2 hours, when they are smoothed and then thrown into a mixture of bran and water, where they remain for 24 hours. They are then taken out, washed and cleansed from all adhering particles of bran, and scraped. The skins are now ready for the aluming. For a dozen skins take 2½ pounds of alum, about 13 to 14 ounces of salt, the yolks of 24 eggs, and 2½ pounds of flour; mix all thoroughly together, throw the skins into the mixture, and let them lie in it over night. They are then hung up to dry in the air, after which they are stretched and pared down to the desired thickness. They are again dried in the air to prepare them for the second bath, consisting of eggs and salt, and again stretched, when they are ready for dyeing. This is done with a preparation of a bichromate salt, urine, logwood, and sulphuric acid. They are again hung up and dried, smoothed, and finally ironed, after which they are oiled with prepared neats-foot oil and rubbed with caoutchouc to remove the oil, which finishes the work, 4 to 6 weeks being required to prepare such a skin.

To Depilate Hides. The sulphide of sodium sometimes fails to entirely remove the epidermis, causing ugly stains on the leather. In such case treat the skin, imperfectly depilated, with milk of lime, which quickly removes all traces of the epidermis.

Currier's Black Gloss. Eitner gives the following receipt for preparing a gloss for oiled leather, especially for corned and smooth calf-skins: Pour 1 quart of alcohol of 95 per cent. over ½

pound of ruby shellac, close the flask hermetically, let it stand in a warm place for 2 or 3 days, shaking it every day, until the shellac is dissolved. Then dissolve 1 ounce of dry Castile soap in ½ pint of warm alcohol of 95 per cent., add to it 1½ ounces of glycerine, shake thoroughly, and then add this mixture to the solution of shellac. To give to it a beautiful black color, dissolve 1½ drachms of aniline black soluble in 1 gill of alcohol, add this to the other mixture, close the flask hermetically, shake thoroughly, and let the mixture stand in a warm place for 14 days before using it.

Heating the Liquor in Tanning. Hot liquor should never be used in tanning. Liquors of 70° to 80° F. may be used without harm in the last stages, when the leather is completely tanned. There has always been a doubt whether warm liquors improve the quality of the leather, it being possible that the process of tanning is somewhat facilitated thereby. The strength of the liquors and their frequent use facilitate tanning and increase the weight.

Heinzerling's Quick Method of Tanning. The cost of production with this process is claimed to be 20 to 25 per cent. cheaper than with the use of tan, and only 3 days are required for tanning light hides and 5 for heavier ones. The process (patented in Germany) is as follows: The green hides are depilated and swelled in the usual manner. They are then brought into a solution of bichromate of potassium, or bichromate of sodium, or bichromate of magnesium and alum, or sulphate of aluminium and chloride of soda, and allowed to remain in it for a shorter or longer time, according to the kind of hides. Instead of placing the skins directly in this solution, they may first be brought into a 5 to 10 per cent. solution of alum to which some zinc dust or sheet zinc cut up in shavings has been added. The action of the zinc upon the alum produces amorphous alumina which is precipitated upon the fibres. After the skins have remained in the alum solution for a shorter or longer time, according to their condition, they are brought into one of the first-mentioned solutions, its degree of concentration depending on the nature of the skins to be tanned.

After remaining in it for a few days a few per cent. of ferrocyanide of potassium is added, although this may be done in the commencement of the operation. For many varieties of leather the addition of ferrocyanide of potassium is omitted, but for upper leather, to be blackened, this treatment is very suitable.

To fix the tannin on the skins thus treated, they are soaked for a short time in a solution either of chloride of barium or acetate of lead, or of soap, and are then dried in the ordinary manner.

The smoothed skins, while yet moist, can be oiled in the same manner as tanned leather. The oil may be worked in, or the skins can be submerged for some time in stearine, paraffine, chrysenes, naphtha, or similar substances, previously dissolved in benzine, photogene, etc. It is well to add some carbolic acid or thymol to the solution.

Boegel's Process of Quick Tanning. The green hides are depilated and soaked in the usual manner. They are then placed in a solution of any vegetable tannin or a solution containing a mixture of several vegetable kinds of tannin. To this are added acetate of alumina, chloride of soda, and picric acid, in alternate smaller or larger quantities, according to the nature of the skins. As an average, 50 pounds of acetate of alumina, 10 pounds of chloride of soda, and a like quantity of picric acid are used to 200 pounds of vegetable tannin. This tanning fluid produces calf leather in 14 days, kip leather in 3 to 4 weeks, bullock leather in 5 to 6 weeks, sole leather in 6 to 8 weeks; the quality of the different kinds of leather being such that they cannot be distinguished from leather tanned in the ordinary manner.

Jungschläger's Quick Process of Tanning. The green hides are placed in a solution of water-glass of 4° to 5° Beaumé, and worked in it from time to time until the hair can be removed. They are then placed in a solution of 2 parts of alum, 0.6 of common salt, a like quantity of sulphate of copper, and 0.2 of sulphate of zinc in 100 of water. During the 5 days the skins are allowed to remain in this solution it is concentrated more and more, and finally brought into the most concen-

trated form, consisting of 10 parts of alum, 3 each of common salt and sulphate of copper, and 1 of sulphate of zinc. The skins remain for 8 days in this last solution, are then dried at 70° to 85° F., and saturated with tallow, stearine, etc., at 95° to 110° F. The oiled skins are now brought into a solution of soap compounded with soda, in order to fix the metallic salts and to partly saponify the fat. They are finally finished in the same manner as tanned leather.

New Process of Depilating Hides. The hides are placed in a solution prepared by mixing together dilute solutions of ammonia and sulphurous acid.

Woolly hides are coated on the flesh side with a dough made of potter's clay and the above mixture. In place of ammonia the salts of ammonia may be used.

To Prepare Transparent Leather. The cleansed skin is repeatedly coated with a mixture of 100 parts of glycerine, 0.2 of salicylic acid, 0.2 of picric acid, and 2.5 of borax; then nearly dried and impregnated in a dark room with a solution of bichromate of potassium; then completely dried and coated on both sides with shellac varnish.

To Preserve and Water-proof Skins. Two baths are used: A. Compound 10 pounds of drying oil (linseed oil) with 2 pounds of concentrated sulphuric acid; neutralize with soda and wash with water. To the heated mass add a thick solution of 12 ounces of glue to which has been added, to make the glue insoluble, $\frac{1}{2}$ ounce of oxalic acid or 1 $\frac{1}{2}$ ounces of salicylic acid.

Reduce the compound before using it with fat or oil, or, where the odor is not annoying, with turpentine or tar oil; and, when the leather requires to be less dense, with ethereal oils, alcohol, or water.

B. Dissolve 10 pounds of glue or gelatine in 250 gallons of water, compound the solution with 6 $\frac{1}{2}$ pounds of oxalic acid or 20 pounds of salicylic acid, and finally mix it with 100 pounds of solution of acetate of aluminium. The grain side of the leather is coated with the mixture A, dried, and then immersed in B; again dried, then tanned in *Balatschano's* and *Trenck's* tanning bath (see above), and dried. This process

may be repeated. When dry, the leather is placed in cold water, whereby substances not absorbed are brought to the surface of the leather, from which they must be removed.

Textile substances, wood, paper, etc., can in a similar manner be made water-proof, durable, and flexible.

To Prepare Calf Leather with a White Flesh-side Smooth as a Mirror. The skins are tanned with sumach, dried, and pared. They are then felled very soft, dyed on the grain side, racked, stretched over a frame, and dried. When the grained side is finished the flesh side is pumiced, coated with the white color, and glass-papered. For the white color for a dozen skins 2 pounds of Spanish white and 12 ounces of white tallow soap are stirred together with the white of 12 eggs and $2\frac{3}{4}$ gallons of water.

To Preserve the Yolks of Eggs used in Tawing Glove Leather. Rub fine in a mortar or upon a stone 1 pound of yolks of eggs, $\frac{1}{4}$ ounce of common salt, and $\frac{3}{4}$ ounce of starch. The mixture, on thickening, is poured into moulds and dried in the air. Yolks of eggs thus prepared answer the same purpose as fresh.

To Preserve Hair in a Tannery. Pour salt water, or brine already used, over it and store it in pits set out with stones.

To Improve Hides and Skins. The depilated and cleansed skins are placed in a fluid compounded with glycerine, and allowed to remain until thoroughly saturated. This will require from 1 to 4 days, according to the thickness of the skins. They are then taken out, freed from the excess of glycerine, dried, and stored away for future use. Skins moderately tanned can also be subjected to the same operation. Skins thus prepared can be advantageously used for machine belts, straps, etc.

DYEING LEATHER. *Azure on Tawed White Leather.* Rub Berlin blue with some sour milk, and let it stand on a plate for several hours; then add some dilute sulphuric acid and sugar water, stir the whole thoroughly, and then apply the color repeatedly, by means of a sponge, to the leather stretched over a frame. The leather should be drawn over the stretcher every time before a new coat is laid on.

Black on Leather. Sixty-six parts of

iron filings and 33 parts of bruised gall-nuts are boiled in 2000 parts of sharp wine vinegar until reduced to half the quantity. Strain the liquor and apply it to the skins.

Blue on Leather. Moisten the leather with alum dissolved in urine and dye with strained juice of corn-flowers.*

Red on Morocco. Pulverize the woody parts of lac, add gall-nuts, alum, and some cochineal; boil these ingredients in water until a red liquor is obtained. Apply this liquor to the leather and finish by giving it a coat of a strained decoction of bruised white gall-nuts in water.

Saffron-yellow on Leather. Boil 250 parts of fine shavings of sour barberry root and 15 parts of pulverized turmeric in water, in an earthen pot. Strain the liquor through linen and add a few drops of aqua-fortis.

Dyeing of Chamois Skins. The colors are applied with a brush.

Black. Apply, first, a strong decoction of logwood, next dilute solution of sulphate of iron, and, finally, a decoction of logwood. Soap water and potash lye are used to give gloss to the color.

Green. Use buckthorn berries and as much alum as is required to produce the desired tint.

Gray. Apply lampblack and whiskey, dry the skin, and brush off the excess of dry color.

Tan. Use decoction of oak-bark, and, according to the lighter or darker shade desired, add more or less pulverized brown-red.

Yellow. Mix light or dark ochre with water.

Yellowish-brown. Mix brown-red and amber with water.

Dyes for Ordinary Tawed Leather. *Blue.* Dissolve 40 parts of Berlin blue and 8 parts of gum-Arabic in a little water, strain the fluid through a cloth, and then add sufficient water to produce the desired tint.

Camel-brown. Boil 2 pounds of oak tan, 2 ounces of sumach, and 1 ounce of Brazil wood, and some onion peels in water. Apply the color warm.

Chestnut-brown. Boil 1 pound of ground logwood, 2 pounds of ground Brazil wood, 1 pound of ground fustic, and 4 ounces of gall-nuts in water.

* Germ., Korn-blumen.

Coffee-brown. Boil 2 pounds of ground oak tan and 1 pound of ground fustic and some lye in water. Then boil $1\frac{1}{2}$ ounces of Brazil wood and 1 ounce of ground logwood in water. Add gradually of this to the first decoction until the fluid has assumed a brown color, and then add more or less sulphate of iron dissolved in warm water, according as the tint is more or less dark.

Flesh Color. Boil 4 ounces of bruised Avignon berries and 25 grains of potash, and add gradually decoction of Brazil wood until the desired tint is obtained.

Garnet. Boil $\frac{1}{2}$ ounce of Brazil wood and some turmeric in water.

Green. Boil 10 pounds of ground fustet, 2 pounds of logwood, and a like quantity of fustic in water, add to the infusion $\frac{1}{2}$ pound of decoction of gall-nuts, and dissolve 3 ounces of sulphate of copper in the mixture.

Another Receipt. Use decoction of buckthorn berries.

Another Receipt. Boil 1 pound of ground logwood, 1 ounce each of onion peels cut up and ground fustic, and 2 ounces of alum, for 2 hours in the requisite quantity of water.

Lilac. Boil for 2 hours 12 ounces of logwood, a little lime and some alum in sufficient water, and add 2 to 3 ounces of decoction of Brazil wood.

Olive-green. Boil fustic and some bruised gall-nuts in water, and add solution of sulphate of iron until the desired tint is obtained.

Orange. Boil sumach, double the quantity of fustic, and onion peels in water.

Rose-color. Boil for 1 hour, 15 grains of cochineal, cut fine, in 1 pound of water, and add 2 ounces of decoction of logwood and 6 drops of hydrochloric acid.

Scarlet. Boil 1 pound of logwood, 8 ounces of Brazil wood, 2 ounces of onion peels, some common salt, and alum in 4 gallons of water.

Violet. Mix 8 ounces of decoction of logwood with 2 ounces of decoction of Brazil wood, and dissolve $1\frac{1}{2}$ ounces of alum in the fluid.

Yellow (Dark). Boil 8 ounces of Avignon berries finely pulverized, $\frac{1}{2}$ ounce of potash, and some fustic with water.

Yellow (Pale). Decoction of quercitron or fustic.

Dyes for Kid Leather. Azure. Dissolve 2 ounces of prussiate of potash in $1\frac{1}{2}$ gallons of tepid water, brush the solution over the skin until it is permeated, and then give a light coat of weak solution of nitrate of iron.

Black. Boil 3 pounds of logwood, and 8 ounces to 1 pound of fustic shavings in $1\frac{1}{2}$ gallons of water, filter, apply the liquor to the leather, and give a coat of solution of sulphate of iron. The black skins then receive a coat of fat on the grain side.

Brown. I. Mix 25 pounds of decoction of willow bark, 8 pounds of decoction of elder bark, 1 pound of decoction of logwood, and some indigo-carmin.

II. Mix 35 pounds of decoction of willow bark, $8\frac{1}{2}$ pounds of decoction of fustet, and $8\frac{1}{2}$ ounces of logwood. -

Brown (Dark). I. Mix 8 pounds of decoction of fustic, 2 pounds of infusion of huckleberries, 4 ounces of decoction of logwood, and some indigo-carmin.

II. Mix $17\frac{1}{2}$ pounds of decoction of fustet, $4\frac{1}{2}$ pounds of decoction of fustic, $13\frac{1}{4}$ pounds of decoction of Brazil wood, and $5\frac{1}{2}$ pounds of decoction of logwood.

III. Mix $8\frac{3}{4}$ pounds of decoction of birch bark, $4\frac{1}{2}$ pounds of decoction of willow bark, $4\frac{1}{2}$ ounces of infusion of elderberries, and 8 grains of indigo-carmin.

Brown (Light). I. Mix 13 pounds of decoction of fustic, a like quantity of decoction of fustet, 2 pounds of decoction of Brazil wood, and 1 pound of decoction of logwood.

II. Mix $8\frac{3}{4}$ pounds of decoction of ground willow bark, $4\frac{1}{2}$ pounds of decoction of fustet, 2 pounds of decoction of fustic, and $\frac{1}{2}$ pound of decoction of logwood.

III. Mix $17\frac{1}{2}$ pounds of decoction of fustic, $8\frac{3}{4}$ pounds of decoction of Brazil wood, and $4\frac{1}{2}$ pounds of decoction of logwood.

English Gray. Boil willow bark with strong solution of copperas.

French Green. Dissolve 1 ounce of alum in 1 gallon of water, which furnishes the mordant required for dyeing. The dye consists of a solution of 1 pound of indigo-carmin in $3\frac{1}{2}$ gallons of boiling water, and 10 pounds of strong

decoction of fustic, and 2 pounds of decoction of logwood.

Gray. Mix 17½ pounds of decoction of willow bark and ½ pound of decoction of logwood.

Gray-brown. Mix 35 pounds of decoction of willow bark, 2 pounds of infusion of elderberries, and ½ pound of decoction of Brazil wood.

Gray-green. Mix 13 pounds of decoction of willow bark, 4 pounds of decoction of fustic, and ½ pound of decoction of logwood.

Gray Stone Color. Mix 17½ pounds of decoction of willow bark and 2 pounds of decoction of logwood.

Green Stone Color. Mix 8¾ pounds of decoction of willow bark with a like quantity of decoction of fustic and 1 pound of decoction of logwood.

Green (Light). Mix 17½ pounds of decoction of fustic and 2 pounds of decoction of logwood.

Green (Dark). Mix 25 pounds of decoction of fustic with a like quantity of decoction of logwood.

Olive-brown. Mix 10 pounds of decoction of fustic, 6 pounds of decoction of fustic, 2 pounds of decoction of Brazil wood, and 4 pounds of decoction of logwood.

Orange-brown. Boil 8 ounces of ground fustic and ½ ounce of ground Brazil wood in 1½ quarts of water.

Orange-red. Mix 4 pounds of decoction of willow bark with a like quantity of decoction of fustic.

Pensée or Violet-blue. The usual mordant is used with 1 pound of decoction of logwood and ½ pound of decoction of Brazil wood.

Silver-gray. Mix a decoction of weld with some infusion of bilberries.

Straw Color. Use a more or less concentrated decoction of weld, according to the tint desired.

Apparatus and Process for Dyeing and Patterning Animal Skins. Woolly skins to be dyed are hooked with the flesh side down upon stretching boards *a*, Fig. 38, provided on the edges with pins, and stretch by tightening the screws *s* acting upon the levers *c*. Copper pans with a double bottom, between which steam is introduced, receive the dye-bath, which must be somewhat heated and as concentrated as possible. On the inner sides of the pans are ar-

ranged movable copper knees, upon which the stretching boards are placed

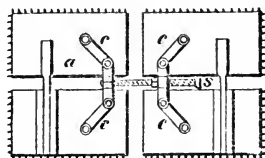

Fig. 38.

in such a manner that only the wool of the skins is immersed in the bath. The dyed skins are rinsed, dried, moistened with salt water, and stretched. For patterning the skins models as represented by Fig. 39 are used. They are provided with a high ledge through which runs a strap with which they are fastened to the stretching board and pressed against the wool. The models protect the wool enclosed in them in the dyeing and rinsing process.



Fig. 39.

To Dye Rabbit Skins Black. (For 100 skins.) *First Bath:* Carbonate of soda 10 pounds. *Second Bath:* Pure extract of logwood 17 pounds, catechu 10 pounds, blue vitriol 2 pounds. Place the skins first in the carbonate of soda solution, rinse them, and then place them for 2 hours in the second bath before the blue vitriol is added. During this operation the temperature of the bath should be kept exactly at 85° F. The skins are then taken out, cooled off, and replaced in the bath, now heated to 95° F., and this operation, after the blue vitriol has been added, is repeated, increasing the temperature every time 10° F. up to 120° F. The skins are then thoroughly rinsed, and will have a beautiful and durable color.

To Dye Sheepskins Brown. (For 10 pounds of skins.) Place the skins over night in water heated from 115° to 140° F. and containing sufficient ammonia to make them smell of it. Take them out the next day and wash them. Now exhaust 2 pounds of logwood by boiling it several times and dilute the liquor to 5 gallons. Place the skins in the

bath for 3 hours, then take them out and let them drain off. Then place them in a bath of wood vinegar of 5° B. for 1 hour, and move them occasionally. Then take them out, rinse, and dye them in a fresh bath heated to 140° F. and containing 1½ ounces of Bismarck brown; take them out, let the liquor drain off, rinse, and then dry the skins at a moderate heat and rather slowly. It is best to lay the skins flesh side upon a board, as this will prevent shrinking. The skins, when dry, must undergo further treatment to render them soft and pliable. For this purpose mix bran to a homogeneous paste with tepid water, and to every 2½ gallons add 3½ ounces of glycerine of 28° B. This mixture is applied to the skins, and when dry brushed off again. The yolks of 10 eggs mixed with 1½ gallons of water and 3½ ounces of Epsom salts can be substituted for the bran.

Process of Dyeing naturally White Skins, or Skins with naturally White Points, various Shades of Brown, leaving the Points White. To protect the points from the dye cover them with a resist-paste made by mixing with water 10 parts of gum-Arabie, 5 of sugar of lead, 10 each of fat white clay and acetate of copper, and carefully dry the skins.

The fur is now freed from oil and at the same time dyed brown by applying silver litharge, boiled in a solution of caustic lime, diluted to 4° B. and cooled to 75° F., to the skins. The plumbic oxide dissolved in the milk of lime forms with the sulphur contained in the fur an insoluble brown sulphide of lead, whilst the excess of milk of lime frees the fur at the same time from oil.

To completely convert the excess of plumbic oxide in the mixture and on the fur into sulphide of lead the skins are placed in a revolving drum hermetically closed and treated with very dilute ammonium sulphhydrate. They are then brought into a gallic acid bath, and, on neutralizing this with lime, brown coloring matter is precipitated upon the fur.

The paste is now removed by careful washing, and the points, having been neither freed from oil nor dyed, will be found perfectly white. By adding to the gallic acid bath small quantities of hyposulphite of silver and nitrate of

bismuth darker tints can be readily obtained.

Imitation of Sable Skins. Hamster skins closely resembling sable have recently been brought into commerce from England. The process of preparing them is as follows: A mordant prepared from 1 part of quicklime and 10 of water is applied with a brush to the fur side of the hamster skins and allowed to remain for 12 hours. The skin is then dyed with the following preparation: Pulverize and mix roasted gall-nuts 3 pounds, sal-ammoniac 4 ounces, sumach 15 ounces, sulphide of antimony 13 ounces, verdigris 2 ounces, iron cinders 10 ounces, copper ash 4 ounces, and clay 10 ounces. Compound the mixture with 12 gallons of water, stirring constantly. Apply a layer of this to the hamster skins, and after 24 hours place every 2 skins with the fur side together, let them again lie for 24 hours, and then heat them. Repeat the whole process until the desired color is obtained. The skins are finally cleansed by revolving them in a closed cylinder filled with sand and mahogany sawdust.

To Protect Fur against the Attacks of Moths. Mix with the liquor used for tanning a mixture of ¼ part rectified oil of turpentine, ¼ of weak solution of carbonate of soda, and 1 of somewhat concentrated decoction of wormwood, and proceed as usual. These proportions are calculated for 100 small skins.

For 100 calf or lamb-skins, they being larger, take oil of turpentine 2 pounds, soda-lye 4 pounds, and 8 pounds of wormwood decoction.

To Tan Linen, Hempen, and Cotton Fabrics. Boil 8 ounces of tan in 1½ gallons of water down to 1¼ gallons, and pour the liquor while hot upon the fabric to be tanned, and let it remain 48 hours. Then take out the fabric, rinse it in cold water, and dry. This quantity suffices for 1 yard. Fabrics thus prepared were kept in a damp cellar for 8 months without injury, while the same kind of fabrics, but not prepared, were totally ruined. The process is especially suitable for nets, ropes, cordage, sails, wagon-covers, tents, bags, etc.

To Give Leather the Smell of Russia Leather. Extract dry birch bark with

alcohol. Distil off the alcohol, pulverize the remaining resin, mix it with 3 parts of calcium hydrate, and distil. The oil passing over soon changes into a resin possessing an aromatic odor like that of Russia leather, and dissolves easily in oils and alcohol.

LIQUORS AND BEVERAGES: BEER, BRANDY, GIN, WHISKEY, WINES, ETC.

Beer Brewing. The fabrication of beer is divided into three principal operations: 1. Fabrication of malt. 2. Preparation of the liquor containing the dextrine and sugar; and 3, the fermenting of this liquor.

1. *Fabrication of Malt* requires 3 operations: *a*, Steeping; *b*, Germinating (*Couching*); *c*, Kiln-drying.

a. Steeping. The barley is first uniformly moistened in the steeping-vat, and then covered with water 4 to 6 inches deep. The light grains floating on top are removed. During this operation carbonic acid is evolved, the water acquiring a yellowish color, while the barley absorbs water equal to about $\frac{1}{2}$ of its volume, the increase in weight being more than $\frac{1}{2}$. After 24 hours the water is drawn off and replaced by fresh, this being repeated 3 or 4 times according to the temperature of the air. The operation is finished if the grains can be crushed between the fingers without exuding in the form of a milky juice. In steeping, strict attention must be paid to avoid acid fermentation.

b. Germinating (Couching). The water being drawn off the barley is allowed to drain off and laid upon the couch floor of stone flags in heaps 5 to 8 inches high, and turned every 5 or 6 hours to insure an even temperature and uniform germination. The temperature of the heap should never be allowed to rise above 60° F. When germination begins the heap is piled up from 7 to 14 inches high. The temperature rises from 77° to 80° F., and the barley commences to sweat, which may be recognized, if, on thrusting the hand into the heap, it not only feels warm but gets bedewed with moisture. The radicles and acrospire begin to develop.

The latter issues from the same end of the grain as the radicle, but turns over and proceeds within the husk towards the other end, and would there come forth as a green leaf were its progress not arrested. The malting, however, is complete before the acrospire becomes a leaf. As soon as the radicles and acrospire begin to grow, the barley, to admit air and check too rapid development, is spread thinner upon the floor, and turned over several times in the course of the day. As soon as the radicles have become 1 $\frac{1}{2}$ longer than the barley, and are contorted so that the grains hook into one another, and the acrospire is just beginning to push through, the barley is spread very thin on the floor, and when it feels no longer moist, brought into the kiln.

Kiln-drying expels the moisture from the germinated grains and converts the starch into dextrine and glucose, and stops the progress of germination and renders the mass fit for storage. The kiln is a chamber with a perforated iron or copper bottom to allow the heated air to permeate through the malt, which is spread upon the bottom about 3 to 4 inches deep. The temperature must not be too high at first, and is gradually increased to, but must never rise above, 158° F. During the kiln-drying the roots and acrospire of the barley become brittle and fall off, and are separated by a wire sieve. The barley, by germinating and kiln-drying, loses 8 per cent. of its weight.

2. *Preparation of the Liquor containing the Dextrine and Sugar (Mashing).* The object of this operation is to extract from the malt the sugar and dextrine by means of water, and to convert the starch into the same substances by the diastase. The beer, besides alcohol, must contain dextrine, and the action of the diastase must therefore be arrested before the dextrine is entirely converted into sugar, this being accomplished by boiling the watery solution. The operations necessary for gaining beer from the malt are: *a*, the actual mashing, or preparation of the wort; *b*, boiling the wort with hops; and *c*, cooling the boiled wort.

a. Mashing. The malt is coarsely ground in a grain-mill and mixed with water in a vat, and after 4 to 6 hours'

immersion, hot water is added to raise the temperature to 168° F., the vat covered, and the mash allowed to stand for 1 to 2 hours, when the clear wort (*wort-black*) is drawn off into a covered vessel and the residue washed several times with water.

b. Boiling the Wort with Hops. The clear wort is boiled in the copper together with the hops. The albumen and unchanged starch are precipitated by the tannin of the hops, and a bitter taste imparted to the beer and its durability augmented. After boiling for several hours the wort, to prevent acid fermentation, must be immediately cooled.

c. Cooling. In small breweries the beer is run into coolers, but in larger establishments refrigerators of various constructions are employed. The cooler is a large shallow vessel constructed of planks. It must be so placed that the wort can be cooled as quickly as possible to 60° to 68° F. In bringing the wort in the cooler the exhausted hops are retained by the hop-strainer.

d. Fermentation. When the wort is sufficiently cooled it is conveyed into the fermenting vat. Six or 8 hours after the yeast has been added fermentation becomes active. The temperature of the fermenting cellar should not rise above 59° F. A thin white froth appears first on the middle, and spreads gradually over the whole surface, whose color gradually changes into a yellowish-brown by the action of the air. Fermentation is finished in 5 to 8 days, according to the temperature of the cellar. After the beer is clear it is drawn off into barrels in the store-cellar for after-fermentation.

Improved Process of Brewing. The malt is mashed with water at 140 to 158° F. in a vat hermetically closed and provided with a stirring apparatus, double bottom, man-hole, etc., whereby the mash acquires a temperature of 120° F., which is raised to 167° F. by introducing steam at 257° F. between the 2 bottoms of the mash tun. The clear mash is then forced by steam from the grains into the clear mash-back standing higher than the mash tun. To dissolve the peptones, etc., the grains are steamed and then cooled off to 167° to

178° F. by squirting cold water over them, and the clear mash is then brought back into the mash tun in order to undergo a second complete saccharization. The mash is then heated to 212° F., and, after resting, forced into the hop-back.

New Brewing Process. The mash is thoroughly worked for 5 minutes in water at 120° F., and allowed to stand for 10 minutes. The supernatant liquor is then brought into the clarifying tun, and to every 25 gallons are added 1 pound of scalded hops and $\frac{1}{2}$ ounce of carbonate of lime. The thick mash remaining in the copper is first heated to 145° F., and then to 170° F., and after saccharization is complete, boiled for 1 hour with an addition of 2 $\frac{3}{4}$ ounces of carbonate of lime to every 2000 gallons of mash; the liquor first drawn off from the thick mash is then added. After standing for $\frac{1}{4}$ hour the wort is pumped into the pan and boiled for 2 hours. The hops, previously boiled alone for 2 hours and cooled off to 190° F., are then added to the mash, cooled to the same temperature. The wort is then pumped into the cooler, where 2 to 2 $\frac{3}{4}$ ounces of carbonate of lime are added to every 2000 gallons.

To prevent fermentation and putrefaction of the albumen, $\frac{1}{2}$ ounce of magnesia are added to every quart of the setting yeast.

Clarifying Beer. A very concentrated solution of phosphate of soda is first put into the wort, and then gypsum or chloride of calcium and slaked lime are added. Instead of the soda salt, phosphoric acid or some soluble phosphate of lime may be employed. This clarifier can be used at any stage of the process, either before or after fermentation. The same process is also recommended for other fermented liquors.

Flaxseed Pulp for Clarifying Beer. For every 60 gallons of beer boil $\frac{3}{4}$ pint of washed flaxseed in 1 gallon of water, replacing the water lost by evaporation by fresh. Separate the pulpy liquid from the seeds by straining and add it to the brewing $\frac{1}{2}$ hour before mixing the hops with it. When the latter is added the flaxseed pulp coagulates, enclosing the substances which make the beer turbid and settling with them

on the bottom of the boiler. Beer prepared in this way becomes clear in a very short time, its taste being not injured in any respect.

Brewer's Pitch. Light Yellow Pitch. Melt in an open iron boiler 100 pounds of pine pitch, and then add, with constant stirring, 5 to 6 pounds of caustic soda-lye of 10° B. When the mass in the boiler no longer rises, and the formation of bubbles has ceased, the fatty pitch is poured into iron moulds and allowed to cool.

Brown Pitch. I. Melt in an open iron boiler 150 pounds of pine pitch and 50 pounds of red, transparent American rosin; then add 10 pounds of rectified heavy rosin oil, stir thoroughly, and pour into moulds.

II. Composed of pine pitch 100 pounds, red, transparent rosin 85 pounds, and rectified heavy rosin oil 10 pounds.

III. Seventy-five pounds of pine pitch, 140 pounds of red, transparent rosin, and 12 pounds of rectified heavy rosin oil.

IV. Pine pitch 50 pounds, red, transparent rosin 150 pounds, and rectified heavy rosin oil 10 pounds.

V. Pine pitch 40 pounds, brown rosin 160 pounds, and rectified heavy rosin oil 10 pounds.

Ordinary Brown Brewer's Pitch. Melt in an open iron boiler pine pitch 30 pounds, brown rosin 175 pounds, and rectified heavy rosin oil 10 pounds.

Hop Pitch. Melt good brewer's pitch for $\frac{1}{2}$ hour with 5 per cent. of hops, pass the mixture through a fine wire cloth, and finally add 0.01 per cent. of oil of hops. This pitch, it is claimed, contributes to make the beer durable and aromatic.

Glaze for Beer Barrels. Glazing beer barrels, being cheaper and better than pitching, is adopted in many large breweries. For this purpose dissolve $\frac{1}{2}$ pound of rosin, $\frac{1}{4}$ pound of shellac, $\frac{1}{8}$ pound of turpentine, and $\frac{3}{4}$ pound of yellow wax in 1 quart of strong spirit of wine, and apply the solution twice to the inside of the barrel by means of a brush. As soon as the second coat is dry, apply one prepared by dissolving 1 pound of shellac in 1 quart of strong spirit of wine. This varnish closes the pores, does not break off nor injure the taste of the beer.

Prof. Artemus recommends to coat the inside of the barrel with a solution of soda water-glass of 1.25 specific gravity rubbed up with $\frac{1}{4}$ of 1 per cent. of magnesia. This glaze is very cheap and, as it can only be dissolved by long continued boiling in water, allows of a thorough cleansing of the barrels.

Testing Beer for Foreign Bitter Substances. Heat about 2 quarts of the beer, to be examined over a water-bath until the largest part of the carbonic acid and about $\frac{1}{4}$ of the water are evaporated. To precipitate the bitter substances derived from the hops, compound the fluid, *while still hot*, with basic acetate of lead as long as a precipitate is formed. The richer the lead salt is in plumbic oxide the more readily will the hop constituents be removed. Filter off the precipitate of lead as *quickly as possible*, protecting it at the same time from the action of atmospheric carbonic acid, which would decompose it. Washing out the precipitate is not advisable. The excess of lead added in the filtered fluid is precipitated with the necessary quantity of sulphuric acid; a quick settling of the sulphate of lead is accomplished by the addition of about 40 drops of a solution of 1 part of gelatine in 20 of water before adding the sulphuric acid. The fluid, after it is again filtered, must, if the beer was unadulterated, have no bitter taste if a few drops of it are placed upon the tongue.

Now compound the fluid with sufficient ammoniacal liquor to neutralize all the sulphuric acid and a part of the acetic acid. Then evaporate it in the water-bath to $\frac{1}{2}$ pint. To precipitate the dextrine, etc., mix the residue with 4 parts by volume of absolute alcohol, shake the mixture thoroughly, then place it in the cellar for 24 hours, and finally filter it. After distilling off the largest part of the alcohol, mix the aqueous residue of distillation, now reacting acid, successively with *petroleum-ether*, *benzole*, and *chloroform*. Then add ammonia to the aqueous fluid until it shows a perceptible alkaline reaction, and then repeat the shaking with the three fluids in the order given.

Pure Beer prepared from malt and hops shows, if treated in this manner, the following action:

*Acid Mixtures. Petroleum-ether.**

The solid part obtained by evaporating the residue of the mixture with petroleum-ether has scarcely any bitter taste, and when dissolved in concentrated sulphuric acid †, in sulphuric acid and sugar, or in nitric acid, gives a very slightly yellowish-colored solution, and in concentrated hydrochloric acid almost a colorless one.

Benzole ‡ withdraws only very small quantities of a resinous substance, which acts towards the mentioned acids in a similar manner as that isolated by the petroleum-ether. This substance has also only a slightly bitter taste.

Chloroform acts similar to benzole.

Ammoniacal Shakings. § *Petroleum-ether* absorbs next to nothing.

Benzole withdraws only traces of a substance giving no characteristic reaction of color.

Beer Wort acts in the same manner as fermented beer.

By the same method the addition to the beer of the following 13 substitutes for hops can be shown.

1. *Warmwood.* On shaking the acid fluid with petroleum-ether, ethereal oil is found, which is recognized by its odor and a part of the bitter substance. The residue of evaporation gives a brown solution in concentrated sulphuric acid, which, on being allowed to stand in the moist air of a room, assumes a violet color. Compounded with sulphuric acid and a little sugar it acquires gradually a red-violet color. By dissolving a part of the evaporated residue in a little water the filtered solution reduces ammoniacal solution of silver, while precipitates are obtained with chloride of gold and potassium mercuric iodide, but only slight turbidity with tannin, potassium bromide, potassium iodide, and mercurious nitrate.

Benzole and *Chloroform* absorb also the bitter substance which reacts as described above.

* Should boil between 91.4° and 140° F.

† The sulphuric acid should be as free as possible from nitric acid

‡ Benzole boiling at 176° to 177.8° F., and previously rectified, must be used.

§ Before making the fluid alkaline it must be once more mixed with petroleum-ether, in order to remove all traces of chloroform.

2. *Marsh Rosemary (Sedum palustre).*

In the extract with petroleum-ether some ethereal oil having the characteristic odor of marsh rosemary is found. The small residue treated with concentrated sulphuric acid acquires a more brownish color than ordinary beer, but for the rest does not remarkably differ from it.

Benzole and *Chloroform* absorb amorphous substances of a bitter taste, which give dark red-violet solutions with sulphuric acid and sugar, and, on being boiled in dilute sulphuric acid (1.10), develops an odor of *ericinol*. The solution reduces chloride of gold and alkaline solution of copper, while a precipitate is obtained with potassium iodide and tannin, but not with basic lead acetate. *Benzole* also absorbs small quantities of a substance which reduces ammoniacal solution of silver. *Chloroform* absorbs a substance which is precipitated with potassium-mercuric iodide.

3. *Bog Bean, Marsh Trefoil (Menyanthes trifoliata).* In the extract with petroleum-ether only traces of the bitter substance are found. *Benzole* and *chloroform* absorb more of the bitter substance (*menyanthin*), the taste of which can be detected in the evaporated residue. The latter, on being heated with dilute sulphuric acid (1.10), develops also the characteristic odor of *menyanthol*, reduces ammoniacal solution of silver, and is precipitated or, at least, made turbid with potassium-mercuric iodide, potassium iodide, tannin, and chloride of gold.

Nothing characteristic is found on shaking with ammoniacal liquor.

4. *Quassia.* Petroleum-ether absorbs but very small traces of the exceedingly bitter quassiin, which does not differ by any other reaction from substances obtained from pure beer. Larger quantities of quassiin are isolated by benzole and especially by chloroform. When treated with sulphuric acid and sugar it acquires a pale reddish color, reduces slightly ammoniacal solution of silver and chloride of gold, and precipitates potassium-mercuric iodide, potassium iodide, tannin, and basic lead acetate.

5. *Colchicum Seeds.* Petroleum-ether yields substances similar to those isolated from unadulterated beer. *Ben-*

zole absorbs small quantities of *colchicin* and *colchicein*, which taste bitter and give a yellow solution with concentrated sulphuric acid, which, on saltpetre being added, acquires a violet, blue, and later on a green color. The last reaction of color being also obtained with nitric acid of 1.30 specific gravity. By adding to the solution in nitric acid, when it has ceased to throw up bubbles, caustic potash, until a strong alkaline reaction takes place, a very durable cherry to dark-red coloring is obtained. The chloroform residue yields larger quantities of the above constituents of the meadow saffron, so that, besides the above-mentioned color reactions, precipitates are obtained with the alkaloid reagents commonly used.

6. *Indian Berries (Cocculi Indici)*, *Petroleum-ether*, and *Benzole* absorb from the beer adulterated with Persian berries only such constituents as from pure beer. With *chloroform* and, still easier, with *amyl alcohol* the picrotoxin is withdrawn from the fluid, but, on evaporating, it remains behind generally in such an impure state that it cannot be directly used for color reactions. It is therefore best to test whether a part of the residue reduces an alkaline solution of copper, and another part, dissolved in water, has a poisonous effect upon fishes. In this case, re-dissolve the remainder of the residue in warm water, shake again with chloroform, and repeat this until the residue of the chloroform shakings appears crystalline, after having been allowed to evaporate spontaneously in the ordinary temperature of a room. On re-dissolving the residue in alcohol, and allowing it to evaporate slowly, large needle-like crystals should remain behind, which give a yellow solution in concentrated sulphuric acid. By mixing this solution intimately with 5 to 6 parts by weight of pulverized saltpetre, then moistening it with sufficient pure, concentrated sulphuric acid to form a plastic mass, and finally adding sodalyle of 1.3 specific gravity until a strong alkaline reaction takes place, a brick-red fluid is obtained.

7. *Colocynths*. The *colocynthin* does not pass into *petroleum-ether* and *benzole*, but is shaken out with *chloroform*. It is extremely bitter, is precipitated

from an aqueous solution with tannin, reduces alkaline solution of copper, and dissolved in sulphuric acid gives a red solution, and in *Fröhde's* reagent* a violet one. But the latter reactions succeed only after the *colocynthin* has been purified by repeated dissolutions in water and shaking with chloroform.

8. *Willow Bark*. The *salicin* found in the young bark of several species of willow and poplar cannot be well obtained from acid extracts with *petroleum-ether*, *benzole*, and *chloroform*, but easily so with *amyl alcohol*. On heating the *salicin* with potassium bichromate and dilute sulphuric acid (1.4), it emits the odor of *salicylic acid*. In concentrated sulphuric acid it gives a red solution, and in *Fröhde's* reagent a violet-red one; but both reactions succeed only when the *salicin* is very pure, which is difficult to obtain even by repeated dissolutions in water and shaking the filtered solutions with *amyl alcohol*.

9. *Strychnine* cannot be gained from the acid solution, but only from the ammoniacal fluid, and then only in small quantities with *petroleum-ether*, and somewhat less difficult with *benzole* and *chloroform*. To establish the alkaloid it is best to use its well-known reaction upon sulphuric acid and potassium bichromate.

10. *Atropin* and

11. *Hyoscyamin* are also obtained by shaking the ammoniacal solution with *benzole* and *chloroform*. They are precipitated with most reagents upon alkalis, but, as good color reactions are wanting, must be confirmed by physiological tests.

The process is modified for proving.

12. *Aloes*. By treating the beer, in preparing it for the test, only with *neutral* lead acetate, and shaking it later on with *amyl alcohol*. After evaporation a residue with the characteristic taste of *aloes* must remain, and which yields precipitates with potassium bromide, basic lead acetate, and mercurous nitrate, and, being heated, reduces alkaline solution of copper and solution of gold. Tannin must also precipitate it,

*0.15 grains of sodium molybdate dissolved in 40 drops of pure concentrated sulphuric acid.

but, on being added in excess, partly redissolves the precipitate. By boiling a part of the residue with concentrated nitric acid, and expelling the latter over a water-bath, a mass remains which, on being heated with caustic potash and potassium cyanide, acquires a blood-red color.

13. *Gentian Root.* The beer is also prepared for this test by treating it with neutral lead acetate, filtering and removing the excess of lead, with just the necessary quantity of sulphuric acid. The fluid is then evaporated to the consistency of syrup, and this acidulated with nitric acid, and then subjected to the process of dialysis. The neutralized dialysate is again precipitated with neutral lead acetate, then filtered, and the filtrate compounded with basic lead acetate, whereby the bitter principle of gentian root (*gentianin*) is precipitated. The precipitate, after filtering and washing, is decomposed with sulphide of hydrogen, and the filtered fluid shaken with *benzole* or *chloroform*. By adding ferric chloride to an aqueous solution of gentianin it will be colored brown, but is not precipitated by it. Gentianin reduces ammoniacal solution of silver and alkaline solution of copper. It is precipitated with potassium bromide and mercurious nitrate, chloride of gold, and phosphomolybdic acid, while corrosive sublimate and potassium-mercuric iodide cause turbidity.

Determination of Glycerine in Beer.

For Dark Beers. Evaporate carefully in a water-bath, at about 165° F., 6 fluid ounces of beer and 1½ drachms of magnesium hydrate. Rub the residue before it is entirely dry with 3 fluid ounces of absolute alcohol, then filter off the alcohol and wash the residue with 3 fluid ounces of alcohol. Then compound the filtrate with 3½ times its volume of absolute ether in order to separate the maltose and para-pepton, and then allow the filtrate to stand for 12 hours for the volatilization of the ether. Place the remaining alcoholic solution in a flask previously weighed, evaporate it to a syrup on the water-bath, and dry it in a rarefied space for 12 to 24 hours. Extract the residue with about 1 fluid ounce of absolute alcohol, free the fluid by fil-

tering from the separated cholesterin, malt fat, etc., wash it with ½ fluid ounce of absolute alcohol, and evaporate the filtrate over the water-bath, then dry it under the air-pump and weigh it as glycerine.

For Light Beers, poor in peptones, take up the mass thickened with magnesium hydrate with absolute alcohol, filter, evaporate the filtrate to a syrup, dry it under the air-pump, add a mixture of 1 part of absolute alcohol and 1 part of ether, stir vigorously with a glass rod, filter through a very small filter, wash with the same mixture, evaporate carefully, and finish the process under the air-pump.

Alcohol and Compressed Yeast from uncrushed Cereals without the Use of Steam Pressure. Acidulate 50 gallons of water with 2 ounces of pure sulphuric acid of 66 per cent., and in it soak 20 pounds of the cereals without being crushed, at a temperature of about 104° F. After soaking for 48 to 60 hours the material is brought together with the water into the preparatory mashing tun, which is provided with a mashing machine, and saccharization takes place at 140° F.

To Convert Alcohol of 70 per cent. into 90 per cent. in the Cold Way. Mix calcined potash with alcohol of 70 per cent. until the phlegm, when shaken, shows 80 per cent.; then pour the alcohol carefully into another vessel, and add potash until it shows 90 per cent. Then pour it into a third vessel, and to cleanse it, which will require about 1 hour, add some more potash, and some burnt alum. The potash before using it, must be pulverized, sifted, and calcined in an iron vessel.

To Purify Alcohol obtained from Beets and Molasses. The alcohol is brought into a vessel of galvanized iron or enamelled wrought iron. For every 20 gallons of alcohol of about 90 per cent., 2 to 2½ ounces of caustic potash are added. The mixture is allowed to stand quietly for about 1 hour, when it is thoroughly stirred and the agitation repeated every 12 hours during the first 24 hours. After standing quietly for 12 hours, 10 per cent. of water is added, and the agitation repeated every 12 hours during the next 36 hours. It is then allowed to

rest for 24 hours, and filtered through a layer of asbestos. The potash is next neutralized with tartaric acid. After stirring it and then resting for 12 hours about 2 gallons of water are added to every 20 gallons of alcohol. The liquid is again allowed to rest for 12 hours, and filtered before rectifying.

To Purify Alcohol. The process consists in adding a small quantity of nitrate of silver to the crude alcohol, $\frac{3}{4}$ to 1 $\frac{1}{2}$ ounces being required for 2000 gallons of crude alcohol, according to quality and strength. For practical use it is best to prepare a solution of 10 parts of nitrate of silver in 100 of water. After the alcohol has been mixed with the solution it is converted into high-proof spirits. Rectified spirit produced by this process is destitute of all bad odors to a degree not otherwise attainable. The invention is available with equal success for any kind of spirit of wine; an addition of but 7 grains of nitrate of silver to 100 gallons of spirit of wine being sufficient to remove the bad odors from the poorest quality coming into commerce. For practical use it is best in these cases also to prepare solutions of nitrate of silver in water, namely, for the first, 1 part of nitrate of silver to 100 of water, and for the last, 1 part of nitrate of silver to 1000 of water.

To Prepare Absolute Alcohol. The easiest way of accomplishing this is to pour strong alcohol over anhydrous sulphate of copper, and agitate as long as the salt is colored blue, and then distil the fluid.

Manufacture of Cognac. The process in the Cognac district is as follows: The wine to be distilled is first brought into a stone trough, and is then pumped into a bronze boiler called the "chauffe-vin," whence it can flow into a still. In the chauffe-vin and in the retort the wine is heated by a coal fire, at first strongly and then gradually weak. After a short time a white, generally transparent, liquor called "*brouillis*," which should amount to about $\frac{1}{3}$ of the quantity of wine brought into the chauffe-vin, begins to run from the mouth of the cooling-pipe. The brown fluid, containing but very little alcohol, which remains in the retort is emptied and thrown away. Fresh wine is then conveyed into the chauffe-vin, and the

distillation commences anew, and is continued day and night until all the wine has been converted into spirits, which is finally rectified.

Artificial Cognac. The following compound, after storing for some time, will closely resemble the genuine article in taste and aroma: I. Mix 10 ounces of acetic acid, 7 ounces of *spiritus nitricothereus*, 1 $\frac{1}{2}$ gallons of white French wine, $\frac{3}{4}$ pint of tincture of oak bark (extracted from 4 ounces of oak bark), and 30 gallons of spirit of wine of 55 to 60 per cent., and the requisite quantity of sugar color.

II. *Artificial Cognac of a very fine flavor* is obtained by mixing 2400 parts of alcohol of 90 per cent., 1600 of water, 8 of *spiritus nitricothereus*, 6 of aromatic tincture, 1 of acetic ether, and 2 of tannin. The mixture, after standing for some time, is filtered, and should have a specific gravity of 0.917 to 0.920.

Dutch Method of Distilling and Manufacture of Compressed (Dry) Yeast. At Schiedam, Rotterdam, and Delfshaven are 300 to 400 distilleries and manufacturers of compressed yeast. The arrangement of all the distilleries is nearly the same. The stills and refrigerator stand on 1 side, and on the other 2 rows of vats, 6 in each row. Some of the vats are covered; on lifting the cover of one in which the mash has ceased fermenting, a thin, mouldy coat will be found on the surface; by tasting the mash and dipping the finger a few inches into it, no particles of crushed malt will be detected.

The capacity of the vats is nearly the same in all distilleries, and 3 to 4 men are employed in each. Work in all distilleries commences at 4 o'clock in the morning and ceases at 5 o'clock in the afternoon. The Dutch method of distilling requires comparatively little labor, which is generally done by hand, steam-engines being seldom used, and then only for pumping water. The greatest cleanliness prevails in the distillery; the walls, brickwork of the stills, etc., being frequently painted, so as to give them always a new appearance.

1. The mash is brought into fermentation with compressed yeast.

2. Considerable of the mash of former distilling is utilized.

3. No sulphuric acid is used. The mash is distilled, *a*, into low wine, and, *b*, by repeated distilling of the low wine into gin (the receipt for which will be given later on).

In Schiedam, 4 vats, each having a capacity of about 500 gallons, are usually mashed every day with 250 pounds of crushed rye and 150 pounds of crushed malt; a total of 400 pounds of groats.

Mashing. At 4 o'clock in the morning water is boiled in 1 of the stills. The groats having been poured into the mashing vat, the mashing water, consisting of 7 kannen* of cold and 21 kannen of warm water, is carried into the vat by 3 workmen, while the foreman manipulates with a kind of mashing scoop. When the mashing is finished, each vat contains about 175 gallons. A thermometer is seldom used for determining the temperature of the mash. The mash is allowed to stand quietly for saccharization for 1½ to 2 hours.

Setting (Anstellen). About 7 o'clock A. M. 230 gallons of wash are put into the fermenting vat, next yeast, and finally 40 gallons of cooling water, its temperature depending on that of the wash, leaving 4 inches (37 gallons) for rising space. Recapitulation of quantity of mash: One hundred and seventy-five gallons of mash, 230 gallons of wash, 40 gallons of water, 37 gallons of rising space; 482 gallons.

It will be seen from the foregoing how little labor is actually required, as only one man mashes lightly by hand, and cooling apparatuses being superfluous, as sufficient cold water and wash are added to the mash.

The mash, after having been set at 9 o'clock A. M. at 81.5° F., is allowed to ferment until 12 o'clock, during which time a thin white coating of froth is formed on the surface.

The wort from the mash in the 4 tuns is then pumped into a wort-back resembling a square wooden cooler, and standing on an elevation in the fermenting room. In place of a perforated bottom to separate the grains from the

wort, the Dutch distillers use a slightly serpentine copper siphon about 30 inches long, 4 inches wide on the top. In one of the staves of the vat, about 10 inches above the bottom, which has a fall forward of about 1 inch, is a hole closed with a cork. This latter is removed by pushing the lower pointed end of the copper siphon through the hole from the inside of the vat, allowing it to project about ¾ inch. To the upper end of the siphon is fastened a strap, which is drawn over the edge of the vat by a stone. The stone is as heavy as the copper tube full of thin mash. By raising the stone somewhat, the upper end of the copper siphon sinks down, sucks in the thin mash, and carries it through the lower end projecting through the hole in the vat, into a collecting back. When all the thin mash down to the exhaust has run off, the stone is raised up a little more and the operation repeated. All the wort is drawn off from the mash in this manner, that of the four vats running at the same time through a gutter into a collecting back, and is from here pumped into the above-mentioned wort-back. The froth (scum) formed from the time of setting (anstellen) to drawing off of the wort (9 to 12 o'clock) is prevented from entering the siphon with the thin wort, by placing a lath across the surface of the wort. When the principal part of the wort has been drawn off, water is poured upon the mash remaining in the vat and thoroughly mixed with it. It is allowed to stand quietly for 2 or 3 hours, when the heavier particles of the grains will have settled on the bottom, and the operation of drawing off the wort is repeated. About 160 gallons of sediment, *i. e.* thick mash, remain in the vat after all the wort has been drawn off. The wort stands about 4 inches deep in the wort-back, which has a total height of about 12 inches; it remains here until the next morning, when the yeast is ripe.

The formation of yeast is as follows: The yeast separates not as a high froth, but as a brownish mass resembling the formation of cream upon milk. Dark places are frequently observed upon the surface of the wort, but generally it is of a light-brown color; the lighter the color the better is the fermentation,

* One kanne = 4.4 gallons; 28 kannen being used. The total quantity of water in each tun is about 125 gallons. (W. T. B.)

and also the yeast. When the yeast is ripe the wort is brought back into the respective fermenting tuns. As there is also a sediment of yeast on the bottom, in order to retain this a ring is placed around the tap-hole, the top yeast being held back by a lath placed across the surface of the wort. When all the wort has run off a hose is tied to the tap-hole and a workman sweeps the ripe yeast into the precipitating vessels. These are circular in form and about 15½ inches high. The yeast, after remaining here for 3 to 4 hours, can be pressed without much difficulty, although only very little water, and that but once, and no starch has been added to precipitate it.

For pressing the yeast a canvas bag is put inside a stout press bag, and this into another press bag. The yeast is poured into this triple bag, the canvas bag containing the grains being finally lifted out. How much easier the Dutch distiller removes by this process the particles of groats from the yeast, than by washing and sifting it, as is customary in the distilleries of other countries. To press the yeast uniformly dry the press bag is not tied, but the bags, which are square, are placed one on the top of the other, the open end of the bag being bent upwards and secured between the bag itself and that lying on the top of it, a piece of linen being, for further security, laid around the open end of the bag. As 6 press bags are laid on top of each other, considerable yeast can be quickly pressed dry with one press.

The setting (stell) yeast, preserved in a fluid state, is compounded with hop water. One gallon of hops is distilled off, and the extract used for preserving the yeast required for 16 washings.

Clarifying the Wash. The wash runs directly from the still into a brick pit, and clarifies here while still warm, there being but a small opening in the cover of the pit for carrying off the vapors. About ¾ of the clarified wash is pumped the next morning into a cooler lined with copper, and used the third day for cooling off the mash. As soon as the wash has been drawn off into the respective fermenting tuns the cooler is at once cleansed and the wash to be used the next day pumped up.

Receipt for Holland Gin. For a distillate of 12 washings about 20 gallons of juniper berries are used; for the finest qualities of gin some licorice root and sugar are added in rectifying.

The fine flavor is imparted to the gin by the proportion of malt to the crushed rye, and the finished liquor being rectified three times. In a few distilleries 20 gallons of barley are used in place of the same quantity of rye.

Rum (Fagon Rum). Prepare first a so-called rum body by pulverizing 10 pounds of catechu, placing the powder in a wide-necked bottle, pouring 1½ gallons of alcohol of 96 per cent. over it, and letting the mixture stand for 8 days, stirring it frequently until the supernatant alcohol has acquired a dark-brown color, while the sediment has become light brown. Then pour the clear fluid into a demijohn. On the other hand, boil 45 pounds of St. John's bread, as fresh as possible, and 10 pounds of large raisins with 4½ gallons of water for about 25 minutes and press out the liquor. Mix this with 1½ gallons of alcohol, pour it into the demijohn, stir thoroughly and allow the whole to settle. Take 1½ to 3 quarts of this rum body to every 130 gallons of alcohol, and flavor the mixture with 1½ to 1¾ pounds of Kingston rum essence to every 20 gallons.

To Destroy Fusel Oil (Amyl Alcohol). Every distillate, be it from grain or potato mash, contains more or less fusel oil, which, by its disagreeable odor and taste, injures the flavor of the liquor, and, in preparing cordials, liqueurs, etc., destroys the effect of the aromatic admixtures. The best means hitherto discovered of depriving liquors of fusel oil is to pass them through coarsely-pulverized charcoal, distributed as follows in a series of casks. Each vessel must have a double bottom, the false one being perforated and placed a few inches above the true. Upon this perforated board a layer of chopped, lixiviated straw ¾ to 1 inch thick is laid, and over the straw a stratum of fine gravel the size of large peas. This is covered with a pretty thick stratum of the charcoal, previously freed from dirt and dust by washing; upon this is spread a piece of close canvas, and pressed down by a thin bed of river

sand. The cylinder or cask should be filled with these successive layers to within 2 inches of its top, and is then closed air-tight. Immediately below the head a hole is bored in the side for receiving an overflow tube, which is either screwed rectangularly to another elbow pipe or is bent so as to enter tight into a hole beneath the false bottom of the second cylinder or cask. In this way the series may be continued to any desired number of vessels; the last discharging the purified spirit into the store-barrel. The foul alcohol must be made to flow into the bottom space of the first cylinder down through a pipe in communication with a charging vessel, placed upon such an elevation as to give sufficient pressure to force the spirits up through the series of filters, the supply pipe being provided with a regulating stop cock.

To Purify Alcohol and Liquors. Cover 10 pounds of animal charcoal with a few inches of water, add $1\frac{3}{4}$ ounces of concentrated sulphuric acid, agitate the mixture thoroughly, and let it stand over night. Draw off the water the next day, and wash the mixture with fresh water until the latter has no longer an acid taste and does not redden litmus paper. The drained-off charcoal is then placed upon the perforated bottom of the filtering apparatus, covered with a layer of lixiviated straw $\frac{3}{4}$ to 1 inch thick. Upon this is placed another perforated bottom, and upon this a mixture of 1 pound of magnesia, 20 pounds of wood charcoal, and $5\frac{1}{2}$ pounds of pyrolusite. This is also covered with a layer of lixiviated straw and a finely-perforated plate upon which comes a thick layer of river sand previously washed and dried. The liquor to be purified is then compounded with $\frac{3}{4}$ ounce of spirit of ammonia to every 20 gallons. The liquor is allowed to remain quietly for a few days and is then gradually passed into the filter, where it remains for 3 days, when the purified liquor is drawn off and the filter replenished. This apparatus may be used for an entire year without renewing the filtering material.

To Remove the Taste of the Barrel from Whiskey, add a little good olive oil to it.

WINES. Bordeaux. It is best to use a light Hungarian red wine. Mix with 50 gallons 1 pint of kino, 2 to 3 ounces of sulphate of iron dissolved in 1 quart of boiling water, and 1 wine-glassful of extract of orris root and a like quantity of raspberry extract.

Burgundy. Mix in a barrel 100 parts of white wine, 10 of the juice of black cherries, 6 of crushed large raisins, 6 of pulverized cinnamon, $\frac{1}{2}$ of pulverized crude tartar, and 50 of most concentrated by evaporation; allow the mixture to ferment in a cool place, and then rack the wine into another barrel.

Champagne. The following process of manufacture is observed in champagne: Late in the fall the must of different grapes is brought and poured in large vats. In December, before fermentation is entirely completed, the wine is clarified with isinglass and racked into well-stoppered bottles. The bottles are then laid on their sides with their mouths sloping downwards at an angle of about 20 degrees, in order that any sediment may fall in the neck. At the end of a few days the inclination of the bottles is increased, and the slimy substances collected over the cork are from time to time dexterously discharged by a skilled workman opening the bottles. Every time the bottles are opened, 1 teaspoonful of rock-candy is added to each bottle. When no more sediment is collected in the neck, the bottles are corked with long corks by special machines, and wired.

Artificial Champagnes. Champagne Liqueur. Boil $8\frac{1}{2}$ pounds of the finest loaf sugar with 1 gallon of water, add gradually while the water is boiling $\frac{1}{2}$ gallon of alcohol of 90 per cent., and then filter the mixture.

The above liqueur is added to all the following compounds.

Chandon et Moet (Green Seal). Mix the above liqueur with $7\frac{1}{2}$ gallons of white wine and 1 quart of cognac.

Louis Köderer (Green and Bronze Seal). Mix the champagne liqueur with $7\frac{1}{2}$ gallons of white wine, 1 bottle of cognac, and 4 drops of sulphuric ether dissolved in cognac.

Heidesick et Cie. (Sealed with Tin-foil). Mix the champagne liqueur

with $7\frac{1}{2}$ gallons of white wine and $\frac{3}{4}$ pint of cognac.

Lemberg Geldermann et Deitzz (Sealed with Tin-foil). Mix double the quantity of champagne liqueur with $7\frac{1}{2}$ gallons of white wine and $\frac{3}{4}$ pint of cognac, in which 2 roots of celery, carefully cleansed, have been previously digested for 4 hours.

Schneider (Yellowish-green Seal). Mix the champagne liqueur with $7\frac{1}{2}$ gallons of wine, 1 bottle of cognac, and 3 drops of strawberry essence.

Fleur de Sillery (Sealed with Tin-foil). Mix the champagne liqueur with $7\frac{1}{2}$ gallons of white wine and 1 bottle of cognac, in which 4 roots of celery have been previously digested for 8 hours.

Jacquesson et Fils (Sealed with Tin-foil). Mix the champagne liqueur with $7\frac{1}{2}$ gallons of white wine and $1\frac{1}{2}$ pints of cognac.

The bottles are corked with champagne corks and laid on their sides with their mouths sloping downward. They are recorked the next day with the corking machine. The corks, before using them, must be laid in hot water, and before placing them in the machine, moistened with sugar syrup, and as soon as driven into the bottles tied with cord, and finally wired.

Madeira. Digest at a moderate heat 10 ounces of purified honey, 13 ounces of the strongest spirit of wine, $\frac{1}{2}$ ounce of hop tops, and 3 quarts of French wine, then add $\frac{1}{2}$ ounce of tincture of burned sugar, and filter the wine into bottles.

Malaga. Put 15 gallons of white *calabre* (white-wine must boiled down to $\frac{1}{2}$ of its volume), 7 gallons of red *calabre* (red-wine must boiled down to $\frac{1}{2}$ of its volume), 2 gallons of spirit of wine, and 1 wineglassful of *essence de Goudron* dissolved in spirit of wine in a barrel; fill the barrel full with light white wine and let it remain in a warm room about 4 to 6 weeks. Then color the wine with sugar color, but not too brown, and finally clear it with isinglass.

The *essence de Goudron* is prepared by allowing 1 pound of Swedish wood tar to stand for a few weeks with $1\frac{1}{2}$ pints of spirit of wine, shaking it fre-

quently, and finally drawing off the supernatant liquor.

Port Wine. Compound 100 gallons of old red wine with 10 to 15 per cent. of pure honey, and let the mixture ferment slowly in a warm room. When the sweet taste has almost disappeared, add $4\frac{1}{2}$ gallons of spirit of wine previously mixed with 2 quarts of kino. Should the wine not be dark enough, add some heavy red wine, or color with mallow blossoms.

To Improve Wine Must. Pulverize pure common salt, calcine it in a pan, and distribute it in the barrels in the proportion of $\frac{1}{4}$ ounce of salt to 15 gallons of must.

A Remedy for Ropiness or Viscidity of Wines is the bruised berries of the mountain ash in a somewhat unripe state, of which 1 pound, well stirred in, is sufficient for a barrel. After agitation the wine is left at rest for a day or two, and then racked off into another barrel, and finally cleared and bottled.

To Remove the Taste of the Barrel from Wine is best accomplished by agitating the wine for some time with a spoonful of olive oil. An essential oil, the chief cause of the bad taste, combines with the fixed oil and rises with it to the surface.

LUBRICANTS FOR MACHINES, WAGONS, ETC.

Adhesive Grease for Machine Belts. Lubricate the belts with castor-oil to which 10 per cent. of tallow has been added. This will make them flexible and augment their friction on the pulleys.

Grease for Water-proofing Leather. Twenty-four parts of oleic acid, 6 of crude stearic acid, 18 of ammoniacal soap, 3 of extract of tannin, and 24 of water. Melt the oleic acid together with the stearic acid, then add gradually the ammoniacal soap, the extract of tannin, and finally the water. The ammoniacal soap is obtained by adding to heated oleic acid, caustic ammonia until, after continued stirring, the odor of ammonia remains apparent and the whole congeals to a jelly-like mass. By adding a solution of 2 parts of sulphate of iron in 6 of water the grease

will assume a deep-black color, and is then very suitable for treating boots and shoes.

To Make Kid Leather Soft the following ointment has been recommended: Wax 30 parts, asphaltum 10, linseed oil 100, oil of turpentine 50, and olive oil 100. The wax and asphaltum are dissolved in the oil of turpentine with the aid of heat; the linseed oil and olive oil are mixed, heated, and added to the solution, and the mixture made homogeneous by stirring.

Lubricant for Industrial Purposes. Melt together 130 pounds of castor-oil, 20 pounds of animal fat, and 40 pounds of vegetable oil, as cotton oil, rape-seed oil, etc., then add 40 pounds of Indian meal, and let the whole boil for 30 minutes.

A Pulverulent Lubricant for axles, shafts, etc., is prepared by intimately mixing graphite with the white or yelk of eggs, rubbing the mixture fine after drying, and dusting the powder upon the parts of the machine while slowly revolving.

Doulon's Caoutchouc Lubricant. Two hundred parts of train oil are melted in a boiler until it commences to bubble and emits a peculiarly disagreeable odor; 20 parts of caoutchouc cut up in small pieces are then gradually added, stirring the mixture vigorously after every addition of caoutchouc.

Patent Wagon Grease from Rosin-oil Soap. Stir 90 pounds of powdered slaked lime into 100 pounds of rosin oil. Heat the mixture, constantly stirring it until a uniform paste of the consistency of syrup is obtained. This rosin-oil compound is a component of all the patent wagon grease.

Blue Patent Grease. Five hundred and fifty pounds of crude rosin oil are heated for 1 hour with 2 pounds of calcium hydrate and allowed to cool. The oil is skimmed off, and 10 to 12 pounds of rosin-oil soap are stirred in until all is of a buttery consistency and of blue color.

Yellow Patent Grease is prepared by adding 6 per cent. of solution of turmeric to the blue grease. The solution is obtained by boiling 1 part of turmeric with 20 of caustic lye.

Black Patent Grease is produced by adding lampblack rubbed with rosin oil in the proportion of 2 pounds to 100 pounds of the blue grease.

Patent Palm Oil Wagon Grease. Ten pounds of rosin-oil soap are melted with a like quantity of palm oil; 550 pounds of rosin-oil are then added, and as much rosin-oil soap to give the whole the consistency of butter, and finally $7\frac{1}{2}$ to 10 pounds of caustic soda-lye.

Lubricant from Paraffine Residues. The thick sediment deposited in the manufacture of paraffine is used as a lubricant on account of its cheapness and longer retention of its fluidity in the cold. It is thickened by being mixed with lead soap. Mixtures of rosin-oil or rosin-oil soap and petroleum, with glycerine also, are often used as lubricants.

Consistent Machine Oil. The boiler used for manufacturing consistent machine oil should have a capacity of twice the quantity of ingredients to be boiled in it. Ten pounds of tallow are melted in 20 pounds of rape-seed oil in a capacious boiler over a moderate fire, and 10 pounds of lime after being slaked in 5 gallons of water poured in. Increase the fire sufficient to boil the mass until a scum arises to the surface, constantly stirring to prevent burning, then add 70 pounds of rape-seed oil, in 10 pound portions at a time, and continue the boiling over a moderate fire until a homogeneous mass is produced, samples of which should be constantly taken and tested.

When the sample is cool enough touch it with the finger, and if a long thread can be drawn it has acquired the proper consistency. Too much condensation by boiling renders the mass insoluble in paraffine oil and worthless. When at a proper consistency, stir in gradually 100 pounds of heavy yellow paraffine oil, and, when the heat has sufficiently subsided, which is tested by dropping a few drops of water into the boiler, add 25 to 30 per cent. of water. Increase the heat and boil gently. The fire should be so arranged that it can be reduced on the instant, and a ready supply of cold water kept on hand to check excess of ebullition. Five hundred pounds of paraffine oil are added in

portions small enough not to interrupt the boiling, and after the prior portion has been amalgamated. The quantity of paraffine oil may be increased to 800 or 900 pounds. After amalgamation of all the paraffine oil allow the boiler to cool, and remove the grease, while still warm, into an agitator, and stir until it congeals. Should it be too stiff, reduce by stirring in sufficient oil to attain the proper consistency. The odor of the paraffine oil can be destroyed by an addition of mirbane oil.

A Lubricant for Belts, which has stood a practical test, is prepared by heating 50 parts of linseed oil and 24 of ordinary turpentine on a water-bath, and adding gradually and with constant stirring 23 parts of rosin finely pulverized, and finally 1.5 parts of medium fine colcothar. The mixture is then allowed to cool.

French's Machine Grease. Mix together at a boiling heat 1000 parts of petroleum, 88 parts of graphite, 3 parts of beeswax, 9 parts of tallow, and 3 parts of caustic soda.

Lubricant for Car Axles. Melt together at a moderate heat 10 parts of dark ozocerite and 2 to 4 of heavy petroleum. This is also very suitable for heavy wagons.

Belgian Wagon Grease. Melt in a large open boiler 30 parts of palm oil and 12 of tallow, and add gradually 9 parts of soda-lye. When the mass commences to thicken add, with constant stirring, 8 to 10 parts of boiling rain water, let the mixture stand for 1 hour in the air, then pour it into a cooling vessel and, after having worked it thoroughly for 2 hours, add 120 parts of cold rain water.

Excellent Carriage Grease. Melt in an open, capacious iron boiler over a moderate fire 1 part of red, transparent rosin and 1 of rendered tallow. When the melting is complete add gradually and with constant stirring 1 part of caustic soda-lye. When the mixture ceases to rise add 1 part of linseed oil; let the whole boil for $\frac{1}{2}$ hour, strain while boiling hot through a cotton cloth into a clean vessel, and let it cool. This will give a beautiful lemon-colored, buttery grease which does not gum.

Lubricant from Oil Residues. Place

in a boiler of the right capacity 500 parts of oil residue and 100 parts of water, and bring them slowly to the boiling point. When all the oil is dissolved add in small portions 40 to 50 parts of hydrochloric acid of 8° to 10° B. Then let the mixture boil and stir for $\frac{1}{2}$ hour. After this time, if the decomposition is complete, the acid forms a combination with the oil residues and the grease is liberated in the form of a thick oil. After resting for 24 hours the water containing the salts and excess of acid is drawn off, and the oil several times washed with a large quantity of water to free it from the last traces of acid. It is finally mixed with 10, 20, or 30 per cent. of tallow, the quantity depending on the thickness of the oil.

Pyroleine (Lubricant for Machinery). Sixty parts of crude rape-seed oil are slowly boiled with 3.5 parts of red lead until the latter, which floats on the surface, has become entirely brown. After ascertaining that no red lead remains in the mixture it is allowed to cool slowly and decanted. The rape-seed oil thus purified is well adapted for lubricating steam-engines and heavy gears. For lubricating spindles it is diluted with 30 to 50 per cent. of mineral oil or shale oil.

Thinly-fluid Pyroleine. Ten gallons of rape-seed oil are gradually heated in a copper boiler of 20 gallons, capacity. The boiling is continued till carbonic acid, acroleine, and other decomposed gaseous products are noticed. After $\frac{1}{2}$ hour finely-pulverized minium is sifted upon the surface of the oil, the oxidizing effect of which upon the albuminates of the oil will be accompanied by the formation of a white froth. The heating is discontinued as soon as black lumps show themselves upon the surface; the oil is then allowed to cool, the clear portion poured off into a metal vessel and allowed to stand quietly until entirely clear.

Thickly-fluid Pyroleine. Twenty gallons of rape-seed oil are heated with $2\frac{1}{2}$ pounds of minium and, while yet hot, poured into a metal vessel and mixed with mineral oil, shale oil, or any other very thinly-fluid oil until the pyroleine has the desired consistency; for instance, that of a fat oil. The oil is cleared by allowing it to stand in a room heated in winter to 65° F.

Metalline. In using this lubricant for journals no grease of any kind is required. Metalline, according to the descriptions of the American patent, is very ductile. The first receipt consists in grinding together 80 parts of finely-ground pock-wood with 20 of spermaceti. There are 13 more receipts:

I. Eighty parts of ivory dust and 20 of spermaceti.

II. Ninety-nine parts of tin and 1 of residue of petroleum.

III. Ninety-five parts of zinc and 5 of melted caoutchouc.

IV. Ninety parts of anthracite and 10 of tallow free from oil.

V. Ninety-eight parts of bronze (best of 93 per cent. of copper, 6 per cent. of tin, and 1 per cent. of lead or zinc) and 2 of melted caoutchouc.

VI. Ninety-six parts of type-metal and 4 of melted caoutchouc.

VII. Ninety-five parts of oxide of tin and 5 of beeswax.

VIII. Fifty parts of iron, $\frac{1}{2}$ of paraffine, and 50 of tin.

IX. Eighty parts of lead and 20 of cannel coal.

X. Ninety-two parts of fresh bones and 8 of beeswax.

XI. Ninety parts of prepared alumina and 10 of spermaceti.

XII. Ninety-five parts of copper glance, as free from quartz as possible, and 5 of melted caoutchouc.

XIII. Eighty-six parts of lead, 12 of lampblack, and 2 of beeswax.

New Lubricant for Machines, from Sea-weed. I. *Solid Lubricant.*

Boil carrageen (*Fucus crispus*) to a thick jelly and mix with it flour in the proportion of 1 part flour to 30 of jelly. To 15 parts of this compound add in the order as given 1 part of ordinary soap, $1\frac{1}{2}$ of tallow, both in a fluid state, 1 of palm oil, and $\frac{1}{2}$ of graphite. In place of the fatty ingredients the following may be used: $\frac{1}{2}$ part of tallow, $\frac{3}{4}$ of finely-pulverized soapstone, and 1 of ordinary soda. When all have been melted over a fire and thoroughly mixed together the compound is poured through a fine sieve and vigorously stirred until it congeals.

II. *Liquid Lubricant.* The above jelly of carrageen is also the basis of this. With 10 parts of it are mixed 8 parts of lard oil, or 4 of lard oil and 4 of

rape-seed oil, $\frac{1}{2}$ of pulverized soapstone, and $\frac{1}{2}$ of solution of caustic potash of 10° B. The mixture is, with constant stirring, brought to the boiling point, then passed through a fine sieve and stirred until cold.

Lubricating Oil for Astronomical Instruments. A solution of 1 part of rosin in 20 of finest olive oil is especially well adapted for the purpose. It does not become rancid and forms no verdigris.

VULCAN OIL. *For Spindles.* Ninety parts of distilled oleine free from mineral acid, and 10 of purified petroleum.

For Carding Engines. Ninety-five parts of distilled oleine free from mineral acid and 5 of purified petroleum.

For Hydraulic Motors. Ninety parts of distilled oleine free from mineral acid, 5 of lard, 2 each of purified petroleum and graphite.

Machine-oil from Coal-tar Varnish Oil. Mix intimately 25 parts each of purified heavy rosin oil, ordinary olive oil, and varnish oil, and keep it in well-closed tin cans.

This composition is a very fine lubricant for steam-engines, valves, etc. It does not congeal nor gum, but the reverse, dissolves resinous substances, and leaves no unpleasant odor. It evolves no inflammable vapors, and does not attack metals.

Lubricant for Carriages from Coal-tar Varnish Oil. Melt in a shallow iron boiler 5 parts each of stearine and tallow and 1 part of paraffine, all of an inferior quality, then add 20 parts of heavy rosin oil and stir the compound until it begins to cool, then add 4 parts of caustic soda-lye of 10° B.; continue stirring until all are intimately mixed, and then add gradually 10 parts of coal-tar varnish oil. The compound, when it has assumed the consistency of wagon-grease, is packed in boxes. In summer it may be necessary to increase the quantity of stearine and tallow somewhat, to prevent the fat from penetrating through the boxes.

Persoz's Patent Wagon-grease. Heavy paraffine oil, rosin oil, tallow, of each 60 parts, and oleic acid 30 parts. Melt the tallow by heating it in the oils, and saponify the mixture by adding 15 parts of finely-pulverized burned lime and 6 parts of soda-lye of 40° B.

Oil for Watch-makers. It is best to use the purest olive oil, after it has been stored for some time, and expose it to a temperature a few degrees below the freezing point, which will cause all foreign substances to separate. The supernatant clear oil is then carefully poured off and filtered through a cup of linden wood or pit of elder wood. By this process an oil is obtained which will remain liquid for several years, and does not attack the delicate machinery.

Neat's-foot oil treated in the above manner furnishes a less useful oil, since it loses much fatty matter by exposure to cold.

A very useful oil is obtained by dissolving 1 part of pure neat's-foot oil in 3 of pure benzine. Allow the compound to remain for several days in a closed vessel, then filter and expose the solution to a temperature of 40° F., at which it is again filtered and the benzine distilled off. The oil should be kept in small, dark vials protected from the air.

A very fine lubricant for clocks and watches is, according to Artemus, obtained by mixing 2 parts of solar oil and 1 of rape-seed oil.

To Test the Fitness of Oils for Lubricating Watches and Clocks, pour a drop of the oil to be tested upon different metal plates, as iron, brass, tin, lead, etc., keep them in a place free from dust, and examine the drops during 8 to 14 days in regard to their liquidity. Oil remaining liquid after the lapse of this time can be safely used.

MARINE GLUE.

This glue is water-proof and can be used to cement metal, wood, glass, stone, pasteboard, etc., and is especially adapted for calking vessels.

Hard Marine Glue. Suspend 10 parts of caoutchouc enclosed in a linen bag in a vessel containing 120 parts of refined petroleum, so that only $\frac{1}{2}$ of the bag is immersed, and allow it to remain 10 to 14 days in a warm place. Then melt 20 parts of asphaltum in an iron boiler, and add the caoutchouc solution in a thin jet, and heat the mixture, while constantly stirring, until it is

perfectly homogeneous. Pour it into greased metallic moulds, where it forms into dark-brown or black plates difficult to break. When it is to be used it should be melted in a kettle placed in boiling water to prevent its burning, which it is very apt to do, as it is a bad conductor of heat. After it has been liquefied, remove the kettle from the water and place it over a fire, where it can be heated, if necessary to make it more fluid, to 300° F., carefully stirring it to prevent burning.

If possible, the surfaces to be glued together should be heated to 212° F., as the glue can then be slowly applied. The thinner the layer of glue in cementing together smooth surfaces, the better it will adhere. But a somewhat thicker layer is required for rough surfaces (for instance, boards not planed), the excess of glue being forced out by strong pressure. Generally speaking it is best to subject all articles cemented together by marine glue to as strong a pressure as possible until the glue is congealed.

We are fully convinced by experiments that, with the aid of this glue, square vats, perfectly water-tight, can be constructed from boards. Wooden pins dipped in the marine glue should be used for putting the vats together.

Elastic Marine Glue. This is a solution of caoutchouc in a suitable solvent, as benzole, bisulphide of carbon, naphtha, or chloroform, principally used for coating ropes and other materials exposed to the alternate action of air and water. It can be cheapened by adding very fine sand or whiting.

Marine Glue for Damp Walls. Dissolve 10 parts of caoutchouc, 10 of whiting, 20 of oil of turpentine, 10 of bisulphide of carbon, 5 of rosin, and 5 of asphaltum in a suitable vessel situated in a warm place and frequently shaken. Scrape the wall smooth and clean, and apply the glue with a broad brush to the wall on the damp place, and about 8 inches higher than the line of dampness, and before the glue is dry lay on plain paper, which will adhere tightly. On this plain paper the wall-paper can be pasted in the usual manner. If carefully done the wall-paper will always remain dry.

MATCHES.

Swedish Matches are made in Sweden almost exclusively of white poplar wood, it being the cheapest. Blocks of the length of the match are cut by machinery from the round logs and splintered, the splints kiln-dried and coated with paraffine. The end to be covered with the inflammable compound is dipped in a solution of paraffine in benzine, when they are again dried. They are then dipped into the inflammable compound, which should be of such a consistency that only small drops remain adhering to the stick. The following mixtures are used :

	PARTS.			
	I.	II.	III.	IV.
Chlorate of potassium	2000	2000	2000	4000
Plumbic dioxide . . .	1150	2150		
Minium	2500	2500		
Antimony trisulphide	1250	1250	2000	4000
Chromate of potassium	1318		750	1500
Gum-Arabic	670	670	670	670
Paraffine	250	250		

In Nos. I. and II. the paraffine is first rubbed up with the antimony and then incorporated with the compound. The compound ignites easily and transmits the flame quickly to the wood. Matches with compound No. II. ignite well and burn quietly. Matches with No. III. ignite easily on the striking surface and quickly transmit the flame to the wood. Compound No. IV. furnishes matches exactly like those of the *Jönköping* product; they ignite easily on the striking surface, transmit the flame quickly to the wood, burn quietly and without noise. The brown color of Swedish matches is due to the antimony trisulphide in the compound.

Striking Surface of Swedish Matches consists of a compound prepared by mixing 9 parts of amorphous phosphorus, 7 of iron pyrites pulverized and sifted, 3 of pulverized glass, and 1 of glue or gum with the requisite quantity of water.

Matches without Sulphur, which can be ignited by friction on any surface and do not absorb moisture from the air, are prepared by dipping the matches into a hot solution of any kind of fat, and using the following inflam-

mable compound : Seven parts of phosphorus, 7 of gum-Arabic, 40 of lead nitrate, 5 of pulverized glass, and 10 of water.

Inflammable Compounds. *H. Schwarz* recommends the following mixtures as giving excellent results : I. One part of pulverized sulphur is melted in warm water with 4 of yellow phosphorus. Most of the water is then poured off and the fluid mixture rubbed intimately with 4 parts of dextrine gum. Now compound 45 parts of minium with $1\frac{1}{2}$ equivalent of nitric acid, dry the mixture, pulverize it, and add it gradually to the phosphorus mixture. The matches are saturated with solution of pine rosin in alcohol, and dried at a moderate heat.

II. Mix 1 part of phosphorus, 5 of chalk, 2.8 of anhydrous gypsum, 6 of pulverized glass, and 6 of some agglutinant and coloring matter. This compound requires a rough striking surface, ignites with a slight report, and does not absorb moisture.

Inflammable Compound without Phosphorus. Thirty-six parts of plumbic dioxide, 15 of chlorate of potassium, 9 of manganese dioxide, 8 of flowers of sulphur, 6 each of infusorial earth, pulverized glass or sand and amorphous phosphorus, and 8 of glue.

The compound ignites by friction on any surface.

Parlor Matches. The sticks are first thoroughly dried, then soaked with stearic acid, and finally dipped into an inflammable compound prepared from 3 parts of phosphorus, $\frac{1}{2}$ of gum tragacanth, 3 of water, 2 of fine sand, and 2 of red lead. To perfume the matches they are dipped, after the compound is dry, into a solution of aromatic gum, made of 4 parts of benzoin in 10 of spirit of wine of 40° B.

Colored Parlor Matches. The inflammable compound on the end of the matches may be coated with different colored lacquers to give a variegated appearance when placed in boxes.

The lacquers are prepared in the following manner : Eight parts of pulverized rosin are dissolved in a hot mixture of 200 parts of alcohol and 4 parts of glycerine, and 40 parts of solution of shellac added to the hot

solution. The whole is then thoroughly agitated and, while yet warm, compounded with the necessary quantity of coloring matter, and finally allowed to cool.

The green iridescent bronze color, which is in great demand, requires for the above solution of lacquer 80 parts of crystallized fuchsine, or 28 parts of methyl-violet. To produce violet an addition of only $\frac{1}{2}$ part of methyl-violet is required; for blue $\frac{2}{3}$ part of aniline blue soluble in water; for orange 4 parts of aniline orange; for blue-green $\frac{1}{2}$ part of methyl-green. For yellow-green 2 parts of blue-green are mixed with 1 of orange; and for red 32 parts of coralline with an addition of 2 parts of caustic soda-lye, dissolved in the above lacquer.

All these colors cover easily the head of the match, and, when dry, possess the brilliant gloss desired.

Anti-phosphorus Matches. The paste for the friction surface consists of minium, sand, and amorphous phosphorus rubbed up with a solution of gum-Arabic and applied with a brush; or of 10 parts of amorphous phosphorus, 8 of pyrolusite or antimony trisulphide, and 3 to 6 of glue dissolved in water. To prepare the matches the ends are first dipped into melted sulphur, stearic acid, or wax, and then into a compound of 6 parts of chlorate of potassium and 2 to 3 of trisulphide of antimony mixed with a solution of 1 part of glue in water. It must be remarked here that the mixture of bichromate of potassium and antimony is exceedingly dangerous, as it is easily ignited by a shock or friction.

Matches Inextinguishable by the Wind. Sheets of paper, thin pasteboard, or wood are saturated with a solution of saltpetre in water to which has been added some substance emitting an agreeable odor while burning. When the sheets are dry, a thin layer of a phosphorus compound, as is used in the manufacture of friction matches, and to which some incombustible substance, as pulverized glass, fine sand, etc., has been added, is placed between two of them, leaving a part of one end free for handling. When dry the 2 sheets are pasted together, and this is cut up into strips of suitable shape.

These strips are then coated with a varnish to protect them from moisture and to prevent their ignition by friction during transportation, etc. Colored varnish may be used to distinguish the part containing the phosphorus from the ends of the sheet left uncoated.

Matches without Phosphorus. Prepare a paste of 10 parts of dextrine, 75 of pulverized chlorate of potassium, 35 of pulverized plumbic dioxide, and a like quantity of pulverized pyrites with the necessary quantity of water, and dip the end of the splints into the compound.

Matches without Phosphorus, of an excellent quality, and in the manufacture of which there is not the slightest danger, are obtained from the following mixture: 53.8 parts of chlorate of potassium, 10 of gum-Arabic, 3 of gum tragacanth, 6 of pyrolusite, 6 of ferric oxide, 12 of pulverized glass, 5 of bichromate of potassium, 3 of sulphur, 1.2 of chalk, and sufficient water.

Paraffine or sulphur is used for transmitting the flame to the wood. The matches can only be ignited by being struck on a surface composed of the following mixture: Five parts of antimony trisulphide, 3 of amorphous phosphorus, 14 of pyrolusite, and 4 of glue.

Amorces d'Allumettes are matches prepared from 20 parts of phosphorus, 5.5 of gun-cotton, 5 of pulverized wood charcoal, 5 of iron filings, 51.5 of sulphur, and 10 of gum.

Nickle's Process of Preparing an Amorphous Phosphorus from the Ordinary Article. The conversion of ordinary into amorphous phosphorus is accomplished by heating ordinary phosphorus from 446° to 482° F. in a closed iron boiler. After 3 or 4 weeks the phosphorus is found to be converted into a red, brittle mass which is ground by millstones under water, and separated from the ordinary phosphorus either by bisulphide of carbon or caustic soda, in which the latter is soluble. The temperature requires careful regulation, for if it is allowed to rise to 500° F. the amorphous phosphorus quickly resumes the ordinary condition, evolving the heat which it had absorbed during its conversion, and thus converting much of the phosphorus into vapor. This reconversion may be shown by

heating a little amorphous phosphorus in a test-tube, when drops of ordinary phosphorus condense on the cool part of the tube. Ordinary phosphorus is very poisonous, while amorphous phosphorus appears to be harmless. The vapor of phosphorus produces a very injurious effect upon the persons engaged in the manufacture of matches, resulting in the decay of the lower jaw. This evil may be greatly mitigated by good ventilation or by diffusing turpentine vapor through the air of the work-room, or may be entirely obviated by substituting amorphous phosphorus for the ordinary variety.

METAL INDUSTRY.

To Harden Cast Iron. Mix 2 pounds of concentrated sulphuric acid and 2 ounces of nitric acid with $2\frac{1}{2}$ gallons of water. Immerse the article at a cherry-red heat in this mixture. The surface becomes very hard.

To Give Iron Articles a Brilliant Lustre and Silvery Appearance. Pour 1 pint of alcohol of 90 per cent. over $\frac{3}{4}$ ounce of antimony trichloride (butter of antimony), $1\frac{1}{2}$ drachms of pulverized arsenious acid, and $1\frac{1}{2}$ ounces of elutriated bloodstone, and digest the whole at a moderate heat, frequently shaking it. In polishing the articles with this fluid a thin film of antimony and arsenic is precipitated upon them, which gives a beautiful appearance to the surface and protects it against oxidation.

To Restore Burnt Cast Steel. Heat the article to a red heat and dust it with a mixture of 8 parts of red chromate of potassium, 4 of saltpetre, $\frac{1}{2}$ each of aloes and gum-Arabic, and $\frac{1}{4}$ of rosin. Then heat it several times and cool it. If the article is to be especially hard take 8 parts of saltpetre and 3 of rosin.

To Make Steel so Soft that it can be Worked like Copper. Pulverize beef bones, mix them with equal parts of loam and calves' hair, and stir the mixture into a thick paste with water. Apply a coat of this to the steel and place it in a crucible, cover this with another, fasten the two together with wire, and close the joint hermetically with clay. Then place the crucibles in the fire and

heat them slowly. When taken from the fire let them cool by placing them in ashes. On opening the crucibles the steel will be found so soft that it can be engraved like copper.

Welding Steel to Cast Iron may be accomplished by first shaping the steel so that it will correspond to the surface of the cast iron to which it is to be welded without forming a lap, then heating to a cherry-red, next applying borax to the surfaces to be united, and immediately heating the parts to a welding heat, after which a strong pressure applied without hammering will securely join the steel to the iron.

Hardening and Welding Compounds.

I. Hardening Compound. Pulverize and mix intimately 1 part of prussiate of potash, 1 of purified saltpetre, 1 of calcined cows' hoofs, $\frac{1}{8}$ of gum-Arabic, $\frac{1}{8}$ of aloes, and $\frac{1}{2}$ of common salt. Scatter the compound upon the steel while at a red heat and upon the wrought iron while at a white heat, and burn it thoroughly in. After cooling the hardened parts will be as hard as steel.

II. Welding Compound for welding wrought iron to wrought iron at a red heat: 1 part by weight of borax, $\frac{1}{2}$ of sal-ammoniac, and $\frac{1}{2}$ of water. Boil these ingredients, with constant stirring, until the mixture is stiff, and then allow it to harden over the fire. When cool the compound is pulverized and intimately mixed with $\frac{1}{4}$ part of wrought-iron filings free from rust. The pieces to be welded together are first dovetailed or tied together, and the place to be welded is made red hot; the powder is then scattered upon it and liquefied over the fire. A few light taps with the hammer suffice to join the two pieces together.

III. Welding Compound to Weld Steel to Wrought Iron at a Red Heat. Pulverize and mix with water 6 parts by weight of borax, 2 of sal-ammoniac, 1 of prussiate of potash, and $\frac{1}{2}$ of rosin. Boil the compound, stirring it constantly, until it forms a stiff paste, which is allowed to harden over the fire. When cold pulverize it and mix it with 1 part of wrought-iron filings free from rust. In using it scatter the powder upon the red-hot pieces and liquefy it over the fire.

IV. Welding Compound to Weld Wrought Iron to Wrought Iron at a

White Heat. Pulverize and mix 1 part by weight of sal-ammoniac, 2 of borax, 2 of prussiate of potash, and 4 of wrought-iron filings free from rust. Heat the pieces to be welded together to a white heat, then scatter the powder 2 or 3 times upon the proper place, and liquefy it. Two or 3 vigorous taps with the hammer will then suffice to join the pieces.

V. Hardening Compound to Make Wrought Iron Very Hard. Cut into small pieces 1 part by weight of cow or horse's hoof and 2 of old leather, and add $\frac{1}{2}$ of common salt. These ingredients are placed in a heating-box together with the pieces to be hardened. The box is hermetically closed with clay and heated for 1 hour at a red heat, when the pieces are taken out and cooled in cold water.

Welding Cast Steel. Take 64 parts of borax, 20 of sal-ammoniac, 10 of ferrocyanide of potassium, and 5 of rosin. The whole is boiled with the addition of some water, under constant stirring, until a homogeneous compound is formed, which is allowed to dry out slowly in the same iron vessel in which it has been boiled. An analysis of a sample of this welding compound formed the basis for the composition of the following compound, which is highly recommended. The welding is accomplished at a light-yellow heat, or between that and a white heat, and, as the quality of the steel is not in the least affected, it needs no further treatment. The compound is composed of 61 parts of borax, $17\frac{1}{2}$ of sal-ammoniac, $16\frac{1}{2}$ of ferrocyanide of potassium, and 5 of rosin. For welding steel to steel less of the ferrocyanide may be used. The borax and sal-ammoniac are pulverized, mixed, and gradually heated in a porcelain or iron vessel, until both melt in the water of crystallization of the first. A strong odor of ammonia is developed. The heating is continued, under constant stirring, until the odor of ammonia is scarcely perceptible, water being added from time to time to replace that lost by evaporation. The pulverized ferrocyanide and the rosin are then added, and the heating continued, under constant stirring, until a thick paste has been formed.

As soon as a weak odor of cyanide is perceptible the heating is interrupted,

as otherwise the boric acid would exert a decomposing effect upon the ferrocyanide of potassium. The thick paste is spread upon a sheet-iron plate in a layer at the utmost $\frac{1}{2}$ inch thick, and dried at a very moderate heat. To facilitate the drying, the paste is loosened and turned with a spatula, so that lumps are formed, which are stored away. When it is to be used a sufficient quantity of one of the lumps is pulverized and scattered upon the article to be welded, which has been heated to a light-red heat. It is then heated to a strong yellow heat and the welding accomplished in the usual manner.

In the above compound, and manner of preparing it, boracic acid and common salt are formed from the borax and sal-ammoniac, while ammonia escapes. The welding compound can therefore be directly prepared by mixing the following ingredients: 41.5 parts of boracic acid, 35 of pure, dry, common salt, 15.5 to 26.7 of ferrocyanide of potassium, 7.6 of rosin, and perhaps 3 to 5 of dry carbonate of sodium.

This mixture does excellent service, is, in fact, as good as the above compound and far easier prepared. It has only the disadvantage of not remaining entirely unaltered if kept for any length of time, but gradually decomposes and assumes a blue color. But this, as the compound is so easily prepared, is a minor evil.

To Harden Files and other Steel Instruments. The files, etc., are first coated with a paste prepared by boiling glue and salt in yeast, and thickened by an addition of wood charcoal and graphite (black lead). Upon this coat is scattered a coarse powder consisting of a mixture of horn, wood charcoal, and common salt. A solid crust is formed upon the files which protects them from a displacement of the cuts by the metal and conveys to them oxygen while being heated. For tempering, the files are brought into a lead bath. To prevent the oxidation of the lead on the surface a mixture of potash, soda, and tartar is scattered upon it. The files remain in the bath from 5 to 8 minutes, according to their thickness, and are then immersed in water.

To Re-sharpen Files. Well-worn

files are first carefully cleansed with hot water and soda; they are then brought into connection with the positive pole of a battery, in a bath composed of 40 parts of sulphuric acid and 1000 of water. The negative is formed of a copper spiral surrounding the files but not touching them; the coil terminating in a wire which rises to the surface. This arrangement is the result of practical experience. When the files have been in the bath for 10 minutes they are taken out, washed, and dried, when the whole of the hollows will be found to have been attacked in a sensible manner; but should the effect not be sufficient, they are replaced in the bath for the same period as before. Sometimes two operations are necessary, but seldom more. The files thus treated are to all appearance like new ones and good for 60 hours' work.

Hardening Compound for Thin Steel. Dr. Hartmann recommends to add about 1 pound of rosin to the usual mixture, composed of 1 gallon of train oil, 2 pounds of beef suet, and 4½ ounces of wax. He also recommends another compound, consisting of 95 parts of spermaceti oil, 10 of melted tallow, 4½ of neat's-foot oil, ½ of pitch, and 1½ of rosin.

New Process of Hardening Gun-barrels. The barrel to be hardened is placed in a gas-pipe of suitable size, the lower end of which is made narrow to prevent the barrel from slipping out while in a vertical position. Several of such pipes containing gun-barrels are then heated to a red heat in a reverberatory furnace, when some hardening compound is thrown into every barrel. The pipes are now taken from the furnace, placed in a vertical position under a hose, and hardening water is passed through each barrel under a pressure of ½ to ¾ atmosphere. It is very suitable to add a small quantity of sulphuric and nitric acids to the hardening water.

To Harden Steel in Sealing-wax. Watch and clock-makers and engravers harden their steel in sealing wax. The article is heated to a white heat and thrust into sealing-wax, allowed to remain for a second, then withdrawn, and again inserted in another part. This treatment is continued till the steel is

cold and will no more enter the sealing-wax. The extreme hardness of steel thus prepared enables it to engrave or bore steel hardened by other processes, the boring or engraving tool being first dipped in oil of turpentine.

Hardening Water. Two quarts of water, 1 quart of urine, 1½ ounces of saltpetre, 2 ounces of common salt, and ½ ounce of sal-ammoniac.

Poncelet's Fluids for Hardening Steel Articles. I. Ten pounds of rosin, 5 pounds of train oil, 2 pounds of lard, and 4½ ounces of assafoetida. By using this bath the steel, even if frequently heated, retains its former peculiarities.

II. This is especially used for hardening cutlery. Two pounds of refined borax, 4 pounds of sal-ammoniac, 3 quarts of water, and 4 ounces of French red wine.

III. Three pounds of sal-ammoniac, 1 pound of potash, 4 gallons of water, 1½ pints of red wine or wine vinegar, and 1 pound of tartaric acid.

New Case-hardening Compound. This compound is very efficacious for case-hardening iron. It consists of 16 parts of lampblack, 18 of sal-soda, 4 of muriate of soda, and 1 of black oxide of manganese.

To Obtain Smooth Castings it is highly recommended to mix with the green sand forming the mould about $\frac{1}{10}$ part of tar. The mixture is employed without the addition of any other substance.

To Harden Saws and Springs. The following composition is highly recommended: Four and a half pounds of suet and 8½ ounces of beeswax are boiled with 2½ gallons of whale oil. This will serve for thin articles and most kinds of steel. For thicker pieces about 2½ pounds of black rosin is added to the above compound, but it should be judiciously added, or the articles will become too hard and brittle. The usual way of proceeding is to heat the saws in long furnaces and then to immerse them horizontally and edgewise in a long trough containing the composition. Two troughs are generally used alternately. Part of the compound is wiped off with a piece of leather when the articles are removed from the trough. They are then heated one by one over a clear coke fire until

the grease inflames; this is called "blazing off." When the saws are wanted to be rather hard, but little of the grease is burned off; when less, a large portion; and for a spring temper the whole is allowed to burn away. When the work is thick or irregularly thick and thin, as in some springs, a second and third application is burned off to insure equality of temper at all places.

To Convert Iron into Steel. J. H. Wilson, of Liverpool, uses the following process which he has patented in England: Forty-six pounds of wrought-iron waste, 2 pounds of spiegel iron, $\frac{1}{4}$ of ferro-manganese, and 6 ounces of wood charcoal are melted together; to this may be added $\frac{1}{2}$ ounce of borax and $\frac{1}{2}$ ounce of chlorate of potassium.

Hard Silver. By melting together 100 parts of silver, 3.5 parts of iron, 2 parts of cobalt, and $\frac{1}{2}$ part of nickel, a compound is obtained which, by cooling in cold water, becomes hard as glass, and in hot water as hard as spring steel.

Malleable Brass. Thirty-three parts of copper are liquefied in a loosely-covered crucible, and 25 parts of purified zinc added under constant stirring. The zinc must be as free from iron as possible, and the copper from lead. The alloy is cast in moulding sand into bars. It is easily wrought at a red heat; in a cold state it can be stretched under the hammer; at a white heat it spits (scatters) under the hammer.

Very Tenacious Brass is prepared from 54 parts of copper and 46 of zinc, but both metals must be absolutely free from tin and lead.

Steel Wire for Musical Instruments. It is of the greatest importance that these wires should possess great solidity combined with a certain degree of elasticity. It becomes, therefore, necessary to anneal the wires to a certain degree after they have been hardened, the accomplishment of which presents many difficulties.

Webster and Horsfall first harden the wire by heating it to a red heat and then cooling suddenly. To obtain a constant temperature for annealing they use a metallic mixture of 40 parts of lead, 26 of antimony, 22 of tin, 21 of zinc, and 1 of bismuth. These ingredi-

ents are melted together in a wrought-iron vessel, carefully stirred, and heated to just above the melting point. The hardened wire to be annealed is then brought into this bath and kept there, according to its thickness, sufficiently long to acquire a uniform temperature. It is then cooled by immersing in water, which will give it all the qualities demanded for piano strings.

To Weld Copper. A mixture is employed composed of 358 parts of phosphate of sodium and 124 of boracic acid. The powder is applied when the metal is at a dull-red heat; it is then brought to a cherry-red, and at once hammered. As the metal is very apt to soften when exposed to a high degree of heat, a wooden hammer is recommended. All carbonaceous matters must be carefully removed from the surfaces to be joined, as the success of the operation depends on the formation of a very fusible phosphate of copper, which would be reduced by the carbon to the state of a phosphide. The phosphate of copper dissolves a thin film of oxide on the surfaces of the metal, keeping these clean and in a condition to weld.

Another Process is as follows: The two pieces of copper to be united having been previously shaped so that the surfaces form a lap or other suitable joint, borax is applied on and between the surfaces of the joint, which are then heated and hammered. The borax is prepared by being heated until all the water of crystallization has evaporated, when the residue is pulverized for use. After being hammered while hot, the joint is further heated to a white heat, and sprinkled over with common salt or other equivalent compound suitable for the exclusion of oxygen, and then welded; or during the welding operation a current of chlorine gas may be directed upon the heated copper joint.

New Process of preparing Malleable Nickel. Nickel in a melted state absorbs considerable quantities of oxygen becoming thereby brittle and unsuited for working. The evil can be remedied by adding to the melted nickel a substance which not only absorbs oxygen, with avidity, but possesses also great affinity for nickel. The object is partly

attained by an addition of metallic manganese, as is done in the fabrication of steel; but this, like all other easily combustible metals, disappears in remelting, and leaves the nickel as brittle as ever. The best means is an addition of phosphorus in the form of a salt, which is obtained by melting together a mixture of phosphate of lime, silica, coal, and nickel, enclosing about 6 per cent. of phosphorus. Nickel containing about 0.025 per cent. of phosphorus has been rolled out cold to a sheet 0.019 inch thick. In alloying with copper, phosphorus-nickel acts more favorably than the pure metal, the casting being cleaner and more uniform. Phosphorus makes it also possible to alloy nickel with iron in all proportions, and to always obtain soft and malleable products.

Dense and Flexible Copper Castings are obtained by adding cryolite and sugar of lead to the copper after it is melted. The proportions are as follows: Two pounds of pulverized cryolite and 8½ ounces of sugar of lead to 200 pounds of copper; a further addition of 2 pounds of borax being also advisable. The quantities of the additions may be varied according to circumstances. The mixture of cryolite and sugar of lead, with or without borax, is added after the copper is melted. When the compound is entirely melted, which will be the case in 10 to 15 minutes, the melted copper is poured into the mould.

Copper Steel is obtained by melting together 3 parts of fluo-silicate of potassium and 1 each of soda and copper at such a temperature that the metal is covered with a very liquid slag, and the copper beneath it forms silicide of copper, containing 12 per cent. of silicium, and is as white as bismuth, and hard. An alloy containing 4.8 per cent. of silicium has a beautiful yellow-bronze color, is hard, and can be worked with the same tools as iron. It may also be drawn into wire. Alloys with a larger percentage of silicium are harder.

Silicium. By melting together in a crucible 1 part of granulated zinc, 1 of sodium, and 3 of fluo-silicate of potassium, a zinc button traversed by long needles of silicium is obtained. On

dissolving the zinc in hydrochloric acid, the silicium remains behind. By heating the zinc containing silicium above the evaporating point, the silicium remains behind in a melted state, and becomes entirely free from zinc by heating it sufficiently. Pure silicium can be melted and cast.

To Protect Lead Pipes it is recommended to provide them with a coat of sulphide of lead. Dissolve ½ ounce of caustic soda in 1½ quarts of water, mix the solution with one of ½ ounce of lead nitrate (or an equivalent of other lead salt soluble in water) in ¼ pint of water, and heat the mixture to 195° F. As soon as a sufficient quantity of lead salt has been added the fluid becomes turbid and must be very quickly filtered through asbestos or a similar material. To the clear fluid is added 2½ ounces of hot water containing 1 drachm of sulphocarbamide in solution. In using the fluid it is best to heat it to 150° F., and to hold the thoroughly cleansed lead pipe in it for a few moments, when it will be quickly coated with a fine layer of sulphide of lead. If the lead has been thoroughly cleansed the sulphide of lead adheres very tenaciously and can be easily polished with a piece of leather.

To Protect Iron from Rust. The following fluid is claimed to prevent the rusting of iron: 1½ pints each of linseed oil and brown varnish, 1 quart of turpentine, and 1½ ounces of camphor. Heat the mixture over the water-bath, stirring constantly, then immerse the articles for a few moments, rinse them off with warm water, and dry.

To Protect Lightning Rods, Metal Roofs, etc., from Rust. Convert 2 parts of graphite mixed with 8 parts of sulphide of lead and 2 of sulphide of zinc into an impalpable powder, and add gradually 30 parts of linseed-oil varnish previously heated to the boiling point. This varnish dries very quickly and protects the metals coated with it from oxidation.

To Protect Wire from Rust. Melt mineral pitch and add to it ⅙ part by weight of coal-tar and ⅙ part by weight of very fine quartz sand, and immerse the wire in the mixture. The coating becomes hard in 24 hours.

To Protect Iron and Steel from Rust.

The following method is but little known, although it deserves preference to all others: Add $1\frac{3}{4}$ pints of cold water to 7 ounces of quicklime. Let the mixture stand until the supernatant fluid is entirely clear. Then pour this off and mix it with enough olive oil to form a thick cream, or rather to the consistency of melted and recongealed butter. Grease the articles of iron or steel with this compound, and then wrap them up in paper, or if this cannot be done apply the mixture somewhat thicker.

Cleaning Guns with Petroleum.

Cleansing a weapon with fats and oils does not entirely protect it from rust; the so-called drying oils get gummy and resinous, while the non-drying oils become rancid, and by exposure to the air acids are formed, and these attack the iron. For these reasons petroleum is to be preferred for this purpose. Petroleum is as great an enemy to water as are the fatty oils, and hence, when a gun-barrel is covered with a film of petroleum, it keeps the water away from the metal. The water resting upon this film evaporates, but the oil does not, and hence no rust can be formed. It is very essential, however, that the petroleum employed be perfectly pure, for impure oil, such as is often met with in commerce, attacks the metal. Care must also be taken not to allow it to come in contact with the polished stock. When about to clean a gun some tow is wrapped around the ramrod and enough petroleum poured upon it to thoroughly moisten it; it is then pushed in a rotary manner through the barrel and back a dozen times, and the tow taken out and unrolled, and the upper and lower ends of the barrel rubbed with the clean part, after which it is thrown away. This removes the coarser portion of the dirt. A round brush of stiff bristles and fitting the barrel is now screwed to the ramrod, then moistened thoroughly with petroleum and twisted into the barrel, running it back and forth at least a dozen times, thus loosening the dirt that is more firmly attached to it. The first operation is now repeated, except that the tow on the ramrod is left dry, and the rubbing with this must be continued in all directions as long as it

comes out soiled. The use of wire brushes is objectionable for cleaning guns, as the numerous steel points cut into the tube. Only soft tow, hemp, woollen rags, or the like should be used, as the petroleum dissolves the dirt sufficiently.

To Protect Wrought-iron Bridges from Rust. The following process was observed in painting the Britannia bridge across the *Menai Strait* in *North Wales*. All of the iron work was scraped and rubbed with wire and stiff bristle brushes until the surface acquired a metallic lustre. The holes, joints, and cracks were carefully cleaned and filled with red or white lead putty, and when dry the whole was brushed again and the bridge painted with 4 coats of the following paint at intervals of 8 to 14 days: Pure white lead 560 parts, crude linseed oil 133 parts, boiled linseed oil (without an addition of litharge) 18 to 36 parts, and spirit of turpentine 18 parts.

After the fourth coat had been applied the whole was sanded with fine white sand. To the paint for the last coat enough Berlin blue had been added to give it a light grayish tint.

The parts of the bridge not exposed to view received, after thorough scraping and puttying up, 3 to 4 coats of a varnish obtained by mixing 8 parts of gas-tar, 1 of spirit of turpentine, and 2 of pulverized lime.

Staining Metals. The following receipts have all been tested in the laboratory of *Dr. Winckler* by a practical armorer and given excellent results:

Blue Stain on Iron and Steel. Polish and cleanse the steel thoroughly with lime, and then brush it over with the following mixture: Butter of antimony 8 parts, fuming nitric acid 8 parts, and muriatic acid 16 parts. Add the spirit of salt very slowly and drop by drop, to avoid too strong heating. Apply the mixture to the steel with a rag, and rub it with green, young oak wood until the desired blue color is produced.

Gray on Steel and Iron. Polish the steel and coat it with a mixture of butter of antimony 8 parts and sulphuric acid 2 parts. If the color does not turn out handsome enough, add a few drops of empyreumatic pyroligneous acid or gallic acid.

Black. Mix 8 parts of butter of antimony, 4 parts of sulphuric acid, and 2 parts of empyreumatic pyroligneous acid, or gallic acid. Apply several coats of the mixture to the polished steel until it is black enough.

To Stain Iron, Gun-barrels, etc.,

Brown. Mix 16 parts of sweet spirit of nitre, 12 parts of a solution of sulphate of iron, a like quantity of butter of antimony, and 16 parts of sulphate of copper. Let the mixture stand in a well-corked bottle in a moderately warm place for 24 hours, then add 500 parts of rain water, and put it away for use.

After the barrel has been rubbed with emery paper and polished, wash it with fresh lime-water, dry it thoroughly, and then coat it over uniformly with the above mixture; it is best to use a tuft of cotton; let it dry for 24 hours, and then brush it with a scratch brush. Repeat the coating and drying twice, but in rubbing off for the last time use leather moistened with olive oil in place of the scratch brush, and rub until a beautiful lustre is produced; then let it dry for 12 hours and repeat the polishing with olive oil.

English Process of Staining Gun-barrels Brown. Mix 33 parts of pulverized sulphate of copper, 25 parts of sublimate, 28 parts each of sweet spirit of nitre and tincture of steel, and 500 parts of rain water.

Rub up first the spirit of nitre with the sublimate, then add the other ingredients, let it stand in a well-closed bottle in a warm place for 12 hours, then add the water and treat the barrel in the same manner as above, but wash it off every time after brushing with the scratch brush. After repeating this 3 times, polish the barrel with leather moistened with olive oil mixed with some oil of turpentine, then dry it for 12 hours, and finally polish with oil.

Light Brown. Mix 4 parts each of butter of antimony and ordinary butter and 10 to 12 drops of olive oil; heat the mixture in a flask and then brush it uniformly over the barrel, previously cleansed and polished; hold the barrel over a moderate coal fire, when a beautiful brown will soon make its appearance; then polish with olive oil, and finally give it a light coat of good amber lacquer compounded with some shellac.

Light Yellowish-brown. Mix 32 parts of spirit of wine and 16 parts each of sulphate of copper, tincture of steel, and nitric acid and, when all are dissolved, add 375 parts of rain water. After polishing the barrel and cleansing it with fresh lime-water, brush it over uniformly with the mixture, let it dry in an airy room, and then wash it off with a brush dipped in boiling water. Repeat this twice, and then coat the barrel with a lacquer prepared by mixing 1 part of amber varnish, 2 of copal varnish, $\frac{1}{2}$ of shellac varnish, and 1 of linseed-oil varnish. Should the lacquer be too viscid, dilute it with some oil of turpentine. As soon as the lacquer is dry polish the barrel first with beech charcoal and then with a piece of hat felt.

Lacquering of Sheet Metal. A good copal lacquer is required for the work. It is prepared as follows: Coat a glazed pot outside with a layer of potters' clay 5 inches thick, and the bottom with one 1 inch thick. Let it dry, and then place in the pot 500 parts of copal in small pieces, and 100 parts of Venetian turpentine, and melt the mixture over a moderate coal fire for $\frac{3}{4}$ hour, stirring it frequently. Then add in small portions at a time, and stirring constantly, 166 parts of hot linseed-oil varnish, and finally pour into the mixture, stirring constantly, 1000 parts of oil of turpentine. Then filter the lacquer and keep it in well-closed flasks.

Sheet metal to be lacquered must first be provided with a ground of oil paint. For the first ground take some good linseed-oil varnish, some oil of turpentine, and a little copal lacquer, and any desired pigment. If the sheet is, for instance, to be crimson, grind cinnabar in the above mixture, lay a coat of the paint on the metal, and bake it in the lacquering oven until it is hard and dry; then apply 3 or 4 more coats, and dry them in the same manner. Then rub the paint with shave-grass, next with finely-pulverized pumice-stone, and finally with a moist piece of felt, and then glaze the article.

For Glazing rub up fine Florentine or Vienna lake in good linseed-oil varnish and a little oil of turpentine; dilute it with copal lacquer, and apply 5 to 6 coats of it, allowing each coat to

dry thoroughly before laying on the next. When the last coat is dry, rub it smooth, first with a moist linen cloth dipped in pulverized pumice-stone, and finish with a piece of chamois and prepared buck's horn, and finally put the article in the lacquering oven heated to 97° F.

This mode of treatment is the same for all color mixtures.

Green. Schweinfurt-green. This requires no glaze.

Yellow. Use chrome yellow.

Blue is obtained by mixing Parisian blue with some Venetian white.

Chamois, by mixing cinnabar, red lead, chrome yellow, and some Venetian white.

Red-brown. Take calcined lampblack and cinnabar.

White Lac Color. Rub up very fine Kremnitz white in oil of turpentine, dilute it with good white copal lacquer, and dry it in the sun or in the air, as the color turns yellow if dried by the heat of a stove.

Lilac or Violet. Mix fine Vienna lake, Venetian white, and a little Parisian blue.

Black Lacquer. Boil on a moderate fire for 4 hours 250 parts of asphaltum in 125 parts of linseed-oil varnish; mix the compound with 66 parts of calcined lampblack, rubbed up in oil of turpentine, and dilute the mixture with oil of turpentine.

Blue or Steel Glaze. Rub fine Parisian blue in good linseed-oil varnish, and dilute with copal lacquer. Apply 3 to 4 coats of this to a tin plate, which will thereby acquire a blue-steel color.

Red Glaze. Rub fine Vienna or Florentine lake in linseed-oil varnish and dilute with copal lacquer. Apply 3 to 4 coats of it to a tin plate or bright sheet iron, which acquires thereby a beautiful transparent color.

MUSTARDS.

To Prepare Ordinary Mustard. I. Stir gradually 1 pint of good white wine into 8 ounces of ground mustard seed, add a pinch of pulverized cloves, and let the whole boil over a moderate coal fire. Then add a small lump of white sugar and let the mixture boil up once more.

II. Pour $\frac{1}{2}$ pint of boiling wine vinegar over 8 ounces of ground mustard seed in an earthen pot, stir the mixture thoroughly, then add some cold vinegar, and let the pot stand over night in a warm place. The next morning add $\frac{1}{2}$ pound of sugar, $\frac{3}{4}$ drachm of pulverized cinnamon, $\frac{1}{2}$ drachm of pulverized cloves, $1\frac{1}{4}$ drachms of Jamaica pepper, some cardamon, nutmeg, half the rind of a lemon, and the necessary quantity of vinegar. The mustard is now ready and is kept in pots tied up with bladder.

III. Pound in a mortar the flesh of a salt herring and 2 ounces of capers to a paste, and mix this with 2 ounces of pulverized white sugar and 13 ounces of ground mustard seed; then pour $1\frac{3}{4}$ pints of boiling wine vinegar over it, stir, and let the whole stand near a fire for several hours. Finally, add $\frac{3}{4}$ pint of boiling vinegar, stir thoroughly, and pour the mustard into glass bottles.

IV. Mix 8 ounces of ground mustard seed with $1\frac{1}{2}$ pints of good, cold vinegar, heat the mixture over a moderate fire for 1 hour, add 1 drachm of ground Jamaica pepper, and when cold keep it in well-closed jars.

V. Cut up a medium-sized onion, pour $1\frac{1}{2}$ pints of good wine vinegar over it, let it stand for a few days, strain the vinegar off and pour it over 8 ounces of mustard seed, and let this stand for 12 hours. The mustard seed is then ground and mixed with the following ingredients: One-half drachm of finely-powdered cloves, $\frac{1}{2}$ drachm of pulverized cardamons, a like quantity of grated nutmeg, and 1 ounce of pulverized white sugar.

Frankfort Mustard. Mix 1 pound of white mustard seed, ground, a like quantity of brown mustard seed, 8 ounces of pulverized loaf sugar, 1 ounce of pulverized cloves, 2 ounces of allspice, and compound the mixture with white wine or wine vinegar.

Wine Mustard. Compound very fine black mustard in powder with $\frac{1}{2}$ of its quantity of must, which has been previously boiled down to a thickly-fluid paste in a tin boiler.

Lenormand's Method of Preparing Mustard. Mix with 2 pounds of ground mustard seed, $\frac{1}{2}$ ounce each of fresh parsley and tarragon, both cut up fine,

1 clove of garlic also cut up very fine, and 12 salted anchovies; grind the mixture very fine, add the required mustard and 1 ounce of pulverized salt, and for further grinding dilute with water. To evaporate the water, after grinding the mustard, heat an iron rod red hot and cool it off in the mixture, and then add wine vinegar of the best quality.

Moutarde de Maille. Cut up 8 ounces of fresh tarragon leaves without the stems, $2\frac{1}{2}$ ounces of basil, 2 ounces of bay leaves, and 4 ounces of rocambolo. Place the ingredients in a glass alembic, pour $2\frac{1}{2}$ quarts of strong wine vinegar over them, and, to allow the vapors to escape, tie up the mouth of the alembic with a piece of perforated moist bladder. Place the alembic upon hot sand for 4 days, then filter the fluid first through linen and then through blotting-paper. Add to this aromatic vinegar 1 ounce of common salt, then stir it into a thick paste with ground black mustard seed, and keep the mustard in earthen jars.

Moutarde à la Ravigotte. Cut up 12 parts of fresh tarragon leaves, 6 of fresh bay leaves, 4 of fresh angelica root, 8 of capers, 8 of anchovies, 6 of rocambolo, and 4 of eschalots, and digest them in 200 parts of strong wine vinegar; then strain the fluid, press out the residue, filter the fluid again, and stir in ground black mustard seed to the consistency of a thin paste.

Sour Düsseldorf Mustard. Fill 2 barrels with vinegar; steep in one of the barrels 2 pounds of origan leaves and in the other an ordinary bucketful of onions cut up, and let them digest for 2 days. Then bruise 44 pounds of white mustard seed and 66 pounds of black mustard seed; put this in a vat and add 1 pound pulverized cloves, $1\frac{1}{2}$ pounds of pulverized coriander seeds, and $4\frac{1}{2}$ gallons of each of the prepared vinegars. Stir the whole thoroughly and grind it twice in a mill. To every gallon of this add and mix thoroughly with it 1 pound of salt dissolved in $\frac{1}{4}$ quart of the onion vinegar.

Soye's Method of Preparing Mustard. I. Steep 4 quarts of mustard seed for 8 days in a mixture of 1 gallon of wood vinegar and a like quantity of water; stir it several times daily and then grind it.

II. *Aromatic Mustard.* Cut up 8 ounces each of parsley, cheroil (*Chacrophylum sativum*), and celery, steep them for 2 weeks in wood vinegar, then grind the mixture, and add 10 quarts of ground mustard seed and 8 ounces of pulverized sea salt. On the other hand, pulverize and mix 1 pound each of cinnamon, cloves, nutmegs, and allspice, sift the powder and mix it with the mustard, together with 40 drops of essence of thyme and 30 drops each of essence of cinnamon and essence of tarragon, diluted with some vinegar poured from the first mixture.

III. *English Mustard* consists of 9 pounds of ground mustard seed, 9 ounces of wheat flour, $1\frac{3}{4}$ pounds of common salt, $2\frac{3}{4}$ ounces of Cayenne pepper, and as much water and vinegar as required.

Black Mustard Powder. Mix 10 parts of ground black mustard and $\frac{1}{2}$ of rocambolo rubbed very fine, and add $\frac{1}{2}$ of salt.

Compound Mustard Powder. Mix 10 parts of ground white mustard and $\frac{1}{2}$ of rocambolo rubbed very fine.

Compound English Mustard Powder. Pulverize and mix 2 pounds of mustard seed, $1\frac{1}{2}$ ounces of dried rocambolo, $\frac{1}{2}$ ounce each of marjoram, thyme, and garden sage, $\frac{1}{4}$ ounce each of tarragon and cinnamon, $\frac{3}{4}$ drachm each of ginger, cloves, and fennel seed, and 8 ounces of dried common salt, and keep the powder in well-closed bottles.

Compound Black Mustard Powder. Pulverize and mix 20 parts of ground black mustard seed, 3 of common salt, 1 each of tarragon, thyme, and rocambolo, and 4 of pulverized sugar.

Very Fine Table Mustard. Digest $1\frac{3}{4}$ ounces of fresh tarragon leaves, 2 bay leaves, 1 lemon (juice and rind), $\frac{1}{4}$ drachm each of cloves and cinnamon, $\frac{3}{4}$ drachm of black pepper, $\frac{3}{4}$ ounce of dill, and 1 onion in $\frac{1}{2}$ gallon of good vinegar. It is best to use a steam apparatus for the purpose. Then strain the fluid into a porcelain vessel, and, while it is yet warm, mix with it 1 pound of ground black mustard seed and a like quantity of white mustard, and 1 pound of sugar and $3\frac{1}{2}$ ounces of common salt. Let the whole digest, stirring it frequently, until the mustard has lost some of its sharpness by the

evaporation of the ethereal oil, and then dilute, according to taste, with more or less vinegar.

OILS AND FATS—ANIMAL, VEGETABLE, AND MINERAL

Purification of Mineral Oils. To remove the disagreeable odor of mineral oils, the following process may be used: Prepare a saturated solution of potassium hyposulphite and caustic soda in alcohol, and pour this, with constant stirring, into the mineral oil to be cleansed. The quantity of solution varies between 5 and 9 per cent., according to the condition of the oil. After the mixture has been allowed to settle by standing, the oil is drawn off the sediment, which is mostly of a dark color, into another mixing vessel, and again compounded with lye.

Residues in the Manufacture of Shale Oil serve for the manufacture of alum and contain considerable quantities of lithium. The acid, tarry matters contain sulphates of the pyridine series, especially coridine, rubidine, and viridine. Aniline does not seem to be present. The insoluble parts and alkaline tars contain principally phenols and thymols, but no ordinary phenylic acid.

French Process of Cleansing Vegetable Fat Oils. A boiler with a larger diameter at the top than on the bottom and provided with a cover is filled half full with oil, which is brought to a gentle boil. To each 30 gallons of oil are added 2 ounces of minium, previously stirred, for better distribution, into a thin paste with some of the oil. As soon as a strong froth is formed and green flakes are separated the boiler is taken from the fire and placed in the open air to cool off. Special care must be had not to neglect this moment, as otherwise a decomposition of the oil into sebatic acids and glycerine might easily occur.

Manufacture of Castor-oil. The following process is in use in the *Belleville Oil Works* of Brosius & Co. The seeds, after they have been cleansed from adhering dust and other impurities, are brought into iron tanks and gently heated, care being had to pre-

vent roasting, since the only object of this operation is to make the oil more fluid for pressing. The pressing itself is accomplished by means of hydraulic presses, each provided with a number of movable plates and a cylinder. As soon as the cylinder is filled and the plates have been put in position the pressing commences. The oil first pressed out runs into a large reservoir. The pressed seeds are thrown together in a pile, and remain there for one day, when they are again heated in an iron tank, brought into the cylinder and pressed. This gives a second quality of oil, which is used as a lubricant for machinery. Part of the press cakes is used as fuel in the manufactory, the other part is sent East, where, in connection with other materials, it is used in the manufacture of manures.

Baeder, Adamson & Co., of Philadelphia, employ bisulphide of carbon for extracting the press-cakes, gaining thereby a dark, thick fluid. The process is similar to that used in France with alcohol, but the product is a very ordinary burning oil smelling of bisulphide of carbon. The oil prepared by the *Belleville* process is called cold-pressed, and is without doubt much better than that gained by other methods where more heat is employed. The product of the two pressings is about 16 pounds, or 2 gallons per $1\frac{1}{2}$ bushels of beans. A third pressing has been tried, but it did not pay, as the gain was but 1 to 3 pounds from $1\frac{1}{2}$ bushels of beans, and the oil more colored. The process of purifying and clarifying the oil varies in different manufactories, the principal point being not to expose the oil to the air for too long a time, as it is apt to become rancid. The oil first pressed out is clear white, or rather colorless, resembling water; while the second is yellowish, resembling syrup of squills. Castor-oil can be mixed with radical vinegar and absolute alcohol in all proportions without the aid of any other agent. It is soluble in 4 parts of alcohol of 0.835 or 0.850 specific gravity at 60° F., and mixes without becoming turbid with equal parts of the same solvent at 77° F. It has a specific gravity of 0.97 to 0.98, congeals

at 8.6° to 10.4° F., and becomes solid at -40° F.

Manufacture of Neat's-foot Oil. The feet of about 100 wethers are placed in a tank and heated by steam for a few hours to 165° or 175° F. When the woolly hair can be removed the tank is emptied, the feet scraped off, and the claws removed. The feet thus cleansed are tied together in bundles of 18 each, and boiled until the oil contained in them is gained, while the half-boiled feet themselves are brought into commerce; 100 to 125 of these bundles are boiled at a time. The yield of fat varies very much, amounting to 1½ to 3½ pints from 100 wethers. The feet of animals, having travelled long distances before being killed, give only traces of oil. After having been boiled the feet are at once thrown into a current of cold water and, when cold, are ready for the market. The oil has a specific weight of 0.915; it is of a transparent gray color, becomes clear by standing or filtration, and is then very pale yellow. More than 75 per cent. of commercial neat's foot oil contain other fats.

To Prepare Chinese Drying Oil. A funnel very narrow on the lower end is filled with animal charcoal purified with hydrochloric acid, and converted into a coarse and uniform powder, and old linseed oil filtered through this. The filtered oil is brought into large leaden pans, upon the bottom of each is placed crystallized basic acetate of lead, minium, and borate of protoxide of manganese. The mixture is exposed to the light of the sun, the pan being covered with a glass plate. The pan is then heated to 248° F., and a current of air, heated to 250° F. and containing 16 per cent. of steam, is passed through it for 6 hours. The linseed oil thus prepared is put in flat tin cans, which are placed in a closed cylinder of sheet iron in rows one above the other in such a manner as to allow space for the circulation of air. In the upper part of the cylinder is placed a wide-necked flask filled ¾ full with chloroform, 1 pound of chloroform being required for 27.5 pounds of prepared linseed oil. A current of air heated to 212° F. is introduced beneath the cover of the cylinder, and passes out through

a clack valve, which can be regulated near the foot of the cylinder. In about 8 to 10 hours the oil is converted into a thick, tenacious mass, which passes then through the following process: American oil of turpentine is heated in a closed boiler to 572° F., 10 per cent. of absolute alcohol is added, and a like quantity of the prepared oil dissolved in this mixture at 212° F. The solution, which is at first yellowish and turbid, is put in a cylindrical vessel of sheet iron and allowed to clarify at a lower temperature. By mixing a small quantity of this drying oil with linseed oil or oil paints, it imparts to them the best drying qualities, and, after standing for some time, expels from the drying oils all vegetable gum. Mixed with linseed oil, a varnish of a straw color is obtained which dries in 18 to 24 hours, and leaves behind a tenacious elastic coating.

To Solidify Petroleum and other Mineral Oils. Mosses containing lichenine and other pectine substances, for instance Japanese moss, are lixiviated with hot water, and the lye obtained is intimately mixed with the petroleum or other oil. The compound, which becomes thick and even solid, can be easily transported. By adding alkali and filtering, or pressing, the petroleum is regained in a fluid state.

Rosin Oil and its Uses. Rosin oil, recently brought into commerce, is a product of the dry distillation of rosin. It has a disagreeable odor resembling that of wood tar, and a blueish mother-of-pearl lustre. The apparatus used in gaining it consists of an iron pot, a head piece, a condenser, and a receiver. In the distillation a light oil passes over first, together with water. As soon as the flow of the distillate ceases, the receiver is changed, and the heat raised, when a red-colored and heavy rosin oil passes over. The black residue remaining in the pot is used as a pitch. The light oil, called *pimoline*, is rectified, and the acetic acid water passing over with it is saturated with calcium hydrate, filtered and evaporated to dryness; the calcium acetate obtained being employed in the manufacture of acetic acid. The rosin oil obtained after the light oil has passed

over, is called *blue* rosin oil, on account of its dark violet-blue color. The red oil is boiled for a day with water, the water lost by evaporation being replaced by fresh; the next day the water is drawn off and the remaining rosin oil saponified with caustic lye of 36° Beaumé, and the resulting almost solid mass distilled so long as oil passes over. The product obtained is rectified rosin oil, which is allowed to stand in iron vessels, protected by a thin layer of gypsum, whereby, after a few weeks, a perfectly clear oil is obtained free from water. Oil of the first quality is obtained by a repetition of the foregoing operation upon the once rectified oil. The residues of both operations are melted up with the pitch. (See also *Lubricants*.)

To Prepare Pure Naphthaline. White naphthaline, on exposure to the air, changes its color. This can be remedied by repeated recrystallizing, washing, and distilling, and hence a permanent white color may serve as a criterion of its purity. As naphthaline is gained from coal-tar compounded with alkali to produce phenole, it is first treated with 5 to 10 per cent. of sulphuric acid of 1.85 specific gravity. As soon as the mixture is complete, 5 per cent. of the weight of the naphthaline of manganese dioxide is added, or natural pyrolusite may also be used. The mixture is heated on a water-bath for 15 to 20 minutes until no further reaction takes place, and, to remove the acid, is then washed with hot water, next with weak solution of sodium hydrate, and again with water. The mass is then distilled and all passes over at 1 to 2 degrees below the boiling point of pure naphthaline. A sample of naphthaline prepared in this simple and cheap manner remained clear for 8 to 9 months, while the ordinary commercial samples obtained from reliable firms lost their color long before that time.

Vaseline or Cosmoline. The principal point in the manufacture of vaseline or cosmoline is to free the raw materials, consisting either of natural mineral tar (soft native bitumen) or the residues of petroleum, from all adhering impurities and easily decomposable substances, and to decolorize

them at the same time as much as possible. The mineral tar from Alsace and Galicia, and petroleum residues in the United States, are the principal raw materials used. They are of a semi-fluid to pasty consistency, and according to their condition the resulting vaseline will be more or less consistent.

The raw material is cleansed and decolorized by treating it with sulphuric acid and chromate of potassium, and subsequent digesting with animal charcoal. We give in the following a description of the processes used:

The raw materials are converted into a fluid state and passed, after all the soluble substances have been separated, through a series of carbon filters, such as are used in sugar refineries.

After passing through 12 to 15 filters, the originally black-brown fluid assumes a wine-yellow color, and by passing through double the number of filters becomes clear as water. The clear fluid, the specific gravity of which decreases as it becomes lighter in color, containing now no trace of bituminous substances, is brought into the duplicator, into which superheated steam is passed, the temperature being raised to 480° F. Samples taken occasionally from the boiler must show no changes in the oil after this temperature has been kept up for several hours. The steam is then shut off and the finished vaseline (about 25 to 30 per cent. of the raw material) is filtered through tissue paper and packed in boxes for transport.

The greatest disadvantage of this process is, that the animal charcoal is very rapidly exhausted and is only able to decolorize a small percentage of its own weight of vaseline; expensive arrangements being therefore required to extract the solution adhering to the charcoal and revivifying the latter by means of superheated steam of 750° to 930° F. But the quality of this vaseline is very good, its color being a pure white like the best white tallow. It is entirely tasteless, odorless, not only when rubbed upon the hand, but also when melted in water; the latter property distinguishing it from all other varieties of vaseline, which, on melting in water, develop a faint odor of petroleum. Vaseline when melted gives an

entirely clear and colorless fluid, recongealing into a homogeneous, non-crystalline mass.

Cold 98 per cent. alcohol dissolves 2.2 per cent. of vaseline. The evaporated residue from an alcoholic solution is liquid at an ordinary temperature. It cannot be saponified; it is therefore neither a fat nor a resin.

Hot alcohol dissolves it completely and gives a clear solution, the vaseline, on cooling, separating in flakes.

To potash-lye vaseline is entirely indifferent. If, after boiling for some time, the lye is poured off from the vaseline and acidulated, it remains entirely clear, no opalizing nor separation of flakes taking place.

Sulphuric acid of 1.60 specific gravity and nitric acid of 1.185 specific gravity do not change vaseline if boiled with them. Fuming nitric acid colors it yellow-red, sulphuric acid of 1.82 specific gravity blackish-gray, the acid itself becoming yellow-brown.

When heated in a platinum dish, vaseline is completely consumed and leaves no residue. Its specific gravity is 0.848.

New Process of Purifying Paraffine. The paraffine, which was formerly pressed, is brought into an ordinary still, and the oily substances expelled by means of superheated steam. They are drawn off through a cock near the bottom of the apparatus. The paraffine is then clarified in the ordinary manner. By this process pressing is avoided, and paraffine melting only at 158° F. is obtained. The oils obtained as by-products are very uniform and good.

To Purify and Bleach Fat of Bones extracted with Benzine, and make it available for the Manufacture of Soap. The principal difficulties preventing the utilization of fat of bones in the manufacture of soap are:

1. That the odor of benzine does not entirely disappear even during saponification.

2. The fat assumes a dark and frequently brown color.

3. Soap manufactured from it is difficult to free from salt.

In most cases these evils are removed by passing steam through the hot fat for 6 to 8 hours, or where no steam can

be had, boiling it with equal parts of water for the same length of time.

But this simple manipulation does not always suffice, as it frequently removes the odor of benzine only partly, and does not free the fat from the dissolved glue and the dark color. To do this satisfactorily boil 100 pounds of fat for 6 to 8 hours with an equal quantity of water in which 2½ pounds of chloride of zinc have been dissolved. The chloride of zinc dissolves the mucous parts of the fat without attacking it, and separates them from the coloring matter, whereby the fat not only becomes clear, but acquires also a lighter color. Should the fat, after being treated in this manner, require further bleaching, it is subjected to the following process: Heat the fat to 167° F., and add, with constant stirring, to every 100 pounds of fat 2 pounds of caustic soda-lye of 34° to 35° Beaumé, and 1 pound of salt previously dissolved in some water, and then let it stand quietly. The traces of impurities and glutinous matter still adhering to the fat are absorbed by the lye and precipitated. The clear fat is then poured into a vat of soft wood and cooled to 105° F. The bleaching liquors, having been prepared in the meanwhile by dissolving for every 100 pounds of fat ½ pound of bichromate of potassium in 1½ pounds of boiling water and mixing this with 2 pounds of fuming hydrochloric acid, are then poured slowly and with constant stirring into the oil at the above temperature. The oil, in about 15 minutes, will assume a dark-green color, which, with uninterrupted stirring, becomes lighter and lighter until it disappears entirely, and the fat acquires a yellowish tint. When a sample taken occasionally from the vat shows no essential changes the bleaching process may be considered finished, and it only remains to wash the fat by means of a watering-pot, using about 10 to 12 pounds of water for every 100 pounds of fat.

Process of Gaining Glycerine. The following process is used for extracting glycerine from soap-boiler's lye containing salts: The lyes are neutralized and evaporated as much as possible. A large part of the salts is separated in solid form; this is removed and washed with neutralized lye. The fluid con-

taining the glycerine is again evaporated and compounded with such a quantity of oleic acid or of trioleins, as oil, tallow, lard, etc., that the mixture contains to every molecule of glycerine somewhat more than 1 molecule of oleic or sebatic acid. The compound is first heated in a still to 338° F. by steam, and then gradually to 392° F., whereby the air may be excluded by introducing carbonic acid. A still provided with a stirring apparatus is used. Water escapes, which may be partly present as such and is partly liberated as a decomposition product. The monoolein thus formed is saponified with lime. A solution of glycerine in water is obtained from which commercial glycerine is gained by evaporation. A lime soap is also produced which, after having been freed from acid, may be again used.

Corn Oil from Corn Mash. The day before the mash is to be distilled, the oil is skimmed from the surface with a sheet-iron skimmer and poured through a fine sieve into a wooden vat having a capacity of 44 gallons. When the vat is $\frac{1}{2}$ full of oil it is filled up with hot water, and the mixture, after being thoroughly stirred, is filtered through linen into another vat provided with 2 cocks, 1 near the bottom for drawing off the water, and the other about 5 inches higher up for the oil. After the filtrate has stood for a few hours, and the water has separated from the oil, the latter is carefully drawn off. If it is to be quite clear and transparent, it is poured into a glass balloon and exposed to the rays of the sun, when, after the slimy precipitate which is formed has settled, the clear oil is poured off. The oil may be used for illuminating and lubricating purposes.

Oil from Acid Tar. Good oil suitable for lubricating purposes and as a substitute for linseed oil in the manufacture of printing-inks may be obtained from the acid tar of oil refineries by diluting it with benzine, then separating the acid by repeated washings, distilling, and next treating with milk of chloride of lime at a temperature not exceeding 140° F. After the oil has been thus treated the limy sediment is drawn off and a caustic or carbonated alkali introduced

to neutralize any of the remaining chlorides or chlorine. The alkaline sediment is next drawn off, and, after the oil has been again washed with water, the process is finished.

To Refine Cotton-seed Oil. One hundred gallons of the crude oil are placed in a tank and 3 gallons of caustic lye of 45° Beaumé gradually added and well stirred for several hours; or the same quantity of oil is treated with about 6 gallons of soda-lye of 25° to 30° Beaumé, and heated for an hour or more to about 200° to 240° F., under constant stirring, and left to settle. The clear yellow oil is then separated from the brown-soap sediment, which is placed into bags to allow the remainder of the oil to drain off. The soap sediment is sold to soap-makers. The potash-lye must be made in iron pots, but the oil and lye may be mixed in wooden tanks.

To Purify Train Oil. Add to 1 gallon of train oil 1 $\frac{1}{4}$ ounces each of chalk and slaked lime and $\frac{3}{4}$ pint of water; stir the mixture thoroughly, let it stand for several days, and then add $\frac{3}{4}$ pint more of water and 3 ounces of potash; heat the fluid without letting it come to a boil, and take it from the fire when the oil has acquired a light amber color. Finally add a solution of 1 ounce of salt in $\frac{3}{4}$ pint of water, let the mixture boil for $\frac{1}{2}$ hour and pour it into a reservoir.

To Purify Illuminating Oil. Mix 200 gallons of oil with 60 pounds of sulphuric acid, and stir for 3 hours. Add a mixture of 6 pounds of clay, 15 pounds of slaked lime, and 200 gallons of water, and boil the whole for 3 hours, with constant stirring. When cold draw off the oil, which will be entirely pure.

To Purify Turbid or Impure Poppy-seed Oil. To 5 parts of oil add 2 of cows' milk, and let the mixture boil for $\frac{1}{4}$ hour. Then remove it from the fire, and when lukewarm filter it into bottles. This oil will in a few days be as clear as good olive oil and resemble it very much in taste.

To Purify Animal Oils. Animal oils in their natural state contain sticky and albuminous substances, making them unfit for lubricating machinery. The following process is recommended

by *Spencer* to remove these evils. The process proposed by him is as follows: Twenty-five gallons of boiling water are poured over 3 quarts of gall-nuts, allowed to stand for 3 hours, being frequently stirred, and the supernatant clear fluid is then poured off. This is mixed with 125 pounds of bone oil and the mixture boiled for 4 to 6 hours. By adding 8 ounces of sulphuric acid to the mixture, and thoroughly stirring, the sticky and albuminous matters will be separated in an insoluble state.

Böttger's Simple Process of Making Commercial Petroleum Clear as Water without Distilling it. Place 1 quart of ordinary petroleum in a glass flask and compound it with 4 to 6 ounces of fuming sulphuric acid; close the flask with a glass stopper, shake the mixture several times every day for several days. The oil will in the course of 8 days become clear as water, all the foreign organic substances mixed with the oil having been carbonized. The bottle is then opened, care being had not to inhale the acid vapor; the clear oil is drawn off into another flask by means of a siphon, several times shaken with water frequently renewed, allowed to stand quietly for some time, and then poured into a third flask containing 3 ounces of caustic lime in pieces as large as a pea, when it is shaken several times and then allowed to stand quietly. The oil thus purified is clear as water and well adapted for swelling and dissolving caoutchouc in small pieces.

Oil from Sunflower Seed. The seeds of sunflowers yield 15 per cent. of oil. It is used as a table oil, for illuminating purposes, and in the manufacture of soap. *Macassar oil* may also be prepared from it. This is done by dissolving $\frac{1}{4}$ ounce of cocoa butter and stirring into it 3 ounces of oil of sunflower seed, entirely odorless, and $\frac{1}{2}$ ounce each of goose grease and melted horse grease. This oil is poured into a flask and mixed with the following ingredients: One-quarter ounce each of liquid storax and oil of eggs, $\frac{3}{4}$ drachm each of neroli and rose oil, $\frac{1}{2}$ drachm of oil of thyme, and 20 drops of Peruvian balsam. The mixture is allowed to stand for a few hours, and the supernatant pure oil then poured off.

To Prepare Oil Used in Pumicing Wood. Mix 2 pounds of old linseed oil with $2\frac{1}{2}$ ounces of finely-rubbed silver litharge in a glazed pot holding at least one-third more than the quantity required, place this over a coal fire and boil the oil for 1 to 2 hours, stirring constantly. The oil is now allowed to stand quietly for a few days, and is then carefully poured off the sediment into a dry vessel or flask, and the oil yet remaining in the residue gained by straining through close linen. The oil is then mixed with half its quantity of oil of turpentine, the whole thoroughly mixed, and the oil is ready for use.

Cowper's Process of Deodorizing Coal-tar, Rosin Oil, etc. Heat 1400 pounds of rosin oil to 260° F., then add 100 pounds of heavy coal-tar oil, and introduce superheated steam of about 400° F. through a perforated tube in the bottom of the boiler for about 10 hours. Oil thus prepared is especially adapted for the manufacture of varnish. For preparing white varnish the oil is intimately mixed with some dilute sulphuric acid, which is afterwards removed by treating with steam, which is best done in a still, whereby the escaping volatile oil can be condensed and regained.

To Detect Rape-seed Oil and all Oils derived from Cruciferae. Dissolve $\frac{1}{2}$ drachm of caustic potash in 6 fluid drachms of water, and add $\frac{3}{4}$ to 1 ounce of the oil to be tested, and heat for a few minutes to the boiling point. Strain the entire soapy gum through a moistened filter. By compounding the filtrate with solution of acetate of lead, it will, if rape-seed oil is present, assume a brownish color. Small quantities of the filtrate and solution of sodium nitro-prusside, placed separately upon a watch crystal and mixed together with a glass rod, will emit a beautiful but evanescent violet to purple color if rape-seed oil is present.

To Detect Rape-seed Oil in other Fat Oils. One part of the oil to be tested is dissolved in about 2 parts by volume of ether; then add 20 to 30 drops of a saturated solution of nitrate of silver in alcohol, mix the whole thoroughly by shaking and let it then stand quietly in a shady place. Should a considerable percentage of rape-seed oil be

present, the lowest layer of the fluid will at once assume a brownish tint and finally become entirely black. If but little of rape-seed oil is present, a black-brown coloring will be perceptible only after about 12 hours. The reaction becomes still more decided by evaporating the ether. Olive oil, oil of almonds, poppy-seed oil, and fat mustard-seed oil do not show this reaction.

Preparation and Uses of Paraffine.

The tar is washed out with lime-water forced into the still by means of a montejus, distilled with steam, and the distillate separated into 2 parts: crude light oil and paraffine. The latter is crystallized in reservoirs. The light oil is treated with sulphuric acid and lye, and freed from acid. The acid and lye containing rosin and creosote are worked up into by-products. The oil, on being distilled in a vacuum, gives essence, photogen, solar oil, and pure paraffine. The latter is put into a press. The oil is again treated with acid and lye, and is then ready for the market.

The paraffine taken from the press is freed from the oil by a centrifugal. The crystallized mass remaining in the machine with a saturated solution of pure paraffine, and then formed in wooden moulds into bricks, which are pressed as cold as possible by means of cold hydraulic presses.

Another process of cleansing paraffine is as follows: The paraffine is melted and digested with about $\frac{1}{3}$ of its weight of animal charcoal, for a few hours, so that the paraffine shall remain in a liquid state. When the purification is complete, the paraffine is strained through linen and crystallized.

The paraffine of commerce is a colorless, translucent substance, perfectly inodorous and tasteless. It floats on water, has a density of about 0.87, and melts at about 113° to 140° F., forming a colorless oil, which, on cooling, again solidifies into a crystalline mass. It boils at about 698° F., and volatilizes without decomposition. It does not absorb oxygen from the air, and is but slowly attacked by sulphuric acid, even at the boiling point of water. It is not at all attacked by dilute nitric acid, and only by the strong acid after

prolonged boiling. Lately it has been discovered that if paraffine be heated for a considerable time in a sealed tube, the result is a more fusible paraffine, exactly similar in its apparent chemical composition, but much softer and more fusible, so that, in fact, if the heat be continued for a considerable time, the paraffine being still under pressure, a perfectly transparent liquid paraffine is ultimately obtained.

In addition to the properties which have brought it into such extensive use for illuminating purposes, paraffine has qualities which give it an exceedingly wide range of useful applications. It can be advantageously used in oil baths in place of oil. Independent of greater cleanliness, it can be heated several times and continuously to 572° F. without decomposition, and at that temperature remains thinly-fluid and clear as water, so that the drying apparatuses in the paraffine bath are plainly visible, while oil, after having been frequently heated, becomes black and thickly-fluid. As paraffine melts at a low temperature, vessels of glass containing the substances to be dried can be placed in it without fear of bursting. The vessels used in the paraffine bath are cleansed in the same manner as those in the oil bath, with benzole, which dissolves paraffine.

Filtering paper drawn through melted paraffine will bear contact with sulphuric acid for weeks without being in the least attacked by it. Paraffine may also be used for coating labels on vessels containing acids and alkalis. To prevent it from permeating the paper, rendering the latter transparent, it is recommended to coat the paper, before pasting it on the vessels, with thin solution of gum-Arabic.

Sponges and papers saturated with paraffine furnish products preferable as regards stability to those treated with wax. It seems also to be available for preserving fruits: apples and pears, being dipped into melted paraffine, have been kept unchanged under the most unfavorable circumstances.

For water-proofing wearing apparel, military equipments, and the like it is much better than rubber, as it is odorless, and does not become sticky with heat. For the water-proofing of tent-

cloths, ground-sheets for soldiers, etc., it has been found of great value.

Paraffine is largely used for the lining of casks and other wooden vessels, to keep them sweet and to prevent either the absorption of their contents by the wood, or their escape through the pores. If applied to beer barrels it keeps them from becoming musty and foul; and by filling the pores and joints of the staves it prevents the escape of carbonic acid gas. Water-buckets, butter-firkins, and other wooden articles of domestic use can be similarly treated, and, as the material is cheap, easily obtained, and easily applied, it may be tried on a small scale by any one.

In the laundry, paraffine rubbed on the hot flat-iron imparts a beautiful gloss to starched goods, greatly lightens the labor of ironing, and leaves no greasy stain, being much superior to the spermaceti used for this purpose. Dissolved in naphtha, paraffine has been applied with excellent effect to decaying brick and stonework, filling the pores of these materials and putting a stop to the destructive action of the weather. Fine wood-work exposed to the weather can be protected in the same manner. Instead of using sealing-wax for the tops of bottles, as good a sealing or better, and with much less trouble, is obtained by dipping the bottles into melted paraffine.

Belmontine and Sherwood Oil. For several years past considerable quantities of naphtha have been brought to England from the East Indies and the Indian Archipelago. This is worked up in a large London establishment by distilling it with superheated steam into a light oil called "*Sherwood Oil*" and into heavy paraffine oils. The *Sherwood oil* resembles benzine, and is used as a solvent of caoutchouc, etc. The heavy oils, purified and rectified, furnish a very fine paraffine called "*Belmontine*" which melts at 140° F., and is therefore especially adapted for the manufacture of candles. The purified paraffine oils may also be used for burning in lamps. This, like all other natural naphtha recently examined, contains neither creosote nor carbolic acid, which is a special advantage the natural products possess over the artificial tar

oils gained from coal, brown coal, and peat.

A New Oil from California. Heptane, as this product is called, is a volatile oil resembling paraffine oil, and is gained by making incisions in the trunk of the *Digger or nut pine (Pinus sabinianus)*, growing on the lower ranges of the Sierra Nevada. The product is an oily, resinous substance which by simple distillation is converted into an oil which is sold in San Francisco and neighborhood under various names, for instance, *Abietine, Theoline, Erasine*, etc. It is used for the same purposes as benzine and is especially well adapted and preferable for removing stains and cleansing gloves, as it has an agreeable odor resembling that of the orange. The boiling point of the crude oil is only a few degrees above that of water, and, when distilled at this temperature, deposits a resinous residue having a strong, penetrating odor of oranges. The inhaling of the vapors of the oil produces an effect like that of chloroform, allaying pain. This new product deserves the attention of the commercial world, as it can without doubt be used in the manufacture of perfumeries, and as a harmless and suitable remedy for certain ailments.

To Distinguish Light Oils from Crude Petroleum from Light Tar Oils.

Light Petroleum Oil ("Benzine" or "Benzoline.")	Coal-Tar Naphtha or "Benzole."
1. Consists of heptane (C ₇ H ₁₆) and its homologues.	1. Consists of benzole (C ₆ H ₆) and its homologues.
2. Heptane contains 84 per cent. of carbon.	2. Benzole contains 92.3 per cent. of carbon.
3. Commences to boil at 129.2° to 140° F.	3. Commences to boil at 176° F.
4. Specific weight at 60° F. about 0.69 to 0.72.	4. Specific weight at 60° F. about 0.88.
5. Smells of petroleum.	5. Smells of coal-tar.
6. Dissolves iodine, the solution being raspberry-red.	6. Dissolves iodine, the solution being purple, resembling an aqueous solution of permanganate of potassium.
7. If brought in contact with coal-tar pitch, even for a long time, it dissolves very little of the latter and becomes scarcely colored.	7. Dissolves coal-tar pitch very easily, the solution assuming a deep-brown color.

8. When shaken in the cold with $\frac{1}{2}$ of its volume of melted crystals of pure carbolic acid, the latter is not dissolved, but forms a layer by itself separate from the oil.

9. Requires for a complete solution at an ordinary temperature 2 volumes of absolute alcohol, or 4 to 5 volumes of methyl alcohol of 0.828 specific gravity.

10. Heated with 4 volumes of nitric acid of 1.45 specific gravity, the latter becomes brown, while the oil is but little attacked and forms an upper layer.

8. Can be mixed with pure carbolic acid in all proportions.

9. Miscible with absolute alcohol in all proportions. It forms a homogeneous fluid with an equal volume of methyl alcohol of 0.828 specific gravity.

10. Is entirely miscible with 4 volumes of nitric acid of 1.45 specific gravity, becoming at the same time uniformly heated and assuming a dark brown color. A part of the nitrobenzole formed may, on cooling the fluid, separate as a distinct layer.

drawn off into another vat, and again treated with cold, caustic soda-lye of 1.25, thoroughly agitated by means of the stirring apparatus and allowed to stand quietly, using the above precautions. The separated oil is stored in special vessels and finally rectified in a clean still of wrought or cast iron, whereby a considerable quantity of light wood-tar oil will pass over, which is added to the other light oils. The heavy oil is then treated several times with concentrated, caustic soda-lye as above, to remove the last particle of creosote.

The heavy wood-tar oil, previously washed with hot water, is now treated with 5 per cent. of concentrated sulphuric acid, thoroughly stirred, and allowed to settle. This operation is carried on in a wooden vat lined with lead, stirring for $\frac{3}{4}$ to 1 hour. The acid which has settled is then drawn off, the oil freed from all traces of acid by adding 2 per cent. of caustic soda-lye and washing with steam. It is then distilled in a copper still, whereby again some light oil passes over, which must be collected in a special receiver; the heavy oil containing paraffine, which passes over later on, is brought into special reservoirs, where the paraffine separates by crystallizing into small laminae. The oil must for this purpose stand at least for 4 weeks in a cool place. The liquid oil is drawn off by faucets arranged on the reservoir at different heights, while the crystals of paraffine remain behind. This fluid oil is largely composed of xylol, but is also contaminated with eupione and Kapnomor.

The crystals of paraffine are brought into a straw filter, pressed, and kept to be used in the purification of paraffine, while the fat oil which drains off and is free from creosote may be used as a lubricator for machines.

The lyes containing the creosote are neutralized with sulphuric acid, whereby the crude creosote is separated, which is stored away for preparing creosote, while the acid fluids are evaporated to dryness and calcined to regain the soda contained in them.

Separating and Purifying Fats. The method of separating the constituents of animal fat used by the Oleomargarine

Many analyses have shown that the light petroleum oils, sold under the name of benzoline or benzine, contain about 50 per cent. of heptane.

Practical Purification of Crude, Heavy Wood-tar Oil and Preparation of Crude Wood-tar Creosote. The heavy wood-tar oils obtained in the distillation of wood tar, having a specific gravity of 0.993 to 1.025, are collected in special vessels, then brought into sheet-iron tanks and thoroughly mixed, when they will show at an average a specific gravity of 1.015. This oil is then brought into large vats open on the top, and a strong solution of carbonate of sodium is gradually added, causing a strong effervescence and the acetic acid to combine with the soda to acetate of sodium. This is continued until all reaction ceases, when the mixture is allowed to settle. The supernatant oil is then drawn off and treated with cold, caustic soda-lye of 1.20 specific gravity. This is best accomplished by providing the vat with a stirring apparatus and agitating the oil thoroughly for 1 hour. It is then allowed to stand quietly, and the stirring apparatus is removed from the vat. To promote a better settling of the lye it is advisable to heat the fluid towards the end of the stirring operation by introducing steam.

The separated oily parts are then

Manufacturing Co., of New York, consists in mincing the fat and introducing it, together with its own weight in water, into a wooden tank, which is heated by a steam coil to from 104° to 122° F., and constantly stirred. After 2 hours the oleomargarine and stearine separate from the scraps and are then allowed to cool to separate from the water. They are then thoroughly worked with 2 per cent. of salt, put in bags, and subjected to pressure or centrifugal action in a temperature of 59° F., which separates the oleomargarine from the stearine, as the latter is not affected by this heat, although the former is melted by it. After the oleomargarine has again congealed, it may be worked a second time with salt to separate the last traces of water.

To Remove Sulphuric Acid and Sulphur Adhering to Mineral Oils after Refining, Perutz uses finely-pulverized dry calcium hydrate and 40 per cent. of soda-lye. The quantities by weight to be used can be determined after a few distillations, but can also be ascertained by an experiment on a small scale. The process is as follows: As soon as the boiler is filled the powdered lime, about $\frac{1}{2}$ to 1 per cent., is added and the fire started, while a workman mixes the powder with the oil by means of a wooden implement. As soon as the oil has been mixed for $\frac{1}{4}$ hour, 40 per cent. of soda-lye is added, mixed for $\frac{1}{4}$ hour, and the boiler closed. Petroleum, containing many oils with a low boiling point, must be mixed while cold, or treated with the alkalies in a mixing apparatus hermetically closed, and then pumped or forced into the boiler. The sulphur combinations in the mineral oils are decomposed by the added alkaline hydrates during the high temperature prevailing in the last stage of the distillation, and remain mostly sodium sulphide or calcium sulphide. If the asphaltum can be utilized it is advisable to distil only to the formation of asphaltum, but if not, to finish distilling in horizontal retorts. This method will, it is claimed, give 5 to 10 per cent. more of pure white illuminating oil than any other. The oil has an agreeable ethereal odor; the heavy paraffine oils have a light yellowish color shading finally slightly

into green, and are entirely free from chrysene and pyrene.

Coal-tar Varnish Oil. The second distillate passing over in purifying crude, light coal-tar oil, having a specific gravity of 0.850 to 0.890, and also the first distillate gained in purifying crude, heavy coal-tar oil, are used for manufacturing varnish oil. The 2 distillates combined show a specific gravity of 0.900. Place about 200 pounds of this in a holder lined with lead, add 1 pound of chromate of potassium, 8 $\frac{1}{2}$ ounces of pyrolusite, and about 4 pounds of sulphuric acid, stir constantly for 1 hour, then let the mixture stand quietly for a few hours, and draw off the oil, which has assumed a dark color, while many resinous substances remain with the acid upon the bottom of the holder. First wash the oil with warm water, then add 2 per cent. of caustic soda-lye of 5° Beaumé, stir thoroughly and allow to stand quietly for a few hours, during which many impurities and resinous substances are removed by the lye. Repeat this operation once more, using only 8 $\frac{1}{2}$ ounces of chromate of potassium, 4 ounces of pyrolusite, and 2 pounds of sulphuric acid. The oil is again washed and freed from acid with 2 per cent. of caustic soda-lye of 5° B. After allowing it to stand for some time the clear oil is brought into a copper still, and distilled at first with a moderate fire. Some benzole passes over first, which is removed, and then the varnish oil having a specific gravity of 0.880. It is clear as water, has a slightly aromatic but not disagreeable smell, and does not turn yellow on exposure to the air. It is an excellent solvent for resins and fatty substances, especially when it is once more rectified with double-rectified oil of turpentine.

(For Varnishes, Printing-Ink, and Lubricants prepared with this oil see under the respective headings.)

Process of Producing Heavy Coal-tar Oil in England. Place the crude, heavy oil in large cast-iron stills and introduce superheated steam until the oil passing over has a specific gravity of 0.91. Then shut off the steam and distil with fire under the apparatus, whereby water and heavy coal-tar oil are obtained, continuing the distillation

until the oil has a specific gravity of 0.99. The residue in the stills, consisting principally of asphaltum pitch, is run off and sold as asphaltum. The crude, heavy coal-tar oil is now further refined by mixing it intimately with sulphuric acid in the proportion of 100 gallons of oil to 15 gallons of acid, in a vat lined with lead. The mixture is allowed to cool and settle; the clear fluid is then drawn off into another vessel, and to every 100 gallons of oil are added 10 gallons of caustic soda-lye of 1.35 specific gravity. Stir the whole thoroughly for 1 hour, then allow it to settle, draw off the clear fluid, and rectify this until the oil passing over has a specific gravity of 0.94. The oil is then conveyed into a smaller still and distillation continued until the contents of the still are exhausted. The oil obtained is treated with dry ammoniacal gas, whereby naphthaline is deposited, then filtered through a bag, the filtrate forming the purified, heavy coal-tar oil. The lighter coal-tar oil, having a specific gravity of 0.91, is compounded in another distilling apparatus with 2 pounds of burned lime to 1 gallon of oil, then allowed to stand for some time, and finally distilled. The product will be a more volatile oil, which can be rectified by means of superheated steam, and used together with varnish oil.

Manufacture of Yellow Shoemaker's Wax from Purified Coal-tar Oils.

Melt 400 pounds of rosin in a cast-iron boiler over a moderate fire, add gradually 40 pounds of purified, heavy rosin oil and a like quantity of purified, heavy coal-tar oil free from creosote, and continue boiling over a moderate fire until a sample taken from the boiler, on cooling, can be kneaded and drawn between the fingers. Now let the mixture cool, and, while it is in a liquid state, add a mixture of 20 pounds each of chrome-yellow and chalk, mix thoroughly and pack the pitch, which is now commercial shoemaker's pitch, in boxes.

Manufacture of Blacksmith's Pitch from Coal-tar. The coal-tar from gas-works, where the tar, for the purpose of freeing it as much as possible from volatile oils, is allowed to run back once more into the retorts, is used, or if this cannot be had, the volatile oils must

first be expelled from more thinly-fluid tar. The tar is brought into a large distilling apparatus with outlets in the bottom, and the light as well as the heavy oils are distilled off so that finally naphthaline vapors pass over. The cooling water is then drawn off from the condensing tubes, as otherwise the naphthaline vapors would condense and choke them up. From 100 parts of coal-tar are drawn off 4 per cent. of aqua-ammonia, 3 per cent. of light crude oil, and 15 per cent. of oil containing naphthaline, the residue containing 48 per cent. of pitch, there being a loss by distillation of 5 per cent. The pitch is very solid, of a conchoidal fracture, and black-grayish color. It is principally used to provide hot iron with a glossy layer to protect it against rusting.

Testing Oils. *Maumené* has investigated all the different methods of testing oils in regard to their purity, and found that accurate results can only be obtained with sulphuric acid. He proceeds as follows: Fifty grammes of oil are placed in a graduated cylinder capable of holding 150 cubic centimeters. The temperature of the oil is then ascertained, and 10 cubic centimeters of concentrated sulphuric acid are gradually added from a pipette and intimately mixed with the oil by stirring for a few minutes, and with a thermometer the maximum degree of heat is noted.

The temperature of 50 grammes	will rise
of pure olive oil	42° C. (107.6° F.)
of pine-seed oil	43° C. (109.4° F.)
of castor-oil	47° C. (116.6° F.)
of horse-foot oil	51.5° C. (124.7° F.)
of oil of bitter almonds	52° C. (125.6° F.)
of oil of sweet almonds	52.5° C. (126.5° F.)
of rape-seed oil	57° C. (134.6° F.)
of beech-nut oil	65° C. (149° F.)
of peanut oil	67° C. (152.6° F.)
of sesame oil	68° C. (154.4° F.)
of hemp oil	98° C. (208.4° F.)
of nut oil	101° C. (213.8° F.)
of cod-liver oil	102° C. (215.6° F.)
of linseed oil	103° C. (217.4° F.)

OIL-PAINITINGS. HOW TO CLEANSE, PACK, AND VARNISH THEM, AND TO RESTORE GILT WORK.

To Cleanse Oil-paintings. The very important knowledge how to properly

clean oil-paintings is unfortunately little understood by those who follow it professionally, their manipulations doing often more injury than benefit. The various substances with which the colors may be contaminated, and the variety of ingredients composing the varnish coated upon paintings, demand correspondingly suitable treatment. We can only give a few hints as to the best means of removing stains, impurities, etc.

A simple spirit varnish is easily removed, but in other cases it can never be done without serious danger to the painting, and for this reason it is of the utmost importance to know whether the varnish is such as can be removed without injury.

1. *Water* removes many slimy and sticky substances, and contaminations originating therefrom, when, for instance, sugar, honey, glue, isinglass, gum-Arabic, white of egg, etc., have been applied to the painting.

2. *Olive Oil or Butter* removes many stains and impurities which resist soap; it dissolves pitch, rosin, and similar bodies which would require spirit of wine or oil of turpentine. It can be freely used, as it has no effect whatever upon the oil of the painting.

3. *Wood-ash* or, what is still more effective, *Potash* dissolved in water is an excellent solvent for many impurities; but it must be used with the greatest care, as it easily attacks the oil of the painting when not coated with varnish. But the use of it and of soap is frequently unavoidable, as they are the only substances which can be used for certain purposes.

4. *Soap* possesses the same qualities as the above, but as it easily forms a combination with the oil, its use is still more risky. It must therefore only be used in cases where nothing else will dissolve the stains, and then only with the greatest care.

5. *Spirit of wine* dissolves all resins, therefore it must be used to remove resinous varnishes; but it attacks also the oils and softens them that they easily rub off. *Oil of turpentine* dissolves some resinous varnishes, and many stains can only be removed by its use, which must be done with great care, as it acts very quickly upon the dry oil of the painting.

6. *Oil of Lemon* is still more powerful than oil of turpentine, and should only be used if the stains resist all other means.

Oils of Lavender and Rosemary, as well as other ethereal oils, are as powerful solvents as oil of lemon, but, being rather expensive, are seldom used.

If a painting coated with a varnish consisting of gum-Arabic, albumen, or isinglass is to be cleansed, the varnish must always be removed. This can be easily recognized if, on moistening a part of the painting, the surface feels slimy. The painting, if such is the case, frequently becomes clean by removing the varnish, which is done with hot water and a sponge, placing the painting in a horizontal position. The water can be nearly boiling hot and freely used until the varnish begins to soften, but then cooler water and in smaller quantities must be taken. In case the varnish should adhere too tenaciously to be removed with a sponge, it may be rubbed with a woollen cloth, which should be frequently wrung out and dipped in fresh, warm water.

If it is found by the above test that the varnish consists of gum resins, or other substances not soluble in water, it is best to use spirit of wine or oil of turpentine. But if any stains remain behind, the painting is rubbed with warm olive oil or butter. The rubbing is continued when it is found that some parts begin to feel smeary, or the impurities combine with the oil. The oil, on becoming dirty, is removed, and fresh applied until the stains have disappeared, the excess of oil being then wiped off with a woollen cloth. Should the painting require further cleansing, recourse must be had to a solution of wood-ash or potash prepared as follows: Dissolve 2 parts of potash in 30 of water, or pour 4½ parts of water over 2 of wood-ash; let the mixture stand for ½ day, stirring frequently. When the earthy part of the ash has settled, pour off the clear fluid and evaporate it to ½ of its volume. Heat the lye somewhat and, with a cloth dipped in, rub the stains until they disappear. Should the effect of the lye be only to attack the stain without entirely re-

moving it, soap-boiler's lye may be tried, but with the utmost caution, and immediately using water when the stain disappears. There is less danger if there is a thick coat of varnish upon the painting, and in such a case it is frequently possible to clean the painting entirely and without injuring it, by washing freely with wood-ash lye or weak soap-boiler's lye.

Should the stains resist all the means mentioned above, spirit of wine must be tried, or, if this fails, oil of turpentine, and, as a last resource, oil of lemon. The stains only, and no other part of the painting, must be gently rubbed with a linen cloth moistened with the solvent, and rubbing must cease at once in case it is noticed that the solvent attacks the colors.

After rubbing a short time, immediately apply olive oil to the stain, in case oil of turpentine or oil of lemon is used as a solvent, and water if spirit of wine, mopping it up with a woollen cloth; frequently the operation will have to be repeated.

If the painting is coated with a varnish composed of substances not soluble in water, and remains dirty after a careful application of the mentioned means, or, as happens frequently, becomes clouded, it will be necessary to remove the varnish. This is done in the following manner: Lay the painting upon a table and thoroughly moisten the surface with a sponge dipped in spirit of wine, rubbing very gently. After thus treating the entire surface for a few minutes, pour cold water over it, which will remove the spirit of wine and also the varnish dissolved by it. All rubbing or force must be strictly avoided, as this would inevitably injure the painting. This operation, when the painting is dry, may, if necessary, be repeated. If paintings with an old coat of varnish, consisting generally of gum resins and linseed oil, cannot be sufficiently cleaned in this manner, no other means are available. Such varnish, to be sure, can be somewhat reduced by rubbing the surface with oil of lemon and then gently with olive oil, but this requires the greatest care, and, as the colors of the painting generally suffer injury, is always risky.

To Remove a Painting from the Old Canvas and Transfer it to a New. Paste several sheets of paper over the painting; then take it out of the frame and place it, paper side down, upon a level table. Now moisten the canvas, but not too much, with a sponge dipped in water, till it can be detached. Commence on one corner, rolling the canvas up and continuing to moisten it, until it is entirely removed. Apply strong glue or paste to the back of the painting and the new canvas, lay the latter upon the back of the painting and rub with a roller until both are joined. When thoroughly dry, carefully remove the paper by moistening it, cleanse the painting from the glue, and coat it with *Dutch varnish* prepared as follows: Take a flask large enough to be filled about $\frac{3}{4}$ by the following ingredients: Eight parts of selected white mastic in grains, 2 of Venetian turpentine boiled hard, $\frac{1}{2}$ of elemi and 30 of pure oil of turpentine. Cover the flask with a piece of perforated bladder and place it in a water-bath until all are dissolved, shaking it frequently. When cold strain the varnish through a clean linen cloth.

How to Pack Oil-paintings for Transportation. Take the painting from the frame and carefully place upon the painted side, raw cotton, silk wadding, thin flannel, or similar materials, and roll it into a cylinder, taking care not to make the diameter too small.

To Paste an Oil-painting upon Wood, use cabinet-makers' glue, or a compound of Greek pitch and wax; or prepare a paste from flour and a little garlic crushed in water.

To Cleanse Beef's Gall to be Used as a Varnish on Paintings, etc. Boil in a porcelain dish 45 parts of beef's gall with water, and then add 2 parts of powdered alum. Stir the mixture for $\frac{1}{2}$ hour, and, when cold, filter. Then add to the gall, which is now entirely decolorized, $\frac{1}{2}$ part of anhydrous spirit of wine, let the mixture stand for 2 days, and then pour off the supernatant clear fluid, while the alum in the form of small crystals remains on the bottom of the vessel.

Cleansing and Lacquering of Oil-paintings. Mix 1 part of spirit of sal-

ammoniac and 12 of water, and rub the painting with a soft sponge moistened with the mixture. For lacquering dissolve 1 part of choice mastic in 2 of pure benzine, and filter the solution.

To Cleanse and Renovate the Gold and Framework of Old Altars. Cleanse first the lustre gold by rubbing it gently first with a fine sponge slightly moistened with oil of tartar, and then with a sponge dipped in alcohol, which will remove all the dirt. *Dead gilding* is carefully wiped with a white flannel cloth dipped in soap-boiler's lye, and then quickly dried with a fine linen rag, which will make the gilding appear like new.

For Cleansing the Framework from dirt, prepare a lye by dissolving 1 ounce of calcined potash in 1½ pints of water and wash the parts to be cleansed with a sponge dipped in the solution, and immediately afterward wipe dry with another sponge, which will make the work appear like new. Then varnish the work with an amber varnish prepared as follows: Introduce 8½ ounces of amber in pieces into an iron pot about 5 inches high and coated outside 1 inch thick with potter's clay. Pour 2 fluid ounces of turpentine over the amber and melt the whole over a moderate coal fire. Then add gradually and with constant stirring 4½ fluid ounces of hot linseed-oil varnish and 1 pint of oil of turpentine, and the varnish is ready for use.

To Repair Lustre Gilding on Altars. In cleansing altars the gold work is frequently rubbed off on the raised parts, while that in the depressions remains uninjured. The injured parts are repaired in the following manner: Melt white wax, Venetian turpentine, and a little soap over a moderate coal fire and apply the compound to the injured places with a brush. After one hour lay on the gilding, which will be far more beautiful than when laid on size.

To Restore Silver on Altars and Tabernacles. Prepare a solution of 1 ounce of Peruvian balsam in 1 pound of alcohol, and with a sponge dipped in the mixture rub quickly over the surface, and wash immediately afterwards with a sponge moistened with fresh

well water, and then dry with a clean linen cloth. If the silver is rubbed off anywhere proceed in the same manner as given for repairing gilding.

PAINTS AND PIGMENTS. GRINDING AND MIXING COLORS. GRAINING. IMITATION OF MARBLES. PAINTS AND WASHES FOR VARIOUS PURPOSES, ETC.

Grinding Colors. Although this work has in great measure been superseded by the iron paint-mill and the introduction of ground colors put up in tin boxes, many painters, either from prejudice or other causes, grind their own colors. This process is performed on a stone by the aid of a muller. The stone is generally a slab of white or black marble or porphyry with a perfectly smooth surface, and the muller a stone or glass pestle with a smooth, flat bottom. A small quantity of the dry color, previously pounded and sifted, is placed on the stone and moistened with a little oil and the muller worked over it in a circular direction. The materials are gradually worked out towards the edge of the stone, from whence they must be removed, and also from the sides of the muller, with a spatula or palette knife. All colors containing arsenic are injured by contact with steel, so that the painter should have an ivory or horn knife, called a "voider," to remove the ground paint from the stone. The paint, before it is removed, should be perfectly smooth and free from grit.

Brushes. Either round or flat brushes are used. The latter are used principally in varnishing and in graining. Smaller surfaces, such as mouldings, are painted with "sash-tools," which are an intermediate size between the large brushes and "fitches." The latter are very small brushes, bound with tinned iron instead of string.

The first process in painting wood-work is that of "knotting." As the knots in a piece of wood generally present the ends instead of the side of the grain to the eye, it is necessary to give the knots an additional coat of paint, which, by filling up the pores, shall leave the surface fit to present a

solid and uniform appearance when painted. The knotting is made of red lead, litharge, and boiled oil, or spirits of turpentine. When the knotting is dry the first coat, called "*priming*," is laid on. This is in almost all cases white lead. The priming is made thinner than any of the subsequent coats. When the priming is dry the nail-holes and other depressions are filled with putty, and the whole is well dusted. The second color is then given, which has the usual consistency of oil paint. As a general rule the preparatory coats of paint are white, whatever the finishing color is to be. When old work, or that which has been previously painted, is to be repainted, care must be taken that all grease and dirt are removed from the paint before the new is applied. For this purpose it should be washed, if necessary, with water containing soda or pearl-ash, or the greasy parts should be cleansed with turpentine. If roughness exists on the surface of the old paint it is necessary to rub it down with pumice-stone or, in extreme cases, to burn off the paint. The manner of using the brush is an art which practice alone will give. Sometimes long strokes of the brush are desirable; at others shorter strokes, or a kind of dabbing, are necessary, especially for ornamental work.

Graining. Almost all wood whose grain is of a fanciful or elegant pattern, such as oak, mahogany, bird's-eye maple, satin-wood, black walnut, rosewood, etc., may be imitated. The principle of imitation is, that a ground shall be laid on nearly the same tint as the lightest parts of the wood to be imitated, and which color is ground in oil. On this, when dry, is laid a thin coating of a transparent color, which is mixed, not with oil, but with beer; and which is so treated with a comb or other implement as to yield a resemblance to the grain of the wood to be imitated. After this is dry the darker parts are put in with a small brush or pencil, in such places and in such quantities as may be deemed advisable. The whole, when dry, is then varnished once or twice.

Oak. This is frequently used for exterior work, such as street doors, etc.,

and is done in oil as follows: For the ground or last coat of paint previous to the graining color, rotten stone and white lead, mixed with oil to a tint similar to the lightest parts of oak is used. On this is laid a thin coat of the "*meglip*" or graining color, which is a mixture of rotten stone, sugar of lead, and wax. In a few minutes the graining comb is drawn along the wet surface in a waving line, by which an effect is produced similar to the grain of the wood. A piece of leather is now wrapped round the end of the finger, or of a stick, and with it the paint is wiped off in little patches, spots or lines, in imitation of the light spots seen in oak. To remove the appearance of hardness, a dry brush is dabbed over it, by which a softening effect is produced. When the graining color is dry, the dark veins are imitated by putting on a little Vandyke brown, ground in ale.

To imitate oak in distemper, use the same ground as for oil and apply with a brush, the graining color composed of raw and burned umber, and Vandyke brown ground in beer. The graining is effected with tools made on purpose called "*veining brushes*." The light and dark patches, veins, etc., are produced in much the same way as in the former instance. When the whole is dry, it is varnished, both for the sake of producing a gloss, and for durability, since the graining color, being mixed with beer, is not of a permanent nature, and requires varnish to preserve it.

Mahogany. Use a mixture of Venetian red, white lead, and a little crimson lake as a ground, and apply a thin coat of Vandyke brown, or sienna, ground in beer as a graining color, and dab it with a sponge to produce the light parts. A badger hair brush is then drawn lightly across the light and dark parts, by which the edges of division between them are softened. When this is dry, the deeper tints of the veins, knots, etc., are put in with a darker shade of Vandyke brown, and the whole again softened with the badger hair brush.

Rosewood. This requires a brilliant ground. A mixture of vermilion, lake, and flake white is used for the purpose. The graining material is a more opaque and solid Vandyke brown than is used

for mahogany. This must be laid on in a peculiar way, so as to imitate the remarkable contortions of veins so frequently observed in rosewood. The light and dark patches, veins, knots, etc., are produced in the same manner as in mahogany, but with a careful attention to the distinctive character of the two kinds of wood.

Satin Wood. The ground is the same as for oak. The graining color is Oxford ochre ground in ale, and is laid on in a thin coat. This is dappled by letting a sponge fall on various parts of it, by which portions of the color are taken off. The edges of these dappled patches are then softened with a badger hair brush. When this coat is dry a flat graining brush is dipped in umber and sienna ground in ale, and is drawn over the work in a waving direction, by which a softened grain is produced.

Maple requires the same ground and nearly the same graining colors as satin wood; the principal point of difference being in the course and nature of the grain, veins, etc.

Walnut. Yellow ochre, umber, and white are used for the ground, and the graining color for dark veins, etc., is raw umber.

Imitation of Marble. This is accomplished in a very similar manner to that of woods, a study of the natural appearance of marbles being the only way to acquire a knowledge of the best modes of imitating them.

Green Marble. The ground is white lead, some yellow and blue. When dry it is pumiced and lightly glazed with oil varnish a shade darker than the ground. The patches are then dabbed in with some black and Paris yellow; the veins are painted white, and the whole softened by a peculiar mode of handling the badger hair brush, called by the painters "*scumbling*."

Dove-colored Marble has a ground of light lead color. *Florentine marble* has a ground of white, Indian red, and black mixed together; *Sienna marble* a ground of yellow ochre. In all these cases the veins must be put in with such colors as will most successfully imitate the patterns of the original marbles.

Receipts for Colors. American Green,

Grind and mix: White 1 part, yellow ochre $\frac{1}{2}$, lampblack $\frac{1}{2}$, Berlin blue $\frac{1}{2}$.

Apple-green. Grind and mix: Mineral green 1 part, chrome-yellow $\frac{1}{2}$.

Apple-green (Lighter Shade). Mineral green and white each 1 part, chrome-yellow $\frac{1}{2}$.

Apple-green (Very Light Shade). Chrome-yellow 1 part and Berlin blue $\frac{1}{2}$.

Aurora. Mix chrome-yellow 1 part with vermilion $\frac{1}{2}$.

Azure-blue. White 1 part and Berlin blue $\frac{1}{2}$.

Blue (Cornflower). White 1 part, Berlin blue $\frac{1}{2}$, and some lac varnish.

Bluish-white. Grind very fine 1 part of white lead or zinc white, and add $\frac{1}{2}$ of indigo.

Bremen Green. Mix: White 1 part, chrome-yellow $\frac{1}{2}$, Berlin blue and lampblack each $\frac{1}{2}$.

Chamois. White 1 part, chrome-yellow $\frac{1}{2}$, vermilion $\frac{1}{2}$.

Cherry-red. Grind and mix: Cinnabar 1 part and lac varnish $\frac{1}{2}$.

Chestnut-brown. Prussian red 1 part, lampblack $\frac{1}{2}$, and cinnabar $\frac{1}{2}$.

Crimson. Mix vermilion and carmine lake.

Enamel-white. Add a trace of Berlin blue to 1 pound of white lead or zinc white.

Flax-gray. Grind 1 part of white lead or zinc white, and add $\frac{1}{2}$ of lampblack and a like quantity of lake.

Golden-yellow. Grind 1 part of white and add $\frac{1}{2}$ of chrome-yellow.

A Beautiful Golden-yellow Color is obtained by brightening Naples or Montpellier yellow with Spanish white or white of Morat, mixed with ochre de Berry and realgar. The last substance, even in a small quantity, gives to the mixture a color imitating gold, and which may be employed in distemper, varnish, or oil.

Grass-green. Grind and mix: Chrome-yellow 1 part, Berlin blue $\frac{1}{2}$.

Grass-green (Lighter Shade). Chrome-yellow and white each 1 part, Berlin blue $\frac{1}{2}$.

Hazel-yellow. White 1 part, yellow ochre $\frac{1}{2}$, red ochre and black paint each $\frac{1}{2}$.

Jonquil. White 1 part, chrome-yellow $\frac{1}{2}$.

Lemon Color. White 1 part, chrome-

yellow $\frac{1}{2}$, Berlin Blue $\frac{1}{10}$; or, white 1 part, mineral yellow $\frac{1}{2}$.

Light Gray. Mix $\frac{1}{10}$ part of lampblack with 1 of white lead or zinc white.

Lilac. I. Grind and mix: White 1 part, lake $\frac{1}{8}$, Berlin blue $\frac{1}{8}$.

II. White 1 part, red madder lake and ultramarine each $\frac{1}{8}$.

Mahogany. Grind and mix: White 1 part, sienna $\frac{1}{8}$, and Paris red $\frac{1}{8}$.

Oak. Grind and mix: White 1 part, saffron-colored ochre $\frac{1}{8}$, and black paint $\frac{1}{8}$.

Olive-green. Grind and mix: Yellow ochre 1 part and lampblack $\frac{1}{2}$.

Sea-green. White 1 part, chrome-yellow $\frac{1}{8}$, and Berlin blue $\frac{1}{8}$.

Silver-gray. Grind 1 part of white lead or zinc white, and add enough indigo to obtain the desired shade.

Straw Color. Grind fine 1 part of white lead or zinc white, and add $\frac{1}{8}$ of chrome-yellow.

Sulphur Color. Grind and mix: White and mineral yellow each 1 part, and the necessary quantity of Berlin blue to obtain the desired shade.

Violet (Dark). Grind and mix equal parts of carmine lake and Berlin blue.

Violet (Medium). Carmine lake 1 part, Berlin blue $\frac{1}{8}$.

Violet (Light). Carmine lake $\frac{1}{2}$ part, white 1, and Berlin blue $\frac{1}{8}$.

Violet (Very Light). Mix: Carmine lake and white each 1 part, and Berlin blue $\frac{1}{8}$.

Violet (Bluish). Carmine lake and white each 1 part and Berlin blue $\frac{1}{8}$.

Walnut (Dark). Grind and mix: White 1 part, umber $\frac{1}{2}$, and red ochre $\frac{1}{8}$.

Walnut (Lighter Shade). White 1 part, saffron-colored ochre and sienna each $\frac{1}{8}$.

Walnut (Very Light). White 1 part, saffron-colored ochre and sienna each $\frac{1}{8}$.

PAINTS FOR VARIOUS PURPOSES.

Flexible Paint. Slice 2½ pounds of good yellow soap and dissolve it in 1½ gallons of boiling water, and grind the solution while hot with 3½ gallons of good oil paint. It is used to paint on canvas.

New Paint for Floors, Stone, Wood, and Brickwork. This new paint has the advantage of saving oil and lacquer, being simply a combination of glue, oil paint, and lime, and for wooden floors

an addition of shellac and borax. To prepare the ground mixture, soak 2 ounces of good light-colored glue for 12 hours in cold water, and dissolve it, with constant stirring, in thick milk of lime (prepared from 1 pound of caustic lime) heated to the boiling point. To the boiling glue stir in linseed oil until it ceases to mix. About 8½ fluid ounces of oil is sufficient for the above proportions. Too much oil is corrected by addition of lime paste. Mix the above with any color not affected by lime, and diluted with water if needed. For yellow-brown or brown-red colors, boil in the ground color $\frac{1}{2}$ of its volume of a solution of shellac and borax, making an excellent paint for wooden floors.

The mixture is easily applied, covers well, and forms a durable combination with any covering, and, as any desired shade can be produced by an addition of proper colors, it may often be substituted for more expensive paints. A simple coat of varnish or lacquer gives a beautiful lustre.

Water-proof Paint. Boil 2 gallons of linseed oil with 11 ounces each of rosin and litharge, 1½ ounces each of minium and umber, add gradually 8 ounces of sulphate of zinc and a solution of 12 ounces of potassium hydrate and a like quantity of alum in 4 gallons of water. For preparing the ground color compound 10 pounds of chalk and 2 pounds of zinc white with $\frac{3}{4}$ gallon of water, in which 1½ ounces of alum have been previously dissolved, and mix with this a solution of 1½ pounds of glue in $\frac{1}{2}$ gallon of water. This ground paint is mixed with 4 to 5 pounds of the above composition, and the mixture diluted with petroleum.

Paint Suitable for Vessels, Submarine Works, etc. A solution of 400 pounds of sulphate of copper is compounded with 100 pounds of grape sugar and a concentrated solution of 200 pounds of potash. The precipitate of hydrated oxide of copper formed by heating is filtered, carefully dried, and mixed with 8 pounds of 75 per cent. carbolic acid. The mass is then moderately heated and about 12 gallons of crude linseed oil added. When the paint is to be used, it is reduced with

linseed oil, and then applied. It is claimed that it has a poisonous effect upon animal and vegetable bodies depositing themselves on vessels or submarine works.

Cheap and Durable Paint for Brick-work. Slake fresh-burnt lime to a powder by sprinkling water upon it and pass the powder through a sieve. To 100 parts of this powder add sufficient water to form a thin milk of lime and boil it in a copper boiler, and add 1 part of bichromate of potassium. Make a thin paste of sulphate of lead with water and stir it in the boiling mixture. Sugar of lead or the nitrate of hydrochlorate of lead can be substituted for the sulphate of lead. Add cold water to the mass and pass it through a fine wire sieve, drain it off through linen or cloth bags, and press the residue remaining in the bags. After sufficient pressing break into pieces and dry in the air.

To Prepare a Zinc Wash for Rooms. Mix oxide of zinc with ordinary milk of lime and apply the mixture in the same manner as whitewash. When dry lay on a coat of solution of chloride of zinc. This combines with the oxide and forms a solid coat with a lustrous surface.

Durable Paint for Tin Roofs. Thirty parts of linseed oil, 10 of oil of turpentine, 14 of colcothar, and 46 of red chalk. The coloring substances are pulverized and the mixture ground. Should the paint be too thick reduce it with equal parts of oil of turpentine and linseed oil. To protect the tin thoroughly against atmospheric influences it is advisable to give it two coats, allowing the first to dry before applying the second. The coats must be neither too thin nor too thick; a principal condition being that the tin is free from rust.

White Paint for Metallic Surfaces. Pure, finely-powdered zinc white (oxide of zinc) is mixed with a solution of soda water-glass of 40° to 60° Beaumé, to the right consistency for an oil paint. The metallic surface to be painted is thoroughly cleansed and washed with hydrochloric acid, and afterwards with water, and the paint is laid on in successive coatings. Not too much paint must be mixed at a

time, as it will become thick and dry on standing, on account of chemical combinations setting in. A surface thus painted preserves a dazzling white appearance. By adding mineral colors various tints may be obtained.

Green Paint for Articles Exposed to the Action of the Weather, such as Doors, Shutters, etc. Rub 2 parts of white lead and 1 of verdigris with nut oil or linseed oil varnish, mixed with oil of turpentine, and dilute both colors with ordinary drying oil.

Universal Paint. A decoction of Brazil wood and flaxseed is mixed with a solution of caoutchouc in linseed oil and compounded with coloring substances until a thick paste is formed. It can be applied reduced with water as well as with oil or lacquer.

Paint for Outside Walls. Boil 1 pint of clear linseed oil, 4½ ounces of rosin, and 3 ounces of litharge until the wooden spatula used for stirring becomes brown. Give the walls two or three coats of this. It is best to do the work on a hot summer's day.

Paint for Wood or Stone which resists all moisture. Melt 12 ounces of rosin, add and thoroughly mix with it 6 gallons of fish oil and 1 pound of melted sulphur, and some ochre or any other coloring substance rubbed up with linseed oil. Apply several coats of the hot composition with a brush. The first coat should be very thin.

Cheap White Paint for Outside Work. Slake 1½ pounds of burnt lime with the necessary quantity of water; then add 6½ pounds of skimmed milk. Dissolve 4½ ounces of white Burgundy pitch in 12 ounces of linseed oil; add this to the lime and milk, and finally add 6½ pounds of Spanish white to the mixture.

Red Wash for Brick Floors and Pavements. Wash the bricks with soap water containing ½ part of carbonate of soda. This cleanses the floor and prepares it for the reception of the wash. Then dissolve 1 part of glue in 16 of boiling water, add 4 parts of red ochre, and stir the mass thoroughly together. Apply two coats of this to the bricks, and then give a coat of linseed oil varnish.

To Prevent Disintegration in Stone-work. Apply the following solutions

to the stonework by means of a watering-pot provided with a rose. They should be applied in such a manner that they are uniformly distributed and cannot run off. The solutions consist of

1. *For Marble.* One part of white shellac and 8 of wood spirit.

2. *For Sandstone.* One-half part of shellac and 8 of wood spirit.

The shellac is broken into small pieces and added to the wood spirit, and the mixture allowed to stand for a few days, being frequently stirred.

To Make Sail-cloth Pliable, Durable, and Water-proof. I. Moisten the sail-cloth first with linseed oil; ground it with Spanish brown rubbed up with linseed oil or rosin oil, and when this is dry give it a coat with a paint prepared from Spanish brown, lampblack, linseed oil, and a sufficient quantity of purified rosin oil.

II. Mix 96 parts of ochre with boiling oil, add first 16 parts of lampblack, and later on a solution of 1 part of yellow soap in 6 of water. Give the sail-cloth a good coat of this mixture, and repeat the operation 2 days later.

Swedish Paint for Wood-work. Melt 3 parts of rosin, add 20 parts of fish oil, and heat until the mass is uniform. Then stir 10 parts of rye flour into a paste with 20 parts of water. Next dissolve 4 parts of sulphate of zinc in 9 of boiling water. The 3 mixtures are combined by stirring the flour paste into the solution of sulphate of zinc, and into this mixture the fish oil containing the rosin. To obtain the desired tint a suitable mineral color finely ground is then added, when the paint is ready for use.

Paint for Constructions of Iron. Rolling-mill and hammer scale are finely ground and washed, and then stirred together with oil varnish. By painting the iron work of bridges, etc., with this composition, they will be thoroughly protected against rust.

Paraffine Paint. A solution of paraffine in heavy coal-tar oil is excellent for painting houses, and especially walls exposed to the action of the weather. Several experiments in painting damp walls with this solution have given very satisfactory results. Wall paper, which formerly became moist and de-

tached from the walls during rainy weather, remained perfectly dry after the wall had been painted with paraffine. The solution of paraffine in heavy coal-tar oil is prepared by dissolving 1 part of paraffine in 2 to 3 parts of coal-tar oil at a moderate heat. A sufficient quantity of oil must be used so that the solution does not entirely congeal on cooling. To heat the paint while applying it, place the vessel containing it in hot water. It is best to apply the solution on a warm day when the bricks are dry. Generally 1 coat is sufficient, but even if 2 coats are given the cost is considerably less than oil paint.

Quickly-drying Oil Paint. Boil for 15 minutes in an earthen-ware pot 1 part of soft curd in 3 parts of water. Pour the mass through a colander, wash it with cold water, and press out the water in a linen cloth. To 1 part of the curd add $\frac{1}{2}$ part of unslaked lime and $\frac{3}{4}$ part of water. The fat slime thus formed is triturated in oil or water with the various pigments. Walls, ceilings, stairs, in short anything of stone, plaster of Paris, or zinc, can be painted with this. If the paint is to be used on wood, add $\frac{1}{16}$ part of linseed oil. Ochre, chrome yellow, Berlin blue, indigo, lead, and zinc, are best adapted for coloring substances. The mixture dries so quick that 3 coats can be applied in 1 day. It is entirely without odor and costs about $\frac{1}{3}$ of ordinary oil paint.

Paint for Roofs. This paint consists of a mixture of 35 per cent. of pulverized slate (argillaceous schist), 30 per cent. of pulverized mica slate (mica schist), and 35 per cent. of pulverized rosin. Compound this mixture with $\frac{1}{2}$ its volume of pure coal-tar and boil to a fluid mass. This paint gives a very durable and pliant coating, which does not melt in the greatest heat of summer nor crack nor break in the greatest cold. It resists moisture, retains its lustre and smooth surface. It is not necessary to repaint the roof for 4 or 5 years.

Paint on Wood exposed to the Action of the Weather. Mix 6 parts of unslaked lime and 1 part of coal dust, both in a dry state, and then add sufficient sour milk to form a mixture which can be applied with a brush. The color of the mixture is a light

gray, but any desired tint can be obtained by adding a mineral color. This paint has been tested and can be highly recommended for wood and frame work.

Water-proof Paint for Metal. Dissolve 3 pounds of Venetian turpentine and 1 pound of mastic in heated turpentine. Then add to this solution 96 pounds of linseed-oil varnish, and heat the whole in a water-bath until the odor of oil of turpentine has disappeared. With 115 pounds of this varnish triturate 20 pounds of strongly-burned clay, 80 pounds of best Portland cement, 10 pounds of zinc white, and 5 pounds of red lead. When the whole has been rubbed fine and intimately mixed together add 25 pounds more of oil of turpentine.

Coating for Blackboards. Dissolve 8 ounces of copal in 1 pound of ether, and compound this with a solution of 2 pounds of shellac and 1 pound of sandarac in $3\frac{1}{2}$ quarts of 90 per cent. alcohol, and further with 5 ounces of lampblack, $1\frac{3}{4}$ ounces of ultramarine, 1 ounce of Venetian turpentine, and 2 pounds of fine *Naxos* emery. This mixture is applied with a brush to the blackboard, and the coating, while moist, ignited. As soon as the flame is extinguished, a second coat is laid on, which is not ignited but allowed to dry. The board is then rubbed with fine sand-paper, and, when cold, washed. The board has a smooth surface and can be written on with a slate-pencil, and the writing washed off with a sponge.

To Protect the Bottoms of Ships and other Articles under Water the following mixture has been patented in England: Sixty parts of alcohol, 9 of shellac, 4 of rosin, 3 of Burgundy pitch, 2 of soft galipot, 4 of arseniate of copper, 3 of arseniate of mercury, 9 of chromate of mercury, and 6 of coloring substance.

Dryer for Oil Colors and Varnish. Heat in a copper vessel 12 parts of shellac and 4 of borax with 80 to 100 parts of water, when, after the mass has become homogeneous, the vessel is closed, and its contents, when cold, are poured into flasks, which are kept closely corked. This solution may be used as a quick-drying varnish, and

when mixed in equal weights with oil colors it causes them to dry quickly.

To Prepare Dryers. Take 2 parts of white lead, 1 of sulphuric acid, and 1 of sugar of lead, and rub them to a paste in boiled linseed oil. This is used as an addition to all mixed oil paints except white, to dry them. White lead, when mixed with this siccativ, assumes a dirty color.

Patent Dryer. Mix 15 parts of dried sulphate of zinc, 4 of sugar of lead, and 7 of litharge with boiled oil, and pass the mixture 3 or 4 times through a color mill. Then mix 100 parts of Paris white to a dough with 50 parts of white lead and boiled oil, pass this through a color mill, mix it with the above, and rub the whole up once more. The result will be 2000 parts. This is mixed with the paint to make it dry quickly.

Dryer for Zinc Paint. 6.66 parts each of anhydrous sulphate of manganese, anhydrous acetate of protoxide of manganese, and anhydrous sulphate of zinc, and 980 parts of zinc white. An addition of 2 or 3 per cent. to zinc paint suffices to dry it quickly.

Drying Oil. Boil together for 2 hours on a slow fire: $\frac{1}{2}$ ounce each of litharge, calcined cerussite, umber, and talc with $1\frac{1}{2}$ pints of linseed oil, carefully stirring the whole time. Skim and clarify the mixture. The older it grows the better it is. One gill is required to every 1 pound of color.

To Paint Tiles Red. Cleanse the pavement thoroughly with a brush dipped in soap water, or water charged with $\frac{1}{2}$ part of carbonate of potassium. When dry dissolve 1 pound of glue in 1 gallon of water. Boil the mixture, and while boiling add 2 pounds of red ochre and mix the whole. Then apply a layer of this mixture to the pavement, and when dry apply a second layer with drying linseed oil, and a third with the same red mixed up with size. When the whole is dry rub it with wax.

PIGMENTS. *Black. Lampblack,* the most important of all blacks used in painting, is produced from common rosin or other bituminous substances. A very superior black may be obtained in the following manner: Ignite a lump

of camphor and hold a saucer over the flame to collect the soot, which, mixed with gum-Arabic, makes a black superior to many India inks. Miniature painters who use colors in small quantities sometimes obtain a most beautiful and perfect black by using the buttons which form on the snuff of a candle, when allowed to burn undisturbed. They are allowed to fall into a thimble which is immediately covered with the thumb to exclude the air. This is found to be perfectly free from grease, and to possess every desirable quality.

Frankfort Black is produced on a large scale in some districts of Germany by calcining wine lees and tartar. The operation is performed in large cylindrical vessels having a vent in the cover for escape of the smoke and vapors which are evolved during the process. When no more smoke is observed the operation is finished. The residuum in the vessels is then washed several times in boiling water to extract the salts contained therein, and finally reduced to the proper degree of fineness by grinding it on porphyry.

Peach-stones, burned in a close vessel, produce a carbon which, when ground on porphyry, is employed in painting to give an old gray.

Ivory Black can be produced on a small scale by calcining ivory chips in a covered crucible, having a small aperture in the cover, until no smoke is seen to escape. It is the most beautiful black for painting in oil. The commercial ivory black is generally nothing but bone-black.

Brunswick Black. Melt 2 pounds of asphaltum, then add $1\frac{1}{2}$ pints of hot-boiled oil, and finally $1\frac{3}{4}$ quarts of turpentine. It is used for painting iron railings and other iron work.

Black from Coal Ashes and Blood. Pass coal ashes through a fine sieve and mix the sifted ashes with blood to a thick paste, and dry it in the air or over a fire to expel the water. When entirely dry the mixture is brought into a drum resembling a coffee roaster, and calcined until all organic parts in the blood are thoroughly carbonized and no more gas escapes through the joints of the drum. It is then cooled, and the lumpy substance remaining in the drum taken out and ground to a fine

powder. This black is used in painting outside walls, and may also be used in the manufacture of lacquers and shoe-blackening.

Berlin Blue. Mix 2 parts of alum with 1 of sulphate of iron, and add sufficient water to dissolve them. Then prepare a solution of yellow prussiate of potassium, add a little sulphuric acid, and pour the mixture drop by drop into the first solution until a precipitate is formed, which is washed upon a filter and then dried.

Mountain Blue. First prepare a genuine Brunswick green by dissolving equal parts of sulphate of copper and common salt in 6 to 8 parts of boiling water, and dilute the solution with 30 parts more of cold water, filter the turbid liquid and precipitate the oxide of copper with milk of lime. After 24 hours remove the precipitate from the fluid, wash it repeatedly in cold water, and, after cutting it up in small cakes, dry them. These small cakes, when dry, are placed in fresh-prepared lime paste, where they remain for 3 weeks, being frequently carefully turned. The lime is then diluted with water; the cakes, which have assumed a beautiful dark-blue color, are taken out, washed, dried, and finally ground.

Ultramarine (Artificial). Mix 2 parts of pulverized verdigris, 1 of powdered sal-ammoniac, and 1 of finest white lead; moisten the mixture with some oil of tartar (*Oleum tartari per deliquum*), put the whole in a strong glass, close it tight, and place it for 1 hour in a bake-oven. Then take it out, rub the powder very fine, and preserve it in a well-closed jar.

Robiquet's Artificial Ultramarine is prepared by calcining 3 parts of porcelain clay in a covered crucible for 1 hour, together with $4\frac{1}{2}$ parts of sulphur and 4 parts of carbonate of sodium perfectly dry and thoroughly calcined, until no more vapors escape, and a sample taken from the crucible has a greenish appearance. The caked compound is then exposed to the air for 24 hours, when the color will change to blue. It is then lixiviated and the residue dried, and the latter again exposed in a crucible to a strong heat. In this manner $3\frac{1}{2}$ parts of pure ultramarine are obtained.

Carmine. Pulverize $5\frac{1}{2}$ pounds of cochineal and $\frac{1}{2}$ ounce of alum, and boil them in a tinned copper boiler with distilled or rain water for $\frac{1}{4}$ hour; then filter the color through a clean cloth, and add solution of tin, drop by drop, as long as a precipitate is formed in the warm liquid. After the carmine has been entirely precipitated wash it with clean water and dry it between 2 porcelain plates in an airy room but not too warm. The residue can be used for Florentine lake.

Carmine Lake. Digest at a moderate heat 2 ounces of ground cochineal with 3 pints of distilled water, and then add, with constant stirring, 1 drachm of alum, $1\frac{1}{2}$ fluid drachms of solution of tin, and 1 drachm of pure soda dissolved in water. Let the whole stand for 2 days, then separate the sediment, wash, and dry it.

Florentine Lake. Boil 4 parts of cochineal and 12 of alum with a sufficient quantity of water, then strain and add to the hot decoction a solution of potash as long as a precipitate is formed. The latter is washed, filtered, formed into balls, and dried.

Green Borate of Copper for Oil and Porcelain Painting. Dissolve separately 16 parts of sulphate of copper and 24 of borax in the requisite quantity of water, mix both solutions by stirring them thoroughly together, collect the pale-green precipitate upon a filter, wash with cold water, and dry, first at an ordinary temperature and then with the aid of heat, and finally rub the powder fine.

Chrome-green. I. Pulverize 1 part of bichromate of potassium, $1\frac{1}{2}$ of sal-ammoniac, and 1 of carbonate of potassium. Mix the powders intimately, calcine them in a Hessian crucible, and wash the residue.

II. Pulverize 240 parts of bichromate of potassium and 5 of sal-ammoniac. Mix the powders intimately with 48 parts of gunpowder and form a cone of the mixture. Ignite the point of the cone, let it gradually burn down, and put the hot residue in water, where the green oxide will settle on the bottom of the vessel.

Chrome-green for Painting. Pulverize and mix 19 parts of bichromate of potassium and 4 of sulphur. Calcine

the mixture for $\frac{1}{4}$ hour, and, when cold, pulverize the compound and treat it with water. In this way $9\frac{1}{2}$ parts of a beautiful chrome-green are obtained.

Innoxious Green Color. Digest for a few days 25 grains of best saffron with $3\frac{1}{2}$ fluid ounces of distilled water, and, when the saffron is thoroughly extracted, filter the solution and mix it intimately with one of 25 grains of indigo carmine in 1 pint of distilled water. This gives a beautiful green color of great intensity.

Mineral Green. Put whiting or lime into a vat and pour solution of nitrate of copper upon it; stir thoroughly and allow the whole to settle. Then pour off the supernatant liquid and add more solution. Repeat this operation until the desired tint is attained.

Newwed Green. Dissolve 16 parts of sulphate of copper in hot water, and add a solution of 3 parts of pulverized white arsenic in the necessary quantity of hot water. Allow it to stand for 24 hours, then pour off the clear liquid, and add, with constant stirring, milk of lime prepared from 3 parts of quicklime. The green precipitate which is formed is washed and dried.

Paris Green or Scheele's Green. An arsenite of sodium is formed by adding arsenic to carbonate of sodium dissolved in boiling water; next sulphate of copper is dissolved in water; both solutions are filtered and the first is poured gradually into the second as long as it produces a rich grass-green precipitate. This is thrown upon a filter and cleansed by washing away all particles soluble in water, and is then dried and pulverized.

This pigment is highly poisonous. It is very transparent, works badly under the brush, and covers badly; but its color is so brilliant that all other greens become dingy brown in contrast with it, and for this reason it is frequently used.

Schweinfurth Green as made in Schweinfurth. Dissolve 100 parts of white arsenic in 1500 of hot water; next dissolve 70 parts of verdigris, coarsely powdered, in 300 of boiling water. As soon as the arsenious solution is thoroughly boiled, and the verdigris paste has acquired a temperature of 190° F., $\frac{2}{3}$ of the arsenious solution is intimately

mixed with the verdigris solution and the whole allowed to stand for 3 hours. The mixture is then thoroughly stirred and the rest of the arsenious solution added.* In the course of 2 or 3 hours the precipitate begins to form, and thin films of a beautiful green color are seen upon the surface of the compound, the precipitate finally settling on the bottom. The liquid portion is then drawn off, the precipitate collected, washed with water, dried, and sifted.

Verdigris, a union of oxide of copper and acetic acid, is produced by exposing small sheets of copper to the action of vinegar in the following manner: The refuse of grapes, after the extraction of the juice, is placed in earthen vessels, which are covered with lids and surrounded with straw mats. The materials soon become heated, and fermentation, beginning on the bottom, rises until it permeates the whole mass. At the end of 2 or 3 days the fermenting materials are removed to other vessels in order to check the process, to prevent putrefaction. The copper plates are prepared by rubbing them with a cloth dipped in a solution of verdigris, and then allowed to dry. When the materials are all found to be in proper condition, the plates are laid on a horizontal wooden grating in the middle of a vat, on the bottom of which is placed a pan of burning charcoal, which heats them to a certain degree. In this state they are put into earthen vessels, with alternate layers of the fermenting grape lees; the vessels are covered with straw mats and left at rest. At the end of 10 or 15 days they are opened to ascertain if the operation is completed. If detached glossy crystals are perceived on the surface the lees are thrown away and the plates are placed upright in a cellar, one against the other. At the end of 2 or 3 days they are moistened by being dipped in water, which is continued at intervals from time to time. This treatment causes the plates to swell, to become green, and be covered with a layer of verdigris. This is scraped off, pressed in paper sacks, dried by exposure to sun and air, and becomes the verdigris of commerce.

Indigo Carmine. Dissolve 2½ pounds

of indigo ground as finely as possible in 13¾ pounds of sulphuric acid. Then add 4 gallons of water and next a solution of potash of 15° Beaumé until effervescence ceases. It is then washed with water and allowed to settle, this being repeated until every trace of acid is removed. The paste is kept in glazed pots well covered.

Chrome-red. Ten pounds of yellow chromate of potassium and 20 pounds of pure white lead. The white lead is first ground as fine as possible in water. The chromate of potassium is then carefully dissolved in 25 gallons of boiling hot water and the white lead stirred into the boiling solution. The whole is then boiled, the water lost by evaporation being constantly replaced until no more white spots appear upon the surface. The liquid portion is then quickly poured off and the residue thrown upon a filter. The manipulation must be carried on as quickly as possible lest the color should become too light.

Cassel Yellow. Heat a mixture of 10 parts of litharge finely prepared and 1 of sal-ammoniac in a Hessian crucible until it melts; then pour the mass into a mould, powder the pieces when cold, and grind fine in a color mill.

American Chrome-yellow.

	PARTS.		
	I.	II.	III.
Crystallized sugar of lead	21	21	21
Bichromate of potassium	4	4	4
Alum	20	20	20
Heavy spar	10	15	20
Gypsum			20

Dissolve the alum in hot water and pour the hot solution into a tub containing the heavy spar and gypsum, previously passed through a fine sieve; then wash the whole gradually and carefully five times. In the meanwhile dissolve the sugar of lead and bichromate of potassium in separate vessels, and then stir the chromate solution very slowly into the solution of sugar of lead. When all is settled, wash with fresh water, repeating this 3 or 4 times. Finally mix and mingle the two precipitates carefully and very intimately, wash twice, and throw the finished product upon a filter. It is customary to spread the residue without pressing

upon drying boards, to cut it, when half dry, into square pieces, which, when entirely dry, fall off of their own accord. The boards should be placed in a room secured from dust and dirt. But the pigment dried in this manner requires polishing. This is accomplished by filling a bag made of strong ticking about $\frac{1}{4}$ with cakes, tying it, and two persons, catching hold on opposite ends, shaking the bag vigorously, whereby the cakes, rubbing against each other, acquire a gloss. The yellow dust falling through is collected and added to inferior qualities.

Baltimore Chrome-yellow. Sugar of lead 40 pounds, vinegar $\frac{1}{2}$ gallon, bichromate of potassium 8 pounds, Roman alum 40 pounds, Klagenfurt chalk 20 pounds. First elutriate the chalk through a fine sieve with about 25 gallons of water. Then mix with it the alum dissolved in about 30 gallons of hot water, stir constantly, and finally wash carefully with water 4 or 5 times. Now dissolve the sugar of lead in 25 gallons of hot water, stir the solution into the above compound, and at the same time the $\frac{1}{2}$ gallon of vinegar. Somewhat later dissolve the chromate of potassium in 25 gallons of hot water, and add this solution to the rest. The further treatment is as given for American chrome-yellow.

French Chrome-yellow (Spoooner's). Boleine chalk $17\frac{1}{2}$ pounds, alum $35\frac{1}{2}$ pounds, sugar of lead $48\frac{1}{2}$ pounds, red chloride of potassium $8\frac{1}{2}$ pounds. This is prepared in the same manner as Baltimore chrome-yellow; the cakes are stamped "Spoooner" with a wooden stamp.

Paris Chrome-yellow.

	F.	FF.
Sugar of lead . . .	10 parts.	10 parts.
Bichromate of potassium . . .	3 "	3 "
Heavy spar . . .	10 "	10 "
Sulphate of lead . . .	20 "	25 "
Bologne chalk	10 "

Elutriate the sulphate of lead, heavy spar, and chalk through a fine sieve into a vat, draw off the lye and wash twice. The sugar of lead and bichromate are dissolved in the same manner as given above, and then poured in succession into the vat. The mixture is com-

pounded with as much fresh water as possible, which, when all is settled, is drawn off. The product is then thrown upon a filter, and as soon as it is practicable formed into small cones.

Naples Yellow (Various Shades).

	I.	II.	III.	IV.	V.	VI.
	Parts.					
Antimonic acid . . .	4	1	3	1	1	2
Plumbic oxide . . .	2	2	3	1	1	1
Zinc oxide . . .	1	1	1	1		

Patent Yellow. Grind 1 part of salt and 4 of litharge in water, wash out the carbonate of sodium and heat the residue until it has acquired a beautiful yellow color.

Vandyke Red. Prussiate of potash 25 parts, spirit of sal-ammoniac 2.5 parts, and sulphate of copper 15.5. The prussiate of potash is dissolved in hot water and carefully compounded with the spirit of sal-ammoniac, and the whole allowed to stand for some time. The sulphate of copper is in the meanwhile dissolved in another vessel and then slowly and with constant stirring added to the prussiate of potash. The pigment is then allowed to settle, and the liquid portion drawn off and the residue washed and rewashed with clean water, and then thrown upon a filter, where it should be dried as quickly as possible.

Innoxious Colors for Painting Toys.
a. White. Calcined magnesia is used by itself as well as in connection with other colors. It should be thoroughly calcined, as otherwise it becomes gray when mixed with hot glue water, or in varnishing.

b. Mix thoroughly fine chalk 4 parts, calcined magnesia 2, with a few drops of solution of indigo.

c. The solution of indigo is prepared by mixing $\frac{1}{4}$ part of indigo finely pulverized with 1 part of concentrated fuming sulphuric acid.

d. A cheaper white is prepared by using Berlin blue in place of indigo solution.

e. Chrome-yellow. Take any desired quantity of *d* and a few drops of ex-

tract of saffron, and add concentrated aqueous decoction of Avignon berries until the desired shade is obtained.

The decoction of Avignon berries is obtained by pouring hot water over the berries and adding some alum or common salt.

f. Yellowish-green. Take equal quantities of Dutch pink and white given under *b*.

g. Golden-yellow. Take any desired quantity of white given under *d*, and compound it with aqueous extract of saffron until the desired shade is obtained.

h. Yellowish-red. Mix 1 part of red chalk and 4 of Dutch pink with some liquid glue.

i. Brownish-red. Mix equal parts of red chalk and round lake with some hot glue water.

k. Black-brown. Mix 6 parts of red chalk with 1 of calcined lampblack.

l. Vermilion. Take any desired quantity of carmine and mix it with a few drops of concentrated extract of saffron and some hot glue water.

m. Rose-red. Mix 1 part of round lake and 2 of white given under *d*.

n. Flesh-color. Mix 4 parts of calcined magnesia with 1 of extract of rhubarb, prepared by boiling $\frac{1}{2}$ part of rhubarb in 3 of hot water.

o. Violet. Mix 4 parts of round lake and 1 of indigo with some hot glue water.

p. Violet-red. Mix 8 parts of round lake and 1 of indigo.

q. Blue. Use indigo and Berlin blue mixed with white given under *d*.

r. Gray. Take 12 parts of white given under *d*, $\frac{1}{2}$ of indigo, and $\frac{1}{2}$ of calcined lampblack.

s. Imperial Green. Take 6 parts of decoction of Avignon berries, $\frac{1}{2}$ of indigo, and 1 of white given under *d*.

t. Light Green. Mix 1 part of solution of saffron with 3 of white given under *d*.

u. Dark Green. Mix 6 parts of Dutch pink and $\frac{1}{2}$ of indigo.

All the above colors are calculated as water colors, and, when dry, are coated with a light mastic varnish.

Colors which, on account of the Poisonous Qualities, should not be used for Painting Toys or in Coloring Articles of Food. *Blue: Mountain blue,*

mineral mountain blue, imperial blue, protoxide of cobalt, Berlin blue containing zinc or copper, Bremen blue, ash-blue (zaffer), silver-blue, Vienna blue.

Brown: Terra di sienna, and the colors mentioned under *red* mixed with black.

Green: Verdigris; Brunswick green; mountain green; Swedish green; Scheele's green; Vienna, Schweinfurth, Paris, and Berlin green; green bronze; imperial green; English and Cassel green; chrome-green, cobalt green, mineral green, Naples green, Newwied green; and every mixture of the colors mentioned under blue and yellow.

Metallic Colors: Metallic gold, metallic silver, Dutch gold, silver leaf, gold bronze, silver bronze, copper bronze, and red antimony.

Orange: Mixtures of the colors given under red and yellow.

Red: Cinnabar, minium, protoxide of copper, chrome-red, English red; mineral red.

Violet: Mixtures of the above blue and red colors.

White: White lead, Kremnitz white, flake-white, heavy spar, zinc white.

Yellow: Orpiment, imperial yellow, Cassel yellow, Naples yellow, massicot, English yellow, mineral yellow, chrome-yellow, gamboge, yellow bronze, Paris yellow.

Artists' Colors and for Restoring Pictures. The following 13 colors are the most important for artists: Venetian or Kremnitz white; light ochre, dark ochre, burnt light ochre, burnt dark ochre, sienna, burnt sienna, umber, burnt umber, Cologne earth; ivory black, fine Parisian blue, red cinnabar. These pigments suffice for almost all modern painting, but some of the old masters used special colors, and to imitate them closely the following pigments will have to be used: Naples yellow, Florentine or Vienna lake, minium, ultramarine, green Verona earth, cobalt blue, brown Munich lake.

Kremnitz or Venetian White is a chemical compound prepared from lead and vinegar, requires no oil varnish, and dries easily in poppy or nut oil.

Light Ochre, a native pigment, requires oil varnish for drying, as also *Dark Ochre.*

Light Burnt Ochre has lost its peculiar fatty constituents by calcining, and requires only to be ground in poppy-seed or nut oil.

Dark Burnt Ochre requires some oil varnish for drying.

Sienna also requires an addition of oil varnish.

Burnt Sienna requires only to be ground in poppy-seed or nut oil.

Umber is to be ground in poppy-seed oil, as also *Burnt Umber*.

Cologne Earth is ground in oil varnish, it being very difficult to dry. By calcining this earth it becomes darker and loses its fatty constituents.

Ivory Black dries very easily in nut or poppy-seed oil.

Parisian Blue is ground in poppy-seed or nut oil.

Cinnabar requires some oil varnish, as it does not dry well in poppy-seed oil alone.

Naples Yellow does not dry without oil varnish.

Fine Vienna Lake is ground in oil varnish, as also *Florentine lake*.

Minium is ground in poppy-seed oil.

Ultramarine is ground in oil varnish.

Verona Earth is ground in oil varnish, as also *cobalt blue* and *brown Munich lake*.

WATER COLORS: *Deep Black*. I. Boil 2½ ounces of calcined lampblack in 1 pint of water; take the liquid from the fire, skim it and add ½ ounce of finely pulverized indigo. Let the mixture boil until the greater part of the water is evaporated, stirring constantly, and finally mix it with ¼ ounce of gum-Arabic, ¾ drachm of glue, and ¼ drachm of extract of cichory. Boil the whole to a thick paste and shape this into cakes in moulds oiled with nut oil or oil of almonds.

II. Dissolve horn shavings in caustic potash lye to saturation, evaporate the dark-brown fluid and boil it in an iron boiler to a pasty mass. Now dissolve it in double its weight of water, and compound it with solution of alum. A black precipitate is formed, which is washed, dried, and ground with gum water.

Blue. Boil up, several times, 33 parts of Berlin blue, ground fine in rain-water, to which a few drops of hydro-

chloric acid have been added. When the color has settled, pour off the supernatant fluid, and mix the sediment with 16.5 parts of gum-Arabic and 8.2 of glue with a little water, and let the whole evaporate at a moderate heat to a plastic paste, which is moulded into cakes.

Indigo Blue. Add some white lead to indigo, grind both very fine, and then proceed in the same manner as given for blue.

Green. Grind 8 ounces of verdigris in milk, and let it digest 24 hours in strong wine vinegar, together with 4 ounces of pulverized tartar, and then boil the compound down to one-half its volume. After standing for 24 hours, pour the fluid into a bottle. This is used for mixing, any desired tints being produced by combining it with indigo, sap-green, and saffron.

Red. Grind either Vienna lake, carmine, cinnabar, or minium, in some gum-Arabic and water, and dry the color.

Violet Blue. Crush ripe bilberries and press the juice into a new pot, let it boil, add a small wineglassful of vinegar and ¾ ounce of alum, strain the color and evaporate it to the proper consistency in a porcelain dish.

Yellow. Boil thoroughly a handful of yellow buckthorn berries in 1 pint of water, add some alum and 8 grains of rock salt. Evaporate the whole to ¼ of its volume, then strain through a cloth, compound the filtrate with some gum-Arabic, and let it dry in moulds.

White. Grind Kremnitz white to a fine paste in a strong solution of gum-Arabic, then grind it once more in mucilage, and put the paste in moulds to dry.

Sap Red. Boil Brazil wood 4 times with soft water, collecting each decoction in a wooden tub, and let them stand in it for 4 days. Then draw off the supernatant fluid, put this also in a tub, and add tin-solution free from iron until all the coloring matter is precipitated. Collect the precipitate upon a cloth and, without washing, let it drain off to a stiff paste. Put 3 pounds of this paste in a porcelain dish and, with constant stirring, add 4½ fluid ounces of caustic ammonia until the mass is dis-

solved. Compound the intensely dark-red fluid with $1\frac{1}{2}$ pounds of gum-Arabic and $8\frac{3}{4}$ ounces of white sugar, and sufficient wheat flour to give it the proper consistency.

Painting with Sympathetic Colors differs from other painting only as regards the colors used, which are simply metallic solutions possessing the property to appear only when the picture is subjected to a moderate heat, and disappearing again on cooling.

It is best to choose for this kind of painting a winter landscape, executed in water colors. Buildings, if such are represented in the landscape, are colored with ordinary water colors with the exception of the roofs, which are painted with a sympathetic color mixed from purple-red, yellow, and some blue. All the rest of the scenery is painted with sympathetic colors. The sky is colored blue; mountains, meadows, leaves, etc., with the desired tints of green, etc. To liven up the picture a few flowers may be painted in the foreground. The painting as mentioned must be executed in a warm room. On carrying the colored picture into a cold room the metallic colors disappear gradually; the sky loses its summer blue, the cold wintery sky again taking its place, the mountains, meadows, trees, etc., seem to be covered with snow, and so on. On exposing the picture again to a moderate heat the scene is changed in a moment to a beautiful summer landscape.

Preparation of the Colors used.

Purple Red. Dissolve 1 part of cobaltic oxide in 3 of nitric acid. It is best, in order to promote the reaction of the acid, to do this in a matrass exposed to heat. When the solution is complete, add basic carbonate of potassium as long as a dirty-gray precipitate is formed, and cease immediately on the precipitate assuming a purple-red color. Then dilute the solution with 6 parts of water, filter it, and add some gum.

Rose Red. Dissolve 1 part of cobaltic oxide in 3 of nitric acid, and when the solution is complete evaporate to dryness to expel the acid; then add 1 part of nitrate of potassium and dilute the whole with 8 parts of water. The resulting rose-red color is filtered and mixed with some gum.

Yellow. Dissolve brown cupric oxide in hydrochloric acid, assisting the action of the acid with heat. The solution is olive-green, and by evaporation furnishes grass-green crystals. Dissolve 1 part of these crystals in 8 of water, and add a little gum.

Green. Pulverize 1 part of cobalt, place the powder in a matrass and add 4 parts of aqua regia. Digest the mixture at a moderate heat; then add 1 part of common salt and dilute with 16 parts of water. Filter the fluid, and when it is to be used mix it with a little gum.

Blue. Pulverize 1 part of cobalt, and heat in a matrass with 2 of nitric acid. When the cobalt is dissolved pour the solution into a vessel and gradually add solution of potash until precipitation ceases. Let the mixture stand quietly for some time, then pour off the clear fluid and wash the residue entirely free from acid with water. Let the precipitate drain off, and then dissolve it at a moderate heat in acetic acid, adding the latter in small portions until a saturated fluid is obtained. This solution, mixed with a little gum, is used as a blue color.

Painter's Cream. Painters, who have long intervals between their periods of labor, are accustomed to cover the parts they have painted with a preparation which preserves the freshness of the colors, and which they can remove on resuming work. This preparation is as follows: Clear nut oil 1 gill, pulverized mastic in tears $\frac{1}{2}$ ounce, and pulverized acetate of lead $\frac{1}{4}$ ounce. Dissolve the mastic in oil over a gentle fire, and pour the mixture into a marble mortar over the pulverized acetate of lead; stir it with a wooden pestle, and add water in small quantities until the compound assumes the appearance and consistency of cream, and refuses to admit more water.

PAPER AND PAPER MATERIALS, MANUFACTURE, STAINING, ETC. GLASS, SAND, AND EMERY PAPER.

Preparation of the different kinds of Straw used in the Manufacture of Paper. The straw must be cleansed from all weeds; it is then cut up in

pieces from $\frac{1}{2}$ to $\frac{1}{4}$ inch long, and freed from the hard parts, especially the knots. It is then softened by boiling in water and converted by a machine into half-stuff, which is boiled in lye prepared from potash and lime, and then worked into pulp and finished paper.

The most tender straw used in the manufacture of paper is that of oats, next that of barley, wheat, and finally rye. Maize straw is prepared from the leaves and is even more tender than oats straw. The time for boiling depends on the hardness of the material, as also the strength of the lye, and the preliminary labor which may have been bestowed on the material.

Corn Leaves and Stalks are placed in lye containing, for 100 pounds of material, 40 pounds of lime and 1 pound of potash; the straw remains in the lye for 3 hours.

Oats Straw. For 100 pounds of straw a lye is required containing 50 pounds of lime and 2 pounds of potash. Time: 3 hours.

Barley Straw is first boiled for 3 hours in water and then brought into a lye containing, for every 100 pounds of straw, 50 pounds of lime and 2 pounds of potash. It is then brought into a second lye consisting of 30 to 40 pounds of lime and 1 pound of potash. Time in each lye 3 hours.

Wheat Straw is first boiled for 3 hours in water and then placed consecutively in 3 lyes, remaining in each for 3 hours. The first lye consists of 50 pounds of lime and 2 pounds of potash, and the last two of 30 pounds of lime and 1 pound of potash.

Rye Straw, being very hard, must first be boiled in water for 3 hours, and then successively for the same time in four different lyes of the same strength as those for wheat straw.

Process of Gaining Fibrous Substance from different Plants. The plants are cleaned and cut in small pieces and impregnated with caustic soda-lye of 1° Beaumé, then subjected to hydrostatic pressure. The lye dissolves the silica, coloring matter, pectine, etc., contained in the raw material, and, in consequence of the pressure, penetrates energetically into the pores of the fibres, swelling and bursting the latter. The effect is still further

increased by abating, after the operation is finished, the pressure in the boiler while the lye is drawn off. The material is then worked into half-stuff or converted into a fibre which can be spun.

Transformation of Woolly Fibre. By submitting substances containing wool to a current of steam of 300° F. with a pressure of 5 atmospheres the woolly fibre is so changed that it melts, and in this state collects in the lower part of the boiler, while cotton, linen, and all other vegetable fibres remain unaltered. The latter are now suitable for the manufacture of paper, while the soluble matter, called "ozotine" by the inventor of the process, furnishes a very valuable substance rich in oxygen, which will without doubt be useful for many technical purposes.

Paper for Documents, Checks, etc. To make an alteration in the writing or printing by the use of acid, chloride of lime, or alkali easily perceptible the following ingredients are added to the pulp: 0.75 per cent. of iodide of potassium, 1 per cent. of starch, 2 per cent. of sulphate or carbonate of manganese, and 2 per cent. of sulphate or carbonate of lead. The compound can be applied to the finished paper with a brush.

Improved Cigarette Paper. Tobacco leaves are ground to an impalpable powder which is sifted in a box upon a moistened sheet of cigarette paper. The sheet thus prepared is covered with another sheet, and brought under a press. Other sheets treated in the same manner are placed upon these and the whole finally subjected to strong pressure, whereby the tobacco-powder is intimately united with the moist paper. After remaining in the press for 12 to 24 hours the paper is removed and is ready for use. By a suitable mixture the color, flavor, and smell of the various kinds of tobacco can be successfully imitated. Paper thus prepared burns uniformly, never on one side only, and does not char.

Safety Paper. To prevent erasures and alterations it has for some time been customary in France to color paper pulp with green ultramarine, and to execute the writing with diluted hydrochloric acid or solution of alum, producing white characters upon the

green ground. Some English bankers use paper colored with litmus, upon which are printed ornamental lines with oxalic acid. These lines of course are red, but as soon as an attempt is made to remove the ink with acid the entire ground becomes red. If it is sought to revivify the blue by means of alkalies, the ornamental lines also assume a blue color.

Cork Paper, patented in America by H. Felt & Co., is prepared by coating one side of a thick, soft, and flexible paper with a preparation of 20 parts of glue, 1 of gelatine, and 3 of molasses, and covering it with fine particles of cork lightly rolled on. The material is used for packing glass, bottles, etc.

Wrapping Paper for Silver Ware. The appearance of silver ware is frequently injured by being exposed to air containing sulphuretted hydrogen or sulphurous and other acids. The small quantity of sulphuretted hydrogen contained in illuminating gas and which in burning yields sulphurous acid is frequently sufficient to spoil the appearance of all the articles in a store. To prevent this a prepared paper is recommended. Prepare a solution of 6 parts of caustic soda in water of 20° Beaumé, then add 4 of zinc oxide and let the mixture boil for 2 hours, if possible under a pressure of 5 atmospheres. Dilute the solution, when clear, to 10° Beaumé, and it is ready for impregnating the paper.

Preparation of Parchment Paper. Dilute strong sulphuric acid with $\frac{1}{2}$ its volume of water, and allow it to cool to about 65° F. Then immerse unsized paper in the cold acid for 10 to 50 seconds according to its thickness. When the acid has acted a sufficient length of time, the paper is first well washed in cold running water, then dipped in dilute ammonia, again washed in water, and finally dried. When it is left to itself to dry it becomes shrivelled and has a bad appearance. To guard against this the following process is adopted: An endless strip of paper is passed by machinery first through a vat of the acid and then through water, ammonia, and water again; next a cloth-covered roller deprives it of a portion of the water, and finally it is pressed and smoothed out

by means of polished heated cylinders. When properly manufactured, parchment paper has the same color and translucency as animal parchment. As compared with ordinary parchment this paper possesses the advantage that it is very little liable to be attacked by insects. And again, the characters inscribed on it cannot be effaced without difficulty, and when effaced cannot be replaced by others, a perfect guarantee against all kinds of falsification. By reason of its firmness and durability it is well suited for plans and drawings, especially such as are much exposed to moisture. Further it can be used for covering books; or books, maps, etc., for use in schools, could be printed on it and would be very durable. In place of animal membrane it is well suited for covering jars of fruit, extracts, etc., as also for connecting the parts of distilling and other apparatus. It furnishes an excellent substitute for animal bladder for the casings of sausages. In surgery it is employed instead of linen, oiled cloth, and gutta serena, for dressing wounds.

Water-proof Paper transparent and impervious to grease is obtained by soaking good paper in an aqueous solution of shellac and borax. It resembles parchment paper in some respects. If the aqueous solution be colored with aniline colors very handsome paper, of use for artificial flowers, is prepared.

Peterson's Water-proof Paper. Dissolve $3\frac{1}{2}$ ounces of tallow soap in water, add sufficient solution of alum that the soap is entirely decomposed, and mix this fluid with a gallon of paper-pulp. The paper is in all other respects prepared in the ordinary manner, and need not to be sized. It is especially suitable for cartridge-shells.

Carbolic Acid Paper is prepared with $3\frac{1}{2}$ ounces of carbolic acid to the square foot. It is used for disinfecting purposes, and also for packing fresh meat. The process of preparing it is as follows: Melt at a moderate heat 5 parts of stearine, 6 of paraffine, and 2 of carbolic acid. Apply the melted mixture to the paper with a brush.

A still more effective paper, and which can be used for a great many purposes, is obtained by the use of a smaller quantity of nitric acid in place of carbolic

acid, the rest of the process being the same.

Two New Varieties of Preserving Paper have been recently brought into the market. The one is obtained by immersing soft paper in a bath of salicylic acid, and then drying in the air. The bath is prepared by diluting a strong solution of the acid in alcohol with a large volume of water. This paper may then be used for wrapping up apples, etc.

The other paper used as protection against moths and mildew is best prepared from strong manilla paper by immersing it in the following bath: Seventy parts of tar oil, 5 of crude carbolic acid containing about $\frac{1}{2}$ phenole, 20 of coal-tar at a temperature of 160° F., and 5 of refined petroleum. The paper is then squeezed out, and dried by passing it over hot rollers.

Plastic Pasteboard for Surgical Bandages is prepared by softening the raw pasteboard by beating, or, if very stiff, lixiviating with alkalis, then drying thoroughly, and saturating with a solution of shellac, rosin, and turpentine, or pine rosin, elemi, etc., and, if necessary, coating with gutta-percha or varnish.

Preparation of Tracing Paper, Tracing Linen, and Transparent Packing Paper. The paper is first treated with boiled linseed oil, and the excess of oily particles removed with benzine. The paper is then washed in a chlorine bath. When dry it is again washed with oxygenated water.

Linen is first provided with a coating of starch and then with an application of linseed oil and benzine. It is finished by being smoothed between polished rollers.

Photo-lithographic Transfer Paper, and Transfer-color belonging to it. Paper is treated with a solution of 100 parts of gelatine and 1 of chrome-alum in 2400 of water, and, after drying, with white of egg. It is sensitized in a bath consisting of 1 part of chrome-alum, 14 of water, and 4 of alcohol. The addition of the latter prevents the solution of the white of egg. On the places not exposed to the light the white of egg becomes detached, together with the color with which the exposed paper has been coated. The transfer color

consists of 20 parts of printing ink, 50 of wax, 40 of tallow, 35 of rosin, 210 of oil of turpentine, and 30 of Berlin blue.

Writing, Copying, and Drawing Paper which can be washed. The paper is made transparent by immersion in benzine and then, before the benzine volatilizes, plunged into a solution of siccativ prepared in the following manner: One pound each of lead shavings and oxide of zinc are boiled for 8 hours, together with $8\frac{1}{2}$ ounces of hardened Venetian turpentine in $2\frac{1}{2}$ gallons of purified linseed-oil varnish, and then allowed to stand for a few days to cool and settle. The clear layer is then poured off and to this are added 5 pounds of white West Indian copal and $8\frac{1}{2}$ to 10 ounces of sandarac dissolved in spirit of wine or ether. This paper can be written or drawn upon with pen and ink or water colors; or, by using good copying ink, good copies can be taken from it without a press.

Tracing Paper. By the following very simple process ordinary drawing paper can be rendered transparent, for the purpose of making tracings, and its transparency removed so as to restore its former appearance when the drawing is completed. Dissolve any quantity of castor oil in one, two, or three volumes of absolute alcohol, according to the thickness of the paper, and apply it by means of a sponge. The alcohol evaporates in a few minutes, and the tracing paper is dry and ready for immediate use. The drawing or tracing can be made either with lead-pencil or India ink, and the oil removed from the paper by immersing it in absolute alcohol, thus restoring its original opacity. The alcohol employed in removing the oil is, of course, preserved for diluting the oil used in preparing the next sheet.

Transfer Paper. Mix lard to a paste with lampblack, rub this upon the paper, remove the excess with a rag, and dry the paper. A copy of the writing can be transferred on a clean sheet of paper by placing it underneath the prepared paper and writing upon the latter with a lead-pencil or sharp point.

Tar Paper. Boil 100 pounds of tar for 3 hours, then dissolve in it a quantity of a glue prepared from rosin and

soap, pour 8 gallons of boiling water upon the mixture, stir carefully, and let the mixture boil. Then stir carefully 100 pounds of potato flour into 60 gallons of water in a vat, mix the dissolved tar with 15 gallons of boiling water, and add this to the potato flour in the vat, stirring constantly. Twenty-four parts of this homogeneous fluid are taken to 20 parts of paper-pulp. From the pulp the tar-paper is manufactured, which can be painted black and varnished to make it water-proof. The prepared tar-solution may also be used to impregnate wood, sail-cloth, etc.

To Prepare Leather Waste for use in the Manufacture of Paper. To extract the tannin place the waste for a few hours in a solution of 5 parts of lime, 5 of crystallized soda, and $1\frac{1}{2}$ of sal-ammoniac in 100 of water; then wash first with acidulated and next with pure water. The prepared waste is worked into paper in the ordinary manner, either by itself or mixed with rags.

Iridescent Paper. Boil $4\frac{1}{2}$ ounces of coarsely powdered gall-nuts, $2\frac{1}{2}$ ounces of sulphate of iron, $\frac{1}{2}$ ounce of sulphate of indigo, and 12 grains of gum-Arabic; strain through a cloth, brush the paper with the liquor, and expose it quickly to ammoniacal vapors.

Colored Paper for Tying up Bottles, etc. The dry aniline colors of all shades are used. Dissolve 15 grains of aniline color in 1 ounce of highly rectified alcohol, dilute the solution with 10 ounces of distilled water, and add 23 grains of tannin dissolved in $\frac{1}{2}$ fluid ounce of alcohol. The object of the addition of tannin is to fix the color permanently upon the fibres of the paper, as without it the color on drying could be easily rubbed off. Now take thin white writing-paper, spread it upon a marble or copper plate, and apply the fluid by means of a sponge. Hang the paper over cord to dry, and in a few days varnish it with a concentrated solution of sodium water-glass to 100 parts of which have been added 10 parts of glycerine.

Pouget-Maisonneuve's Electro-chemical Telegraph Paper. Sufficiently sized paper is treated with a solution of 5 parts of ferro-cyanide of potassium and 150 of sal-ammoniac in 100 of

water. Telegrams transmitted by means of this paper and Morse's apparatus have given very satisfactory results.

Amianthus Paper consists of 2 parts of paper pulp and 1 of amianthus. It is especially distinguished from ordinary paper by its color, having a yellowish tint. When burned in a flame it leaves a white residue, which, when not violently shaken, retains the form of the paper, and upon which the writing, provided ink containing sulphate of iron has been used, can be traced and deciphered with some trouble by the yellow marks left behind. Experiments in the manufacture of amianthus paper have been made in America, where large beds of amianthus of fine fibre have been discovered and the price of the material is low.

To Water-proof Cylindeers of Paste-board. The so-called Chinese lacquer is best adapted for this purpose. It consists of a mixture of 4 parts of slaked lime and 3 of fresh blood, to which some alum has been previously added. As soon as the mixture is complete it is applied to the pasteboard with a large soft brush. When the first coating is dry a second is laid on, which suffices to make the pasteboard impermeable to water.

To Produce Enamelled Writing Surfaces on Pasteboard and Paper. A mixture of bleached shellac and borax dissolved in 10 per cent. of water and glue and vine-black rubbed to an impalpable powder is used for the first coloring material. It is transferred to the paper to be coated by means of a felt roller, and distributed with a brush. The paper is then dried and rolled up. After this operation a second color consisting of vine-black, pergamentine (water-glass and glycerine) is used, the paper receiving three coats of this. It is then cut into suitable sizes, steamed at a temperature of 248° F., and finally smoothed by calendering. For white tablets Kremnitz white is used in place of vine-black; for colored, ultramarine, etc.

Imitation of Mother-of-Pearl on Paper. Stout paper with a glossy coating is allowed to float upon a solution of salts of silver, lead, or bismuth. As soon as the paper lies smooth upon the surface of the solution it is slowly

lifted and allowed to dry. The dry paper is then placed in a room impregnated with sulphide of hydrogen, and remains here until the surface has assumed a metallic lustre. Diluted collodion is now poured over the paper thus prepared, or it is drawn through a bath of it, when, after drying, the beautiful iridescent colors will appear upon the paper. The most varying effects can be produced by sprinkling reducing substances or salts upon the surface of the paper before submitting it to the action of the sulphide of hydrogen.

This process is not only adapted for paper but can also be employed for finished articles, as boxes, bonbonnières, etc.

To Make Paper Transparent. Apply

The boiler containing the glue is constructed of copper or iron, and surrounded with a steam-jacket. The small rollers *k* and *n* act as distributors, both being turned by friction with *b*. As soon as the paper reaches the even plane from *b* to *c* the glue upon it is heated by steam emanating from the apparatus *d*, and a fine jet of the material, emery, glass, sand, etc., falls from *e* upon the surface thus heated. The powder penetrates deeply into the soft, sticky mass, and adheres quickly. The excess falls off by the paper turning over *c*, and is collected in a box. The powder in *e* is heated by a steam-pipe. The fan *f* sets the paper in motion, whereby all the powder not adhering tightly is shaken off. A jet of steam striking the surface of the paper through *g* helps to

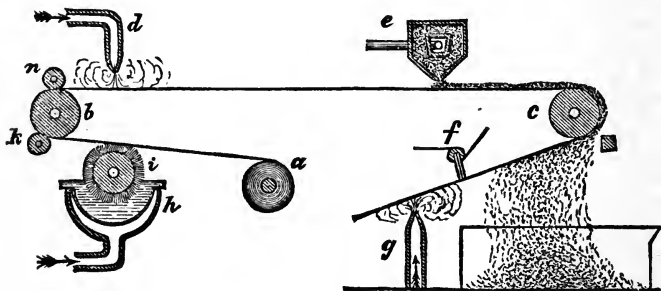

Fig. 39a.

a thin coating of a solution of Canada balsam in turpentine to the paper, then give it a good coating of much thicker varnish on both sides. Perform the work before a hot fire, to keep the paper warm, and a third or even fourth coating until the paper becomes evenly translucent. Paper prepared in this manner comes nearer to perfection than any other.

Emery Paper. The accompanying illustration (Fig. 39a) represents Edwards' patented apparatus used in the manufacture of emery, sand, glass, and similar papers. *a* is the beam on which the endless paper is rolled. In unrolling it passes over the brush-roller *i*, which takes up the glue from the boiler *h* and applies it to the paper.

set the powder more securely in the glue.

Water-proof Emery Paper. The paper is coated on both sides with pulverized emery which is made to adhere to it by means of a water-proof cement, so that moisture can have no injurious effect upon the paper. This flexible water-proof cement is prepared by melting 2 parts of hard, African copal, pouring over this, while yet hot, 3 of boiled linseed oil and adding 1 part of oil-lacquer, 1 of Venetian turpentine, 1 of Venetian red, $\frac{1}{2}$ of Berlin blue, $\frac{1}{2}$ of litharge, and 1 of dissolved caoutchouc. Mix these ingredients intimately, and should the compound be too thick dilute with some linseed-oil varnish. Then spread it uniformly upon paper,

or a suitable cheap fabric, stretched in a frame, and sift finely pulverized emery, or glass, quartz sand, etc., over it; and, when dry, remove the excess of powder. Usually both sides of the paper are covered, one side with coarser and the other with finer powder.

Stains Used in Coloring Paper for Artificial Flowers. Sap-colors are only used and principally those containing much coloring matter. The following colors are calculated for *one ream* of paper.

The gum-Arabic given in the receipt is dissolved in the sap-liquor.

Crimson. Mix 1 gallon of liquor of Brazil wood compounded with borax, 2 ounces of wax-soap, and $8\frac{3}{4}$ ounces of gum-Arabic.

Dark Blue. I. Mix 1 gallon of tincture of Berlin blue and 2 ounces each of wax-soap and gum tragacanth.

II. Mix $\frac{3}{4}$ gallons of tincture of Berlin blue with 2 ounces of wax-soap and $4\frac{1}{2}$ ounces of gum tragacanth.

Dark Green. I. Take $\frac{1}{2}$ gallon of liquor of sap-green (boiled down juice of the berries of *Rhamnus catharticus*), $4\frac{1}{2}$ ounces of indigo rubbed fine, 1 ounce of wax-soap, and $4\frac{1}{2}$ ounces of gum-Arabic.

II. One-half gallon of liquor of sap-green, $4\frac{1}{2}$ ounces of distilled verdigris, 1 ounce of wax-soap, and $4\frac{1}{2}$ ounces of gum-Arabic.

Dark Red. Compound 1 gallon of liquor of Brazil wood with 2 ounces of wax-soap and $8\frac{3}{4}$ ounces of gum-Arabic.

Golden Yellow. Mix $6\frac{1}{2}$ pounds of gamboge with 2 ounces of wax-soap.

Lemon Color. I. Compound 1 gallon of juice of Persian berries with 2 ounces of wax-soap and $8\frac{3}{4}$ ounces of gum-Arabic.

II. Add to 1 gallon of liquor of quercitron compounded with solution of tin 2 ounces of wax-soap and $8\frac{3}{4}$ ounces of gum-Arabic.

Pale Yellow. Mix 1 gallon of liquor of fustic, 2 ounces of wax-soap, and $8\frac{3}{4}$ ounces of gum-Arabic.

Rose Color. Mix 1 gallon of liquor of cochineal with 2 ounces of wax-soap and $8\frac{3}{4}$ ounces of gum-Arabic.

Scarlet. I. Mix 1 gallon of liquor of Brazil wood compounded with alum,

and a solution of copper with 2 ounces of wax-soap and $8\frac{3}{4}$ ounces of gum-Arabic.

II. Mix 1 gallon of liquor of cochineal compounded with citrate of tin with 2 ounces of wax-soap and $3\frac{1}{2}$ ounces of gum-Arabic.

Yellow-green. I. Compound 1 gallon of liquor of sap-green with 2 ounces each of distilled verdigris and wax-soap and $8\frac{3}{4}$ ounces of gum-Arabic.

II. Take 1 gallon of liquor of sap-green, 2 ounces each of dissolved indigo and wax-soap, and $8\frac{3}{4}$ ounces of gum-Arabic.

Stain for Glazed Papers. On account of the cheapness of these papers a solution of glue is used as an agglutinant. The following proportions are generally used for *one ream* of paper: One pound of glue and $1\frac{1}{4}$ gallons of water.

Black. I. Dissolve 1 pound of glue in $1\frac{1}{4}$ gallons of water; triturate with this 1 pound of lampblack previously rubbed up in rye whiskey, $2\frac{3}{4}$ pounds of Frankford black, 2 ounces of Paris blue, 1 ounce of wax-soap, and add $1\frac{1}{2}$ pounds of liquor of logwood.

II. Take $\frac{1}{2}$ gallon of liquor of logwood compounded with sulphate of iron, 1 ounce of wax-soap, and $4\frac{1}{2}$ ounces of gum-Arabic.

Blue (Azure). Dissolve 1 pound of glue in $1\frac{1}{4}$ gallons of water, and compound the solution with $1\frac{1}{2}$ pounds of Berlin blue, $2\frac{3}{4}$ pounds of pulverized chalk, $2\frac{1}{2}$ ounces of light mineral blue, and 2 ounces of wax-soap.

Blue (Dark). I. Dissolve 1 pound of glue in $1\frac{1}{4}$ gallons of water, and mix with it $4\frac{1}{2}$ pounds of pulverized chalk, $4\frac{1}{2}$ ounces of Paris blue, and 2 ounces of wax-soap.

II. Mix $\frac{1}{2}$ gallon of tincture of Berlin blue and 1 ounce of wax-soap with $2\frac{1}{2}$ ounces of dissolved gum tragacanth.

Blue (Pale). I. Mix $\frac{1}{2}$ gallon of tincture of Berlin blue and 1 ounce of wax-soap with $3\frac{1}{2}$ ounces of dissolved gum tragacanth.

II. Dissolve 1 pound of glue in $1\frac{1}{4}$ gallons of water, and mix with it 4 pounds of pulverized chalk and 2 ounces each of Parisian blue and wax-soap.

Brown (Dark). I. Dissolve 1 pound of glue in $1\frac{1}{4}$ gallons of water, and mix

with it 1 pound of colcothar, a like quantity of English pink, $1\frac{1}{2}$ pounds of pulverized chalk, and 2 ounces of wax-soap.

II. Dissolve 1 ounce of wax-soap and $4\frac{1}{2}$ ounces of gum-Arabic in $\frac{1}{2}$ gallon of good liquor of Brazil wood and a like quantity of tincture of gall-nuts.

Cherry Red. Dissolve 1 pound of glue in $1\frac{1}{2}$ gallons of water, and mix with it $8\frac{1}{2}$ pounds of Turkish minium previously rubbed up with $\frac{1}{2}$ gallon of liquor of Brazil wood and 2 ounces of wax-soap.

Green (Copper). Dissolve 1 pound of glue in $1\frac{1}{2}$ gallons of water, and triturate with it 4 pounds of English green, $1\frac{1}{2}$ pounds of pulverized chalk, and 4 ounces of wax-soap.

Green (Pale). Dissolve 1 pound of glue in $1\frac{1}{2}$ gallons of water, and mix with it 1 pound of Bremen blue, $8\frac{1}{2}$ ounces of whiting, 1 ounce of light chrome-yellow, and 2 ounces of wax-soap.

Lemon Color. Dissolve 1 pound of glue in $1\frac{1}{2}$ gallons of water, and mix with it 13 ounces of light chrome-yellow, 2 pounds of pulverized chalk, and 2 ounces of wax-soap.

Orange-yellow. Dissolve 1 pound of glue in $1\frac{1}{2}$ gallons of water, and mix with it 2 pounds of light chrome-yellow, 1 pound of Turkish minium, 2 pounds of white lead, and 2 ounces of wax-soap.

Red (Dark). Mix $\frac{3}{4}$ gallons of liquor of Brazil wood with 1 ounce of wax-soap and $4\frac{1}{2}$ ounces of gum-Arabic.

Red (Pale). Dissolve 1 pound of glue in $1\frac{1}{2}$ gallons of water, and mix with it $8\frac{3}{4}$ pounds of Turkish minium previously rubbed up with 2 ounces of wax-soap.

Rose Color. Dissolve 1 pound of glue in $1\frac{1}{2}$ gallons of liquor of Brazil wood and mix with it 50 pounds of rose madder previously rubbed up with 2 ounces of wax-soap.

Violet. Mix $4\frac{1}{2}$ ounces of gum-Arabic and 1 ounce of wax-soap with $\frac{1}{2}$ gallon of good liquor of logwood. After the gum has dissolved in the liquor compound it with some potash.

Stains for Morocco Papers. Black. Dissolve $8\frac{3}{4}$ ounces of good parchment shavings in $1\frac{1}{2}$ gallons of water and stir in 1 pound of lampblack, 30 pounds of

Frankfort black, and $1\frac{1}{2}$ ounces of fine Paris blue.

Blue (Dark). Dissolve $8\frac{3}{4}$ ounces of good parchment shavings in $1\frac{1}{2}$ gallons of water, and mix with the solution $8\frac{1}{2}$ pounds of white lead and $4\frac{1}{2}$ ounces of fine Paris blue.

Blue (Light). Dissolve $8\frac{3}{4}$ ounces of parchment shavings in $1\frac{1}{2}$ gallons of water, and mix with it $8\frac{3}{4}$ pounds of white lead and $2\frac{1}{4}$ ounces of fine Paris blue.

Green (Dark). Dissolve 13 ounces of parchment shavings in $2\frac{1}{2}$ gallons of water, and mix with 10 pounds of Schweinfurth green.

Green (Pale). Dissolve 13 ounces of parchment shavings in $2\frac{1}{2}$ gallons of water, and mix with $8\frac{3}{4}$ pounds of Schweinfurth green and 1 pound of fine Paris blue.

Orange-yellow. Dissolve $8\frac{3}{4}$ ounces of parchment shavings in $1\frac{1}{2}$ gallons of water, and mix with $1\frac{1}{2}$ pounds of light chrome-yellow, $8\frac{3}{4}$ ounces of orange chrome-yellow, and 1 pound of white lead.

Pale Yellow. Dissolve $8\frac{3}{4}$ ounces of parchment shavings in $1\frac{1}{2}$ gallons of water, and mix with 2 pounds of light chrome-yellow and $8\frac{3}{4}$ ounces of white lead.

Red (Dark). Dissolve $8\frac{3}{4}$ ounces of parchment shavings in $1\frac{1}{2}$ gallons of water, and compound this with $7\frac{3}{4}$ pounds of fine cinnabar and 1 pound of Turkish minium.

Red (Pale). Dissolve $8\frac{3}{4}$ ounces of parchment shavings in $1\frac{1}{2}$ gallons of water, and mix it with $8\frac{3}{4}$ pounds of Turkish minium.

Violet (Dark). Dissolve $8\frac{3}{4}$ ounces of parchment shavings in $1\frac{1}{2}$ gallons of water, and mix with $3\frac{3}{4}$ pounds of white lead, 1 pound of pale mineral blue, and $8\frac{3}{4}$ ounces of scarlet lake.

Violet (Light). Dissolve $8\frac{3}{4}$ ounces of parchment shavings in $1\frac{1}{2}$ gallons of water, and mix with $4\frac{1}{2}$ pounds of white lead, 13 ounces of light mineral blue, and $8\frac{3}{4}$ ounces of scarlet lake.

Stains for Satin Papers. Azure Blue. Dissolve 13 ounces of parchment shavings in $2\frac{1}{2}$ gallons of water, and mix with 3 pounds of Bremen blue, $1\frac{1}{2}$ pounds of English mineral blue, and $4\frac{1}{2}$ ounces of wax-soap.

Blue (Light). Dissolve $8\frac{3}{4}$ ounces of

parchment shavings in $1\frac{1}{2}$ gallons of water, and mix with 1 pound of light mineral blue and $3\frac{1}{2}$ ounces of wax-soap.

Brown (Light). Dissolve $8\frac{3}{4}$ ounces of parchment shavings in $1\frac{1}{2}$ gallons of water, and mix with 13 ounces of light chrome-yellow, $6\frac{1}{2}$ ounces of colcothar, 2 ounces of Frankfort black, 3 pounds of pulverized chalk, and $3\frac{1}{2}$ ounces of wax-soap.

Brown (Reddish). Dissolve $8\frac{3}{4}$ ounces of parchment shavings in $1\frac{1}{2}$ gallons of water, and mix with 1 pound of yellow ochre, $4\frac{1}{4}$ ounces of light chrome-yellow, 1 pound of white lead, 1 ounce of red ochre, and $3\frac{1}{2}$ ounces of wax-soap.

Gray (Light). Dissolve $8\frac{3}{4}$ ounces of parchment shavings in $1\frac{1}{2}$ gallons of water, and mix with $4\frac{1}{4}$ pounds of pulverized chalk, $8\frac{3}{4}$ ounces of Frankfort black, 1 ounce of Paris blue, and $3\frac{1}{2}$ ounces of wax-soap.

Gray (Bluish). Dissolve $8\frac{3}{4}$ ounces of parchment shavings in $1\frac{1}{2}$ gallons of water, and mix with $4\frac{1}{4}$ pounds of pulverized chalk, 1 pound of light mineral blue, $4\frac{1}{4}$ ounces of English green, $1\frac{3}{4}$ ounces of Frankfort black, and $3\frac{1}{2}$ ounces of wax-soap.

Green (Light). Dissolve $8\frac{3}{4}$ ounces of parchment shavings in $1\frac{1}{2}$ gallons of water, and mix with $2\frac{3}{4}$ pounds of English green a like quantity of pulverized chalk and $3\frac{1}{2}$ ounces of wax-soap.

Green (Brownish). Dissolve $8\frac{3}{4}$ ounces of parchment shavings in $1\frac{1}{2}$ gallons of water, and mix with 1 pound of Schweinfurth green, $8\frac{3}{4}$ ounces of mineral green, $4\frac{1}{4}$ ounces each of burnt umber and English pink, 1 pound of whiting, and $3\frac{1}{2}$ ounces of wax-soap.

Lemon Color. Dissolve $8\frac{3}{4}$ ounces of parchment shavings in $1\frac{1}{2}$ gallons of water, and mix with $1\frac{1}{2}$ pounds of light chrome-yellow, 1 pound of white lead, and $3\frac{1}{2}$ ounces of wax-soap.

Orange-yellow. Dissolve $8\frac{3}{4}$ ounces of parchment shavings in $1\frac{1}{2}$ gallons of water, and mix with $1\frac{1}{2}$ pounds of light chrome-yellow, $8\frac{3}{4}$ ounces of orange chrome-yellow, 1 pound of white lead, and $3\frac{1}{2}$ ounces of wax-soap.

Pale Yellow. Dissolve $8\frac{3}{4}$ ounces of parchment shavings in $1\frac{1}{2}$ gallons of water, and mix with $4\frac{1}{4}$ pounds of light

chrome-yellow, 1 pound of pulverized chalk, and $3\frac{1}{2}$ ounces of wax-soap.

Orange-yellow. Dissolve $8\frac{3}{4}$ ounces of parchment shavings in $1\frac{1}{2}$ gallons of water, and mix with $4\frac{1}{4}$ pounds of light chrome-yellow, $8\frac{3}{4}$ ounces of Turkish minium, 1 pound of white lead, and $3\frac{1}{2}$ ounces of wax-soap.

Rose Color. Dissolve $8\frac{3}{4}$ ounces of parchment shavings in $1\frac{1}{2}$ gallons of water, and mix with $\frac{3}{4}$ gallon of rose color prepared from liquor of Brazil wood and chalk, and $6\frac{1}{2}$ pounds of wax-soap.

Violet (Light). Dissolve $8\frac{3}{4}$ ounces of parchment shavings in $1\frac{1}{2}$ gallons of water, and mix with $1\frac{1}{2}$ pounds of light mineral blue, a like quantity of scarlet lake, 1 pound of white lead, and $3\frac{1}{2}$ ounces of wax-soap.

White. Dissolve $8\frac{3}{4}$ ounces of parchment shavings in $1\frac{1}{2}$ gallons of water, and mix with $8\frac{3}{4}$ pounds of fine Kremnitz white, $4\frac{1}{4}$ ounces of fine Bremen blue, and $3\frac{1}{2}$ ounces of wax-soap.

Silver White. Dissolve $8\frac{3}{4}$ ounces of parchment shavings in $1\frac{1}{2}$ gallons of water, and mix with $8\frac{3}{4}$ pounds of Kremnitz white, $8\frac{3}{4}$ ounces of Frankfort black, and $3\frac{1}{2}$ ounces of wax-soap.

How to Split a Sheet of Paper. To split paper into two or three even parts proceed as follows: Paste a piece of cloth or strong paper to each side of the sheet to be split. When dry quickly pull the two pieces asunder, when one part of the sheet will be found to have adhered to one and part to the other. Soften the paste in water, and the pieces can be easily removed from the cloth. The process can be utilized in various ways. If it be desired to paste in a scrap-book a newspaper article printed on both sides of the paper and we possess only one copy it is very convenient to know how to detach the one side from the other. The paper when split, as may be imagined, is more transparent than before being subjected to the operation, and the printing-ink is somewhat duller; otherwise the two pieces present the appearance of the original if again brought together.

To separate the paper sheet into two films as above described will require some little practice, but with a little patience the experimenter will soon acquire the necessary dexterity.

PERFUMERY. AROMATIC VINEGARS, COSMETICS, EXTRACTS, HAIR OILS, POMADES, POWDERS, WASHES, FUMIGATING ARTICLES, ETC.

Extraction of Perfume from Flowers.

Remove the unpleasant odor from methyl chloride by treating it in a gaseous state with sulphuric acid. The apparatus for extracting the flowers consists of a digesting vessel, a holder for the purified methyl chloride, a hermetically closed receiver, and an air-pump. Place the flowers in the digesting vessel and submit them for 2 minutes to the action of the liquid methyl chloride which is then run into the receiver. Repeat this operation frequently, each time with fresh methyl chloride. Finally the methyl chloride absorbed by the blossoms in the digesting vessel is removed by rarefying the air, and conveyed to the condensing apparatus. The last traces of it may be gained by the introduction of a jet of steam. The methyl chloride collected in the receiver, which is placed on a water-bath heated to about 86° F., is volatilized by rarefying the air to $\frac{1}{2}$ atmosphere, the perfuming substances mixed with fatty and wax-like matters remaining behind. By treating them with cold alcohol the perfume is obtained in a perfectly pure state.

Manufacture of Perfumery. Pure alcohol free from fusel oil and other substances of a disagreeable odor is one of the principal requisites for the manufacture of good perfumery. It is also of the utmost importance that the ethereal oils used should be perfectly pure and of the best quality.

Eau des Alpes. Two thousand parts of alcohol, 38 parts each of oil of orange blossoms, cedrat oil, and oil of bergamot, 15 parts each of oil of lemon and Portugal oil, 8 parts of oil of wormwood, and 4 parts of oil of cloves.

Eau de Cologne. Six hundred and fifty parts of 96 per cent. alcohol, 50 parts each of orange water and rose water, 200 parts of neroli, 400 parts of oil of lavender, 200 parts of oil of bergamot, 900 parts of "petit-grain" oil, 250 parts of oil of rosemary, and 50 parts of myrtle oil.

Otto's Eau de Cologne. Mix the following ingredients with 400 parts of

alcohol of 86 per cent. Tralles: Four parts of oil of lemon, 3 of oil of bergamot, $\frac{3}{4}$ of lavender oil, $\frac{1}{2}$ of rosemary oil, 1 of spirit of sal-ammoniac.

Thillaye's Eau de Cologne. Dissolve the following oils in 2000 parts of strong alcohol: 60 part each of bergamot and lemon, 12 parts of cedrat, and 3 parts of rosemary.

Wagner's Eau de Cologne. Place the following ingredients in a glass matrass: Four parts each of chopped leaves of common balm, peppermint, and basil, 6 of bruised angelica root, 1 of bruised coriander seed, and $1\frac{1}{2}$ of bruised cloves. Pour 300 parts of alcohol and 100 of water over them, let the whole digest for 48 hours, and then distil off 300 parts. Then pour 100 parts of 40 per cent. alcohol over $2\frac{1}{2}$ of neroli, $\frac{1}{4}$ of orange oil, 2 of oil of bergamot, $\frac{1}{2}$ of oil of peppermint, 2 of tolu balsam, and $\frac{3}{4}$ of essence of ambergris, and allow the mixture to stand quietly for 24 hours. Then pour the supernatant liquid off, mix it with the first, let the whole stand again for a few hours, filter through animal charcoal, and finally distil it.

Eau de Lavande Ambra. Four hundred parts of alcohol, 100 parts of oil of cloves, 200 parts of oil of bergamot, 600 parts of oil of lavender, 100 parts of Portugal oil, 300 parts of tincture of violets, 25 parts each of tincture of benzoine and tincture of storax, 50 parts of tincture of musk, 25 parts of tincture of ambergris, 100 parts of water, and 100 parts of sugar-color.

Eau de Paris. Eight thousand parts of 85 per cent. alcohol, 62 parts each of oil of lemons, oil of bergamot, and Portugal oil, 15 parts of neroli, and 8 parts of oil of rosemary.

Empress Eugenie's Nosegay. One part each of extracts of musk, vanilla, tonka beans, and neroli, and 2 parts each of extracts of rose geranium and sandal wood and triple essence of roses.

Esprit de Patchouli. Mix 1 part of elixir of musk and 1 part of patchouli oil with 300 parts of cologne water, and distil in a steam-bath.

Esprit de Rose triple. Mix 100 parts of rose oil with 4000 parts of rectified spirit of wine, and distil.

Esprit de Toilette Française. Dis-

solve in a suitable flask 1½ parts each of the following oils: lemon, thyme, lavender, and bergamot, and ½ part of oil of cinnamon in 500 parts of rectified spirit of wine.

Ess. Bouquet. Four ounces of extract of musk, 2 ounces of extract of tuberose, 1 drachm of rose oil, 1½ drachms of oil of bergamot, ½ drachm of neroli, 8 minims of oil of verberna, 10 minims of oil of allspice, 3 minims of oil of patchouli, 10 minims of oil of lavender, ½ drachm of oil of cedar, and 3 to 4 pints of alcohol.

Extrait Violet.

Extract of cassia	300 parts.
“ “ rose	200 “
“ “ jasmine	50 “
“ “ tuberose	56 “
Tincture of iris	100 “
“ “ musk	200 “
Oil of bergamot	5 “

Extract of Iris. Seven pounds of iris root of good quality and ground fine are treated by percolation with pure alcohol until 1 gallon of extract is obtained.

Jockey Club Extract.

Extract of jasmine	5 ounces.
“ “ violet	20 “
“ “ musk	7 “
“ “ vanilla	1½ “
Rose oil	1½ “
Sandal oil	1½ drachms.
Orange blossom oil	40 minims.
Benzoic acid	2 drachms.
Alcohol	2 to 4 pints.

Heliotrope Extract.

Vanilla	1¼ drachms.
Orange blossom oil	10 drops.
Cherry-laurel oil	5 “
Musk	¾ grain.
Benzoine	6 drachms.
Rectified alcohol	1 pint.

Millefleur Extract.

Oil of rose	1 drachm.
“ “ cedar	1 “
“ “ oranges	1 “
“ “ allspice	20 minims.
Extract of iris	6 ounces.
“ “ jasmine	2 “
“ “ styrax	1 ounce.
“ “ tonka	4 ounces.
Alcohol	2 to 4 pints.

Moss-Rose Extract.

Rose oil	2 drachms.
Sandal oil	2 “
Extract of musk	12 ounces.
“ “ vanilla	4 “
“ “ iris	2 “
“ “ jasmintie	4 “
Benzoic acid	1 drachm.
Alcohol	1 to 4 pints.

Musk Extract. Two drachms of the finest musk in grains are rubbed up with a solution of ½ ounce of carbonate of potassium in 4 ounces of alcohol, until the musk is thoroughly soaked and has the consistency of cream. A sufficient quantity of alcohol is added so that the whole will amount to a pint, and this allowed to settle. The liquid is then poured off, and the coarser particles of the settled musk are again rubbed up in the same manner. This process is repeated until all the musk is finely divided, when the whole is allowed to stand for 14 days, and 3 pints of extract are drawn off.

New Garden Nosegay. Mix 50 parts of neroli extract, 25 parts each of the extracts of acacia, tuberose, jasmine, and rose geranium with 10 parts each of essence of musk and essence of ambergris.

New-mown Hay.

Extract of tonka bean	25 ounces.
“ “ musk	6 “
“ “ iris	8 “
“ “ vanilla	1 ounce.
“ “ styrax	1 “
Oil of bergamot	1 “
Neroli	15 minims.
Oil of rose	10 “
“ “ patchouli	10 “
“ “ cloves	6 “
“ “ sandal wood	1 drachm.
Benzoic acid	1½ “
Alcohol	1 to 4 pints.

Styrax Extract. Dissolve 8 drachms of styrax in 1 pint of alcohol.

Tonka Bean Extract. Convert 1 pound of tonka beans into a coarse powder, and pour sufficient alcohol over it to give 1 gallon of extract.

Vanilla Extract. Rub 4 ounces of finest vanilla beans to a powder together with 4 to 6 ounces of loaf sugar, and extract with alcohol by percolation until 7 gallons of extract have been obtained.

Victoria Extract.

Oil of rose	2 drachms.
" " neroli	2 "
" " bergamot	4 "
" " coriander	16 minims.
" " lavender	16 "
" " allspice	24 "
Extract of jasmine	2 ounces.
" " musk	2 "
" " iris	16 "
Benzoic acid	2 "
Alcohol	1 to 4 pints.

West End Bouquet. Mix in a glass flask: Fifty parts each of extracts of acacia, violet, and tuberose, 25 parts of extract of jasmine, 150 parts of triple essence of rose, 25 parts of essence of musk, a like quantity of essence of ambergris, and 6½ parts of oil of bergamot.

White Rose Bouquet. Oil of rose 2 drachms, cedar oil 6 minims, patchouli oil 4 minims, orange oil ½ drachm, extracts of tuberose, iris, jasmine, and musk each 2 ounces, benzoic acid 1 drachm, and alcohol 1 to 4 pints diluted with 4 ounces of rose water.

Ylang Ylang.

Oil of ylang-ylang	2 drachms.
" " rose	1 drachm.
" " neroli	½ "
Extract of vanilla	2 ounces.
Tincture of tolu	8 "
Alcohol	1 gallon.
Rose water	1 pint.

Allow the mixture to stand for several days, and then filter through carbonate of magnesium.

Ambergris Vinegar. White vinegar 800 parts, ambergris $\frac{1}{16}$ part, and musk $\frac{1}{8}$ part. Rub the ingredients fine in a mortar before adding them to the vinegar. Then moisten the powder with some of the vinegar, and with the remainder rinse out the mortar, put all into a flask, allow it to digest for 5 or 6 days, and then draw off 500 parts, or, at the utmost, 600 parts.

Aromatic Vinegar. Pour 300 parts of vinegar over 6 parts each of chopped-up leaves of rosemary, garden sage, peppermint, bruised cloves, bruised zedoary root, and pulverized angelica root. Macerate for 4 days in a closed vessel, then press and filter.

Clove Vinegar. Digest in 800 parts of vinegar for 3 days: Eighteen parts of

bruised cloves, 6 parts each of grated nutmegs and cinnamon, 9 parts of ear-nation pink blossoms, 3 parts each of mace, cinnamon blossoms, and orange blossoms; then press out and filter.

Jasmine Vinegar. Pour 800 parts of white-wine vinegar over 50 parts of jasmine blossoms, and 9 parts each of bergamot and orange rind cut up. Let the mixture digest for 3 days, then draw off and filter the vinegar.

Lavender Vinegar. Pour 800 parts of white-wine vinegar over 100 parts of lavender blossoms, 9 parts each of chopped leaves of rosemary, gentian, and marjoram, 4½ parts of thyme leaves cut up, and 3 parts each of bruised angelica root and violet root. Let the mixture digest for 3 days, draw off the liquid, strain the residue, add the liquid obtained to the first, and filter the whole through blotting paper.

Musk Vinegar. Digest for 3 days in 800 parts of white-wine vinegar: Twenty parts of blossoms of the yellow, sweet sultan flower, 3 parts of chopped rosemary leaves, and 6 parts each of bruised anise seed, bruised caraway seed, chopped angelica root, and bruised cardamons; press out, strain, and add 3 parts of musk. Let the whole stand for 36 hours and filter through blotting paper. The musk remaining upon the filter can be used several times in preparing this vinegar.

Orange Blossom Vinegar. Pour 500 parts of white-wine vinegar over 16 parts of orange blossoms, 6 of jasmine blossoms, 6 of jonquill, 6 of mignonette, 3 of heliotrope blossoms, 3 of cassia blossoms, and 2 of ground caliatour-wood. Digest for 3 days, strain and filter.

Rose Vinegar. Digest in 3 parts of pure white vinegar 1 part of red roses and 1 of white. Let the whole stand for 6 days, then press out, strain and filter.

Toilette Vinegar. This toilette article, much in demand in *Paris*, is composed as follows: Three hundred parts of acetic acid of 6°, 1000 parts of 80 per cent. alcohol, 20 parts each of tincture of tolu and tincture of benzoin, 4 parts each of the oils of lemon, bergamot, Portugal and cedar; 2 parts of oil of limes, 1 part of neroli, 5½ parts

of lavender oil, $\frac{2}{3}$ part of oil of rosemary, and $\frac{1}{15}$ part of musk.

To give the preparation an agreeable color add from $1\frac{1}{2}$ to 3 parts of tincture of ratany.

Vanilla Vinegar. Digest for 4 days in 500 parts of red Burgundy vinegar: Four parts of grated vanilla beans, 8 of pulverized cinnamon, and 2 of pulverized cloves; then press out, strain and filter.

Vinaigre de Beauté. Digest in a flask for 3 days in 500 parts of red Burgundy vinegar: Thirty parts of rose leaves, 16 of daffodil blossoms, 8 of jasmine blossoms, 3 of jonquils, and 2 each of marjoram and common balm leaves cut up; press out and strain the fluid.

Vinaigre des Dames. Digest for 3 days with frequent shaking: Three hundred parts of red wine vinegar, 50 parts of rose leaves, 18 parts each of blossoms of jasmine and carnation pinks, 9 parts each of ground rosewood and sandal wood, and 3 parts each of quassia wood and sassafras wood cut up in pieces; then press out the liquid, strain through a cloth and finally filter through blotting paper.

Vinaigre Aromatique de J. V. Bully. This toilet article is much in demand. It is composed of 30 parts each of oil of bergamot and oil of lemon rind, 12 parts of Portugal oil, 25 parts of oil of rosemary, 4 parts each of lavender oil and neroli, 50 parts of spirit of balm, and 1000 parts of alcohol. Let the mixture stand for 24 hours, shaking it frequently, and then add 60 parts each of tinctures of benzoin, tolu, and storax, and 100 parts of spirit of carnation pinks. Shake again, and after 24 hours add 2000 parts of distilled vinegar, and finally after letting it stand for 12 hours compound the mixture with 90 parts of radical vinegar.

Vinaigre d'Hébé (to Remove Freckles). Six thousand five hundred parts of vinegar, 1350 of lemons cut up in small pieces, 850 of alcohol of 85° Tralles, 225 of oil of lavender, 5 of rose oil, 60 of cedar oil, and 850 of water. Let the mixture stand for 3 days exposed to the sun, and then filter.

Apply the fluid to the skin by means of a sponge before retiring at night and let it dry. Wash the next morning with cold water.

Cucumber Essence is much used in cosmetics intended for beautifying the complexion. To prevent the juice from spoiling or becoming rancid when mixed with fat, mix the fresh juice with an equal volume of 90 per cent. alcohol, and distil off the latter. If not sufficiently perfumed add fresh juice and distil.

Cucumber Milk is prepared by making an emulsion from 8 parts of sweet almonds, 20 parts of fresh cucumber juice previously boiled, and $\frac{1}{2}$ of Castile soap dissolved in 6 of cucumber essence, and finally adding $\frac{1}{10}$ of tincture of benzoin.

Lily Essence. Mix 250 parts of extract of tuberose, 33 parts of extract of jasmine, 66 $\frac{1}{2}$ parts of extract of orange blossoms, 100 parts of vanilla extract, 125 parts each of the extracts of acacia and rose, and a trace of ethereal oil of bitter almonds. The mixture must at least stand for 1 month before it is fit for sale.

Narval Bouquet. Two hundred and fifty parts each of rose essence, extract of sandal wood, patchouli essence, and verberna essence.

Moss-rose Essence. One thousand parts of alcoholic extract of French rose-pomade, 500 parts of triple spirit of rose, 500 parts of alcoholic extract of orange blossom pomade, 250 parts of extract of ambergris, and 125 parts of extract of musk.

The extract from pomades is obtained in the following manner: Five hundred parts of pomade are cut up in small pieces and placed in a capacious flask, together with 575 parts of alcohol. The flask is then hermetically closed and placed in a water-bath until the pomade is melted, when it is converted into a fine-grained mass by shaking. The mixture is allowed to stand for a few days, being occasionally shaken, and the supernatant fluid is then drawn off. By repeating this operation 2 or 3 times a weaker extract is obtained suitable for cheap perfumeries.

Odeur Fin National. Put $\frac{1}{2}$ grain of musk into a flask, pour 6 fluid ounces of 85 to 90 per cent. alcohol over it, close the flask, shake it several times, and let it stand for 24 hours; then add 5 drops of rose oil, 50 grains each of the oils of bergamot and cloves, 1 fluid

drachm of cedar oil, and $\frac{1}{2}$ fluid drachm of oil of lavender. Shake the mixture thoroughly and let it stand for 3 days, frequently agitating it. Pour off the clear liquid or filter it through unsized paper.

A few drops of this mixture imparts an agreeable and lasting perfume to a handkerchief.

Tea-rose Essence. Alcoholic extract of French rose pomade, triple spirit of rose, and extract of rose geranium of each 50 parts, extract of sandal wood 25 parts, extract of neroli and extract of orris root of each $12\frac{1}{2}$ parts.

Violette de Bois. Essence of violets 500 parts, essence of acacia, essence of rose pomade, and extract of iris root of each 100 parts, and oil of bitter almonds a trace.

White Rose Essence. Alcoholic extract of French rose pomade, triple spirit of roses, and spirit of violets of each 100 parts, extract of jasmine 50 parts, extract of patchouli 25 parts.

HAIR OILS. *Flower Oil.* Sesame oil 400 parts, geranium oil 400 parts, oils of lavender and bergamot of each 100 parts, "petit-grain oil" 50 parts, and angelica oil a trace.

Good and Cheap Hair Oil. By reason of competition in trade the price of hair oil has been so much reduced that in place of good olive oil cheaper oils, as sesame oil, refined cotton-seed oil, etc., belonging to the half-drying oils, are perfumed, colored, and sold as good hair oil.

Rape-seed oil is a good fat oil and, when freshly pressed and chemically pure, gives a much better and much cheaper oil to the manufacturer than the above oils, and may be still further improved by compounding it with 10 per cent. of castor oil.

Rape-seed oil is refined as follows: Pour 10,000 parts of crude rape-seed oil, freshly pressed, into a capacious flask, and add 4 parts of camphor and 40 parts of oil of cloves previously dissolved in 200 parts of strong alcohol. Mix by shaking the flask vigorously, and then add 900 parts of solution of permanganate of potassium obtained by dissolving 50 parts of the permanganate in 1000 of water. The whole is then thoroughly mixed and placed aside for a few days until the brown color of the

mixture has disappeared. Now add 600 parts of diluted hydrochloric acid containing 12.5 per cent. of the acid. The mixture is allowed to stand, being frequently shaken, until the oil floats nearly clear upon the aqueous fluid, when it is poured off and filtered through paper. During all the operation the flask must be kept closed.

A good hair oil is now prepared as follows: Color 500 parts of refined rape-seed oil red with alkanet, add 50 parts of castor oil, and perfume with 4 parts of oil of bergamot, 2 parts of oil of balm, and 1 part of essence of mirbane (nitro-benzole).

II. Mix 90 parts of fresh olive oil with 3 of sweet-scented oil, and, if desired, color red with alkanet.

Another Receipt. Bruise 250 parts of fresh southernwood (*Artemisia abrotanum*), pour 750 parts of olive oil and 250 parts of white wine over it, boil the whole, and press out the liquid through a linen cloth. Repeat this 3 times, but every time with fresh southernwood, and add, during the last operation, 60 parts of bear's grease. This oil is claimed to be excellent for producing new hair upon bald heads.

Hamilton's Hair Oil. Pour 500 parts of fine olive oil into a glass, and add $8\frac{1}{2}$ parts of alkanet. When the fluid has assumed a fine dark red color, pour off the clear oil or filter through filtering paper, and add any ethereal oil, as the oil of jasmine, cloves, cinnamon, etc.

Huile antique à la Bergamotte. Mix 500 parts of pure oil of almonds or filberts with 60 parts of oil of bergamot, and let the mixture digest in the sun for 14 days, and put up in bottles.

Huile antique à l'Héliotrope. Put 4 parts of the finest oil of almonds and a like quantity of heliotrope blossoms into a glass retort, place it in a sand-bath and distil at a moderate heat. Place the distillate in a cool place for 8 days, and then bottle the oil.

Huile à l'Héliotrope. The heliotrope blossoms should be picked very carefully and full-blown ones selected. The perfume is extracted by absorption with fat.

The following may be used as a substitute for the natural oil: Fifteen parts of Peruvian balsam are digested for 14 days in 500 parts of good oil, shaking

the vessel frequently. When the mixture is clear add 60 parts of jasmine oil and 30 parts each of the oils of roses and bitter almonds. This oil keeps a long time and resembles very much the heliotrope oil in odor. More strength and a more agreeable aroma can be given it by adding 60 parts of vanilla oil and 30 parts each of the oils of ambergris and musk.

Huile à l'Oeillet. Two kinds of pinks are used: the dark red carnation and the red with white stripes. The flowers are freed from the calyx and placed in quite thick layers upon cotton cloths. After the oil has been pressed out a stronger aroma can be imparted to it by adding to and mixing it with ethereal oil of carnation pinks.

Should it be impossible to procure fresh flowers the following mixture may be used in place of the oil: Oil free from all odor 24 parts, orange blossom oil and jasmine oil of each 12 parts, and ethereal oil of carnation pinks 1½. Mix the whole together by shaking, and let the mixture become clear.

Huile antique à la Vanille. Take pure oil of almonds 50 parts and 1.5 of oil of vanilla and follow the directions given under *huile antique à la bergamotte*.

Huile de mille fleurs et de Pot-pourri. Mix intimately the following oils: Sixteen parts each of jasmine and rose, 8 each of orange blossoms and tuberose, 6 of cassia, 4 each of hyacinthe, vanilla, and jonquil, and ½ of carnation pink. When the mixture is clear add 60 parts of flower oil. If a stronger perfume is desired, add 4 parts each of the oils of ambergris and musk.

Pot-pourri Oil is prepared from the same ingredients with an addition of 4 parts of oil of bergamot and a trace of oil of thyme.

Macassar Oil. Mix fine inodorous oil of sunflower seed 60 parts, liquid goose-grease and horse oil each 4 parts, liquid storax and egg oil each 2, neroli 1, thyme-oil 2, Pervivian balsam ½, rose oil ½, cacao butter 2. Let the mixture stand for a few hours in a moderately warm place, then put in bottles and keep them in a cool place.

Sweet Scented Oil. Mix intimately the following oils: Of cinnamon blossoms ½ part, carnation pinks ½, of berga-

mot and cedar each 3, and vanilla essence 2.

Lime Juice and Glycerine is much used in America as a substitute for hair oil. The mixture does not become rancid and, by reason of the citric acid contained in it, exerts a stimulating effect upon the roots of the hair. The following mixture gives an excellent preparation: White wax 1 part, oil of sweet almonds 20, lime water 22, glycerine 2, and oil of lemons ½.

POMADES. An addition of soap improves pomades. Before perfuming add about 250 parts of soap dissolved in hot water and about 1½ parts of borax to 12,500 parts of pomade stock. This renders the pomade as white as snow, and very emollient, which is very difficult to attain by an addition of stearine. This pomade will bear an admixture of ½ water.

Aurora Pomade is prepared from orris root and cacao butter. It is a patented article, and sold at 50 cents per pot containing ½ ounce.

Beef-marrow Pomade. Melt together 4000 parts of lard and 2000 parts of beef-marrow, strain through fine linen, and then stir with a wooden or porcelain pestle until the pomade is cold. Then work in 60 parts of oil of bergamot and 1 part of rose oil, or any other perfume desired. If the pomade is to be colored yellow, add to the fat, while yet hot, some crude palm oil or saffron; red is obtained by an addition of a few drops of alkanet.

Crème Céleste. Melt 2½ parts of white wax, 50 parts each of spermaceti and oil of almonds, and add 33 parts of rose water.

Crème Cristallisée. Dissolve 1 part of spermaceti in 1 of *huile antique de rose*, a like quantity of oil of tuberose, ½ of *huile antique* of orange blossoms, and 2½ of oil of almonds. Fill the clear mixture into small glass jars and let it cool slowly.

Glycerine Balsam. Melt white wax and spermaceti each 33 parts, and add fat oil of almonds 250 parts, glycerine 66 parts, and rose oil ½ part.

Ice Pomade. Finest olive oil 2000 parts, spermaceti 500, oil of bergamot 50, neroli 10, oil of carnation pink 30, good olive oil 50.

Neroli Pomade. Mix ½ part of rose-

pomade and a like quantity of jasmine-pomade with $\frac{2}{3}$ part of fat oil of almonds, and 1 of neroli.

Pomade according to Wagner. Fifteen parts of salicylic acid, 30 parts of spirit of wine of 91 per cent., and 150 parts of lard.

Pomade according to Winterberg. One hundred and fifty parts of lard, 120 parts of beef's marrow, a like quantity of white wax, 60 parts of Peruvian balsam, 40 parts of oil of jasmine, and 5 parts of salicylic acid.

Pomade à la Duchesse. One hundred and twenty parts of soft lard, 3 each of neroli, oil of bergamot, and oil of lemon, 1 of tincture of ambergris, and $\frac{1}{2}$ of tincture of musk.

Pomade au Bouquet. Two hundred parts of soft pomade fat, 5 of "petit grain" oil, 1 each of neroli, rose oil, and oil of geranium, $\frac{1}{2}$ each of oil of cinnamon and Peruvian balsam, and $\frac{1}{6}$ of tincture of musk.

Pomade Divine. Soak 400 parts of crude beef's marrow for 10 days in pure cold water, changing the water twice every day. Then melt the 400 parts of beef's marrow, and while it is yet liquid add 500 parts of rose water; pour the whole into a jar which contains 16 parts each of flowers of benzoin, storax, and orris root, and 8 parts each of cinnamon, nutmeg, and cloves; cork the jar tightly, and place it on the fire in a vessel filled with cold water. Then heat over a moderate fire until all is melted, pour it out and stir it until it congeals. This pomade, it is claimed, promotes the growth of hair. Rub the scalp with it before retiring.

Red Pomade. Melt together in a porcelain dish 90 parts of olive oil of the best quality, 30 parts each of white wax and spermaceti, and 3 to 4 parts of alkinet finely pulverized; then add 4 parts of an essential oil and a few of rose oil and pour the mixture into small porcelain jars.

Rose Pomade. One thousand two hundred parts of French fat rose oil, 100 of white wax, 200 of spermaceti, 1 of Turkish rose oil, 2 of geranium oil of best quality, 1 of oil of bergamot, and 1 of alkanet.

Stick and Beard Pomatum.* *Brown*

Beard Pomatum. Melt together 750 parts of olive oil, 250 parts of lard, and 375 parts of wax. Let the mixture stand for some time, then press out the clear fluid, and perfume it with $7\frac{1}{2}$ parts of oil of bergamot, 12 parts of oil of cloves, and $7\frac{1}{2}$ parts of Peruvian balsam, and color it with brown umber or alkanet which has been mixed with some bone black.

Held's Beard Pomatums. I. Take $3\frac{1}{2}$ parts each of pulverized Venetian soap and gum-Arabic, $16\frac{1}{2}$ parts each of rose water and white wax, and a few drops of rose oil. Rub the soap and the gum-Arabic together with the rose water, adding the latter all at one time to prevent the formation of lumps. Then melt the wax in a spoon or other suitable vessel, and mix it with the above paste, first heating the rubbing-dish or mortar containing it, so that the wax shall not congeal too rapidly, and a homogeneous, smooth compound is obtained.

II. Take $16\frac{1}{2}$ parts each of finely-pulverized gum-Arabic and Venetian soap, 100 parts of rose water, 33 parts of white wax, and a few drops of rose oil. Proceed as above. Then mix $16\frac{1}{2}$ parts of good ordinary soap and 5 parts of gum-Arabic, both pulverized, with about 133 parts of water, and put the mixture in a new, glazed earthenware pot. Then add 5 parts of white wax and boil the whole over a moderate coal fire until it has the desired consistency. Perfume the compound when cold with any kind of ethereal oil.

Hungarian Moustache Pomatum. Take 500 parts of lead-plaster, $6\frac{1}{2}$ parts of acacia oil, 3 parts of rose oil, and $1\frac{1}{2}$ parts each of oils of cloves and bitter almonds. Give the desired shade of color with sienna rubbed up in oil, and then mix the ingredients by first melting the lead-plaster in water.

Stick Pomades. I. Consists of purified lard and white wax each 500 parts, jasmine pomade and tuberose pomade each 250 parts, and rose oil $1\frac{1}{2}$ parts.

II. Mix purified lard 500 parts, white wax 250 parts, oil of bergamot 33 parts, and oil of cassia $1\frac{1}{2}$ parts. The pomatum is colored black with lampblack, or brown with umber rubbed up in oil.

* Barbers' pomatum generally comes in sticks.

ETC. *American Shampooing Liquid to Promote the Growth of Hair.* Mix: Rum 1000 parts, alcohol 120, tincture of cantharides 5, carbonate of ammonium 5, and salt of tartar 10. Rub the head thoroughly with the mixture and then wash with cold water.

Bandolines. I. Mix in a wide-necked flask 30 parts of gum-tragacanth converted into a coarse powder with 500 of rose water; let the mixture stand for 2 or 3 days, shaking it several times every day, and then strain through a linen cloth, using gentle pressure.

II. Boil 1 tablespoonful of whole flaxseed for 5 minutes in 1 pint of water and strain.

Bay-rum Hair Tonic. Mix intimately 150 parts of tincture of bay leaves, 4 parts of ethereal bay oil, 30 parts of bicarbonate of ammonium, 30 parts of borax, and 1000 parts of rose water; and filter after the mixture has been allowed to stand for a short time.

Bühligen's Hair Tonic. Tincture of arnica blossoms 10 parts, glycerine 5 parts, spirit of wine 10 parts, and water 60 parts.

Cheap and Efficacious Hair Tonic. Mix: Eau de Cologne 60 parts, tincture of cantharides 8 parts, rosemary oil and lavender oil of each a few drops.

Cheap Hair Wash. Pulverize 30 parts of borax and 15 parts of camphor, and dissolve the powder in 1500 parts of boiling water. The solution when cold is ready for use. The camphor will form small lumps, but this does not destroy the efficacy of the solution, as the water is thoroughly impregnated. This wash, with which the hair should be frequently moistened, not only cleanses and improves it, but strengthens the growth, preserves the color, and prevents premature baldness.

Eau de Lustre (For Dressing the Hair). I. Dissolve 120 parts of gum-Arabic in 500 parts of tepid water, and add to the solution 4 parts of sandurac. Before the water becomes entirely cold add to it the white of 2 eggs beaten to a froth, and then compound the whole with some rose water. In place of the gum-Arabic 15 parts of pulverized sugar may be used. In using this preparation pour a little of it into a

small saucer and apply it to the hair with an old tooth-brush.

II. Boil 7 parts of isinglass in 500 parts of water, add 7 parts of pulverized sugar and 250 parts of spirit of wine or rose water, and shake vigorously until a homogeneous mixture is formed.

Glycerine Wash. Dissolve 33 parts of borax in 4000 parts of orange blossom water, and add 250 parts of glycerine.

Rosemary Hair Wash. Dissolve 33 parts of pearlsh in 2000 parts of rosemary water, and add 250 parts of rectified spirit of wine. This preparation can be colored brown with kino.

Wash to Remove Dandruff. Glycerine, chlorate of potassium, borax, and spirit of camphor each 1 part, and water 25 parts. Rub the scalp thoroughly with this preparation before retiring, and wash the head with the yolk of egg once or twice a week.

HAIR DYES. The basis of nearly all hair dyes is either lead or silver, and the constant application of these metals to the skin is dangerous. We here give several such dyes with a silver basis, quite as much for the purpose of instructing those who would use these preparations of the risk they run as of furnishing formulæ for compounding them. To these we have added some which are innocuous, although these latter are not so effective as those prepared from silver and lead. Let the use of all hair dyes be practised with the utmost care.

Brown Hair Dye. Dissolve 33 parts of nitrate of silver in 250 parts of rose water and filter the solution. The mordant used with this preparation consists of a solution of 33 parts of sulphide of potassium in 250 parts of water. The mordant is first applied and, when dry, the solution of nitrate of silver.

Eau de Chine pour Noircir les Cheveux. This hair dye, sold in Paris, is prepared in the following manner: Put 8 parts of pure silver in a flask and pour gradually 30 parts of aqua-fortis over it. Place an earthen vessel filled with sand over a moderate fire and put the flask into the sand. As soon as the silver is dissolved add 1 ounce of mercury and 3 fluid ounces of aqua-fortis. When the solution is complete

add gradually $\frac{1}{2}$ pint of distilled water, then take the retort from the sand and let it stand in a moderately warm place until the liquid is clear, and then fill it in bottles which must be well closed.

Eau Lajeune is a hair-dye manufactured by M. Lajeune, perfumer in Paris. An elegant box contains 3 bottles of fluids and 2 small hair brushes. Bottle No. 1 contains a clear fluid consisting of 25 grains of pyrogallic acid, $4\frac{1}{2}$ grains of alkanet, 6 fluid drachms of spirit of wine, and 1 fluid ounce of water. Bottle No. 2 contains a thickish, brown, opaque fluid, composed of $\frac{1}{2}$ ounce of nitrate of silver, 1 fluid drachm of spirit of sal-ammoniac, $\frac{3}{4}$ fluid drachm of gum-Arabic, and 7 fluid drachms of distilled water. Bottle No. 3, labelled "*Fixateur*," contains a fluid consisting of $7\frac{1}{2}$ grains of sodium sulphide and 2 fluid drachms of water.

Hager's Innoxious Hair Dye as a Substitute for Lead Preparations. Place 10 parts of basic nitrate of bismuth and 150 parts of glycerine in a glass matrass, heat it gently and add caustic potash lye until by shaking, gentle heating, and digesting on a water-bath a solution as clear as water is obtained. Then add citric acid dissolved in an equal quantity of water until the alkaline reaction only slightly prevails. Then add sufficient orange blossom water until the whole amounts to 300 parts. The fluid may now be compounded with some aniline color. This preparation gives good results, but its effect is somewhat slow.

Innoxious Hair Dye. Prepare a pomade of 5 parts of lard and 2 of white wax by melting these two ingredients together, and mixing with them 2 parts of bone-black. The dye is not a very durable one, but it is entirely harmless, and if carefully applied does not rub off as easily as might be supposed.

Turkish Hair Dye. Pulverized gall-nuts are rubbed to a paste with sufficient fat oil, and the paste is then roasted in an iron vessel until no more oily vapors escape. The residue is rubbed to a paste with water and, while yet moist, mixed as intimately as possible with sufficient metallic powder, consisting of the finest iron and copper dust, so as to retain the consistency of an ointment, and perfumed with powdered

ambergris. The preparation must be kept in a moist place, as thereby only it acquires the property of dyeing the hair black. One application is sufficient to impart a beautiful black to the hair, which it retains for a long time, leaving it soft and glossy.

Depilatory Compounds. Triturate in a saucer 20 parts of quicklime, 1 of pure potash, and 1 of potassium sulphide, and stir the whole into a paste with warm water. Soak the hair in warm water of 128° F. for 10 minutes, and apply the above paste while yet warm. The effect is instantaneous; but the skin should be washed with vinegar to remedy any injurious effect the preparation may have on it.

Sulphydrate of Sodium is recommended by R. Böttger as a very effective and inodorous agent destructive of hair. It is readily obtained by rubbing together intimately 1 part by weight of crystallized sulphydrate of sodium with 3 parts by weight of fine purified chalk to a fine powder. By moistening this mixture, which keeps for an unlimited time in well-closed glass vessels without suffering decomposition, with a few drops of water to a thick paste, and placing it in a layer of the thickness of a knife blade upon a hide covered with hair, it will be seen that the thickest hair is changed within a few minutes into a soft mass easily removed from the skin with water. Great care should be used in applying it to the human body.

COSMETIC AND MEDICATED WATERS. "*Anhalt*" Water. Pulverize $\frac{1}{2}$ ounce each of galanga and rosemary blossoms, the same quantity each of fennel seed, bay leaves, and frankincense, and the same each of cloves, cubebs, nutmegs, cinnamon, and mastic. Place the powders in glass flasks, pour $\frac{3}{4}$ pint of Venetian turpentine and 1 gallon of rectified spirit of wine over them, and let the whole digest for 6 days; then add 1 pint of water and distil over $\frac{1}{2}$ gallon of "*Anhalt*" water. It is used for strengthening weak and lame limbs.

Barège Waters. I. *Napoleon's Bath.* Boil $1\frac{1}{2}$ grains each of alum, chalk, and hard soap, $3\frac{1}{2}$ grains of salt, 20 grains of carbonate of sodium, and $15\frac{1}{2}$ grains of potassium sulphide in $1\frac{1}{2}$ quarts of

water until gas commences to be developed, and then add sufficient water for the whole to make 1 gallon of fluid.

This water is used as a bath for eruptions of the skin.

II. Dissolve 2 ounces each of sulphhydrate of sodium, carbonate of sodium, and common salt in a little water, and then add the quantity of water required for a bath.

"Bretfeld" Water is used for washing the skin and sprinkling clothing. It is prepared by mixing 2 fluid drachms each of neroli, oil of bergamot, and oil of lemon, 1 fluid drachm each of the oils of lavender and rosemary, 30 grains of mace, $4\frac{1}{2}$ grains of musk, and $7\frac{1}{2}$ grains of ambergris with some spirit of wine, allowing the mixture to stand for 1 month, frequently shaking it, and finally pouring off the clear liquid.

Cascarilla Water. Distil 1 pound of cascarilla bark with sufficient water to produce 10 pounds of liquid.

Creole Water. Pour 1 pint of French brandy of 36° over $4\frac{1}{2}$ ounces of orris root cut up in small pieces. Let the whole stand, with frequent stirring, for 14 days, and then filter. Add to the filtrate $\frac{1}{2}$ fluid ounce of oil of orange blossoms, $\frac{1}{2}$ fluid ounce of oil of geranium, and 1 quart of French brandy. Distil the mixture and add simple cumarin essence to the distillate.

Eau Athenienne. Hoffmann's life balsam, eau de Cologne, essence of orris root, each 200 parts, essence of musk and essence of ambergris each 1, and glycerine 150.

Eau de l'Impératrice. Dissolve 15 drops each of cedar oil and oil of bergamot in 1 fluid ounce of rectified spirit of wine, add $\frac{3}{4}$ ounce of hydrochlorate of ammonia, 1 ounce of basic carbonate of potassium, and 13 fluid ounces of eau de Cologne. Mix the whole with $\frac{1}{2}$ pint of orange blossom water and distil over 1 quart of liquid.

Eau des Odalisques. Take 1 gallon of alcohol of 32° , 1 quart of rose water, 4 ounces of cream of tartar, $1\frac{1}{2}$ ounces of storax, $\frac{3}{4}$ drachm each of bartram root, cypress root, galanga, angelica root, essence of mint, and dill seed, $\frac{3}{4}$ ounce each of liquid Peruvian balsam and dry Peruvian balsam, $\frac{3}{4}$ drachm of the finest cinnamon, and 30 grains of

cochineal. Pulverize the roots, place all the ingredients in a glass matrass, pour the alcohol and rose water over them, and let them digest for 8 days; then strain and filter.

Eau des Princesses. Mix together tincture of benzoin 4 parts, carbonate of potassium 1, spirit of camphor 1, tincture of musk $\frac{1}{4}$, eau de Cologne 260, and water 60. The preparation, after having stood for 4 weeks, is ready for use.

English Honey Water. Pour 48 parts of rectified spirit over 3 parts of centifolious rose leaves cut up, $\frac{1}{4}$ of orange blossoms, and a few rinds of lemons cut up. Then pound fine in a mortar $1\frac{1}{2}$ part of ambergris, $1\frac{1}{2}$ part of musk, with an addition of a little sugar. To this mixture add $\frac{3}{8}$ part of pulverized cloves, $\frac{1}{4}$ part of coriander seed pulverized, and $\frac{1}{2}$ part of vanilla bean cut up in small pieces. After adding these to the ambergris and the musk the whole is pounded again, and $1\frac{1}{2}$ parts of fine honey are at the same time incorporated with them by rubbing. The whole is then mixed with the spirit of wine, the mortar and pestle washed off with 6 parts of good rose water, and this added to the rest. The mixture is digested for 3 days, and then distilled in the water-bath.

Florida Water. This cosmetic, much in demand in America, is prepared according to the following receipts: I. Oil of bergamot 4 ounces, oil of lemon 6 ounces, oil of lavender 1 ounce, oil of cloves 6 drachms, alcohol $3\frac{1}{2}$ gallons, water 6 pints. The oils are first dissolved in the alcohol and the solution allowed to stand for some time, and finally the water is added, and the whole filtered.

II. Oil of bergamot 8 ounces, neroli 4 ounces, oil of lavender 3 ounces, oil of cloves $1\frac{1}{2}$ ounces, oil of cinnamon $\frac{1}{4}$ ounce, tincture of iris $\frac{1}{2}$ pint, tincture of Peruvian balsam $\frac{1}{4}$ pint, alcohol 4 gallons, water 6 pints. It is prepared in the same manner as No. I.

Held's Cosmetic Washes. I. Dissolve 15 grains of Venetian borax in $\frac{1}{2}$ fluid ounce each of rose water and orange blossom water. This preparation is used to remove pimples and other impurities of the skin. Moisten the places 4 or 5 times daily.

II. Mix 7 fluid ounces of orange blossom water, $3\frac{1}{2}$ fluid ounces of eau de Cologne, and $\frac{1}{2}$ fluid ounce of tincture of benzoine. Pour 1 or 2 spoonfuls of it upon a moist sponge or flannel cloth and wash the skin with it.

Kummerfeldt Water. Rub together in a porcelain mortar $\frac{1}{2}$ ounce of flowers of sulphur, 1 fluid ounce of spirit of camphor, and $1\frac{1}{2}$ fluid ounces of spirit of lavender, and add $1\frac{1}{2}$ fluid ounces of glycerine. Pour the mixture into a glass flask and mix it with $2\frac{1}{4}$ fluid ounces of eau de Cologne and 1 quart of distilled water. Shake the liquid thoroughly before using it.

COSMETIC POWDERS, ROUGES, ETC.

Bran of Almonds. Convert 3 parts of sweet almonds peeled into an emulsion with $4\frac{1}{2}$ parts of water, press out thoroughly, and dry the residue. When entirely dry rub it to a fine powder, and mix it with $\frac{2}{3}$ part of pulverized orris root.

Cosmetic Wash Powder. Mix 400 parts of pulverized Castile soap, 33 of dry carbonate of sodium, 133 of orris root, 200 of bran of almonds, 3 of oil of bergamot, 1 of oil of lemon, and $\frac{1}{2}$ of oil of cloves. A small quantity of this powder added to water gives to it a lather of an agreeable odor which cleanses and softens the skin.

Flour of Almonds. Mix 500 parts of crushed almonds, a like quantity of wheat flour, 125 of pulverized orris root, 16.5 of oil of limes, and 1 of oil of bitter almonds.

Held's Washing Powder for the Hands. Mix intimately fine wheat flour 500 parts, ordinary pulverized soap 125, finely pulverized orris root 33, oil of bergamot $2\frac{1}{2}$, and keep this mixture in a well-closed jar.

In using it take 1 or 2 spoonfuls of the powder, mix it to a thin paste with water, and rub the hands with this for some time, then wash them in clean water and dry them thoroughly.

Oriental Rouge. Stir finely pulverized orris root into water and strain it several times through fine linen. The powder remaining in the linen is dried and preserved in a glass jar. In using the powder apply a little of it to the part to be rouged and rub it in with the hand for a few minutes. The skin will become red during the process

accompanied with a burning sensation, but this ceases in a short time. The color lasts for several days.

Paris Powder for Beautifying the Complexion. Steep a quantity of rice in pure clean water. Change the water every day for 14 days until the rice is so soft that it can be easily crushed. Then pour off all the water and stir the rice into a white, milky fluid. Strain this through a hair sieve or a coarse cloth, let the fluid settle and dry the fine flour gained in this manner, and finally mix it with some pulverized soda.

Rouge. Sixteen grains of carmine and 1 drachm of carbonate of magnesium.

Vinaigre Rouge. Digest for 14 days 3 drachms of cochineal, a like quantity of carmine lake, 6 fluid drachms of alcohol, and 1 pint of vinegar perfumed by oil of lavender.

White or Pearl Powder. One ounce of oxide of zinc, $8\frac{1}{2}$ ounces of rice flour or starch, and 3 drops of rose oil.

Augustin's Cosmetic Wash. Mix 9 fluid ounces of rose water, $\frac{1}{4}$ ounce of salt of tartar, and $\frac{1}{2}$ fluid ounce of tincture of benzoine. The mixture is used as a hair wash.

Copland's Aqua Cosmetica. Mix $3\frac{1}{2}$ fluid ounces of emulsion of bitter almonds, $\frac{1}{4}$ pint each of rose water and orange flower water, 1 drachm of borax, and 2 fluid drachms of tincture of benzoine. The preparation is used as a wash for the skin.

Flacon Générateur Universel des Cheveux de Madame S. A. Allen consists of precipitate of sulphur 1.69 per cent., pulverized cinnamon 0.20 per cent., glycerine 32 per cent., acetate of lead crystallized 2.65 per cent., water 63.46 per cent. perfumed with nitrobenzol. The acetate of lead and sulphur are first rubbed together, the powdered cinnamon is then added, and finally the glycerine and water, and the whole filtered through gauze.

FUMIGATING ARTICLES. *Black Fumigating Pastils.* Two and three-quarter pounds of willow charcoal finely pulverized, $3\frac{1}{2}$ ounces of pulverized benzoine, $1\frac{1}{2}$ ounces each of powdered storax and liquid storax, $\frac{1}{2}$ ounce each of pulverized cloves, cinnamon, and Peruvian balsam, $1\frac{1}{2}$ grains of musk, 1

fluid drachm of oil of lemon, $\frac{1}{2}$ fluid drachm each of oil of bergamot and oil of cloves are mixed with sufficient starch paste to form a half-dry, plastic mass, which is shaped into little cones and dried.

Fumigation with Chlorine. Mix 125 parts of sulphuric acid in a flask with 375 parts of water. Then mix 166.5 parts of dry common salt with 66.5 parts of pyrolusite finely pulverized. Bring this mixture into the dilute sulphuric acid, and place the open bottle in the room to be fumigated.

Fumigating Essence. Alcohol 600 parts, benzoin 125 parts, infusion of storax 400 parts, tolu balsam 100 parts, Peruvian balsam 4 parts, acetic acid 2 parts, oils of bergamot, lavender, and cloves each 5 parts, and infusion of nutmegs 3 parts.

Fumigating Pastils. The solution of gum-tragacanth used as an agglutinant is prepared by pouring 60 parts of warm water over 10 of gum-tragacanth, letting it stand for a few days, and then pressing or squeezing through a coarse cloth. The pulverized charcoal used in preparing the pastils must be thoroughly calcined and contain no ill-smelling constituents.

I. Convert the following ingredients into a fine powder: Charcoal 60 parts, benzoin 2, storax 2, frankincense and mastic each 4, anise resin 1. Mix the powders intimately with the charcoal and then stir them into a paste with the necessary quantity of solution of gum-tragacanth.

II. Pulverize and mix: Charcoal 2, cascarilla bark and sandarac each 4, anise resin and liquid storax each 1, cinnamon and cloves each 2, musk and ambergris each $\frac{1}{4}$ part, with sufficient solution of gum-tragacanth, and form the paste into cones.

III. Very cheap fumigating pastils are obtained by pulverizing and mixing: Charcoal 6 parts, frankincense $\frac{1}{2}$, juniper wood $\frac{1}{4}$, and liquid storax $\frac{1}{4}$. The mixture is formed into a paste with starch paste and cones made of this.

Fumigating Spirit. I. Mix 500 parts of eau de Cologne, 66 $\frac{1}{2}$ parts of tincture of benzoin, 33 $\frac{1}{2}$ parts of tincture of vanilla, and $\frac{1}{2}$ part each of oils of thyme, mint, and nutmeg.

II. Mix 500 parts of rectified spirit

of wine, 16.5 parts of benzoic acid, 1.5 parts each of oils of thyme and cumin, and 66.5 parts of oil of bergamot.

Imperial Fumigating Powder. Five hundred parts of orris root coarsely powdered, 250 parts of rose wood, a like quantity of cascarilla bark, 66.5 parts of cassia, 750 parts of blue corn flowers, 1500 parts of rose leaves, 2000 parts of lavender flowers, 12 parts of oil of thyme, 90 parts each of oils of bergamot and lemon, 60 parts of oil of lavender, and 5 parts of liquid storax.

Indian or Yellow Fumigating Pastils. Five hundred parts of pulverized sanders wood, 750 parts of benzoin, 125 parts of tolu balsam, 5 parts each of oil of sandal wood, cinnamon, and cloves, and 5 parts of nitrate of potassium. The ingredients are converted with solution of gum-tragacanth into a paste, which is formed into cones.

Medicated Fumigating Pastils. Iodine Pastils. Iodine 77 parts, pulverized althea 600, saltpetre 525. Rub the iodine to a fine powder with alcohol, add the althea and saltpetre, and make the compound with water into paste from which conical pastils are formed, each containing about 4 $\frac{1}{2}$ grains of iodine. Sulphur pastils are made in the same manner.

Stramonium Pastils. Pulverized stramonium leaves and saltpetre each 600 parts, and pulverized althea 750. The same proportions are used for digitalis and belladonna pastils.

Tar Pastils. Tar 450 parts, saltpetre and pulverized althea each 525 parts. The powder is mixed and formed into paste without the use of water.

Opium Pastils. Pulverized althea and saltpetre each 600 parts, pulverized opium 39. Mix the powders into a paste with water and form into pastils.

Oriental Fumigating Balsam. Cloves, cascarilla bark, amomum seeds, olibanum each $\frac{1}{2}$ ounce, orris root, benzoin, and cinnamon each 2 $\frac{1}{2}$ ounces, nutmeg and Peruvian balsam each 1 ounce, musk, oils of bergamot and lavender each 12 grains, oils of fennel and rosemary each 10 drops, oil of orange flowers 20 drops, and 1 pint of rectified spirit of wine free from fusel oil and of 30° Beaumé. Powder and mix the ingredients, let them digest for 8 days in a warm place, shaking the vessel sev-

eral times each day. Then separate the fluid from the sediment, pour $\frac{1}{2}$ pint of spirit of wine upon the latter, let it again stand for a few days, then pour off the clear fluid and add it to the first. Comminate the solid residuum and place it in a glass, weigh and pour the fluid into the glass and let it stand in the sun, or in winter near a warm stove, shaking it frequently. Filter the resulting product immediately after it has been drawn off.

Paris Pastils. Mix 125 parts each of benzoin and cascarilla bark, 41.5 parts of myrrh, 750 parts of wood charcoal, 25 parts each of oils of nutmeg and cloves, and 66.5 parts of saltpetre, and the necessary quantity of solution of gum-tragacanth.

Perfumed Pastils. Mix 500 parts of wood charcoal powder, 375 parts of benzoin, 125 parts each of tolu balsam, vanilla beans, and cloves, 3 parts each of oil of sandal wood and neroli, 50 parts of saltpetre, and the necessary quantity of solution of gum-tragacanth.

White Fumigating Pastils. Pulverized lime wood 8 parts, benzoin and mastic each 1, and white Peruvian balsam $\frac{1}{2}$. Mix with as much solution of gum-tragacanth as required.

PHARMACEUTICAL PREPARATIONS.

Artificial Carlsbad Water. Take 6 grains of calcium chloride, 1 drop of tincture of sesqui-chloride of iron, $1\frac{1}{2}$ drachms of sodium sulphate, 1 drachm of sodium carbonate, $7\frac{1}{2}$ grains of sodium chloride, and 1 pint of water charged with carbonic acid.

Artificial Koumiss. Mix 100 parts of condensed milk with 1000 of water; add 1 part of lactic acid, $\frac{1}{2}$ of citric acid, and 15 of best Jamaica rum. Saturate the mixture with carbonic acid, fill it in bottles, and let them stand first for a few days in a moderately warm room and then keep them in the cellar.

Balm of Gilead. Forty parts of compound tincture of cardamoms and 10 parts of tincture of cantharides.

Balsam of Horehound for Colds and Asthma. Make an infusion of equal quantities of licorice root and horehound leaves, $1\frac{1}{2}$ pints of hot water, and add $\frac{1}{2}$ ounce each of laudanum, camphor,

flowers of benzoine, squills, and aniseed oil, and $1\frac{1}{2}$ pounds of honey.

Bitter Elixir. Chop up: Zedoary root $1\frac{1}{2}$ drachms, rhubarb root $\frac{1}{2}$ ounce, gentian root $\frac{1}{2}$ ounce, oriental saffron 30 grains, Barbadoes aloes 1 ounce, myrrh $\frac{1}{2}$ ounce, larch-agaric $1\frac{1}{2}$ drachms, and common valerian $\frac{1}{2}$ ounce. Place the ingredients in a suitable glass flask and pour 3 pints of spirit of wine over them. Let them digest for 8 days in a moderate heat, then strain through a cloth and filter. This elixir can be highly recommended.

Bland's Female Pills. Sulphate of iron 10 parts, salt of tartar, powdered licorice, and gum-tragacanth of each 20 parts. Make into pills with extract of gentian.

Blistering Ointment, a cure for spavin, old swellings of the hough, bony excrescences, etc., in horses, consists of $1\frac{1}{2}$ drachms of pulverized cantharides, 40 grains of euphorbium, $\frac{1}{2}$ ounce of elemi salve, 20 drops each of oils of juniper, rosemary, and turpentine.

Blume's Remedy for Spavin, etc., consists of arsenic 12 per cent., bromide of potassium 10 per cent., opium 5 per cent., animal charcoal 1 per cent., bay-oil 20 per cent., and cantharides salve 53 per cent.

Camphor Ice. Melt together 4 parts of spermaceti and 30 parts of oil of almonds and add 4 parts of pulverized camphor.

Cheltenham Salts. Take 30 parts of Glauber's salt, 24 parts each of Epsom salt and common salt, and $\frac{1}{2}$ part of sulphate of iron. Dry each powder separately, and then mix them. A solution of this mixture gives a good artificial Cheltenham water. It is a tonic and mild purgative.

Cod-liver Oil and Iodide of Iron. Dissolve by frequent stirring or shaking for a few days 1.25 parts of iodine in 98.5 of cod-liver oil. The oil is then poured in a vessel hermetically closed, and shaken with 2.5 parts of pulverized iron for about 4 hours until it has assumed a purple-violet color, and a test with solution of iodide of potash and starch shows no more free iodine. The preparation, after having stood for 24 hours, is allowed to settle and filled in well-closed bottles of yellow glass

large enough to hold the doses required for 5 days, since the air exerts no perceptible influence upon it in this time. The preparation has a purple-violet color, a specific gravity of 0.937 to 0.940 at 60° F., and should contain 1.23 per cent. of iodine and 0.27 per cent. of iron.

Compound Storax Pills, for allaying pain in cases of chronic cough, consist of prepared storax 6 parts, pulverized opium and saffron each 2 parts. Make into pills of 4½ grains. Dose: 1 to 2 pills.

Dolorifuge Elixir Anti-Odontalgique. This cure for toothache is composed of a mixture of 2 parts of acetic ether and 1 part each of chloroform and creosote.

Edinburgh Stomachic Elixir. Chop up and pound 66 parts of gentian root, 33 parts of orange rind freed from the white skin, 5 parts of white cinnamon, and 2 parts of cochineal. Place the ingredients in a suitable glass flask, pour 1250 parts of rectified spirit of wine over them, let them digest for 4 days, then strain the liquid through a cloth and filter.

Glycerine Collodion is prepared by dissolving 2 parts of glycerine in 100 of collodion.

English Peppermint Lozenges. To give to peppermint lozenges the peculiar sharp and agreeably pungent taste of the English product the following receipt may be highly recommended: Dissolve 14 parts of white gelatine in 150 of water and intimately mix with it 4000 parts of pulverized loaf sugar, 300 of starch, 1 of pulverized ginger, and 20 of the oil of peppermint, into a paste dry enough not to stick to the board upon which it is worked. Form into 30 grain lozenges. They are as white as chalk, and require no sprinkling with flour.

Erasing Powder. Mix thoroughly: Equal parts of alum, amber, sulphur, and saltpetre, and keep the mixture in a well-closed jar. By sprinkling some of the powder upon an ink-stain or recently written characters, and rubbing with a white linen rag, the stain or characters will at once disappear from the paper.

Hoff's Malt Beer. To the beer brewed to the consistency of thin syrup

add the following ingredients: Comminute and boil in 3 gallons of water 1 pound althea root, ½ pound coriander seed, ¼ badiane seed, and ½ pound grains of paradise; cool, press out and filter the liquor. Of this 1 quart is added to every 7½ gallons of beer, besides the necessary quantity of sugar syrup, or 1 quart of glycerine, a few drops of oil of lemon, 1 drop of orange oil, and 1 pint of beer color.

Improved Collodion Styptic. Collodion 100 parts, carbolic acid 10, tannin 5, and benzoic acid 5. This preparation has a dark-brown color, leaves, after evaporation, a tightly adhering film, coagulates the blood instantaneously to a crusty mass, and the wound under this covering heals in a very short time.

Iodoform. According to *Vulpius*,

Oil of					
Turpentine	dissolves	4	per cent.	of iodoform.	
Lavender	"	7	"	"	"
Cloves	"	8	"	"	"
Lemons	"	9	"	"	"
Rosemary	"	9	"	"	"
Cassia	"	14	"	"	"

Petroleum ether dissolves 1 per cent. and benzole 1½ per cent. of iodoform, both solutions assuming a rose color in a short time.

Iodoform Pencils. Mechanical mixtures of finely powdered iodoform with gelatine and glycerine, which in the form of cylindrical elastic pencils are introduced into wounds, have been in use for some time. Recently a demand has sprung up for such pencils containing a large percentage of iodoform, and *Vulpius* has, by the following process, succeeded in incorporating as much as 50 per cent. Dissolve on a water-bath 15 parts of the best gelatine in 50 parts of water and 7.5 parts of glycerine, and evaporate the solution to 54 parts; then intimately mix with it 27 parts of iodoform rubbed as fine as possible, and pour the paste into a moderately heated mould, which to accelerate congelation, and to prevent the heavy iodoform powder from sinking to the bottom, is immediately placed in ice-water. The congealed cylinders are finally dried to ⅓ of their weight by being placed in a drying-room.

Aromatic Balsam. Mix in a por-

celandin mortar 33 parts of pressed nutmeg oil, 4 parts each of oils of cloves and lavender, 1.33 parts of oil of amber, and 6 parts of black Peruvian balsam. This balsam is an excellent remedy for colic in children, applied by rubbing it on the stomach.

Locatelli's Balsam for Wounds and Ulcers. Melt in a copper pan 500 parts of yellow wax, then add 750 parts of olive oil and 500 parts of Venetian turpentine. Take the pan from the fire, and then add 66 parts of black Peruvian balsam and 33 parts of pulverized red sanders wood.

Soap Balsam for Sprains. I. Pulverize in a mortar 25 parts of Venetian soap, and add gradually during the operation 75 parts of oil of turpentine. Form a paste of the mixture and keep it for future use.

II. *To Prepare the Balsam,* dissolve the paste in 150 parts of rectified spirit of wine and filter the solution.

Gelatine Capsules for Medicinal Purposes. Dissolve 8 parts of gelatine, 2 of sugar, and 1 of gum-Arabic in 8 of water in a water-bath. Dip iron pins, the lower ends of which are pear-shaped and slightly oiled, into the lukewarm solution. The thin gelatine films formed on the iron pins when congealed are detached and placed in a hole of a corresponding size in wooden forms, and allowed to dry. The capsules, when thoroughly dry, are filled with the respective medicines, and closed with a drop of the same solution.

English Plaster. Prepare a concentrated solution of gelatine in warm water, and compound it with pure alcohol. Stretch silk taffeta of a flesh or black color in a frame, and apply 3 coats of the solution, allowing 1 coat to dry thoroughly before laying on the next. When the last coat is dry, give the whole a coat of tincture of Peruvian balsam.

Malt Extract. Allow a mixture of equal parts of crushed malt and water to stand for 3 hours, add 4 parts of warm water, and keep the mixture for 1 hour at a temperature of 150° F. The compound is then boiled up once, pressed, filtered, and evaporated as quickly as possible.

Malt Extract with Iron. Dissolve 2 parts of phosphate of iron with some

citrate of ammonium in 3 parts of distilled water, and mix the solution with 95 parts of malt extract.

Malt Extract with Lime. Two parts of calcium hypophosphite and 100 of malt extract.

Malt Extract and Quinine. One part of neutral quimotannic acid and 100 of malt extract.

Malt Extract and Pepsin. Five parts of German pepsin and 95 of malt extract.

Malt Extract and Iodide of Iron. Five parts of iodide of iron and 95 of malt extract.

Neutral Citrate of Magnesium. *Cornelis* gives the following method of preparing citrate of magnesium free from impurities and injurious excess of citric acid, which have been complained of as existing in the ordinary commercial article. Dissolve 100 parts of citric acid in 300 parts of boiling distilled water, saturate the solution with about 70 parts of basic carbonate of magnesium, leaving a slight excess of acid, filter the warm solution and place it in a cool place, where in 24 hours it congeals to a cheese-like mass. This, consisting of citrate of magnesium with 14 equivalents of water, is pressed, and the cake remaining in the cloth broken up in small pieces, which are dried at 70° to 75° F. and pulverized. The product is a tasteless, neutral powder of a dull white color, and soluble in double its weight of boiling water; 100 parts of it consist of 46 per cent. of citric acid, 17 per cent. of oxide of magnesium, and 37 per cent. of water.

Neutralizing the Taste of Cod-liver Oil. Mix with each table-spoonful of oil 12 drops of the following compound: Two ounces of essence of lemon, 1 ounce of sulphuric ether, $\frac{1}{2}$ ounce each of the essential oils of caraway, peppermint, and cloves.

New American Patent Medicines. *Phosphorole* is a solution of 0.6 per cent. of phosphorus in cod-liver oil, and is recommended in phthisis. *Hydroleine*, another remedy for the same disease, consists of soda $\frac{1}{2}$ grain, boracic acid $\frac{1}{2}$ grain, water 35 drops, pancreatine 5 grains, hyocholic acid (from hog-bladder) $\frac{1}{8}$ grain, and cod-liver oil 80 drops. Dose: 2 tea-spoonfuls.

Fluid Hydrastis is an alcoholic extract of *Hydrastis canadensis* miscible with water, syrup, and glycerine.

Lacto-pepsin is recommended as a universal remedy for dyspepsia and other diseases of the stomach. It consists of: Milk sugar 40 ounces, pepsin 8 ounces, pancreaticine 6 ounces, vegetable ptyalin (diastase) 4 drachms, lactic acid 5 drachms, and hydrochloric acid 5 drachms.

Thermaline is a mixture of cinchona alkaloids and extract of eucalyptus, and is claimed to be much superior to all other fever remedies, quinine included.

Oleum Aromaticum Compositum (Spice Oil for Kitchen Use). Oil of cloves 1 part, oil of mace 3.5, oil of cinnamon 5, essential oil of bitter almonds 2.5, oil of lemon 30, and absolute alcohol 50. Mix.

Opodeldoc. Soap free from stearine 12 parts, camphor 8, spirits of wine 320, oil of thyme 1, oil of rosemary 2, and spirit of ammonia 16.

Pepsin Wine with Malt. Prof. Ernst Schmidt, of Lille, France, furnishes the following receipt: Pepsin extract and maltine extract each 5½ parts, chloride of sodium 5, good cognac 45, old Chablis wine 400, vin de Grenache de Gollivure 500. By pepsin extract the author means a solution of pepsin prepared in conformity with the directions given in the "Pharmacopœia," and evaporated to the consistency of thick extract, and to which 10 per cent. of glycerine has been added. The maltine extract is prepared by pouring over crushed malt 10 times its weight of cold water, macerating it for 24 hours, and straining and pressing. Strong alcohol is added to the fluid, causing a copious precipitate to be formed, from which the fluid is after 24 hours filtered off, and fresh alcohol added to it. This is again allowed to settle for 24 hours, when the fluid is carefully poured off, the result being a shiny precipitate and a clear liquid. The latter is distilled to regain the alcohol, while the precipitate is evaporated to the consistency of a thick extract, and then compounded with 10 per cent. of glycerine.

Plastic Bandage. Tissues or textures of any material are saturated

with a solution of asphaltum with an alternate addition of rosin and coal tar, or gallipot and pitch, and eventually lime. When the finished and hard bandage is to be used it is only necessary to soak it in hot water and apply it to the broken limb, where it congeals in a short time.

Plasters. Simple Lead Plaster. Boil equal quantities of elutriated litharge and of olive oil in a copper pan over a moderate fire, stirring constantly, and adding occasionally a few drops of water until the plaster has assumed the necessary consistency.

Compound Lead Plaster. Melt together 200 parts of simple lead plaster and 25 parts of yellow wax. In the meanwhile dissolve on the water-bath 13 parts each of purified gum ammoniac and purified galbanum in 13 parts of ordinary turpentine, and mix the solution intimately with the above compound.

Preparation of Sticking Plaster. Boil in a copper pan 175 parts of pulverized litharge and 300 parts of olive oil, adding occasionally a few drops of water, to the consistency of plaster, which is stirred at a gentle heat until all the water has been evaporated and the mass has a grayish-white color. Remove it from the fire, and, while yet warm, add a mixture of 200 parts of rosin and 400 parts of common turpentine. Then evaporate, with constant stirring, until it ceases to foam, cool it and break into pieces or mould into sticks.

New Sticking Plaster by Dr. A. Hewson. Dissolve glue in boiling water. Compound the solution with 25 per cent. of officinal acetic acid, perfume with rose oil, and spread it upon paper, gauze or muslin.

Galbanum and Saffron Plaster. Place in a copper pan 200 parts of simple lead plaster and 66 parts of yellow wax. Let the compound cool off somewhat and then add 200 parts of purified galbanum, previously dissolved on the water-bath, in 33 parts of ordinary turpentine, and finally 20 parts of pulverized saffron, and mix the whole thoroughly.

Saffron Plaster. Melt together in a copper pan 250 parts each of yellow wax and rosin, and strain through a

cloth. Dissolve 66 parts each of gum ammoniac and purified galbanum in 250 parts of common turpentine. Mix it with the above composition, and stir in 66 parts each of pulverized saffron, mastic, myrrh, and frankincense. The result will be a yellowish-brown plaster.

Soap Plaster. Melt in a porcelain dish 150 parts of simple lead plaster and 25 parts of yellow wax and mix the compound with 10 parts of pulverized Castile soap.

Powdered Camphor. Glycerine is the simplest and most efficient substance to keep camphor in a finely divided state. Mix 2 parts of glycerine in 10 parts of alcohol and triturate it with 150 parts of camphor to a fine powder.

Antiarthritic Papers. Buchner's Antiarthritic Paper. Digest 11 parts of pulverized euphorbium, 22 parts of cantharides powder in 234 parts of 90 per cent. alcohol. When thoroughly extracted, compound the extract with 11 parts of Venetian turpentine, then immerse fine paper in the mixture, and dry it in the air.

English Antiarthritic Paper. Digest 29 parts of pulverized euphorbium and 14.5 parts of pulverized cantharides in 146 parts of alcohol for 8 to 10 days; then filter, and dissolve in the filtrate 58.5 parts of white rosin and 44 parts of Venetian turpentine. Apply three coats of the resulting varnish-like solution to thick letter-paper.

PHOTOGRAPHY.

Alcoholic Solution of Gelatine is easily prepared by allowing the hard gelatine to swell up in water, then melting and finally adding 4 to 5 times its quantity of 95 per cent. alcohol. The solution remains entirely clear, runs off like collodion, and dries far quicker than gelatine emulsion with 5 per cent. of alcohol, and it can be compounded with ammonia to basic reaction without injuring its firmness.

According to *Herschel*, a mixture of 1 part of dilute nitro-muriatic acid and 48 parts of rectified spirit of wine dissolves almost any quantity of heated gelatine. Poured over plates the solu-

tion dries twice as quickly as plates treated with collodion. Ether and chloroform compounded with the above acid mixture also dissolves gelatine.

Alkaline Gelatine Developer. Dissolve 1½ ounces of Nelson's amber gelatine in 2½ fluid ounces of water over a water-bath, then add 1 fluid ounce of saturated solution of caustic soda, and boil until the solution is thinly fluid. Take 1 part of this solution to 8 parts of solution of pyrogallie acid in the proportion of 1 to 250. No bromide of potassium is required; expose for a very short time; an over-exposure cannot be remedied.

Chloride of Silver and Gelatine Emulsion. Water 1000 parts, gelatine 50, nitrate of silver 15, chloride of lime 5, citric acid 5 to 10. Dissolve each chemical by itself in a part of the water. Then add to the gelatine first the nitrate of silver, next the chloride of lime, and finally the citric acid. It does not matter should the emulsion become red. It is now ready for use without washing. Coat glass plates with the emulsion and print quite dark in the photo-printing frame. The shades bronze quickly and the intensity with workable emulsion is good. In case the tones are a dirty yellow instead of black the quantity of citric acid must be increased, which will always rectify this evil. The diapositives thus produced must be still further toned, which is best done in a bath of cyanide of gold. It is fixed with weak hyposulphite, then washed, tanned with alum, and finally washed again.

Claudet's Instantaneous Positive Paper. Float the paper on a solution of 500 parts of distilled water and 20 parts of corrosive sublimate, then dry it and wash with a solution of 5 parts of nitrate of silver in 60 parts of distilled water. The negative is exposed to the light over this prepared paper for 2 seconds to 1 minute. The picture is developed by immersion in a bath of 1 part of sulphate of iron, 1½ parts of radical vinegar, and 30 parts of distilled water. The positive picture is then washed and fixed with sodium hyposulphite.

Cleansing Mixture for Glass Plates. Mix two parts of alcohol, 1 of ammonia, and 15 of water.

Cleansing Fluid for Glass Plates.

This is especially efficient in case iron salts have been used for the developing bath. Mix 30 parts of water, 7 parts of hydrochloric acid, and a trace of iodine. Rub the plate with a linen rag moistened with the fluid, and then polish in the usual manner.

Clear Caoutchouc Solutions. Tie 30 parts of caoutchouc, cut up in small pieces, in a small linen bag, fasten this to the cork of a bottle containing 1000 parts of benzine, in such manner that it floats upon the surface of the benzine. Allow it to stand perfectly quiet for 6 to 8 days. During this time the soluble portion of the caoutchouc passes over into the benzine, while the contents of the bag swell up enormously. The resulting solution, which is as clear as water and thickly fluid, contains 1.2 to 1.5 per cent. of caoutchouc. The swelled residue retains about $\frac{1}{4}$ to $\frac{1}{2}$ of the benzine used, and may serve for the manufacture of an ordinary caoutchouc varnish.

We would here remark that a solution of caoutchouc in benzine kept in half-full bottles becomes decomposed when exposed to light; that is to say, a thickish solution becomes thinly fluid and is no longer available for photographic purposes. Although the solution will undergo the same change when kept in the dark it requires at least three times as long.

Damson's Tannin Plates. 1. *Receipt for the Collodion Cotton.* Sulphuric acid of 1.840 specific gravity 1000 parts, nitric acid of 1.450 specific gravity 360 parts, water 240 parts, and cotton 50 parts.

2. *Collodion.* Collodion cotton $\frac{1}{2}$ part, ether of 0.725 specific gravity 15 parts, alcohol of 0.810 specific gravity 15 parts, cadmium iodide $\frac{1}{8}$ part, cadmium bromide $\frac{1}{8}$ part.

3. *Solution of Tannin.* One part of tannin dissolved in 30 parts of distilled water.

Developer for Gelatine Plates. *Mottu*, of Amsterdam, uses the following formula for developing emulsion negatives: Saturated solution of potassium ferricyanide and water each 120 parts, and pyrogallic acid 1 part. Before using the developer a few drops of ammonia are added to every 15 parts of it;

the plate is then washed and dipped into the mixture.

Davanne's Intensifier. In case a plate has been spoiled it is, after exposure, only partly developed and fixed with solution of cyanide of potassium. The plate, after having been freed from the last traces of the fixing salt by washing, is treated twice or several times with a solution of 2 grains of pyrogallic acid, 1 grain of citric acid, and 10 drops of radical vinegar in 1 fluid ounce of distilled water, to which a few drops of a solution of silver of 15 per cent. have been added. It is next treated with the following fluids:

1. Iodine $5\frac{1}{2}$ grains, iodide of potassium 10 grains, and distilled water 1 fluid ounce.

2. Sulphate of potassium 1 drachm, distilled water 6 fluid ounces.

Solution No. 1 is poured over the plate either in daylight or in the dark room, and allowed to remain upon it until the precipitate is perfectly yellow; it is then rinsed off with water and solution No. 2 poured upon it, and this allowed to remain until the yellow color is changed into a deep brown.

Developing Solution of Oxalate of Iron. The following receipt is by *H. W. Vogel*: a. Neutral oxalate of potassium 9 ounces, water 1 quart. b. Sulphate of iron $3\frac{1}{2}$ ounces, water $10\frac{1}{2}$ fluid ounces, sulphuric acid 2 to 3 drops. A supply of both solutions should be kept on hand. For use mix 3 volumes of a with 1 of b. Should the plates appear clouded add to 4 fluid ounces of the mixed solutions several drops of a solution of bromide of potassium, containing 3 parts of bromide to 50 of water.

Direction for Calculating Focus Distances for Enlarging Pictures. Multiply the focal length of the lens used by the number of times of enlargement required and add the focal length to the product. For instance, the negative is to be enlarged 3 times with an objective having a focal length of 4 inches; the ground glass of the camera must be 16 inches from the lens, viz.: $3 \times 4 + 4$ inches of focal length equals 16 inches. The distance the negative is to be in front of the lens is always more than the focal length, but less than twice the focal length.

Email Photographs. The object of this process is to treat photographic pictures in such a manner that they appear to stand out from the surface of the picture. The process is as follows: The photograph is carefully colored with fine gum colors, mostly transparent. The negative is covered on the collodion side with a good glass plate free from scratches, and fastened to it with clamps. The outlines of the figures are then drawn upon the glass plate with a fine brush, and black spirit lacquer and the ground of the negative filled in with the same kind of lacquer, so that only the figures remain free and clear. The glass plate is now removed from the negative, and the coating with spirit lacquer, after the first coat is dry, is repeated. The coating is now allowed to dry thoroughly; the black negative mask is then placed exactly upon the colored positive, and both joined together on the edges with strips of paper. Although the colored figure lies in reality behind the black glass plate, it seems nevertheless to stand out from it.

Gelatine Emulsions. *Abney* confirms the observations of others that gelatine emulsions become more sensitive with age. He states also that emulsion plates inclined to curl lose this fault entirely after having been kept for some time. He also recommends the following process for intensifying weak plates: The plate, after having been fixed, is first washed for half an hour with fresh water, which is changed every 10 minutes, then placed for half an hour longer in a mixture of 1 part of diluted dioxide of hydrogen and 60 parts of water, and finally washed with pure water for 5 minutes. The intensifying solution consists of: I. Pyrogallic acid and citric acid each 1 part, and water 480 parts. II. Nitrate of silver 1 part, water 24 parts. To 30 parts of No. I add 1 of No. II. The intensifying must be done in the dark room.

Glacé or Enamelled Photographs. Over a perfectly clean glass sprinkle pulverized talc and with a tuft of cotton rub it on the glass with a circular movement until every particle of the talc disappears. The talc gives a surface to the glass that assists in lifting

the enamelled print from it. Now flow the plate with collodion prepared as follows: Four and one-half fluid ounces of ether, $3\frac{1}{2}$ fluid ounces of alcohol, sufficient cotton to thicken, and 24 drops of castor oil. When this flow is dry, apply the prints face downward, after immersing them in a solution of gelatine made as follows: Cox's gelatine 1 ounce, water $8\frac{1}{2}$ fluid ounces, and glycerine 50 drops. Add the gelatine and glycerine to the water, and let it stand over night, when it will be ready for use after filtering. Allow the prints to remain in this solution about 5 minutes before laying them on the collodionized glass, and then pass a gum roller lightly over them to press them tightly to the glass, and also to remove the excess of gelatine. After the prints are nearly dry they are ready for the mounts. For this purpose light Bristol board is best. Use the gelatine solution for mounting and mount on the glass as the prints lie. It is a good plan to lay upon the back, after the mounts have been applied, a weight of some kind, as a heavy piece of glass, which should remain there for an hour at least. This assists in securing a complete contact to the print. The whole must be perfectly dry before an attempt is made to remove the prints from the glass. When they are thoroughly dry run a knife blade around the edge to start them up; and if the work has been properly done they will come off all right. Careful manipulation is the only surety for success. A little experience will enable any one to perform this operation well.

Gold and Fixing Baths. As soon as the impressions come from the printing frame they are drawn through 3 or 4 washing waters, and then immersed in a dish with water to which a handful of common salt has been added.

Toning Bath. Chloride of gold 1 grain, sodium acetate 32 grains, sodium carbonate $4\frac{1}{2}$ grains, water $8\frac{1}{2}$ fluid ounces. The following solution should be kept on hand: Chloride of gold 15 grains, sodium acetate 1 ounce, water $12\frac{1}{2}$ fluid ounces, some of this being added from time to time to the toning bath as it becomes weaker by use. The copies, after toning, are several times washed with water containing some common

salt, and finished in the following bath: Water $3\frac{1}{2}$ fluid ounces and sodium hyposulphite $8\frac{1}{4}$ ounces.

The fixing bath is previously neutralized with sodium carbonate or ammonia.

New Intensifying Bath for Gelatine Negatives. Mix successively the following solution: *a*, corrosive sublimate 4 parts, and water 200; *b*, iodide of potassium 6 parts, and water 66; and *c*, sodium acetate 8 parts, and water 66. This intensifying bath has the advantage over other solutions that it can be used immediately after fixing the plates, and it gives the requisite intensity, even to the thinnest negatives, in a few minutes.

New Developer for Bromide of Silver Dry Plates. Edwards' glycerine pyrogallic developer is superseding the simple pyrogallic developer, having greater scope in the exposure and control of the development. The following solutions are used: A. Pyrogallic acid and glycerine each 1 part, and alcohol 6. B. Bromide of potassium 1 part, ammonia of 0.880 specific gravity and glycerine each 8, and water 50. Both concentrated solutions keep for a long time. For use in developing pour 30 parts of water into a saucer, add 1 part of solution A, and a like quantity of solution B, and submerge the emulsion plate in it. With a correct exposure the image appears in a few seconds, and the development is finished in a minute. Should the picture, in consequence of over-exposure, appear too suddenly, the developer must immediately be poured off, water poured into the saucer and some of solution A added, which with the residue of the remaining ammonia will sufficiently develop the plate.

New Method of Preparing Emulsion, especially in hot weather, and which saves all washing, is as follows: Prepare the following solutions: I. Silver 400 parts, water 2800 parts. II. Bromide of ammonium 240 parts, gelatine 24 parts, water 2800 parts, and acidulate slightly with hydrochloric acid. III. Gelatine 20 parts, water 465 parts. IV. Hard gelatine and soft gelatine each 240 parts, water 2230 parts. When No. II. is melted add gradually No. I. and boil for $\frac{1}{2}$ hour. Then cool it to

about 100° F. and add No. III. Let the whole cool, then shake with 1160 parts of alcohol, when the whole will be precipitated in about 5 minutes. The supernatant liquor contains some traces of bromide of silver, but of so little value that it is best to pour the fluid off, although by filtering it can be obtained entirely clear. Now add again 1860 to 2800 parts of alcohol to the precipitate to make it more solid, and then pour off the alcohol. The precipitate may be washed once more with water, though it is not necessary. Now mix the precipitate with No. IV. keep it warm for some time and shake until all is thoroughly mixed.

New Photo-printing Receipts. I. Preliminary Preparation. Flow thoroughly cleansed plates with the following mixture: Potash water-glass 1 part and Pilsen beer 11 parts. When all the plates have been flowed heat them somewhat and let them stand till the next morning, when they are again heated, washed, and stood aside to dry.

II. *Chrome-gelatine Layer.* Wash 25 parts of gelatine in several waters and let them swell up in the last water. Then dissolve 7.5 parts of chrome-alum in 200 parts of distilled water, add the soaked gelatine, and heat the whole to 120° F. When the gelatine is entirely dissolved add 2.5 parts each of bichromate of potassium and bichromate of ammonium. The plate before flowing is somewhat heated.

Fixing Solution. Glycerine 500 parts, ammonia 50, hyposulphite of sodium 12, and water 250.

Fluid for Drawing off Negatives. Gelatine 36 parts, radical vinegar 100, and glycerine 6 to 8. The solution remains liquid even on cooling, and the negatives can be flowed cold.

Painting the Operating Room. Blue, which is generally used, prolongs the taking of a picture instead of accelerating it. The best paint for the walls of the operating room is an orange-green, obtained by mixing orange with pea-green. If, further, the collodion layer and the silver-bath are colored violet—the complementary color of orange-green—the picture is under favorable conditions taken instantaneously, while under less favorable circumstances it requires but 2 to 3 seconds.

Petschler's New Dry Method of Preparing Plates. The plates prepared by this method are not affected by daylight, and can be again sensitized by washing before exposure in water in the dark room. It simplifies without varying greatly from the ordinary process.

The collodionized and sensitized plate is first washed and then coated with albumen, which, in place of iodide, contains only 2 to 4 parts of common salt to 100 parts of albumen. The plate is then dried by submitting it to a great heat, and is not sensitive. Instead of sensitizing it in a silver-bath it is simply washed in the dark with pure water, whereby the layer becomes again sensitive.

Photo-diaphanic, or Process of Transferring Photographs together with the Albumen layer on Glass, Porcelain, etc. Float the paper 2 minutes in a bath consisting of nitrate of silver 6 parts and water 30 parts, then dry and expose it under a negative until the picture is copied. Wash with water, and tone the picture in a solution of 1 part of chloride of gold, 30 parts of sodium acetate, and 1050 parts of water, and neutralized with carbonate of sodium. Let the solution stand for 24 hours. After it has been used acidulate it slightly with hydrochloric acid, and when it is to be employed again neutralize the acid with carbonate of sodium and add, if necessary, some neutralized chloride of gold.

After toning the diaphanic picture is placed in pure water. As soon as the albumen layer begins to detach itself from the paper place the picture in a fixing bath consisting of sodium hyposulphite 4 parts and water 20, which will detach the film entirely from the paper. The film remains in the bath about 10 minutes, whereby it becomes very elastic and, after washing thoroughly with water, fit for transferring. It is laid wet on the article to be decorated, which must be entirely free from grease. If the film should not adhere properly wash it with a mixture of radical vinegar of 32° 1 part and distilled water 6, which renders it again elastic. When properly fastened remove all traces of acid by washing.

Photo-emulsions. Improvements by

H. W. Vogel. The improvements consist in a combination of emulsion of bromide of silver and gelatine emulsion with pyroxyline. Four different methods may be employed.

1. Prepare a gelatine emulsion with bromide of silver (or iodide or chloride of silver). Dry and dissolve the emulsion in 3 to 10 times its quantity of formic or acetic acid. This acidulated emulsion is used either by itself or compounded with pyroxyline.

2. Dissolve pyroxyline by itself in one of the above acids with an addition of alcohol, and mix the solution with equal parts by volume of the above acidulated emulsion.

3. Prepare an ordinary collodion emulsion, precipitate it with water, dry the precipitate, and dissolve it in one of the acids mentioned, and add gelatine either direct or in solution.

4. Dissolve gelatine and pyroxyline and add finely powdered bromide of silver (iodide or chloride of silver), or produce them in the solution. These new emulsions can be used either dry or wet.

Photo-printing without a Press. A carbon picture is prepared on a glass plate in the usual manner, and the picture surrounded by a wooden frame which exactly encloses the glass plate. Now pour on a moderately warm mixture consisting of gelatine 1 part, gum-Arabic and glycerine each 2, and possessing the consistency of the mixture used in ordinary printing. When solidification has taken place the frame or rim is carefully removed with a hammer, and the gelatine plate, which has united itself with the carbon picture, is cautiously turned over. With respect to the printing the blackening of the picture is performed with a glass roller and is best managed with an elastic runner, as practised by the ordinary printer. The printing-ink, which must be of good consistency, is dissolved in oil of turpentine or benzol. This solution without an addition of varnish is poured on the plate and distributed by the glass roller. A non-coagulated albuminized paper is now spread over the blackened picture with due precautions. The paper should not lie too long on the plate, otherwise the albumen layer is apt to dissolve and soil the

plate. Moistening the plate with water is not necessary, as the plate is moist enough for the printing of a dozen pictures. After continuous use it exhausts itself, but still it is hygroscopic enough to absorb moisture in a few hours to be ready again for printing. This method has the advantage that the print is obtained in relief; also that round or cylindrical objects, as flasks, vases, etc., can be printed.

Photographic Process with Phosphorescent Substances. The following process has recently been published by *Warnerke*: Coat a glass plate or paper with a layer of phosphorescent sulphide, using albumen as agglutinant to protect the powder from atmospheric influence. By preparing the phosphorescent surface upon a collodionized glass plate, and drawing off the film, a flexible layer is obtained. The plate coated with calcium sulphide is dark as long as not subjected to the action of light, but on exposure in the camera for about 1 minute, and brought into the dark room, the points struck by the light will appear luminous. By placing the luminous picture upon an emulsion plate for about 5 minutes, and then developing it, a complete negative, but reverse, will be obtained. An exposure of the phosphorescent plate for a few seconds suffices to obtain an image visible in the dark room; heating the plate increases the luminosity. The picture remains luminous sufficiently long to allow of several copies being successively taken upon emulsion plates. It is a remarkable fact that the picture produced in the camera is not sharp, the cause of this being evidently that the focus of the system of lenses is not corrected for rays promoting phosphorescence (especially ultra-violet and violet rays). A phosphorescent plate after having become luminous remains so in the dark for several hours, the luminosity gradually disappearing after that time, but in a red or green light it is extinguished in a few minutes. By exposing a luminous plate to bright daylight under a red glass plate, or green aniline layer, for several minutes it loses the power of emitting light in the dark. When a phosphorescent plate is exposed under an ordinary negative

a luminous image is obtained which, on being brought in contact with an emulsion plate, allows of a sharp positive being taken. By exposing a phosphorescent plate to the light, then covering it with a negative and a colored plate, extinguishing luminosity, and again exposing it, a luminous positive image is obtained, because the points struck by the colored light lose the power of emitting light in the dark. With phosphorescent plates it is possible, according to *Warnerke*, to obtain photographs from the red end of the spectrum. The entire surface of the plate must first be exposed to the light. On being struck by the spectrum of the sun the less refrangible rays (on the red end) destroy the illuminating power, and leave only Fraunhofer's dark lines gleaming upon the plate. These can then be transferred to a gelatine or collodion plate. *Lieutenant Darwin* has made similar experiments, using *Balmain's* luminous paint. He exposed a phosphorescent plate to the sunlight 3 to 4 seconds, covered it with a negative and a red glass plate, and submitted the whole to the rays of the sun for 1½ minutes, and, as soon as the plate was brought into the dark room, a luminous negative made its appearance. This, on being brought in contact with a dry plate for 30 seconds, and then developed, gave a negative picture.

Photographic Reproduction. This new process is based on the property of perchloride of iron being reduced to protochloride by light. The latter salt is not changed by a solution of prussiate of potash, while the former is immediately colored blue. The copying paper is sensitized by immersion in a bath formed of 100 parts of water, and 10 of perchloride of iron, and 5 of oxalic acid. The drawing, on transparent paper, is placed on a dry sheet of the copying paper and exposed to the light under glass from 15 to 30 seconds in summer and 40 to 70 seconds in winter. After exposure the sheet is placed in a bath of prussiate of potash (15 : 100), which immediately colors blue all the parts where the perchloride has remained intact, but does not affect the places where the salt has been reduced by light.

The drawing is then washed with water, and passed into a bath of 8 to 10 per cent. of hydrochloric acid, which removes the salt of protoxide of iron; then it is washed again and dried. The drawing now appears in deep blue tints on a very white ground, and looks like a drawing made by hand with blue ink.

Platinotypy. This new process of photo-chemical printing in metallic platinum has been recently improved by *Roppe*. He gives the following directions: Dissolve 500 parts of chloride of iron perfectly pure and dry in 1000 parts of water. Then prepare a warm solution of carbonate of sodium entirely free from potash salts. Both salts are found sufficiently pure in commerce. Then filter the solutions, and precipitate the solution of chloride of iron with the soda solution by adding the latter as long as a precipitate is formed. The result will be ferric hydrate which, by settling and washing with water, is freed as much as possible from sodium chloride which has been formed, after which it is collected in a funnel arranged for quick filtration. When dry the ferric hydrate is dissolved in a concentrated hot solution of oxalic acid. This is best accomplished by pouring the latter gradually to the precipitate contained in a beaker glass, care being had to avoid an excess. Now introduce 12 parts of sodium chloro-platinite, or, if this cannot be procured, 10 parts of platinum tetrachloride into the hot solution, filter, and concentrate the solution by evaporation. With this the first sensitizing bath is prepared.

The paper to be sensitized must be well sized. Float the paper, gelatine side down, for about 5 minutes, care being had to disperse all air bubbles, and using all other precautions as in sensitizing albumen paper. The paper, if kept excluded from light and moisture, seems to improve with age. Pictures taken upon paper several weeks old seemed to be more perfect. The entirely dry paper being exposed under a negative to the light, the picture can be easily perceived, and the printing is continued until the white places assume a weak gray coloring. The exposure requires on an average $\frac{1}{2}$ of the time

necessary for albumen papers, silvered or fumigated with ammonia. The paper is now immersed in the following developing solution: Oxalic acid 25 parts, sodium chloro-platinite 2 parts, dissolved in 250 parts of water; or, 25 parts of sodium oxalate and 1.5 parts of platinum chloride dissolved in 200 parts of water. The developing bath must be heated to 120° to 140° F.; the picture soon reaches the requisite intensity and is then washed and dried.

This process is simple, economical, and gives satisfactory results. The picture retains sometimes a yellowish tone of color caused by the excess of oxalate of iron present in the paper, which can be easily remedied by immersion in a tepid solution of potassium oxalate and alum. The sodium salts are better than the potassium salts, potassium chloro-platinite being only moderately soluble in water, while sodium chloro-platinite is very much so. By increasing the quantity of the platinum salts very dull black tones of color can be obtained, and also a paper more sensitive to light, which might be of advantage in winter.

Precipitation of Gold from Old Toning Baths. To regain the gold from baths prepared with sodium tungstate it is recommended to add to the bath, immediately after having been used, a few drops of pure aniline oil and to agitate it thoroughly. In about 12 to 24 hours the gold will be precipitated together with a little tungstate. When a sufficient quantity of gold has been collected dissolve it in *agua regia*, reduce the solution somewhat with water, neutralize it carefully with sodium carbonate, and let the fluid stand quietly for 2 or 3 days, when a precipitate of gold-spangled tungsten-bronze will be deposited, which is filtered off.

Rapid Method. Sensitive Collodion: Cotton 10 parts, alcohol 400 parts, ether 500 parts, solution of iodide of ammonium 45 parts, solution of iodide of cadmium 40 parts, and solution of cadmium ammonio-bromide 35 parts. The latter is prepared by dissolving cadmium bromide 6 parts and ammonium bromide 4 parts in 100 parts of alcohol. Sufficient tincture of iodine is added to this collodion to give it an orange-red color, and it is then allowed to stand for

2 or 3 days. The *silver bath* must be neutral, but the collodion acid red.

Developer for Photographs of Children. Water 1000 parts, sulphate of iron 50 parts, acetic acid 10 parts, boric acid 10 parts, purified honey $7\frac{1}{2}$ parts, and alcohol 30 parts.

Developer for Photographs of Adults. Water 1000 parts, iron 60, acetic acid 60, alcohol 30.

Rapid Collodion Process by Borlinetto. Rectified alcohol 96 parts, ether of 66° 144 parts, gun cotton 2 parts, ammonium iodide and cadmium iodide each 1.66 parts.

Neutral Silver Bath. Nitrate of silver 10 parts, distilled water 100 parts, and a few drops of a saturated alcoholic solution of cadmium iodide.

Developing Bath. Sulphate of iron, alcohol, nitric acid, and radical vinegar each 5 parts, and water 100 parts.

Fixing Bath. Sodium hyposulphite 1 part, water 8 parts.

Regaining of Silver from Residues of Gelatine Emulsions. Heat the residues and add caustic potash to prevent gelatinizing. When the solution boils pour it into an earthen-ware pot and add concentrated solution of potassium cyanide till the cream color of the emulsion disappears and a turbid fluid is formed. Then take 2 large zinc-carbon elements charged with potassium bichromate and sulphuric acid, connect a copper plate with the zinc-pole of the battery, and a large piece of coke with the carbon-pole, and hang both into the solution of cyanide of silver. *Pure silver* will at once be precipitated upon the copper plate. Allow the battery to act for an entire week and, when the solution is exhausted, add fresh residues. When the layer of silver is thick enough it is broken from the copper plate. It is *chemically pure silver*. The expense is somewhat less than melting. For 65 parts of zinc dissolved in the battery 108 parts of silver should be obtained.

Removing the Negative Layer from the Glass Plate is easily accomplished by pouring the following mixture over the dry, unlaquered negative: Gelatine 60 parts, water 600 parts, alcohol 120 parts, glycerine 10 parts, radical vinegar 7.5 parts. The plate is then placed in a horizontal position and

dried in a room free from dust. When dry run a knife around the edges, draw the film from the glass, pass it through dull varnish, and hang it up for a few minutes to dry. These negatives have the advantage over the glass negatives that they can be retouched from the back, which makes the retouching less visible in the printing and can be more conveniently kept, requiring less space, and besides are indestructible and can be easily handled.

Reproduction of Photo-negatives. The sensitive compound used for coating the plates is prepared from dextrine 4 parts, ordinary white sugar 5 parts, bichromate of ammonium 2 parts, water 100 parts, glycerine 2 to 8 drops, according to the condition of the atmosphere. A new well-cleansed plate is coated with the sensitive chromium solution; and, after the superfluous liquid has been allowed to flow off at one of the corners, the plate is dried in the dark upon a lithographic stone or metal plate for 10 minutes in a temperature of 120° to 160° F. The film, being perfectly dry, while yet warm, is put under a negative and printed in the shade for 10 or 15 minutes. As soon as it comes out of the printing frame the plate is again slightly warmed, and a brush, dipped into the graphite, applied over the surface of the image which should be just slightly visible. The application of the powder is done in a shaded corner of an ordinary room illuminated by daylight. Do not press hard upon the film with the brush, but move it over the surface as gently as possible; nor will it do to hurry the operation.

In proportion as the film cools so the image appears. By carefully breathing, or, still better, blowing upon the film, the operator will be enabled to accelerate the process, and when the picture has attained sufficient vigor the superfluous graphite may be taken off with a clean brush. A normal collodion is now applied composed of alcohol 500 parts, ether 500, and pyroxyline 15 to 20. When this film has set and hardened the edges are cut round with a knife, and the plate put into a porcelain dish of cold water. In 3 minutes the picture will be free from the glass, and the film may be employed in this position, or reversed with a soft brush, and

taken out of the water adhering either to the same glass plate or to another. A gentle stream of water falling upon the film will remove any chromium salt still remaining on it, and will also press down the loose film uniformly upon the glass surface. Finally the plate is allowed to dry in a perpendicular position. Further treatment of the plate with varnish follows as a matter of course. The image upon the collodion film is very thin; but it need not be feared that it will tear while in the water.

Sensitive Collodion Emulsion. Immerse the plates coated with collodion emulsion for 1 to 2 minutes in a solution of 1 part of gelatine in 100 of water, and then dry them. The plates treated thus are very sensitive, and, if correctly exposed, give a vigorous negative.

Sensitive Photo-paper. Dissolve 2 parts of nitrate of silver in 30 parts of water, and add $\frac{1}{2}$ part of citric acid. After this is dissolved add ammonia until precipitation ceases. Then redissolve with nitric acid, and leave the solution so that a small proportion of the precipitated citrate of silver remains. Let that settle perfectly, and then add 10 drops of nitric acid to every 2500 parts of solution. Sheets of the ordinary albuminized paper may be sensitized by floating for $\frac{1}{2}$ minutes. There is no trouble from bubbles. The paper is more sensitive in printing than the ordinary paper, and tones splendidly. The paper is fumed in the usual way with strong ammonia. Paper made in this way will be found just as white at the end of 5 days as when first prepared.

Simple and Quick Process of Preparing Pyrogallic Acid. Ten parts of dry gallic acid are placed in a bottle or wide tube together with 30 parts of glycerine, and heated on a sand-bath to 375° or 390° F. until development of carbonic acid ceases. The conversion of gallic acid into pyrogallic acid takes place in a short time. The brown, tenacious fluid is, after boiling, diluted with 1000 parts of water, whereby a solution is obtained containing in 20 parts about $\frac{1}{2}$ part of pyrogallic acid. Care must be had that the temperature does not rise above 390° F. during the process.

Sutton's New Developer. Dissolve 8 parts of sulphate of iron in 16 parts of water, and in another vessel 4 parts of sugar in 3 parts of water. When all are dissolved, mix the two solutions, boil and filter the mixture, and allow the salt to crystallize. This produces a more vigorous development than ordinary sulphate of iron.

Sutton's Weak Silver-bath for Albuminized Paper. Dissolve 10 parts of nitrate of silver in 100 parts of water, and add, with constant stirring, ammonia until the solution becomes clear and the turbidity at first shown has disappeared. Then add nitric acid, drop by drop, until blue litmus paper begins to redden.

Toning Bath with Calcium Chloride and Sodium Acetate by Parkinson. Mix in a suitable flask calcium chloride 3 parts, sodium acetate 8 parts, calcium carbonate 8 parts, distilled water 100 parts. Mix 5 parts of this solution with 1000 parts of water, and add $\frac{1}{2}$ part of chloride of gold. The bath, after standing for 5 to 6 hours, is ready for use, and may be kept for some time.

Transfer Paper with Collodio-chloride of Silver is prepared in the following manner: Coat a stout piece of paper with a solution of caoutchouc thick enough to prevent the collodion from penetrating and spotting the paper. When the coating is dry pour upon it collodio-chloride of silver containing 1.5 parts of nitrate of silver, 1 part of citric acid, and some glycerine. The picture prints splendidly upon the caoutchouc surface; it is toned, fixed and washed, and then laid in water until it can be mounted. The article upon which the photo-print is to be mounted is coated with a solution of gelatine containing some glycerine. When dry dip the gelatinized article in a vessel with clean water, and place the wet print, picture side down, upon it, taking care to avoid air bubbles. The mounted picture is then allowed to dry. When it is *entirely* dry the caoutchouc paper is brushed over with benzine, and withdrawn from the picture.

Various Practical Receipts. I. Collodion for Hot Weather. Ether 300 parts, alcohol 360 parts, bromide of cadmium and bromide of ammonium

each $\frac{1}{8}$ part, iodide of cadmium $\frac{1}{8}$ part, and iodide of ammonium $\frac{1}{2}$ part. Take 30 parts of this to every 30 parts of raw collodion.

II. *Collodion for Outside Work.* Ether and alcohol each 150 parts, iodide of ammonium and cadmium and bromide of cadmium each $1\frac{1}{2}$ parts, collodion cotton 4 to 6 parts. This collodion may be used for taking photographs of persons and landscapes. In case it becomes discolored, acidulate it with a trace of tincture of iodine.

III. *Developer.* Saturated solution of sulphate of iron and radical vinegar each 30 parts, water 360 parts. For white drapery and photographs of children use it somewhat more concentrated.

IV. *Silver Bath.* Water 240 parts, glycerine best quality 120 parts, and silver 20 parts. Let it stand in the sun for a few days. If the nitrate is acid, add a few drops of solution of potassium carbonate, heat to the boiling point, and filter. Later on re-acidulate the bath thoroughly. Sensitized plates keep very long in this bath.

V. *Developer for Landscapes.* Radical vinegar 90 parts, and 1 to 2 parts of sulphate of iron to every 50 parts of solution.

VI. *After-developer.* Rain-water 120 parts, citric acid 2 parts, and sulphate of iron 680 parts, and a few drops of solution of silver.

VII. *Good Intensifying Bath. Solution 1.* Permanganate of potassium $3\frac{1}{2}$ parts, water 300 parts.

Solution 2. Bichromate of potassium 65 parts, water 300 parts. Keep the two solutions in separate bottles, and for use mix equal parts.

VIII. *Solution for Preparing Paper.* Boiled milk 567 parts, radical vinegar a few drops, the white of two large eggs, bromide of potassium $5\frac{1}{2}$ parts, iodide of potassium $10\frac{1}{2}$ parts. Mix and filter. The white of egg must, previously to adding the milk, be beaten to a froth. Float the paper for 2 minutes.

IX. *Silver Bath.* Water 100 parts, silver 8 parts.

X. *Developer.* Water 240 parts, radical vinegar 30 parts, bromide of potassium $\frac{1}{2}$ part, and pyrogallic acid 2 heaping tea-spoonfuls to each 8 ounces of solution.

XI. *Fixing Bath.* Water 300 parts, hyposulphite of sodium 120 parts.

XII. *Negative Lacquer with Castor Oil.* Alcohol 500 parts, white shellac 360 parts, sandarac 45 parts, and 1 drop of castor oil to every 20 parts of lacquer.

Various Receipts for the Gelatine Process. I. *Edward's Glycerine Developer.* a. Pyrogallic acid 30 parts, glycerine 30, alcohol 180. b. Potassium bromide 4 parts, ammonia and glycerine each 30, water 180. Take 10 parts each of a and b to 300 of water.

II. *Dr. Eder's Oxalate of Iron Developer.* a. Saturated solution of sulphate of iron. b. Saturated solution of neutral oxalate of potassium. c. Bromide of potassium 1 part and water 10. Mix 100 parts of a with 400 of b, and add 15 to 30 drops of c. Should the picture not appear in the course of 5 to 10 minutes dip it into the following stronger bath: Dissolve 60 parts of neutral oxalate of potassium in 100 of boiling water, and stir in this 15 parts of sulphate of iron. This bath, when cold, will keep in full bottles tightly closed.

III. *Nelson's Developer.* a. Water 360 parts, sulphate of iron 120, alum 15, sugar 30. b. Water 720 parts and neutral oxalate of potassium 240. Mix 1 part of a with 2 of b.

IV. *Bedford's Developer.* a. Pyrogallic acid 4 parts, nitric acid $\frac{1}{2}$, water 600. b. Ammonia 8 parts, bromide of ammonium or potassium 5, water 600. For a normal exposure mix equal parts of a and b.

V. *Abney's Intensifying Bath.* Pour $\frac{3}{4}$ part of pyrogallic acid, 1 of radical vinegar, and 90 of water upon the plate previously laid in alum for one hour, and add after one minute 1 part of solution of silver. Iron may be used in place of pyrogallic acid, viz., 0.9 part of sulphate of iron, 1.8 of citric acid, and 90 of water.

Varnishes. Good Negative Lacquer. Thirty parts of bleached shellac, 10 parts of mastic, 1 part of Venetian turpentine, 350 parts of strong alcohol, and a few drops of oil of lavender.

Retouching Varnish. Shellac 1 part, sandarac 6 parts, mastic 6 parts, ether 10 parts.

Elastic Lacquer. Dammar 40 parts, acetone 180 parts.

Excellent Lacquer for Photographs. Amber 2 parts, copal 4, mastic 1, petroleum naphtha 10, spirit of wine 20.

Vibrotypes. A. Kurtz, of New York, makes use of a very original method to impart softness to negatives and thus save retouching. He places a number of gas-flames between the person whose photograph is to be taken and the camera. These put the air in vibration and cause a peculiar but not injurious softness, toning down the very sharp outlines.

Photographs on Wood. The following formula will be found useful to wood engravers, or to those who are photographing on wood: Dissolve $\frac{1}{2}$ part of gelatine in 33 parts of water, mixing it with some gilders' glue, and spread it upon the surface of the block with a broad camel's-hair brush. When dry, brush over the prepared surface, in the dark room, some of the following solution: *a.* Red prussiate of potash 8 parts, water 60 parts. *b.* Ammoniacitrate of iron 9 parts, water 60 parts. When dissolved mix together and filter. This solution should be kept in the dark. When the coating has dried expose under a negative in sunshine for 10 or 12 minutes, then take the block where the light is not very strong and wash the surface lightly with a soft sponge and water, and a beautiful dark blue picture will appear, that will not chip in cutting. To make a red picture prepare as above, but use the following mixture: Dissolve 1.5 to 2 parts of sulphate of uranium in 30 parts of thiú gum-Arabic or gelatine water; brush this on the block in the dark room and, when dry, expose under a negative for 10 to 20 minutes in sunshine. Then wash well with a sponge and water. Now take a clean sponge moistened with a solution of red prussiate of potash, $1\frac{1}{2}$ parts to 30 parts of water, and apply it quickly all over the surface, and the picture will appear immediately. When the work is completed clean with a fresh sponge and water. A drop or two of muriatic acid in some water will bleach the picture if over-printed.

Woithy's Negative Process (without Intensifying Bath). 1. Collodion. Nine-

ty per cent. alcohol 200 parts, iodide of ammonium 37 parts, bromide of cadmium 7 parts, iodide of cadmium $1\frac{1}{2}$ parts, absolute ether 200 parts, collodion cotton 8 parts, and water $\frac{3}{4}$ part.

2. *Developer for Negatives.* Sulphate of iron 2 parts, water 500 parts, alcohol 3 parts, and acetic acid $\frac{3}{4}$ part.

3. *Varnish for Negatives.* Ninety-five per cent. alcohol 50 parts, white shellac 12 parts, and a few drops of oil of lavender.

4. *Polishing Glass Plates.* Prepare a mixture of equal parts of sulphuric acid and water. Place the plates in this for one day, then rinse them with water, and rub them dry with a tuft of cotton and old collodion, and finally cleanse them completely with alcohol and linen thoroughly washed and dried.

PLASTER OF PARIS CASTS WHICH CAN BE WASHED.

Some time ago a prize was offered by the Prussian government for a method of preparing plaster casts in such a manner that they might be washed without injury. The prize was awarded to *Dr. Reissig*. In the following we give a description of the process: In preparing these casts it was not only desirable to obtain a surface which should not wash away, but also to include a simple process for preventing dust entering the pores, and rendering them more easily cleansed. Laborious experiments convinced *Dr. Reissig* that the only practical method of accomplishing this, and retaining sharpness of outline, was to convert the sulphate of lime into.

1. Sulphate of barium and carbonate of calcium; or,

2. Into silicate of calcium by means of silicate of potassium.

Objects treated in this way are not affected by hot water or hot soap solutions, but are porous, catch dust, etc., and when first put into water eagerly absorb all impurities. To avoid these evils the articles are rendered water-proof by subsequently coating them with an alcoholic soap solution which penetrates easily and deeply into the pores, and when washed is converted into suds, which easily remove the dust without allowing it to penetrate.

Process with Baryta Water. This is the easiest, simplest, and cheapest method. It depends upon the fact that gypsum or calcium sulphate is converted by baryta water into barium sulphate (which is totally insoluble) and caustic lime, which is converted by contact with the air into calcium carbonate. The practical method of carrying this out is as follows: A large zinc vessel is required with a tight-fitting cover. In the vessel is a grating made of strips of zinc resting on feet 1 to 2 inches high. This vessel is two-thirds filled with soft water of 50° to 75° F., and to every 25 gallons of water are added 9 pounds of fused or 14½ pounds of crystallized pure hydrated oxide of barium, and 9½ ounces of lime previously slaked in water. As soon as the baryta water gets clear it is ready to receive the casts. They are wrapped in suitable places with cords, and, after removing the scum from the baryta bath, are dipped in as rapidly as possible, face first, and then allowed to rest upon the grating.

Hollow casts are first saturated by rapid motions in the bath, then filled with the solution and suspended in the bath with the open part upwards. After the cords are all secured above the surface of the liquid the zinc vessel is covered. The casts are left in the bath for 1 to 10 or more days according to the thickness of the water-proof stratum required. After taking off the cover and removing the scum the casts are drawn up by the strings, rinsed off with lime water, allowed to drain off, carefully wiped off with cotton or linen rags, and left to dry, without being touched by the hands, in a warm place, free from dust. The same solution which has been used once can be used again by adding a little more baryta and lime.

Of course this process can only be applied to casts free from dust, smoke, dirt, etc. To prevent the casts from getting dust upon them they should be wrapped in paper when taken from the mould and dried by artificial heat below 212° F., care being had not to handle them with sweaty hands. If in spite of every precaution the casts when finished show yellow spots they can be removed in this manner: The casts

when perfectly dry are painted over with water and oil of turpentine, then put in a glass case and exposed to the direct rays of the sun. All spots of an organic nature will then disappear, but rust, smoke, and mineral spots cannot be removed in this way. In the place of cold baryta water the casts may be placed for half an hour in a concentrated solution of baryta heated to 100° to 120° F. This has the advantage that the casts may be put in before drying. As the casts treated in this way are not hardened very deeply and are still porous, it is well to place them subsequently in a cold bath for a longer time.

The casts are now ready, as soon as perfectly dry, for the soap solution. A pure, good, hard soap is cut in shavings, which are dried and then dissolved in 50 or 60 per cent. of alcohol, 10 or 12 parts of alcohol to 1 of soap. A solution of Marseilles soap known as "*spiritus saponatus*" can be bought at any drug store. The finest appearance as well as a high degree of durability is obtained by using a solution of stearate of soda in strong alcohol. Both the solution and cast should be warm, so that it may penetrate as perfectly and deeply as possible. It does no harm to repeat the operation several times as long as the liquid is absorbed by the cast. When dry the cast is finished.

Process with Silicate of Potassium. This process depends upon the conversion of the calcium sulphate into calcium silicate—an extremely hard, durable, insoluble compound—and is accomplished by the use of a dilute solution of silicate of potassium containing free potash. To prepare this solution make a 10 per cent. solution of caustic potash in water, heat to boiling in a suitable vessel, and then add pure silicic acid, free from iron, as long as it continues to dissolve. On standing the cold solution usually throws down some highly silicated potash and alumina. It is left in well-stoppered glass vessels to settle. Just before using it, it is well to throw in a few small pieces of potash or to add 1 or 2 per cent. of the potash solution. If the plaster articles are very bulky this solution can be diluted to one-half with pure water. The casts are silicated by dipping them in a cold state for a

few minutes into the solution, or applying the solution by means of a well-cleaned sponge, or throwing it upon them as a fine spray. When the chemical reaction, which takes place almost instantly, is finished, the excess of the solution is best removed with some warm soap-water or a warm solution of stearine soap, and this finally removed with still warmer pure water. The casts, which can be immersed or easily moved about, may be treated as above when warm; a very short time is required, but some experience is necessary. In every case it is easy to tell when the change is effected, from the smooth, dense appearance, and by its feeling when scratched with the fingernail. It is not advisable to leave the casts too long in the potash solution as it may injure them. A little practice renders it easy to hit the right point. The fresher and purer the gypsum and the more porous the cast the more necessary it is to work as quick as possible. Castings made with old and poor plaster of Paris are useless for silicating. These silicated casts are treated with soap as before. In washing plaster-casts prepared by either process it is recommended to use a clean soft sponge, carefully freed from all adherent sand and limestone, moistened with lukewarm water and well soaped. They are afterwards washed with clean water. The addition of some oil of turpentine to the soap is useful, as it bleaches the casts on standing. The use of hot soap-suds must be avoided.

Brethauer's Method of Preparing Plaster of Paris Casts Resisting the Action of the Weather. Slake 1 part of finely pulverized lime to a paste, then mix gypsum with lime water, and intimately mix both. From the compound thus prepared the figures are cast. When perfectly dry they are painted with hot linseed oil, repeating the operation several times, then with linseed-oil varnish, and finally with white oil paint. Statues, etc., prepared in this way have been constantly exposed to the action of the weather for 4 years, without suffering any change.

Jacobsen prepares casts which retain no dust, and can be washed with lukewarm soap-water by immersing them or throwing upon them in a fine spray

a hot solution of a soap prepared from stearic acid and soda lye in ten times its quantity by weight of hot water.

Shellhass recommends the coating of plaster of Paris casts with a compound of finely powdered mica and collodion prepared as follows: The mica, rendered perfectly white by boiling with hydrochloric acid or calcining, is ground very fine, sifted and elutriated, and then mixed with dilute collodion to the consistency of oil paint, and applied with a soft brush. Casts coated in this way possess a silvery lustre, have the advantage of being indifferent to sulphurous exhalations, and can be washed without injury.

PRESERVING MEAT, MILK, VEGETABLES, VEGETABLE SUBSTANCES, WOOD, ETC., AND PRESERVATIVES.

Boro-glycerine for Preserving Organic Substances is prepared by heating 92 parts of glycerine with 62 of boracic acid to 392° F.

Boro-tartrate for Preserving Meat and other Food. Distilled water is aromatized with nutmeg in the proportion of 1 or 2 parts to 1000, and in this is dissolved 12 to 15 parts of boro-tartrate obtained by melting together 2 parts of tartaric acid with 15 of boracic acid. This antiseptic fluid is injected into the arteries of the animal to be preserved, which is then cut up, and the pieces, after the bones have been removed, are immersed in the fluid for several hours and then dried in the air. Small pieces require to be immersed only for a short time, or their surface simply sponged with the fluid.

English Pickle for Meat. Dissolve 300 parts of common salt, 5 parts of saltpetre, and 50 parts of sugar in 2000 parts of water. Boil the whole and remove the scum.

Fluids for Preserving Corpses, Anatomical Specimens, Plants, etc. The Cultus Department of the German Empire has bought the following patented process from the inventor, *Jean Wickersheimer*, and published it for the benefit of the public: Dissolve 3½ ounces of alum, ¾ ounce of common salt, ½ ounce of saltpetre, 2 ounces of potash, and ¼ ounce of arsenious acid

in 2½ quarts of boiling water; allow the solution to cool, and then filter. Now add to every 2½ gallons of the neutral fluid 3½ quarts of glycerine and 1½ pints of methyl alcohol. About 1½ quarts are required for injecting the body of a child, and 1 gallon for that of an adult. Anatomical specimens are simply immersed in the fluid for 6 to 12 days. The muscles, etc., when dry, remain soft and flexible.

Struve recommends the following fluid in which the alum is omitted, which he claims to be entirely superfluous, and as exerting a disturbing influence in consequence of its being precipitated: Water 55.45 per cent., glycerine 37.7 per cent., methyl alcohol 4.43 per cent., potassium sulphate 1.34 per cent., common salt 0.46 per cent., saltpetre 0.23 per cent., and arsenious acid 0.39 per cent.

Oscar Jacobsen, for the same reason as *Struve*, changes the receipt as follows: Arsenious acid ¾ ounce, potassium carbonate ½ ounce, saltpetre ½ ounce, common salt ⅞ ounce, potassium sulphate ½ ounce, and water 2½ quarts.

Two fluids prepared according to *Wickersheimer's* patent have been brought into commerce, one intended for "injecting," the other for "immersing," the first containing larger quantities of the different salts than the latter. They contain no alum, and are prepared according to the following receipts:

	Injecting fluid.	Immersing fluid.
Arsenious acid . . .	0.56 oz.	0.42 oz.
Sodium chloride . . .	2.82 "	2.11 "
Potassium sulphate . . .	7.05 "	5.29 "
" nitrate . . .	0.88 "	0.63 "
" carbonate . . .	0.705 "	0.52 "
Water	2 gals.	2 gals.
Glycerine	3 qts.	3 qts.
Methyl alcohol	1 pt.	1 pt.

Improved Process for Preserving Meat, Fish, Fruits, Liquids, etc. For closing bottles hermetically the following mixture is used: Melt 3 parts of glue with 1 of glycerine or oil. For bottles containing volatile fluids the mixture consists of 3 parts of gelatine, ½ of glycerine or oil, and ½ of water.

To preserve meat, fish, fruits, etc., the articles are surrounded with a compound prepared by melting 2½ parts

of gelatine in ½ part of glycerine. To protect the gelatine from spoiling 4 parts of tannin are added to every 10,000 parts of the compound. The bottle or jar is hermetically closed by placing a piece of paper upon the contents, and filling the space between this and the cork with the above compound.

New Process of Giving Preserved Vegetables a Natural Color. Copper and zinc salts, both injurious to health, are frequently employed to give canned vegetables a natural green color. This may, according to a new invention, be accomplished by adding chlorophyll, the natural coloring matter of vegetables. Immerse green leaves in dilute caustic soda lye, and compound the fluid with alum. Wash the precipitate and dissolve it with potassium phosphate and alkaline earths. By adding the solution to the boiling vegetables sufficient chlorophyll is absorbed by them to retain their natural green color. The great advantage of this method is that no foreign substance is added, but only one natural to the plant and innocuous.

New Process of Preparing Preservative Salt. Melt together 4 equivalents of crystallized boracic acid and 1 equivalent of sodium phosphate, and add saltpetre and common salt.

To preserve fresh meat of any kind remove first all bones, and then scatter the preservative salt over the surface and into all hollows.

The meat may also be placed for ¼ hour in a solution of the preservative salt in the proportion of 1 to 6, or about 10 tablespoonfuls of the salt dissolved in 1 quart of water, and then wrapped up in a linen cloth moistened with the solution and hung up in the air; or it may be placed in a pot or barrel, the solution poured over it and allowed to remain until it is to be used. For 1 pound of meat 1 teaspoonful of the salt is required.

New Method of Preserving Sugar Beets, Potatoes, and other Tubers. The beets, potatoes, etc., are piled up and covered, not as formerly with straw or earth, but with a sufficient layer of the following mixture: Coal cinders converted into coarse powder 80 per cent. and lime slaked to a fine powder with

as little water as possible 20 per cent., and intimately mixed.

Preserving Lemon Juice. I. Keep the filtered juice, before it has passed into fermentation without adding alcohol, in a bottle hermetically sealed. II. Heat the fresh juice not compounded with alcohol in a closed vessel to the boiling point. III. Compound the unfermented juice with 10 per cent. of alcohol, and heat as in No. II. IV. Fill the fermented juice in bottles without an addition of alcohol and without heating. V. Heat the fermented juice without an addition of alcohol in a closed vessel to the boiling point. VI. Compound the fermented juice with 10 per cent. of alcohol and heat as in No. V. All these methods furnish a juice which, when mixed with sugar syrup in the proportion of 5 drachms of juice to 5 ounces of sugar-syrup and the necessary quantity of water, give lemonades of a fine flavor.

Process of Preparing Preserved Cattle-feed from Agricultural Products and Waste. Bran, malt-germs, brewers' grains, residues from the manufacture of oil, and of beet sugar, and of potato and corn starch are mixed with each other in water, so that in the mixture the proportion of proteine substances to the carbo-hydrates is as 1 to 3 or 4 in 52 to 53 per cent. of dry substance. To 1 pound of dry substance is added $\frac{1}{2}$ drachm of salt and some calcium phosphate; the mass is then crushed and placed in a reservoir, where it is allowed to heat spontaneously until a homogeneous compound is formed, which is pressed into cakes and dried.

Rapid Process of Corning Meat on a small Scale. Mix 16 parts of common salt, $\frac{1}{2}$ of saltpetre, and 1 of sugar. Roll the meat in the mixture so that it is uniformly covered. Then wrap it in a linen cloth and put it in a covered pot. Turn the meat several times every day. In 8 days it will be thoroughly pickled.

To Dry Fruit by means of a Cold Air-blast. Pared apples, etc., are submitted in a sieve-like holder to the action of a cold air-blast for $3\frac{1}{2}$ hours. Excellent dried fruit, much superior to that dried in the sun or by means of hot air, is prepared by this process.

To Pack Apples and other Fruit to

be transported to distant places. Wrap each fruit separately in salicylized paper and pack carefully, so that in rolling or moving the barrel the fruit are not brown against each other. The salicylized paper is prepared by dissolving salicylic acid in strong alcohol, and compounding the solution with as much water as it will bear without reprecipitating the salicylic acid. The paper is then saturated with the solution and dried. The object of the salicylic acid is to prevent the rotting of fruit injured by careless handling in packing.

To Preserve the Blood from Meat-cattle. The fresh blood to be preserved is mixed with pulverized unslaked lime. The lime being slaked in the blood is precipitated in a short time, while the blood is converted into a homogeneous jelly-like compound, which can be easily separated from the lime-precipitate, dried, and then used as a nutritious food.

To Preserve Burnt Lime. A layer of lime slaked to a powder is spread to the depth of 6 to 8 inches upon the floor of a shed protected from all moisture. Upon this layer are piled the pieces of lime to be preserved and pressed as closely together as possible. The uppermost layer should have a slight slant. On the top is also placed a layer of lime slightly moistened, which is thereby converted into powder and falls into the interstices of the heap, protecting it from the access of air and moisture. Experiments on a large scale have proved that this process is practicable, and makes the keeping of burned lime during the winter possible without losing any of its good qualities.

To Preserve Butter for Transatlantic Transport pack it in tin cans capable of holding from 2 to 30 pounds. The cans should be lined with wood saturated with brine, and, when filled, the lid must be soldered down.

To Preserve Butter. Several Methods. I. Cover the butter with a layer of metallic (iron) sponge and water, so that the air can only reach the butter by passing through it.

II. Dissolve 1 part of sodium metaphosphate in water and mix it intimately with 240 parts of butter.

To Preserve Eggs. I. In China, accord-

ing to *Tier*, the eggs are placed in a saturated solution of common salt, and allowed to remain in it until they sink down. They are then taken out, dried, and packed in boxes. The eggs, when boiled, are salted to the taste.

II. *Sack* recommends the coating of the eggs with paraffine, 1 pound being sufficient for 1500 eggs. Fresh and sound eggs are of course required for the process, as decomposition once commenced would progress notwithstanding the coating of paraffine.

III. *Marsh* dissolves in each gallon of water 12 ounces of quicklime, 6 ounces of common salt, 1 drachm of soda, $\frac{1}{2}$ drachm of saltpetre, $\frac{1}{2}$ drachm of tartar, and $1\frac{1}{2}$ drachms of borax. The fluid is brought into a barrel and sufficient quicklime to cover the bottom is then poured in. Upon this is placed a layer of eggs, quicklime is again thrown in and so on until the barrel is filled, so that the liquor stands about 10 inches deep over the last layer of eggs. The barrel is then covered with a cloth upon which is also scattered

some lime.

IV. Eggs immersed in a solution of $1\frac{1}{2}$ drachms of iodate of calcium in 1 gallon of water were not to be distinguished after a month by smell or taste from perfectly fresh eggs; how much longer than a month they may be thus preserved experience only can determine.

To Preserve Fish. Freshly caught herring immersed in a solution of $1\frac{1}{2}$ drachms of iodate of calcium in 1 gallon of water remain perfectly good in hot weather for about 4 days, when they begin to change slowly. If dry iodate of calcium is sprinkled over the fish, $1\frac{1}{2}$ to 3 grains to a dozen fish, instead of immersing them in the solution, the result is the same, and in neither case is it possible to detect the slightest foreign flavor in the taste of the fish. If salt herrings are first soaked in water long enough to remove as much of the salt as is considered desirable, and then immersed in a solution of iodate of calcium for 24 hours, they lose their disagreeable rancid flavor, and are completely restored to the flavor they had when freshly caught.

To Preserve Fluids containing Nutritive Substances. The residues from

the manufacture of alcohol and of compressed yeast are filtered, passed through the centrifugal, or pressed. For filtering, a system of pits is used in connection with a collecting-well. The residue flows from the distilling apparatus into the filtering pits *a* (Fig. 39b). The substance is retained here while the water charged with the sol-

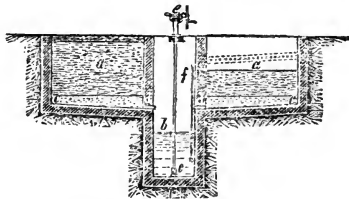

Fig. 39b.3

uble nutritive substances contained in the residues enters through the filtering layer *c* and the pipe *d* into the collecting-well *b*, where, by means of the stirring apparatus *e*, it is mixed with a suitable alkali, and neutralized to a weak alkaline reaction. This water containing in solution more than $\frac{1}{2}$ of the nutritive substances contained in the residues is used as ordinary feed water of the boiler of the distillery, to which it is conveyed by the suction-pipe *f* of a pump. When it has obtained the desired percentage of nutritive substances it is used for scalding feed, and the animals are fed with this either with or without an admixture of the dry substance of the residues.

When the pit *a* is full it is covered with several layers of hard burnt bricks, which, after a few days, are covered with clay or potter's clay, to protect the dry substance as much as possible from oxidation by excluding the air.

The water from starch factories is also concentrated and the concentrated fluid is used for scalding and changing the pulp into paste, whereby it becomes suitable to be used as an addition to mashes or, directly, as cattle-feed.

The waste-water containing nutritive substances of breweries, sugar houses, etc., may be concentrated and utilized in a similar manner.

To Preserve Hops. Press the hops,

as soon as dry, into wooden boxes made air-tight with rosin or pitch, close the box hermetically, and do not open it until the hops are to be used.

To Preserve Meat. I. Wrap the flesh in a cover of gelatine or parchment paper made insoluble by treatment with potassium bichromate.

II. To preserve meat to be used as food, *Wickersheimer* has patented the following process: A solution of 36 parts of potash, 15 parts of common salt, and 60 parts of alum in 3000 parts of water, is heated to 120° F., then mixed with another solution of 9 parts of salicylic acid in 45 parts of methyl alcohol, to which have been added 250 parts of glycerine. The animal to be preserved is injected with this fluid before it is opened. For smaller animals 100 parts of the fluid are used for every 1000 parts of dead weight, while larger animals require less. In small animals, as fish, fowl, etc., the fluid is injected before they are killed directly into the heart with a syringe provided with a sharp point, while in large animals it is injected after they are killed into one of the cervical arteries. For cattle and pigs 2 to 3 parts of saltpetre must be added to the fluid. The meat of animals thus treated keeps perfectly fresh for 2 to 3 weeks. If it is to be preserved for a longer time more methyl-alcohol must be used, and 12 parts of salicylic acid instead of 9 parts, and 450 parts of glycerine instead of 250 parts. To preserve animal substances *not* to be used for food the following solution is used: Eighty parts of potash, 60 parts of common salt, 30 parts of saltpetre, and 160 parts of alum in 6000 parts of water. The solution is heated to 120° F., and compounded with a solution of 18 parts of salicylic acid in 600 parts of methyl-alcohol, and finally 60 parts of carbolic acid and 1800 parts of glycerine are added.

III. Inject the meat with a saturated solution of boracic acid in cold water, and sprinkle pulverized boracic acid over it. The effect of the solution is increased by an addition of some common salt and saltpetre, which helps especially to preserve the natural appearance of the meat. The meat treated

thus shows no sign of decomposition, and no change can be detected even by a microscopical examination.

IV. Excellent results have been obtained by using powdered acetate of sodium. The meat is placed in a barrel and the acetate put in, when it is left for 48 hours. Thus prepared, it is said, the meat will keep for any length of time, and will be ready for cooking by soaking for 12 hours in water, to every 1000 parts of which 7 parts of sal-ammoniac are added.

V. Meat and other organic substances can be preserved by adding to them a minute quantity of fuchsine. Pieces of beef enveloped in blotting-paper soaked with gelatine and fuchsine were found to keep unaltered. By being soaked in water for 24 hours the beef became perfectly fresh, and furnished a soup in which no disagreeable flavor could be detected.

To Preserve Meat and Vegetables for some time put a small quantity of cleansed iron filings in a pot, pour clean boiled water over them, then put in the meat or green vegetables, so that the water stands over them, and, to prevent the access of air, pour a layer of oil upon the water. According to many experiments made meat treated thus preserved its good taste for seven weeks and had the appearance of being recently killed. Vegetables can be treated in the same manner without injury.

To Preserve Milk. I. Add to milk evaporated to $\frac{1}{2}$ its volume at a temperature of 100° to 120° F., in a vacuum, a solution of benzoate of magnesium and preserve the mixture in hermetically-closed vessels.

II. The addition of a small quantity of boracic acid to milk retards the separation of cream, and the milk retains its sweetness for several days.

To Preserve Vegetables and Fruits. Dissolve 1 part of common salt in 100 of water, boil the solution and heat the steam evolved by it to a temperature of 200° to 400° F., according to the vegetable substance to be treated, and expose the latter to the superheated steam 5 to 18 minutes. Such vegetable matters as albumen, caseine, chlorophyl, bassorin (vegetable mucus) are dissolved and float on the surface, from

which they are afterwards removed by means of clear, running water. The vegetables and fruits as soon as dry are pressed and packed. For many plants it is better to place them in brine composed of 1 part of common salt and 35 of water, which, by the introduction of steam, is kept at a temperature of 400° F. For washing a vat is used, through which runs constantly a stream of pure water of a temperature of 40° to 50° F. Vegetables and fruits prepared in this way retain their color and taste for a very long time.

To Prevent the Formation of Mould on Fruit Jellies. Scatter upon the surface of the jelly a layer of pulverized sugar about $\frac{1}{4}$ inch thick, and tie up the jar with bladder or waxed paper.

Two New Kinds of Preservative Papers have recently been introduced in commerce. One is obtained by immersing soft paper in a bath of strong solution of salicylic acid in alcohol with as much water as it will bear without re-precipitating the acid, and then drying it in the air. This paper is used for wrapping up fruits, etc.

For the other paper, which is used as a protection against moths and mildew, it is best to use strong vanilla wrapping-paper, which is immersed in a bath and then dried by passing over hot rollers. This bath consists of 90 parts of tar-oil, 5 of crude carbolic acid containing phenole about one-half its volume, 20 of coal tar at a temperature of 158° F., and 5 of refined petroleum.

To Smoke Beef. Put the meat freshly killed and while still warm into a mixture of 1 part of pulverized saltpetre and 32 of common salt, work it thoroughly, and scatter upon it as much rye bran as will adhere to it, and then hang it, either with or without an envelope of paper, in the smoke-house. The empyreumatic constituents of the smoke are prevented by the bran from reaching the meat and drying it out too much. The meat thus treated has an excellent taste and appearance.

To Preserve Vine Proprs and Wine-Barrels by Impregnating the Wood. The purpose of impregnating vine proprs is a double one, namely, to preserve the proprs themselves, and by the different chemicals used in impregna-

tion to keep away insects injurious to the vine.

For Vine Proprs. Impregnation with Linseed Oil. The proprs are coated with linseed oil, to which enough pulverized wood-charcoal has been added to give it the consistency of oil-paint. This process protects the wood from rotting for a number of years.

Process with Preparations of Lime. The wood is first saturated with soap-water and then treated with a solution of a calcium salt or immersed in an acid. The combinations of calcium sebrates separated in the wood itself, it is said, protect it against moisture and the attacks of insects. Diluted milk of lime is also claimed as an impregnating agent. Even lime slaked in a solution of calcium chloride is used as a wash for protecting vine proprs; or the wood to be impregnated is covered with burnt lime, which is gradually slaked with water. The wood remains in this 8 days.

Common Salt is the simplest impregnating agent. The wood, well seasoned, is either immersed in a strong solution of salt or painted with it. The part of the prop set in the ground is surrounded with a layer of salt which is gradually dissolved by earth moisture and absorbed by the wood. Wood thus treated, it is claimed, is not attacked by insects.

Solution of Sulphate of Copper. The posts to be impregnated are first pointed and then immersed in a solution of 3½ lbs. of sulphate of copper in 40 gallons of water. This process is especially adapted for soft and cheap varieties of wood, as acacia, pine, and, on account of their porosity, for larch, beach, cherry, poplar, alder, etc.

Coal Tar. A new process is as follows: Wood cut in winter and as well seasoned as possible is immersed for a quarter of an hour in the following mixture: To every 50 parts of coal tar boiling hot add 3 parts of common salt, 5 parts of sulphate of iron, 3 parts of alum, and 13 parts of rosin; mix thoroughly and boil the compound down to the proper consistency. As soon as the wood is taken from this compound a powder consisting of the following ingredients is spread over it: Coal cinders, very hard and thoroughly

burned, 50 parts, sulphate of iron pulverized 5 parts, lime pulverized 15 parts, and glass pulverized any desired quantity. The wood thus prepared is stored in a dry place.

Rosin. Heat 25 parts of rosin in an iron boiler together with 2 parts of linseed oil, and add with constant stirring 150 parts of white sand, and finally 1 part of sulphuric acid and a like quantity of oxide of copper ground fine. The whole is then intimately mixed and applied while still hot to the wood.

New Preservative for Wood, to prevent it from rotting, is prepared as follows: Boil in an iron boiler 4 to 8 parts of linseed oil with 50 of rosin, 40 of whiting, and 200 to 300 of sharp, white sand, and, when the paste is thoroughly boiled, add 1 part of red oxide of copper and 1 part of sulphuric acid; stir the mixture thoroughly and apply it while hot to the wood with a stiff brush. The coating dries immediately and forms an indestructible crust as hard as stone.

To Restore the Original Natural Color of Old Parquet Floors. Boil 1 part of calcined soda for $\frac{3}{4}$ hour with 1 part of slaked lime and 15 of water; mop the floor with the caustic soda lye thus obtained. When nearly dry scrub the floor with a hard brush and fine sand and water in order to remove the old wax and all other impurities. Next mix 1 part of concentrated sulphuric acid and 8 of water and apply the mixture to the floor. The sulphuric acid revivifies the color of the wood by forming a combination with the brown substance and the earthy parts which may have penetrated into the wood. When the floor is dry scrub it once with water, and when dry wax it in the usual manner.

SEALING-WAX AND WAFERS.

Good sealing-wax should be smooth, glossy, and not brittle; when held in a flame it should melt without dropping or charring, and retain, after cooling, a certain degree of elasticity. Its color must not change by melting, the wax must not adhere to the seal, and the impression should be sharp and clear.

It is perfumed with benzoin, Peruvian balsam, mastic, musk, etc. An addition of 2 per cent. of benzoin and 1 per cent. of Peruvian balsam imparts a very agreeable odor to sealing-wax. The perfume can be much varied by an admixture of small quantities of essential oils, oil of peppermint and essential oil of almonds being especially efficacious.

The poorest qualities of sealing-wax are known as "parcel wax" and "bottle wax." The first is prepared from gallipot, turpentine, shellac, pulverized heavy spar, and pigments, and the latter of the same materials with the exception of shellac.

We give in the following a number of receipts for all kinds which have been tested and can be recommended.

Black (Fine No. I.) I. Venetian turpentine 183 parts, shellac 300, rosin 16.5, and the necessary quantity of lampblack mixed with oil of turpentine.

II. Shellac 1295 parts, bone-black 1085, chalk 245, rosin 630, turpentine 665.

Black No. II. Fifty parts of shellac, a like quantity of Venetian turpentine or rosin, and 25 parts of bone-black.

Black (Ordinary). Shellac 18 parts, Venetian turpentine or white rosin 10, whiting 8, and calcined lampblack 2.

Blue (Dark). I. Venetian turpentine 100 parts, rosin 33, shellac 233, mineral blue 33.

II. Shellac 1 part, Burgundy pitch $\frac{1}{2}$, dammar 1, Venetian turpentine $\frac{1}{2}$.

III. (*Very Light*). Bleached shellac 157 $\frac{1}{2}$ parts, turpentine 525, mastic 385, calcined mica 350, ultramarine 262 $\frac{1}{2}$.

IV. (*Very Dark*). Bleached shellac 122.5 parts, turpentine 210, Spanish chalk 105, mastic 752.5, calcined mica 70, cobalt blue 420.

Brown. I. Shellac 1068 parts, rosin 560, cinnabar 175, turpentine 910, gypsum 525, lampblack 122.5.

II. Shellac 1085 parts, rosin 665, red bole 140, turpentine 840, gypsum 490, minium 140.

Brown (Dark). Venetian turpentine 133 parts, shellac 250, brown rottenstone 50, and magnesia mixed with oil of turpentine 5.

Brown (Light). I. Venetian turpentine 133 parts, brown mineral color

33, whiting 16.5, shellac 250, cinnabar 16.5, magnesia 3.

II. Venetian turpentine 133 parts, shellac 233, rosin 100, rottenstone 50, cinnabar 8, whiting 33, and magnesia 3.

Crimson. Venetian turpentine 66.5 parts, shellac 133, colophony 33, carmine 50, magnesia mixed with oil of turpentine 3.

Gold. I. Shellac 1260 parts, turpentine 1295, rosin 700, mastic 35, Dutch gold cut up fine 70.

II. Shellac 6 parts, white rosin 2, and silver leaf 1. The brown color of the resins imparts a golden tint to the silver.

III. Shellac 1085 parts, rosin 1015, turpentine 1120, chrome-green 35, magnesia 17.5, gold leaf 87.5.

Green. I. Shellac 980 parts, turpentine 560, rosin 525, gypsum 315, mineral blue 420, massicot 560.

II. Shellac 1295 parts, rosin 315, turpentine 910, chalk 420, chrome-green 420.

Red (Very Fine No. I.). 1. Venetian turpentine 133 parts, shellac 233, cinnabar 83, chalk mixed with oil of turpentine 3.

2. Shellac 100 parts, white rosin and prepared cinnabar each 50 parts.

3. Turpentine 1050 parts, shellac 1138 parts, oil of turpentine 26 parts, sparry gypsum 350 parts.

Red No. II. Venetian turpentine 133 parts, shellac 216, cinnabar 83, colophony 16, chalk rubbed with oil of turpentine 3.

II. Shellac 58 parts, Venetian turpentine 87.5, cinnabar 43, magnesia rubbed up with oil of turpentine 3.

Red No. III. I. Venetian turpentine 133 parts, rosin 75, shellac 200, cinnabar 58, chalk rubbed up with oil of turpentine 3.

II. Shellac 1200 parts, oil of turpentine 66.5, chalk 100, turpentine 650, calcined sparry gypsum 150, magnesia 200, cinnabar 866.5.

III. Shellac 884 parts, turpentine 1166.5, chalk 500, fine gypsum 333, cinnabar 216.5.

Red No. IV. Venetian turpentine 133 parts, shellac 200, rosin and cinnabar each 50, chalk rubbed up with oil of turpentine 3.

Red No. V. Venetian turpentine

133 parts, shellac 183, rosin 50, cinnabar 40, chalk rubbed up with oil of turpentine 3.

Red (Ordinary). I. Shellac 533 parts, rosin 266.5, turpentine 666.5, gypsum 133, cinnabar 833.

II. Shellac 910 parts, rosin 770, turpentine 1050, chalk and cinnabar each 315.

Rose Color. Shellac 61 parts, Munich lake 4, tin-ash 17.5, flake-white 52, white flake (the finest white lead) 17.5.

Violet. Shellac 245 parts, turpentine 122.5, mineral blue 79, white flake 52, flake-white 35, Munich lake 9.

White. Bleached shellac 560 parts, turpentine 280, Spanish chalk 192.5, magnesia 17.5, flake-white 245, white lead 350.

Yellow. I. Venetian turpentine 3 parts, shellac 3½, elutriated massicot 3.

II. Venetian turpentine 66.5 parts, colophony 41.5, shellac 133, massicot 24.5, magnesia rubbed up with oil of turpentine 2.5.

III. Shellac 1085 parts, rosin 700, turpentine 560, gypsum 175, minium 507.5, magnesia 35, and chrome-yellow 297.5.

Transparent Sealing-wax. The best quality of bleached shellac and other materials must be used for making this kind of wax. A mixture of bleached shellac, mastic, and very fine, viscid, light-colored turpentine gives the transparency. In the following we give several receipts for preparing the ground mass for transparent sealing-wax, which may be colored as desired by mixing with suitable coloring matters:

I. Bleached shellac 30 parts, turpentine 30, mastic 60, chalk 20.

II. Bleached shellac 30, turpentine 35, mastic 40, and zinc white 20.

III. Bleached shellac 15, turpentine 20, mastic 25, sulphate of barium or nitrate of bismuth 30.

Gold or Silver Transparent Sealing-wax is obtained by mixing finely pulverized leaf-metal with one of the above ground masses.

Aventurine Sealing-wax. This beautiful variety of transparent sealing-wax is obtained by stirring finely powdered yellow or bronze-colored mica into one of the above ground masses.

Parcel Sealing-wax. Light Red.

Common rosin 1120 parts, turpentine 280, better quality of rosin 280, chalk 840, and brick dust 840.

Dark Red-brown. Rosin 1540 parts, chalk 420, turpentine 875, bole 560.

Light Red-brown. Common rosin 1120 parts, better quality of rosin and turpentine each 280, chalk and colcothar each 980.

Very Dark Brown. Shellac 1120 parts, turpentine 525, pitch 455, chalk 735, umber 560.

Cheap Parcel Sealing-wax. Heat 333 parts of ordinary turpentine, melt in this 500 parts of shellac, and add minium sufficient to give a fine color.

Another Receipt. Shellac 133 parts, rosin 1.5, turpentine 83, cinnabar 0.8, chalk 100.

Melt the shellac and turpentine over a moderate fire and stir into the mixture the chalk and cinnabar previously mixed together. When the compound is cooled off so far that a portion taken out with the stirring implement can be handled without sticking to the fingers roll it out into sticks upon a board without wetting the board or the hands.

Bottle Sealing-wax. Melt together white pitch 2 parts, yellow wax and pine resin each 4, and turpentine 2.

Or: Pine resin 10 parts and yellow wax and turpentine each 2.

The mixture is colored *red* with 2 parts of red ochre; *green*, with Berlin blue and chromate of zinc each 1 part; *blue*, with ultramarine 2 parts.

Black. I. Black rosin 6 parts by weight, wax $\frac{1}{2}$, lampblack $\frac{1}{2}$.

II. White pitch 2 parts, yellow wax and pine rosin of each 4, turpentine 2, bone-black 1.

The following receipt gives the best mixture for hermetically closing bottles containing alcoholic beverages: Melt 2 parts of yellow wax and then add 4 each of rosin and pitch. When the whole is thinly fluid, dip the neck of the bottle in the compound and turn it horizontally. Some wine merchants in Champagne give more transparency and a finer color to the mixture by adding 2 parts of shellac.

Bronze Sealing-wax for Bottles. Melt 1000 parts of colored bottle sealing-wax over a moderate fire and add 100 to 200 of pulverized mica or bronze powder.

Substitute for Bottle Sealing-wax.

Mix gypsum 40 parts, white cement 60 parts, chalk 30 parts, dextrine 20 parts, spirit-varnish 500 parts, and sufficient coloring matter to give the desired color. Dip the necks of the bottles into the mixture and let them dry.

WAFERS. There are two modes of manufacturing wafers. *a.* With wheat flour and water for the ordinary kind, and, *b.* with gelatine. The manufacture presents no difficulty. The tools required are, 1, a species of waffle iron, consisting of 2 plates of iron which come together like pincers, leaving a small space between them; and, 2, annular punches of different sizes, with sharp edges to cut the prepared paste into wafers.

White Wafers. Grease and slightly heat the iron plates and fill them with a thin dough made of the finest white flour and water, close and expose them to a charcoal fire. When cooled off, open them and remove the thin dry cake and punch out the wafers.

Colored Wafers are prepared in the same manner except that the coloring matter is mixed with the dough, and the flour need not be absolutely white. The coloring matter must be readily soluble in water, devoid of any unpleasant taste or of injurious effects, forbidding the use of most metallic salts or oxides and certain vegetable substances. If the coloring substances cannot be dissolved in water, they must be converted into an impalpable powder.

Black Wafers are produced by adding some finely-pulverized lampblack or Chinese ink to the dough.

Red, and Rose Color, by more or less concentrated decoction of madder or Brazil wood, or more beautiful with an infusion of finely pulverized cochineal brightened with some alum.

Yellow Wafers are obtained by coloring the dough with a decoction of weld or turmeric, but saffron furnishes the finest product.

Blue Wafers. Color the dough with finely pulverized Berlin blue, or a blue liquor obtained by adding a few drops of a solution of sulphate of iron to one of ferrocyanide of iron.

Violet Wafers are produced by adding a mixture of red and blue to the dough,

Gelatine or French Wafers. Dissolve fine glue by itself, or mixed with isinglass, in water to a suitable consistency. Pour it upon a glass plate previously warmed with steam and slightly greased, which is fitted in a metallic frame with edges just as high as the wafers should be thick. A second plate of glass, heated and greased, is laid on the surface so as to touch every point of the gelatine, and resting on the edges of the frame. When the two plates of glass get cold the gelatine congeals, and may readily be removed. It is then cut with proper punches into wafers of different sizes.

The coloring matter should not be of a poisonous kind.

For Light Red Wafers, mix the boiled gelatine with fine English minium rubbed up in whiskey; for *medium red,* with Chinese cinnabar rubbed up in whiskey. For all *dark colors* it is necessary to determine the amount of coloring matter by experiment, as, when too little is taken, the color is not sufficiently fiery, and if too much, the wafers lose their lustre and adhesiveness.

For Transparent Red Wafers, decoction of Brazil wood brightened with some alum may be used.

For Yellow, an infusion of saffron or turmeric is recommended, but a decoction of weld, fustic, or Persian berries can be used.

For Blue Wafers, sulphate of indigo partially saturated with potash is used, and this mixed with yellow for the greens.

English Metallic Wafers consist of very thin leaf-metal glossy on the surface and the lower side provided with a sticky substance. The leaves are passed between two rollers, one having a smooth and the other a somewhat rough surface. To the latter the following mixture is applied: Glue 16 parts, gum-Arabic 4, syrup 5, spirit of wine 3, camphor 1, virgin wax 1, and distilled water 12. The ingredients are placed in a glass flask hermetically closed, and heated for 8 hours in a sand-bath at a temperature of 210° F. The solution is then filtered and diluted with one of 1 part of alum in 15 of water, keeping the temperature somewhat below the boiling point. When

dry, the prepared leaves are cut with proper punches into wafers of different sizes. The smooth surface may be gilded or lacquered.

SHOE-BLACKING, DRESSINGS, ETC.

1. Good blacking will preserve the leather soft and flexible and show a gloss with slight rubbing, not dimmed by exposure to ordinary moisture. It should be applied in a thin layer. Bone-black is almost universally used as a colorant, but as it contains only 9 or 10 per cent. of carbon to a large per cent. of phosphate of lime, it must be freed from the latter constituent to prevent the black from having a gray tinge, which is done as follows: Pour 3 parts of pure concentrated hydrochloric acid over 10 parts of bone-black, and work into a paste with a spatula. Let it stand for 24 hours, then add 50 parts of boiling water, and stir into a thin mixture and let it settle. The clear fluid is then drawn off, and the sediment mixed intimately with 2½ parts of sulphuric acid. The mixture is allowed to stand for 24 hours. Then add 50 parts of boiling water, stir thoroughly, let it settle and pour off the clear fluid. The residue of bone-black is now thoroughly disintegrated, is nearly free from acid, not injurious to leather, and furnishes blacking of a deep-black color.

Lampblack and Frankfort black are also used as pigments in the manufacture of blacking, but neither can replace bone-black, at least not without a large addition of other substances to give gloss.

If the object is to give to the blacking a beautiful color without taking the cost into consideration, some freshly-precipitated Berlin-blue may be added. It gives to the blacking a bluish-black shade of a metallic lustre.

2. Every blacking must contain an agglutinant, which fixes the pigment upon the leather and takes a gloss by brushing.

It is best to use a mixture of 2 parts of molasses and 1 of glycerine. This combines the preserving qualities of the glycerine and the power of the molasses to give a good gloss.

3. As a third integral constituent of blacking, especially of such not containing glycerine, an addition of some substance is needed which will keep the leather soft and flexible. Non-drying fat oils, as olive oil, sesame oil, lard, fish oil, etc., are best to use.

Sesame oil, being cheap, must be preferred to olive oil. Lard is too dear, and readily becomes rancid. Fish oil is principally objectionable on account of its smell. Five to 10 per cent. of the weight of the bone-black of these oils is generally used. An addition of too much oil makes it difficult to give a gloss to the blacking, and besides the dust adheres so tightly to the shoes or boots as to make it almost impossible to remove it. If the blacking contains glycerine, a very small percentage of oil will do, as glycerine alone keeps the leather soft and flexible.

4. *Mixing the Ingredients.* After the bone-black has been disintegrated by means of acid, add the substances giving gloss, then the oil, and finally sufficient water, beer, or vinegar to allow of the whole being mixed together.

We give below a number of receipts, most of which have been tested and can be recommended.

Caoutchouc Blackings. Receipt I. In the Form of Paste. Mix bone-black 20 parts, molasses 15, vinegar and sulphuric acid of each 4, and caoutchouc oil (see below) 3.

Receipt II. In Fluid Form. Bone-black 60 parts, molasses 45, dissolved gum 1, vinegar 50, sulphuric acid 24, caoutchouc oil 9.

Caoutchouc Oil is prepared by digesting, with the assistance of heat, 55 parts of caoutchouc in 450 parts of rape-seed oil.

Cordova Blacking. This blacking deserves special recommendation for blacking shoes, boots, harness, etc., as it contains neither hydrochloric nor sulphuric acid. Mix: Vinegar 1500 parts, beer 500 parts, good cabinet-makers' glue 250 parts, sumac 60 parts, isinglass 4 parts, indigo 2 parts, and let the whole boil slowly for $\frac{1}{2}$ hour. Strain, after cooling, and apply with a sponge.

Dressing for Dancing Shoes. Gum-Arabic 1 part, loaf sugar and bone-black each $\frac{1}{2}$, and sufficient water.

Dissolve the gum and the sugar, triturate the bone-black with the solution, and apply the fluid with a sponge.

Dressing Free from Sulphuric Acid. Boil for $\frac{1}{4}$ hour: 1 part of extract of logwood and 30 of gall-nuts coarsely powdered, press out and strain the liquid, and add to it 8 parts of sulphate of iron. Let it stand for 24 hours, strain off the clear fluid, heat it moderately and stir into it 8 parts of gum-Arabic, 100 of rock-candy, and 80 of molasses. Strain the fluid again, and add 50 parts of spirit of wine, 40 of a solution of equal quantities of shellac and pulverized indigo.

Dressing, equal if not superior to Paris dressing, is prepared as follows: Boil for half an hour 20 parts of bruised gall nuts and 10 parts of logwood in 500 parts of water or wine, then strain and add to the liquor 10 parts of sulphate of iron and $2\frac{1}{2}$ parts of sulphate of copper, and allow the whole to stand 12 hours. The next day the clear fluid is drawn from the sediment and heated, and 90 parts of gum-Arabic dissolved in it, and finally 60 parts of syrup and 150 parts of spirit of wine are added. The dressing is applied with a brush and brushed.

Another Receipt. Boil in 200 parts of water 20 parts of soap and 10 parts each of sulphate of iron, starch, and powdered gall-nuts, strain off the fluid and add to it 30 parts of disintegrated bone-black and 60 parts of syrup.

This dressing acquires great gloss and is certainly not injurious to the leather.

English Water-proof Blacking. Stir 60 parts of bone-black into 45 parts of molasses, and pour over it 12 parts of vinegar, and stir in gradually 12 of sulphuric acid. Let it stand for 7 days, and then add 9 parts of caoutchouc oil and keep the finished blacking in jars.

The caoutchouc oil is prepared by melting 1 part of caoutchouc cut up in pieces in an earthen pot over a coal-fire, and mixing with it 6 to 8 parts of linseed oil, stirring constantly.

Fluid Blacking, a Substitute for Ointment and Lacquer. Make a mixture of 500 parts of asphaltum and 500 of petroleum, to which add first 60 parts of linseed-oil varnish, next 140

parts of train oil, and finally 130 parts of alcohol.

French Paste for Patent Leather. To preserve the gloss of patent leather the following preparation is used: Melt pure wax over a water-bath. Place it on a moderate coal-fire, add first some olive oil and then some lard, and mix intimately by stirring. Then add some oil of turpentine, and finally some oil of lavender. The resulting paste is filled in boxes, where, on congealing, it will acquire the requisite consistency. Apply a little of it to the shoe or boot, and rub with a linen rag, which will restore the gloss to the leather and keep it soft and prevent cracking.

Good Shoe-blackening. Mix 2 parts of olive oil with 15 of syrup, then mix 1 part of sulphuric acid with 75 of stale beer. Pour the two mixtures together, and add 15 parts of bone-black and 4 parts of indigo triturated with beer. Boil the whole for about 10 minutes.

Another Receipt. Mix 6 parts of fine bone-black, 28 of syrup, 4 of sugar, 3 of train oil, and 1 of sulphuric acid; let the mixture stand for 8 hours, then add, with vigorous and constant stirring, 4 parts of decoction of tan, 18 of bone-black, and 3 of sulphuric acid, and pour the compound into boxes.

Gutta-percha Blackening. a. Dissolve 20 parts of gum-Arabic in 1000 of water. Pour 50 parts of olive oil over 20 of gutta-percha cut in pieces, and melt, with constant stirring, into a uniform mass, and stir it into the dissolved gum-Arabic.

b. Mix intimately 200 parts of bone-black, 400 of lampblack, and 1500 of molasses. Melt the mixtures a and b together.

As will be seen from the receipt the preparation is entirely free from acid, and cannot injure the leather in the least. The addition of gutta-percha causes the leather, after repeated treatment with this blackening, to become nearly water-proof.

Hardeg's Leather Ointments. I. Melt and mix: Yellow wax, oil of turpentine, olive oil, castor oil, each 25 parts, and linseed oil purified and boiled 50 parts, and add, with constant stirring, 37½ parts of pure wood tar.

II. Melt and mix: Yellow wax, oil of turpentine, and castor oil each 12½

parts, linseed oil purified and boiled 125, and tar 3½ parts.

Konrad's Celebrated Blackening. Melt in an earthenware pot: Lard 75 parts, train oil 8, tar 2, and colophony 2. When the mixture is homogeneous pour it upon 430 parts of sifted animal charcoal, mix them thoroughly, and add 30 parts of furniture polish and 70 of syrup.

Boil in another pot: Mountain ash berries 70 parts, rasped logwood 30, sulphate of iron 16, gall nuts 4, and verdigris 2, with rain-water 300; pour off the liquor and compound it with 12½ parts of alum. As soon as the liquor is cool add gradually and with constant stirring 3 parts of indigo dissolved in 25 of sulphuric acid.

This liquor is now poured in small quantities at a time upon the above mixture and intimately mixed with it by vigorous stirring. The pasty compound when cold is dried, rubbed fine, and then packed.

Ointment for Boots used by the Normandy Fishermen. Mix 50 parts of good linseed oil, 35 parts of spermaceti, 5 parts of yellow wax, and 3½ parts each of pitch and oil of turpentine. Melt the whole in an earthenware pot over a moderate fire, care being had to prevent the mixture from igniting. The compound is rubbed into the leather and then dried by exposure to heat.

Shoe-blackening from Potatoes. Boil in a suitable vessel 10 parts of potatoes chopped fine, and 1 of concentrated sulphuric acid until a black glossy mass has been formed. Then compound it with 4 parts of bone-black and a corresponding quantity of train oil; stir thoroughly and form into cakes.

Water-proof Blackening. Mix 60 parts of bone-black with 45 of syrup; dilute the mixture with 12 parts of strong vinegar, and then add gradually and with constant stirring 12 parts of sulphuric acid. Let the whole stand for 7 days, and then mix it with 9 parts of caoutchouc oil.

Water-proof Ointments for Shoes and Boots. I. Green wagon grease 3 parts, lard 1, and wall-wort (*Symphytum officinale*) ½ part. The wall-wort is chopped up very fine and boiled to a thick paste with water, and then pressed so that the fibrous parts remain behind.

Should the leather be very hard more wall-wort must be used.

This composition makes the leather water-proof, soft, and gives it almost incredible durability. The boots are first moistened with warm water and then thoroughly impregnated, especially the soles and seams, with this paste, and allowed to dry slowly either in the sun or near a stove. This is repeated at least every two weeks, although it is then sufficient to moisten only the soles and seams. Boots treated in this manner can be polished with ordinary blacking.

II. Melt in an earthenware pot over a moderate fire 6 parts of spermaceti, add 12 parts of caoutchouc cut up in strips, and when this is dissolved 12 parts of tallow, 4 of lard, and 8 of amber-varnish. Mix the whole intimately, and the compound is ready for use. Apply it twice or three times to the shoes with an ordinary blacking brush. It renders the leather water-proof and gives it a fine gloss.

To give to the Soles, after Scraping, a Smooth and Beautiful Appearance. Dissolve 1 part of stearine in 4 to 5 of benzine. Apply the solution to the soles, and, when dry, rub smooth with a linen rag.

Another solution well adapted for the same purpose is obtained by melting together 5 parts of stearine with 1 of white wax. Rub the soles, after scraping, with this compound, and smooth with a clean cloth.

For Hemlock Leather Soles the following mixture is used: Alcohol, saturated solution of sodium hyposulphite, and hydrochloric acid, equal parts.

To Prevent Boots and Shoes from Squeaking, rasp with a coarse rasp the outsole and insole, and every other piece of leather that is moved by the action of the foot. Then apply freely good wheat or rye paste. If this is well attended to from heel to toe, the boot or shoe will not squeak.

How to Make Water-proof Boots. For 3 pairs of boots cut 3 ounces of caoutchouc in small pieces, place them in a pot over a fire, and add oil of turpentine sufficient to form a stiff paste. Great care must be observed, as the mass ignites easily. By diluting the compound with 1 pint of boiled linseed-

oil an ointment of the consistency of yolk of egg is obtained.

The uppers of a pair of boots are first soaked in a tub with hot water and brushed while in the water, until the pores are thoroughly opened and entirely free from lime. They are then shrunk, dried, and cut somewhat larger than the measure. The uppers are then greased with the compound, lined with soft leather consisting of 2 parts sewed together in the centre, and stretched over the last. The upper is then turned up and the lining brushed over with the water-proofing compound. The upper is then drawn over it and tacked. The peg-leather is filled out with leather and the inner sole burned in with pitch, care being had that the leather forms a close union with the pitch on all points. Finally the soles are sewed on. Boots thus made are entirely water-proof, so that, even if the sole is broken, water cannot penetrate; but in this case they should be half-soled before the inner sole is injured.

SIZING AND DRESSING FOR COTTON, WOOL, STRAW, ETC.

Back's Improved Size and Dressing for Linen, Cotton, and Woollen Goods. The sizing of yarn and dressing the finished goods is well known to be one of the most difficult operations in the production of linen, cotton, and woollen goods. The greatest difficulty lies in the preparation of the size, which contains generally too much glue and mucous constituents, thus rendering the working of the yarn more difficult. For this reason we give here a peculiar method of preparing a size and dressing which, it is claimed, possesses all the qualities demanded.

1. *Size.* Boil 100 parts of ordinary peas in 400 parts of soft water, allow it to cool and then add 25 parts of the sticky buds of the balsam poplar and allow the whole to come once to a boil. The compound is then allowed to stand for 24 hours, and the supernatant clear fluid may then be used for sizing.

2. *Dressing.* This is prepared in the same manner, but the proportions are as follows: Water 600 parts, peas 50

parts, and buds of balsam poplar 25 parts. Apply the fluid by means of a sponge to the plain or dyed goods, pile them up over each other for 36 hours, then stretch them in a frame and dry in the air. Size and dressing must be prepared fresh every time, as, by exposure to the air, they become sour, and decompose in a short time.

Dressing and Size. The compound can be prepared in solid or fluid form, perfumed or not. To prepare it in fluid form take: Glycerine of 2° Beaumé 1000 parts, sodium carbonate and gelatine each 10 parts, alum and borax each $\frac{1}{2}$ part. Mix intimately to a homogeneous fluid compound. To prepare it in solid form mix different proportions of gelatine, hog-fat soap, stearine, gum-Arabic, or gum tragacanth, with varying proportions of borax, soda, and alum. To perfume the compound dissolve 1 part each of oil of peppermint and oil of lavender and 2 parts of camphor in 40 parts of alcohol, and add 1 part of the solution to the above-described fluid.

Eau de Crystall. This size consists of sulphate of magnesium, chloride of magnesium, and dextrine. The varieties found in commerce contain:

	Ordinary quality. per cent.	Good quality. per cent.
Water	50	51 to 52
Sulphate of magnesium	36 to 38	42 to 48
Chloride of magnesium	to 1.5	
Ferric oxide	traces.	
Sulphate of sodium	to 5.04	
Sulphate of calcium	to 0.62	

Glycerine and its Use in Sizing and Dressing. To load and oil the wool the following mixture is used: Rosin and aqua ammonia free from lime each 1 part by weight and water 10 parts by weight are mixed, filtered through a cloth, and half the quantity by weight of fat oil added, and then the whole quantity by weight of glycerine. This mixture is reduced half with water and used for oiling the wool. It is also much used as a solvent for aniline colors, being capable of dissolving a larger quantity of them and at a lower temperature than alcohol. Its power of dissolving albumen makes it especially adapted for calico-printing. Solutions

of albumen in glycerine keep for a long time and are not decomposed even at 158° F. We give in the following a few receipts for dressing with glycerine:

1. *For White Goods.* 1. Water 20 parts, gelatine 6, glycerine 2.
2. Starch 2 parts, glycerine 3.
3. Kaolin 9 parts, sulphate of calcium 5, glycerine 2.
4. Kaolin 8 parts, dextrine 7, glycerine 4.

A mixture brought into commerce under the name of "polykoll" or "parmentine" consists of 100 parts of gelatine, 70 of dextrine, 20 of glycerine, and 21 of sulphate of zinc; or, grape sugar 10 parts, Epsom salts 15, glycerine 5, saltpetre $1\frac{1}{2}$, dissolved in water, and diluted to 6° Beaumé.

For sizing the following mixtures are used: 1. Glycerine 12, dextrine 5, sulphate of aluminium 1, water 30.

2. Dissolve 5 parts of glue in 50 parts of boiling water. Pour the solution into 500 parts of glycerine of 20° Beaumé and add a solution of 5 parts of soda. An addition of a small quantity of carbolic acid prevents decomposition of the mixture.

3. A compound glycerine sizing liquid is prepared from glycerine 100 parts, soda 1, gelatine 1, white starch 10, alum 1100, and borax 1100. The hardening of cotton yarns is also conveniently prevented by an immersion in a glycerine bath.

New Preparation, called Glutine, used for giving Gloss to Wall Papers, and as an Inspissation for Dyeing and Printing Purposes. Press caseine, generally known as curd, through rollers revolving towards each other, to free it from fluid, and convert into a coarse powder. Triturate the powder with 1 part of sodium tungstate, or pass the compound through the rollers to effectually crush the smallest particle of caseine, for as soon as the solution comes in contact with the caseine reaction begins and the compound becomes tough. Caseine containing much buttermilk is mixed with hydrochloric acid and water, and then repeatedly washed with water, until all reaction has ceased, when it is pressed out and treated as above. The caseine and soda solution are stirred in a boiler over a water-bath until the caseine is

fully dissolved, and add a little carbolic acid and a few drops of oil of cloves. When all is melted pour the compound out, which on cooling will form a more or less solid mass, according to the quantity of water used. The glutine is soluble in water in every proportion, possesses great adhesive power, and furnishes an excellent paste for fastening labels on tin, glass, and porcelain. When once dry it resists moisture quite well, and gives to dull wall papers, printed with mineral or metallic colors, a beautiful glossy coating, which is made more flexible by an addition of a little glycerine. Gelatine dissolved in glycerine produces a beautiful, tenacious compound, which gives to paper a flexible enamel, that on being passed through a solution of alum resembles leather. Glutine with decoction of dye wood gives, on account of its percentage of tungstic acid, various tints of colors. Steeping cotton or linen in a solution of glutine, then dried and drawn through a decoction of logwood, receives a violet color; by drawing them through acids or solutions of mineral salts fast colors of various shades are obtained.

New Size. Treating starch with soda-lye produces a paste which is used for sizing, and sold under various names. One disadvantage of this compound is that it is always more or less alkaline. It is claimed that otherwise it would lose its efficiency. Chloride of magnesium has been recently substituted for the soda-lye. Add 100 parts of chloride of magnesium to a sufficient quantity of boiling water to dissolve the starch, and in a short time draw off the clear liquor, to which is added 1 part of hydrochloric acid, and then 100 parts of starch are thrown in, and the compound brought to the boiling point. After the mixture has been kept at a temperature of 195° F. for about 1 hour, clarified lime water is added to neutralize it. The boiling is repeated once more, and the resulting artificial glue is, in case it is to be stored, poured into moulds, and allowed to congeal.

Preparation of Artificial Gum to be used in Place of Gum-Arabic. Place in a boiler, water equal to 6 times the weight of the starch to be added and heat it to about 86° F., and stir in 20

parts of wheat starch, then 100 parts of potato starch, 20 parts each of sago and crushed malt. Heat the mass over a water-bath until a gummy compound is formed, requiring generally 1 hour after adding the crushed malt. The operation is not complete as long as a drop of the gum mixed with tincture of iodine shows a blue color; when it shows a reddish-violet color reduce the temperature of the gum mixture to 212° F. by shutting off the steam. The solution is then allowed to stand for 1 hour, when it is filtered through a woollen cloth. It is then concentrated by bringing it into another vessel and heating by means of steam-pipes to expel the water. If it is desired to obtain the gum in a dry state the compound is divided into small pieces and dried.

Preparation of Blood Albumen. The principal requisite in preparing blood albumen is that the working-room should be located as close as possible to the slaughter-house, as the quicker the coagulated blood is cut and placed upon the sieves the brighter and purer the serum drains off. The blood is cut up in pieces of about 1 cubic inch, placed upon sieves, and allowed to drain off 40 to 48 hours. At first the serum is red on account of corpuscles of blood being mixed with it, but in about 1 hour it drains off perfectly clear. After the time stated above the clear fluid is drawn from the red sediment into wooden vats having a capacity of 40 to 60 gallons. From the serum "*natural albumen*," without gloss, and "*patent albumen*," with gloss, are prepared.

To manufacture *natural albumen* add 12½ parts of oil of turpentine to 5000 parts of serum, and agitate the mixture for 1 hour by means of a perforated board provided with a handle. The oil of turpentine forms ozone, which has a bleaching effect; it withdraws also a mucous fat from the serum and acts as a preservative. The mixture is then allowed to stand quietly for 24 to 36 hours, and the clear serum is then drawn from the sediment. The drying is accomplished in iron cups coated with oil-paint and lacquer burned in. The cups are about 12 inches long, 6 inches wide, and ¾ inch deep. The temperature of the drying-room at the start must be about 122° F., and is

gradually raised for 2 hours to 125° to 130° F. It is then lowered to 100° to 105° F., and kept there for 34 hours, when the drying is finished.

To Prepare Patent Albumen add to 5000 parts of serum 12 parts of sulphuric acid mixed with 22 parts of concentrated acetic acid and 336 parts of water, and then add 14 parts of oil of turpentine and agitate for 1 hour. The whole is then allowed to stand quietly for 24 to 36 hours, when the clear serum is drawn off, neutralized with ammonia, and dried. Fifty thousand parts of serum give 5000 parts of dry blood albumen.

A second quality of albumen is prepared from the serum colored red by blood corpuscles and the sediment, and a third quality by lixiviating the blood with water. The remaining blood is comminuted and dried in sheet-iron pans at a temperature of 143° to 167° F.

Preparation of Dextrine. Dilute 4 parts of nitric acid of 36° to 40° Beaumé with 600 of water, and pour the mixture over 2000 parts of dry potato starch; mix thoroughly and dry. When the evaporation has progressed so far that the cakes can be easily broken crush them with a shovel and spread the starch upon the floor of the drying-room in a layer $\frac{1}{2}$ to 1 inch deep. The temperature should be kept at 230° to 240° F., and the dextrine will be finished in 1½ hours. It will remain white if not exposed to too high a temperature.

Process of Sizing all Kinds of Tissues with Alkaline Solutions of Silk, Wool, or Feathers. Dissolve fibres of silk, wool, or down in caustic soda, and apply the solution to the tissues, which are then washed in a bath of sulphuric acid and carefully rinsed. Tissues thus treated may be bleached and dyed.

This process is used for loading woollen and silk yarns and tissues with an alkaline solution of wool or silk, and eventually to improve defective qualities. Mixtures of alkaline solutions of silk and wool, silk and down, etc., may also be used for coating all kinds of textile fibres.

Size for Bobbinet. The bobbinet, after bleaching, dyeing, and drying, is

stretched evenly in a machine. It is then brought into a closed room having a temperature of 98½° to 104° F., and coated several times with a cold size consisting of boiled starch and dextrine with an admixture of some gelatine or glue, until the desired degree of stiffness and gloss—the latter being produced by the temperature prevailing in the work-room—is obtained. The size is applied with brushes. Bobbinet thus prepared is equal to the English product. The size is boiled the day before, and cooled off to an ordinary temperature, say 68° F.

Size for Cotton Yarns. An improved size for cotton yarns, patented by H. Wegmann, consists of tallow, soft soap, rosin, sulphate of iron, and onions. Boil the rosin, sulphate of iron, onions, and tallow until sufficiently liquid, and add the mass to the soft soap melted in a tank with steam and hot water. Mix the ingredients thoroughly with steam, and add them to the starch or flour with sufficient water to make the sizing of the desired consistency.

Size for Cotton and Woollen Yarns, especially for dark colors. Liquefy 100 parts of glue and 20 parts of glycerine in water on the water-bath, and then add 5 parts of potassium bichromate. The compound, by reason of becoming decomposed by light, must be kept in the dark.

Size for Cotton. I. Flour 1250 parts, tallow 5 parts, paraffine $\frac{1}{2}$ to 2 per cent.; or, flour 1250 parts and 5 to 10 per cent. of paraffine. Add a little alkaline carbonate to both compounds. The materials are mixed with water, heated, and thoroughly mixed together.

II. Glue 600 parts, dextrine 400 parts, sulphate of calcium 500 parts, glycerine 5000 parts, chloride of lime 5 parts, spermaceti 500 parts, stearine 200 parts, starch-syrup and starch each 500 parts, carbolic acid 5 parts, and caustic soda 10 parts are thoroughly mixed.

Dressing Cotton Prints. I. Prepare the following decoction: Water 137 parts, wheat flour 5 parts, potato starch 15 parts, wheat starch 5 parts, cocoanut oil $\frac{1}{2}$ part. The goods are starched with covered starching rollers, dried

over drums, and strongly but uniformly moistened, being wound up very tightly at the same time. They remain upon the rollers for 10 to 12 hours, when they are unwound, folded, and pressed.

II. Mix $\frac{3}{4}$ part of pulverized gum tragacanth with spirit of wine and work it into a homogeneous compound, then digest this in 450 parts of water over a moderate fire, without allowing it to boil, until a liquid, slimy compound is formed, which is passed through a sieve. Now boil 150 parts of potato starch with about 1000 parts of water, and add to the boiling mixture $7\frac{1}{2}$ to $8\frac{3}{4}$ parts of alum previously dissolved in hot water. Then add the solution of gum tragacanth, stirring it in but not boiling it with the starch.

Glaze Dressing for Colored Cotton Goods. I. *Glaze on Black.* Weak liquor of logwood 1700 parts, potato starch 100 to 120 parts, wheat flour 50 to 60 parts, palm oil 10 parts, yellow wax and tallow each 5 parts. Compound the decoction with $\frac{3}{4}$ to $\frac{1}{2}$ part of potassium chromate, and then add solution of rosin 45 parts, and potato syrup $22\frac{1}{2}$ parts. Mix the whole thoroughly and use hot.

II. *Glaze on Black Goods when the Color is not sufficiently Deep and Dark.* Logwood liquor, to which some extract is added, 1700 parts, potato starch 100 to 120 parts, wheat flour 50 to 60 parts, palm oil 10 parts, yellow wax and tallow each 5 parts, acetate of iron $13\frac{1}{2}$ parts, sulphate of iron and sulphate of copper each $2\frac{1}{2}$ parts. The decoction is compounded with $\frac{3}{4}$ to $\frac{1}{2}$ part of potassium chromate and $1\frac{1}{2}$ parts of bluestone, and 45 parts of a solution of rosin and $22\frac{1}{2}$ parts of potato syrup are finally added.

Glaze on Blue and Green. Water 1700 parts, potato starch 100 to 120 parts, wheat flour 50 to 60 parts. The proportions of fat, rosin, and potato syrup are the same as for black. When the decoction is about half-cold compound it with $1\frac{1}{2}$ parts of tartaric acid dissolved in water, and finally darken it according to the desired tint with indigo-carmin, or, still better, with solution of potassium sulphate.

Glaze on Crimson Paper Muslin. Water 570 parts, liquor of Brazil wood 1700 parts, potato starch 100 parts,

wheat flour 50 parts. When half-cold add 2 to $2\frac{1}{2}$ parts of tartaric acid, and fine the decoction with $137\frac{1}{2}$ to 140 parts of vinegar. Use fat, rosin, and syrup in the same proportions as for black.

Glaze on Rose-colored Muslin. Water 1700 parts, potato starch 100 to 120 parts, wheat flour 50 to 60 parts, white cocoanut oil 5 to $7\frac{1}{2}$ parts, white wax and stearine each 5 parts. Compound with $1\frac{1}{2}$ to 2 parts of tartaric acid dissolved in water, and 115 to 135 parts of good wine vinegar.

Size for Laces. Boil $\frac{3}{4}$ part of borax and $3\frac{1}{2}$ parts of shellac with 1000 parts of water. The solution may be thickened with starch, gelatine, or isinglass. One part of the above solution and 1 part of gelatine solution give a very good size. For white laces bleached shellac must, of course, be used.

Size for Linen. I. *For Half-bleached Linen.* Boil by introducing steam: Wheat starch 5 parts, potato starch $2\frac{1}{2}$ parts, Utrecht white $4\frac{1}{2}$ parts, light glue $\frac{1}{2}$ part, until 80 parts of size are obtained.

II. *For Fine Holland Linen.* Fine white wheat starch 100 parts, potato starch 25 parts, fine mineral white $12\frac{1}{2}$ parts, soap and stearine each 5 parts, white wax $1\frac{1}{2}$ parts, and crystallized soda $\frac{1}{2}$ part are boiled by introducing steam, and then colored slightly with ultramarine.

For Table Linen and Damask. Wheat starch 50 parts, potato starch 8 parts, white glue 5 parts, stearine and white wax each $2\frac{1}{2}$ parts, white soap $1\frac{1}{2}$ parts, and crystallized soda $12\frac{1}{2}$ parts, are boiled by introducing steam.

Dressing for Panama Hats. The following lacquer is highly recommended for the purpose: Alcohol of 95 per cent. 200 parts, sandarac 100 parts, and oil of turpentine 20 parts, are digested for 10 days. The hat is coated twice with this lacquer inside and out.

Size for Petinet and Marly. The process of sizing petinet and marly, to give them sufficient stiffness, hardness, and glaze to adapt them for bonnet-frames is as follows: The bleached material is starched, then stretched in a frame and dusted while yet somewhat moist with fine starch flour by means of a hair sieve, so that the meshes re-

main free, but the powder adheres abundantly to the threads. The frame thus prepared is then placed in a tightly-closed box into which steam is introduced. The steam swells up the threads, they becoming in consequence adapted for an absorption of the dissolved starch, and that which is not absorbed is changed into a jelly, adhering tightly to the threads. The frame is then taken from the box and a fine current of cold water thrown over it until the starch jelly begins to dissolve, when the frame is replaced in the box and steam introduced until the starch is transparent, clear, and glossy. The frame is then taken from the box and dried.

Size for Woollen Goods, Cloths, and Flannels. Prepare a decoction of flaxseed, to which, for black or blue colors, some logwood liquor may be added. The decoction must be so thick that it draws threads like white of egg. It is then forced through coarse linen and applied with a brush. Dry linen moistened with weak soap-water is then placed upon the face of the cloth and ironed with a hot iron.

Sulphate of Barium has been for a long time used in sizing and dressing tissues. The old method consisted in adding sulphate of barium to the starch or animal or vegetable glue. This gave to the size a yellowish tint, injuring the whiteness of the tissues. The object of the new process is to remedy this evil. Mix in varying proportions, according to the strength and weight of the size desired: 1, Water; 2, starch, vegetable, or animal glue; 3, drying oil, castor oil, poppy seed oil, etc.; 4, sulphate of barium in a nascent condition, *i. e.*, in the act of formation. The most suitable proportions are as follows: Water 400 parts, starch 100 parts, castor oil 10 to 20 per cent. of the weight of the starch, chloride of barium 10 to 20 per cent. of the weight of the starch, and a sufficient quantity of ordinary sodium sulphate to completely decompose the chloride of barium by chemical reciprocal action. All the ingredients are mixed together and heated to form a paste. This process is still further facilitated by the fact that the chloride of barium and the sulphate of sodium can be mixed in

a dry state without fear of reciprocal decomposition.

Gerard's Apparatine is a colorless transparent mass prepared from potato starch with caustic soda or potash-lye, and used for dressing all kinds of fabrics. To prepare it take 76 parts of water, 16 of potato starch, and 8 of caustic lye of 25° B.; pour the starch into the water, and then add the lye, stirring constantly. The fluid clarifies suddenly, and gives a thick gelatine, which must be vigorously beaten. If dried in thin leaves it forms a hornlike substance, which can be folded together without breaking.

SOAP. HARD AND SOFT SOAPS, MEDICATED AND TOILET SOAPS, ETC.

American Rosin Soap. Place 1000 pounds of tallow, 200 pounds of crude palm oil, and 800 pounds of rosin in a boiler, and add about 4000 pounds of lye of 15° B. until a clear paste is formed, which is then thoroughly salted and allowed to stand about 3 hours, when the settled salt-lye is pumped or drawn off. Five hundred pounds of water and 250 pounds of lye of 8° B. are added to the boiler, and a fire started under it. Should the combination be incomplete after boiling, add enough lye of 15° B. until a clear soap is formed. The soap is again salted and boiled clear like other hard soaps. Draw the fire, and let the soap stand in the covered boiler for 3 days to let the impurities and under-lye settle. Uncover the boiler and remove the congealed crust, and ladle the clear soap into another boiler, and keep up the fire until a thick mass is formed, which is then ladled into frames of 1000 pounds capacity and thoroughly racked until nearly cold, and 36 pounds of dissolved crystallized soda stirred into each frame and the soap becomes solid. The soda solution consists of 150 pounds of crystallized soda in 5 pounds of hot water. The racking of the soap, after the soda has been added, must be continued as long as it is possible to do so, as the quality of the soap depends much on this. Soap which can be cut after 48 hours is very smooth and of a reddish-brown color.

If a lighter-colored soap is desired the crude palm oil is omitted, and 200 pounds of tallow and light rosin used instead. The pasty lye is freed from salt and used for the next boiling.

American Soaps. 1. Extra Soaps. *Basis:* Tallow 45 parts, kitchen soap-fat 5 parts, rosin 25 parts.

Filling: To every 500 parts of finished soap: Saponified rosin 50 parts, crystallized soda-lye of 37° to 38° Beaumé (lukewarm) 25 parts, water-glass 50 parts, carbonate of potash-lye of 40° B. (lukewarm) 5 parts, infusorial earth, talc, or marble dust 45 to 50 parts.

2. Superior Soaps. Basis: Tallow 12½ parts, kitchen soap-fat and rosin each 37½ parts.

Filling: To every 500 parts of finished soap: Saponified rosin and soda-lye of 37° to 38° B. each 50 parts, water-glass 90 parts, carbonate of potash-lye 7½ parts, infusorial earth, talc, or marble dust 60 parts.

3. Old English Soap. Basis: Tallow and kitchen fat each 25 parts, rosin 30 parts.

Filling: To every 500 parts of finished soap: Saponified rosin 20 parts, soda-lye of 37° to 38° B. 28 parts, water-glass 72 parts.

4. First Premium Soap. Basis: Tallow 12½ parts, kitchen fat and rosin each 37½ parts.

Filling: To every 500 parts of finished soap: Saponified rosin 75 parts, soda-lye of 37° to 38° B. 60 parts, water-glass 110 parts, potash-lye 15 parts, infusorial earth, talc, or marble dust 120 parts.

These rosin soaps are at first of a light-yellow color, but, on account of the large percentage of rosin, become gradually very dark and have a strong odor of rosin. Clothes washed with such soaps, when kept in a dark room, become yellow, and the hands, after using these soaps, feel rough. But the soaps, by reason of their cheapness, are much liked. They are pressed into bars weighing about 1 pound, which are sold at 4 or 5 cents.

Besides these cheap rosin soaps another soap known as "*Silex soap*" is manufactured. It is nothing but an ordinary tallow soap mixed by means of a stirring apparatus with 10 times its

weight of infusorial earth, and pressed into cakes weighing 1 pound each. It is used for cleansing metals, glass, etc.

Brown Rosin Soap in the Cold Way. Melt together cocoanut oil 16 pounds, crude palm oil 4 pounds, rosin 20 pounds, and compound the mixture at a temperature of 155° F. with 24 pounds of soda-lye of 35° B. In case a thorough combination should not be formed cover the mixing vessel with cloths, and the compound will in a short time become hot. When this is the case stir it thoroughly, and when it appears to be intimately combined stir in 3 to 4 pounds of a solution of potash of 30° B., and then pour the paste, which should be uniform and quite thickly fluid, into the frame. Soap thus prepared is pliant and washes excellently.

Cocoanut-oil Soap in the Cold Way, 100 Pounds of Oil yielding about 200 to 230 Pounds of Soap. Cocoanut oil, besides its other good qualities in comparison with other fats used in the manufacture of soap, possesses the peculiarity of fixing large quantities of water and saponifying only with concentrated lye, differing from tallow which is difficult to saponify with strong lyes. With weak lyes it forms no combination whatever, but floats as a clear fat over the lye, and actual saponification can only be accomplished by long continued boiling. This last peculiarity may have been the cause of recourse being had to cold saponification. In the following we give a few practical processes, thoroughly tested, by which good cocoanut-oil soaps are obtained at a comparatively low price.

1. Heat 100 pounds of cocoanut oil to 100° F. and add, with constant stirring, 120 pounds of lye of 27° B. The combination is formed as soon as the lye has become thoroughly caustic. Should this not be the case continue the stirring for a short time, or add fine shavings of soap, if such are on hand, cover the boiler carefully and let it stand quietly for a few hours. Then stir in 15 to 20 pounds of salt-water of 18° B., perfume with oils of lavender, thyme, and cumin each 3½ ounces, and pour the soap into the frame (mould). Yield: Two hundred to 300 pounds from 100 pounds of oil. The soap may

be colored or marbled in the ordinary way.

2. *Another process is as follows:* Melt 100 pounds of cocoanut oil, dissolve in it 5 pounds of potato starch, and, when the oil is cooled off to 97.5° to 100° F., rake in 100 pounds of soda-lye of 30° B. and, when the combination is complete, fill with 20 pounds of solution of potash of 28° B.

3. *A third process is as follows:* Melt 100 pounds of cocoanut oil and heat to 100° F., then add, with vigorous stirring, 85 pounds of lye of 32° B. and, when the combination is complete, 10 pounds of water-glass together with 5 to 6 pounds of a solution of potash of 28° to 30° B., and finally pour the soap in the frame (mould).

Cold Water Soap. By reason of this soap being generally demanded of a brown color it is prepared from cheap dark fats, as bone fat, dark tallow, etc., in the proportion of 100 pounds of fat to 60 pounds of rosin. The soap is boiled in exactly the same manner as other rosin soap, and is allowed to stand in the boiler 2 to 3 days. If it should be laded out at once the soap would be scarcely fit for use, as, on account of the high percentage of rosin, it would be impossible to obtain it in a solid form. For this reason, before it is poured into the frame, it is hardened with a filling prepared in the following manner: One hundred pounds of crystallized soda and 50 of Glauber's salts are melted over a fire without an addition of water; to this is added 25 pounds of water-glass of 75° B., and then 12 hundredweight of soap are raked into the mixture. The soap immediately becomes entirely stiff and smooth, and, after raking for $\frac{1}{2}$ hour, may be brought into the frame (mould), where the raking is continued for a short time. It is generally perfumed with essence of mirbane (nitro-benzol).

Elaine Soap. Various kinds of soap are sold under this name. They have the appearance of elaine soap, but do not contain one grain of elaine.

A really good soap, actually deserving the name on account of its containing elaine, is obtained according to the following receipt: Nine hundred pounds of palm oil are saponified with 1130 pounds of lye of 25° B. When the

paste is clear add 360 pounds each of half-bleached palm-oil and elaine, then boil the soap clear and let it stand covered 3 to 4 hours. The soap is then drawn off into the settling or heating boiler, which is warmed by flues from the boiling pan, so that the soap is kept warm and the lye can thoroughly settle. It remains here for 24 to 36 hours, is then poured into iron frames (moulds) and raked until cold.

Floating Soap. Four hundred and twenty pounds of cocoanut oil, 30 pounds of bleached palm-oil, 50 pounds of rosin, 100 pounds of olive oil, and 120 pounds of tallow are first boiled with weak lye, the strength of which is gradually increased to 40° B., and the weight of which corresponds to 360 pounds. As soon as the paste is formed add 400 pounds of flea-bane seed (*Semen psyllii*), and then boil until the finished soap detaches itself from the boiler in the form of a dough. The compound is then perfumed and, shortly before pouring out, some pulverized carbonate of sodium added. The carbonic acid set free permeates the soap and causes the formation of empty spaces, thereby lessening the specific gravity and giving the soap the quality of floating on water.

Molasses Soap. One hundred parts of molasses are heated in a boiler provided with closed serpentine steam-pipes, and 28 parts of ordinary calcined soda are then added under constant stirring. As soon as solution is complete, 100 parts of oleic acid are carefully added, so that the carbonic acid of the soda, which is liberated, first escapes. When all the oleic acid has been added, the compound is for a short time heated to the boiling point. The process is very quick, it being possible to produce 20,000 pounds of soap in 2 hours. One hundred parts of molasses yield 210 to 225 parts of soap, which, according to the time of boiling, is either half-hard or entirely hard.

The process for *soft soap* is the same, only potash being used instead of soda. For ordinary soft soap take 100 parts of molasses, 100 of oleic acid, 10 of potash, 10 of soda, and 50 of water. The yield will be about 260 parts of soap.

Cocoanut Oil and Molasses Soap is obtained by dissolving caustic soda in

hot molasses and adding cocoanut oil heated to 167° F. One hundred parts each of molasses and cocoanut oil yield 400 parts of very good hard soap. The same kind of soap is obtained by taking 100 parts of cocoanut oil, 36 of caustic soda-lye of 36° B., and 50 of molasses, whereby the cocoanut oil must also be heated to 167° F. When other kinds of fat are used a longer time is required for boiling.

Oranienburg Soap. The quantity and strength of the lye required in the manufacture of this soap depend on the fats used; for those of animal origin, as bone-fat, tallow, etc., it may be from 15 to 18 B., but more concentrated lye, from 24 to 28° B. strong, is required for the saponification of palm oil. By reason of a soap of yellowish color being in demand some rosin or crude palm oil is added.

The following receipts furnish Oranienburg soap of excellent quality and at a comparatively low cost:

	I.	II.	III.	IV.
	lbs.	lbs.	lbs.	lbs.
Bone-fat . . .	400	800		
Tallow . . .	800	400		
Palm oil . . .	1000	1000	2000	2000
Cotton-seed oil .	200	100		300
Crude palm oil .	100	250	400	300
Rosin . . .	400	350	300	400

For Nos. I. and II. saponification can begin with lye of 24° B., while Nos. III. and IV. are saponified with a concentrated lye of 26° B. The boiling process is the same for all. The fats are saponified in the usual manner and the soap separated with hot salt-water. It is then allowed to stand in the boiler 24 hours for the paste to settle thoroughly.

Process of Preparing all Kinds of Perfectly Neutral Soaps. The fats to be saponified are placed in a cylindrical vessel surrounded with a jacket and provided with a stirring apparatus. Water, heated by steam to the melting point of the fat, circulates between the jacket and the cylinder. A solution of soap, 20 per cent. of fat, or any other fluid capable of promoting an emulsion, is then added, and saponification quickly

accomplished with caustic lye. To avoid cooling, the apparatus must be kept covered during the saponifying process, and the heat formed by the chemical process exhausted as much as possible. The under-lye contains only caustic soda and glycerine free from chlorine and has a concentration of 5 to 10° B.

Water-glass Soap. Both hard and soft soaps are brought into commerce. *Hard Water-glass Soap* is prepared as follows: One hundred pounds of cocoanut oil are saponified with 200 pounds of soda-lye of 20° B., and boiled until all froth has disappeared. The soap is then hardened by gradually scattering calcined soda over it until a sample as large as a silver dollar congeals with a bluish border. In 600 pounds of soda water-glass of 36 to 38° B. are in the meanwhile placed in readiness. Eighteen to 20 pounds of crude glycerine mixed with 50 pounds of soda-lye of 20° B. are added to the soap while it is gently boiling, and then gradually the water-glass, testing the soap from time to time, until all has been added. Should the soap be still too soft, it is hardened with some calcined soda until a sample on congealing shows the above-mentioned bluish border, when the soap will be hard enough.

Soft Water-glass Soap is prepared as follows: One hundred pounds of cocoanut oil are saponified with 200 pounds of soda-lye of 20° B., and the paste boiled clear. Six hundred pounds of potash water-glass are then gradually added, and finally potash-lye of 20° B. to give it the consistency of ordinary soft soap.

Both kinds of soap are at present successfully used in dyeing, wool-washing, cotton-printing, and for other purposes.

Sand Soap. Fifty pounds of cocoanut oil are saponified in the ordinary way with about 100 pounds of soda-lye of 20° B., shortened with salt, hardened with calcined soda, covered while hot, and allowed to stand quietly in the boiler for several hours. When the soap is sufficiently cooled off so that it can be brought into the frame, remove the scum before the soap is poured out. Fifty pounds of white and perfectly dry sand are then added in the fol-

lowing manner: While one workman rakes the soap with a rake nearly as wide as the frame so that it can be conveniently handled without touching the sides of the frame, another sifts the sand into the soap. It is generally perfumed with oil of lavender 3 ounces, oil of thyme 2½ ounces, and oil of cumin 1½ ounces.

The soap must be raked until it is stiff and begins to congeal.

Toilet and Medicated Soaps. Bitter Almond Soap in the Cold Way. Coconut oil 1750 parts and lard 750 parts are saponified with 1250 parts of caustic soda-lye of 40° B., 17 parts of oil of bitter almonds, and 21½ parts of oil of bergamot.

Bouquet Soap. Tallow 1000 parts, cocoanut oil 2000 parts, crude palm-oil 100 parts, pulverized orris root 250 parts, soda-lye of 40° B. 1250 parts, potash-lye of 40° B. 100 parts, musk ½ part. *Perfume:* Sandal-wood oil 2½ parts, oils of bergamot 8 parts, geranium 4 parts, lavender 5 parts, and lemon 3 parts.

Bouquet Soap in the Cold Way. Coconut oil 2000 parts are saponified with 1000 parts of caustic soda-lye of 40° B. Perfumed with oils of bergamot 12 parts, sassafras 5 parts, cloves 2 parts, and sage 1½ parts. The soap is colored dark brown.

Camphor Soap. Good tallow soap 1500 parts, rosemary oil 40 parts, oil of lavender 5 parts, and camphor 60 parts. The camphor is first rubbed fine and mixed with the perfume.

Camphor Soap No. II. This soap is an excellent remedy for chilblains and frosted limbs. One thousand parts of cocoanut oil are saponified with 500 parts of caustic soda-lye of 40° B., and when the combination is complete stir in a solution of 75 parts of camphor dissolved in 100 parts of alcohol and 50 parts of water.

Camphor and Sulphur Soap. Cocoanut oil 1200 parts, soda-lye of 38° B. 600 parts, potassium sulphate 100 parts dissolved in water 50 parts, and 16 parts of camphor dissolved in the melted cocoanut oil.

Eagle Soap (Brown). Cocoanut oil 7000 parts, lard 30.00 parts, soda-lye of 50° B. 5000 parts. The soap is per-

fumed with essence of mirbane 16 parts, oils of bergamot 12 parts and cloves 7 parts, and colored with 14 parts of brilliant brown.

Family Soap. Cocoanut oil 2500 parts, soda-lye of 30° B. 2000 parts. The soap is perfumed with oils of bergamot and cassia each 4 parts, oils of sassafras and lemon each 2 parts.

Gall Soap. One hundred and fifty parts of beef-gall are stirred into 2500 parts of melted cocoanut oil, and the latter then saponified in the cold way with 1200 parts of soda-lye of 38° B. The soap is colored with 33 parts of ultramarine green, and perfumed with 7½ parts each of oils of lavender and cumin.

Glycerine Soap (Brilliant and Transparent). Water 1050 parts, loaf sugar 3000 parts, glycerine 5700 parts, castor oil 4800 parts, cocoanut oil and tallow each 6650 parts, lye of 40° B. 8300 parts, alcohol 3500 parts, and perfume 150 parts.

A double boiler heated with steam and provided with a stirring apparatus is used. After the ingredients have been heated, add the alcohol, place the cover on the boiler, and put the stirring apparatus in motion. As soon as the mass is thoroughly saponified shut off the steam and stop the stirring apparatus; let the soap stand quietly 6 to 8 hours, then add the perfume and, when cooled off to 130° or 133° F., pour the soap into the frame, and let it congeal as quickly as possible. The soap becomes brilliant. As the price of glycerine is rather high at present it might be advisable to use less glycerine, and substitute sugar-water. It seems also more advisable to saponify the fats first, and then add the sugar-water, glycerine, etc., as otherwise the soap might easily acquire a dark color.

Glycerine Soap (Transparent). Heat cocoanut oil 1200 parts, tallow 1000 parts, castor oil 600 parts, to 180° F., and add glycerine 600 parts. Then add 1500 parts of hot caustic soda-lye and 200 parts of alcohol, and saponification will take place. Cover the boiler to prevent evaporation of the alcohol, and fill the soap with 500 parts of solution of sugar in the proportion of 1 part of refined sugar dissolved in 2 of distilled

water. Heat the solution to 167° F., and stir it into the hot soap.

This soap is brilliant and comparatively cheap.

A *substitute filling* is now much used in making glycerine soap. Prepare a soap with 10 parts of cocoanut oil and 10 of hot caustic soda of 30° B., and keep for use. Dissolve 2400 parts of this ground soap in 7000 parts of clear salt water of 13° to 15° B., add 500 parts of potash of 96° B., and heat the whole to about 167° F.; then add 1150 parts of 95 per cent. alcohol and cover the boiler. The filling will become clear, the impurities, etc., settling on the bottom. It is kept in well-closed glass balloons. To 5000 parts of soap 30 to 50 per cent. and frequently more of this filling is used.

Iodide Soap is used for preparing iodide baths, and is considered a remedy for cutaneous diseases. It is prepared in the cold way in the following manner: Twenty pounds of cocoanut oil are saponified with 10 pounds of caustic lye of 40° B., and, when saponification is complete, a solution of 3 pounds of potassium iodide in 4 pounds of water is added.

Kummerfeldt's Soap for Frosted Limbs. Of cocoanut oil 1200 parts, flowers of sulphur 50 parts, camphor dissolved in alcohol 50 parts, soda-lye of 40° B. 800 parts, potash-lye of 40° B. 100 parts.

Lemon Soap. Cocoanut oil 1000 parts, caustic soda-lye of 40° B. 500 parts, oils of lemon and bergamot each 4 parts. The soap is colored pale yellow.

Lily Soap. Wax soap 3000 parts, starch 300 parts, oils of bergamot 16½ parts, geranium 6½ parts, cassia 1½ parts, of sandal-wood ½ part, cedar oil, tinctures of musk and tonka bean each 3½ parts, and tincture of storax 10 parts.

Mignonette Soap. Wax soap 2500 parts, starch 400 parts, mignonette 11½ parts, genuine Turkish rose oil 1½ parts, oil of geranium 5 parts, essence of iris 3½ parts, oil of bitter almonds 2½ parts, tincture of musk 5 parts, and tincture of storax 10 parts.

Musk Soap in the Cold Way. Cocoanut oil 2000 parts, caustic soda-lye of 40° B. 1000 parts, tincture of musk 10

parts, oil of bergamot 6 parts, oil of lemon 3½ parts. Color the soap light brown.

Orange Soap. Good white tallow soap 600 parts, oils of neroli 1 part, bergamot ½ part, orange 2 parts, azalea 1 part, petit-grain 2 parts, lemon 1 part, geranium 2 parts, essence of Portugal 1 part, infusion of civet 2 parts, and infusion of musk 1 part.

Patchouli Soap. Good white tallow soap 1250 parts, oil of patchouli 12½ parts, and oil of sandal-wood 2 parts.

Pumice Soap (Prime) in the Cold Way. Cocoanut oil 2000 parts and lye of 40° B. 1000 parts are saponified in the ordinary way. Five hundred parts of pumice-stone, finely pulverized, are then stirred in, the soap ladled into the frame and perfumed with oils of cassia 2 parts, bergamot 8 parts, cloves 1 part, lavender 1 part.

Rose Soap. Cocoanut oil 2000 parts, caustic soda-lye of 40° B. 1000 parts, oils of geranium and bergamot each 8 parts, rose oil ½ part, tincture of musk 1½ parts.

Savon de Riz. Wax soap 2700 parts, starch 400 parts, oil of geranium 3½ parts, essence of Portugal and oil of bergamot each 5 parts, essence of mirbane 3½ parts, tincture of benzoin, colored white or red, ½ part, cinnabar 8 parts.

Savon Ess: Bouquet. Wax soap 2500 parts, iris powder 200 parts, starch 300 parts, oils of geranium 7½ parts, bergamot 15 parts, cinnamon 12½ parts, tincture of storax 9 parts, tincture of musk 3 parts, sugar color for coloring 12½ parts.

Savon Orange. Good white tallow soap 3000 parts, scraps of cocoanut oil soap 750 parts, flour 250 parts, oils of neroli, orange, and petit-grain each 10 parts, bergamot 5 parts, essences of lemon 5 parts, geranium 10 parts, American Portugal 5 parts, infusion of civet 10 parts, and infusion of musk 5 parts.

Soap Crèmes. The soft toilet soaps are mostly prepared from lard and caustic potash-lye of 30° B. Melt the lard over a water-bath, and stir in hot lye in a thin stream; then work the mass with a pestle to a pearl tint, which will be improved in appearance by using 3 parts of potash-lye and 1 part

of soda-lye. The pigment and perfume dissolved in alcohol are added while working the soap. The soap crèmes, by reason of their convenient application, are much in demand.

Crème D'Amandes Amères. Lard 600 parts, caustic potash-lye of 38° B. 250 parts, and caustic soda-lye of 38° B. 50 parts. Perfume: oils of bitter almonds 3 parts and bergamot $\frac{1}{2}$ part.

Crème à la Rose. Lard 600 parts, caustic potash-lye of 38° B. 250 parts, and caustic soda-lye of 38° B. 50 parts. Perfume: oils of bergamot 3 parts and geranium $1\frac{1}{2}$ parts.

Besides soap crèmes transparent and white soft soaps are manufactured from lard, olive oil, tallow, etc. They are boiled with potash-lye and used as toilette and shaving soaps.

Sulphur Soap. Cocoanut oil 1000 parts is saponified with 500 parts of caustic lye of 40° B. and 75 parts of flowers of sulphur stirred in.

Swiss Herb Soap. Melt together over a water-bath 500 parts each of best quality of cocoanut oil and tallow, add 150 parts of glycerine of 28° B., 200 parts of refined sugar dissolved in 225 parts of water; mix 375 parts of 96 per cent. alcohol with 550 parts of soda-lye, and add to the solution, which is then heated as quickly as possible to 190° F. with constant stirring. It is then taken from the water-bath, and, under constant stirring, allowed to cool off to 144 $\frac{1}{2}$ ° F. The soap is now colored with $\frac{1}{2}$ to $\frac{3}{4}$ part of uranium green previously dissolved in alcohol or boiling water, and perfumed with 2 $\frac{1}{2}$ parts each of oils of bergamot and peppermint, and 1 $\frac{1}{4}$ each of oils of aniseed and lavender. It is finally filtered through gauze into a frame of sheet-zinc, which is lightly covered.

Tannin Soap. Saponify 900 parts of cocoanut oil with 450 parts of soda-lye of 40° B., and add 25 parts of tannin previously dissolved in alcohol. The soap is perfumed with Peruvian balsam 3 parts, oils of cassia and cloves each 1 part.

Tur Soap. I. Melt together 20 parts of cocoanut oil and 3 parts tar, and saponify in the ordinary manner with 25 parts caustic lye of 40° B. This soap is used for cutaneous diseases.

II. Scraps of cocoanut oil soap can

be utilized by dissolving them in solution of salt of 10° B., and stirring about 30 parts of it with 3 parts of coal tar.

III. Cocoanut oil 350 parts, lye of 40° B. 180 parts, good wood tar stirred into the melted cocoanut oil 30 parts.

Vaseline Soap. Cocoanut oil 200 parts, vaseline 25 parts, lye of 40° B. 95 parts, and water 5 parts.

Violet (Prime). Cocoanut oil best quality 500 parts, soda-lye of 38° B. 240 parts, and potash-lye of 38° B. 10 parts. The soap is perfumed with 10 parts of orris root and 5 parts of liquid storax stirred into the fat; and oils of cassia, sassafras, and bergamot each $\frac{1}{4}$ part, oil of lavender $\frac{1}{2}$ part, Peruvian balsam $\frac{1}{2}$ part, oil of orange $\frac{1}{6}$ part, oil of rose $\frac{1}{6}$, essence of musk $\frac{1}{4}$ part, and colored with $\frac{2}{3}$ part of brilliant brown previously dissolved in boiling water.

Violet Soap. I. Tallow 100 parts, cocoanut oil 140 parts, pulverized orris root 30 parts, pulverized orange peel 1 $\frac{1}{4}$ parts, and storax 2 $\frac{1}{2}$ parts. The storax is dissolved with constant stirring in 10 parts of the cocoanut oil over a moderate fire, poured through gauze, and added to the fat. One-thirtieth part of musk is then triturated with some lye and water, and the whole saponified with 120 parts of soda-lye of 38 per cent., and perfumed with 1 $\frac{3}{4}$ parts of oil of bergamot, 2 parts of oil of lavender, 1 $\frac{1}{4}$ parts of Peruvian balsam, and $\frac{1}{2}$ part of oil of cassia, and colored with 1 part of cinnabar.

Violet Soap. II. Melt together 315 parts of cocoanut oil and 150 parts of crude palm oil, cool off to 108° F., pour through gauze and color with $\frac{3}{4}$ part of cinnabar. Then take 20 parts of pulverized orris root, 2 $\frac{1}{2}$ parts of pulverized orange peel, and 1 $\frac{3}{4}$ parts of pulverized benzoin, pass the whole through a fine sieve, and add it, with constant stirring, to the fat. When all the powder is dissolved, saponification is accomplished with 170 parts of soda-lye of 38° B., and the soap perfumed with oils of lavender and bergamot each $\frac{3}{4}$ part, oils of cassia and cloves each $\frac{1}{2}$ part, and tincture of musk $\frac{3}{4}$ part. The soap does not need coloring, as it is naturally of a beautiful brown.

White Alabaster Soap. Stearine

65 parts, cocoanut oil best quality 110 parts, glycerine 65 parts, caustic soda-lye of 38° to 39° B. 90 parts, alcohol of 96 per cent. 130 parts.

White Windsor Soap. Good white tallow soap 200 parts, oils of lavender $\frac{1}{2}$ part, cassia $\frac{1}{2}$ part, neroli $\frac{1}{2}$ part, essence of Portugal $\frac{1}{2}$ part, and oil of cinnamon $\frac{1}{2}$ part.

Shaving Soap in the Cold Way. Melt together 250 parts of tallow, 125 parts of cocoanut oil and 25 parts of lard, and allow the mixture to cool off to 115° F; then add 275 parts of caustic soda-lye of 30° B. and 75 parts of caustic potash-lye, and perfume the soap with 1 part of oil of lavender and $\frac{1}{2}$ part each of oils of thyme and cumin.

Soap for Washing Silk Goods. Melt in a suitable boiler 1500 parts of soap converted into fine shavings, a like quantity of beef-gall, 165 parts of honey, 150 parts of pulverized sugar, and 25 $\frac{1}{2}$ parts of Venetian turpentine, and pour the mass, while yet hot, into a mould previously lined with a cloth dipped in cold water. The soap will become hard in the course of 24 hours and ready for washing silk goods.

To Give a Gloss to the Surface of Toilet Soaps they are generally scraped, dipped into dilute lye, and, when dry, brushed. This rather tedious labor can, according to *Depuis*, be done by steam. The soap, before or after drying, is submitted to a current of steam, which may be perfumed before reaching the soap by passing through a cloth impregnated with the perfume. The action of the steam effects at once an alteration in the surface of the cakes or bars of soap, forming a salt of varying composition according to the fats used. By uniformly distributing this salt upon the surface of the soap with a moist linen cloth, all the pores and irregularities of surface are closed, and, when dry, forms a very glossy coating which is not injured even in the moulding press.

New Process of Treating Fats. By this process the tar-like substances formed in saponification with sulphuric acid are, by a simple method, removed, and complete decomposition is accomplished by an addition of di-

lute sulphuric acid, and boiling under pressure in a closed apparatus. The fat is completely decomposed, and the glycerine obtained as a clear fluid. We may divide the process into 4 distinct operations: 1, treating the fat with concentrated sulphuric acid with development of sulphurous acid; 2, removing the tar-like substances; 3, decomposition with dilute sulphuric acid in a closed vessel under a pressure of 3 to 4 atmospheres; and, 4, treating the sebates in the cold and warm press.

1st Operation. The fats are heated in a vessel lined with lead to 250° to 300° F., fresh fats requiring a higher temperature than old stock. Sulphuric acid in the proportion of 1 to 1.5 parts to 100 parts of fat is then added with constant stirring, and the stirring continued until the temperature is reduced to 212° F. This operation prepares the fats for decomposition. The mass becomes black under development of sulphurous acid, by reason of which arrangements must be made for the protection of the workmen against the injurious effects of the acid. The fat, when the temperature is reduced to 212° F., is brought into another vessel.

2d Operation. To 100 parts of fat treated with concentrated sulphuric acid add 50 parts of hot water. The compound is thoroughly agitated and then allowed to settle, whereby the greatest part of the tar-like bodies is dissolved. The fat is then skimmed off and brought into another pan. To every 100 parts of it 50 parts of water are added; it is boiled for a short time and then again allowed to settle for a few hours. If the sebatic acids are to be distilled, two washings are sufficient, but if the acids are to be worked up without distilling, it is best to wash a third time. The fat will then be entirely cleansed from all tar-like substances originated in the first operation.

3d Operation. The purified fat is brought into a vat lined with lead, and, according to the condition of the fat, 3 to 4 per cent. of concentrated sulphuric acid previously diluted with double its quantity of water is added. The vessel is then closed, and the fat boiled by introduction of steam under a pressure of 3 to 4 atmospheres for 4 to 5 hours, which completes the decomposition.

The glycerine sulphuric acid, by reason of the three washings in the second operation, is entirely clear and almost colorless; it is neutralized with lime and evaporated. One hundred parts of tallow yield by this process 7 parts of glycerine in no respect inferior to that obtained by lime-saponification. If the sebacic acids are to be distilled it suffices to treat them with boiling water, but if they are to be pressed undistilled they must be washed with boiling water to which 1 per cent. of sulphuric acid has been added. All that remains then is cold and warm pressing.

Balling's Method of Preparing Caustic Soda-lye. Dissolve by introducing steam 100 parts of calcined soda of 80 to 90 per cent. in 600 of clear water; then add 60 to 70 parts of burned lime which, on becoming slaked in the hot fluid, raises the temperature. Carbonate of calcium is formed which settles in a short time, and the clear lye is then drawn off. The carbonate of calcium is washed with water, this wash water being afterwards used in preparing the caustic soda-lye, giving a product of 15° to 16° B.; 100 parts of this lye will saponify 400 parts of tallow.

The caustic lye thus obtained is at once, and without being concentrated by evaporation, used for boiling soap. It is one of the principal requisites that only fresh caustic lye should be used in boiling soap. The lye is first placed in the boiler and then the tallow. The latter melts, covering the surface of the lye and preventing the access of air to it, and the saponification of the fat is hastened by the quicker boiling of the lye.

By this process but very little under-lye is obtained. This contains the foreign constituents of the soda, common salt, and Glauber's salt, on which the separation of the soap from the under-lye depends. Salting is required only for potash soaps.

The soap is allowed to remain quietly in the boiler for ½ hour to allow the under-lye to separate. It is then poured into the frame and when cold divided into bars.

The under-lye obtained is of a dark brown color and contains, besides common salt and Glauber's salt, some glycerine. When a considerable quantity

has been collected, it is boiled down, whereby a part separates as black soap. The dry residue is calcined and furnishes a black substance which, after lixiviation, gives a colorless lye. By evaporating the latter a white substance containing considerable quantities of soda is obtained, which on being dissolved and made caustic with lime can be again used as lye.

TUNNERMANN'S Table giving the Percentage of Soda in a Soda-lye at 59° F.

Per cent. of soda.	Specific gravity.	Per cent. of soda.	Specific gravity.
0.302	1.0040	15.714	1.2453
0.604	1.0081	16.319	1.2515
1.209	1.0163	16.923	1.2578
1.813	1.0246	17.528	1.2642
2.418	1.0330	18.132	1.2708
3.022	1.0414	18.730	1.2775
3.626	1.0500	19.341	1.2843
4.231	1.0587	19.945	1.2912
4.835	1.0675	20.550	1.2982
5.440	1.0764	21.154	1.3053
6.044	1.0855	21.758	1.3125
6.648	1.0948	21.894	1.3143
7.253	1.1042	22.363	1.3198
7.857	1.1137	22.967	1.3273
8.462	1.1233	23.572	1.3349
9.066	1.1330	24.176	1.3426
9.670	1.1428	24.780	1.3505
10.275	1.1528	25.385	1.3586
10.879	1.1630	25.989	1.3668
11.484	1.1734	26.594	1.3751
12.088	1.1841	27.200	1.3836
12.692	1.1948	27.802	1.3923
13.297	1.2058	28.407	1.4011
13.901	1.2178	29.011	1.4101
14.506	1.2280	29.616	1.4193
15.110	1.2392	30.220	1.4285

TUNNERMANN'S Table showing the Percentage of Anhydrous Potash in Potash-lye at 59° F.

Per cent. of potash.	Specific gravity.	Per cent. of potash.	Specific gravity.
0.5658	1.0050	15.277	1.1568
1.697	1.0153	16.408	1.1702
2.829	1.0260	17.540	1.1838
3.961	1.0369	18.671	1.1979
5.002	1.0478	19.803	1.2122
6.224	1.0589	20.935	1.2268
7.355	1.0703	21.500	1.2342
8.487	1.0839	22.632	1.2493
9.619	1.0938	23.764	1.2648
10.750	1.1059	24.895	1.2805
11.882	1.1182	26.027	1.2966
13.013	1.1318	27.158	1.3131
14.145	1.1437	28.290	1.3300

PRINZ'S PRACTICAL SOAP-BOILING TABLE.

Hard Soaps.

100 parts of the following fats	require for complete saponification, of soda :						
	Parts of NaO	Parts of NaO, HO	Parts of NaO C O ₂	of soda-lye of degrees Beaumé.			
				10	20	25	30
Tallow, suet, stearine, stearolic acid . . .	10 $\frac{2}{3}$	13 $\frac{2}{3}$	18 $\frac{1}{3}$	273	137	105	80
Free elaic acid, oleic acid	11	14 $\frac{1}{3}$	19	287	143	110	84
Palm oil	11 $\frac{1}{3}$	15	20	300	150	115	89
Cococanut oil	13 $\frac{1}{2}$	17 $\frac{1}{2}$	23	350	175	135	103

Soft Soaps.

100 parts of the following fats	require for complete saponification, of potash :						
	Parts of KaO	Parts of KaO HO	Parts of KaO C O ₂	of potash-lye of degrees Beaumé.			
				8	20	26	35
Tallow, suet, stearine, stearolic acid . . .	16	19 $\frac{1}{3}$	24	322	129	97	72
Free elaic acid, oleic acid	16 $\frac{2}{3}$	20	25	333	133	100	75
Palm oil	17 $\frac{1}{3}$	20 $\frac{2}{3}$	26	345	138	103	7
Cococanut oil	20 $\frac{1}{2}$	24 $\frac{1}{3}$	30 $\frac{1}{2}$	405	162	122	90

Note to the Table. By multiplying the quantity of potash (column 3) required for saponification with 3 and dividing the product by 7 the quantity of quicklime required for making the lye caustic is obtained.

The lyes indicated by figures printed in bold type accomplish saponification best, those by figures in medium type good, while the work is difficult with lyes indicated by figures in small type. Of the 4 fats tallow is the most difficult to saponify, palm oil less so, while cococanut oil and elaic acid are the easiest to work.

SOLDERING AND SOLDERS.

Soldering is the process of uniting the surfaces of metals by means of a more fusible metal which, being melted upon each surface, serves, partly by chemical attraction and partly by cohesive force, to bind them together. There is a great variety of solders, known by the names of *hard, soft, spelter, silver, white, gold, copper, tin, plumbers',* and many others. Nearly all the principal metals take part in the composition of solder, and most unmelted metals can be jointed by one or other of these solders. The metals to be united may be either the same or dissimilar, but

the uniting metal must always have an affinity for both. In all soldering processes the following conditions must be observed: 1. The surfaces to be united must be bright, smooth, and free from oxide; 2. The contact of air must be excluded during the soldering, because it is apt to oxidize one or other of the surfaces, and thus to prevent the formation of an alloy at the points of union. The most frequently employed solder consists of tin and lead, and melts somewhere between 329° and 563° F., according to the proportions of the ingredients. A flux of borax, etc., is often needed to insure the adhesion of the solder to the two pieces of

metal, and soldering irons of various kinds are required.

Autogenous Soldering takes place by the fusion of the two edges of metals themselves without interposing another metallic alloy as a bond of union. This is accomplished by directing a jet of burning hydrogen gas from a small movable beak upon the two surfaces or edges to be soldered together. Metals thus joined are much less apt to crack asunder at the line of union by differences of temperature, flexibility, etc., than when the common soldering process is employed. This method of soldering is especially of great advantage in chemical works for joining the edges of sheet lead for sulphuric acid chambers and concentration pans, because any solder containing tin would soon corrode.

Ordinary Soft Solder, an alloy of tin and lead, is best adapted for most metals, with the exception of cast-iron, worked in the various industries. Its composition varies very much, about equal parts of the metals being generally taken; 2 parts of tin to 1 of lead furnishing what is called "*weak soft solder*," and 2 parts of lead to 1 of tin "*strong soft solder*." A composition consisting of:

Tin 1 part and lead 2 parts	melts at 441.5° F.
" 1 " " " 1 part	" " 371.7° F.
" 2 parts " " 1 " "	" " 340.2° F.

Bismuth Solder consists of 2 parts or more, frequently even as much as 8 parts, of tin solder and 1 part of bismuth. It is more fusible than tin solder, and for this reason is better suited for soldering thin articles of plumbiferous tin, but it breaks quite easily and is therefore but little used for other purposes. A composition consisting of:

Tin 8 parts bismuth 1 part	melts at 320° F.
" 6 " " " 1 " "	" " 311° F.
" 4 " " " 1 " "	" " 293° F.
" 2 " " " 1 " "	" " 236.7° F.

Darcel's Metal is an excellent soft solder consisting of lead and bismuth each 8 parts and tin 3 parts.

Hard Solders. *Cast-iron* may be used as a solder for wrought-iron, but, being very refractory and brittle, it is but seldom used.

Copper is the best material of joining iron to iron whether wrought or cast. It unites the two surfaces very firmly and, by reason of its natural ductility and toughness, allows of the soldered articles being bent into almost any shape.

Brass Hard Solder consists of a mixture of brass and zinc to which is sometimes added a small portion of tin. Wrought or rolled brass being more homogeneous, and not likely to contain an undue proportion of zinc, should be preferred to cast-brass in preparing the solder. The proportions of brass and zinc vary according to the purpose intended; addition of zinc increases the fusibility but decreases the ductility and also the durability of the solder. A very good hard solder for cast-steel, wrought-iron, steel, copper, and brass (with the exception of cast-brass) is obtained by melting 7 parts of brass shavings together with 1 of zinc, keeping the mixture in flux for not longer than 6 to 7 minutes, and then pouring out.

Hard Solder containing Tin. In preparing this solder it is best to melt the brass and zinc separately in 2 crucibles, so that they become liquid at the same time. The zinc is then carefully, and with quick and constant stirring, poured in the brass previously skimmed.

	I.	II.	III.	IV.
	Parts.			
Brass	18	12	12	16
Zinc	3	4	2	
Tin free from lead	2	1	2	1
Copper	16

Other solders belonging to the same order:

	I.	II.	III.	IV.	V.
	Parts.				
Copper	33.34	61.25	13	49.5	24
Zinc	66.66	38.75	10	50.5	8
Tin	8

Or, tin 1 part, brass 5; *or*, zinc 19 parts, brass 82; *or*, zinc 333 parts, brass 1000, and tin 125.

Solder for Argentan (German Silver).

A composition consisting of argentan and more or less zinc is used for this. The proportions vary very much, but, as regards durability and solidity of the solder, it is best to take as little zinc as possible. Argentan by itself is well suited for soldering iron and steel articles.

Hard Silver Solder is used for soldering silverware and fine articles of brass, copper, steel, and iron. It consists of silver with a large addition of copper, or of silver, copper, and zinc.

a. Hard Silver Solder (for the first soldering) is generally composed of:

	I.	II.	III.	IV.	V.	VI.	VII.	VIII.	IX.	X.	XI.
	Parts.										
Fine silver	4	2	19	57	66.7	66.3	50	11	16	6	9
Copper	1	28.6	23.3	25.7	33.4
Brass	3	1	10	4	15	76	157
Zinc	5	14.3	10	11	16.6	1	1	18	35

b. Softer Hard Silver Solder for after-soldering, *i. e.*, for soldering articles having parts already soldered and

therefore requiring a more fusible solder:

	I.	II.	III.	IV.	V.	VI.	VII.	VIII.	IX.
	Parts.								
Medium fine silver	7	16	16	3.5	2	10.5	68.8	67.1	48.3
Zinc	1	1	1	1	1	3	8.2	10.5	16.1
Copper	2.6	3	4.5	23	24.4	32.3
Tin	-3.3

Hard Gold Solders for soldering goldware, and sometimes fine articles of steel, are generally divided into:

1. *Easily Liquefiable Solder for Articles of less than 14-carat gold.* Fourteen-carat gold 10 parts, fine silver 5, zinc 1. This solder serves for yellow gold which it resembles in color, and also for finer goldware which is not to be colored.

3. *Refractory Solder for Articles of 14-carat gold and over,* especially when they are to be colored. Fine gold 16 parts, fine silver 9, copper 8.

3. *Solder for Articles of 20-carat gold* which are to be enamelled, and

by reason of the heat to which they are exposed during the process require a very refractory solder: *a.* Fine gold 37 parts, fine silver 9. *b.* Eighteen-carat gold 16 parts, fine silver 3, copper 1.

Very Refractory Solders for Articles to be enamelled.

	I.	II.	III.
	Parts.		
Copper	25	0.1	...
Silver	7	3	9
Gold	68	16	37

Other Hard Gold Solders for articles of gold of 14-carat and over are composed of:

	I.	II.	III.	IV.	V.	VI.	VII.	VIII.	IX.
	Parts.								
Copper	24.2	33.4	37.5	26.1	27.1	27.2	29.2	33.3	31.3
Silver	27.3	16.6	18.75	25	76.7	31.8	33.3	37.5	50
Gold	48.5	50	43.75	48.9	56.2	40.9	37.5	29.2	18.7

Good Hard Solder used for soldering brass is prepared from an alloy of 6 parts of copper with 4 of brass and 10 of tin. The copper and brass are first melted and the tin is then added. When the whole is melted together it is poured upon a bundle of twigs held over a tub of water, into which it falls in granulations. The granulated metal is then dried and pounded to the required fineness in a mortar. By adding to this alloy 2 parts of zinc a still more fusible solder is obtained. For soldering platinum, fine gold cut up in small pieces is used.

An *Excellent Soft Solder* is obtained by melting together equal parts of bismuth and lead. It is used for soldering tin plates together, and gives very good results. The following table gives a number of alloys for soft solder and their respective melting points :

No.	Tin.	Lead.	Bismuth.	Melting Point. Degrees F.
1	1	25	...	556
2	1	10	...	541
3	1	5	...	511
4	1	3	...	482
5	1	2	...	441
6	1	1	...	370
7	1½	1	...	334
8	2	1	...	340
9	3	1	...	356
10	4	1	...	365
11	5	1	...	378
12	6	1	...	380
13	4	4	1	320
14	3	3	1	310
15	2	2	1	292
16	1	1	1	254
17	1	2	1	334
18	5	3	1	203
19	2	1	1	
20	1	1	2	

No. 8 is used for soldering cast-iron and steel, sal-ammoniac or rosin serving as a flux. Copper, brass, and bronze can also be soldered with the same alloy and the same flux. For soldering tin-plate and sheet-iron chloride of zinc is used as a flux with the same solder. Lead and tin-pipes are soldered with Nos. 6, 7, and 8, using rosin and olive oil as flux.

Silver Solder for Plated Ware. Melt together silver 64 parts and brass 40.

Soft Solder for Cast Britannia Metal. Melt together lead 10 parts, tin 16.

Solder for Pewter. Melt together tin 30 parts, lead 15, and bismuth 3 to 9.

Hard White Solder is composed of copper 24 parts, zinc and tin each 8.

Hard Yellow Solders. 1 consists of copper 13 parts and zinc 10.

2. This is especially suitable for copper-smiths. It is composed of zinc 49.5 parts and copper 50.5.

Solder for Gold on Aluminium Bronze. Copper 8 parts, aluminium 12, and zinc 80, melted together in the order mentioned. For larger articles : Copper 4 parts, aluminium 6, and zinc 90.

Three *Excellent Hard Solders* found in commerce are composed as follows :

	Copper Parts.	Zinc Parts.	Tin Parts.	Lead Parts.
A. Golden yellow	53.50	43.33	2.12	
B. Medium light	43.75	50.58	3.75	1
C. White . . .	57.50	27.90	14.90	trace.

To Solder Brass and Sheet-tin. Tin the brass where it is to be soldered, and use a solder consisting of 2 parts tin and 1 lead.

To Solder Iron and Steel. For large pieces of iron or steel, copper or brass is used as solder. Place a thin strip of copper or brass along the junction, bind the plates together with wire, and cover them an inch deep with clay free from sand. For soldering iron to iron bring the plates, when dry, to a white heat, and then plunge them into cold water; for iron to steel or steel to steel cool slowly from the white heat. The vitrified clay is then broken off.

For smaller articles prepare a solder by granulating a mixture of 8 parts of brass with 1 of zinc. Mix this solder with borax and spread it over the articles to be joined.

For very small articles a solder prepared by melting together 6 parts of brass, 1 of zinc, and 1 of tin is used. The solder is beaten into thin plates, which are applied, together with borax, to the surfaces of the articles to be soldered.

Very small and delicate articles are

best soldered by gold, either pure or mixed with 2 parts of silver and 3 of copper.

To Solder Steel on Sheet-iron. Melt borax in an earthenware pot, and mix it with $\frac{1}{6}$ part of sal-ammoniac. Cool it upon an iron plate, and add an equal weight of lime. When iron and steel are to be soldered together bring them first to a red heat, and spread the above mixture over them. The mixture melts and becomes liquid like sealing-wax. The pieces of metal are replaced in the fire and heated again, but not nearly as strong as for ordinary soldering; they are then taken out and the two surfaces united by hammering. The same process is also recommended for soldering sheet-iron tubes.

Soldering without a Soldering Iron. Pieces of brass, etc., can be soldered without it being possible to detect the joint by filing the pieces so that they fit exactly, moistening them with a soldering liquid, then placing a piece of smooth tin-foil between them, tying them together with wire, and heating over a lamp or fire until the tin-foil melts. With good soft solder most all soldering can be done over a lamp without the use of soldering iron. The different degrees of fusibility of solders can also be advantageously used for several solderings and joints on the same piece. By soldering first with a fine solder composed of lead 2 parts, tin 1, and bismuth 2 there will be no danger of melting when close to the jointed part another piece is soldered on with solder composed of lead 4 parts, tin 4, and bismuth 1. The following soldering liquid is the best to use: Equal parts of water and hydrochloric acid saturated with zinc.

Soldering Liquid Causing no Rust is prepared as follows: Dissolve small pieces of zinc in hydrochloric acid until the acid ceases to effervesce. Then add about $\frac{1}{2}$ part of the solution of spirit of sal-ammoniac, which neutralizes all acid, and finally dilute the whole with an equal quantity of water. This soldering liquid causes no rust on iron or steel, and does excellent service in all soldering and also in tinning operations.

Another Soldering Liquid Free from Acid is prepared by mixing 10 parts of

pure hydrochloric acid with 5 of water, and adding gradually to the mixture 5 parts of zinc cut up in small pieces. It is best to use an earthenware or glass vessel with a wide neck, and, by reason of the escaping gases being very poisonous, to perform the work in the open air. When all the zinc has been added stir frequently with a wooden rod during the first day; the next day heat the vessel gently by placing it in hot water or hot sand, and then place the mixture aside for clearing. In a few days pour off the clear fluid, and add a solution of $\frac{1}{2}$ part of sal-ammoniac in 2 of water; stir thoroughly and put the ready liquid in earthen jars or glass bottles.

The zinc remaining in the vessel is rinsed off with water, dried, and kept for future use.

If a stronger liquid is desired, the last 2 parts of water may be omitted and the sal-ammoniac directly dissolved in the solution of zinc.

Simple Method of Soldering Small Articles. Moisten the surfaces of the metals to be soldered with a feather dipped in a solution of sal-ammoniac, and fit the joint with tin-foil cut to the exact size, and heat the metals sufficiently to melt the tin-foil. When cold the surfaces will be found firmly cemented together.

To Solder Saws. A piece of charcoal, a blowpipe, some spelter and borax are required. File the ends of the saw smooth, so that one side laps over the other; fit the teeth opposite each other, and bind it with iron wire to keep in place. Then moisten the lap with borax dissolved in water and place the saw on the charcoal. Place the broken parts near a gas jet, sprinkle the parts previously wetted with the spelter, and blow the flame of gas until the spelter runs; let it get cool before removal. When quite cold file it flat with the other part of the saw.

SUGARS, GLUCOSE, ETC.

Preparation of Milk Sugar. By the former process of evaporating the whey in order to gain the milk-sugar, a large part of it, by reason of the percentage of acid, passed over into non-

crystallizable lactose. By *Engling's* process the whey is neutralized with whiting, then evaporated to one-half its volume and allowed to settle. The clear whey is then drawn off from the precipitate, consisting of albumen and calcium phosphate, and further evaporated. The sugar separates from the purified solutions in cohering lamina and crusts. The mother lye, by being further evaporated, yields a second crystallization. The remaining thick lye can be still further worked into sugar by dialysis. By this process 100 parts of summer whey yield 4 parts of refined milk-sugar. By allowing the whey to freeze and removing from time to time the ice-crust formed, a solution rich in sugar is obtained in a comparatively short time, and which is purer than that gained by evaporation, since the fat, albumen, and salts mostly combine with the ice. An experiment to obtain milk-sugar by this process resulted in a yield of $\frac{1}{4}$ part of milk-sugar, white as snow, from 10 parts of whey, the result being still better from winter whey, naturally poor in sugar, 100 parts of which yielded $2\frac{1}{2}$ parts of milk-sugar.

Improvement in Refining and Crystallizing of Starch Sugar (Glucose). Commercial glucose is melted and mixed with 70 to 80 per cent. of spirit of wine of 80° Tralles, or with pure pyroligneous spirit. To the resulting syrupy mixture add pulverized glucose, and allow the whole to congeal at a temperature of above 86° F., stirring it frequently. The syrup obtained in the manufacture of starch can also be treated in this manner. The resulting paste is pressed and treated in the centrifugal machine, and the alcohol regained by distilling in a vacuum. To prepare solid transparent glucose (dextrose hydrate $C_6H_{12}O_6 \cdot H_2O$) concentrate in a vacuum a solution of glucose to 46° (weighed at 90°) and allow it to crystallize in moulds at a temperature from 95° to 120° F. At a lower temperature it crystallizes in wart-like masses.

Refining and Preparation of Anhydrous Glucose. Evaporate in a vacuum an entirely colorless and clear solution of glucose until a sample can scarcely be kneaded. Then mix the

evaporated mass with 10 to 25 parts by weight of boiling hot methyl alcohol, and pour the resulting thin syrup in conical moulds, which can be closed. Crystallization will be complete in 2 or 3 days, when what remains liquid is expelled by suction.

For producing dense and solid sugar, saturate the porous mass taken from the moulds with a mixture of 100 parts of concentrated syrup and 80 to 100 parts of pyroligneous spirit and allow it to crystallize at an ordinary temperature. When the desired density has been obtained, remove the liquid portion by suction and wash the sugar with methyl alcohol. The methyl alcohol remaining in the loaves is distilled off by bringing the loaves into a vacuum pan, a temperature of 86° F. being sufficient at the start, and need only be raised towards the end of the operation to 120° to 140° F. The pyroligneous spirit is regained by distillation from the fluid drawn off by suction.

Apparatus and Process for the Fabrication of Starch, Glucose, and Hard Grape Sugar (Dextrose), by Wm. T. Jepp, of Buffalo, N. Y. Through the hopper A^1 (Fig. 40) the corn, etc., to be worked is conveyed into the closed steeping vat A filled with water of about 140° F., and distributed by an apparatus over the entire inner surface of the vat. The material sinks down, while the foreign admixtures are removed by a discharge pipe. After 48 hours the water is drawn off, and the corn conveyed by an elevator to the hopper B^1 , and from here to the mill B^2 , from whence it passes to the shaking sieve C, upon which falls a constant stream of water. The starch passes through the sieve, while the bran remains behind and is carried by a transport screw placed underneath the sieve to the elevator C'' , and is conveyed by this to the crushing apparatus D, consisting of two rubber collars between which passes a wire cloth. The bran is here freed from moisture and starch, the bran remaining upon the wire cloth while the starch is collected in a basin beneath the cloth and runs from here into the settling boxes E, where it is treated with chemicals in order to separate

the gluten. From here the starch-milk is conveyed to the inclined starch tables G, and is then carried into a channel at the head of the series of tables where it is comminuted by a revolving knife, water being admitted at the same time. The paste is conveyed to the mixing reservoir K provided with a stirring apparatus, and finally into the settling box L, where it is washed. To produce glucose the starch is brought into the open converter L, drawn off into the holder M, and here neutralized. The fluid is then conducted through the settling box M' and the bag-filter M² into the reservoir M', and bleached. From M' the fluid passes through the bag-filter N' to N' and O, is filtered through animal charcoal, and then pumped into the vacuum pan Q, where it is concentrated. After passing through the filtering press R, it is ready to be drawn into barrels.

For preparing hard grape sugar (*dextrose*), the solution of sugar is conveyed from the closed converter L³ into the reservoir T, then to T' where it is neutralized and bleached, and finally into the settling box M'. From here it is passed through the bag-filter M² into the reservoir M³, filtered, then pumped into M', where it is bleached and filtered through N into N'. From the latter it is conveyed to O, and is either filtered through the carbon filter P or brought directly into the vacuum pan Q. The concentrated fluid is filtered through filter-presses into U, and passes from here into the cooling apparatus. S V and V' are the steam apparatus and furnace for re-vivifying the animal charcoal. In the cooling apparatus S the hot cream-like sugar is kept in constant motion by a screw, and cooled off by serpentine pipes. Solidification is accelerated by throwing in finished sugar.

To Remove Gypsum from Solutions of Glucose produced with the aid of Sulphuric Acid. The solution of glucose formed by boiling the starch with dilute sulphuric acid is, after being neutralized with chalk, filtered, compounded with oxalate of barium and boiled down. The solution, after filtering, is entirely free from gypsum. In place of oxalate of barium, phos-

phate of barium may be used, or any other barium salt forming an insoluble combination.

Preparation of Pure Levulose. Prepare a 10 per cent. solution of cane sugar, add for every 100 parts of sugar 2 parts of hydrochloric acid, and heat to 140° F. At this temperature the fluid remains entirely colorless. The conversion into grape and fruit sugars takes place very slowly and regularly, 1½ pounds of sugar requiring about 17 hours. After complete conversion a 12 per cent. solution of inverted sugar is obtained. Allow the fluid to cool slowly to about 23° F. Then add to every 10 parts of sugar 6 parts of slaked lime pulverized and passed through a hair sieve, mix and stir thoroughly. The fluid congeals to a paste, the temperature rising about 2 degrees. Then press out the paste in order to separate the liquid lime-compound of grape sugar from the solid lime-compound of fruit sugar. Replace the latter in water and press it out again, repeating the operation as long as the wash-water turns to the right. The remaining mixture of lime-compound of levulose and excess of lime is suspended in water and saturated with oxalic acid until the lime-compound is accurately neutralized. The scarcely yellowish colored fluid is then filtered off from the oxalate of lime into a large beaker glass and placed in a cold mixture of snow and hydrochloric acid. Stir thoroughly until about ¼ of the water is frozen. Then throw the whole upon a linen filter, and, as soon as the greater part of the fluid is drained off, press out the residue. Replace the combined filtrates in the cold mixture and repeat the whole process until a very concentrated solution of levulose is obtained, and then dry the levulose syrup in a vacuum. Levulose thus obtained is pure and white.

A New Source for Supplying Mannite is, according to W. Thörner, the *Agaricus integer*, a common and easily recognized fungus. Boil out the comminuted fungus with fresh quantities of alcohol until the extracts, on cooling, separate no more crystals. The crystalline mass, consisting of separated mannite, is redissolved in alcohol and

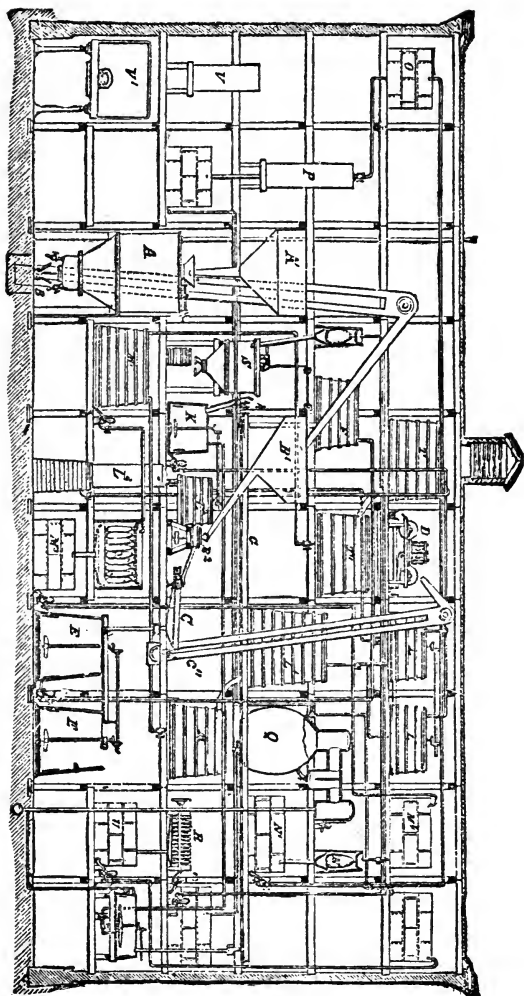

Fig. 40.—Jepp's Apparatus for Fabrication of Starch, Glucose, and Grape Sugar.

boiled with animal charcoal. From the filtered fluid the mannite crystallizes in snow-white needles. One hundred parts of *Agaricus integer* yield from 19 to 20 parts of mannite.

Purification of Sugar Beet Juice by means of Silica Hydrate. Heat the juice nearly to the boiling point and compound it with $\frac{1}{2}$ to 2 parts of silica hydrate of 10° B. to every 100 parts of juice, the quantity depending on the organic substances and organic alkaline combinations in the juice. In about 5 minutes add to the mixture 0.004 per cent. of lime in the form of milk of lime (or air-slaked) and then let it come to a boil. Remove the resulting precipitate by pressing and treat the filtrate like other juice, *i. e.*, filter and boil down.

To Prepare Strontia Sugar from Treacle and Syrup. By using 3 molecules of strontia to 1 molecule of sugar strontium saccharate is precipitated at the boiling point under ordinary or higher pressure. The precipitate is separated from the fluid in a hot condition and washed with hot water. The strontium saccharate thus obtained is decomposed by water at a lower temperature into basic saccharate and free strontium hydrate. The strontium saccharate is used for separating beet juice and other sacchariferous juices.

TEXTILE FABRICS AND TISSUES.

Coating Textile Fabrics with Metallic Substances. Fine comminuted metallic powder is mixed with an adhesive substance, as caoutchouc, etc., and the mixture applied either by hand or machine to the textile fabric, which is then dried and glazed. After glazing a pattern may be either pressed or printed upon the fabric.

Effect of Heat on Textile Fabrics. Recent experiments have shown that white wool, cotton, and silk may be heated to 248° F. for 3 hours without apparent injury, except that wool will show a slight change in color, especially when new. The same may be said of dyed wools, printed cottons, and most dyed silks; but some white silks turn brown by this heat, and some pink silks are faded by it. The same tem-

perature will, if continued for a longer period, slightly change the color of white wool, cotton, silk, and unbleached linen, but will not otherwise injure them. A heat of 293° F., continued for about 3 hours, slightly singes white wool, and less so unbleached and white cotton, white silk, and linen, both unbleached and white, but does not materially injure their appearance. The same heat continued for about 5 hours singes and injures the appearance of white wool and cotton, unbleached linen, white silk, and some colored fabrics of wool, or mixed wool and cotton, or mixed wool and silk. It is noteworthy that the singeing of any fabric depends not alone upon the heat used, but also on the time during which it is exposed. In these experiments the heat was obtained by burning gas with smokeless flames, and conducting the products of combustion, mixed with the heated air, by means of a short horizontal flue into a cubical chamber through an aperture in its floor, and out of it by a smaller opening in its roof. Fixed thermometers showed the temperature of the entering and outgoing currents, which represent the maximum and minimum temperatures of the chambers.

Feather-plush. A process has recently been patented in Germany whereby finely comminuted down is worked with textile materials into a fur-like fabric, in lengths of about 50 yards by 2 yards in width. The down may also be used in the manufacture of light bed-covers, wall-papers, etc., and for this feathers of little or no value and formerly considered useless can be utilized. The process is as follows: The feathers are comminuted by a machine representing a combination of a batting machine, fan and sieves. The resulting down is then carded in a carding engine together with 40 to 90 per cent. of other material and formed into a close fleece. By mechanical friction and the aid of steam the fleece is joined together in large pieces of a kind of felt, which is then converted into a cloth-like material by the fulling process. The resulting fabric is then thoroughly dried and steamed for some time at a very high temperature in a closed steam-box, resembling an appa-

ratus for shrinking cloth. By this process an intimate union is formed between the down and the other materials, the fabric assuming at the same time a plush-like appearance, which can be very much varied in the finishing.

Down-cloth. Seventy-nine to 85 parts of down are mixed with 20 to 30 parts of wool and 50 to 60 parts of oleic acid. The mixture is then passed through a batting machine, and then worked in succession in a breaking card, finishing card, and carding machine. The material is then spun and woven. The finished piece is freed from oil, fulled, raised, shorn, and dyed. The card-clothing of the rollers of the carding machine corresponds to the material to be worked. On the finishing card is arranged an endless cloth upon which rests another endless cloth, which receives the mixture from the porcupine, and, carrying it along, is wound with it around a roller. On the carding engine is also arranged an endless cloth upon which the fleece wound around the roller of the finishing card is unrolled and carried by it to the working rollers. There is a further contrivance on the carding engine by which one or more threads may be introduced into the roving in order to make the fabric more durable. The improvements in the gig consist in an arrangement of drums covered with carding between which the piece of cloth runs.

Improvements in the Treatment of Vegetable Fibres. The fibres after having been freed from foreign constituents are bleached in a bath of $\frac{1}{2}$ to 1 per cent. of ethyl chloride to 25 gallons of water. To give to them a silk-like gloss they are immersed for 3 hours in a bath of sodium carbonate or bicarbonate, then exposed to the fumes of burning sulphur, and finally thoroughly rinsed with water.

To give greater flexibility to the fibres, they are, after having been dried over hurdles, submitted to the action of glycerine vapors.

Improvement in the Preparation of Surfaces to be Printed on, Embossed, etc. A design or drawing on transparent paper is placed upon a layer of chrome-gelatine and exposed to the light. The surface of chrome-gelatine,

after the drawing has been removed, is washed. A very fusible metal, the Spence metal being the best adapted for the purpose, is then poured over the chrome-gelatine surface. The casting can be directly used, or fac-similes are prepared with the help of this metal-plate, either by the galvanoplastic or some other process.

In place of the design a drawing prepared by weaving, knitting, printing, etc., can be used. Such drawing is then coated with a thick coat of coloring matter or plastic material. In case the relief formed is not deep enough, it is improved by scattering any powder or fibrous substance upon the surface while it is still in a plastic state. It is then filled up with Spence metal, and the resulting plate used for printing. This process is also available for printing with type and for embossing.

New Method of Compressing the Fibres of Cotton Tissues, and Giving the Colors more Lustre. This invention is based upon the fact that cotton threads treated with cold caustic-lye are compressed $\frac{1}{2}$ to $\frac{1}{4}$. By this process apparently very fine tissues can be prepared from coarser, the colors appearing more intense and brilliant. The fabric gains in strength. A thread which would formerly break when loaded with 14 ounces will, after treatment, require a weight of 21 $\frac{1}{2}$ ounces.

New Yarn, called Pearl Yarn, consists of threads upon which at any desired intervals are fastened drops or pearls of a pasty substance, which, on congealing, assume the appearance of glass or crystals. The substance is prepared from wax, rosin, lacquer, gum, and enamel. The pearl yarn is prepared either by hand or a trough is used for the reception of the paste. Tubes are arranged in the trough, each of which is provided with an aperture below, from which a drop of the pearl substance exudes and is received by a thread held under the tube.

Oil-cloth. The customary process of stretching the tissue in a frame and coating it with a vegetable gluten makes the oil-cloth hard and brittle. It is claimed that animal gelatine, substituted for the vegetable gluten, remedies this defect. Boiling the pit of the

horns of ruminants makes the best gelatine for this purpose, the ordinary glue and gelatine not giving equally good results. To about 32 parts of melted gelatine add $\frac{1}{2}$ part of a saponifying material (borax being the best) and 16 parts of linseed-oil varnish, and allow the compound to congeal. Then bring it into a mill and mix it with 30 parts of mineral color soaked in water, such as kaolin, chalk, etc. Reduce the compound with naphtha, and bring it into the priming machine, where it may be applied to the tissue once or oftener. When the ground is sufficiently dry, the following composition is applied: 75 parts of kaolin are formed into a thick paste with water mixed in a mill with 33 parts of linseed-oil varnish and reduced with naphtha. Kaolin mixed with linseed-oil varnish has been previously used for the same purpose, but the kaolin having been mixed in a dry state with the varnish, the oil-cloth remained in consequence hard and brittle. Soaking the kaolin before mixing it with the varnish remedies this evil. The composition is also applied to the cloth by means of the priming machine, adding at the same time the ground color the oil-cloth is to have, and it finally receives the desired pattern in the ordinary way.

Apparatus and Process for Scouring and Removing the Oil from Fleece, Wool, and Silk, and Woollen Fabrics of every Description. The process is based upon the use of carbonic acid gas or carbonated water as a washing agent, with or without other ingredients generally used for washing, cleansing, and bleaching. The apparatus used consists of a revolving wash-barrel containing the

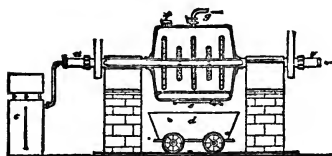

Fig. 41.

fabrics to be manipulated. The carbonic acid gas or carbonated water enters through the tube *a* (Fig. 41), and

steam from the opposite side through the tube *b*. Both steam and carbonic acid are converted into a fine spray by means of a perforated tube inside the barrel. *c* is the carbonic acid holder, *d* is a wagon for carrying away the fabrics, *e* the cover of the aperture through which the barrel is filled and emptied, *f* the safety-valve, *g* the escape-pipe for the gases.

Process for Animalizing Vegetable Fibres with Nitro-glucose (Nitro-saccharose). Nitro-glucose or saccharose is prepared by treating sugar with nitric or sulphuric acid and washing and kneading. The product is dissolved in acetic acid or methyl-alcohol, and the vegetable fibres are saturated with the solution. The nitro-glucose may also be produced upon the tissue by immersing it in a solution of sugar and submitting it to the action of nitric acid vapors or drawing it through a solution of the acid. Fibres prepared in this manner act in dyeing like animal substances.

Patent Process to give to Colored Fabrics a Metallic Lustre. For 5 parts of black tissues use a bath consisting of: Water 500 parts, sulphate of copper $\frac{1}{2}$ part, and tartaric acid $\frac{1}{2}$ part. The tissues are manipulated in this at a moderate heat for half an hour, then rinsed, placed in a decoction of 5 parts of logwood and some ebony shavings with the corresponding quantity of water, again rinsed and dried. They are then placed in a mixture of $\frac{1}{3}$ part of sulphate of copper, $1\frac{1}{2}$ parts of aqua ammonia, and 500 parts of water at a temperature of 167° to 190° F., for 12 to 15 minutes. They are then rinsed, and finally brought into solution of sodium hyposulphite of 25° B., again rinsed and dried.

Preparation of Fibres that can be Spun from Nettles, Hemp, Jute, etc. To facilitate the action of the chemicals used in the process the stems, which are generally very hard and woody, must be broken. This is best accomplished by passing the stems between fluted rollers and exposing them in a suitable vessel for a few hours to the action of steam, which separates the woody parts from the fibres, removes the vegetable gum mucus, etc., by loosening the substances enclosing the fibres. To make the action of the steam more effective,

it may be mixed with a small proportion of hydrochloric acid vapors. The stems are then placed for a few days in a lye prepared by slaking 10 parts of lime in 1 of water. The solution is used either cold or hot, according to the nature of the stems. Prepare a bath of 50 parts of caustic soda in 10,000 parts of water, and in it boil the prepared stems for 4 to 6 hours at a temperature of 212° to 248° F.; 500 parts of stems require about 4000 parts of water. For very hard or unripe stems the above bath can be strengthened by addition of caustic soda previously dissolved in water distilled over quicklime. The strength of the bath varies according to the condition of the stems, to be regulated only by actual experience. In the strengthened bath the stems may be left 6 to 8 hours at a temperature of 176° to 248° F. To remove the last traces of vegetable gum or mucus the stems are placed in a hot bath composed of water and ordinary soft soap. The fibres, now cleansed from all foreign substances, are bleached, various methods being in use.

I. Place the fibres for 1 to 3 hours in a bath containing 5 parts of chloride of lime to 1000 parts of water. The strength of the bath and duration of immersion must be governed by the conditions. If necessary a bath containing an aqueous solution of $\frac{1}{2}$ to 1 per cent. of ethyl chloride (spiritus ætheris chlorati) is used, which, it is claimed, bleaches the fibres without injuring them in the least.

II. Immerse the fibres for 15 to 30 minutes in a bath containing 10 parts of chloride of lime to 1000 parts of water. Then immerse them in another bath composed of 10 parts of magnesia in 1000 parts of water. Chloride of magnesium and free chlorine are formed, which last bleaches the fibre without injuring it. Drain the fibres, after being bleached, and bring them into a bath containing 5 parts of carbonate of potassium or soda to 1000 parts of water. Carbonic acid having a strong affinity for magnesia forms carbonate of magnesium, and the chlorine set free forms a fresh equivalent of bleaching salt, which finishes the bleaching of the fibres, this

being the principal object of the operation. The fibres are then washed either in cold or warm water to remove the adhering chlorine. As this has to be done very carefully several baths are used, either separately or combined. The fibres are placed, for instance, 5 to 10 minutes in a hot sulphuric acid bath of 140° to 176° F., in the proportion of 5 parts of sulphuric acid to 1000 parts of water. Or the moist fibres, after they have been washed, are placed for 1 to 2 hours in a room and exposed to sulphuric fumes generated by the burning of sulphur. The fibres when thoroughly washed have a silky lustre which can be augmented by a bath of a strong solution of sodium carbonate or bicarbonate. By again exposing the fibres to sulphurous fumes it is claimed that the carbonic acid which is developed splits the fibres, making them very fine and extremely soft. They are then again rinsed in water. To give the fibres the necessary degree of softness they are placed for 2 hours in a hot bath having a temperature of 176° to 248° F., and composed as follows: Two parts of olive or palm oil soap are dissolved in 100 parts of water, and the solution compounded with $\frac{1}{2}$ part of soda. The fibres when dry are once more passed through fluted rollers or a breaker. They are finally spread out upon hurdles, and in a closed room exposed to the action of weak glycerine vapors, whereby they obtain greater flexibility without injury to their silky lustre. They are now ready for spinning. The fibre in a finished state is soluble in strong acids, chloride of zinc, and soda.

Shoddy. How it is Made. Shoddy consists of old rags torn up for use in adulterating wool. Both woollen and cotton rags are used, but the former more so than the latter. The rags are first sorted and then go into the picker-room, entering first a machine for beating out dust and called "the willow." It consists of a cylinder provided with long teeth and boxed in. A fan is attached, which blows the dust into a long flue. The cylinder revolves at the rate of about 600 times per minute. The rags next go to the picker. This has a cylinder with teeth about 2 inches long, very sharp and set

close; it revolves about 1200 times per minute. The rags are fed by slow-moving rollers, which hold them so that the teeth of the picker-cylinder tear them in threads, and these threads are passed on to a machine called the "finisher" or "lumper." This is something like the picker, but not so powerful. It throws out the unworkable stock or lumps and reduces the good stock to finer texture. After leaving the lumper the stock is ready for mixing; that is, different weights of shoddy, cotton, and good wool are placed in piles, according to the grade of cloth to be made. The materials are then mixed in layers, often in such quantities as to weigh several tons. This mixture is then passed through the willow, to more completely mingle it, and then through the lumper. It then leaves the picker-room and goes to the card-room. The "stock," as it is now called, is placed in machinery called "breakers," which make it uniform in quality, and it then goes to the "condenser," by which it is formed into thin folds, from $\frac{3}{4}$ inch to 2 inches in width, according to the quality of the stock. It then goes to a system of rollers, which roll these thin folds into thread, which is run on to large spools and is ready for spinning. The carding machines are of different character, according to the work demanded. The spinning frame is generally called a "mule," and has on it from 600 to 700 spindles, and can work that many threads at once. The art of hiding the nature of shoddy is seen in great perfection in the weaving. By an arrangement of the loom machinery the inferior material is thrown to the back of the cloth and the better fibres to the front. By more complicated machinery certain arrangements of fibres can be made on the surface of the cloth, producing various forms of diagonal twills. To test the quality of the cloth take a thread of the filling and pull it apart. If it breaks off short, without any long fibres holding it together, it is shoddy. If, however, it draws out without breaking at once, and shows long fibres, then the body or filling contains pure wool, and the more of these long fibres are found the better the cloth. We would finally remark that nowadays it is very

good cloth which has 50 per cent. of good wool in it.

Silk Gauze. The warp is dressed with a solution of gelatine and runs only through two shafts. The wool is reeled dry, and in the shuttle is placed a small moistened sponge, through which the cocoon-thread runs during weaving. The raw fabric is immersed in a hot solution of gelatine, then half-dried, vigorously beaten between the hands, and then stretched in a frame.

Tinning of Tissues. Woollen or cotton fabrics can be provided with a close and flexible coating of tin having a silvery lustre. The process is as follows: Mix commercial zinc dust with an albuminous solution into a thin paste, and brush or roll the paste on the fabric. When dry the coating is fixed by coagulating the albumen by means of hot steam, and the fabric is then placed in a solution of chloride of tin. The tin precipitates itself in a finely-divided state upon the zinc. The fabric is then washed with water, and, when dry, is passed on to the glazing machine, when the tin will appear as a lustrous coating upon the fabrics. Beautiful effects can be produced by printing the fabrics, making them available for decorative purposes. Tinned linen, etc., can in many cases be substituted for tin-foil as an elegant and water-proof packing.

To Produce a Metallic Lustre upon fabrics saturate them with a metallic solution; for instance, acetate of lead, and bring them before they are entirely dry into a vessel, on the bottom of which is placed some metallic sulphide slowly decomposable by air, so that the sulphide of hydrogen which is formed acts upon the metallic salt.

Utilization of Short Hair. To make short, rough hair suitable like wool for spinning, weaving, or felting, treat it with a thin alkaline solution and then with diluted acid.

Utilization and Working of Jute. The best qualities of jute are of a pale yellow or silver-gray color, with a very high silky gloss, and feel agreeably soft and smooth to the touch. Jute is not as strong as hemp or flax, but sufficiently so for the production of durable coarse fabrics. Although the separate threads are comparatively fine they can

only be used for coarse yarns. The root ends, or jute-butts as they are called in commerce, are generally darker in color and harder and more woody than the middle and upper portions. The fibres are free from stems, and only inferior qualities exhibit dark scarf-skin cells adhering quite tightly. The fibres are generally $6\frac{1}{2}$ to 9 feet long, although there are some varieties 14 feet long. The medium qualities are of a dark brown color, while the ordinary qualities are yellow or reddish-brown, and both are harder and more woody than the best quality, and their root ends very hard and coarse. The jute-fibre is very hygroscopic, and in an ordinary state contains about 11 per cent. of water, and, if stored in a damp room, may absorb as much as 30 per cent. and more. The better qualities of raw jute are much used for enveloping submarine telegraph cables and as bandages for surgical purposes, for which they are especially prepared. If they are to be employed for bandages they are saturated either in the dry state with salicylic acid (salicyl-jute) or in a half-moist condition with carbolic acid (carbol-jute). Jute yarns are prepared according to two processes. By the first the jute is first cut up in stricks about $2\frac{1}{2}$ feet long, which are then heckled by machines, and finally worked like flax into finished yarn, but always upon the dry frame. This method is employed in England, France, and Belgium for a few numbers of yarns only, namely, for Nos. 16, 20, and 22, and furnishes also the article which comes into commerce under the name of "heckled yarn" or "jute line yarn."

The second process for all numbers from No. 14 down is almost generally used in Germany and exclusively in Austria. By this process the jute-stricks are torn to short fibres by special carding machines very strongly built, and these short fibres are joined together in an endless band, which is then stretched in the usual way in a drawing-frame, and double-milled. It is then converted into roving upon the fly-frame, and finally into finished yarn upon the dry frame. But the jute, before it is actually worked up, undergoes several

other processes in order to make it softer and more flexible. These consist in moistening the fibres with train oil and water, and then passing them repeatedly through between fluted rollers. The yarns and the threads prepared from them are either worked into actual jute-fabrics, which are used as a packing material, or employed in the production of mats, carpets, table-covers, and curtains, which, by reason of their naturally yellow and glossy color, are much in demand for decorative purposes. The yarns, either raw, bleached, or colored, are used as filling either by themselves or mixed with cotton warp. Jute yarns, mixed with cotton, wool, and flax, are also used in the manufacture of drills, bed-ticking, furniture reps, lamp-wicks, canvas of all kinds, and many small articles.

Utilization of Hop-stalks. In Sweden a strong cloth is manufactured from hop-stalks. The stalks are gathered in autumn and soaked in water during the whole winter. The material is then dried in an oven and woven as flax.

A *New Yarn* is produced in France in the following manner: Upon a mule is placed another row of rollers through which at different speeds is passed a colored or plain thread, but twisted in the reverse way of the yarn to be operated upon. Thus, when the spindles revolve, the two threads are twisted, but the additional yarn is untwisted. This double yarn is again twisted with the same or other yarn, but running it again in the opposite direction, which untwists the first thread and produces a very singular effect, and one which in the loom will, no doubt, produce a novelty.

TOBACCO. SMOKING TOBACCO, SNUFF, STERNUTATIVE POWDERS, ETC.

SMOKING TOBACCOS. *Brazilian Tobacco* is brought into commerce either in rolls or cut and in three qualities.

I. Known as "*Legitimo*," is prepared by mixing equal parts of best unribbed Brazilian leaf and Havana leaf.

II. Havana leaf alone is used for this and treated in the customary manner, as follows: Extract pounded cassia

bark 100 parts and sugar 300 parts in 2250 parts of soft water; then press out the liquor and add cinnamon water 500 parts, saltpetre 100 parts, wine vinegar 450 parts, and common salt 125 parts.

III. Ordinary American leaf of good dark brown color is used for this. For 500 parts of such leaf the following mixture is required: Pulverize dried plums 20 parts, tamarinds 15 parts, cassia bark 5 parts, figs 10 parts, and juniper berries 30 parts. Macerate the powder in 225 parts of soft water for 24 hours, and add to the resulting liquor: juice of Spanish licorice 30 parts, molasses 20 parts, honey and saltpetre each 10 parts.

Chinese or Star Tobacco. Yellow Virginia leaf is used and treated as follows: Comminute orris root 10 parts, large raisins 5 parts, angelica root 12½ parts, fresh walnut leaves 15 parts, calamus root and elder blossoms each 7½ parts; pour 187½ parts of water over them, digest for 24 hours, and then press out the fluid. Now mix in a glass matrass: Benzoin powder 1 part, pulverized storax ½ part, cinnamon blossoms 1 part, rosewood oil ¼ part, and spirit of wine of 70 per cent. 15 parts. Close the matrass with a piece of wet bladder perforated with a needle. Digest the whole in a sand-bath for 24 hours, then pour off the liquor and press out the residue. Mix the two fluids and the product is ready for use.

Canaster. To convert 500 parts of Virginia leaf into canaster proceed as follows: Pulverize 20 parts of cascarilla bark, 1½ parts of nutmeg, 5 parts each of orris root and lavender blossoms, and sift them into a tin tank, and pour over them 185 parts of a solution of 1½ parts each of purified potash and fresh burned lime in soft water. Cover the vessel and let it stand 24 hours in a warm place, so that the mixture is heated nearly to the boiling point without actually boiling. The liquor when cold is strained through linen and the residue pressed out. Then dissolve in the fluid thus obtained: Purified saltpetre and common salt each 10 parts, and white sugar 12 parts. Moisten the leaves with the mixture, and pile them together and turn them frequently, so that they become uniformly permeated with the liquor, which will be the case

in 6 to 8 days. While still moist the leaves are cut, and when dry packed in tin-foil or paper.

Half Canaster. I. Moisten 50 parts of Virginia leaf before cutting with the following mixture: Dissolve 2 parts of sugar in 24 of water, and add ⅙ part of cinnamon wine, ⅙ part of extract of mastic, and 2 of juniper wine. The tobacco after moistening is pressed into a barrel, remaining there 24 hours, when it is cut and packed.

II. Moisten 100 parts of Virginia leaf with the following mixture, obtained by boiling for 3 hours: Raisins 3 parts, bay-leaves ½, and pulverized cascarilla bark ¼ in water 80. Let the decoction cool and strain the liquor through a linen cloth, and then add 4 parts of cinnamon wine and 1½ of sugar. The tobacco, after moistening, is dried and cut.

Maracaibo Tobacco or Varinas Canaster. Finest Quality, No. I. Finest Havana leaf 30 parts, small Orinoco leaf and genuine Porto Rico leaf each 25, light yellow and green Virginia leaf each 10.

Quality No. II. Havana leaf 15 parts, Louisiana leaf 20, Porto Rico leaf 40, yellow Virginia leaf 15, and green Virginia leaf 10.

Quality No. III. Havana and Louisiana leaf each 5 parts, Porto Rico leaf 40, and yellow and green Virginia leaf each 25.

These mixtures have a very light color. When a darker color is preferred the yellow and green leaf is replaced by dark yellow or brown.

Ostend Tobacco consists of a mixture of American leaf. There are four varieties:

No. I. Porto Rico leaf 33 parts, light brown Maryland leaf 35, and brown Virginia leaf 32.

No. II. Louisiana leaf 45 parts, light yellow Virginia leaf 35, and light yellow Pennsylvania leaf 20.

No. III. Louisiana leaf 25 parts, brown Virginia leaf 30, and good brown Pennsylvania leaf 45.

No. IV. Equal parts of long Orinoco leaf, yellow Virginia leaf, and yellow Maryland leaf.

Petit Canaster comes into commerce cut and packed in tin boxes. There are two varieties of pure American leaf:

No. I. Long Orinoco leaf 10 parts, Louisiana leaf 45, Porto Rico leaf 45.

No. II. Louisiana leaf 5 parts, long Orinoco leaf 45, and brown Virginia leaf 50.

Petum Optimum, according to the Dutch Process. Free 50 parts of Virginia leaf from the stems and moisten it with the following mixture: Dissolve 3 parts of rock-candy in 60 of soft water, sprinkle the solution over the leaf, press the latter into a barrel, and then cut it. Dry the tobacco in the air, but not near a fire, and then sprinkle it with a mixture of juniper wine 1 part, extract of mastic and cinnamon wine each 2 parts, so that it is just moistened, and then pack it in tin-foil or paper.

II. Moisten 100 parts of Virginia leaf with water, let it stand 24 hours, cut and dry in an airy room. In the meanwhile boil the following ingredients for 3 hours in 32 parts of soft water: One part of raisins, 3 of yellow rock-sugar, and $\frac{1}{4}$ of bay-leaves, and, when the liquor is cool, add 3 parts cinnamon wine. Sprinkle the tobacco with the mixture and work it thoroughly through. Dry it for some time in an airy room, then put it in a barrel, let it stand in a cool place for 8 days, and then pack in paper or linen bags.

Portocarero Tobacco. Boil in 24 parts of water, 2 of loaf sugar, $\frac{1}{2}$ of pulverized fennel-seed, $\frac{1}{4}$ of pulverized cascarilla bark, $\frac{1}{4}$ of powdered cubeb, and a like quantity of powdered cloves. Moisten with the liquor 60 parts of Maryland leaf, allow it to lie for 8 hours, then cut, dry, and pack it.

Porto Rico Tobacco, according to the Dutch Process. Boil in a covered boiler for 3 hours: Best wine-vinegar 12 parts, water 90, honey 1, large raisins 3, and bay-leaves $\frac{1}{4}$. Filter the liquor and, when cooled off to milk-warm, treat with it 100 parts of Porto Rico leaf.

In Holland tobacco treated with the above mixture is put up in rolls and is in great demand.

Porto Rico Tobacco from Ordinary Leaf. For 100 pounds of ordinary leaf, cured for 1 year, the following mixture is used. When the leaves are thoroughly permeated they are piled together for 8 days and turned once every day. Com-

minute: Lemon peel, green dried orange peel, coriander seed, figs, and sassafras wood each 1 pound, elder blossoms 12 ounces, cassia and juniper berries each $5\frac{3}{4}$ ounces, and galanga 12 ounces. Pour 60 pounds of water over the above ingredients; allow them to digest for 24 hours; then pour off the liquor and press out the residue. Dissolve in the liquor 2 pounds of pure saltpetre, 3 pounds of common or rock salt, and 4 pounds of sugar. The product is now ready for use. To improve the scent of the tobacco in smoking, compound the above before using it with benzoin $2\frac{1}{4}$ ounces, mastic 1 ounce, myrrh $8\frac{3}{4}$ ounces, and spirit of wine of 60 per cent. $1\frac{1}{2}$ pints.

Swicent Tobacco (English Process). Remove the lower thick stems from 100 parts of Virginia leaf, and moisten the leaf with 60 parts of water, then cut it up fine and kiln-dry it. In the meanwhile boil the following ingredients in 10 parts of water: sugar 3 parts, raisins 2, and cascarilla bark $\frac{1}{4}$. Strain the liquor, when about milk-warm, through a linen cloth, and when it is entirely cold add 1 part of extract of mastic and $\frac{1}{2}$ of cinnamon wine. Moisten the tobacco with this mixture, and then pack in paper or linen bags.

Swicent Tobacco (Ordinary). Macerate $\frac{1}{4}$ part of powdered cascarilla bark 8 days in 2 parts of spirit of wine. Then boil the whole in 24 parts of water together with 2 parts of wine-vinegar, $\frac{1}{2}$ of bruised juniper berries, $\frac{1}{4}$ of saltpetre, and $\frac{1}{2}$ of bruised angelica root, strain the liquor and with it treat 100 parts of ordinary country tobacco.

Sweet-scented Tobacco. This is pure Virginia leaf, but most of the article sold under this name is an imitation prepared from ordinary country tobacco. Treat 100 pounds of ordinary tobacco in the usual manner. Prepare the following compound: Commi-
4 pounds of dried prunes, 2 pounds each of orange peel and rosewood, 1 pound of coriander seed, and 2 pounds of raisins; pour over them $8\frac{3}{4}$ ounces of purified potash and let the whole stand for 24 hours. Then heat it nearly to the boiling point, draw off the liquor, and press out the residue; dissolve in the liquor 2 pounds of purified saltpetre, 4 pounds each of common salt and honey. Pour 40 pounds of this

mixture over the 100 pounds of prepared tobacco.

Virinas Tobacco. I. Prepare a mixture by boiling in 90 parts of soft water 1 of raisins, 1 of raisin stems, 2 of fine sugar, and $\frac{1}{2}$ of pulverized fennel seed. Cover the boiler and let the mixture cool. When cold sprinkle 60 parts of yellow Porto Rico leaf and 40 of Maryland leaf with it; cut and kiln-dry the tobacco. Then sprinkle it with 3 parts of cinnamon wine, and pack it immediately.

Improvement of Inferior Qualities of Tobacco. We here give a number of mixtures which can be recommended for converting inferior qualities of leaf tobacco into good smoking tobacco. Each mixture is calculated for 100 pounds of leaf, the latter being treated with it in the usual manner. It is left to the manufacturer to adopt a suitable name for each brand.

I. Comminute orris root, juniper berries, and coriander seeds each $8\frac{1}{2}$ ounces; pour $3\frac{1}{2}$ gallons of water over them and let the whole digest 24 hours. Now dissolve saltpetre 2 pounds, sugar syrup 4 pounds, in water $1\frac{1}{2}$ gallons, and mix the solution with the above liquor. Then macerate in a glass matrass with the assistance of heat $8\frac{1}{2}$ ounces of liquid storax in 2 pounds of strong spirit of wine, filter the extract and compound it with the above mixture, and the mixture is ready for use.

II. Comminute cascarilla bark, angelica root, cinnamon blossoms, and badiane each 7 ounces, and cloves $2\frac{1}{2}$ ounces; pour 4 gallons of water over them, macerate the whole 24 hours, then press out the liquor and compound it with a solution of $1\frac{1}{2}$ pounds of saltpetre and $2\frac{1}{2}$ pounds of brown syrup in $1\frac{1}{2}$ gallons of water, and it is ready for use.

III. Comminute cassia bark, orris root, licorice root, angelica root, and rosewood each 7 ounces. Macerate with 4 gallons of water, press out the liquor and compound it with a solution of 2 pounds of pure saltpetre and $3\frac{1}{2}$ pounds of white sugar in $1\frac{1}{2}$ gallons of water.

IV. Comminute juniper berries and fresh bay-leaves each $1\frac{1}{2}$ pounds, fresh walnut leaves 2 pounds, and green oranges $8\frac{1}{2}$ ounces; macerate with 4 gal-

lons of water for 24 hours, and press out the fluid. Now pound in a mortar 1 fluid ounce of oil of lemon and $\frac{1}{2}$ ounce of amber together with $3\frac{1}{2}$ pounds of white sugar; dissolve the mixture in $1\frac{1}{2}$ gallons of water, add 2 pounds of pure saltpetre, and mix this solution with the above liquor, and the mixture is ready for use.

V. Comminute orris root and angelica root each 7 ounces, vanilla 1 ounce, and cassia bark $8\frac{1}{2}$ ounces. Pour 4 gallons of water over the ingredients, let the whole stand for 24 hours and then press out the liquor. Rub up $1\frac{1}{2}$ pounds of white sugar with a like quantity of rosewood oil and $8\frac{1}{2}$ fluid ounces of oil of bergamot, add $1\frac{1}{2}$ pounds of pure saltpetre, dissolve the mixture in $1\frac{1}{2}$ gallons of water, and compound the solution with the above liquor.

VI. Convert into a coarse powder cascarilla bark 7 ounces, cassia bark 4 ounces, digest with 4 gallons of water for 24 hours, and press out the liquor. Now rub up 2 pounds of sugar with $\frac{1}{2}$ fluid ounce each of Peruvian balsam and oil of cloves, add $1\frac{1}{2}$ pounds of pure saltpetre, dissolve the mixture in $1\frac{1}{2}$ gallons of water, and compound it with the above fluid.

VII. Pulverize cassia bark and badiane each 4 ounces, nutmeg 2 ounces, and purified potash $3\frac{1}{2}$ ounces; digest them 24 hours in 4 gallons of water, then pour off the fluid and press out the residue. Now dissolve Peruvian balsam and olibanum each 1 fluid ounce in strong spirit of wine 1 quart, add 2 pounds of sugar and $1\frac{1}{2}$ pounds of saltpetre, and mix the solution with the above liquor.

VIII. Convert into a coarse powder orris root $8\frac{1}{2}$ ounces, cardamons with their shells $2\frac{1}{2}$ ounces, cubeb $2\frac{1}{2}$ ounces, cassia bark 4 ounces, cloves 1 ounce, mastic $2\frac{1}{2}$ ounces; digest them in $2\frac{1}{2}$ gallons of water and 1 quart of alcohol of 70 per cent. for 24 hours, and then pour off the liquor. The residue is extracted with $2\frac{1}{2}$ gallons of water, with the assistance of heat, and the liquor obtained from this mixed with the first. Then dissolve in the mixture $3\frac{1}{2}$ pounds of white sugar and $1\frac{1}{2}$ pounds of saltpetre, and add to the whole $1\frac{1}{2}$ gallons more of water,

IX. Comminute the following ingredients and macerate them with $\frac{1}{2}$ gallon of spirit of wine of 60 per cent.: Sassafras wood $8\frac{1}{2}$ ounces, cubeb 4 ounces, cloves $2\frac{1}{2}$ ounces, rosewood and fennel seed each 7 ounces, and, after 24 hours, press out the liquor. The residue is macerated with 4 gallons of hot water, the fluid poured off and the residue pressed out. Dissolve in this last liquor $2\frac{1}{2}$ pounds of white sugar, $1\frac{1}{4}$ pounds of pure saltpetre, and then mix the whole with the liquor obtained first.

X. Comminute the following ingredients and macerate them 24 hours in $2\frac{1}{2}$ gallons of soft water: Orange peel $8\frac{1}{2}$ ounces, coriander seed 7 ounces, and preserved rose leaves $1\frac{1}{2}$ pounds, and then press out the liquor. Macerate at the same time $1\frac{1}{2}$ ounces of nutmeg and $2\frac{1}{4}$ ounces of storax with $\frac{1}{2}$ gallon of spirit of wine of 60 per cent., press out the liquor and dissolve in it $1\frac{1}{2}$ fluid ounces of oil of bergamot and $1\frac{1}{2}$ pounds of sugar-syrup. Now mix this gradually with the first liquor and then dissolve in the whole $1\frac{1}{2}$ pounds of saltpetre.

XI. Comminute: Cascarilla bark $4\frac{1}{2}$ ounces, orris root 7 ounces, badiane $3\frac{1}{2}$ ounces, cubeb $2\frac{1}{2}$ ounces, and galanga $3\frac{1}{2}$ ounces. Digest them in 4 gallons of water in the sand-bath for 24 hours, and then press out the liquor. In $\frac{1}{2}$ of the liquor dissolve $1\frac{1}{2}$ pounds of sugar rubbed up with 1 fluid ounce of oil of cloves, and in the other half 1 pint of licorice juice and $1\frac{1}{4}$ pounds of saltpetre, and then mix both thoroughly together.

XII. Comminute: Fresh lemon peel and fresh orange peel each $8\frac{1}{2}$ ounces, cubeb $3\frac{1}{2}$ ounces, calamus root and coriander seed each 7 ounces, and figs $1\frac{1}{2}$ pounds; macerate 24 hours in 4 gallons of soft water, strain off the liquor, and dissolve in it 2 pounds of sugar-syrup and $1\frac{1}{2}$ pounds of pure saltpetre.

To Remove the Disagreeable Smell and Taste of Inferior Qualities of Tobacco. Treat 100 parts of ordinary cured tobacco with a mixture of solutions of $1\frac{1}{2}$ to 2 parts of potash in 100 parts of water and 20 of soda water-glass in 500 to 600 parts of water. The solution is poured over the leaf, the

latter remaining in it 2 days, with frequent turning. The solution is then poured off and the tobacco dried.

SNUFF MANUFACTURE. The tobacco leaf is well fermented, then dried and ground. The snuff-mill resembles somewhat a coffee or cocoa-mill with a continuous rotation of the cone or crusher. The ground tobacco travels on an endless cloth to a vibrating sieve where it is sifted, the fine particles are carried forward into a box, while the coarser are returned to the mill to be reground.

Bürenburg Snuff. Treat 100 pounds of ground tobacco with a sauce prepared from the following ingredients: Brown syrup 2 pounds, loaf sugar $6\frac{1}{2}$ pounds, oil of jasmine $1\frac{1}{2}$ fluid ounces, oil of bergamot $\frac{1}{2}$ fluid ounce, purified potash $3\frac{1}{4}$ pounds, common salt $12\frac{1}{2}$ pounds rose water $8\frac{1}{2}$ pounds, and soft water $2\frac{1}{2}$ gallons.

Bergamot Snuff. Treat 100 pounds of ground tobacco with the following mixture: Stems of American tobacco cut up $4\frac{1}{2}$ pounds, rasped rosewood $4\frac{1}{2}$ pounds, calamus root and orange peel cut up each 2 pounds, angelica root cut up 1 pound, loaf sugar $4\frac{1}{2}$ pounds, oil of bergamot 2 fluid ounces, oils of lemon and lavender each $\frac{1}{2}$ fluid ounce, elder flower water $4\frac{1}{2}$ pounds, rose water $6\frac{1}{2}$ pounds, purified potash 2 pounds, pure common salt $12\frac{1}{2}$ pounds, and soft water 2 gallons.

Dutch Musino Snuff. Convert 100 pounds of fat Virginia leaf to a coarse powder and mix it with the following ingredients previously pulverized: Cassia bark, orange peel, angelica root each 1 pound, galanga and Brazil wood each 2 pounds. Treat the above with the following mixture: Dissolve loaf sugar 2 pounds, saltpetre 1 pound, sal-ammoniac $3\frac{1}{2}$ pounds, common salt 10 pounds, and purified potash $3\frac{1}{2}$ pounds in elder flower water $2\frac{1}{2}$ gallons.

Espaniol or Sevilla Snuff. Convert 100 pounds of Orinoco or Havana leaf into a fine powder, and treat it with a mixture prepared from the following substances: Purified potash $4\frac{1}{2}$ pounds, common salt $5\frac{1}{2}$ pounds, cassia water $1\frac{1}{2}$ gallons, melilot water and rose water each $\frac{1}{2}$ gallon, tonka beans 2 ounces, and color with 3 to 4 pounds of colcothar.

Frankfort Snuff. Convert 100 pounds of leaf tobacco into powder and treat it as follows: Stems of Virginia tobacco cut up 4½ pounds, bruised juniper berries 4½ pounds, elecampane root cut up 12½ ounces, cassia bark, St. John's bread, tamarinds, juniper-berry juice, orange peel, and purified potash each 2 pounds, licorice juice and sal-ammoniac each ½ gallon, brown syrup 3½ pounds, pure saltpetre 1½ pounds, and water 4 to 4½ gallons.

Parisian Rappée. Boil dried prunes 8½ pounds, juniper berries 1 pound, tamarinds 4½ pounds, syrup 3½ pounds, sal-ammoniac 8½ ounces, salt of tartar 1 pound, and common salt 12½ pounds in 6 gallons of water, and then add ½ gallon of French brandy and 1½ quarts of wine-vinegar. Moisten as much tobacco powder as possible with this mixture and pack the finished snuff in tin-foil. It improves with age.

Rappée (Genuine). Boil in a covered boiler for 1 hour, in 5 gallons of water, 1 pound of licorice root cut up, 8½ ounces each of calamus root and bay leaves, and 1½ pounds of best logwood. Filter the decoction while still warm into a small barrel and dissolve in it, stirring constantly: Common salt 9½ pounds, potash 1 pound, sal-ammoniac 4½ ounces, and sulphate of iron 8½ ounces. When all is entirely dissolved and thoroughly mixed add 2½ quarts of wine-vinegar. With this moisten 100 pounds of ground tobacco, press the snuff into a barrel, and let it stand well covered for 6 weeks, when it is ready to be packed in tin-foil.

St. Vincent Rappée. Convert 100 parts of tobacco into powder and treat it with the following mixture: Stoned plums 4 parts, honey 2, bruised juniper berries 1, calamus root chopped up ½, angelica root cut up ¼, sal-ammoniac 4, purified potash 2, wine-vinegar 6, pure common salt 12, and soft water 24.

STERNUTATIVE (SNEEZING) POWDERS. *Green Sternutatory.* Convert into a fine powder leaves of marjoram, sage, pennyroyal with the flower, betony, and origan each 30 parts, and pass the powder through a hair-sieve. Then add 15 parts of pulverized orris root, 3 parts of cloves, and 2 parts of cinnamon, each pulverized by itself. Mix the powders intimately and color

with 1½ parts of fine indigo and 2½ parts of turmeric rubbed to an impalpable powder, and moistened with spirit of wine. This imparts to the powder a green color. Finally add a few drops each of the following oils: marjoram, cajeput, lavender, and bergamot.

Variiegated Sternutatory. Pulverize dried corn flowers, common marigolds, lavender flowers, leaves of marjoram, sage, and savory each 2 parts. Pass the powders through a fine sieve, and then add the following ingredients all finely pulverized and rubbed up with ½ part of sugar: White sandal wood, yellow sandal wood, orris root, cinnamon, cloves, zedoary of each ½ part, and musk ⅙ part, and finally oils of cloves, cinnamon, and cardamon each ⅙ part. Mix all intimately with an addition of 2 parts of spirit of wine, and preserve in well-corked glass bottles.

White Sternutatory. Pulverize: Orris root and cinnamon each 30 parts, white Castile soap 6 parts, white sugar 15 parts, arum root 3 parts, white hellebore ½ part. Mix intimately and add a few drops of oil of marjoram and essence of ambergris.

Sternutatories for Cold in the Head. I. Convert into a fine powder and mix: Dried leaves of the witch-hazel 3 parts, marjoram blossoms and lavender blossoms each 1 part.

II. Valerian leaves and snuff each 8 parts, oils of lavender and marjoram each a few drops.

III. (*Corrizino*). Mix: Salicylic acid ½ part, tannin 2½ parts, and pulverized borax 2½ parts. Or, Sodium salicylate 10 parts, rose leaves 20 parts, and snuff 70 parts.

Perfumes for Cigars. I. Fluid extract of valerian 1 ounce, tincture of tonka beans 8 ounces, alcohol 23 ounces.

II. Valerianic acid 3 drachms, butyric aldehyde 10 minims, acetic ether 40 minims, and sufficient alcohol to make 64 ounces of mixture.

III. Tincture of valerian 4 drachms, butyric aldehyde 4 drachms, tincture of vanilla 2 drachms, ethyl-nitrite 1 drachm, alcohol 5 ounces, and sufficient water to make 16 ounces of mixture.

Turkish Smoking Tobacco. The pe-

cular flavor of this tobacco depends not so much, as is generally supposed, on climatic conditions and a particular sauce, as on the peculiar treatment of the leaf. As soon as the leaves have been cut, they are moistened with soft water, and then piled up in layers on the floor of the tobacco house, a small quantity of melilot (*Herba meliloti*) being scattered upon each layer. In a few days the tobacco begins to ferment, becomes hot and diffuses a pungent but stupefying smell. When fermentation is complete, which is recognized by the pile becoming cold, the leaves are freed from the adhering melilot, and then strung on cords or packed in boxes.

The honey-*aroma* of the melilot has been imparted to the tobacco during fermentation, the cumarin of the melilot forming very likely a new combination with the pectine substances of the tobacco, since without fermentation the desired result is not obtained. In some parts of Servia and Turkey the tobacco, after cutting, is slightly sprinkled with honey-water, and then pressed for transportation into leather bags or tin boxes.

To Impart to Common American Tobacco the Flavor of Havana Tobacco. To dissolve the gummy substance, which causes the bad taste, soak the tobacco in cold or hot water for 6 to 12 hours. The tobacco is then freed from the gum by pressing, dried, and steeped in an infusion of stems and ribs of genuine Cuba tobacco, and again dried. Leaves thus prepared are equal to imported leaf, and can be used as wrappers for Havana fillers without injury to the taste of the cigars.

New Process of Preparing Tobacco. Fill an enamelled sheet-iron pot with pressed tobacco leaves and cover it with a perforated lid to allow the escape of the gases. Heat the vessel gradually in a sand or water-bath so that in the course of 6 hours the temperature rises to 212° F., but in the first 3 hours it must not rise above 180° F. The tobacco curls, loses weight, and the leaves, which have assumed a darker color, are covered with a grayish dust. Tobacco thus prepared burns well, has an agreeable odor, and

is especially suitable for the manufacture of cigars, since it is freed from all injurious constituents.

Preparation of Leaf Tobacco for Cigars. Prepare a lye from red and white beech-ash, filter it while hot, and after pouring it boiling hot over the tobacco leaves let them soak for 24 hours. Then rinse the tobacco in baskets with clean water, and press and dry. When thoroughly dry the leaves are treated as follows: Boil for one hour over a moderate fire 28 parts of beer-wort, $\frac{1}{2}$ of powdered cubebs, $\frac{1}{2}$ of bay-berries, $\frac{1}{2}$ of bruised juniper berries, $\frac{1}{2}$ of powdered corianderseed, and $\frac{1}{2}$ of storax. In another vessel boil 1 part of wine and $\frac{1}{2}$ of powdered cascarilla bark previously soaked for 12 hours in the wine and add the decoction to the first liquor. Pour off the supernatant liquid; when cold, moisten the tobacco with it.

To give to cigars, made from tobacco prepared as above, the odor of genuine Havana tobacco, proceed as follows: To 100 parts of French wine add 2 parts of cascarilla bark and 2 of vanilla previously grated with 15 of sugar. Cork the flask and let it stand in a warm place for 8 days. Then pour off the liquid and add 50 parts of mastic extract. Moisten the cigars with this and pack them in boxes. Keep the lids of the boxes nailed down to prevent the access of air.

VINEGAR. MANUFACTURE OF ORDINARY AND FINE TABLE VINEGARS.

Altwater's Process of Manufacturing Vinegar. A. *Arrangement of the Factory.* The building should be solid, with tight fitting windows and doors to prevent outside atmospheric influences. The walls should be covered with hard plaster or clay, not lime-washed, but coated with asphaltum, and all wood and iron painted with oil paint.

B. *Utensils.* It is best to use conical barrels, as represented by Fig. 42, each of a capacity of about 265 gallons.



Fig. 42.

The use of smaller barrels is not advisable, since experience has shown that a uniform temperature cannot be kept up in them, thus preventing the vinegar from attaining the proper quality.

Only beech-wood *but recently cut* should be used in the manufacture of vinegar. The billets are sawed up in pieces 18 inches long; these are again divided into flat pieces 12 inches thick, which are then converted by means of a large plane into fine shavings, and the latter lixiviated by steeping in water for 2 days.

The barrels are arranged in the vinegar-room of the factory in such a way as to allow a person to pass between them and the wall, so that, in case a barrel leaks or a hoop bursts, the damage can be conveniently repaired. The barrels should stand about 3 feet above the floor, and a platform about 5½ feet high run in front of them, to allow the workmen to pass along and conveniently look into the barrels.

The barrels are filled with shavings; and the latter stamped down so as to leave a space of 6 inches between them and the top of the barrel. Immediately upon the shavings comes a perforated cover, so secured that no fluid can transude between it and the barrel-staves. The barrel is then covered with a cover of pine-wood joined

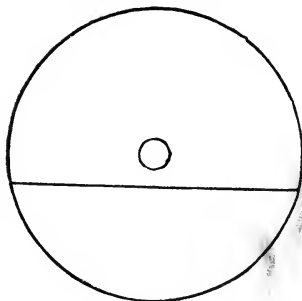

Fig. 43.

together with wooden nails and consisting of two parts, the front part being somewhat smaller than the back.

In the centre of the cover is a hole as shown in Fig. 43. The perforated cover is made of oak-wood 1 inch thick, and strengthened with cross-pieces to prevent its warping. The holes are bored or, what is better, burned through with a thin piece of iron, and should be about 1 inch apart. In the four large holes seen in the illustration (Fig. 44) tubes ½ inch in diameter and projecting 3 inches above the cover are placed. At a distance of 2 inches below the perforated cover a hole is bored in the right side of the barrel, in which is placed a thermometer, so that

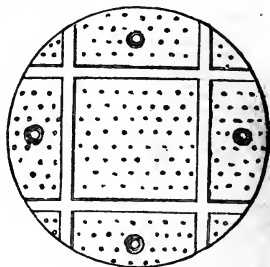

Fig. 44.

the temperature can always be observed. Twelve inches above the bottom of the barrel is a large wooden faucet, and under this stands a bucket capable of holding 2½ gallons without becoming too full. Fig. 45 represents the entire arrangement. When everything is in order the barrels are acidulated in the following order.

First Day. At 5 o'clock P. M. acetic acid is heated in a tinned boiler to 122° to 167° F. Ninety gallons of this are poured into each tank, 1 wine-glassful of whiskey of 25 per cent. being added to every bucketful. The barrels are then allowed to stand quietly till the next day.

Second Day. The next morning at 7 o'clock the faucets are turned to test whether all the acetic acid has been absorbed by the shavings, or whether there is any fluid in the barrel. Should the quantity of fluid be very small 90 gallons of warm acetic acid with the

addition of the above-mentioned quantity of whiskey are again poured into each barrel, and the latter allowed to stand quietly for a few hours. At 2 o'clock P. M. $2\frac{1}{2}$ gallons of liquor are drawn from each barrel into the buckets standing under the faucets, and poured back over the contents of the barrel. This operation is repeated at 3 P. M.,

Taking barrels I., II., and III. as an example, at 5 o'clock A. M. $2\frac{1}{2}$ gallons are drawn from each barrel, that drawn from No. III. being conveyed to the storing-barrel in the cellar as finished vinegar. The bucketful drawn from No. I. is poured upon the contents of No. II., and that from No. II. upon those of No. III. Upon I. is poured $2\frac{1}{2}$

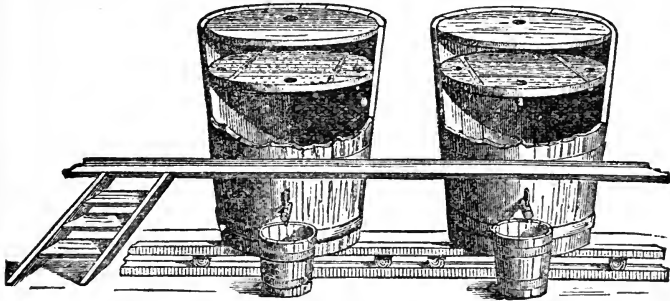

Fig. 45.

but with an addition of a wine-glassful of whiskey to each bucket. The operation is repeated in the following order:

At 4 P. M. as at 2 P. M., without an addition of whiskey; at 5 P. M., as at 3 P. M.; at 6 P. M. as at 4 P. M.; at 7 P. M. as at 5 P. M.; at 8 P. M. as at 4 P. M.

Third Day. At 5 A. M. as at 3 P. M.; at 6 A. M. as at 2 P. M.; at 7 A. M. as at 3 P. M.; at 8 A. M. as at 2 P. M.; at 9 A. M. as at 3 P. M.; at 10 A. M. as at 2 P. M.; at 11 A. M. as at 3 P. M.; at 12 M. as at 2 P. M.; at 1 P. M. as at 3 P. M.

As will be seen from the foregoing, at the even hours the $2\frac{1}{2}$ gallons are poured back without an addition of whiskey; while at the odd hours 1 wine-glassful of whiskey of 25 per cent. is added to every $2\frac{1}{2}$ gallons poured back over the contents of the tanks. This process is continued for 2 or 3 days more, after which the tanks will have become heated and the thermometer show a temperature of 86° to 100° F. The acidulating of the tanks is now finished and the regular fabrication is proceeded with.

Three barrels are worked together so that barrels I., II., and III., and barrels IV., V., and VI., and so on, belong to one set.

gallons of diluted whiskey of 7 per cent. Tralles. The same operation is repeated at 6 o'clock A. M. At 7 A. M. $2\frac{1}{2}$ gallons are drawn from each barrel, and poured back upon its contents. At 8 A. M. $2\frac{1}{2}$ gallons are again drawn from each barrel. To the quantity drawn from No. I. is added $\frac{1}{4}$ pint of whiskey of 25 per cent. T., and is then poured upon the contents of No. II. That drawn from No. II., without an addition of whiskey, is poured upon those of No. I.; that drawn from No. III., to which has been added the same quantity of whiskey as to No. I., is poured back into the same barrel. At 10.45 A. M. $2\frac{1}{2}$ gallons are drawn from each barrel, and poured back over the contents. The operations are repeated as follows:

At 12 M. the same as at 5 A. M.; at 1.45 P. M. the same as at 8.45 A. M.; at 3 P. M. the same as at 12 M.; at 4.30 P. M. the same as at 8.45 A. M.; at 6 P. M. the same as at 10.45 A. M.; at 7 P. M. the same as at 12 M.; at 8 P. M. the same as at 7 P. M.

As will be seen ready vinegar is always taken from No. III. 6 times a day, namely at 5 o'clock, 6, 12, 3, 7, and 8, yielding daily about 16 gallons of 45° to 50° .

The principal point in the manufacture of vinegar is strict regularity. Should it happen that through an irregular pouring the temperature of the barrels has sunk below $72\frac{1}{2}^{\circ}$ F., the barrels must be allowed to stand quietly for 1 or 2 days until the proper temperature has been restored. A temperature of 70° to 77° F. should always prevail in the factory, and one of 86° to 104° F. in the barrels. The vinegar should be immediately conveyed into the cellar. It is first stored in uncovered barrels, filled loosely with shavings, where it remains for 2 days, and is then drawn off into storing-barrels.

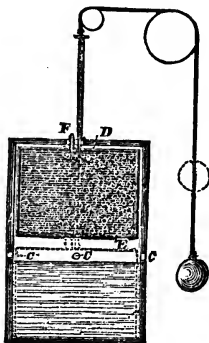

Fig. 46.

Plunging "Vinegar Producers." In the vessel A (Fig. 46) moves a plunger E provided with a perforated bottom. It is filled with shavings and periodically immersed in the vinegar-stock contained in A. The air enters through the aperture C, and passes out through the pipe F. A and E are hermetically closed by the rubber ring D, fastened either to A or E.

Utilization of Cork-waste in the Manufacture of Vinegar. The wood shavings generally used in the manufacture of vinegar act vigorously for some time, but lose perceptibly in efficiency. This is explained by the fact that the shavings as soon as permeated with the fluid press down the layers beneath them by their increased weight, and thus prevent a free access of air.

It has, therefore, been recommended to replace the shavings by cork-waste. The elasticity of cork is increased by its becoming moist, and a compression of the filling need not be feared even in very deep barrels. In the cracks of the cork many small organisms are found, and among them a large quantity of vinegar-bacteria, in consequence of which barrels filled with cork-waste become quickly acidulated.

Concentration of Vinegar by Means of Calcium Chloride. Two glass vessels, one containing vinegar and the other calcium chloride, are placed in a glass holder. The vinegar gradually yields water to the calcium salt.

To Prepare the Yellow Color for Coloring Vinegar. Melt 250 parts of pulverized white sugar in a boiler over a clear fire. When the syrup is thick enough to drop slowly from the stirring implement add 1000 parts of water, and after mixing this thoroughly with the sugar syrup the color is ready for use.

To Prepare Acetic Ether. Place 600 parts of sodium acetate in a tubulated glass retort; pour over it 420 parts of crude sulphuric acid mixed with 340 parts of spirit of wine, and distil until 370 parts of fluid have passed over. Then compound the distillate with a solution of potassium acetate in water until the ether is separated, and rectify this over 5 parts of calcined magnesia.

Quick Vinegar Process. Mix alcohol of 80 per cent. with 6 parts of water and $\frac{1}{100}$ part of yeast, or some other ferment containing nitrogen, and heat the mixture to about 80° F., and cause it to trickle from cords fastened to a shelf placed over beech-wood shavings soaked in vinegar and packed in a cask bored with holes to permit a circulation of air. The oxidation of the alcohol soon raises the temperature to about 100° F., which occasions a free circulation of air among the shavings. The mixture is passed 3 or 4 times through the cask, and in about 36 hours the conversion into vinegar is completed. The oxidation of the alcohol in this process is found to be arrested by the presence of essential oils, or of creosote and similar antiseptic substances.

Production of Vinegar by Means of Bacteria. The process first introduced

by *Pasteur* consists in planting (sowing) acetic acid bacteria (mother of vinegar) upon a mixture of wine and vinegar, or water with 1 per cent. of acetic acid and 2 per cent. of alcohol and mineral nourishing salts, and, after the conversion into acetic acid of half the alcohol used, adding alcohol daily in small portions until the fluid contains enough of it to give the vinegar the degree demanded in commerce. In order to add the alcoholic fluid without destroying the bacteria by immediate contact, two gutta-percha tubes perforated on the sides are fastened upon the bottom of the vat.

Mr. E. Wurm, after having obtained satisfactory results by experimenting in a small way, commenced the fabrication of vinegar on a large scale according to *Pasteur's* method. The mode of manufacture is as follows: Large wooden vats are charged with 50 gallons of the above vinegar mixture, and the nourishing salts consisting of 0.01 per cent. each of the phosphates of potassium, calcium, and magnesium. The vats are covered with tight wooden lids. The air is admitted through small holes in the sides. The bacteria are planted by means of a thin spatula of wood, and the fluid heated to 77° to 86° F., while the room in which the vats are located has a permanent temperature of 86° F. The percentage of acetic acid (1 per cent.) in the setting-fluid, recommended by *Pasteur*, was found too low, since a fluid so weakly acidulated is easily attacked by *saccharomyces mycoderma*, which prevent the growth of the acetic acid bacteria and the formation of vinegar by a direct combustion of the alcohol present into carbonic acid. Experiments proved that with an addition of 2 per cent. of acetic acid a pure growth of bacteria was obtained, while at a lower percentage, up to 1.2 per cent. of acid, the formation of *saccharomyces mycoderma* increased, and that of bacteria decreased. The addition of 2 per cent. of alcohol recommended by *Pasteur* was found to be sufficient. The formation of vinegar progressed now in the following manner: The planted bacteria covered the entire surface in 24 to 36 hours, the temperature of the fluid rising to 93½° F., and a strong smell of acetic acid becoming at the same time

perceptible. The practical yield of acetic acid is less than that promised by theory. The loss of alcohol by this method amounts to 10 to 15 per cent., while, when casks filled with shavings are used, it is from 12 to 15 per cent. in the production of ordinary acetic vinegar spirit of 23 per cent.; 2 per cent. by volume of alcohol furnished acetic acid of 1.7 to 1.8 per cent., the production of stronger vinegar requiring therefore an addition of alcohol. This must only be done when but ½ to ¼ of 1 per cent. of alcohol is present in the mixture, and the fluid coming in contact with the bacteria must never contain over 0.5 per cent. of alcohol, since, as *Pasteur* has already shown, a too strong addition of alcohol may easily destroy the formation of vinegar. The alcohol to be added is distributed in the fluid by means of a strong perforated porcelain tube reaching from the bottom of the vat to the surface of the fluid; not more than ⅙ of 1 per cent. should be added daily. When the vinegar has acquired the desired degree of strength it is drawn off into a clarifying vat in order to free it from turbidity caused by adhering particles of the plant. The other vat is then thoroughly cleansed with brushes and charged anew. The principal requisites for the success of the operation are pure bacteria seed, a uniform temperature of 86° F., and a well-regulated addition of alcohol. By strictly observing these precautions this new process can be very easily carried out, and offers the following advantages: 1. It produces vinegar in one-half the time of any quick process formerly used. Ten vats yield daily as much acetic acid as 3 barrels 9½ feet high, filled with shavings; but the cost of ten vats, with all appurtenances, is scarcely one-half that of the casks with the necessary filling. 2. By a suitable arrangement of the vats less room is required. 3. By reason of the vats being emptied in 10 to 15 days and cleansed, the vinegar-eels (vibrios) have no time to increase in a disturbing manner. It is only necessary to see that the fungus seed is not taken from a fluid containing eels, and this can be easily avoided since the eels are perceptible to the naked eye. If, in spite of all precautions, the fluid in one of the

vats should become eely, it is drawn off and heated by means of boiling water or steam to 140° F., and the vat itself scoured with boiling water and a little sulphuric acid, and the fluid, after cooling, replaced in it. 4. While the acidulation of a new barrel filled with shavings requires 4 to 8 weeks, and the vinegar produced during the first 4 weeks has always a strong taste of wood, *Pasteur's* method furnishes at once a good product, without any loss of vinegar, and the work can be interrupted at any time, it being only necessary to provide a stock of fungus seed. The manufacture is simpler, surer, and cheaper, but requires a daily and accurate controlling of the working vats.

White Wine Vinegar is produced in France from light wines. A little vinegar is poured into a cask partially open at the top, together with 5 to 6 gallons of white wine, which has been allowed to trickle over wood shavings. In a few days, during which the temperature is maintained at about 80° F., a fresh quantity of wine is poured in, and in the course of 12 to 14 days half the vinegar contained in the cask is drawn off and replaced by a fresh portion of wine. In this way an occasional renewal of the air in the upper part of the cask is provided for. The acetification is found to proceed more rapidly in old casks than in new, which is attributed to the presence of bacteria or mother of vinegar.

To Prepare Acetic Acid. Mix 26 parts of pulverized potassium sulphate and 15 of crude sulphuric acid, evaporate to dryness and melt the residue; then cool and pulverize it and add 24 parts of dry sodium acetate obtained by heating moderately about 40 parts of ordinary sodium acetate, and distil in a sand-bath, thoroughly cooling the receiver until 14 parts of acetic acid have passed over.

To Prepare Excellent Vinegar. Bruise 200 parts of large raisins, 12½ parts of crude tartar, and 100 parts of wheat malt, and work them to a stiff paste by adding hot water. Let this stand for half an hour, then pour 1800 to 2000 parts of hot water over it, and let it stand for 3 hours. Now pour it in a barrel provided with a faucet and

standing near a warm stove. When the mixture is as warm as the hand will bear add 300 parts of yeast and stir thoroughly. After 3 hours, when all the yeast is fermented, add 400 parts of sharp wine-vinegar, let it stand for 24 hours, and then draw off the fluid. Remove the yeast and cleanse the barrel by rinsing it with water. Replace the fluid in the barrel, bung tightly, and let it stand quietly for 14 days, when the vinegar will be sour. After it has laid for 6 weeks draw it off, and to improve the vinegar repeat the operation several times. Vinegar thus prepared is nearly equal to the best wine-vinegar.

Vinegar from Potatoes or Rice. Grate 3500 parts of potatoes and add 2000 to 2500 parts of water and 20 parts of sulphuric acid. Let the mixture boil for 6 hours, and run it through a strainer into a cooler, in order to separate the fluid from the sediment. The fluid is then drawn off into another vat and placed in a room having a temperature of 79° F., and ½ part of potash dissolved in water and 560 parts of yeast are added, some more yeast being added in the course of 3 days to promote fermentation. Now fill a barrel loosely with beech-wood shavings or grape husks saturated with strong vinegar, and pour, every morning and evening, 200 parts of the fermented fluid over them until the barrel is full. Then draw off 200 parts and pour them into another vessel half-filled with vinegar, and from this into another barrel filled loosely with beech-wood shavings, where the vinegar is allowed to cool and clarify, and is then ready for use.

Fine Table Vinegars. Anise Vinegar. Convert the following ingredients into a coarse powder: Anise seed 5 parts, caraway seed ½ part, fennel and coriander seed each ¼ part; pour 5 parts of alcohol and 45 parts of good strong vinegar over the powders, close the flask hermetically, and let the whole digest in a warm place for 6 to 8 days, shaking frequently. Then strain the liquid off, press out the residue, filter the vinegar, and put it up in bottles.

Aromatic Vinegar. Chop up leaves of rosemary, sage, and peppermint each ½ part, cloves, zedoary, and angelica root each ¼ part; place all in a suitable

flask, into which also pour 30 parts of crude vinegar, let it macerate for 4 days, then press out and filter. The product is a clear fluid of a reddish-brown color.

Dragonswort (Estragon) Vinegar. Pick the young tender leaves of dragonswort (*Artemisia dracunculus L.*) when the first flower-buds appear. Bruise the leaves, place them in a suitable flask, pour good wine-vinegar over them, and let the whole stand for a few days. Then strain the vinegar through a cloth, filter, and bottle. The bottles must be filled entirely full, as otherwise the vinegar will not keep.

Another Receipt. Mix $1\frac{1}{2}$ parts of oil of dragonswort with 3000 parts of pure good vinegar, let the whole stand for a few days, and then filter the vinegar.

Compound Dragonswort Vinegar or Herb Table Vinegar. Comminute leaves of dragonswort 100 parts, bean leaves 25 parts, leaves of basil and marjoram each $12\frac{1}{2}$ parts, bay leaves and orris root each 25 parts, cloves $3\frac{1}{4}$ parts, cinnamon $6\frac{1}{2}$ parts, and shallots 25 parts. Put all in a demijohn, pour 700 to 750 parts of pure good vinegar over it, let it stand on a warm place and digest 5 to 6 days, frequently agitating it. Then strain the vinegar through linen, press out the residue with the hands, add 25 parts of alcohol, and filter. Keep the vinegar in well-corked bottles in a cool place.

Spiced Dragonswort Vinegar. Cut up and treat as above leaves of dragonswort 100 parts, fresh lemon peel 40 parts, cinnamon and coriander seed each $13\frac{1}{4}$ parts, fennel seed $3\frac{1}{4}$ parts, cardamoms $\frac{1}{2}$ part, shallots 25 parts, and vinegar 700 to 750 parts.

English Spiced Vinegar. I. Pour 400 parts of pure vinegar and 50 parts of strong alcohol over the following ingredients, previously pulverized: Cloves 25 parts, cassia bark, mace, and orange blossoms each $3\frac{1}{4}$ parts. Let the whole stand in a warm place for 1 week, then strain through a cloth, press out the residue, and filter.

II. Mix oils of cloves 96 drops, bergamot 70 drops, and camphor $15\frac{1}{2}$ grains, triturated with $4\frac{1}{4}$ ounces of strong acetic acid and 15 drops of acetic ether. Add to this mixture 2 gallons of pure vinegar, mix thoroughly, let

the whole stand for a few days, and then filter through blotting paper. This vinegar must be kept in well-closed bottles and in a cool place.

Effervescing Vinegar. Dissolve 500 parts of loaf sugar in 5000 parts of water, add lemon juice and rind cut up in the proportion of 1 lemon to 1 pound of sugar, $1\frac{1}{2}$ parts of the best cinnamon, and $12\frac{1}{2}$ parts of beer-yeast thoroughly washed. Place the whole in a barrel, and after agitating thoroughly let it ferment at a temperature of 55° to 60° F. When fermentation has ceased the vinous fluid is strained, and mixed with 1000 parts of best wine-vinegar previously boiled up, and yeast in the proportion of 1 spoonful to 5 pounds of sugar. The fluid is then distributed in several earthenware pots and exposed to a temperature of 77° to 88° F., until it has been converted into strong vinegar. This, while remaining in the pots, is mixed with 200 parts of French brandy and after two days bottled in small bottles. To each pound of this vinegar are added $\frac{1}{2}$ part of crystallized tartaric acid pulverized and $\frac{1}{2}$ part of bicarbonate of sodium. The bottles, as soon as the respective portion of the mixture has been added to each, must be corked as quickly as possible, and then stored in a cool place.

Herb Vinegar as Prepared in the Northern Part of Germany. Chop fine the leaves of marjoram and thyme each $13\frac{1}{2}$ parts, bean leaves $6\frac{1}{2}$ parts, leaves of mint, basil, and celery each $3\frac{1}{2}$ parts, and $1\frac{1}{2}$ parts of fresh shallots. Pour 600 to 700 parts of good vinegar over the herbs, and treat in the same manner as given for compound dragonswort vinegar.

Herb Vinegar as Prepared on the Rhine. Chop up leaves of fresh dragonswort and woodroof each 20 parts, borage $1\frac{1}{2}$ parts, fresh mint $3\frac{1}{4}$ parts. Pour 600 to 750 parts of good vinegar over them, and then proceed as given for compound dragonswort vinegar.

Lemon Vinegar. Remove the rind from 5 to 6 fresh lemons, press out the juice and let it stand in a tall covered glass until clarified. Then pound the rinds to a paste and pour 1 gallon of good vinegar over it. Let it stand for a few days, then pour off the vinegar,

mix it with the clear lemon juice, filter and bottle the vinegar.

Orange Vinegar. Peel 5 to 6 fresh oranges, press out the juice in a tall glass, and let it stand covered to clarify. Free the rinds from the white parts, pound them to a paste and pour 1 gallon of good vinegar over it, and proceed in the same manner as given for lemon vinegar.

Pine-apple Vinegar. This excellent vinegar soon loses its flavor, and it is therefore best to prepare a small quantity at a time and keep it in hermetically closed bottles.

Bruise the slices of pine-apple and pour over them a considerable quantity of vinegar. Close the vessel as tightly as possible and let it stand 12 hours; after which pour off the vinegar and filter it.

Raspberry Vinegar. Crush perfectly ripe raspberries to a paste, let it stand 24 to 36 hours; then put 1 pound of this paste into a jar, pour $1\frac{1}{2}$ to 2 gallons of vinegar over it, place it in a warm place, but not in the sun, and shake frequently. After standing for several days strain the mixture through a cloth, add 1 gill of alcohol, mix thoroughly, and filter the vinegar. The bottles should be entirely filled and kept in a cool place.

Strawberry Vinegar. Mash thoroughly ripe strawberries, let the paste stand in a warm place for 24 hours, then press out the juice, bottle and let it stand for a few days to ferment and to allow the slimy constituents to separate. Then filter the juice and put it in well-closed glass bottles which should be scrupulously clean, where it will keep for a long time. When it is to be used for flavoring, add a sufficient quantity of it to good vinegar.

Vanilla Vinegar. Triturate in a porcelain mortar 4 parts of vanilla bean cut up with some white sugar, add 2 parts each of pulverized cloves and cinnamon, put all in a flask and digest it with 30 parts of strong alcohol for several days. Then add 250 to 270 parts of good vinegar, let it stand for some time, shaking it frequently, then strain through a cloth and finally filter. This vinegar is usually colored red.

Vinaigre à la Bordin. Chop up: Leaves of dragonswort 20 parts, bay

leaves 10 parts, angelica root $6\frac{1}{2}$ parts, capers and anchovies each 10 parts, shallots $6\frac{1}{2}$ parts, and pour 150 parts of good vinegar over them. Let the whole stand for 3 days, shaking frequently, then strain through a cloth, press out the residue, and filter the vinegar.

Vinaigre à la Ravigote. Leaves of dragonswort 25 parts, bay leaves $6\frac{1}{2}$ parts, capers $13\frac{1}{2}$ parts, anchovies cut up fine $26\frac{1}{2}$ parts, cloves and horse-radish each $3\frac{1}{2}$ parts, white mustard seed pounded fine $\frac{1}{2}$ part, shallots $13\frac{1}{2}$ parts, and good vinegar 300 parts. Proceed as above.

WASHING AND SCOURING. MANUFACTURE OF WASHING-BLUE, ETC.

To Wash Satin, Silk Ribbons, Brocade, and Silk Damask. Rub the materials either with yolk of egg or Venetian soap, wash them in tepid water, then rinse, and dry. Now dissolve good gum-tragacanth in equal parts of wine-vinegar and spring water, and strain the solution through a cloth; it should not be too thick. Dip the fabric in this solution so that it is uniformly moistened, then squeeze out the gum water, and by means of a brush spread the fabric upon a smooth board and let it dry quickly in the sun or near the stove. But ribbons should be ironed dry.

To Wash Silk Ribbons mixed with Gold and Silver Threads. Before washing brush the ribbons with honey water to protect the colors. Then wash in a solution of beef's gall and soap; manipulate the ribbon with one hand while pouring rain water over it with the other hand. After washing dip them in clear gum water, wrap them between two cloths around a mangle roller, and mangle them for a short time; then fasten some weight to one end of the ribbons and hang them up to dry.

To Wash Silver and Gold Lace. Place the lace in curdled milk for 24 hours. Dissolve shavings of some good soap in 1 quart of rain water, add a comparatively large quantity of honey, 1 beef's gall, and heat the whole for 1 hour. In case it is too thick add rain

water, so that a thin-fluid paste is formed. Allow this to stand for 12 hours, then brush the paste over the wet laces. Wrap a moist cloth around a mangle roller, around this the lace, and around it another moist cloth. The lace is then mangled, being occasionally dampened with rain water and several times brushed over with the paste. Now soak gum-tragacanth in water for 24 hours, strain it through a cloth, add an equal quantity of sugar, and, when this is dissolved and the solution has become clear, immerse the laces in it; then mangle them smooth between 2 clean cloths and then hang them up to dry.

To Wash Gold Laces. Place them over night either in urine or wine, and then wash them in the same manner as above. Color and gloss are restored by heating in a pot 1 pint each of water and whiskey, to which has been added pulverized gum-Arabic and some saffron; spread the laces upon a table and apply the solution uniformly with a small brush, and then hang them up to dry.

To Wash White Silk Crape. Soak over night in a solution of soap in milk, then sponge without rubbing and lay it in a solution of soap and water for 12 hours, squeeze gently, and place it between 2 damp cloths in a basket. Put some sulphur in an iron pot, and place the latter in a barrel or tall vessel covered with a cloth folded 4 times. Place the wet basket containing the crape over the sulphur, which is now ignited and allowed to burn some time. The crape is then taken out, stretched evenly over a board covered with cloth, and pressed down upon it with a sponge dipped in white boiled starch.

To Wash White Gauze. Place the gauze between 2 cloths together with some fine shavings of Venetian soap, put all in a tin dish, and pour lukewarm water over it; place a cloth folded double on top, load it down with a weight, and, when the water has become cold, pour it off and add lukewarm water, repeating this operation several times. Now let it stand over night under the pressure of the weight, then rinse the gauze several times with lukewarm water. The further treat-

ment and sulphuring is the same as given for silk crape.

Fine Muslin, Linen, and Batiste are first soaked in soft water. Then boil and skim 1 pound of soap, $\frac{1}{2}$ ounce of alum, and 1 ounce of carbonate of potassium until a plastic mass is obtained, which is formed into cakes or balls. Apply this to the fabric, rubbing with the grain; then squeeze it and repeat the operation several times, and finally, to prevent adhering particles of soap from turning the fabric yellow, rinse several times in fresh water, putting a few drops of indigo solution in the last rinsing water. The fabric is then squeezed out, beaten between the hands, and then dried in the shade.

To Wash Velvet. Boil, with constant stirring, 2 beef-galls with some soap and honey in a sufficient quantity of water. Place the velvet upon a clean damp board and freely apply the above mixture with a rag. Then wrap the velvet around a mangling roller and mangle it until the dirt has disappeared; then draw it through clean water, mangle again, and then hang up. When half dry moisten the velvet with isinglass dissolved in water, wrap it in a cloth, mangle it until dry, and raise the pile by rubbing with a cloth.

Velvet, which has become hard and rough by rain or mud, is made soft in the following manner: Moisten the back of the velvet. Secure a hot iron with the flat smoothing part up and draw the moist velvet across it. The heat converts the water into steam which penetrates through the pile of the velvet and separates the tangled threads.

To Wash Veils. White veils are washed in lukewarm soap water, gently wrung out, rinsed in cold water, blued, starched, beaten half dry between the hands, and then hung up to dry entirely. Black veils are immersed in warm water in which beef gall has been dissolved, then rinsed in cold water, and stiffened with gum water, beaten half dry between the hands, and then hung up until entirely dry.

Silk and Silk Fabrics are best washed in tea water and rinsed clean in whiskey in which some sugar has been dissolved, mangled, and ironed while still moist;

or they are washed in strong bran water to which some pulverized alum has been added; or by spreading the fabric upon a clean table, soaping it thoroughly with a woollen rag, using lukewarm water, and rubbing always in one direction. When the dirt is removed the soap is washed off with a sponge dipped in cold water. After the other side of the fabric has been cleansed in the same manner it is rinsed in cold water, spread out, and dried in the shade. The iron used for ironing should be but half warm, and paper be laid between the iron and the fabric.

Embroidered Fabrics, or Muslin, Linen, etc., Woven with Gold should be soaked in cold water, so as to prevent a disarrangement of the threads; all rubbing and wringing must be strictly avoided. When this has been done make suds of lukewarm water and Venetian soap, place the embroideries in it, and squeeze them out. Then place them in fresh water and, after 4 hours, squeeze them out and let them dry. Then sew linen around the edges of each piece and stretch them in a frame for finishing.

Silk Stockings are washed in warm water with good soap, and then rinsed in fresh water until all the soap has been removed. Then dissolve a piece of litmus as large as a hazel-nut in 1 quart of water and draw the stockings, turned outside in, several times through the solution. Then hold the stockings over sulphur burning in a pan filled with hot coals, and let the fumes pass through them. Then turn the stockings inside out, draw them upon frames, smooth them, while still moist, with a glass roller, and let them dry in the sun.

To Wash Taffeta. White taffeta is soaked in soft water and then washed with wheat bran and Venetian soap. It is then rinsed, sulphured, and finally stiffened with gum tragacanth, fleabane seed, and Saxony blue, then mangled between two cloths and lightly brushed. By another method white taffeta is washed three times in a solution of $4\frac{1}{2}$ ounces of Venetian soap in 2 gallons of rain water prepared by boiling and cooling off to lukewarm.

Black Taffeta is washed three times in a like solution of Venetian soap in

water which has stood over night, and then stiffened with gum-Arabic and fleabane seed, and mangled and ironed. Another method of washing black taffeta as well as all other black silk fabrics is by rubbing the fabric with a sponge dipped in beer, mint-water, or whiskey, then mangling dry between two cloths, and finally ironing on the wrong side.

To Polish Gold and Silver Lace. To restore gold lace, spangles, and buttons, which are worn so that the white ground shines through, treat $1\frac{1}{2}$ ounces of shellac and 12 grains each of dragon's-blood and turmeric root with strong alcohol, and decant the ruby-red colored solution. The objects to be restored are then brushed over with some of the color by a camel's-hair brush, and then a hot flat-iron is passed over, so that the objects shall only be gently warmed. Gold embroidery is treated in the same manner. Detached gold knobs and buttons are fastened on a fork, brushed over with the gold lac, and then dried over red-hot coals with the above-mentioned precautions.

Silver Lace or Embroidery is polished with a powder obtained as follows: Alabaster is strongly calcined and, while hot, placed in corn-whiskey. A white powder is obtained, which is dried over the flame of a spirit-lamp and placed in a linen bag. The lace is then dusted over with the powder and brushed with a velvet brush.

To Wash Laces. Cover an ordinary wine bottle with fine flannel and stitch it firmly around the bottle, tack the outer edge of the lace to the flannel, rolling it smoothly around the bottle, then tack the inner edge smoothly down. Cover over the lace with a piece of very fine flannel or muslin, and rub the whole gently with clean suds made of Castile soap. If the lace is very much discolored, fill the bottle with hot water, place it upright in a sauce-pan of suds, and let it boil for a few minutes; then place the bottle under a running hydrant, to rinse the lace thoroughly. Make some starch about as thick as arrow-root for an invalid, melt in it a small quantity of white wax and a little loaf-sugar. Plunge the bottle 2 or 3 times in the

starch, pressing out the excess with the hands; then dip the bottle into cold water, remove the outer covering from the lace, fill the bottle with very hot water, and set it in the sun to dry. When nearly dry take it off the bottle carefully, pick it out with the fingers and lay it in a cool place to dry.

To Wash Point Lace. Fix the lace in a frame, draw it tight and straight, make a warm suds of Castile soap and apply it gently to the lace with a fine brush; when clean on one side wash the other in the same manner. Then rinse by throwing clean water on it in which some alum has been dissolved. Then make some thin starch, apply it to the wrong side of the lace, and, when dry, iron it on the same side, and pick it out with the fingers or a bodkin. To clean the lace, if not very dirty, without washing, fix it in the frame as above and go over it with fine bread-crumbs, and, when done, dust out the crumbs.

To Whiten Lace. Iron the lace slightly, then fold it, and sew it in a clean linen bag, and place this for 24 hours in pure olive oil. Then boil the bag in a solution of soap and water for 15 minutes, rinse in lukewarm water, and finally dip in water containing a small quantity of starch. Then take the lace from the bag and dry it stretched on pins.

To Cleanse Feathers. Take for every gallon of clean water 1 pound of quicklime, mix them well together, and when the undissolved lime is precipitated in a fine powder pour off the clear lime water for use. Put the feathers to be cleansed in another tub and add to them a quantity of the clear lime water sufficient to cover the feathers about 3 inches when well immersed and stirred about therein. The feathers when thoroughly moistened will sink down and should remain in the lime water 3 or 4 days, after which the foul liquor is drawn off, the feathers rinsed with clean water, and then dried.

Cleansing and Rosing Salt, for Red Cloths which have become dirty or decolorized by use, is prepared as follows: Dissolve in 1000 parts by weight of water 32 parts by weight of sorrel salt,

16 of crystallized soda, and 5 of potash. When all are dissolved add 2 parts of cochineal and filter the solution. Moistened the red woollen fabrics and brush them with a hard brush, rubbing always with the grain, until the dirt is removed, and then wash them in pure water.

This renovator possesses all the qualities ascribed to it by the inventor; the effect is quick and complete, the red color regaining its original freshness and purity. The small quantity of cochineal in the mixture exerts but little influence and may just as well be left out.

To Wash Genuine Pearls. Scatter salt over the pearls laid on a clean linen cloth, tie this together with a cord, and rinse in lukewarm water until all the salt is dissolved and washed out; then dry the pearls at an ordinary temperature.

Dye-starch and Preparation and Use of Crimson Dye-starch. To dye white dresses *Actus* recommends a dye-starch of his invention, by means of which any lady can dye her dress with little expense and trouble. He gives the following directions for preparing crimson dye-starch and how to use it: Mix 3 parts of fuchsine into a thick paste with water, and dissolve in it 20 parts of glycerine by constant stirring, which will be done without the aid of alcohol as a solvent. When the fuchsine is dissolved, and the compound has assumed a uniform crimson color, add with constant stirring 150 parts of starch previously rubbed fine, spread the whole upon unsized paper, and dry in the air. To dye a dress after it has been washed prepare a small quantity of the dye-starch with boiling water in the same manner as ordinary starch, and starch with it the dress to be dyed. It is then dried, sprinkled, and ironed with a hot flat-iron.

Washing with Water-glass. This has been highly recommended of late and gives excellent results. Soak the clothes over night in a solution of 1 part of water-glass in 20 to 30 parts of water at 122° to 140° F. In the morning add hot water and manipulate the clothes with a stick, drain them off, which will remove nearly all the dirt, and a little

rubbing with soap will complete the work. It is advisable to treat the clothes once more with a weak solution of water-glass (1 part to 50 of water of a temperature of 113° to 122° F.), and then to boil them in clean water. Clothes washed in this manner are brilliantly white, require no bleaching, and besides the process is considerably cheaper and takes less time than the ordinary one with soap and water. Colored woollen fabrics are washed in a solution of 1 part of water-glass in 50 of water of a temperature of 100° to 122° F.

Palme's Process of Washing. Soak the clothes for 15 minutes in clean water. Dissolve 1½ ounces of washing powder and 7 ounces of soap in 9 gallons of boiling water. In 1½ gallons of this hot solution rinse the clothes wrung out from the clean water and wring out again. Then immerse them in 2½ gallons of the solution mixed with 1 gallon of cold water, then in 4½ gallons of the boiling-hot solution, and rinse in cold water.

The washing powder used consists of 30 per cent. of borax, 65 per cent. of commercial soda, and 5 per cent. of wheat or corn-starch.

New Wash Process. Boil 2 pounds of soap to a paste, dilute this with 6½ gallons of water, add 1 table-spoonful of spirit of turpentine and 2 table-spoonfuls of ammonia, and beat the mixture thoroughly. The water must be as warm as the hand will bear. The dry clothes are then soaked in this for 2 hours previously to washing them. The tub containing them must be well covered. The suds can be again heated, and used once more by adding ½ table-spoonful of spirit of turpentine and 1 table-spoonful of ammonia.

To Wash Dresses of Fast-colored Silk. I. Mix 1 quart of liquid ammonia in 2½ gallons of soft water with sufficient soap. Wash the dress thoroughly in this solution and rinse it in running water if possible.

II. Rub the dress with yolk of egg and wash it in clean lukewarm water, rinse in cold water, and dry at an ordinary temperature. Soak for 12 hours ½ ounce each of gum tragacanth and fleabane in water; then boil to a thin starch, through which draw the dress,

and iron it between two cloths until dry.

To Make Washed Silk Glossy. Dissolve 1 ounce of gum-Arabic in ½ gallon of water, and add 2 table-spoonfuls of beef's gall and ¼ ounce of fleabane seed. Boil the whole for a quarter of an hour and, when cold, spread a thin coat of it on the silk with a sponge, and smooth with a linen cloth.

To Restore the Color of Fabrics. Sponge the silk or woollen fabric with a solution of sal-ammoniac in half its quantity of water. Then with a piece of the same material rub the stains until they are dry, and the color will be restored.

To Wash Pearl Embroideries. Boil 8½ ounces of shavings of ordinary soap with 1 pound of beef's gall into a uniform mass, then add 1 ounce each of Venetian turpentine, honey, and pulverized sugar, stir together and boil for a few minutes. Pour this soap into a dish, and when dry cut it into cakes. To wash an embroidery, dissolve as much of the soap as required by boiling it in soft water, allow the solution to cool, and apply it with a sponge.

To Bleach or Whiten Clothes which have turned Yellow. Soak the clothes in buttermilk, allowing them to remain for some time, coarser articles requiring a longer time than finer. Then wash with soap in tepid water, rinse in cold water and dry. Repeat the operation if the first application is not entirely successful. For very fine clothes the buttermilk must not be too sour.

Clark's Wash for Carpets. Solution I. Dissolve 10 parts of soap in 20 of water, and add 3½ parts of soda and ½ each of liquid ammonia and spirit of wine.

Solution II., which is the *actual cleansing liquid*, consists of 4 parts of liquid ammonia and 3 of alcohol diluted with water.

The last solution is first used, and when the dirt loosened by it has been removed the soap solution is applied. Carpets thus treated regain their original colors in all their freshness, the entire operation of washing and drying a large carpet requiring but 2 hours, and the carpet need not be taken up.

To Wash Straw and Chip Hats. Make

a strong lather of Castile soap on a woollen rag and rub it on the hat until the dirt is removed. Wash the soap off the hat with clean water. Then dry with a cloth until the hat is only moderately moist, and finally place it in a sulphuring barrel to be bleached.

The sulphuring barrel is prepared as follows: Cover the bottom of a barrel with stone or sheet-iron and ignite some sulphur upon it. Suspend the hat for 30 minutes, so that the sulphur fumes but not the flame can reach it, and cover the barrel tightly. The hat, when sufficiently sulphured, is taken out and made glossy by pressing with a warm flat-iron.

Experiments in Washing Woollen Fabrics. Opinions about washing woollen fabrics differ so widely, and the receipts and directions given in practical journals vary so much and are so contradictory, that we decided to test the matter thoroughly. The most varying degrees of heat, from the hottest to the coolest temperature, were made use of in this experiment; and, further, all the recommended cleansing agents, such as soap, borax, spirit of sal-ammoniac, benzine, and all mixtures of the latter. The results were so decidedly and distinctly marked that the following may be given as the principal guiding points:

1. The suds used for washing must be as hot as possible.

2. To remove greasy impurities, as perspiration, etc., borax is of so little use that its employment is sheer waste; even pure soap-suds is better, but the best of all is soap-suds with spirit of sal-ammoniac. The latter actually effects wonders in quickly dissolving dirt on special places in woollen undershirts, etc., otherwise hard to cleanse, and restores and brightens the colors. On the other hand, for washing white woollen articles, nothing is equal to borax; soap-suds with borax used boiling hot gives to white woollen articles a looseness of texture and a brilliant white which they frequently do not possess when new.

3. If shrinking is to be entirely avoided and the texture of the fabric is to be even looser than when new, the articles must be prepared for quick drying by pressing them repeatedly be-

tween soft drilling. Under no circumstances should woollen articles be dried in the sun, as that renders them hard and close; it is best to dry them in a moderate draught of air, and in winter in a warm room, not too close to the stove.

Separate the white from the colored woollens. For the latter prepare a suds of about 2½ ounces of yellow soap (Elaine soap) in about 2 gallons of boiling soft water, and divide in two tubs, in one of which add a small tea-spoonful of spirits of sal-ammoniac for each quart of suds. When the articles (only 3 or 4 pair of stockings or an equivalent at one time) are placed in the suds, they must be so hot that the hand cannot be borne in it, and the articles must be squeezed, turned, and manipulated with clean wooden sticks or spoons. They are then squeezed out as much as possible, and brought into the tub containing the other half of the suds without an addition of spirits of sal-ammoniac. This will be generally sufficiently cooled off to allow of the articles being thoroughly squeezed out, but under no circumstances must they be wrung out with a turning motion. The articles, to accelerate their drying, are now pressed between 3 or 4 soft dry cloths, until the latter absorb no more moisture. Then every article is drawn into the shape it is to have; undershirts, for instance, being stretched in the width, this being still more necessary in regard to the sleeves, as they have a tendency to become long and narrow. In hanging on the line the shape of the article must also be carefully taken into consideration; jackets and undershirts, for instance, must be hung only crosswise, that is, the collar to the right and the tail to the left. In summer a few hours suffice for drying.

For washing white woollen articles add 1 tea-spoonful of pulverized borax to 1 quart of soap-suds, and for the rest proceed exactly as above. Should the second suds be found too soapy some hot water may be added. It is of great importance that, after washing about 3 sets of articles, the suds should be reheated, which is accomplished by adding to the first from the second, and replacing this by fresh. Even suds which have become almost black can

be further utilized by allowing the dirt to settle, then carefully pouring off the suds, and using them for the first washing of coarse colored clothes.

Any one wishing to test the efficacy of these methods should make a trial with articles not thickened by previous washing in lukewarm water, and, if possible, new ones.

To Wash Cotton and Muslin Prints Without Injury to the Colors. Heat soft water in a copper boiler to such a degree that the hand can be barely borne in it, and pour in the eighth part by weight of the fabrics to be washed of wheat-bran. Then place the articles in the water and let this come to a boil, during which the fabrics should be frequently turned with a wooden stick. Now let the water cool off sufficiently to allow of the dresses, etc., being washed in it; then rinse them in soft water, and dry at an ordinary temperature. The dresses, etc., are by this process washed as clean as with soap without the least injury to the colors.

Panama Essence for Cleansing and Washing Clothes is prepared by dissolving 15 pounds of *Marseilles* soap and $1\frac{1}{4}$ pounds of carbonate of sodium in 25 gallons of hot water, and adding 1 pound of extract of *quillaya* bark.

This gives solution No. I. In another vessel mix 4 gallons of beef's or sheep's gall with $1\frac{1}{2}$ quarts of ammonia of 22 per cent.; heat and skim the mixture, and, when cold, compound it with 4 gallons of spirit of wine of 90 per cent. This gives solution No. II. For use mix $\frac{1}{3}$ part of solution No. I. with $\frac{2}{3}$ of solution No. II., and compound the mixture with a suitable quantity of aromatic essence.

Cleansing Fluid for Tissues, etc. The parts of mineral oils having a low boiling point are treated with chlorine gas until a sample, after shaking with alkali, emits no disagreeable odor. The whole is then treated with milk of lime and next with soda, or air is forced through it. It is then distilled, and the product passing over at less than 212° F., having a weak, agreeable odor, may be perfumed.

Use of Tin-salt for Removing Rust-stains from Clothes. Hörmann has

made experiments to determine the value of tin-salt for removing rust stains from clothes as compared with that of the usual means, oxalic acid and sorrel salt. For this purpose he prepared the following solutions:

1 a.	1 part of tin-salt in 10 parts of water.
1 b.	“ oxalic acid in 10 “
2 a.	“ tin-salt in 20 “
2 b.	“ oxalic acid in 20 “
2 c.	“ sorrel salt in 20 “
3 a.	“ tin-salt in 40 “
3 b.	“ oxalic acid in 40 “
3 c.	“ sorrel salt in 40 “

The rust stains to be removed were in old ironed towels, which, to all appearance, had been in them for some time, and in a condition as generally found in clothes. Pieces as large as a hand containing the stains were cut out of the towels, and to prevent errors five of such pieces placed in every solution, care being also taken to place stains of equal intensity in equally strong solutions. All solutions were used cold.

The result of the observations was as follows:

In the oxalic acid solution even the strongest stains disappeared completely in 1 b. in about 20 minutes; in 2 b. in 25, and in 3 b. in 30 minutes.

In the sorrel salt solutions, 2 c. and 3 c., the stains disappeared in about 30 minutes.

In the stains treated with tin solution only a slight change was perceptible in the stains, even after an immersion of $3\frac{1}{2}$ hours, and they remained plainly visible after 3 days.

By a completely saturated solution of tin-salt the rust stains were removed after an immersion of 3 days.

Such stains as had been in the tin-salt solutions for $3\frac{1}{2}$ hours, and then carefully washed, disappeared in 10 to 15 minutes after being placed in the oxalic acid solutions.

With ink stains the result was the same. From these experiments the conclusion may be drawn that tin-salt deserves but little recommendation for removing rust and ink stains.

Manufacture of Washing Blue. Washing blue usually consists of starch colored with Parisian blue. Its manufacture presents no difficulties whatever, so that every one after a few trials can prepare it.

Means of Removing Stains

Of :	From Linen.	Colored Fabrics.		Silk.
		Cotton.	Wool.	
Sugar, gelatine, blood, albumen.		Washing simply in water.		
Fat.	Soap-water, alkaline lyes.	Tepid soap-water.	Soap-water, spirit of sal-ammoniac.	Benzine, ether, spirit of sal-ammoniac, pota h, magnesia, chalk, yoke of egg.
Varnish and oil-paint.	Oil of turpentine, benzine, and finally soap.			
Stearine.	Alcohol of 95 per cent.			
Vegetable colors, red wine, fruits, red ink.	Sulphurous vapors, warm chlorine water.	Washing in warm soap-water, or liquid ammonia.		As above, rubbing very gently and carefully.
Alizarine ink.	Tartaric acid ; the older the stain the more concentrated solution.	Diluted solution of tartaric acid, if the fabric permits.		As above.
Rust and gall-nut ink.	Warm oxalic acid solution, diluted hydrochloric acid, and finally tin filings.	Repeated washing with dissolved citric acid, if the fabric is dyed well.	The same as for cotton, but diluted hydrochloric acid if the wool is naturally colored.	Nothing can be done ; all attempts only increase the evil.
Lime and alkaline lyes.	Washing simply in water.	Pouring diluted nitric acid drop by drop upon the stain. The stain previously moistened is rubbed off with the finger.		
Tannin, green nut-shells.	Eau de Javelle, warm chlorine water, concentrated solution of tartaric acid.	More or less concentrated chlorine water, according to the nature and tint of the fabric, and alternate washing with water.		
Coal-tar, wagon-grease.	Soap, oil of turpentine alternating with a jet of water.	Rubbing with hard, then scouring, and after a while washing alternately with oil of turpentine and water.		The same as for colored fabrics, but using benzine instead of oil of turpentine, and the jet of water must fall from some height upon the back of the stain.

The apparatus required consists of a trough 4 feet long, 1 foot wide on the bottom, and 2 feet wide on the top, and about 25 to 30 drying boards 3 feet long, 1 foot wide, and 1 inch thick, and provided on 3 sides with small ledges; a drying frame constructed of 2 ladders 7 feet high with rounds $1\frac{1}{4}$ inches apart; and finally a barrel which can be turned around an axle passing through the head and bottom. In summer the blue is dried in airy lofts, but in winter in heated rooms.

The Parisian blue must be in the form of a paste and have a consistency of at least 30 per cent. Place in the trough 20 pounds each of potato starch and residue from the manufacture of wheat starch, both perfectly white, 40 pounds of Parisian blue in the form of paste, 2 pounds of indigo-carmin, and a like quantity of gum-Arabic dissolved in water. Then add sufficient water for the whole to form a compound of somewhat greater consistency than the Parisian blue. Knead this with the hands into a homogeneous compound free from lumps, place enough of this upon the drying boards to fill them about half, distribute the mass uniformly over their whole surface by beating and shaking them, and then place them in the drying frames. The ladders of the latter are placed about 2 feet apart and connected on the top by cross-pieces, so that they will stand by themselves. The paste remains here until half dry, which in the open air will require about 2 hours, but a less time in a heated room. The half-dry paste is then cut into square pieces. This is accomplished with a roller 4 inches long on which are arranged 16 small knife blades at equal distance from each other. With this instrument the paste is cut into equally wide strips and then into squares, which are then entirely dried. But, as the product in this state would not present a fine appearance, it is polished by placing 30 pounds of the cakes in the mentioned barrel or drum together with $1\frac{1}{4}$ to $1\frac{1}{2}$ ounces of Parisian blue finely pulverized. The barrel is revolved until the cakes have acquired a uniform and fine appearance. The excess of Paris blue and broken pieces is removed by sifting, and the product is ready for the market.

Liquid Wash Blue is easily prepared in the following manner: Pulverize 8.3 parts of solid indigo in a porcelain dish, and add $33\frac{1}{2}$ parts of sulphuric acid. Let it stand for 6 hours with frequent stirring with a wooden or glass rod, and pour into a flask containing $\frac{1}{2}$ gallon of water not too cold. Throw powdered chalk into the flask until effervescence ceases, in order to remove the sulphuric acid, which is injurious to the clothes. The whole is then allowed to stand quietly for a few days, then filtered through blotting paper, and can be kept for years without fear of spoiling.

Several other Receipts for Liquid Washing Blue. I. Dissolve 1 part of indigo-carmin in 10 of water and then add $\frac{1}{2}$ of gum-Arabic.

II. *Concentrated Liquid Washing Blue.* Bengal indigo 2 parts, fuming sulphuric acid 9, gum-Arabic 4, water 50.

III. *Ordinary Liquid Washing Blue.* Dissolve 2 parts of indigo in 9 of fuming sulphuric acid and mix the solution with 350 parts of water and 8 of gum-Arabic.

Washing Powders. *Washing Crystal* is a solution of borax and soda in water.

Lustrine Alsacienne (Starch Gloss) consists of spermaceti, gum-Arabic, and borax each $1\frac{1}{2}$ ounces, glycerine $4\frac{1}{2}$ ounces, distilled water $1\frac{1}{2}$ pints, and some sweet-scented essence. The mixture is used with or without an addition of starch. If it is to be mixed with starch add 4 spoonfuls of lustrine to $4\frac{1}{2}$ ounces of boiling starch.

WASTE AND OFFAL, UTILIZATION OF.

Fabrication of Different Kinds of Lampblack from Waste in Working Coal-tar. The oil last obtained in distilling coal-tar and freed as much as possible from naphthaline is burned in a furnace of special construction (Figs. 47 and 48) for manufacturing lampblack. In the division *a* of this furnace is an iron plate which must be constantly kept red hot. Immediately over it is a tube *e* through which the oil drops upon the plate where it is decomposed, and the smoke (soot) enters

the chambers 1, 2, 3, 4, through small apertures *f*.

When the quantity of oil to be decomposed is exhausted, the furnace is allowed to stand for a few days when

(Fig. 48) is used, in which the pitch is burned, the air being as much excluded as possible. The material is thrown in through the doors *a a*, the smoke (soot) passes through the chim-

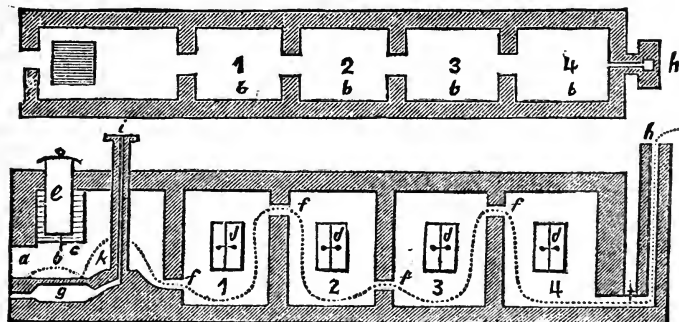

Fig. 47.

Cross-section of Furnace No. 1. *a*, door with small apertures; *b*, iron plate; *c*, tube for the oil; *d*, windows or iron doors; *e*, apertures for the soot; *g*, fire-place; *h*, chimney for the gases; *i*, chimney for the smoke; *k*, evolution of the soot into the chambers; *l*, oil reservoir.

the windows *d* in the chambers 1, 2, 3, 4 are opened. The finest lampblack suitable for lithographic purposes is in No. 4. No. 3 contains that fit for printing ink, while a coarser quality is in No. 2 and No. 1. The latter is sifted and sold as ordinary lampblack. The calcined lampblack used by paper manufacturers is also made from the best quality obtained by this process. The lampblack is firmly pressed into closed tubes of sheet-iron, the covers of which are luted on with fine clay and provided with a small aperture. The tubes are placed in a furnace and subjected to a strong heat, whereby the empyreumatic oils are expelled and the lampblack becomes inodorous. The tubes, after cooling off for a few days, are opened and the soot taken out. This is half-calcined lampblack. To calcine it entirely it is again pressed into tubes and once more thoroughly heated. The tubes are opened in two days, when the entirely calcined material will be obtained in compact pieces.

Manufacture of Lampblack from Asphaltum Pitch or Blacksmiths' Pitch. A furnace of a different construction

ney *b* and the flue *g* into the chambers 1, 2, 3, 4, where the soot is deposited. When all the pitch has been burned, the furnace is allowed to stand for a few days before it is opened. The iron doors *d* are then slightly opened for the admission of air, and later on, when the lampblack is entirely cold, are thrown wide open. The finest lampblack suitable for the use of manufacturers of leather and oil-cloth will be found in chamber No. 4, while the coarser quality is in the other chambers, after sifting, is sold as ordinary lampblack. The finest quality of this may also be converted into calcined lampblack by the same process given above.

Description of the Furnace. It may be built of stone or bricks, but the interior *b* must be lined with strong iron plates. The doors *d* are of strong sheet-iron, as also the door *a*, which is provided with a few apertures for the introduction of air required for combustion. The flue *g* leads into soot chambers 1, 2, 3, 4, arranged in the same manner as Fig. 47.

In regard to the amount of lampblack obtained we give the following

statement: Four hundred pounds of oil yield about 20 pounds of the finest lampblack, 30 pounds of No. 2, and 20

Manufacture of Artificial Manures from Residues in the Working of Coal-tar. The various sodic residues impreg-

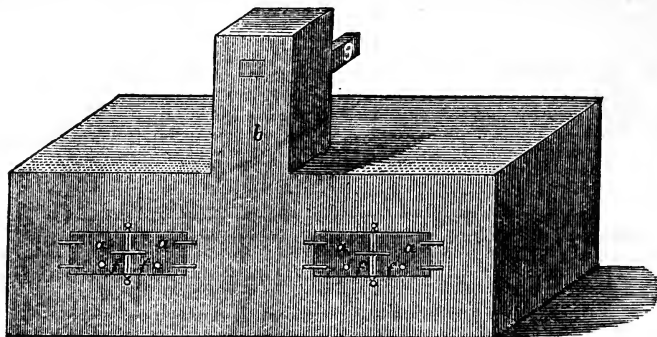

Fig. 48.

Front View of the Furnace. *aa*, doors; *b*, chimney; *c*, flue leading to the soot chambers; *f*, apertures for the admission of air.

pounds of Nos. 3 and 4. Upon the iron plate remains a coke-like residue which must be removed, and can be used as fuel. Five hundred pounds of pitch yield about 200 pounds of lampblack of all qualities. The coke-like residue, which must be broken off with a hammer and chisel, amounts to about 440 pounds, and can also be used as fuel.

Manufacture of Various Kinds of Lampblack from the Resinous Sodic Residues in the Working of Coal-tar. The dry residues, containing potash and soda and rich in oil and resin, obtained in the various processes of purifying and distilling crude coal-tar oils and creosote, can also be burned to lampblack in the furnace. The residues, to make them more inflammable, are mixed with some asphaltum or blacksmiths' pitch. The lampblack formed is also conducted into the chambers 1, 2, 3, 4, and there allowed to cool. In quality it does not differ from that produced by burning blacksmiths' pitch. The furnace, after the lampblack has been taken out, is closed and the black cinders containing soda and potash are completely burned with the aid of wood until they show a grayish-white color. The residues, when cold, are pulverized and used in the fabrication of manure and artificial guano.

nated with very finely powdered carbon obtained in purifying the crude light and heavy coal-tar oils are pulverized, the powder sifted and stored in a dry place. The lime remaining in the filtering bag in preparing the caustic lye is also thoroughly dried, pulverized, and sifted. The wood ash is also sifted and mixed with the above residues in the following proportions: One part of sodic residues, 2 of caustic lye residues, and 4 of sifted wood-ash. Upon this are poured 2 parts of sulphuric acid residues, *i. e.*, residues obtained by treating the crude oils with sulphuric acid. The mixture, which becomes quite heated, is thoroughly worked with iron rakes until it is again entirely dry. Now take 2 parts of bone-flour, 2 of animal charcoal, and pour upon them 4 parts of acid residues, stirring constantly. Next evaporate, under constant stirring, fresh bullock's blood until it can be rubbed to a fine powder. Pass it through a sieve, and add 4 parts of it to the above mixture, and finally 3 parts of crude sulphate of ammonium, and 4 of pulverized pigeon dung. Mix the whole thoroughly and, to separate the coarser parts, pass it repeatedly through sieves. This manure is equal to guano in all respects.

We give in the following a few simi-

lar compositions: I. Sodid residues 1 part, caustic lye residues 2, wood-ash 4, animal charcoal 2, bone-flour 2, acid residues 6, dry bullock's blood 4, crude sulphate of ammonium 3, pigeon's dung 4.

Manure for Meadows. a. With Wood-ash. Wood-ash 30 parts, caustic lye residues 60, acid residues 30, sodid residues 7, crude sulphate of ammonium 3.

cium hydrate, and introduce steam as long as the distillate passing over smells of ammonia. Then empty the still, put in fresh ammoniacal liquor, and proceed as before. The concentrated ammoniacal liquor is then neutralized with sulphuric acid and filtered, whereby many tar-like substances are separated, and finally evaporated in shallow lead pans (Figs. 49 and 50).

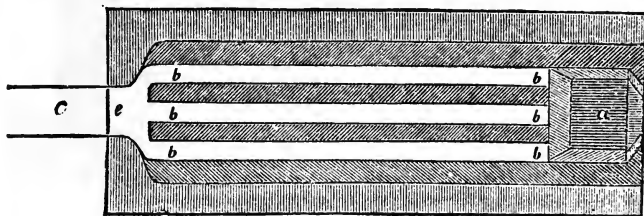

Fig. 49.

Ground-plan of Evaporating Furnace. a, grate; b, flues; c, chimney; e, damper to regulate the fire.

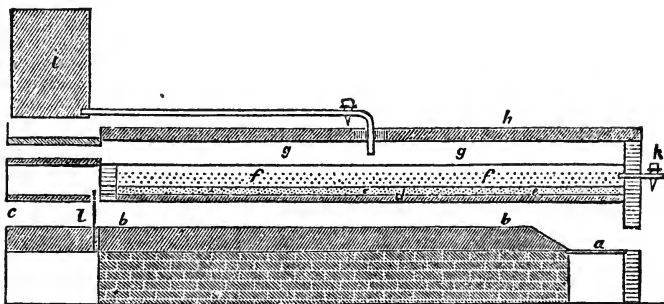

Fig. 50.

Longitudinal Section of Evaporating Furnace. a, grate; b, flue; c, chimney; d, cover-plates; e, sand; f, lead pan for the sulphate of ammonium; g, flue for the vapors escaping into the chimney; h, top vault; i, reservoir for ammoniacal water; k, escape-pipe for the concentrated ammonia; l, damper for regulating the fire.

b. With Peat Ash. Peat-ash 30 parts, lye residues 60, acid residues 30, sodid residues 7, crude sulphate of ammonium 3.

Utilization of Ammoniacal Liquor from Coal-tar. Bring the ammoniacal water gained in gas-works and in the distillation of coal-tar into large cast-iron stills, add 2 to 4 per cent. of cal-

As soon as the mass begins to be crystalline it is drawn off through the faucet *k* into shallow cast-iron boilers, and under constant stirring evaporated, whereby many empyreumatic oils escape, and the mass assumes a much darker appearance. It is then poured out upon stone slabs and allowed to congeal. The product forms crude

commercial sulphate of ammonium. To prepare the purified article from it, it must be redissolved, filtered and again evaporated. The purified sulphate of ammonium is used for the production of the liquor ammoniæ of commerce. For this purpose a mixture of equal parts by weight of sulphate of ammonium and calcium hydrate is placed in a cast-iron retort and slowly heated. The developed gas is conducted through a series of Woulff bottles filled $\frac{2}{3}$ with pure water.

The fluid in the first bottles generally assumes a somewhat yellowish color, while that in the other bottles, in which the gas tubes reach to the bottom and the ammoniacal gas must pass through the water which becomes thoroughly saturated, remains entirely colorless.

The water absorbs 670 times its volume of ammoniacal gas, and the specific gravity sinks from 1.0 to 0.780, but liquor ammoniæ, as a general rule, has a specific weight of only 0.960.

In England the ammoniacal liquor of gas works is neutralized with hydrochloric acid in large covered vats, having a capacity of 100,000 to 125,000 gallons, and the mixture uniformly mixed by agitating with a stirring apparatus. The carbonic and hydrosulphuric gases which are expelled are, on account of the bad smell of the latter and its unwholesomeness, conveyed through pipes with which the vats are provided into a furnace where the hydrosulphuric acid is burned, forming water and sulphurous acid. After a few days, when the tarry constituents and the separated sulphur have settled, the fluid is drawn off into lead pans resting upon iron plates. The latter are laid upon sand over a heated flue, by which the sand, plates, and pans are uniformly heated. The ammoniacal liquor is exactly neutralized with milk of lime or concentrated liquor ammoniæ and then evaporated, whereby many tarry constituents and volatile oil, as impure benzole, etc., are separated. The fluid, as soon as it has obtained a specific gravity of 1.25 to 1.30, is run off through large filters into special crystallizing vats, which are so placed that the mother-lye can run back into the evaporating pans.

After about 8 days crystallization is so far progressed that the mother-lye

can be drawn off and the crystals formed placed upon large linen filters to drain off. The mass when nearly dry is entirely dried upon cork hurdles, and forms the crude sal-ammoniac, having a yellowish-gray appearance. This crude product is further purified by sublimation. For this purpose the crystals are heated in a cylindrical iron boiler covered with an iron dome lined with fire-clay, and provided in the centre with a small aperture closed by an iron rod, which is removed during the operation to allow the non-condensable vapors to escape. The crude sal-ammoniac rises in vapor below a red heat, and condenses upon the dome in the form of the fibrous cake known as sal-ammoniac. The sublimation requires 5 to 8 days. A boiler in which 1000 pounds of crude sal-ammoniac can be sublimated at one time has a diameter of 3 to 6 feet. But as this sal-ammoniac generally contains some empyreumatic substances, it is redissolved in water and treated with steam, whereby all volatile foreign substances are removed. The hot fluid is then filtered through fresh calcined animal charcoal, again evaporated in lead pans, and allowed to crystallize. The product obtained is perfectly white and inodorous.

Ammonia, Tar, and Other Products of Distillation from the Gases of Coke-ovens. To preserve the gases developed in the coke-ovens *r* (Fig. 51) from decomposition, a fine jet of steam is forced towards them in the absorbing pipe *a*. A second jet of steam may also be conducted from the lower to the upper part of the pipe. With the assistance of these two jets the pressure and draught in the oven are regulated. From the absorbing pipes the gases pass into a spacious channel *e*, the top of which *f* is cooled with ammoniacal liquor. A strong exhauster *g* sucks the gases from this, and blows them into a second channel *h*, nearly as wide as *e*, placed above the cooling water of the first channel, and also cooled on top by ammoniacal liquor *i*. From here the gases pass into a large condenser *k*, the pipes of which are kept cool by means of water, flowing towards the gases. The gases after passing through several systems of pipes, the cross section

of which becomes smaller in accordance with the process of cooling, are finally forced through dilute sulphuric acid into the lower chambers, where

the compound contains either phosphoric acid or superphosphate of lime. The acid is expelled by boiling and the residual filtered.

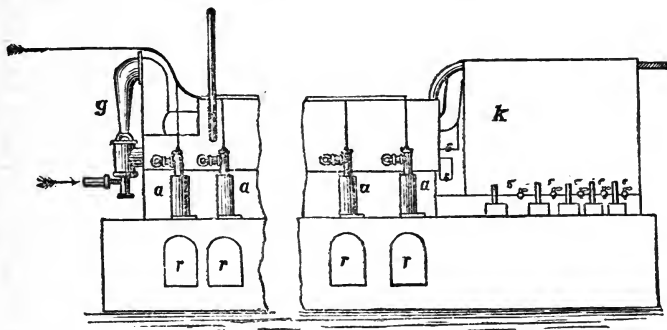

Fig. 51, a.

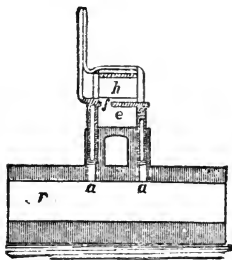

Fig. 51, b.

they are deprived of the last traces of condensable admixtures.

After the gases have left the condenser they can be used in any manner desired. The solution of sulphate of ammonium is allowed to stand for a few days in order to separate the tar and oils. It is then pumped into *i* and *f*, where as mentioned it is used for condensing the gases, and is at the same time evaporated.

To Regain Hydrochloric Acid used in the Manufacture of Gelatine from Bones. The bones are treated, not with hydrochloric acid alone, but with a mixture of this with sulphuric acid. Of the latter so much is added that

Process of Producing Tartrate of Calcium and Spirit of Wine from Wine-lees. The thickly fluid mass remaining in the fermenting tuns after fermentation and drawing off of the clear wine, and the press-cakes remaining in the press-bags in case the lees are pressed out, are used for gaining tartrate of calcium and spirit of wine. The pure lees contain 3 to 5 per cent. of pure alcohol and 2 to 3 per cent. of tartrates, while the pressed cakes yield only 1 to 2 per cent. of alcohol, but 4 to 6 per cent. of tartrate of calcium. The gaining of alcohol is the first operation, for which any ordinary liquor still may be used, the product being alcohol of 85 to 90 per cent. Tralles. The thickly fluid lees are put in the still and distilled as long as alcohol is obtained, but the pressed cakes must first be intimately mixed with cold water, 12 gallons to 200 pounds of lees. After distillation the boiling hot residue is drawn from the still into a wooden vat, and compounded with 2 to 3 per cent. of hydrochloric or sulphuric acid to every 20 gallons. The mass thus treated is kept boiling for half an hour longer, being constantly stirred. The residue is then left standing quietly for 18 to 20 hours, to allow the lees to settle. The nearly

clear fluid containing in solution all the tartrates is, in order to gain the tartrate of calcium, drawn off into another vat and compounded, under constant stirring, with elutriated carbonate of calcium until the acid is completely neutralized, whereby the tartrate of calcium formed is precipitated. The whole is then allowed to stand quietly for 5 hours, when the tartrate of calcium is separated by drawing off the fluid standing over it. The product thus obtained is especially adapted for the fabrication of tartaric acid, tartrates of potassium, sodium, etc., and is a perfect substitute for crude tartar.

Process of Producing White or Black Pigment from the Clarifying Slime in Sugar Houses. The slime is dried and calcined in retorts, under exclusion of air, and then cooled in a well-closed vessel. To obtain a white pigment admit air to the calcined mass.

Process of Working Fecal Substances in a Rarefied Space. *a, b, d* (Fig. 52) are the saturating reservoirs in which

the injector into the column apparatus *B*, and be used for warming the fecal substances. According to another method the injector placed on the reservoir *h* creates a vacuum in the column apparatus *B* by means of the suction pipe *F*, and blows the ammoniacal vapors to *h*, where they are absorbed.

Sulphur, Sulphuric Acid, etc., from Gas-lime may be obtained by heating the lime to 300° F. in a closed retort, and passing steam at 600° F. over it, evolving sulphuretted hydrogen, which passes to a leaden chamber, and is there supplied with air and ignited to produce sulphurous acid; it is then mixed with nitric acid vapors, when the reaction produces sulphuric acid. The gas-lime is then mixed with clay, loam, or sand and subjected to heat, when the silicate or aluminium unites with the lime and with oxygen, forming silicate of calcium, etc., and liberating the sulphur. To produce the sulphide of sodium or potassium the gas-lime,

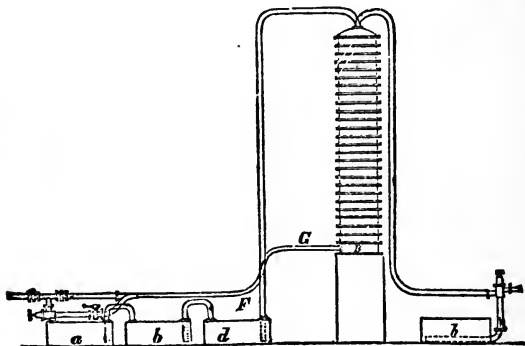

Fig. 52.

a partial vacuum is produced by means of injectors. The air is also rarefied in the column apparatus *B*, in which the fecal substances are laid on plates situated above each other. The ammoniacal gases in the reservoirs *a, b, d*, in distilling, in consequence of this pass over much more quickly and are less heated. The steam used in creating a vacuum can be passed through the blast-pipe *G* of

etc., should be mixed with caustic soda or potash, and allowed to stand until the reaction takes place.

Recovering Fat and Color from Waste Wash Liquors. Treat the waste soap liquor with a solution of muriate of lime, and add milk of lime until free lime remains in the mixture. After mixing thoroughly, and allowing to settle, the supernatant liquor is drawn

off. The precipitate containing the fatty and coloring matters is then treated with sufficient muriatic acid to decompose the fatty but not the coloring matter. The whole is then strained through flannel, and the fatty and coloring matters left on the strainer are heated, to melt and agglutinate the colored fatty substance, then cooled and pressed in bags to remove any watery solutions left by the first straining. The substance removed from the bag may be further heated to remove any remaining water, and the color combined with the fat may be separated by heat and pressure, or by treatment with hydro-carbons as a solvent.

Utilization of Waste Wash Liquors from Wool Manufactories. Compound the waste soap liquor with a mixture of 44 pounds of sulphuric acid of 66° B., 13½ pounds of the same acid of 53° B., and 44 pounds of hydrochloric acid of 22° B. The sulphuric acid of 66° B. unites with the alkalies and colors the liquor, which assumes a milky appearance, while the acid of 53° B. liberates the fatty substances, the hydrochloric acid completing the decomposition and neutralizing the liquor, in which will then be found small lumps of fat of the size of pin-heads. These small lumps rise to the surface and form a cake of fat floating thereon. This is separated from the liquor, heated in a boiler, and then mixed with sawdust in the proportion of 25 gallons of the latter to 400 pounds of fat. The mass is then cooled, pressed in a hydraulic press, and the oil running off allowed to settle, and is then decanted. The oil thus gained is claimed to be just as good as if it had never been used.

To Cleanse Woollen Waste. Soak the waste in cold urine for 1 to 6 days, then place it in a basket to drain off. Now place the wool for 4 to 6 days in a vat containing fulling liquor in which 2 pounds of soda to every 20 pounds of waste have been dissolved; then wash with cold water and dry. The waste will have the appearance of pure wool and can be used as such.

Utilization of Waste of Sheep Wool. Comminute the waste to a length of 2½ inches, and soak it in quite hot water for 3 days. Then free the waste from the greater part of the water and bring it

while still moist upon a close and fine carding engine.

To Regain Indigo from old Colors and Residues of Colors. Put 85 to 100 pounds of residues of colors in a vat or boiler having a capacity of 50 gallons, add 30 gallons of water, and boil the whole ¾ hour. Then add gradually a mixture of 10 pounds of sulphuric acid and 2½ gallons of water, and let the whole boil until no more sulphurous acid is developed. Then pour the liquor into a large wooden vat with water, wash the indigo by decantation until the water shows no more acidity, and throw the slime upon a filter. The paste, after the percentage of indigo has been determined, can be used at once.

Production of Cyanide of Potassium, Ammonia, Tar, and Gas from Nitrogenous Organic Substances. Leather waste, blood, wool, hair, etc., are saturated with a solution of potash and then dried. The mass is then heated in retorts, but not to the melting point. Ammonia, gas, and tar are caught up in the usual manner. The residue contains cyanide and cyanate of potassium, sulphocyanide of potassium, calcium carbonate, potassium hydrate, potassium sulphide, and carbon. In the presence of metallic iron or ferrous oxide the cyanide of potassium is converted into ferrocyanide of potassium by lixiviation. After separating this the solution may again serve for impregnating nitrogenous substances. The potassium hydrate present is converted into carbonate by treating the solution with carbonic acid. In case the raw materials are contaminated with sand it is removed by washing with potash-lye.

To Restore Rubber Corks which have become hard digest them for 10 days in a 5 per cent. solution of soda-lye at 100° to 120° F., then wash them and scrape off the outer layer which has become very soft with a dull knife until nothing more can be scraped off. Then wash the corks once more with warm water, and they are again fit for use.

Process of Gaining the Volatile Products Developed in Roasting Coffee and their Utilization. The volatile products developed in roasting coffee, which may amount to as much as 25 per cent. of the weight of the coffee, are condensed

in a condenser. The resulting fluid is used either by itself or, after previous evaporation, in the manufacture of coffee substitutes, or for improving solid or fluid coffee extracts.

WATER-GLASS (SOLUBLE GLASS) AND ITS USES.

Water-glass comes into commerce in the form of a thickly fluid and tough mass, obtained by fusing together quartz, sand with soda and less frequently with potash.

It is actually a glass, distinguished from other varieties by being easily soluble in water.

The solution possesses an alkaline taste, and on exposure to air is gradually converted into a gelatinous, transparent mass, which finally becomes entirely hard. This phenomenon is caused by the expulsion of the silicic acid from the water-glass by the carbonic acid in the air, thus forming a gelatinous mass of hydrated silicic acid. The article must therefore always be kept in hermetically closed vessels. Glass stoppers must not be used, as they are cemented so tightly to the neck of the vessel that they cannot be removed without the greatest difficulty.

Four varieties of water-glass are known in commerce: Potash water-glass, soda water-glass, compound water-glass, and fixing water-glass.

Preparation of Potash Water-glass. Mix 15 parts of pure quartz-sand with 10 of potassium carbonate and 1 of charcoal powder, and fuse the mixture in a crucible. The contents of the crucible, when cold, is taken out, pulverized, and exposed to the air, being frequently stirred during the time. The powder is then several times washed with cold water, and then boiled with 5 parts of water until all is completely dissolved. The solution is then filtered and evaporated to a specific gravity of 1.25. In this manner a sticky, syrupy liquid is obtained which, on exposure to the air, dries to a transparent glass.

Another receipt: Quartz sand 15 parts, potash 5, and anhydrous soda 4. It is prepared as above.

Preparation of Water-glass from Infusorial Earth. Liebig first drew attention to infusorial earth as a valuable material for preparing water-glass. By treating 24 parts of infusorial earth with 72.6 of soda-lye of 1.135 specific gravity 46 parts of an excellent gelatinous compound are obtained which consist of 58.5 per cent. of dry potash water-glass and 41.5 per cent. of water. The lye used in preparing it is obtained by dissolving 74.5 parts of calcined soda in 5 times the quantity of water, compounding the solution with 56 parts of dry, slaked lime, and evaporating the compound to 1.5 specific gravity. By adding to this lye 120 parts of infusorial earth water-glass is obtained. By taking less infusorial earth a very strongly alkaline water-glass is the result which, on exposure to the air, deliquesces very easily.

By using 120 parts of infusorial earth to 74.5 of soda 8.62 to 8.94 ounces of gelatinous water-glass are obtained, which contains:

Dry water-glass	47 per cent.
Water	53 " "
	100

The dry water-glass contains:

Silicic acid	73 per cent.
Soda	27 " "
	100

Preparation of Soda Water-glass. I. Mix 15 parts of fine quartz-sand with 8 of sodium carbonate and 1 of wood charcoal powder. The process is the same as given for potash water-glass.

II. Mix 45 parts of quartz sand, 23 of anhydrous sodium carbonate, and 3 of wood charcoal powder. This mixture is easier to fuse.

III. Water-glass may also be prepared from 1 part of finely-pulverized quartz and 2 of crystallized soda.

IV. *Buchner* prepares soda water-glass with the assistance of Glauber's salt, using the following proportions: Quartz finely pulverized 100 parts, anhydrous Glauber's salt 60, and pulverized wood charcoal 15 to 20 parts. By this process a solution in water is obtained which is more opalescent than potash water-glass.

Preparation of Compound Water-

glass. This can be obtained either by mixing 3 parts of concentrated potash water-glass and 2 of concentrated soda water-glass; or by fusing together: Quartz 100 parts, purified potash 28, neutral anhydrous sodium carbonate 22, and pulverized wood charcoal 6. The rest of the process is the same as given for potash water-glass.

Preparation of Fixing Water-glass. This is prepared by fusing together 3 parts of pure anhydrous sodium carbonate with 2 of pulverized quartz, and making of this a concentrated solution, 1 part of which is mixed with 4 to 5 of concentrated potash water-glass completely saturated with silica.

In *Kuhlmann's* water-glass factory at *Lille* liquid water-glass is prepared by treating pulverized flint in iron boilers, under a pressure of 7 to 8 atmospheres, with a strong solution of hydrate of soda.

Water-glass as a Substitute for Cow-dung for Fixing Alumina and Iron Mordants on Cotton-prints, Linen, etc. The cotton and linen fabrics, after hanging three days to allow of a partial evaporation of the acetic acid and its conversion into basic salts, are drawn through a roller-box containing a solution of 15 parts of sodium silicate in 4500 parts of water; they are then washed and passed through a bath of cow-dung.

But the manufacturers experience great difficulty with this process on account of the sodium silicate, which generally contains some caustic alkali, and attacks the alumina mordant too strongly for alazarine, while the iron mordant used remains untouched. For this reason *Higgins* proposed calcium silicate, which was found to answer the purpose very satisfactorily. It is prepared as follows: Melt in a furnace a mixture of quartz powder and calcined soda, so that the resulting water-glass consists of 2 equivalents of silica and 1 equivalent of soda: dissolve this in sufficient water for the solution to show 30° B. Then prepare an aqueous solution of chloride of calcium of 30° B. The mixture used for cleansing the fabrics printed with bases consists of 2 parts of a solution of water-glass of 30° B., obtained as given above, 2 parts of a solution of chloride of calcium of 30°

B., and 1200 parts of water. In mixing a precipitate of calcium bisilicate is formed, which is held in suspension in the fluid. The solution contains also chloride of calcium, but the calcium bisilicate is the effective part in passing the fabrics printed with mordants through the bath. This cleansing bath takes the place of two of cow-dung. A part of the silicic acid in the calcium bisilicate combines with the alumina or iron mordant to aluminium silicate or iron silicate, both giving great intensity and constancy to the colors to be produced.

Use of Soda Water-glass for Protecting White Colors in Printing Fabrics. If white figures are to be produced under a catechu brown ground color, neutral sodium silicate furnishes an excellent protection. It is accomplished by printing upon cotton fabrics bleached white with a solution of sodium silicate. The places, when dry, appear like coated with a glass varnish which prevents the catechu color from penetrating.

Water-glass for Silicifying Stones. By dissolving pulverized chalk in water-glass a paste is formed which hardens slowly in the air, and becomes so hard that it is well adapted for repairing monuments and manufacturing mouldings.

Limestone dipped several times in a solution of water-glass and then exposed to the air acquires a very smooth surface and becomes very hard. It is also claimed that stones prepared with water-glass are suitable for lithographic purposes.

Water-glass as a Bleaching Agent. *H. Grothe*, who has made many experiments with water-glass in large bleacheries, pronounces it superior to soda for bleaching purposes. Even such materials as jute yarns become brilliantly white in a short time by subjecting them to the following process: Place the yarns for 15 to 20 minutes in a hot solution of 3 to 4 parts of water-glass in 50 parts of water, and turn them several times with a stick. They are first rinsed in hot but not boiling water, and next in cold, and then placed in a weak chlorine-bath, and finally in an acid-bath. Jute bleached in this manner can be used not only as fine material

for paper but also for fine white textile fabrics. Instead of boiling hemp and cotton yarns for 6 to 8 hours in strong solution of soda, it is only necessary to work them for 10 to 15 minutes in a very hot bath of water-glass. For 100 parts of flax-yarn 12 to 15 parts of water-glass are required, which cost 30 per cent. less than the 10 parts of soda of 90 per cent. generally used. The yarn, after being taken from the water-glass bath, must be rinsed in hot water and then in cold, and is finally placed in the ordinary chlorine and acid-baths. Linen and cotton fabrics cannot be bleached in the same manner as the yarns, as the sizing, consisting of starch, glue, gum, etc., must first be removed by boiling in milk of lime; but when this has been done bleaching is accomplished decidedly quicker and cheaper with water-glass than with soda.

For Finishing Linen and Cotton Goods water-glass can be advantageously used in place of China clay. It has the advantage of being far whiter and forming a chemical combination in the finest fibres of the fabric. To produce a precipitate the linen or cotton fabric is first passed through a hot solution of alum, and then through a hot bath of water-glass, to which has been added a small quantity of glycerine. The fabric is then passed through a weak starch-bath, and finally through warm rollers.

Potash Water-glass as a Binding and Fixing Medium for Ground Colors on Cotton Goods. For fixing ultramarine potash water-glass is better for printing than soda water-glass; but for all other printing colors the latter is the best.

The printing color is prepared by grinding ultramarine very fine in a concentrated solution of potash water-glass, then pressing through a sieve or cloth, and printing on the cloth with the cylinder printing-machine. The fabric is then hung up in the air for a few days to allow the ultramarine to combine with the silicic acid upon the fibres of the fabric, and the potash is then removed by washing. Fabrics printed with ultramarine prepared as above and dried in the air may also be drawn through a cold and very weak bath of alum or vinegar. The potash water-glass is thereby partly

decomposed and the ground color intimately combined with the cotton fibre. Rinse the fabric in running water and then dry it. Hydrochloric acid destroys the ultramarine.

Potash water-glass is a much cheaper material for printing with ultramarine than albumen, which passes quickly into putrefaction.

For Light Blue Ultramarine Colors bleached potash water-glass is used, which is prepared in the same manner as soda water-glass.

Other colors are mechanically fixed upon the fibre of cotton fabrics by grinding them in neutral water-glass and proceeding in the same manner as given for ultramarine.

Violet is obtained by mixing blue ultramarine and red carmine or cinnabar with liquid neutral water-glass.

Different green tints by mixing chrome-green, Schweinfurth green, or green carmine with liquid neutral glass.

Yellow is produced by mixing chromate of zinc or sulphide of cadmium with liquid neutral water-glass.

Orange and Red with minium and cinnabar.

Red-brown by mixing red ferric oxide with liquid neutral water-glass.

Copper-brown with cupric ferrocyanide.

White by grinding zinc-white with neutral soda water-glass.

The different vegetable lakes obtained by precipitation with alum, pink-salt, and other tin-chlorides are also very suitable for printing on cotton goods. After printing and drying they are, in order to decompose the soda water-glass, drawn through an alum-bath, whereby the silicic acid forms a combination with the lake, and precipitates itself in an insoluble state upon the fibre of the fabric. The goods are then rinsed in running water and dried in the shade.

For printing the so-called "solid blue," soda water-glass is especially well adapted as an inspissating agent. This blue is the precipitate obtained with acid chloride of tin in the cold indigo vat. After printing the color is fixed in a sulphuric acid bath, and the goods are then rinsed.

The "solid green" is obtained by

adding to the blue color solution of plumbic oxide in caustic lye. After printing the color is fixed by drawing the fabric through a bath of potassium bichromate.

Water-glass in Painting. Feichtinger states that the palace at Munich is decorated with paintings in the preparation of which alkaline silicates have been used, and some of which have been in existence for some time. The alkaline silicate liquor used has the specific gravity of 1.12, is opalescent, and, on standing, forms calcium carbonate. It leaves on evaporation a residue composed of silica 9.18 parts, potash 3.56, soda 1.14, potassium sulphate 0.66, and traces of chloride of sodium and calcium carbonate. The colors used are *white* (mixtures of 27 to 36 parts of oxide of zinc and 64 to 73 parts of barium sulphate), *yellow*, *reddish-brown*, and *dark brown*, these last being calcareous ochres; and *black*, a mixture of lampblack and manganese. They are made up into thick parts with a solution of water-glass containing silica 51.79 per cent., potash 39.05 per cent., and soda 9.16 per cent. The surface on which these colors are applied is a calcareous mortar exposed to the air for a long time.

A water-glass paint of a yellowish-white contains oxide of zinc 52.7 parts, oxide of iron 3.25, calcium carbonate 22.12, sand 21.85. This is mixed with a solution of water-glass, leaving behind 27.2 parts of residue containing silica 67.05 per cent., potash 29.4 per cent., and soda 3.55 per cent. Apparently the coloring matter in this case is a partially-calcined natural calamine.

Use of Water-glass for Coating Rough-cast and Stone Walls. Mix 1 part of water-glass with 3 of rain water. The solution of water-glass is decomposed by the lime in the mortar. The calcium carbonate is converted by this decomposition into silicate, whereby the surface acquires a glassy appearance of a darker hue, becomes solid and hard, and resists the action of the weather.

By painting white-washed walls with water-glass the coat becomes very durable, does not rub off, and can be washed. If the white color is to be preserved

some fat lime may be added to the water-glass.

Zinc white with an addition of $\frac{1}{4}$ to $\frac{1}{2}$ part by weight of permanent white and ground in water-glass gives a beautiful white color.

Water-glass in Painting Metals and Glass. Water-glass either by itself or mixed with pigments is especially well adapted for painting articles of iron, zinc, brass, etc., exposed to the action of air and moisture, and also to prevent rust. A coat of a mixture of water-glass and some elutriated manganese applied to iron will stand a red heat; nay, more, the coating will become more beautiful. This paint, as it prevents rusting, may be especially recommended for stove-pipes.

Wood Painted with Water-glass is protected against the action of fire, the atmosphere, and moisture, and is besides rendered very durable. The water-glass must be applied cold, not too concentrated nor too thick. Such solution is obtained by diluting 1 part of water-glass of 33 per cent. with 5 of rain water. Apply several coats of this to the wood, allowing each coat to dry thoroughly before laying on the next.

Creuzburg's process, according to which water-glass paint is more durable than oil or varnish, consists in grinding the pigments not in water-glass but in a compound of equal parts of water and skim milk, as pigments ground in water-glass alone rub off too easily. In painting the solution of water-glass is first applied, then a coat of paint, then again water-glass, and so on, the last coat being one or more of water-glass. Every coat must be thoroughly dry before the next is laid on.

Water-glass can be substituted for *borax* and *boracic acid*, especially for soldering, hardening, and welding cast-iron. For welding cast-iron to iron or steel scatter upon the hot surfaces to be joined a powder consisting of clay thoroughly dried 2 parts, calcined soda 1, and potash $\frac{1}{2}$.

Water-glass Cements. By combining water-glass with cement or quicklime a double silicate hard as stone and resisting chemical agents is formed in a short time.

Water-glass by itself can only be used for cementing glass to glass, and even for this a certain skill is required, but combined with other substances it furnishes a durable and hard cement.

To Cement Cracked Bottles with Water-glass. Prepare a thickly-fluid solution of water-glass. Provide the bottle with a cork fitting tightly but set on loosely, while the bottle is heated to at least 212° F. When this is done press down the cork, so that it closes the bottle hermetically, and then apply a thick coat of the water-glass solution to the cracks. The air in the bottle on cooling contracts, the pressure of the outer air forces the water-glass into the cracks, closing them so perfectly that they cannot be detected.

Hydraulic Water-glass Cement is prepared by quickly mixing finely-pulverized cement with solution of water-glass. The cement, by reason of its hardening in a very short time, must be applied as quickly as possible. It is excellent for hydraulic works, as in the water it becomes as hard as stone. The stones should be coated with a solution of water-glass immediately before applying the cement.

Water-glass Cement for Glass and Porcelain. Elutriated glass powder 10 parts, elutriated powder of fluor-spar 20, solution of water-glass 60. The ingredients are stirred together as quickly as possible, and the resulting homogeneous paste is immediately applied. The cement becomes so hard in a few days that the cemented article can be safely heated.

Water-glass Cement with Zinc and Pyrolusite. Pyrolusite 80 parts, zinc white 100, and water-glass 20. This cement hardens in a short time, and is especially adapted for cementing the joints of pipes exposed to a red heat, as, when once fused, it forms a glass-like mass of great adhesive power, and makes a very close joint.

Water-glass and Lime Cement. Quicklime 10 parts, whiting 100, solution of water-glass 25. This cement hardens slowly and can be used for flag-pavement by mixing with it small sharp-edged stones and stamping it into moulds.

Böttger's Water-glass and Lime Cement. This cement becomes so hard

in a few hours that it can be polished; it consists of whiting 100 parts and thick solution of water-glass 25, and is especially adapted for cementing the joints between marble plates.

Water-glass and Caseine Cement for Glass and Porcelain. Caseine 10 parts, solution of water-glass 60. The cement must be applied as quickly as possible, and the cemented articles dried in the air.

Water-glass mixed with powdered chalk furnishes a mortar hardening completely in 6 to 8 hours; mixed with sulphide of antimony it forms a dark mass, susceptible of a high polish; with iron filings the result is a grayish-black, very hard mass; whilst with zinc filings a very hard gray metallic mass is produced very suitable for cementing zinc work.

Water-glass for Preserving Barrels and Other Wooden Articles. Heat commercial water-glass diluted with about 25 per cent. of water and apply a coat of the hot solution to the barrel. When thoroughly soaked in, repeat the application, allow it to dry and then give a coat of a solution of 1 part of sodium bicarbonate in 8 parts of water. By the latter application the carbonic acid of the bicarbonate separates the silicic acid from the water-glass (sodium silicate) soaked into the pores of the wood, which, so to speak, silicifies the wood and renders it capable of resisting the penetration of liquids. Barrels thus treated are very durable and easily cleansed.

WATER-PROOFING COMPOUNDS.

Preparations for Water-proofing Tissues. Dissolve 33 to 36 parts of pure gutta-percha in 333 parts of oil of turpentine or benzole, filter the solution, and compound it with 333 parts of linseed-oil varnish. Apply with a brush.

II. Dissolve at a moderate heat 33 parts of white wax shavings in 1665 to 3000 parts of collodion.

III. Pulverize as fine as possible 250 parts of white bole, 1500 parts of silver litharge, and 500 parts of calcined lamp-black, and compound the ingredients with the required quantity of linseed-oil varnish.

To Make Sacking Water-proof. Dissolve 1 part of rosin in 20 parts of coal-tar oil, and filter the solution. Let the sacking lie in it for 5 days, and then rub it with litharge or lime. Then dissolve $\frac{1}{2}$ part of rosin in 4 parts of coal-tar oil, immerse the sacking several times and rub again with litharge or lime.

Soap for Water-proofing Woollen Cloth and other Fabrics. Prepare the following solutions: I. Thirty-three parts of isinglass in 66 parts of water. II. Sixty-six parts of alum in a like quantity of water. III. Sixty-six parts of white soap in 500 parts of water. Filter the solutions, then pour them together in a vessel standing on a fire, and let the mixture boil up. Then take it from the fire and apply it with a brush to the back of the fabric. When dry brush it against the grain and later on with the brush dipped in water in order to remove all lustre. The fabric is then dried. For thin woollen and cotton fabrics and silk take but half the quantity of water and soak them in the fluid.

Various Processes of Water-proofing Tissues. I. Dissolve 1 part each of glue and neutral lime soap in 20 of boiling water, and add gradually $1\frac{1}{2}$ parts of alum. Then boil the solution $\frac{1}{2}$ hour, let the resulting milky fluid cool off to 120° F., and immerse the tissues until they are thoroughly permeated, and hang them up to dry without wringing. When dry the tissue is washed, again dried and mangled.

II. Dissolve 125 parts of gun-cotton in 425 of ether and mix the solution with 375 parts of castor oil and 25 of an organic coloring substance. The quantity of castor oil depends on the degree of flexibility the fabric is to have. Apply the mixture in the same way as caoutchouc solution.

Preparation of Collodion Varnish for Water-proofing Fabrics. Dissolve 250 parts of gun-cotton in a mixture of 630 parts of ether and 100 of alcohol, add 20 parts of castor oil, and apply several layers of the solution to the fabric. Paper thus prepared, on being rubbed with a rag dipped in ether, acquires a beautiful polish. This collodion varnish can also be mixed with linseed-oil varnish or oil of turpentine varnish.

A New Water-proofing Compound is prepared by melting paraffine, and adding gradually a suitable drying oil, stirring well to insure intimate mixture; it is then poured into moulds the shape of bricks or blocks, and allowed to cool. The fabric to be rendered water-proof is rubbed over with a block of the compound, warming the rubbing face gently if the atmosphere is cold, and then ironing the cloth with a warm iron or passing it between hot rollers. The application of this compound to leather and textile and felted fabrics gives excellent results, as, although it renders the cloth thoroughly water-proof, it is not impervious to the air.

To Manufacture Water-proof Cloth which is not Impervious to the Air. Instead of water-proofing the finished cloth, coat the yarns before weaving with a solution of copal or anime, and boiled linseed-oil in oil of turpentine, which is heated and mixed with half its weight of a thick solution of caoutchouc in oil of turpentine. The yarn is drawn through the varnish and, to remove any excess, is passed through a cut in a piece of leather or rubber; it is then wound upon a roller, dried at a moderate heat, and is now ready for weaving. It is very glossy, and fabrics manufactured from it present a beautiful appearance.

Prepared Cloth as a Substitute for Leather. The cotton or linen cloth called "moleskin" is used for the purpose, both sides of it being coated with a compound obtained by mixing 100 parts of drying oil, 3 of burnt umber, and 6 of lampblack, and liquefying the mixture with oil of turpentine. When dry the cloth is passed between smoothing rollers. Several layers of this mixture may be applied, and when the last layer is dry the cloth is coated with a varnish consisting of the same ingredients as above, but a larger quantity of oil of turpentine. When this is dry, the surface is polished with pumice stone, and finally coated with a varnish consisting of linseed oil 100 parts, litharge, umber, and Berlin-blue each 3, and caoutchouc 2. The cloth is finally dried for 48 to 60 hours, at a temperature of 120° F.

To Water-proof Felt, Woollen and Half-woollen Fabrics, and to give them greater Consistence. The fabrics are treated with a solution composed of potash-alum, animal or vegetable glue each 100 parts, tannin 5, and potash water-glass 2. Three different operations are required to prepare the solution. 1. The potash-alum is dissolved in an equal quantity by weight of boiling water. 2. The glue is allowed to swell up in cold water until it has absorbed double its quantity by weight. The excess of water is then poured off, and the glue brought to the boiling point, and the tannin and soda water-glass are then added. 3. The two solutions are now mixed together and boiled, with constant stirring, until a complete union has taken place, when it is allowed to cool, whereby it will acquire a gelatinous consistency. For treating felt or other fabrics a bath is prepared by boiling 1 part of the gelatinous compound with 10 to 12 parts of water for 3 hours. The water evaporating in boiling is always replaced by fresh, so that the bath retains its density, which is regulated by a test with the densimeter. The bath is then cooled to 175° F., and the felt or fabric immersed in it for $\frac{1}{2}$ hour. The impregnated fabric is then spread upon a table for 6 hours to allow the fluid to drain off. This must be done at an ordinary temperature, and in such a manner that the fabric lies in a perfectly horizontal position and is everywhere equally permeated. The fluid draining off is collected and again used. The fabric is then dried in the sun or in a room heated at most to 120° F.; kept in a horizontal position, so that the fluid remains equally distributed over the entire surface. Finish by passing the fabric through rollers heated to 120° F. Felt or other fabrics prepared in this manner possess more consistency and power of resistance than ordinary tissues—are water-proof but not impervious to the air. If the fabrics are subjected to this treatment after dyeing it helps to fix the colors, but for very tender colors it is advisable to use almost white glue and perfectly pure alum, *i. e.*, containing no trace of iron, as this would injure the colors.

To Water-proof Vegetable Fibres. Compound 20 parts of petroleum as inodorous as possible with $\frac{1}{2}$ part of ordinary, $\frac{1}{4}$ of very light rosin, and $\frac{1}{4}$ of paraffine, heat the mixture at 167° F. until all are dissolved. Then add 60 to 80 parts of water, and heat the whole until the fluid becomes clear. Then, after cooling the mixture to about 140° F., immerse the fibres in it, and allow them to remain until no more foaming up is perceived on the surface. Yarns, tissues, ropes, bags, etc., are slowly drawn through the bath until the above-named foaming up ceases. The impregnated fabrics or fibres are then freed from adhering parts of the mixture by passing them through rollers. They are then thrown into water for 1 to 2 hours, again passed through rollers, this manipulation being repeated until the impregnating mixture is almost entirely removed from the surface of the fibres or fabrics, and they are then dried.

To Water-proof Textile Fabrics, Leather, Paper, etc. The compound consists of 100 parts of best quality of white or yellow wax, 6 parts of English varnish, 4 parts of Burgundy pitch, 8 parts of peanut oil, 5 parts of sulphate of iron, and 2 parts of essence of thyme. The pitch is melted in an iron boiler, and the wax together with the sulphate of iron in another. Both are then poured together, intimately mixed and kept at a moderate heat until the compound is liquid and homogeneous. The fabrics to be water-proofed are immersed in it, and then freed from an excess by passing through heated rollers. For water-proofing leather the compound is applied with a brush to the inner side with the leather lying upon a heated plate.

To Water-proof Paper add to the stuff a solution of pure tallow soap in water, to which has been added sufficient alum to effect an entire decomposition of the soap. The stuff is then worked up in the ordinary manner, but requires no sizing.

For Water-proofing Woollen Fabrics. Boil 12 $\frac{1}{2}$ parts of Castile soap in 1200 parts of water, and 16 $\frac{1}{2}$ parts of alum also in 1200 parts of water. Heat both solutions to about 195° F., then pass the fabric several times

through the soap-bath, and through the alum solution, and dry in the air.

II. The following mixture answers the same purpose: Borax 15 parts, isinglass 100 parts, sago 3 parts, salep 2 parts, stearine 15 parts, and water 1000 parts.

Impregnation with Caoutchouc. Mix intimately 30 parts of alumina with 100 parts of a concentrated solution of caoutchouc in oil of turpentine, spread the cloth upon a table and apply the compound with a brush, and dry. Several layers of the compound may be applied, the thickness of each coat varying according to the number of layers. Should the non-coated side of the cloth undergo any change, cleanse it with alcohol.

Impenetrable Double Stuff. The principal feature of this fabric consists in it being formed by uniting two tissues, which without being impervious to the air are water-proofed by the above compound or by the following preparation: Mix $62\frac{1}{2}$ parts of alum, 50 parts of white lead, and 900 parts of water. After these ingredients have acted upon each other for some time, pour off the clear liquid and immerse the fabrics in it to saturation. Then place them in an ordinary soap-bath, wash and dry them. The caoutchouc solution is then applied in oblique strokes to the surfaces to be joined, so that when the two fabrics are placed together the strokes upon the first cut those upon the other at a right angle. Small squares are formed in this manner which allow of the passage of air and transpiration, without moisture or rain being able to penetrate through the double fabric.

Becker, Delivaire & Co. make cloths and other fabrics water-proof by coating them with a mixture of: Spermaceti 58 parts, flaxseed 78 parts, decoction of snails (from 200 snails) 29 parts, isinglass and alum each 175 parts. Each of the ingredients is dissolved by itself in boiling water, and the solutions are then mixed. In place of spermaceti, stearine saponified with caustic soda-lye may be used, and the decoctions of flaxseed and isinglass compounded with some ammonia. The alum-bath may be used by itself or the decoction of flaxseed is first stirred into the solu-

tion of isinglass, then the soap, and finally the alum solution, the whole being heated to 100° to 120° F. An addition of a little sulphuric acid makes the compound adhere better to the fibres. Cloth water-proofed in this manner is not impervious to air and transpiration.

A New Process of Water-proofing Fabrics is as follows: Dissolve at a moderate heat 35 parts of stearic acid in 850 parts of spirit of wine, pour the solution upon 1100 parts of pulverized alum and expose the whole to a temperature of $98\frac{1}{2}^{\circ}$ F. For water-proofing cotton and linen fabrics immerse them in a solution of 1 part of this powder in 100 of water, and then dry them. For silk 1 part of the powder in 200 of water is used.

Vanel's Water-proof Composition consists of mineral salts and stearic or margaric acid. It is prepared as follows: The salt and about 50 parts of sebacic acid are mixed with 1000 parts of water, the mixture filtered through a felt bag, and the residue pressed to dryness. One part of this residue in 100 of water forms the bath in which the fabrics are immersed. They become water-proof but not impervious to the air. All kinds of tissues, paper, and leather can be subjected to the process. The composition is inodorous and does not injure colors.

Roelandt's Water-proofing Compounds. Dissolve 1 part by weight of caoutchouc and 1 part by weight of paraffine or stearine in 2 parts by weight of benzine, dilute the compound to the proper consistency, and apply it with a brush or immerse the substances in it.

To make Boots and Shoes Water-proof use the following preparation patented in France: Soda 20 parts, oil of turpentine 50, tar-oil 160, rosin 25, linseed oil and isinglass each 15, gutta-percha 125, and glue 25.

To Water-proof Sugar-bags for Transport use a compound also patented in France, prepared from 100 parts of best starch, 50 parts of rosin, 25 parts each of potash and boiled linseed-oil, and sufficient water to form a paste of more or less consistency, according to the material with which the bags are to be lined, strong paper or muslin being used for this purpose. Coat the inside of

the bag with the paste, and while moist press on it the paper or muslin lining, which should be large enough to lap over the seams. Dry in summer in the sun and in winter in a room heated to 104° F.

The following Water-proofing Compound has been patented in England: Mix about 100 parts of alumina with 40 parts of flaxseed and 70 parts of alcohol, let it stand to settle and press the sediment formed into blocks. For water-proofing fabrics, dissolve 5 to 7½ parts of the compound in 300 parts of water.

Water-proofing Felt Hats. Pulverize: Ordinary shellac 4 parts, white pitch, fine glue, and ordinary soap each 1 part, and purified potash ½ part. Dissolve the potash in 2 parts of warm water, place the other ingredients in a copper boiler on a coal fire, and as soon as the mixture begins to liquefy add the potash solution, and finally a little more soap dissolved in water. Apply the compound with a brush.

Water-proof Sail-cloth, known by the name of "Imperial Cloth," is prepared in the following manner: Seventy-two parts of fine linseed oil are boiled for 2 to 3 hours with 6 parts of sulphate of iron and 4 of sulphate of zinc, and, when cool, mixed with 60 parts of oil of turpentine and the necessary quantity of lampblack. The sail-cloth is painted with this compound and dried in the sun. After 8 or 10 days the application is repeated. We will here remark that it is necessary to shrink the sail-cloth in water and dry it before applying the compound.

Zwilling's Water-proofing Compound. Put a porcelain dish in a water-bath and place in it the following ingredients: Caoutchouc cut up very fine 50 parts, Venetian turpentine 3 parts, and paraffine oil 66½ parts. Let the mixture stand in the water-bath at a temperature of 98½° F. for 1 day, then add 66½ parts of oil of turpentine, mix thoroughly by stirring, and leave the compound in the water-bath for 10 days, then add 583 parts more of oil of turpentine, and let it stand for 14 days longer in the water-bath. The product will be 750 parts of yellowish liquid, which is applied with a brush, and the fabric is then dried at 120° F.

Dr. Fournaise's Water-proofing Compound. Immerse the fabrics in a bath of 4° to 5° B. of acetate of alumina, prepared, not by double decomposition, but by dissolving hydrate of alumina in acetic acid. The fabric is immersed in this solution for 1 hour, then pressed dry, and, to expel the acetic acid from the combination, exposed in a steam-box to a temperature of 230° to 248° F.

Kuhr's Receipt for Water-proofing Linen. The linen is first immersed in an alum-bath composed of a solution of 1 part of neutral sulphate of aluminium in 10 of water, and, when thoroughly saturated, in a hot soap-bath prepared by boiling 1 part each of colophony and soda in 10 of water, separating the soap with 1 part of salt, and dissolving this soap and 1 part of white hard soap by boiling in 30 parts of water. The fabric is then dried.

To Water-proof Textile Fabrics and Paper and to Give them Greater Consistence. To water-proof paper take: Soda 100 parts, rosin 270 parts, gamboge ½ part, and 100 parts of lime. Slake the lime in water, and dissolve the soda in water. Heat the soda solution in a boiler, and add sufficient milk of lime to make it caustic. The rosin and gamboge are melted together at a moderate heat. Pour this melted compound gradually into the caustic soda-lye until it is no longer dissolved by it. On cooling the compound congeals to a solid mass, which is kept for future use. For water-proofing paper or textile fabrics dissolve 10 parts of this compound in 100 parts of boiling water. Next prepare a solution of 10 parts of alum in 100 parts of water. The paper or fabric is immersed in the first and then in the second solution, and dried by passing between hot rollers or in any other manner. For white paper or fabrics the gamboge is omitted.

Composition for Water-proofing Textile Fabrics and Protecting them against Moths. Dissolve separately 5 parts each of alum and sugar of lead in sufficient water. Heat the solutions and mix them while warm; then allow the mixture to stand quietly until a precipitate of sulphate of lead is formed. The clear fluid, now containing acetate of alumina, is then poured off and mixed with 500 parts of water

containing some solution of isinglass. Immerse the articles for 12 hours in this fluid until saturated, then dry and press them. They are water-proof, but not impervious to air, and not attacked by moths.

WAX AND WAX PREPARATIONS.

Unadulterated beeswax is of a pure yellow color, has a honey-like smell, breaks easily into small pieces, does not dissolve in cold spirit of wine nor oil of turpentine, and melts at 143.6° F.

To Bleach Beeswax. A wooden vat of about twice the volume of the wax should be lined with lead and have on its bottom a coil of perforated lead pipe. Faucets should be placed different heights. Thirty parts of water to every 50 parts of wax are first placed into the vat, and brought to the boiling point by introducing steam in the serpentine pipe. Then add to the water for every 50 parts of wax 6 to 7½ parts of potassium bichromate, according to the light or dark color of the wax, and about 24 parts of concentrated sulphuric acid. Now melt the wax in water in another vessel by introducing steam, and pour it either directly into the bleaching liquor or allow it first to congeal and add it in a solid state. After the wax has been placed in the bleaching liquor introduce steam through the serpentine pipe, and let the whole boil vigorously for about 1 hour. Steam of about 5½ pounds pressure to the square inch should be used; too hot steam, being injurious to the wax, must be avoided. Take occasionally a sample from the vat and examine it in a test-glass. The process is finished if the wax floats as a green layer upon a black fluid. Let the mass stand quietly for half an hour, then draw the wax off into another vat containing 7½ parts of water and ½ part of sulphuric acid, or, still better, oxalic acid. Heat the mixture to the boiling point by steam introduced through a pipe on the bottom of the vat, and continue boiling until the wax has lost its green color. The wax is finally washed with water and poured into moulds.

Green Wax. Melt 200 parts of yellow wax, 100 parts of white rosin, and 66½ parts of ordinary turpentine; mix the

compound with 16½ parts of pulverized verdigris, and pour the mass, while hot, into paper capsules.

Black Wax. I. Melt in a copper boiler 550 parts of yellow wax, and add gradually and with constant stirring 50 parts of prepared silver litharge, and boil until the compound begins to assume a brown color; then add 16½ parts of calcined lampblack rubbed very fine, mix thoroughly, and pour the mass into paper capsules.

II. Melt in a porcelain dish 333 parts of yellow wax and 83 parts of Venetian turpentine; then add gradually and with constant stirring 33 parts of black sulphide of mercury, and pour the mass into paper capsules.

Red Wax. Melt 20 parts of white wax and 12 of Venetian turpentine, add 1 part of fine cinnabar, and pour the mass into paper capsules.

Polishing Wax. Melt ½ part of yellow wax and ½ of rosin, and add ¼ part of oil of turpentine.

Polishing Wax for Furniture. Pour 3 parts of oil of turpentine over 4 parts of white wax in an earthen vessel, cover the vessel tightly with strong paper, and place it in warm water on the back part of a warm stove to melt the wax. When both substances are united let the mixture cool until it begins to be solid and assume a whitish color, then add and mix with it 2 parts of strong alcohol.

Another Polishing Wax for Furniture is prepared by melting 8 parts of white wax, 2 of rosin, and ½ of Venetian turpentine over a moderate fire, pouring the compound while warm into a suitable earthenware pot, and stirring into it 6 parts of rectified oil of turpentine. In 24 hours the polish will have acquired the consistency of soft butter, and is then ready for use. Now carefully cleanse the furniture with soap-water, and, when dry, apply the polish in a thin layer with a woollen rag, rubbing first gently and then more vigorously. Then let the furniture stand for ¼ to ½ hour, and rub once more thoroughly with a woollen cloth.

Wax Soap. Melt ½ part of crumbs of wax in 1 part of caustic soda-lye. Should the soap thus obtained be too caustic add some more wax and rain-water, and unite the whole by melting

and stirring. This soap is used for waxing floors, etc.

To Prepare Waxed Paper. Place a level sheet of copper over a moderate coal fire, and cover it with a clean sheet of paper as a basis for the work; place the paper to be prepared upon this, smear it over with yellow or white wax, and distribute it uniformly over the whole sheet by means of a sponge until the paper is transparent. The success of the work depends principally on the condition of the fire; it must be neither too strong nor too moderate, as in the first case it blackens the paper, and in the latter makes the labor very difficult.

Colors for Wax-Work. Every wax-worker should thoroughly understand the mixing of colors to give to the different articles fashioned of wax a pleasing and natural appearance. The colors given in the following must be rubbed up in oil of turpentine:

Rose Color. Rub a rose color with fine Vienna lake and Kremnitz white, paint a rose upon the wax candle or other article to be decorated, then add a little more white, making the color somewhat whiter, paint a few rose-petals upon the first red ground, and finally shade with some Vienna lake.

Yellow Flowers, for instance daffodils, are entirely painted with chrome-yellow, with the exception of the pistil, which is executed with Vienna lake, and the work is then shaded with dark ochre.

Blue Color. To paint larkspur, blue gilly flowers, etc., mix Parisian blue with white to a sky-blue, and paint the flower with this. Lighter shades are obtained by adding more white. Shade with Parisian blue.

Violet Colors. By mixing Parisian blue, white, and Vienna lake, a beautiful lilac is obtained. The flower is painted with this; then add some white and Vienna lake to make the color 4 shades lighter than the first; paint the petals with this, and shade with fine Vienna lake.

Leaves are painted alternately with verdigris and mineral green or with chrome-yellow and blue. To produce different tints these colors must be suitably mixed. After the wax ground

is painted the decoration must be coated with a very light varnish, prepared as follows: Dissolve in 330 parts of spirit of wine 133 parts of sandarac, 33 parts of mastic in grains, and 16 parts of white pine rosin.

Gold Ground upon Wax. Take some copal lacquer, white lead, and red minium; paint the flowers and decorations with this; allow it to dry and then gild it.

Wax for Waxing Threads to be Woven. Mix 1 part of pulverized graphite with $\frac{1}{4}$ of pulverized soapstone and $1\frac{1}{2}$ parts of melted beeswax. The compound, when cold, is ready for use.

Wax Tapers. Two wooden drums having a diameter of $7\frac{1}{2}$ to 10 inches are required; further, a trestle (horse) with two clamps, between which is placed the draw-iron provided with holes of different dimensions. The drums, provided with cranks for turning, stand one on each side of the trestle. Upon one is wound the wick, which is passed through melted wax and then through the narrow hole of the draw-iron, and wound upon the other drum. It is again passed through melted wax and a wider hole of the draw-iron, again wound up, and this operation repeated until it has acquired the desired thickness. The room in which the work is done must be moderately warm, so that the wax is kept neither too hard nor too soft. As wax by itself is too brittle it is best to use the following composition: Yellow wax 8 parts, white rosin 4, tallow 2, and turpentine 2.

To White Wax add $\frac{1}{4}$ of its weight of tallow and $\frac{1}{8}$ of Venetian turpentine.

For Coloring the Tapers, vegetable colors, as indigo, infusion of Brazil wood, annotto, etc., are used.

Wax Candles. Mix 1 part of white wax and $\frac{1}{4}$ of tallow. Insert the wick in the mould, which should stand accurately perpendicular, and, to prevent it from shifting, fasten it in a vessel standing under the mould. Then saturate the wick by pouring melted wax over it, and, when this coat has somewhat stiffened, continue the pouring until the desired thickness has been obtained. Cut off the candles while still warm, roll them smooth upon a moistened marble plate, and bleach in the sun. The candles must be moist-

ened every evening and turned daily until they are sufficiently white.

Floor Wax. Boil 5 parts of purified potash, 20 parts of water, and 25 parts of wax, stirring constantly, until a thickly-fluid and homogeneous compound has been formed, and no more watery fluid is separated. Then take the vessel from the fire carefully, add first a few drops of boiling water and then a larger quantity, so as to form a fat-like mass, in which no water can be detected. Then replace the vessel on the fire, heat the compound without allowing it to come to a boil, and add gradually and with constant stirring 400 to 450 parts of hot water.

Yellow Floor Wax is obtained by an addition of finely-pulverized gold ochre to the above composition ;

Brown, by adding umber ;

Red, by an addition of colcothar ;

Beautiful Golden Yellow, by adding 12 parts of golden ochre and 3 parts of annatto.

New Compound for Waxing Floors. Linseed oil 200 parts, litharge 20, wax 150, tallow 15, molasses 190, lampblack 103, oil of turpentine 280, alcohol 35, shellac 5, aniline violet 2. Boil the linseed oil with the litharge for 1 hour, then melt the wax and tallow in the hot fluid, add the molasses, and keep the whole at a temperature of 230° to 248° F., until all the water is volatilized. Then add the lampblack or any other coloring matter, and, after cooling, the oil of turpentine, and finally the shellac dissolved in alcohol and the aniline violet.

Spirit Lacquer for Lacquering Wax Tapers. Place 25 parts of mastic and 250 parts of sandarac in a fine sieve, and suspend the latter in a tin vessel containing 600 parts of alcohol of 96 per cent., in such a manner that the resins are just covered with the alcohol. After 24 hours, when all the resins will be dissolved, filter the solution.

Excellent Modelling Wax. Melt carefully over a moderate coal fire 100 parts of yellow wax, and then add 13 parts of Venetian turpentine, 6½ parts of lard, and 72½ parts of elutriated bole. Mix thoroughly, pour the mixture gradually into a vessel containing water, and knead it several times with the hands. The wax must be melted at

so low a temperature as not to create bubbles.

WOOD—GILDING, POLISHING, STAINING, ETC.

Extraction and Impregnation of Sounding-board Wood. The object of the invention is to remove the soft rosin from the wood and replace it by a hard resinous substance. The extraction is accomplished by placing the boards for 4 hours in petroleum ether, and then drying them in the shade in the open air. To replace the extracted natural rosin by a hard resinous substance the boards are placed for 2 days in a holder containing a spirit varnish composed of glassy copal, sandarac, pulverized glass, and aloes. The boards are then dried and are ready for use.

To Prepare Sounding-board Wood. The wood to be prepared is strongly heated for 12 hours in a hermetically-closed boiler, K (Fig. 53). The boiler is then opened for a few hours and the wood, slightly heated, exposed to the action of ozone. The oxygen is generated in the reservoir A, which, like the boiler K, is lined with chanotte* to protect it against the action of the oxygen, and ozonized in the boiler K by electrical sparks. By this process the resinous and fatty constituents of the wood are extracted.

To Make Wood Flexible and Fire-proof. To accomplish this the rosins contained in the wood are saponified, and the acids neutralized with alkalies obtained from wood ash. Although all alkaline combinations possess the property of rendering vegetable substances more or less flexible and fire-proof, the carbonates are preferable ; they are used in the following manner : Dissolve carbonate of potassium or sodium in cold clear water, and add calcium hydrate to the solution. Then immerse the boards or timber in the alkaline solution until a coating ¼ to ½ inch thick has been formed, which will require about 5 to 12 hours. A

* Chamotte is a mixture of unburnt fire-clay and dust of fire-bricks, glass pots, or seggars.—W. T. B.

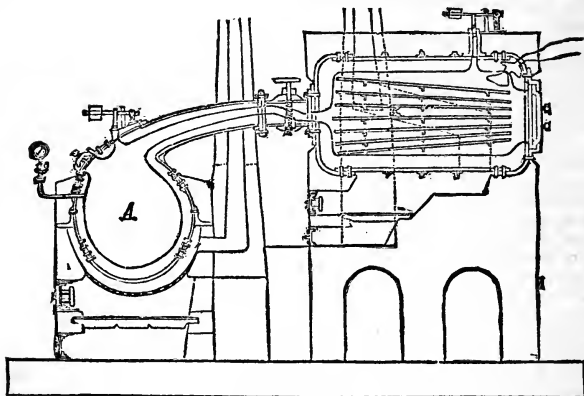

Fig. 53.

coating $\frac{1}{2}$ inch thick suffices to render building timber fire-proof, but in case great flexibility with absolute non-inflammability is desired, a thicker coating or even an entire saturation of the timber will be necessary, which is accomplished by hydraulic pressure.

Thin veneers of any dense, veined wood treated in the above manner can be rendered sufficiently flexible to resemble tanned leather. To attain this result immerse the veneers in the alkaline solution for a sufficiently long time to acquire a transparent appearance, which will require from 15 to 40 minutes, according to their nature and thickness. They are then allowed to dry, and rolled and pressed between steel cylinders or plates. Veneers treated in this manner can be used for many purposes instead of leather, and are especially well adapted for chair bottoms, wainscoting, etc.

To Render Wood Incombustible and Impermeable. Folbacci uses a process by which wood is, so to say, petrified without losing its ordinary appearance. It will bear any degree of heat without the primary substance suffering any change, except the formation of an extraordinarily thin charred coating, which falls off on the lightest touch. The process is as follows: Heat in a

boiler 55 parts of water to 113° F., and then add 55 parts of sulphate of zinc, 22 of potash, 44 of alum, and 22 of manganic oxide. When all are dissolved, add gradually 22 parts of sulphuric acid of 60° , until the compound is thoroughly saturated. Then place the pieces of wood into the compound in such a manner that they lie about 2 inches apart, allowing them to remain for 3 hours, and then dried in the open air.

To Render Wood Fire-proof. Boil the wood first in a solution of potassium sulphate and, after drying, heat it together with a mixture of coal-tar and argillaceous admixtures, by which it acquires a durable coating of a mixture of asbestos and fire-clay. Heat the wood thus treated in a steam-vat between layers of clay, whereby the coating is firmly united with the wood. Timber prepared in this manner is fire and weather-proof, and well adapted for building purposes.

To Render Wood Impermeable to Water. Even the softest kind of wood, as that of the poplar and lime tree, can be made water-proof by the following process: Coat the article several times with hot linseed-oil varnish, and finally apply quite a thick layer of polish. Wooden gutters for holding water for

moistening the threads in throwing silk and thread were made water-proof in this manner.

How Oziers can be Peeled in Winter. Steam the oziers for 10 to 14 minutes in a closed cylinder, and then place them for 24 hours in water of about 100° F.

Staining Wood for Fine Cabinet Work. *Denninger, of Mayence*, has made a series of experiments in staining maple wood. Of the coloring matters used he prefers decidedly the alcoholic extracts to aqueous decoctions, since, on account of the woods having to remain longer in the decoction, the pores are opened too widely and the coloring matter penetrates too deeply into the soft parts of the wood, while the hard parts remain almost untouched. For soft varieties of wood aqueous coloring extracts must therefore be entirely avoided.

Denninger advises also against the use of strong acids, as aqua fortis, hydrochloric and sulphuric acids, since the slightest excess of these acids exerts later on an injurious and frequently destroying effect upon the polish. The alcoholic extracts are of course more expensive than the aqueous decoctions, but they furnish a more uniform and intense coloring and go a great deal further.

Denninger made use of the following coloring matters and other materials :

a. Gallic Acid. This is prepared by pouring ordinary spirit of wine over pulverized black or white gall-nuts, allowing the mixture to stand in a warm place for a few days, stirring frequently, and then straining it.

b. Sulphate of Iron. Roast it in an iron pan over a coal fire until it turns reddish; when cold pulverize it, and pour spirit of wine over it.

c. Logwood Shavings. *d. Pulverized Sanderswood.* *e. Saffron and Annatto.* Pour spirit of wine over them and treat the tincture as given under *a.*

d. Shavings of Brazil Wood, and *g. of Fustic.* *h. Crushed Persian Berries.* Pour water over them and use the infusion cold.

e. Pulverized Cochineal. Boil it with double its weight of spirit of ammonia and water in a water-bath until the spirit of ammonia is volatilized; then mix the fluid with spirit of wine, and filter.

f. Aqueous Decoction of Logwood is compounded with some solution of alum in water. The precipitate formed is collected upon a paper filter, dried and formed into a paste with a few drops of hydrochloric acid, and then dissolved in spirit of wine.

g. Pulverized Indigo. Dissolve indigo in four times its own weight of fuming sulphuric acid, allow the solution to stand in a warm place for a few days and then dilute it with water.

h. Solution of Tin. Dissolve 50 parts of granulated tin by boiling in 50 parts of hydrochloric acid; or, *h'*, dissolve 33½ parts of granulated tin by boiling it in 50 parts of hydrochloric acid. And also ½ to ¼ ounce each of the following salts: *i. Alum.* *j. Potassium bichromate.* *k. Potassium ferrocyanide,* and *l. Sulphate of copper.* Dissolve the salts in so much water that a part of them remains undissolved on the bottom of the vessel.

In the following we give a number of colors and the materials used by *Denninger* in producing them:

Blue. Dilute a solution of indigo with a sufficient quantity of water.

Bluish-brown. Dilute a solution of logwood extract with spirit of wine, and add some solution of tin (*h'*).

Bluish-gray. Dilute a solution of cochineal strongly with spirit of wine, and add solution of indigo.

Blue-black. Dilute a solution of extract of logwood with spirit of wine, and add solution of sulphate of iron.

Brown. Mix equal parts of solution of extract of logwood and solution of saffron, dilute with spirit of wine, and add some solution of tin (*h'*).

Brownish-red. Mix a decoction of Brazil wood with some solution of tin (*h'*).

Crimson. Dilute a solution of cochineal with spirit of wine.

Dark Gray. Use first extract of gall nuts, then solution of sulphate of iron, and finally indigo solution diluted with water.

Greenish. Extract of saffron with an addition of some indigo solution.

Green. Same as above with an addition of more indigo.

Greenish-gray. Mix decoctions of gall nuts, sulphate of iron, and fustic with some solution of indigo.

Yellowish-gray. Decoction of Persian berries mixed with some solution of sulphate of iron.

Light Brown. Sulphate of copper dissolved in water, then solution of potassium ferrocyanide in water with an addition of some hydrochloric acid.

Cherry-red. Decoction of Brazil wood diluted with spirit of wine, and then solution of tin (*h.*).

Orange. Annatto or saffron dissolved in spirit of wine.

Red. Solution of cochineal mixed with solution of saffron.

Red-brown. Dissolve precipitate of logwood (*f.*) in spirit of wine compounded with some hydrochloric acid.

Rose Color. Compound a solution of cochineal with some alum water.

Straw Color. Use first decoction of Persian berries and next solution of tin (*h.*) much diluted with water.

Other Stains on Wood. *Thimm's Patent.* The woods are painted with suitable concentrated solution of metallic salts, and then thoroughly dried, which will require about 12 hours. They are then placed in a closed room into which gases, as sulphide of hydrogen, ammonia, etc., are introduced according to the combination to be produced.

By using sulphide of hydrogen the following colors are obtained:

Brown from bismuth sulphide formed from bismuth nitrates.

Yellow from cadmium sulphide formed from solutions of cadmium sulphate.

Golden Yellow from stannic sulphide formed from solutions of stannous chloride (tin salt).

Iron Gray to Brown from lead monosulphide formed from a solution of acetate of lead.

Green from chromium sesquioxide formed from solutions of chromic acid.

Red from antimony trisulphide formed from solutions of antimony.

The cost of this process is very small, since 2 pounds of any of the solutions will cover 100 square feet of wood surface. The woods can also be provided with various designs in any color desired. The colors are not affected by air, light, or water.

The very cheap solution of ferric hydrate in ferric chloride is used for

completely saturating floors, stair-steps, and other articles subjected to strong wear, which are then colored by means of ammonia. Wood thus treated is also far less inflammable than when painted.

Black Ground for Lacquering. Grind fine ivory-black in shellac-varnish upon a stone slab with a muller until a perfectly smooth varnish is obtained. The following directions give good black grounds:

I. One pound each of asphaltum and copaiba balsam and the necessary quantity of turpentine. Melt the asphaltum over a fire, then add the balsam previously heated, and finally the oil of turpentine. II. Moisten lampblack with oil of turpentine and rub it very fine upon the stone with a muller. Then add ordinary copal varnish and mix all thoroughly. III. Take 3 ounces of asphaltum, 4 quarts of boiled linseed-oil, 8 ounces of burnt umber, and some turpentine. Melt the asphaltum, stir the oil previously heated into it, then the umber, and, when cool, dilute the mixture with turpentine.

IV. An *extra black* is obtained from 12 ounces of umber, 2 ounces of purified asphaltum, $\frac{1}{2}$ pint of boiled linseed-oil, 2 ounces of rosin, and $1\frac{1}{2}$ pints of turpentine. Melt the asphaltum and rosin together, add the oil in a hot state, stir thoroughly, and then mix the turpentine with it. V. A *white ground* is obtained by mixing equal parts of copal varnish and zinc white or starch.

To Stain Walking Canes. I. Apply to the sticks in a natural state a more or less concentrated solution of calcium hydrate in water, according as the stain is to be more or less dark.

II. Dissolve iron filings in sulphuric acid, apply the solution to the sticks in a natural state, and burn them at once over a fire of wood shavings. This burning must be done thoroughly, as stains, spoiling the work, will be formed in case any places remain untouched by the fire.

To Stain Maple Wood Silver-gray. I. Upon the bottom of a water-tight box place a layer of grindstone sand (from the troughs of grindstones) upon this wood, and then again a layer of grindstone sand. Then pour over it sufficient

rain water to cover the whole, and place the box in a warm place for 3 to 5 weeks. Replace occasionally the water lost by evaporation, so that the wood is never dry. By this process a beautiful silver-gray color is produced on maple and lime wood.

II. Place the wood for 3 to 4 hours in a decoction of 1 part of pulverized gall nuts in 10 of water, and then for 1 hour in a solution of 1 part of sulphate of iron in 60 of cold water, and then brush it off with a soft brush dipped in a solution of 1 part of alum in 18 of water, and allow it to dry. Should the color be too light repeat the process, but allowing it to remain in the baths only a few minutes.

III. Pour sharp vinegar over iron filings and alum, and brush the wood over with the solution until the desired silver color is obtained. Gall nuts converted into coarse powder may also be used in place of the iron filings.

IV. Dissolve verdigris in vinegar or crystallized verdigris in water, and paint the wood with the solution until it has acquired the tint desired. The solution may be used either warm or cold.

Ebony Stains. To prepare a very fine ebony stain applicable especially to pear or walnut woods boil 40 parts of gall nuts, 4 parts of rasped logwood, 5 parts each of sulphate of iron and verdigris with water, strain through linen and apply the warm fluid to the wood, and then give it 3 coats of a warm solution of 10 parts of iron filings in 75 parts of vinegar.

For Veneers which are to be stained through and through place 16 parts of sal-ammoniac and a sufficient quantity of steel filings in an earthenware pot, pour strong vinegar over them, and let it stand for 14 days in a moderately warm oven. Then pour sharp lye into another pot, add gall nuts converted into a coarse powder and shavings of blue Brazil wood, and let the whole stand in a warm place for a few days. This gives an excellent stain.

Boil the veneers for a few hours in the first stain of sal-ammoniac and steel filings, and let them remain therein for 3 days. Then place them in the second stain, and proceed in the same manner as with the first.

In case the veneers should not be entirely colored through repeat the operation.

Stain for Floors. Boil 25 parts of fustic and $12\frac{1}{2}$ of Brazil wood with 1000 parts of soap-boiler's lye, to which has been added $12\frac{1}{2}$ parts of potash. When the liquid is boiled down to 700 or 800 parts, add $3\frac{1}{2}$ parts of annotto and 75 parts of wax, and when this is melted stir the compound until it is cold. It is of a brown-red color, and the above quantity suffices to keep a floor in good condition for a year by applying it once a week, and rubbing it on with a brush.

Staining Wood for Veneers, Mosaics, etc. Treat the wood for 24 hours with a 10 per cent. caustic soda-lye, then boil it therein for half an hour and wash it to remove the alkali. This prepares the wood for the reception of the color. Dry the wood with filtering paper and press it to preserve the shape. Then immerse it for 24 hours in a dye-bath consisting of $\frac{1}{2}$ dye-wood and $\frac{2}{3}$ liquid, turn it occasionally, and throw it in a bath of 1 part of sulphate of iron to 3 of water, and the result will be a beautiful black.

Yellow is obtained with 1 part of picric acid dissolved in 60 of water.

Various Rose-colored Tints by adding a little caustic soda to coralline.

Red Stain. Immerse the wood in a solution of $3\frac{1}{2}$ parts of Marseilles soap in 100 of water, and then apply aniline red sufficiently diluted to give the desired tint.

Violet. Treat the wood in a bath consisting of $12\frac{1}{2}$ parts of olive oil, a like quantity of calcined soda, and 125 parts of boiling water; then stain with aniline red to which tin salt has been added.

Blue is produced in the same manner, except that aniline blue is used as a stain.

Green. Mordant the wood first with a solution of aluminium acetate of 1° B., and then place it in a decoction of Persian berries and indigo-carmine. Quercitron may also be used in place of Persian berries.

Bright Red. Boil for 3 hours $6\frac{1}{2}$ parts of cochineal ground very fine in 100 parts of water, and paint the wood with the solution. When dry apply a coat

of a solution $3\frac{1}{2}$ parts of tin-salt and $1\frac{1}{2}$ parts of tartaric acid in 100 parts of water.

Brown in Various Tints is produced by mordanting the wood with potassium bichromate, and applying later on decoctions of fustic, logwood, or Brazil wood.

Moiner's Method of Staining Wood Rose Color by Chemical Precipitation. Wood, and also vegetable ivory, can be colored rose-red without much difficulty by chemical precipitation. The resulting color is very brilliant and uniform.

First Bath. This consists of 8 parts of potassium iodide to 100 parts of water.

Second Bath. Two and one-half parts of corrosive sublimate to 100 parts of water.

Immerse the wood for a few hours in the first bath. Then place it in the second, in which it will acquire a beautiful rose-red color. The wood, after drying, is varnished. Both baths can be repeatedly used without renewing them.

New Polish for Wood. Compound an alcoholic solution of 3 parts of shellac with a solution of 100 parts of colloid cotton and 50 parts of camphor in ethyl alcohol. For finishing use a mixture of benzole and alcohol.

Moody's New Polish consists of 8 parts of rectified wood spirit, $1\frac{1}{2}$ of shellac, and $\frac{1}{2}$ of benzoin, and if desired $1\frac{1}{8}$ of dragon's-blood may be added. Dissolve the ingredients by heating, and filter the solution through flannel. Apply with a camel's-hair brush.

Gilding on Wood. The gilding on wood, called oil gold, cannot be burnished, and is always of the natural color of unwrought gold. It has the advantage that it may be washed and cleansed with water, which burnished gold will not stand. It is often used for parts of furniture and mouldings of rooms, and as it stands the weather it is also employed for outside work. The surface to be gilded must first be rubbed smooth with shave grass. After this apply a priming of glue size and two coats of oil paint and one of flattening. To enrich the color of the gold these last may be laid down in red or yellow. White, however, is usually preferred, as the darker color renders

any imperfection in the gold-sizing more difficult to detect. When the last coat of paint is thoroughly dry, rub it over with wash leather to render it smooth and free from dust and grit. If any patterns or figures are to be left ungolded, they should be lightly pounced over with white to prevent the gold-leaf adhering to them. Another way is to paint them over with the white of egg diluted with water. If any gold sticks to this it can be easily washed or wiped off with a moistened linen cloth. When all is ready for sizing strain sufficient size through muslin, and put some out on the palette, adding to it enough ochre or vermilion, mixed with oil alone, to color. Then with a stiff hog-hair tool commence painting it on the surface, taking care to lay it on smoothly and not too thick, as in the latter case it runs and leaves wrinkles in the gilding. Size always from left to right, beginning on the top of the surface, and working downward. Move the brush lightly and firmly, mapping out the surface to be sized into several squares, and finishing and cross-hatching each before proceeding onwards. If there are patterns to be left ungolded, carefully trace round their outline with a sable pencil, and then fill in the interstices. When the whole surface is covered with size, give it a thorough inspection to make sure there is no faulty portion, and if there is, delicately touch in the size with a small pencil. When very perfect gilding is required it should be sized twice, the first coat being allowed to dry thoroughly before the second is applied. In carved work be careful to dip the brush down into the hollows of the carving. It is a good plan to size over night so as to gild in the morning. But all size does not dry alike, sometimes taking 12 to 24 or 30 hours before it is ready for the gold-leaf, in damp weather or locations always more than in dry. The readiness of the size can only be ascertained by the touch. If on being touched by the finger the surface daubs or comes off it is not ready, but if it feels clammy and sticky it is sufficiently dry. If too dry it must be sized again. The books of gold-leaf should always be placed before a fire half an hour previous to use, in order to dry the

gold and make it more manageable. When all is ready, shake out several leaves upon the gold cushion, and blow them towards the parchment screen. Then carefully raise one leaf with the blade of a knife, and place it on the cushion, gently breathing on it to flatten it out. If it curls up, work it about with the knife-blade until it lies flat. Then replace the knife in its loop under the cushion, and taking the tip pass it lightly over your hair, thus acquiring sufficient greasiness to enable the gold to stick to it. Lay the hairy portion of the tip upon the gold-leaf, and then raising it apply it to the sized surface. As in sizing, work from left to right, and be especially careful to let each leaf overlap slightly, so as to avoid gaps and spaces. Lay on whole leaves as far as the space permits, and then proceed to gild the curves and corners which need smaller pieces. Place a leaf flat and smooth on the cushion, and then taking the knife in the right hand draw the edge easily and evenly along it with a gentle pressure. Divide the leaf into as many pieces as required, and lay on as before. When all the ground is complete inspect it carefully to make sure there are no portions ungilt, however small, and mend them at once. Next take a piece of cotton-wool and gently dab or press the gold down all over, finally brushing off the superfluous pieces either with cotton-wool or a camel's-hair brush. It is a good plan to stipple the gold with a large stiff hog-bristle tool, quite dry and clean, as this gradually softens and removes the marks of joining and other little imperfections. Finally smooth the gold with a clean piece of wash-leather, and it is completed. With regard to gilding with japanner's size the same instructions apply, except as to the time necessary to wait between sizing and gilding. If japanner's size is used pure, it will be ready in from 20 to 30 minutes, but better gilding can be made by mixing one-third oil size with two-thirds of japanner's size. This will be ready in about 2 to 4 hours from the time of putting on. When all the gilding is finished, dilute 1 part of very clean and pure parchment size with 2 parts of water, and brush it over the entire surface of the gold to enrich

and preserve it. If it is necessary to gild in a position much exposed to touch, as the base of a pillar or string-courses, it is as well to give the gold a coat of mastic varnish thinned with turpentine. There are various processes which tend to enrich and vary the effect of gilding. Glazings of transparent colors are sometimes applied for the purpose of deadening its lustre. Raw sienna passed thinly over a sheet of gold gives it a leathery appearance. A good effect may be produced by stencilling a small pattern in umber, sienna, or Indian red over gold, especially if there is foliage or arabesque work upon the gilding, as the small design affords an agreeable relief. This is the easiest mode of gilding; any other metallic leaves can be applied in a similar manner.

American Process of Preserving Wood. The wood, while immersed in a bath of creosote, is subjected to a temperature above the boiling point of water and below 300° F. until all the moisture is expelled. When the water is thus expelled the pores contain only steam; the hot oil is then quickly replaced by a bath of cold oil which condenses steam in the pores, and forms a vacuum into which the oil is forced by atmospheric pressure and capillary attraction. A wooden platform thoroughly creosoted will last twenty to thirty years, and be better than a stone platform during that entire period.

Preparation of Mine-timber. Experiments on a large scale have been made at the *Commentry Coal Mines* in France in regard to mine-timber impregnated with different substances. The experiments were executed at the same time with different varieties of wood, the following table giving the result of all the experiments:

Relative Durability of the Timbers:

Without preparation	1.00
After immersion in the mine-water . . .	1.40
Charred	2.44
Impregnated with tar	7.42
“ “ sulphate of copper	9.77
“ “ sulphate of iron	11.11
“ “ creosote	16.36
“ “ chloride of zinc	34.00

Unprepared oak wood lasted at an average 4½ years, beech wood 2, pine, cherry, and poplar woods 1½, and acacia

wood 6 to 9 months. Of the different varieties of tar, wood tar gave the best results, but its high price prevents its general use. Tar gained from peat gave less favorable results, but better than coal-tar. The French experiments showed that while the durability of oak timber was considerably increased and sometimes doubled by an impregnation with coal-tar, that of pine was but little augmented, it making no difference whether the tar was used in a cold state or heated to 284° F. The use of sulphate of iron gave the following results: 1. While unprepared oak showed signs of decay after 2 years, impregnated with sulphate of iron it lasted 30 years. 2. Immersing the timber for 24 hours in a solution containing 20 parts of sulphate of iron to 100 parts of water gives just as good results as a longer immersion in a stronger solution. 3. The action of a solution of sulphate of iron is just as effective on green as on seasoned wood, and alike on oak and pine woods. The impregnation with sulphate of iron costs about $\frac{1}{3}$ cent per running foot of timber.

The experiments seem to prove conclusively that sulphate of iron is to be preferred for impregnating mine-timber. The apparatus required for preparing 100 pieces of mine-timber daily costs, with all appurtenances, about 1860 francs (\$372).

Shrinking of Wood. It is of importance for every mechanic to know the percentage of shrinkage in wood. In the following table, I. gives the percentage of shrinkage in the direction of the fibres; II. in the direction of the semi-diameter of the trunk, and III. in vertical direction:

	I.	II.	III.
Hornbeam (iron wood)	0.21	6.82	8.00
Beech	0.20	5.25	7.03
Field maple	0.00	2.03	2.97
Elm	0.05	3.85	4.10
Maple	0.11	2.06	4.13
Birch	0.50	3.05	3.19
Oak	0.00	2.65	4.13
Ash	0.26	5.35	6.90
Aspen	0.00	3.97	3.33
Round-leaved willow	0.00	2.07	1.90
Lime	0.10	5.73	7.17
Pine	0.00	2.49	2.87
Pitch pine	0.09	2.08	2.62
Alder	0.30	3.16	4.15

Strength of some American Woods. In view of the frequent use of wooden pins, J. C. Trautwine made experiments by which cylindrical pins $\frac{3}{8}$ inch diameter were sheared off. Each sample was subjected to two tests; where the difference was not more than 10 per cent. the average is given. The principal results were as follows:

Wood.	lbs. per sq. in.	Wood.	lb. per sq. in.
Ash	6280	Maple	6355
Beech	5223	Oak (white)	4425
Birch	5395	“ (live)	8480
Cedar (white)	1445	Pine (white)	2480
“ (Central American)	3410	“ (yellow Northern)	4340
Cherry	2945	Pine (yellow Southern)	5735
Chestnut	1535	Pine (yellow, very resinous)	5053
Dogwood	6510	Poplar	4418
Ebony	7750	Spruce	3255
Gum	5890	Walnut (black)	4728
Hemlock	2750	“ (common)	2830
Hickory	6045		
Locust	7176		

Hard Coating for Wood. To coat wood with a substance as hard as stone mix intimately 40 parts of lime, 50 of resin, and 4 of linseed oil, and add 1 part each of cupric oxide and sulphuric acid. Apply the hot mixture with a brush.

Imitation of Cedar Wood. To give soft, white wood used for turned articles and lead-pencils the appearance of cedar wood the following stain is used: Two hundred parts by weight of catechu, 100 of caustic soda, and 10,000 of water. The finished article is boiled in the stain for a few hours, rinsed, and dried. If not sufficiently deep in color boil for some time longer.

This stain penetrates the wood so deeply that veneers of considerable thickness will be penetrated through and through, so that articles made from it can be afterwards worked further without the original color of the wood making its appearance.

New Glaze for Barrels, Vats, etc. Mix intimately 2 parts of plaster of Paris and 1 part of finely-pulverized asbestos, with sufficient fresh bullocks' blood to form a thick mass, but so that it can be worked with a brush. Apply a uniform coat of this to the dry wood, and after a few hours

give a second coat, to which it is advantageous to add a small quantity of linseed-oil varnish. If necessary to dry the barrel quickly suspend a basin with live coals in it, but the heat should be moderate, and it is preferable to let the barrel stand for a few days in a dry, warm room.

Before use, heat the barrel with steam, and then allow it to dry out. If properly done the layer of glaze will adhere tightly, never show cracks, nor scale off. The glaze on a vat used for 9 months for boiling starch with sulphuric acid was well preserved, and in fact had become somewhat harder.

As the process is very cheap and simple, and the materials are entirely harmless and impart no odor or taste to liquids brought in contact with them, it is especially adapted for breweries, distilleries, starch manufactories, and other industries where wooden vessels are exposed to the action of acids.

New Method of Drying Wood. The following process to dry green wood in 10 to 14 days, without the use of heat, is patented in Germany. The wood is freed from the bark and then imbedded in animal charcoal, bone-black, or peat dust. The moisture in the wood is

10 to 14 days the wood is removed, and, it is claimed, is free from cracks, quite dry, and ready to be worked.

New Paint for Wooden Posts, etc. Fifty parts of rosin, 40 of finely-pulverized chalk, 500 of fine, sharp, white sand, 4 of linseed oil, 1 of native red oxide, and 1 of sulphuric acid.

Heat the rosin, chalk, sand, and linseed oil in an iron boiler, add the red oxide, and then very carefully the sulphuric acid. Mix all thoroughly, and apply the hot mixture to the wood by means of a stiff brush. Should the mixture be too thick dilute with some linseed oil. When cold and dry this paint forms a varnish hard as stone and impermeable to all moisture.

New Process of Preserving Wood. By this process wood is saturated with paraffine, resins, fats, or heavy tar oils by dissolving them in petroleum or benzine instead, as was formerly the case, by heating them to a high temperature. Such solutions penetrate the wood much easier than thickly-fluid substances.

It is best to force the solutions into the wood under pressure, for which the pneumatic methods slightly modified can be used, so that the solvent can be

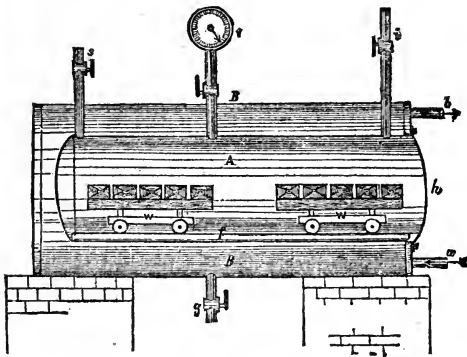

Fig. 54.

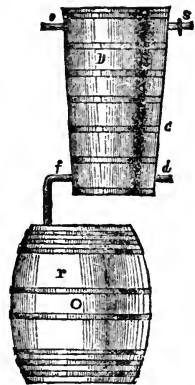

Fig. 55.

eagerly absorbed by these substances. Care must be had to cover the wood completely, as otherwise the places exposed to the air will form cracks. After

regained after impregnating the wood. We give in Figs. 54 and 55 an apparatus by which this object can be attained.

A is the impregnating boiler, BB the

steam-jacket, and *C* the condenser. The boiler is provided on top with the escape-pipe *s* for the vapors to be condensed, the manometer *v* and the pipe *i* for the introduction of the impregnating mixture. The boiler is further provided with a removable cover *h*. In the interior are the rails *f*, upon which the carriage *w* with the ties, etc., is introduced. The steam-jacket is provided with the pipe *a* for the introduction of steam, and the escape-pipe *b*, and on the lower side with a cock for drawing off the condensed water. The cooling vat *D* receives a cooling coil, of which *s* is the receiving and *t* the discharging end. The water runs in through the pipe *d*, and escapes through the pipe *e*. *R* is a vessel placed under *D* for the reception of the regained distillate.

To execute the operation the solution prepared as described further on is forced under pressure into the thoroughly dried wood in the same manner as in the Bethell process. After sufficient impregnation the pressure is shut off, and after connecting the impregnating boiler with the cooling coil, the volatile solvent is distilled off by admitting steam into the steam-jacket, distillation being continued as long as considerable quantities of solvent pass over.

The following mixtures are considered especially well adapted for impregnation: I. Three parts of rosin, 1 part of paraffine, and sufficient benzine to make a thinly-fluid solution. II. Two parts of heavy tar oil, 1 part of paraffine, and benzine sufficient for solution.

The best manner of dissolving the substances is as follows: Melt the paraffine, pour in double the quantity of benzine, and add the pulverized rosin. The solution of the mixture with tar oil is effected in the same manner by first dissolving the tar oil in benzine and then adding the pulverized colophony.

The solution is best effected in a vessel provided with a cover made tight by water-closing and heated by steam. By continuing distillation sufficiently long and having good cooling apparatus, the loss of benzine will be very slight.

It is believed that wood impregnated

in this manner is especially durable in moist places or under water.

Polishing Wax for Wood. Melt over a moderate fire 1 pound of yellow beeswax and $\frac{1}{4}$ pound of rosin, and after removing the vessel from the fire add $\frac{1}{2}$ pound of oil of turpentine. Allow the mixture to cool with constant stirring, and apply it to the wood with a woollen rag, rubbing thoroughly. In a few days the wood will look as though varnished.

Practical Experiments in Producing New Colors upon Wood with known Coloring Matters. The coloring matters used are, according to their nature, either concentrated decoctions or solutions. To produce the desired color the stained wood is treated with the respective chemical agent. The colors obtained are beautiful, fast, and cheap.

Decoction of Logwood Extracts treated with:

	Gives:
Concentrated hydrochloric acid	reddish-yellow.
Diluted hydrochloric acid	reddish.
Concentrated and dilute nitric acid	red.
Concentrated sulphuric acid	black.
Dilute sulphuric acid	red.
Sulphide of hydrogen	yellow-brown.
Ferric nitrate	black.
Potassium chromate	black.
Stannous chloride	violet.
Tartaric acid	gray-brown.
Sulphate of copper	dark gray.
Tannin	yellow-red.
Sal-ammoniac	yellow.
Verdigris	dark brown.
Sugar of lead	gray-brown.
Potash	dark red.
Potassium permanganate	light brown.
Potassium iodide	red-yellow.
Pyrogallic acid	yellow-brown.
Cupric chloride	{ reddish-violet to dark brown.
Chrome-yellow	dark violet.
Sodium	violet.
Sulphate of iron	gray to black.
Alum	{ dark red-brown.
Potassium carbonate	yellow-brown.
Magnesium sulphate	brown.
Cupric nitrate	violet.
Spirit of sal-ammoniac	dark violet.
Ammonium sulphhydrate	violet.
Potassium sulphocyanide	red.
Zinc chloride	red-brown.

Decoction of Fustic Extract treated with:

	Gives:
Concentrated hydrochloric acid	red.

Diluted hydrochloric acid . . .	yellow-brown.
Concentrated nitric acid . . .	{ reddish-yellow.
Diluted nitric acid . . .	brown.
Concentrated sulphuric acid . . .	dark purple.
Diluted sulphuric acid . . .	brown-red.
Spirit of sal-ammoniac . . .	dark yellow.
Ammonium sulphhydrate . . .	dark yellow.
Ferric nitrate . . .	{ dark gray-green.
Tannin . . .	yellow.
Potash . . .	yellow.
Stannous chloride . . .	yellow.
Cupric chloride . . .	yellow.
Tartaric acid . . .	yellow.
Alum . . .	yellow.
Pyrogallic acid . . .	yellow.
Potassium permanganate . . .	{ brownish-yellow.
Cupric sulphate . . .	orange.
Sugar of lead . . .	yellow.

Decoction of Brazil-wood Extract treated with :

	Gives :
Concentrated nitric acid . . .	dark purple.
Diluted nitric acid . . .	pale red.
Concentrated sulphuric acid . . .	red.
Diluted sulphuric acid . . .	purple.
Concentrated hydrochloric acid . . .	dark red.
Diluted hydrochloric acid . . .	light red.
Spirit of sal-ammoniac . . .	dark red.
Ammonium sulphhydrate . . .	dark red.
Sulphide of hydrogen . . .	light red.
Sulphate of iron . . .	dark violet.
Tannin . . .	no change.
Stannous chloride . . .	light red.
Cupric chloride . . .	dark red.
Sal-ammoniac . . .	reddish-yellow.
Sugar of lead . . .	yellowish-red.
Potash . . .	dark crimson.
Tartaric acid . . .	reddish-yellow.

Decoction of Madder treated with :

	Gives :
Diluted hydrochloric, sulphuric, and nitric acid . . .	pale yellow.
Sugar of lead . . .	reddish violet.
Sodium . . .	red.
Tartaric acid . . .	pale yellow.
Tannin . . .	pale yellow.
Potash . . .	light red.
Sal-ammoniac . . .	pale yellow.
Spirit of sal-ammoniac . . .	reddish yellow.
Alum . . .	faint red.
Stannous chloride . . .	light red.

Decoction of Avignon Berries treated with :

	Gives :
Dilute hydrochloric acid . . .	rose color.
Dilute nitric acid . . .	no change.
Dilute sulphuric acid . . .	yellow.
Potash . . .	yellow.
Stannous chloride . . .	dark yellow.
Tartaric acid . . .	discoloration.
Sugar of lead . . .	dark yellow.

Ammonium sulphhydrate . . .	faint yellow.
Potassium bichromate . . .	brown-yellow.
Ferric nitrate . . .	{ dark olive-green.
Potassium iodide . . .	yellow.
Cupric sulphate . . .	{ greenish-yellow.

Decoction of Turmeric treated with :

	Gives :
Hydrochloric, nitric, or sulphuric acid . . .	yellow.
Sulphate of iron . . .	{ greenish-yellow.
Ferric nitrate . . .	{ yellow to dark yellow.
Sugar of lead . . .	yellow.
Alum . . .	yellow.
Potash . . .	red yellow.
Stannous chloride . . .	yellow.
Sodium . . .	yellow.

Preparation of Fire-proof Wood. To render wood incombustible the following mixture is recommended: Soak 27.5 parts by weight of sulphate of zinc, 11 of potash, 22 of alum, and 11 of manganic oxide in lukewarm water in an iron boiler and gradually add 11 parts by weight of 60 per cent. sulphuric acid. The wood to be prepared is placed upon an iron grating in an apparatus of suitable size, care being had to place the separate pieces at least $\frac{1}{2}$ inch apart. The liquid is then poured in the apparatus and the wood allowed to remain completely covered for 3 hours, and is then dried in the air.

YEASTS. MANUFACTURE OF PRESSED YEAST, BAKERS' AND BREWERS' YEAST, ETC.

Schubert's Method of Manufacturing Pressed Yeast. 1. *Mashing in.* Four hundred and ninety-five pounds of crushed rye and 165 pounds of kiln-dried malt are doughed in the preparatory mash-vat with $90\frac{1}{2}$ gallons of water of $133\frac{1}{2}^{\circ}$ to 140° F. Continue mashing until no more lumps can be detected in the dough, and then add 1 pound of pressed yeast dissolved in water. Allow the mash to stand for 20 to 30 minutes, but stirring it several times. Then add $72\frac{1}{2}$ gallons of water of 200° F., and mix it as intimately and quickly as possible with the mash, which thereby acquires a temperature

of about $144\frac{1}{2}^{\circ}$ F., which is the best for saccharization.

2. *Saccharization and Cooling.* After finishing mashing in cover the mash-vat, but stir the mash vigorously every half an hour. Saccharization is complete in 3 hours, and the mash is then slowly cooled in the cooler to 104° F., this promoting top fermentation later on and increasing the yield of yeast.

3. *Setting the Mash.* When the mash is cooled to the proper temperature, 104° F., it is drawn off into the fermenting vat, and set in the following manner: Add gradually $48\frac{1}{2}$ gallons of clarified wash and 95 gallons of cold water to reduce the temperature of the mash to 84° F. Then add to every 100 pounds of crushed grain $8\frac{1}{2}$ ounces of sulphuric acid, previously diluted with water, and $6\frac{1}{2}$ pounds of pure pressed yeast previously set with some mash. The fermenting tun should be large enough to allow of the mash rising without running over. The clarified wash is obtained by mixing wash freshly drawn off with a few bucketsful of cold water to promote cooling and clarification. The barrel in which this is done must be provided with stop-cocks arranged at suitable distances above each other. The wash when clear is gradually drawn off by opening the cocks in succession from above to below.

4. *Scooping off the Yeast and Freeing it from Husks.* Top fermentation begins as soon as the mash is set, and in course of 8 to 12 hours the yeast is sufficiently matured to be ladled off. The yeast is strained through a bag filter, being thereby separated from the husks which remain in the bag. The latter is then thoroughly squeezed out, and the husks poured back into the fermenting vat.

Washing the Yeast. The yeast is brought into the washing-back. This should be higher than wide, and provided with 10 to 12 small discharge cocks one above the other. The yeast is stirred with cold water and then left to settle, after which the water is drawn off through the cocks, fresh water poured in, and this continued until the water running off does not redden blue litmus paper. Two and a quarter to $4\frac{1}{2}$ pounds of potato starch are frequently added to the wash-water.

Pressing the Yeast. The yeast, after washing, is mixed with as much potato starch as desired, and to free it from water is placed in a double bag and pressed with a gradually increasing pressure. It is best to use screw presses.

Moulding the Pressed Yeast. When freed from water the yeast is thoroughly kneaded and formed into pieces weighing 1 pound each. When dry they are packed in paper, then wrapped in linen, and preserved in a cool, airy place.

Vienna Pressed Yeast. The yeast manufactured in Vienna and Moravia possesses excellent qualities. It does not impart a bitter taste or odor to bread or cakes, as is frequently the case with other pressed yeast, the bitter taste being no doubt caused by hops mixed with the yeast. Vienna yeast is manufactured from a mixture of malt, rye, and corn. The grains are crushed and mashed in the usual manner, and the mash set with a ferment and subjected to alcoholic fermentation for 72 hours. A light froth appears first on the surface and then yeast, which is taken off 3 or 4 times. One hundred parts of grain yield 10 parts of yeast.

Zettler's Process of Manufacturing Vienna Pressed Yeast. A mixture in the proportion of $2\frac{1}{2}$ pounds of crushed barley malt to 22 pounds of rye flour is mashed in with 6 times its quantity by weight of water at 140° to $144\frac{1}{2}^{\circ}$ F. When all is thoroughly mixed by continued stirring the mash is allowed to rest for 2 or 3 hours, during which time saccharization is completed. To promote the fermentation of the mash some yeast is added, but this must not be done before the temperature of the mash has fallen to $72\frac{1}{2}^{\circ}$ or $81\frac{1}{2}^{\circ}$ F. Alkaline carbonates and sulphuric acid are sometimes used in place of yeast. To every 100 pounds of flour are generally taken $\frac{1}{2}$ ounce each of potash and sulphuric acid, or $8\frac{1}{2}$ ounces of crystallized sodium carbonate and $3\frac{1}{2}$ ounces of sulphuric acid.

As soon as the froth makes its appearance on the surface it must be removed with ladles. This moment must not be overlooked, as the froth falls back later on and the yeast is then lost.

This froth is the yeast. It is freed from husks by passing it through a hair sieve into a settling vessel into which cold water is poured, and the whole allowed to stand quietly for 8 to 12 hours, during which the yeast settles on the bottom. The yeast is washed once more, then tied in linen bags, and pressed with gradually increasing pressure. After pressing it is formed into suitable cakes and stored in a cool place. It will keep 3 to 4 weeks.

The following directions for preparing *Pressed Yeast* are by Prof. Otto. Mash in a vat of 450 gallons capacity 650 pounds of crushed malt consisting of 2 parts of rye and 1 of barley. The mash, after being thoroughly worked, should have a temperature of 140° to $144\frac{1}{2}^{\circ}$ F. Cover the vat and let the mash rest for $1\frac{1}{4}$ hours, and then cool it to 100° F. by stirring. When the proper temperature has been obtained pour $11\frac{1}{2}$ gallons of the mash into an yeast-vat of 35.3 to 37 gallons capacity; then add $7\frac{3}{4}$ pounds of good pressed yeast dissolved in $1\frac{3}{4}$ gallons of lukewarm water, $\frac{1}{2}$ pint of beer yeast, and, after stirring, $1\frac{3}{4}$ pounds of sulphuric acid diluted with 1 to $1\frac{1}{2}$ gallons of water. If the temperature of the mixture should be below 88° F. add sufficient hot water to bring it up to that temperature, or cool it by stirring if above that degree. Then cover the vessel and fermentation will begin in about $\frac{1}{4}$ hour.

The remainder of the mash is in the meanwhile cooled off to $81\frac{1}{2}^{\circ}$ F. by adding water, and is then brought into the fermenting vat. Then, when the yeast in the yeast-vat begins to ferment, add it to the mash in the fermenting vat, agitate thoroughly, and add $1\frac{3}{4}$ pounds more of sulphuric acid diluted with $1\frac{1}{2}$ gallons of water. Stir the mash until it shows a temperature of $73\frac{1}{2}^{\circ}$ to 77° F. Cover the fermenting vat in winter. Skimming off the yeast may be commenced after 10 to 12 hours and be continued 6 to 8 hours. Pour the skimmings into bags of medium-fine bolting-cloth, press the milky yeast through, and pour the remainder back into the fermenting vat. The filtered yeast is transferred to a vat of about 300 gallons capacity filled half with water; stir the mixture thoroughly and then

let it rest 6 to 8 hours. Then draw off the supernatant fluid into the fermenting vat, pour fresh cold water over the yeast, add $4\frac{1}{2}$ ounces of sulphuric acid, and thoroughly agitate the mixture. Let it settle 10 to 12 hours and then draw off the supernatant fluid, which may be used in cooling off the next mash. The yeast is mixed with $28\frac{1}{2}$ to 33 pounds of potato starch, then brought into double bags and carefully pressed. Scrupulous cleanliness must be observed throughout the whole operation. The mash and fermenting vats must be frequently whitewashed, as also the washing vat. The press bags must be washed in hot water and then thoroughly dried.

Pressed Yeast from Potatoes. The potatoes are boiled to a thin paste in water mixed with sulphuric acid. For 220 pounds of potatoes, with an average of 17.5 to 18 per cent. of starch, 8 gallons of water and 2 ounces of sulphuric acid are required. The potato-paste is then brought into the preparatory mash-vat, mixed with 40 to 50 pounds of a mixture of malt and rye to every 220 pounds of potatoes, and converted into pressed yeast-mash at a temperature of $136\frac{1}{2}^{\circ}$ to 140° F. The washing and elutriating of the yeast is done in the usual manner, but only for 30 to 40 minutes, instead of 6 to 8 hours.

American Dry Yeast. Mix $3\frac{1}{2}$ ounces of hops with 15 quarts of hot water and $3\frac{3}{4}$ pounds of rye flour. When the mixture is cooled off to lukewarm, add $\frac{1}{2}$ pint of beer-yeast, and allow the mass to ferment. The next day add $7\frac{3}{4}$ pounds of corn or barley meal, knead the mass into a stiff dough, and form this into a cake about $\frac{1}{2}$ inch thick. Divide this with a glass knife into small pieces and dry them completely in a warm room, or in the sun, turning them frequently. This yeast can be kept in well-closed pots for an indefinite time. For use, break off the required quantity, soak it in warm water, let it stand for 12 hours in a warm place, and then use it like ordinary yeast.

Artificial Yeast. Mix 2 parts by weight of the fine flour of pale barley malt with 1 part of wheat flour. Stir 55 pounds of this mixture gradually into 33 gallons of water with a wooden spatula until it forms a smooth paste.

Place this in a copper boiler over a slow fire, stir it well until the temperature rises to 149° to 158° F., when a partial formation of sugar will take place, but this sweetening must not progress too far. Then turn out the thin paste into a flat cooler and stir it from time to time. As soon as the temperature of the paste has fallen to 59° F. transfer it to a tub or vat, and add to every 15 gallons of the paste 1 quart of beer-yeast, which will throw the mass into brisk fermentation in the course of 12 hours. This preparation is a good yeast for bakers' and brewers' use, and will continue fresh and active for 3 days. It should be occasionally stirred.

Cramer's Process of Preparing Pressed Yeast from Beer-yeast. 1. Press the raw beer-yeast in a bag of fine silk bolting-cloth under water, whereby even the finest constituents, mechanically mixed with the yeast, will remain in the bag. 2. As soon as a sufficient quantity of yeast is purified in this manner transfer it to the washing vat and add three times its quantity of water. Then dissolve $\frac{1}{4}$ to $\frac{1}{2}$ ounce of carbonate of ammonium in water to every quart of beer-yeast, and mix the solution with the yeast in the washing vat. The yeast soon separates as a white sediment on the bottom of the vat, while the hop-resin giving the bitter taste to the yeast remains dissolved in the water, which is then poured off. The white yeast remaining behind is now free from all bitter substances, but is not vigorous enough for the promotion of fermentation, and must therefore be subjected to a regenerating process. 3. *Regeneration of the Yeast.* Mash in crushed air-dry barley malt with cold water, heat the mash to 149° to 158° F., add $\frac{1}{2}$ ounce of tartaric acid to every 15 gallons of the mash, and let it stand in a room the temperature of which should not be below 72 $\frac{1}{2}$ ° F. for 24 hours, during which time the formation of sugar and acid takes place. Then free the mash from the grains by passing it through a fine hair-sieve, and add a half gallon of it to every quart of yeast to be regenerated. The temperature of the mixture should be 77° F. The mass will soon be thrown into vigorous fermentation, the revived yeast rising partly to the surface, from

which it is removed, and settling partly on the bottom. Fermentation ceases in about 36 to 48 hours; the fluid is then drawn off from the vat and the bottom yeast is mixed with the top yeast and both placed under water, and then pressed through double linen bags. The pressed yeast thus obtained is white, has no bitter taste, is very vigorous and durable.

Improvements in Treating Yeast. Brewers frequently suffer serious losses by the spoiling of the yeast in warm weather. The cause of the spoiling of the yeast must be sought, 1, in its porosity, as it is generally in a half liquid state, containing innumerable bubbles of carbonic acid which escape constantly, giving the oxygen of the air free access to all parts of the yeast, and, 2, in the rapid development of acid in the yeast, turning it sour and rendering it unfit for brewers' use.

These evils may be overcome by the following treatment: Add three times the volume of the yeast of water of as low a temperature as possible to the vessels containing the yeast. Mix the yeast and water by stirring thoroughly, and then allow the yeast to settle for 24 hours. Then pour off the water, add half the quantity of fresh water, stir again, and add gradually milk of lime, a solution of soda or other alkali, until the fluid reacts only slightly acid. Then add to every 100 pounds of yeast about 1 $\frac{1}{2}$ ounces of salicylic acid. Allow the yeast to settle, and do not remove the supernatant fluid until the yeast is to be used. After drawing off the fluid add to every 100 pounds of yeast 10 pounds of a mixture of equal quantities of malt flour or wheat flour and sugar, and mix it thoroughly with the yeast. The yeast quickly absorbs this compound containing sugar and starch, which is at once recognized by an abundant development of carbonic acid. To render the yeast very active 8 ounces of a soluble phosphate may be added to every 200 pounds of yeast.

Pressed Yeast from Beer-yeast. The following process gives, according to *Pfauth*, a pure and white yeast. Strain the yeast through a very fine filter in order to remove all larger resinous particles, and then stir it up with three times its quantity of cold water in a vat

of suitable size and provided with cocks arranged at suitable distances one above the other. Allow the mixture to stand for 10 minutes for the yeast to settle, draw off the supernatant fluid, and repeat the washing twice. To the first wash-water add 1½ ounces of bicarbonate of sodium to every 15 gallons of yeast, to the second ½ ounce of tartaric acid to the same quantity of yeast, and to

the third water 1 ounce of carbonate of ammonium. After the last water has been drawn off the yeast is pressed into cakes. Some kinds of yeast settle with difficulty. In such cases, ice-cold water in larger quantities may be employed, or in lieu of this a little alum may be added to the first water, which must, however, be completely removed by washing.

ADDENDA.

ALLOYS.

Alloy of Copper, Platinum, and Palladium. An excellent alloy of these three metals is made by melting for 3 hours 8 parts by weight of copper and 1 part of platinum with a pinch of borax. Then add 1 part of palladium and retain the crucible over a bright flame until the metals melt and amalgamate.

Alloys Resembling Silver. In the following we give the composition of a few new alloys having the appearance of silver:

Minargent: Copper 100, nickel 70, tungstate of iron 5, aluminium 1.

Warne Metal: Tin 10, nickel 7, bismuth 7, cobalt 3.

Trabak Metal: Tin 87.5, nickel 5.5, antimony 5, bismuth 2.

Manganese Alloys. A good effect, as is well known, is produced by the use of manganese as an addition to bronze, brass, German silver, red copper, etc. All red copper and bronzes found in commerce contain more or less oxide, which injures their tenacity and malleability. The removal of the oxide is effected by substances having a greater affinity for oxygen than copper; for instance, by the addition of phosphorus in the form of a tin or copper phosphide, as in the preparation of phosphor-bronze. Manganese, however, acts more energetically. An alloy of copper and manganese—cupro-manganese—composed of 70.50 parts of copper, 25 parts of manganese,

and ½ part of charcoal, is well adapted for the purpose. An addition of at the utmost 2½ per cent. is sufficient, and the process is quite simple.

After melting the bronze masses the metal bath is covered with pulverized charcoal and the pieces of cupro-manganese, previously weighed and comminuted, are allowed to slide slowly into the crucible; the melting together takes place immediately. The crucible must, however, be replaced upon the fire for a few minutes to restore the temperature lowered by the addition of the cold pieces of metal. Pouring out is done in the usual manner.

To scoriify the manganic oxide formed during the process add to the charcoal, with which the metal bath is covered, about one-half the quantity of pure sodium carbonate or potassium carbonate.

The following alloys are prepared according to this process:

	PARTS.					
	Tin.	Zinc.	Lead.	Cupro-manganese.	Copper.	Antimony.
1.	16	3½	3½	1		
2.	16	3	3	2		
3. Red brass.	14	1	85	
or . . .	17	2	81	
4. White brass	42	...	40	2	...	16
or . . .	20	...	58	2	...	20

A composition of 70 per cent. of copper and 30 per cent. of manganese is used as an addition to a large number of alloys, especially for red brass, white brass, and bronze. By this addition the alloys acquire greater density, solidity, and ductility. A copper and tin alloy with 6 per cent. of manganese possesses the hardness of steel.

We give in the following a few compositions which can be highly recommended:

	PARTS.					
	Copper.	Tin.	Zinc.	Lead.	Antimony.	Cupro-manganese.
For brasses . . .	80	6	5	9
" rollers . . .	8	64	...	10	16	2
" malleable brass . . .	56½	42	1½

Manganese alloys can be polished, and their color is from white to rose color.

In refining copper, cupro-manganese is used to reduce the cuprous oxide, playing a part corresponding to that of ferro-manganese in the manufacture of steel. Manganese silver composed of 80 per cent. of copper, 15 per cent. of manganese, and 5 per cent. of zinc is white, takes a good polish, and is easily worked.

New Alloy for Silvering. This new alloy consists of 80 parts of tin, 18 of lead, and 2 of silver; or, 90 parts of tin, 9 of lead, and 1 of silver.

Melt the tin, and when the bath is lustrous white add the granulated lead and stir the mixture with a pine stick; then add the silver and stir again. Increase the fire for a short time until the surface of the bath assumes a light yellow color, then stir thoroughly and cast the alloy into bars. The operation of silvering is executed as follows:

The article—for instance, a knife blade—is dipped in a solution of hydrochloric or sulphuric acid, rinsed in clean water, dried, rubbed dry with a piece of soft leather or dry sponge, and

then exposed in a muffle 5 minutes to a temperature of 158° to 176° F. The effect of this treatment is to render the surface of the iron or steel porous. With iron, not very good and coarsely porous, the silvering process is difficult to execute. With steel, however, the process is easy; the article heated to about 140° F. is dipped in the alloy, melted in a crucible over a moderate fire. The bath, which must be completely liquid, is stirred with a pine or poplar stick. The surface of the bath should show a fine silver white color. One to 2 minutes dipping suffices for a knife blade. When taken from the bath, the article is dipped in cold water, or, if necessary, hardened and tempered in the usual manner. It is then rubbed dry, and polished without heating.

Articles thus treated have the appearance of silver, and also possess the sound of silver, and resist oxidation in the air. To protect them from the action of acid liquids they are first dipped in an amalgam bath of 69 parts of mercury, 39 parts of tin, and 1 of silver; then, while hot, in melted silver, and electroplated with silver. This method of silvering is claimed to be very durable and not costly.

Aluminium Bronze. Several alloys are known by this designation. By far the most useful and valuable is that composed of copper 90 per cent. and aluminium 10 per cent. It has a golden-yellow color, is very dense, and homogeneous. It may be worked hot or cold, though it is difficult to weld. It possesses great tensile strength, often as high as 100,000 pounds to the square inch, and is remarkably ductile and malleable. Its stiffness is 3 times that of gun bronze and 44 times that of brass. It can be cast very well and works well under the tool. It is generally acknowledged to be of all the bronzes decidedly the best. Recent improvements in the metallurgical treatment of aluminium promise to considerably lessen its cost, which, up to the present time, has stood in the way of its extensive use in the arts. (W.)

Phosphor Bronze, which is largely used as a substitute for bronze and gun-metal compositions, for gearing, bear-

ings, wire rope, etc., etc., is an alloy of copper and tin which has been fluxed by the introduction of a variable quantity of phosphorus, which is generally added in the form of phosphide of copper or phosphide of tin. This addition prevents the formation of oxide by which the strength, ductility, and homogeneity of the resulting alloy would be impaired, and furnishes a metal which in respect to these qualities is notably superior to ordinary bronze. Numerous grades of phosphor-bronze are made according to the uses for which it is intended. (W.)

Manganese Bronze. This alloy is much used in England. It is formed by fusion of copper, tin, and manganese. Its color is usually white, and when very rich in copper tinged rose color. The addition of manganese to copper-tin alloys imparts to them greater strength, ductility, and homogeneity, resembling in this respect the influence of phosphorus. Thurston speaks very highly of this alloy as a material of construction. It is remarkably hard, tough, and elastic, as compared with ordinary bronze, and very durable when used for bearings of machinery. An average composition would have the proportions: Copper 88 per cent., tin 10 per cent., manganese 2 per cent. (W.)

Density of Alloys. This is frequently greater or less than the mean density of their constituent metals. In the following is given a list of alloys exhibiting such abnormal densities:

1. *Alloys exhibiting greater Density than the Mean of their Constituents:*

Gold and zinc.	Copper and zinc.
Gold and tin.	Copper and tin.
Gold and bismuth.	Copper and palladium.
Gold and antimony.	Copper and bismuth.
Gold and cobalt.	Lead and antimony.
Silver and zinc.	Platinum and molybdenum.
Silver and bismuth.	Palladium and bismuth.
Silver and tin.	
Silver and antimony.	

2. *Alloys exhibiting less Density than the Mean of their Constituents:*

Gold and silver.	Iron and bismuth.
Gold and iron.	Iron and antimony.
Gold and copper.	Iron and lead.
Gold and lead.	Tin and lead.
Gold and iridium.	Tin and palladium.
Gold and nickel.	Nickel and arsenic.
Silver and copper.	Zinc and antimony.

(W.)

Fusibility of Alloys. In nearly all cases the fusibility of alloys is lower than the mean fusing point of their constituent metals. In some cases, as in that of the so-called fusible metals, the point of fusion is lower than that of either of their constituents. (W.)

Spence's Metal. This compound has lately attracted considerable attention. It is an English invention, and is named after the inventor. Strictly speaking it is not a metal, but a compound obtained by dissolving metallic sulphides in molten sulphur, which is found to be capable of receiving into solution nearly all the sulphides of the metals. For most purposes Mr. Spence employs in the production of his "metal" the sulphides of iron, lead, and zinc, in varying proportions according to the quality of the product desired, which will depend on the uses for which it is designed. On cooling the mixture solidifies, forming a homogeneous, tenacious mass, having ordinarily a specific gravity of 3.37 to 3.7. It is said to be exceedingly useful in the laboratory for making the airtight connections between glass tubes by means of caoutchouc, and a water or mercury jacket, where rigidity is no disadvantage. The fusing point is so low that it may be run into the outer tube on to the caoutchouc, which it grips, on cooling, like a vise, and makes it perfectly tight. It melts at 320° F., expands on cooling, is claimed to be capable of resisting well the disintegrating action of the atmosphere, is attacked by but few acids, and by them but slowly; or by alkalies; is insoluble in water, and may receive a high polish; it makes clean, full castings, taking very perfect impressions; it is cheap, and easily worked. It has been used as a solder for gas-pipes, and as a joint material in place of lead. (W.)

ANTISEPTIC AND PRESERVATIVE AGENTS.

Boroglyceride. This compound, which is patented in this country under the name of "Barff's Preserving Compound," is obtained by heating 92 parts of pure glycerine to 302° F. and gradually adding 62 parts of finely-pulver-

*Receipts for Metal-workers proved in Practice :**a. Metal for Brasses.*

	Copper.	Zinc.	Tin.
For locomotive axles	86	14	
“ “ “ “	82	8	10
“ axles of railway carriages	82	18	
“ “ “ “	84	16	
“ “ “ “	75	2	20
“ various kinds of axles	73.7	2.1	14.2
“ “ “ “ “ (medium hard)	69.55	5.88	21.77
“ “ “ “ “ (hard)	82	2	16
“ “ “ “ “ (very hard)	88.8	11.2	

b. Machinery Metal for Various Purposes.

	Copper.	Zinc.	Tin.	Lead.
For cogwheels	91.3	8.7		
“ punches	83.3	16.7		
“ steam-whistles	80	2	17	
“ “ “ “	81	2	16	
“ cocks	88	2	10	
“ wagon-wheel boxes	87.7	2.6	9.7	
“ stuffing-boxes	86.2	3.6	10.2	
“ mechanical instruments	81.2	5.1	12.8	
“ files	64.4	10	17.6	8.6
“ “ “ “	61.5	7.7	30.8	
“ weights	90	2	8	
“ castings (for gilding)	79.1	7.8	13.1	
“ “ “ “	77.2	7	15.8	
“ piston rings	84	8.3	2.9	4.3
“ buttons (white)	57.9	36.8	5.3	
“ sheets (for pressed articles)	63.88	30.55	5.55	
“ small cast articles	94.12	5.88	
“ “ “ “	90	10		

ized boracic acid ; water vapor escapes during the operation. The manipulation of about 6 pounds requires an entire day, as on account of the viscosity of the melted mass it is difficult for the water vapor to escape. The process is completed when no more loss of weight takes place, and the preparation dissolves readily in water of ordinary temperature. The escaping water amounts to somewhat more than $\frac{1}{3}$ of the substances used.

Boroglyceride, when cold, is solid, brittle, and transparent, of a light yellow color and lustrous fracture.

It is readily soluble in water, only slightly soluble in cold alcohol and in 5 parts of alcohol at 122° F., and insoluble in ether and chloroform at ordinary temperature. A hot alcoholic solution might be well adapted for im-

pregnating cotton for surgical purposes with boroglyceride. It is an excellent agent for preserving milk, fruits, meat, anatomical preparations, etc.

Calcium and Sodium Glyceroborates, Two New Antiseptics. Both are readily soluble, odorless, and non-poisonous. Calcium glyceroborate is obtained by heating together equal parts by weight of calcium borate and glycerine with constant agitation, until a drop taken from the vessel and placed upon a glass plate solidifies to a clear colorless pearl. The compound is then poured upon a metal plate where it solidifies to a transparent, glassy, and very brittle mass. The pieces, still hot, are kept in a well-stoppered bottle. Sodium glyceroborate is obtained in the same manner by heating together 100 parts of anhydrous

borax and 150 parts of glycerine. These compounds possess analogous properties; they melt at about 302° F. and are very hygroscopic. They deliquesce very rapidly when exposed to the air, absorbing their own weight of water. They dissolve in half their weight of alcohol or water. Both are powerful antiseptics even in a very diluted state. They deserve preference to carbolic acid on account of being soluble in water in all proportions and producing no effect injurious to health. They can be applied without inconvenience even to such a sensitive organ as the eye. Meat simply covered with a glaze of glyceroborate was sent to La Plata and arrived in a perfectly fresh condition. From a therapeutical point of view the sodium compound would seem to be preferable, though they are both pre-eminently adapted for preserving provisions, etc. In surgery they may be used in place of phenol.

Effective Power of different Antiseptic Agents. To test the antiseptic power of different agents Miguel has made experiments and calculated the smallest quantity required to prevent putrefaction in neutralized bouillon, as follows:

Mercuric iodide	0.025 per cent.
Corrosive sublimate	0.070 "
Chromic acid	0.20 "
Chlorine	0.25 "
Iodine	0.25 "
Brome	0.60 "
Iodoform	0.60 "
Chloroform	0.80 "
Sulphate of copper	0.90 "
Carbolic acid	3.0 "
Tannin	4.80 "
Arsenious acid	6.0 "
Boric acid	7.50 "
Chloral hydrate	9.30 "
Salicylic acid	10.0 "
Sulphate of iron	11.00 "
Amyl alcohol	14.00 "
Ether	22.00 "
Alcohol	95.00 "
Common salt	165.00 "
Glycerine	200.00 "

It will be seen from the above that the mercury combinations possess the greatest antiseptic power.

New Iron Fruit-drying Apparatus. The fruit is placed upon the movable hurdles *h h h h*, which are protected from catching fire by layers of ashes and the air-flue *L*. Cold air is sucked

into the air-flue *L*, which is provided with heating pipes, through the openings *r*, and after being heated passes through the opening *s* into the drying-

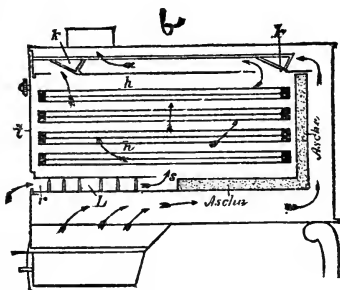

Fig. 56.

room *a b*, where it absorbs the moisture escaping from the fruit, and passes through the dampers *k k* into the chimney. The dampers *k k* are opened by shutting the door *t*, and closed on opening it.

New Process of Greening Canned Vegetables. For Peas. Nine gallons of peas, bleached in the ordinary manner, are poured into a vessel containing 18 gallons of boiling water. They are then washed in cold water, dried, and put in the cans, which are filled with the following liquor: Prepare a solution of white sugar with common salt and ordinary water and add 20 per cent. of milk of lime. After stirring, add 1½ pints of the following solution: Ten to 25 ounces of soda-lye of 40° B., and 3½ to 6½ ounces of crystallized sodium sulphide, dissolved in 1 pound of water. The tin cans are filled as full as possible and subjected to boiling in an ordinary digester for 10 to 15 minutes, according to the size of the peas.

For Beans the cans are filled with the following liquor: Clear lime-water 22 gallons, common salt 2 to 6 pounds, and 1 or 2 drachms of sodium sulphide. The cans are boiled 6 to 8 minutes at a temperature of 223° to 230° F.

It will be seen that the substances used are entirely harmless, especially in such small quantities.

Novelties in preserving Organic Sub-

stances, and Apparatus used. The glass or other vessels containing the fruits, etc., to be preserved, are placed upon the carriage *m*, which is pushed upon the track *i* into the air and steam-tight box *a*. A rail-bridge is connected

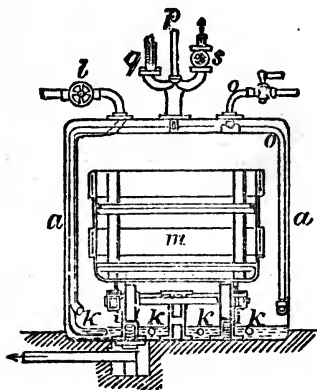
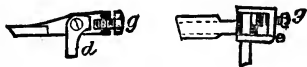

Fig. 57.

by means of a hinge joint with the track, so that, after closing the box, it can be turned up. The door is pressed against the box *a* by the joint hinge *d*, provided with a longitudinal slit, the strap *e*, and the pressing screw *g*. In



Figs. 58, 59.

using the apparatus, water covering the serpentine pipe *k* to a height regulated by an overflow funnel is introduced through the pipe *o* and its perforated continuation. The steam, which is introduced into the serpentine pipe *k* by opening the valve *l*, heats the layer of water, and the steam arising from it, the glass vessels. Should the heat become too great cold water is introduced through the pipe *o*. A valve *q* opening to the inside is placed alongside the thermometer *p*. The steam escapes through the valve *s*.

Preparation, free from Arsenic, for Preserving Animal Skins. Boil until reduced one-half, 125 parts of colocynths and 25 of aloes in 1500 of water, and strain while hot. Then stir 500 parts of brown resin soap in 250 of soft soap with some water to a paste over a moderate fire, and mix it carefully with the first decoction, and 125 parts of glycerine and 40 of rape-seed oil over a moderate fire. After thorough mixing stir into the whole 50 parts of powdered naphthaline rubbed up with 35 parts of oil of turpentine and 80 of carbolic acid, kept liquid by a sufficient addition of alcohol. The mass should be homogeneous; if too thick, thin with oil of turpentine.

Preservative Picking-paper to protect Cloth, Furs, etc., from Moths. Paper manufactured from woollen rags and manilla threads or paper is saturated with a mixture of 70 parts by measure of oil obtained as residue in the distillation with energetic steam of coal tar naphtha, 5 parts of crude carbolic acid containing at least 50 per cent. of phenol, 20 parts of thin coal tar heated to about 160° F., and 5 parts of refined petroleum. After saturation the paper is passed through pressing machines and over hot rolls to dry it, and when sufficiently cooled is cut into leaves of suitable size and completely dried in the open air.

ARTIFICIAL EYES, MANUFACTURE OF.

A wax model of the cornea, fitting accurately into the orbital cavity of the person who is to wear the artificial eye, is placed in plaster of Paris paste. When hardened the wax model is taken out, the pupil removed from it, and after coating with caoutchouc solution replaced in its cavity in the plaster of Paris mould. The concave bottom of the mould is then entirely covered with caoutchouc and vulcanized.

The eye thus prepared is placed in alcohol and exposed to the sun, whereby the color of the artificial cornea becomes like that of the natural one. The pupil consists of glass or enamel, the cornea of 2 parts each of oxide of zinc and caoutchouc, and 1 part of sulphur. The red caoutchouc used for

imitating the blood veins of the cornea consists of a mixture of 2 parts each of caoutchouc and cinnabar and 1 part of sulphur.

ASBESTOS AND ITS USES.

Asbestos Industry in England. Italian asbestos is principally used. Immense deposits are also found in other countries, especially in Canada, but the fibre of the Canadian variety is short and has not the snowy whiteness of the Italian.

For manufacturing purposes the asbestos is separated into two kinds, the first to be used for making paper and the second for textile fabrics. For the manufacture of asbestos paper large quantities of water are required, and for this reason the large establishments at Harefield, the most important place of the English asbestos industry, are located close to the canal.

The separation of the asbestos is effected in the following manner: The fibres are disaggregated with a machine consisting of two rollers with three-cornered teeth. The rollers have a revolving and backward and forward motion, so that disaggregation is effected without destroying the parallelism of the fibres.

Three machines differing only in size are used for the operation. The disaggregated asbestos is placed in vats provided with stirring apparatus and boiled with constant agitation and occasional lifting out and replacing. After boiling the water is partially removed by mechanical means, and the asbestos dried in chambers heated by steam. The long fibres are then separated from the short ones by a special machine. The short fibres are converted into pulp and made in the usual manner into paper and pasteboard. Leaves of asbestos paper are generally 40 inches square and $\frac{3}{8}$ to $\frac{1}{4}$ inch thick. Asbestos board, which is principally used for fire-proof lining and for steam-joints, is also used for other purposes as it does not cause a chemical alteration of metal.

The manufacture of asbestos tissue is much more difficult than that of paper, as the fibre neither crimps nor felts.

The fibre is first carded upon machines similar to carding engines used in the wool industry. Upon the last carding engine, technically known as "condenser," the mass of fibres is divided into separate strands. Each of these strands passes between two hoses moving in the same direction, which form the strand into a single thread, not by torsion, as in the textile industry, but by rolling it together somewhat like putty is rolled between the fingers.

The other operations, doubling the threads and weaving, are comparatively simple. In doubling a number of threads are joined and twisted together like a rope. The thread thus obtained serves as the chain in making the fabric. The weaving is done upon ordinary looms.

Asbestos cloth is chiefly used for filtering in chemical works, for theatre curtains, aprons and trousers for stokers, clothing and gloves for firemen, lining for fire-proof safes, etc. In the United States there is quite an extensive industry in asbestos products, much of which are produced from native material. Asbestos fibre twisted into rope is largely used for steam-packing; asbestos millboard is used largely for gaskets, pipe and boiler covering, fire-proof linings, etc.; asbestos pulp for the last-named purposes and ground asbestos for paint body. (W.)

BLEACHING.

Bleaching of Fabrics and Yarns without Chlorine. The article to be bleached is soaked in an iron or wooden vat, or, if great purity is demanded, boiled with an addition of $3\frac{1}{2}$ pounds of caustic soda to 100 pounds of material for 12 hours. After this operation the material is placed in a warm concentrated bath of permanganate of potassium for 15 to 30 minutes, and after cooling brought into a bath of borax and sulphurous acid for 15 to 30 minutes. The materials thus prepared are then treated with a preparation formed by the action of gaseous sulphurous acid upon crystallized borax. To prepare this borax-bath dissolve 2 pounds 3 ounces of borax in 22 gallons of cold water previously saturated

with gaseous sulphurous acid. The bleaching effect produced by this combination must be explained by the simultaneous action of the borax and sulphurous acid, since, when used one after the other, the result is quite different. After washing and drying the materials thus treated are brilliantly white.

Bleaching Yarns and Fabrics. Linen yarns and fabrics are boiled for 3 hours in a solution containing 37 grains of potassium cyanide in $1\frac{1}{2}$ pints of water, then washed, and treated again in the same manner. For cotton this operation may be omitted unless the material has been brought in contact with fatty or oily substances, in which case the above solution is used in a more dilute form (about half the strength). The fabric thus prepared is placed in closed vessels and treated with a solution of $81\frac{1}{2}$ grains of chloride of lime in $1\frac{1}{2}$ pints of water. As soon as the vessel is full the solution is drawn off and carbonic anhydride passed in. This operation is repeated until the fabric assumes the desired degree of whiteness. It is then taken out, washed in water, and pressed. In most cases a slight yellow tinge is retained within the fabric, owing to the presence of traces of iron in the bleaching agent. To remove this coloration the fabric is drawn through a bath of oxalic acid (about 70 grains per gallon), washed with water, pressed and toned with indigo or aniline violet.

Novelties in Bleaching. Before bleaching wool with hydrogen peroxide it must be washed thoroughly clean. An immersion of 30 to 40 minutes in a bath of commercial hydrogen peroxide diluted with 10 parts of water suffices to bleach the wool. With a dilution of 15 parts of water about 1 hour is required. A capacious vat should be used to allow of the wool being easily moved, as this accelerates the bleaching process.

As long as the wool, after being taken from the bleaching bath, is moist and exposed to the air, the bleaching process goes on, and it is therefore advisable not to hasten drying. The best results are obtained by drying in the sun; if this cannot be done a moderate temperature should be kept in the

drying-room. In working with diluted bleaching water, the small quantity of indigo required for the production of a pure white can be directly added to the bleaching bath. By using a concentrated bath the toning must, however, be done in a separate bath. For very yellow wool add a few drops of dissolved methyl violet to the bath, which prevent the white from acquiring a greenish tint.

BOOKBINDING, GILDING, AND ORNAMENTS.

Folding. The sheets are folded in leaves, according to the form of the book, viz.: Two leaves for folios, four for quartos, eight for octavos, twelve for duodecimos, etc., and are marked with what printers call *signatures* to guide the folder. The folding-sticks are made of wood, bone, or ivory, and the folding generally done by women.

Rolling. After being folded the sheets are made smooth and compact either by being beaten with a hammer weighing 12 to 14 pounds, or passed through a rolling-press consisting of two smooth horizontal rollers placed a small distance apart.

Sewing. The sheets forming one volume are fixed in a cutting-press and saw-cuts made across the back edge to receive the bands or cords to which the sheets are to be sewed, and which aid in fastening the covers. After this preparation they are placed in a sewing-press, consisting of two vertical wooden screws fastened on a table or board and joined at their top by a horizontal bar from which cords are stretched vertically to the table or board, and held tight by nuts on the cross-bar. The sheets are laid singly on top of each other, the saw-grooves fitting to the cords, and each sheet is sewed fast by passing the needle in and out through the sheet and around the cords.

Rounding. The back of the book is now glued, and the ends of the bands are opened and scraped with a knife that they may be more conveniently fixed to the pasteboard covers. By a dextrous application of a hammer and the fingers the back, while still moist with glue, is made round or convex,

and the front edge hollow or concave, the book being fixed in a press between boards called backing-boards, in order to make a groove for receiving the covers.

Edge-cutting or trimming is next done in a cutting-press with a very sharp blade working vertically. The concave edge is temporarily made flat by the press during the cutting, but it springs back to its proper concavity afterwards.

Binding. The covers of books are mostly made of what is technically called "*binders' board*," cut to the proper sizes and shapes from large sheets. Holes are pierced through the boards corresponding to the cords in the back of the sheets, which are passed through and fastened.

Covering. The covering is done by pasting leather, muslin, or other material on the board, and requires considerable skill. The hollow back of a book is produced by the interposition of paper or cloth between the edge and the leather in a way that enables the book to be opened without crinkling the back.

Tooling and Lettering. Numerous tools are employed in a heated state and pressed heavily against the covers. If no gold is used the tool makes a dark, glossy impression, which is called "*blind tooling*," but in *gold tooling* leaf-gold is applied before the tools are used. The cover is first washed with clear gum water. The parts to be gilded are then coated twice with white of egg beaten into a froth, and then allowed to subside into a clear liquid. To gild, spread a leaf of gold on the gilding-cushion with a knife, and blow it flat, then cut it into strips about $\frac{1}{2}$ inch wide. Heat the tool until it is just hot enough to fizz under the wet finger; if it sputters it is too hot and will burn the leather; touch its edge with a rag slightly moistened with sweet oil, and with the same rag rub over the part of the book to be gilt. Roll the tool softly on the strips of gold, which will adhere to it, and when enough is taken up roll it with a heavier pressure along the places to be gilt, and the gold will be transferred to the leather, the excess being wiped away with a soft rag.

Edge Gilding. The top, bottom, and front edges are scraped smooth with a piece of steel, and are then coated with a composition of red chalk and water; this is wetted with white of egg and water; the leaf-gold is laid on, and soon afterwards is brilliantly polished by rubbing with a burnisher of agate or blood-stone.

For Plain Edges. Screw the book tight into the press between boards and rub the edges vigorously with an agate or a dog's tooth.

Marbling is done by sprinkling the colors on the edges of the leaves with a brush made of hogs' bristles, the brush being held in the one hand and the bristles moved with the other.

Another plan is to tightly stretch either plain or figured mull in a wooden frame and place the edge of the book upon it, to quickly draw the brush over the mull or sprinkle the color in the above manner, whereby the places protected by the threads of the mull remain white.

Reichardt's Rosin Compound for Gilding Paper, Leather, etc. Pulverize and mix 4 to 5 parts of copal and 1 of mastic, and apply the powder with a fine camel's-hair brush to the place to be gilt.

Reber's Process of Gilding Leather. Prepare parchment glue and white of egg of the best quality.

Parchment Glue. Dissolve 1 part by weight of hogskin parchment shavings (but not those of sheepskin parchment), and boil the solution to half its volume.

White of Egg. In place of diluting the white of egg with water, as most bookbinders do, add 3 drops of spirit of sal-ammoniac to each white of egg before beating it to a froth.

The manner of gilding the different kinds of leather is as follows:

Marbled and Dark Leather of one Color. Rub the place to be gilded with good nut oil, and burnish it with a dog's tooth, and then coat it with very thin-fluid flour paste; wash off the whole with urine and let it dry. Then coat the parts to be gilded with parchment glue, and, after drying, twice with white of egg. When dried so far as not to be injured on being touched with the hand, press the places with the warm

tool, and finally, before applying the gold, coat them with nut oil.

Calfskin. The best way to avoid stains is to dampen the leather with a wet sponge. When dry coat it with parchment glue, and then twice or three times with white of egg, and, when this is dry, gild as given above.

Dull Gilding on Calfskin. After washing and drying the cover, coat the places to be gilded once with gum-water, once with milk, once with parchment glue, and twice or three times with white of egg. Allow the ground to dry thoroughly, and then lay on the gold without oil.

To Gild Velvet. Velvet to be gilded must be lined with paper, as otherwise the gold will not adhere. The design is then pressed in with hot tools, and gamboge pulverized as fine as possible dusted quite thick over the places. Roll the tool softly on the gold, and when enough is taken up apply it with such a uniform pressure that when the tool is lifted up no gold remains on it. The tool should be just warm enough to allow of the hand being quickly passed over it without burning.

A very convenient method of applying the gamboge powder is to dust it through the silk bottom of a paste-board cylinder. The velvet must be scrupulously clean, since the smallest impurity prevents adhesion of the gold.

Gilding on Silk is done in the same manner as on velvet, only still more care, with less pressure, is required.

Bookbinders' Lacquer. The following well-tested receipts are recommended: Pulverize and dissolve 3 ounces of shellac, 1½ ounces each of sandarac, mastic, and benzoin in 1½ pints of absolute alcohol, then add 1½ ounces of Venetian turpentine, and filter the solution.

II. Pulverize 1 ounce each of sandarac, mastic, and white elemi, and dissolve the powder with the assistance of a moderate heat in ½ ounce of Venetian turpentine, and combine this by shaking with a solution of 4½ ounces of bleached shellac in 1 ounce of strong spirit of wine and 3½ ounces of oil of lavender. After standing for a few days the solution is filtered.

Improvement in the Manufacture of

Book Covers. Book covers are now made in endless strips by using a composition of oils solidified by mixture with fibrous substances and coloring matter and pressed through embossed rollers, which produces a resemblance of morocco, but with sharper outlines and capable of being washed. The mixture principally used consists of 100 parts of oxidized oil,* 10 of rosin, 10 of Kawrie copal (*New Zealand rosin*), 20 of white lead, 10 of coloring matter, 20 of sawdust, and 10 of paraffine wax. These substances are intimately mixed in a horizontal cylinder heated by steam. The cylinder is provided with a shaft with inclined wings by which the contents are carried forward and pressed out through an aperture in a similar manner as the clay in a kneading machine. When the mixture is ready it is spread upon a basis of textile fabrics, but principally consisting of paper combined with a fabric. A suitable agglutinant consists of: 12 parts of oxidized oil, 1 of Kawrie copal (*New Zealand rosin*), 1 of rosin, 24 of ochre, and 2½ of turpentine. The plate produced by the machine is afterwards divided in suitable pieces and the covers, if necessary, can be stiffened with paper board pasted to the back.

BRONZING, GILDING, SILVERING, ETC.

Apparatus for Coating Tools. Metallic tools and other articles, particularly those consisting of iron and steel which are used in laboratories or other workshops where acid vapors are of frequent occurrence, can be protected from rust with a black shining coat which resists acids and is but little affected even by a low red heat, as follows: Have a sheet-iron box constructed large enough to hold all the tools, etc., to be coated, and provided with a false bottom of wire netting. Underneath this is placed a layer of crushed blacksmiths' coal about ½ inch deep; then place the

* Oxidized oil is prepared by applying a drying oil to a tissue and exposing it to the action of the air, and when dry spreading on repeated coatings until the enamel thus formed is about ¼ inch thick. The solid oil is then ground together with the tissue upon which it has been formed.

tools, which must be entirely free from rust, clean and polished, upon the wire net. The box is then covered and set on a strong fire, which causes the coal to give off tarry constituents, and the heat is continued until the bottom of the box is at a red heat. When all evolution of gas has ceased, the box is allowed to become cold and the tools are taken out and will be found covered with a beautiful glossy coat. Tongs, shears, pincers, etc., so coated, keep in good condition for many months even in places where the air is constantly mixed with acid vapors.

Bronzing Copper. Dissolve 30 parts of carbonate or hydrochlorate of ammonium and 10 parts each of common salt, cream of tartar, and acetate of copper in 100 parts of acetic acid of moderate concentration, or in 200 parts of strong vinegar and add a little water. When an intimate mixture has been obtained, smear the copper object with it, and let it dry at the ordinary temperature for 24 or 48 hours. At the end of that time the object will be found to be entirely covered with verdigris presenting various tints. Then brush the whole, and especially the reliefs, with a waxed brush, and if necessary set off the high reliefs with hematite or chrome-yellow or other suitable colors. Light touches with ammonia give a blue color to the green portions, and carbonate of ammonium deepens the color of the parts on which it is laid.

Cold Black Stain for Brass. Dissolve with constant stirring 1 ounce of carbonate of copper in 9 ounces of spirits of sal-ammoniac and then add 1 pound 2 ounces of water. The stain is then ready for use. Suspend the articles to be stained by copper or brass wires and allow them to remain for a short time.

Galvanizing and Nickelling of Iron in Cleveland, Ohio. The sheets of iron are immersed in a bath of hot dilute sulphuric acid to remove oxide, and then washed with water; the plates are then immersed in commercial hydrochloric acid, after which they are dried in a hot oven. The zinc is melted in a large iron pan along the middle of which an iron screen is fixed, so that it just dips into the bath and extends about 3 inches above the rim; the surface

of the zinc is thus divided longitudinally into two compartments; ammonium chloride is strewn on the surface of one and in the other sand. The iron plates, hot from the oven, are dipped one at a time perpendicularly into the melting zinc on the ammonium chloride side, and are passed under the iron screen into the other side, whence they are drawn out by tongs and pulleys. Drops of zinc are removed from the lower edge by touching with an iron rod. When they are completely removed from the bath, the sand is wiped off and the plate is finished. The nickelling is conducted in wooden tanks lined with asphalt; the solution used consists of $\frac{3}{4}$ pound of nickel-ammonium sulphate dissolved in 1 gallon of water. The object to be nickelled, after it has been made perfectly clean by washing respectively with potash and dilute hydrochloric or sulphuric acid and scouring with pumice stone, is suspended in the bath by means of copper slinging wires from a copper or brass bar which is connected with the negative conductor of a dynamo-electric machine, while from another copper bar a nickel plate is suspended in the bath, care being taken that the nickel plate does not touch the object. After 15 to 30 minutes under the influence of the current, the object becomes sufficiently nickelled and is withdrawn, washed first with cold and then with warm water, and subsequently well dried. Care must be taken to regulate the current, as if it is too strong the deposited nickel will be dull, while if too feeble the deposit will be granular. The polisher is a disk of wood covered on the surface with a piece of leather, which has been immersed in thin lime-water, rolled in emery powder and dried.

Gilding of Steel. Dissolve pure gold in nitro-muriatic acid, and evaporate the solution to dryness to expel the excess of acid. Dissolve the residue in pure water and add 3 times the quantity of sulphuric ether. Then shake the mixture in a well-stoppered bottle until, when standing quietly, the ether appears of a golden-yellow color, and the water beneath it is entirely clear. Polished articles of steel plunged into the solution are instantly beautifully

gilded. By protecting portions of the surface of the articles with lacquer or varnish, beautiful designs can be produced. If the gilding should not turn out well at first, dilute the liquid with ether. Care should be had not to execute the work near a light or fire.

Gold and Orange Stain for Brass. Dip the articles in a mixture of 3 drachms of caustic soda, 2 ounces of water, and 5½ drachms of moist carbonate of copper. The shades of color appear in a few minutes, and the progress can be readily judged and observed. After obtaining the desired shade of color, rinse the articles in water and dry in fine sawdust.

Green Bronzing. The repeated applications to copper or brass of alternate washes of dilute acetic acid and exposure to the fumes of ammonia will give a very antique-looking green bronze; but a quick method of producing a similar appearance is often desirable. To this end the articles may be immersed in a solution of 1 part of perchloride of iron in 2 parts of water. The shade becomes darker with the length of immersion. Or the articles may be boiled in a strong solution of nitrate of copper. Or they may be immersed in a solution of 2 ounces of nitrate of iron and 2 ounces of hyposulphite of sodium in 1 pint of water. Washing, drying, and burnish complete the process.

Liquid Cement for Coating Articles. A liquid cement for giving a cheap and durable metal-coating to papier-maché, plaster of Paris, clay, slate, metal, etc., is prepared by two combined processes which supplement one another. The first consists of the following ingredients, which are mixed in substantially the following proportions: No. 1: 60 parts of powdered rosin, 15 of alcohol, spirit of wine, or pyroxylic spirit, 10 of turpentine, 10 of petroleum spirit, and 5 of soda water-glass. The liquid thus prepared is then spread upon the object to be treated in the manner of applying sizing, and can be used for papier-maché, plaster of Paris, clay, slate, cement, metals, etc., and renders them more firm, and water-proof. When it is desired to give a metallic finish in imitation of metal to the object treated with the above composition, apply to its surface, before the

composition has hardened, the powder of any desired metal, such as silver, copper, etc., by means of a fine camel's-hair brush, after which the article is dried in warm air or in the sun. In order that not only the metal dust may adhere but that also the metallic color may be retained and not oxidize on exposure to the air, the second composition or varnish is laid quite lightly on the metallized surface after the lapse of a few days. To prepare composition No. 2, dissolve 1 part of bichromate of potassium in 5 of water, and mix then 80 parts of distilled water, 15 of Russian glue, 5 of the above solution, or 5 of chrome-alum and water (1:5). After the article thus treated has been dried for some days in warm air or in the sun it will be found that this layer or metallic surface has become so hard and firm that it will not be injured by exposure to the heat of the sun, or to frost or moisture, being in fact weather-proof.

Porous and water-absorbing materials are rendered impervious by coating with the liquid cement No. 1.

New Process for Producing a Bronze-colored Surface on Iron. The cleansed objects are exposed to the vapors of a heated mixture of equal parts of concentrated hydrochloric and nitric acid for a few minutes, and heated to a temperature of from 572° to 662° F., the heating being continued until the bronze color appears. The objects are then cooled, rubbed with vaseline, and heated, until the latter begins to decompose, the operation being repeated once more. A bronze-colored oxide coating is obtained by using acetic acid in conjunction with the above-mentioned acids. By varying the proportions of the different acids it is possible to obtain light and dark brown shades. Iron bars coated in this manner and exposed for a year to the atmosphere of a laboratory remained unchanged and without the slightest sign of corrosion.

Painting on Zinc. The process is made easier by employing a mordant composed of 1 part each of chloride of copper, nitrate of copper, and sal-ammoniac dissolved in 64 parts of water, and to this mixture is added 1 part of commercial hydrochloric acid.

This is brushed over the plate of zinc, and after 12 or 24 hours it dries a dullish gray color. Painting upon this surface the colors will adhere in a perfect manner. Another method is as follows: Into some muriatic acid of full strength drop some pieces of zinc until effervescence ceases. Add an equal quantity of water, and with a sponge tied to a stick wash over every part of the surface to be painted. This roughens the surface and takes off that sort of greasiness which prevents paint from adhering. After the acid has remained a short time wash it over with water or diluted vinegar, dry off, and paint.

To Cleanse Brass. Dip the articles in a mixture of 1 part of nitric acid and $\frac{1}{2}$ part of sulphuric acid, then rinse in water, and finally rub with sawdust. If greasy, dip the brass first in a boiling hot solution of potash-lye.

To Color Soft Solder Yellow. When brass is soldered with soft solder the difference in color is so marked as to direct attention to the spot mended. This can be obviated by the following method: First prepare a saturated solution of sulphate of copper in water, and apply some of this on the end of a stick to the solder. On touching with a steel or iron wire it becomes coppered, and by repeating the experiment the deposit of copper may be made thicker and darker. To give the solder a yellow color mix 1 part of a saturated solution of sulphate of zinc with two of sulphate of copper, apply this to the coppered spot, and rub with a zinc rod, which produces a precipitation of brass. The color can be still further improved by applying gilt powder and polishing.

BUILDING MATERIALS.

Fire-resisting Properties of Building Materials. Of the natural building stones the highest rank as fire-resisting materials must be accorded to the sandstones; and of these the fine-grained, hard, silicious varieties (that is, those having a silicious cementing material) are the best. Such sandstones are found to be capable of resisting the radiant or direct heat of the most intense fire, before which limestone crumbles

and granite or gneiss crack and split into fragments. Of the artificial materials, brick and cement and iron comprise all that are commonly employed. Of these, the first two are first-class fire-resisting materials. The first named is undoubtedly the very best fire-proof material for a wall that can be used. Cast-iron, which at one time was largely used for the fronts of large structures, has proved to be utterly unreliable as a fire-resisting material, and is rapidly going out of use for this purpose, as it should. Even wrought-iron girders, used as floor supports, are elements of danger and weakness in case of fire, unless they are surrounded with a cement or similar filling. (W.)

Cork Stone. A product possessing many of the properties of natural cork but less specific gravity is prepared as follows: 6.3 parts by weight of pulverized cork-wood are mixed with boiling-hot paste prepared from 3 parts by weight of starch and 25 parts of boiling water. The plastic mass thus obtained is pressed at once into suitable moulds, and the objects produced are dried at a temperature of 212° F. The drying process is very slow. To make the articles more capable of resisting moisture add small quantities of linseed oil or tar to the mass.

Cork stone thus prepared being very light and a poor conductor of heat is especially adapted as a building material for the insulation of roofs, for ice cellars, and drying-rooms.

Enamelled Bricks. The composition of the enamel varies between 1 part of plumbic oxide and 1 of sand, and 2 parts of plumbic oxide and 1 of sand. For green enamel least plumbic oxide is used, and for colorless enamel generally 4 parts of plumbic oxide and 3 of sand. Some manufacturers add heavy spar, so that the enamel will only fuse at a high temperature. For coloring light brown to black, pyrolusite is used, and for green, copper scales. The constitution of the body of the brick is of great importance for the durability of the enamel. The harder it is burnt and the more the clay of which it is composed is inclined to slagging in consequence of a fine division of the lime contained in it the more intimate the union between the enamel and the body of the

brick will be, and the fewer cracks the enamel will show. Solid particles of lime near the surface of the body of the brick are especially injurious, as on coming later on in contact with water they are apt to crack the enamel.

Mass for Roofing, Fire-proof Ceilings, Floors, etc. Two masses are used, an under-layer and top-layer. For the under-layer stir to a paste: Slaked lime, blood, burnt alum, cement, sand, brickdust or pumice stone, coal-ashes, sawdust, broken glass or porcelain, and water-glass.

For the top-layer mix linseed oil, asphaltum, chalk, litharge, broken glass, burnt alum, blood, cement, plaster of Paris or chalk, and pumice stone.

For roofing, insulating layers, fire-proof ceilings, etc., apply both masses in a cold and liquid state upon a base. They soon harden.

For roofing, plates of the under-layer with a wire net enclosed are also used. The plates are coated with the top-layer and a solution of water-glass, and fastened to the rafters by means of cramps through the loops of the wire net.

Plaster for Ceilings. *H. Kahl's* patented plaster consists of: Sawdust 35 per cent., sand 35 per cent., plaster of Paris 10 per cent., glue 10 per cent., and whiting 10 per cent.

Terra-cotta Lumber. Mix, according to the degree of porosity desired, 1 to 3 parts of resinous wood with 1 part of elutriated kaolin, and add sufficient water to form a plastic mass of spongy consistency, which is exposed in metal cylinders to a strong pressure by steel stamps. The result of the operation are cylindrical blocks 8 to 12 inches in diameter and 4 to 6 feet long. The blocks are dried in the air, then in a drying oven, and finally heated in a furnace to a white heat. The blocks, after cooling, are very strong, and can be sawed, cut, and planed. Their density corresponds to about half of that of ordinary bricks. A special advantage of the mass is that it is fire-proof. It is patented in this country, and is successfully used for building and other purposes.

Utilization of Sawdust. Two patents have been recently issued in this coun-

try for the use of sawdust in place of sand for plastering. According to the one, equal parts of plaster of Paris and sawdust are used, while the other prescribes the following mixture: $4\frac{1}{2}$ parts of slaked lime mixed with sawdust, 1 part of plaster of Paris, $\frac{1}{4}$ part of glue, and $\frac{1}{8}$ part of glycerine. The plaster thus prepared is claimed to be much lighter and to adhere more firmly.

CELLULOID: IMITATIONS, SUBSTITUTES, ETC.

Artificial Ivory. Mix 8 parts of shellac with 32 parts of ammonia of 0.995 specific gravity, and shake the solution in revolving cylinders for about 5 hours at a temperature of 99.5° F. The result of the operation will be a complete solution of the consistency of thin syrup. Add to this 40 parts of zinc oxide, mix thoroughly with the hand, and then grind the mixture in a color-mill. The ammonia is then expelled by heating. The residue is completely dried upon glass plates, ground fine in a mill, and pressed into moulds with a pressure of as much as a ton to the square inch, and an increase of temperature to from 500° to 540° F. The product, when taken from the mould, is of a pure white color and closely resembles ivory.

Celluloid Printing Plates. Celluloid, though comparatively a recent product, is being continually applied to new uses in the arts. Very good results have lately been obtained with celluloid stereotypes, both from wood engravings and from type, which may be used on the printing-press. The process consists in taking a copy of the engraving on wood or of the type with the use of a special cement, which hardens rapidly and takes the finest lines sharply. After about 20 minutes this cement is hard and resistant. The form in which the first impression is taken should be slightly heated; and a sheet of celluloid is employed to obtain a counter impression from this, which is then prepared by ordinary methods for the printing-press. A celluloid plate has been subjected to 25,000 impressions, apparently without losing any of its sharpness.

When used as a substitute for wood in the production of large printing-type, it is found to be much preferable to wood. It has a fine surface, possesses great durability, can be readily worked, is light, and can stand all the rough usage of the press. [Celluloid has lately been successfully used for imitating enamel for signs, monograms, etc., to be attached to glass. (W.)]

Elastic Mass Resembling Leather. The pulverulent residue obtained in refining cotton-seed oil is intimately mixed in varying proportions with suitable non-volatile solvents, such as fats, oils, paraffine wax, resins, etc., and with pulverulent substances, such as graphite, cinnabar, soot, etc., and sulphur powder or carbon di-sulphide is added to the mixture. By heating the mass at 176° to 302° F. until the powder unites with the solvents to a homogeneous mass, a more or less hard, plastic substance is obtained.

Flexible Insulating Mass. One part by weight of mineral wax (paraffine, ozocerite), 20 of wood tar, 32 of shellac, and 32 of dry and finely-pulverized asbestos, flax, cotton, wood, or paper, are mixed in a boiler at 100° to 200° F., and constantly stirred. For a harder mass use less tar. For an especially hard mass omit the mineral wax, decrease the quantity of asbestos, and add about 24 parts of ground slate or clay, free from iron.

Insulating Material for Electrical Conductors. Mix 66 parts by weight of finely-powdered glass or quartz and 34 parts by weight of pulverized vegetable or mineral resin, and add 26 parts by weight of paraffine, beeswax or spermaceti, and 3 parts by weight of boiled or raw linseed oil. The proportions differ according to circumstances. If the mass is to be exposed to the sun only a small quantity of wax is to be used, while, for underground lines, the quantity of wax must be increased.

Mass for Plastic Models. The following preparation possesses many advantages over most now in use: Mix 200 parts of soapstone powder and 100 parts of the best wheat flour, and stir the mixture carefully into 300 parts of melted white wax, not too hot. The homogeneous mass can be colored at pleasure.

New Imitation of Ivory. This new material possesses all the hardness and brilliancy of celluloid, and has the advantage of being fire-proof. It is prepared as follows: Dissolve 200 parts of casein in 50 of ammonia and 400 of water, or 140 parts of albumen in 400 of water, and add to either solution 240 parts of quicklime, 150 of acetate of aluminium, 50 of alum, 1200 of sulphate of calcium, and 100 of oil, the oil to be mixed in last. For dark objects substitute 75 to 100 parts of tannin for the acetate of aluminium. The mixture is well kneaded, and made into a smooth paste and passed through rollers to form plates of the desired thickness. These are either dried and pressed into metallic moulds previously heated or they may be reduced to a very fine powder, which is introduced into the mould and submitted to a strong pressure. The objects are afterwards dipped into a bath consisting of 100 parts of water, 6 of white glue, and 10 of phosphoric acid. They are then dried, polished, and varnished with shellac.

New Substitute for Caoutchouc. Skins of hares, rabbits, and other small animals, or waste of such skins, are cleansed in water, depilated in lime-water, or by some other suitable method, and boiled with 5 per cent. of crude glycerine and as little water as possible, until entirely dissolved. The thickly-fluid, viscous mass obtained is either dried upon nets in an airy room or at once further manipulated. Three parts by weight of the mass and an equal quantity of crude glycerine are melted in a water or steam-bath, and $\frac{1}{2}$ part by weight of a concentrated solution of potassium bichromate is added. The liquid mass is poured into moulds and allowed to solidify under pressure. When cold the articles are taken from the moulds and dried in a dark, airy room. The evaporation of the excess of water takes place more quickly in a dark room than in a light one, as in the latter the surface of the articles becomes too quickly insoluble under the influence of light, which impedes the evaporation of the water in the interior. This mass bears a close resemblance to vulcanized caoutchouc, and has the advantage of standing heat much better.

To prepare a mass resembling hard rubber add less glycerine and a little more chromate and dry between heated, polished metal plates under pressure. A very hard product is obtained by immersing the articles in a bath of chrome-alum solution. This substitute for hard rubber can be sawed, ground, and polished. To make it resist acids add to the mass 30 per cent. of gum-lac dissolved in alcohol. By the addition of suitable coloring matters, imitations of coral, malachite, etc., are obtained. If the mass is to be used for articles which, with great elasticity, have to resist strong pressure, such as railroad buffers, wheel tires, etc., only 1 part of crude glycerine is used and $\frac{3}{4}$ part of comminuted cork mixed with the mass.

For the preparation of a mass for water-proofing fabrics, etc., add $\frac{1}{4}$ part by weight of ox-gall to the mass and compound with sufficient soft water to give it the consistency of thickly-fluid oil; about $\frac{1}{4}$ part of the potassium bichromate is used. The thickly-fluid mass thus obtained is brought into a double-walled cylinder, heated by steam and provided with a roller under which the fabric to be impregnated is conducted.

Substitute for Gutta-percha. The following mass, which is patented in Germany, is claimed to be a good substitute for gutta-percha for many purposes. The process of manufacture is as follows: A mixture of 50 parts by weight of powdered gum copal, 7 to 15 of sulphur, and 15 to 30 of oil of turpentine, is heated to from 228° to 300° F. and thoroughly stirred. After being allowed to cool to 100° F., an emulsion prepared from 3 parts by weight of casein and weak ammonia with an addition of some alcohol and wood spirit is added, and the whole heated once more to 300° F. until it has acquired the consistency of thin syrup. It is then boiled for a few hours with an ammoniacal solution of 15 to 25 per cent. of tannin. The product is cooled, washed in cold water, rolled out, and finally dried.

Superior Modelling Wax. Melt carefully over a moderate coal fire 2 pounds of yellow beeswax, add 4½ ounces of Venetian turpentine, 2 ounces of lard,

and 1½ pounds of elutriated bole, and mix thoroughly. Then gradually pour the mixture into a vessel with water and thoroughly knead several times with the hands. The wax should be melted at such a low temperature that no bubbles appear upon the melted surface.

Vegetable Leather. This new product, which, it is claimed, possesses all the properties of genuine leather, is water-proof and a non-conductor of electricity, is prepared by mixing 6½ pounds of gutta-percha, 2 pounds of sulphur, 2 pounds of raw cotton, 1 pound 5 ounces of zinc white, 3½ ounces of coleothar, and 8¾ ounces of antimony oxide, and vulcanizing the mass by means of steam similar to caoutchouc. Gutta-percha and sulphur are absolutely required, while chemicals of similar nature may be substituted for the other constituents. The proportions of the separate components may also be varied, according to the purpose the product is to serve. The composition is recommended for soles and heels.

CEMENT WORK.

Weather-proof Cement Work. Soak the article for 24 hours in a solution of 1 part of ferrous sulphate in 3 of water and dry in the air. The ferric oxide produced is chemically combined in the cement and makes it denser, harder, heavier, and weather-proof, filling up most of the pores, and giving it an ochre color. Ornamental cement work is brushed over with the solution four times and allowed to dry. The cement work can be rendered extremely resisting by warming and then coating with a hot mixture of equal parts of paraffine and paraffine oil. This treatment is recommended as being especially serviceable for ornamental cement work which is exposed to the weather. By treating twice with a 5 per cent. soap solution, drying and polishing, the surface is made receptive for oil-painting. Chalk objects and room walls treated in this manner will stand any amount of washing. Light ochre color can be obtained by adding alum to the ferrous sulphate; and various shades of green by painting with chrome-alum.

CLEANSING, POLISHING, AND RENOVATING AGENTS.

Cleaning-powder for Show-windows.

A good cleaning-powder, which leaves no dirt in the joints, etc., is prepared by moistening calcined magnesia with pure benzine so that a mass is formed sufficiently moist to let a drop appear when pressed. The mixture should be preserved in glass bottles with ground stoppers, in order to retain the easily volatile benzine. A little of the mixture is placed on a wad of cotton and applied to the glass plate. It may also be used for cleaning mirrors.

Cleansing-rags for Polishing Metal.

Dip flannel rags into a solution of 20 parts of dextrine and 30 parts of oxalic acid in 20 parts of logwood decoction, wring them gently, and sift over them a mixture of finely-pulverized tripoli and pumice stone. The moist rags are piled upon each other, placing a layer of the powder between each two. They are then pressed, taken apart, and dried.

Cleansing Wash-leather. Wash the soiled polishing leather in a weak solution of soda and warm water, then rub a good deal of soap into the leather and let it soften for 2 hours. It is afterwards thoroughly washed until perfectly clean, and rinsed in a weak solution of warm water, soda, and yellow soap. It must not be washed in water alone or it will become so hard when dry that it cannot be used again. It is the small quantity of soap remaining in the leather which penetrates its smallest particles and makes the leather as soft as silk. After the rinsing, it is wrung out in a coarse towel and dried quickly. It is then pulled in every direction and well brushed, after which it is softer and better than most wash leather when first bought. If rough leather is used to finish highly polished surfaces, it will be often observed that the surface is scratched or injured. This is caused by particles of dust, and even grains of hard rouge that were left in the leather. As soon as they are removed with a clean brush and rouge, a perfectly bright and beautiful finish can be obtained.

Cloth-cleaning Compound. Take $\frac{1}{2}$ ounce each of glycerine, alcohol, and

sulphuric ether, 2 ounces of aqua ammonia, $\frac{1}{2}$ ounce of powdered Castile soap and add sufficient water to make 1 quart of the mixture. Use with brush or sponge, and rinse with pure water.

Furniture Renovator. Mix thoroughly, olive oil 1 pound, refined oil of amber 1 pound, and tincture of henna 1 ounce. Keep the mixture in a well-stoppered glass bottle. For renovating the polish of furniture apply the mixture with a tuft of raw cotton and rub dry with a cotton rag.

Liquid Polish for Silver-plated Ware. Dissolve 3 to 4 drachms of cyanide of potassium and 8 to 10 grains of nitrate of silver in 4 ounces of water. Apply with a soft tooth-brush, wash the object thoroughly with water, dry with a soft linen cloth, and polish with a chamois skin. Neither whiting nor powder of any kind should be used for cleaning and polishing; they only wear out or scratch the silver. In the case of solid silver some precipitated chalk is allowable in the solution.

For preserving the lustre of silver or plated ware, when not needed for actual use for a considerable time, a coating of collodion may be employed to great advantage. The articles are heated and the collodion is carefully applied by means of a brush, so as to cover the surface thoroughly and uniformly. It is used most conveniently when diluted with alcohol, as for photographic purposes.

New Polish for Wood. Dissolve 6 pounds of shellac in about 4 to 5 gallons of pure alcohol. Then pour 3 $\frac{1}{2}$ ounces of high-grade sulphuric ether over 3 $\frac{1}{2}$ ounces of collodion cotton in a bottle, add 1 $\frac{1}{2}$ ounces of camphor, stir thoroughly and add 96 per cent. alcohol enough to completely dissolve the cotton.

Then pour both solutions together and shake well. The polish is then rubbed in with an oil prepared as follows: Prepare a saturated solution of camphor in good oil of rosemary and add 1 $\frac{1}{2}$ ounces of this to 2 pounds 3 ounces of pure linseed-oil. For finishing, dissolve benzole in alcohol and dilute at pleasure, taking care to apply the solution as weak as practicable.

Polishing Soaps and Pastes have been recently introduced, and as they are preferred by many to the ordinary polishing powders for cleansing gold, silver, brass, etc., we give in the following several receipts for good polishing soaps and one for polishing paste.

A polishing soap especially suitable for silver and brass is prepared as follows: Set in the ordinary manner 50 pounds of cocoanut oil with 75 to 80° of 23° soda, and boil the mixture to a clear jelly. When the soap is ready and sufficiently solidified add 10 pounds of tripoli, 5 pounds of alum, 5 pounds of cream of tartar, and 5 pounds of white lead, all previously finely pulverized and intimately mixed. Pour the mixture into small, shallow tin moulds, and it will quickly solidify. For cleansing, moisten the articles with lukewarm water with a brush, and apply the soap with a rag.

Another polishing soap is made as follows: Wash commercial colcothar in water 6 to 8 times and then dry it. Next prepare a soap solution by dissolving at a moderate heat 6½ pounds of cocoa soap, cut in pieces, in soft water. Mix intimately ½ pound of the prepared colcothar rubbed up with a little water and 5½ ounces of purified ammonium carbonate, finely pulverized, and add the cold soap solution, with constant stirring. Keep the polishing soap thus prepared in stone jars closed with oiled paper.

Another polishing soap is prepared by dissolving 14 ounces of Marseilles soap in ½ gallon of water, and adding to the solution 7 ounces of finely-pulverized chalk. The mixture is colored red with fuchsine and kept in stone jars. By applying this soap with leather or a woollen rag the dirtiest articles can be cleansed in a short time.

For preparing polishing paste or pomade melt 7 ounces of beef marrow and add 3 ounces of fine colcothar. Perfume the mixture with oil of almonds and pour it into small tin boxes. Lard may be used instead of beef marrow. Apply the paste with a soft rag, rub thoroughly, and finish with a dry rag.

Restoring Plush. It is customary to use ammonia for the purpose of neutralizing acids that have accidentally de-

stroyed the colors of fabrics. This must be applied immediately, or the color is usually imperfectly restored. An application of chloroform, used with caution, will, however, bring out the colors as bright as ever. Plush goods and all articles dyed with aniline colors, faded from exposure to light, will look as bright as ever after sponging with chloroform.

To Clean Glass and Silverware. Egg shells crushed into small pieces and shaken well in decanters three parts filled with cold water will not only clean them thoroughly but make the glass look like new. By rubbing with a flannel dipped in the best whiting the brown discoloration may be taken off cups in which custards have been baked. Emery powder will remove ordinary stains from white ivory-handle knives, and the lustre of morocco leather is restored by varnishing with white of egg. To clean silver nothing is better than alcohol or ammonia, finishing with a little whiting on a soft cloth.

To Clean Marble. After brushing the dust off with a piece of chamois rub the marble with the following solution: One-quarter pound of soft-soap, ¼ pound of whiting, and 1 ounce of soda, and a piece of stone-blue the size of a walnut. Rub it over the marble with a piece of flannel and leave it for 24 hours, then wash it off with clean water, and polish the marble with a piece of flannel or an old piece of felt.

Another method is as follows: Take 2 parts of common soda, 1 part of pumice stone, and 1 part of finely powdered chalk, sift it through a fine sieve, and mix it to a paste with water. Rub it well over the marble, and then wash with soap and water.

To take stains out of white marble mix 1 ounce of ox gall, 1 gill of lye, and 1½ table-spoonfuls of turpentine, and make it into a paste with pipe-clay. Put the paste over the stain and let it remain for several days. To remove oil stains apply common clay saturated with benzine. If the grease has remained in long the polish will be injured; but the stain will be removed. Iron mould or ink spots are taken out in the following manner: Dissolve ½ ounce of butter of antimony and 1

ounce of oxalic acid in 1 pint of rain water, and add enough flour to bring the mixture to a proper consistency. Lay it evenly on the stained part with a brush, and, after it has remained for a few days, wash it off, and repeat the process, if the stain be not wholly removed.

To Cleanse Silvered Dial Plates. Silvered dial plates of clocks frequently lose their lustre by the effect of air and smoke or sulphurous emanations. To cleanse them make pulverized purified tartar into a paste with water. Take some of the paste on a brush of bristles and rub the dial plate with it, turning it constantly, until the silvering has acquired its original whiteness and lustre. Then wash the dial plate with clean water and dry by gentle patting with cloth, and finally expose it for a few minutes to a moderate heat.

To Clean Smoky Walls. Brush them with a broom, then wash them over with strong pearlash water, and immediately rinse them with clean water before the pearlash is dry. When dry, give the walls a thin coat of fresh slaked lime containing a liberal portion of alum dissolved in hot water. Finish with whiting and good size. Be careful not to apply the size-distemper till the lime wash is dry, as the latter will destroy the strength of the size if the two come in contact while wet.

COLORS, ENAMELS, CEMENTS, GLUE, VARNISHES, WATER-PROOFING SUBSTANCES, ETC.

American Wood-filler. Mix 1 part by weight each of pulverized starch and heavy spar and $\frac{1}{2}$ part by weight of siccativ with sufficient turpentine to the consistency of ordinary varnish. For dark woods add up to $\frac{1}{2}$ part by weight of umber to the siccativ.

Apply the filler with a medium stiff brush. When the coat, at first lustrous, becomes dull, remove everything from the surface by rubbing across the grain of the wood with a piece of felt or strong leather fastened to a piece of wood. Allow the prepared wood to dry 8 hours, then rub thoroughly with glass paper, and it is ready for polishing or varnishing.

Cement for Mending Enamelled Dial Plates. Scrape some pure white wax, mix it with equal parts of zinc white, melt the mixture over a spirit lamp, and let it cool. For use, warm the dial plate slightly and press the cold cement into the defective places. The cement adheres very firmly and by scraping with a sharp knife acquires a white and lustrous surface. In case the cement should be too hard add some wax, and if too soft some zinc white. Cleanliness in the manipulation and moderate heating in mixing are the principal points and contribute essentially to the snow-white color of the cement.

Crystalline Coating for Wood or Paper. Mix a very concentrated solution of salt with dextrine and lay the thinnest coating of the fluid on the surface to be covered by means of a broad soft brush. After drying, the surface has a beautiful, bright, mother-of-pearl coating, which, in consequence of the dextrine, adheres firmly to paper and wood. The coating may be made adhesive to glass by going over it with an alcoholic shellac solution. The following salts are mentioned as adapted to produce the most beautiful crystalline coating, viz.: Magnesium sulphate, sodium acetate, and tin sulphate. Paper must first be sized; otherwise it will absorb the liquid and prevent the formation of crystals.

Enamel for Fine Cards and Other Purposes. For white and for all pale and delicate shades take 24 parts by weight of paraffine, add 100 parts of pure kaolin (china clay) very dry, and reduce to a fine powder. Before mixing with the kaolin the paraffine must be heated to the fusing point. Let the mixture cool, and it will form a homogeneous mass, which for use is reduced to powder, and worked into paste in a paint mill with warm water. It can be tinted according to fancy.

Imitation of Cinnabar. Dissolve in 5 parts of warm water made slightly alkaline by the addition of a small quantity of soda 1 part of eosin, and add with constant stirring 100 parts of best orange minium; then add 3 parts of sugar of lead or lead nitrate dissolved in warm water. The mass is filtered and pressed, and the press cakes are cut into small pieces and

dried as quickly as possible. After drying the product is ground and passed through a fine sieve.

Enamel free from Lead and Metallic Oxides for Iron and Sheet-iron, and Utensils Manufactured from them:

	PARTS.		PARTS.
Silica . . .	30 to 50	or quartz	30 to 50
Flint . . .	10 to 20	" granite	20 to 30
Kaoline . . .	10 to 20	" borax . . .	16 to 20
Pipe-clay . . .	8 to 10	" glass . . .	6 to 10
Chalk . . .	6 to 10	" magnesia	10 to 15
Porcelain meal	5 to 15	" fluorspar	5 to 20
		" weathered	
Boracic acid .	20 to 40	sodium carbonate	10 to 20
		" heavy spar	2 to 8
Saltpetre . . .	6 to 10	" fluorspar .	3 to 10
Gypsum . . .	2 to 6		

After grinding every ingredient separately they are all intimately mixed and fused to enamel. This, after again grinding, is applied and burnt in.

The proportions of these constituents may vary according to the nature of the metal to be enamelled. The enamel should be applied in thin layers, as it expands in different proportions from the sheet-iron on exposure to a high temperature. The articles must be slowly cooled, as otherwise an unequal contraction takes place, which causes the enamel to crack off.

New Method for the Production of Water-proof and Incombustible Fabrics. The fabric is immersed for a few minutes in a 7 to 8 per cent. solution of gelatine heated to 104° F., then pressed out between rollers and dried to a certain degree in the air. It is then placed for a few minutes in a cold 30 to 40 per cent. solution of alum, hung up for an hour in the air, washed in cold water, and dried. It is claimed that by this process, which is patented in England, the fabric is rendered water-proof and incombustible without becoming stiff or losing its ductility, or preventing the free passage of air.

Phosphorescent Enamel. Commercial phosphorescent paint in powder is intimately mixed with $\frac{3}{4}$ of its weight of very finely-pulverized fluorspar or cryolite, and $\frac{1}{4}$ of calcium borate. The mixture is made into a paste with water, and applied in a uniform layer to the articles to be enamelled by means of a brush. They are then burnt in the usual manner.

Preparation of Lustre-colors with Carbolic Acid. The present methods of preparing lustre-colors, which are much used in the decoration of earthenware and glass, have the disadvantage that a large portion of the metallic salts remains undissolved, and is separated and lost in an undissolved state in dissolving the resinous mass. With the aid of carbolic acid it is possible to prepare lustre-colors without an appreciable loss of metallic combinations.

Bismuth Lustre. Dissolve 10 parts by weight of bismuth in nitro-muriatic acid and evaporate to the consistency of thin syrup. When cold add 50 parts by weight of carbolic acid liquefied by moderate heating in warm water. Let the mixture stand a few hours, as by stirring and heating at once a too energetic reaction, accompanied by strong foaming, takes place. Then stir the mixture with a glass rod and heat it for some time in a steam-bath. During this operation vapors of hydrochloric acid are evolved. The mass is taken from the steam-bath as soon as a drop taken from the vessel by means of the glass rod dissolves clear in nitro-benzole. When this is the case the mixture is dissolved in nitro-benzole and is ready for use.

Tin Lustre. Dissolve 10 parts by weight of tin in nitro-muriatic acid, evaporate to the consistency of thin syrup, and treat with 50 parts by weight of carbolic acid in the same manner as prescribed for bismuth lustre. The subsequent treatment for this and the following preparations is the same as that of bismuth lustre.

Uranium Lustre. Dissolve 15 parts by weight of uranic nitrate in 40 parts by weight of pure hydrochloric acid, and treat with 50 parts by weight of carbolic acid.

Iron Lustre. Dissolve 15 parts by weight of ferrous chloride in pure hydrochloric acid, and after evaporating to the consistency of thin syrup treat with 50 parts by weight of carbolic acid.

In the same manner as iron lustre manganese lustre is prepared from manganese chloride, nickel lustre from nickel chloride, and cobalt lustre from cobaltous chloride.

For the production of combination

lustres the different preparations are mixed together.

Soap Varnishes. These varnishes are valuable on account of their cheapness, their resistance to water, and their elasticity. The simplest mode of preparing them is as follows: Tallow soap is boiled in rain water until a clear solution is formed, and the hot solution filtered through a cloth. It is then again heated, and after diluting with an equal volume of rain water precipitated with boiling solution of alum. The precipitated stearate of aluminium is washed several times with boiling water and dried, heated on a water-bath until transparent, and stirred into hot turpentine until it forms a thick varnish, which, if too thick, can be thinned with hot turpentine.

Johnson's Varnish for Water-proofing Paper or Cloth. Dissolve green vitriol in water, add soap to the solution, and collect and dry the precipitate of stearate of iron or iron soap. By dissolving the stearate of iron in carbon sulphide or benzole a liquid is obtained which leaves a water-proof layer upon paper or cloth. If the paper or cloth is to remain white, alum solution is substituted for the green vitriol, and the resulting white stearate of aluminium is used in the same manner.

Soap Varnish for Gilding. This is prepared from resin soap which is made by heating a solution of 50 parts of soda in 150 of water to the boiling point, and adding gradually and with constant stirring 100 parts of powdered rosin; the boiling is then continued 2 or 3 hours until the liquid is transparent. After cooling and pouring off the supernatant fluid the resin soap is mixed with 100 parts of water and 15 of soaked glue and heated until the whole is dissolved. This is a quick-drying varnish, but can be made slow-drying by adding 10 to 20 parts of glycerine of 28° B. The resin soap mixed with 5 per cent. of its weight of ammonia forms a cheap and durable vehicle for paint.

Water-proof Glue. Dissolve of gum sandarac and mastic each 5½ drachms in ½ pint of alcohol and add 5½ drachms of turpentine. Place the solution in a glue boiler upon the fire and gradually stir into it an equal quantity of a strong,

hot solution of glue and isinglass. The mixture is ready for use after straining it, while hot, through a cloth.

For gluing mineral substances it is best to stir 5½ drachms of finely-pulverized glass into the strained mixture. Articles glued with this preparation can be placed under water without danger of the glued parts separating.

COPYING.

New Method of Copying Drawings.

The paper on which the copy is to appear is first dipped in a bath consisting of 30 parts of white soap, 30 parts of alum, 40 parts of glue, 10 parts of albumen, 2 parts of glacial acetic acid, 10 parts of alcohol of 60°, and 500 parts of water. It is afterwards put into a second bath which contains 50 parts of burnt umber ground in alcohol, 20 parts of lampblack, 10 parts of glue, and 10 parts of bichromate of potassium in 500 parts of water. The paper is now sensitive to light and must therefore be preserved in the dark. In preparing paper to make the positive print another bath is made just like the first one, except that lampblack is substituted for the burnt umber. To obtain colored positives the black is replaced by some blue, red, or other pigment. In making the copy the drawing to be copied is put in a photographic printing-frame, and the negative paper laid on it and then exposed in the usual manner. In clear weather an illumination of two minutes will suffice. After the exposure the negative is put in water to develop it, and the drawing will appear in white on a dark ground: in other words it is a negative or reverse picture. The paper is then dried and a positive made from it by placing it on the glass of a printing-frame and laying the positive paper upon it and exposing as before. After placing the frame in the sun for two minutes the positive is taken out and put in water. The black dissolves off without the necessity of moving it back and forth.

Phytochromotypy. This is a process of producing impressions of leaves and plants and is effected as follows: The plant is first dried and flattened by

pressure between unsized paper, or it may be done rapidly with a hot iron. The surface to be copied is then brushed with a solution of aniline color in alcohol and allowed to dry, which will take place very rapidly. If the impression is to be taken on paper, immerse the latter in water for a few seconds, and remove the excess by pressing between blotting-paper. Place it then on some non-absorbing surface and apply the plant colored side down; place over it a sheet of strong paper, and while it is held securely in position stamp the whole surface with a wad of cotton. A cold iron may be lightly passed over the paper instead of using the cotton, and if a few sheets of tissue paper are interposed between the paper and plant its outline and veins principally will be copied, while without it the whole surface may be impressed on the paper. If the paper which is to receive the impression is moistened with alcohol instead of water, the impression will be brighter and the paper will retain its lustre or glaze better. If a very light coating of glycerine be spread upon the colored plant when perfectly dry, and the excess removed by unglazed paper, one or more prints may be immediately taken upon dry paper or other dry surface. If the print shows blots when a strong color is used, pass over the surface with a solution of saltpetre which will moderate the impression. Different parts of plants may be colored differently to conform to nature or individual taste. Defects may be touched up with a pen dipped in the color.

EXPLOSIVE AGENTS.

Blasting Cartridges. Dissolve 73 parts of saltpetre and 1 of magnesium sulphate in $\frac{1}{2}$ of their weight of boiling water, and compound with 8 parts of ground wood charcoal, 8 of bran, and 10 of sulphur, previously mixed dry. Stir the mass thoroughly, and heat for 2 hours at a temperature of 284° F., and then dry in a drying apparatus for 5 hours at a temperature of 122° F. The dried mass is pressed into cylinders, four of which are generally formed into a cartridge in a paper shell.

Blasting Paper. Coat unsized paper with a hot mixture of 11 drachms of ferrocyanide of potassium dissolved in 3½ pints of water, 11 ounces of bass-wood charcoal, 1½ ounces of refined saltpetre, 2½ ounces of potassium chlorate, and 6½ drachms of wheat starch, stirred to a paste with 1½ ounces of water; dry and smooth. For use roll strips of the prepared paper into cartridges.

Explosive Combination. An explosive combination consists, according to a French patent, of 80 parts of powdered potassium chlorate, 20 parts of ordinary coal tar, and a porous, absorbent substance, such as pulverized wood-charcoal or silicious earth. Potassium permanganate can be substituted for a portion of the chlorate.

Explosive Substance. This, according to an English patent, consists of 9 parts of potassium chlorate, 2 of carbohydrate (sugar), 1 of flour, and 1 of ferrocyanide of potassium.

Explosive and Pyrotechnic Substances. Ferrocyanide of potassium, saltpetre, and chlorate of potassium are dissolved and mixed with pulverized charcoal. The water is then evaporated, and the substances are combined by the admixture of paraffine or resins. The paraffine is used either melted or dissolved in benzine. The mass is made into any desired shape, and can also be used for coating paper.

Method of Blasting under Water with Compressed Gun-cotton. In the accompanying illustration, Fig. 60, *aa* represent layers of gun-cotton, *b* the cartridge of compressed gun-cotton, and *d* the quick match with the cap. The cartridge is enclosed in the rubber tube *e*, which on the top is fastened water-tight around the quick-match, so that



Fig. 60.

when the cartridge is placed under water the latter can penetrate the gun-cotton only from below. The entire charge is enclosed in the tin case *c*, which is open on top and bottom for the passage of water. The cartridge remains explosible until all the gun-cotton is soaked through by the water entering from below, which with a cartridge about 1 inch in diameter and $4\frac{1}{2}$ inches long will be the case in exactly 22 hours, which makes the unexpected explosion of a charge missing fire impossible after that time.

New Blasting Powder. Saltpetre, potassium chlorate, and finely-pulverized coal-tar pitch are converted with benzine into a plastic paste, which is made into flat cakes and freed from the

of this powder are: 1. Facility and quickness of manufacture. 2. Safety in its preparation. 3. Absence of all hygroscopic properties (4 ounces placed upon a very sensitive scale in an open window for 4 days of misty weather did not increase in weight). 4. Superior force, $2\frac{1}{2}$ times that of ordinary powder. 5. Very small residue. 6. Scarcely perceptible smoke.

New Method of Preparing Giant Powder. Two mixtures are prepared:

a. 36.06 parts of potassium or sodium bisulphate, 28.60 of potassium nitrate, and 9.20 of glycerine.

b. 50 to 55 parts of some chlorate, and 50 to 45 parts of a substance rich in carbon.

On igniting a mixture of the two, it

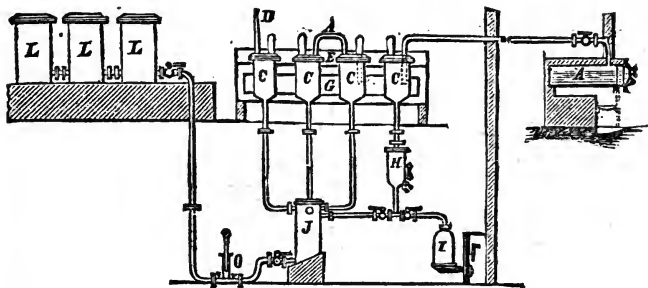

Fig. 61.

benzine by evaporation, and then worked in the same manner as ordinary powder. The grains, which, like those of the ordinary article, are irregular in form, can be made of any desired size. The density, which is 0.9 or somewhat more, corresponds with that of ordinary gunpowder. This new powder possesses considerable hardness, does not lose color, even when wet, and without undergoing a change stands a higher degree of heat than that of melting tin. It is not inflammable by single sparks of short duration. Ignited free, it burns quickly with a white flame; in a closed space it burns, however, very energetically with little smoke and leaving a very small residue. A gun is not in the least affected by its combustion products. The advantages

is claimed mixture *b* evolves sufficient heat to effect the nitrication of the glycerine and explosion of the nitroglycerine. The material rich in carbon is saturated with concentrated solutions of the bisulphate, nitrate, and chlorate, and dried. The mass is then mixed with the glycerine and made into cartridges.

Preparation of Hyponitric Acid and its Use for Explosive and Illuminating Substances. The following process has been patented in France and Germany: Nitrate of lead is heated in the retort *A* (Fig. 61). The developed gases are first conducted through sulphuric acid, which retains the moisture, and then into the condensers *C* of enamelled cast-iron, which rest in the cooling vessel *E*, whose cooling fluid is kept at zero by

the ice machine *G*. While the oxygen escapes for further use through *D*, the hyponitric acid collects in the reservoirs *H* and *J*, the first of which is provided with a test-cock for the examination of the acid. The reservoir *I* contains sulphuric acid. From *J* the hyponitric acid is brought by the pump *O* into the vessel *L*, and from there is drawn into tin cans. The oxide of lead in the retorts is reconverted into nitrate by nitric acid.

A mixture of carbon di-sulphide and hyponitric acid is a powerful explosive, which is exploded by fulminate of mercury or gunpowder. It does not explode by a shock alone, nor by heating to 398° F. A mixture of equal parts of hyponitric acid and carbon di-sulphide gives the most powerful explosion.

The mixture burns in the open air with a brilliant white light, which is powerfully actinic.

GLASS.

Appert's Method of Blowing Glass by Means of Compressed Air. The air is compressed by a double cylinder pump to 50 pounds per square inch. The compressed air passes into 12 steel reservoirs, which together form a battery.

Each reservoir has a capacity of 150 gallons, and is tested to stand a working pressure of 70 pounds per square inch. A cylinder placed on the side is provided with a safety-valve with an alarm whistle. The reservoirs serve as accumulators for night work.

Lead pipes, 1 inch in diameter, are used for distributing the compressed air. They are placed in the upper part of the work-room, and provided at suitable places with discharge-cocks. For blowing large vessels the air can be taken direct from the conduit, while for small articles the air is conducted into collecting cylinders, and the pressure regulated according to the nature of the articles to be blown.

The compressed air is conducted to every large room by underground iron pipes connected with the accumulators and the collecting cylinder, which is

provided with contrivances by which the pressure can be regulated to $\frac{1}{2}$ ounce to the square inch. From the pressure regulator conduits lying upon the floor lead to the work-places of the glass-blowers. The conduits are provided with cocks which can be regulated by the workman with the foot. On the cocks are rubber pipes communicating with the air-nozzle, consisting of a rubber cone enclosed by a copper case which is fastened to an iron pipe movable in a stationary pipe. The two pipes are separated from each other by oiled tow.

One end of the pipe is connected with the nozzle. Figs. 62 to 74 represent the manner of connection.

The glass-blower works upon a bench upon which the pipe connected with the nozzle is carried by a small carriage, which moves in a frame fastened to the ledge of the bench, and is provided with 1 vertical and 4 horizontal rollers.

For fashioning an article a curved metal pipe called a "swan neck" is used. It is connected with the air-nozzle by means of a piece of rubber pipe, which rests upon the blowing-pipe, which is held straight.

A third arrangement allows of blowing free in the air by holding the blowing-pipe perpendicular or slanting, the glass being always under it.

It will be readily understood that by varying the shape and adjustments of the pipes fastened to the air-holes and by fitting to the pipes rubber hose of various lengths and connecting each with a nozzle, the blowing-pipe can be given any desired mobility, and the smallest as well as the largest articles, for instance cylinders 3 feet in diameter, can be blown with the greatest ease.

Another use of compressed air is for the manufacture of pressed glass. Appert's apparatus consists of a cylinder, in which moves a piston. Thick rubber plates on both ends of the piston-track serve for breaking the shocks. The core is fastened to the lower part of the piston, whose motion can be accurately regulated.

The piston is put in motion by a slide-valve constructed similar to that of a steam-engine. This machine can exert

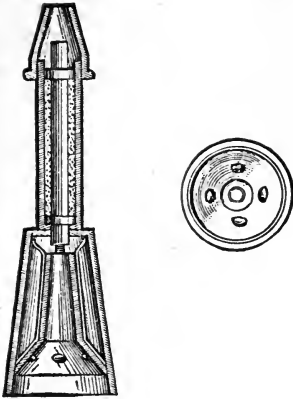

Figs. 62 and 63.

a pressure of 1450 pounds, and the pressure is carried out with such rapidity that extremely thin articles can be made. The average capacity of the

machine is 100 piston strokes per hour, with a consumption of 2 cubic feet of compressed air.

The expenses of blowing glass by compressed air are not increased, but on account of the great rapidity of the work rather diminished; and, besides, the work is easier on the workmen and the process does away with many evils of the present manner of blowing glass.

Without the aid of illustrations it would be difficult to give a complete description of the process. From the accompanying accurate illustrations with explanations the practical importance and ingenious arrangement of the process will be readily recognized:

Figs. 62 and 63 show a section of the air-nozzle into which the workman introduces his blowing-pipe in the moment of blowing.

Fig. 64 is a longitudinal section through the working-room of the glass-house.

a. Air reservoir under a pressure of 8.8 pounds.

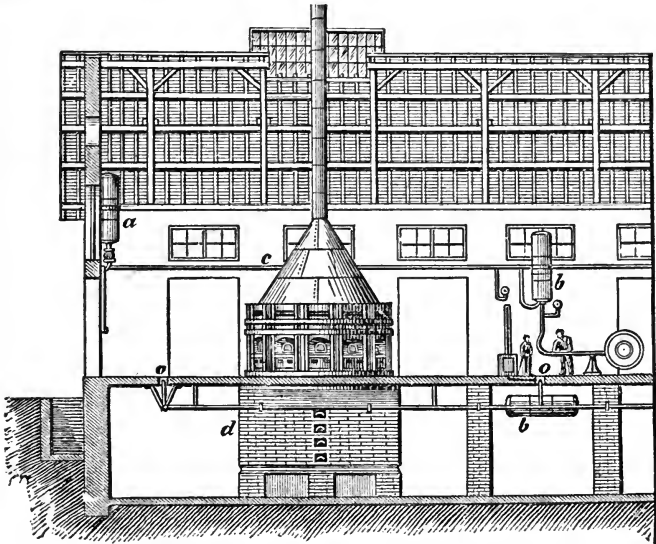

Fig. 64.

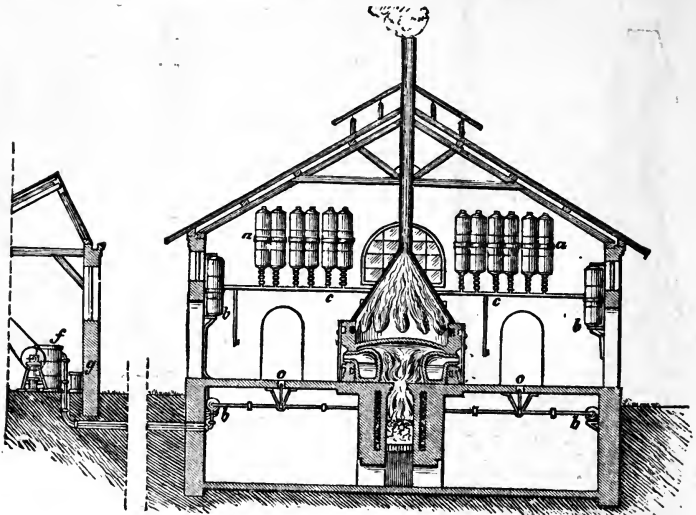

Fig. 65.

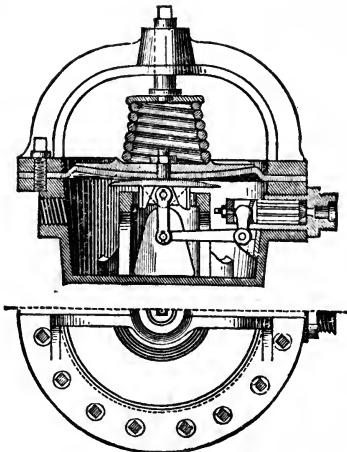

Fig. 66.

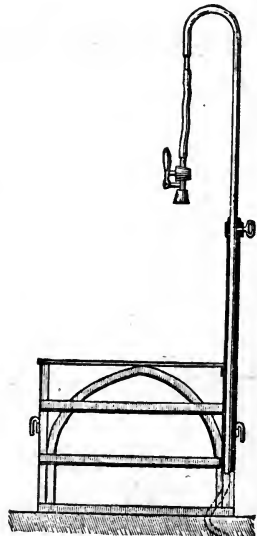

Fig. 67.

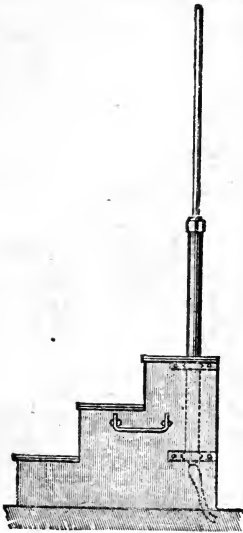

Fig. 68.

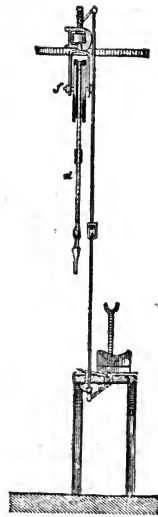

Fig. 70.

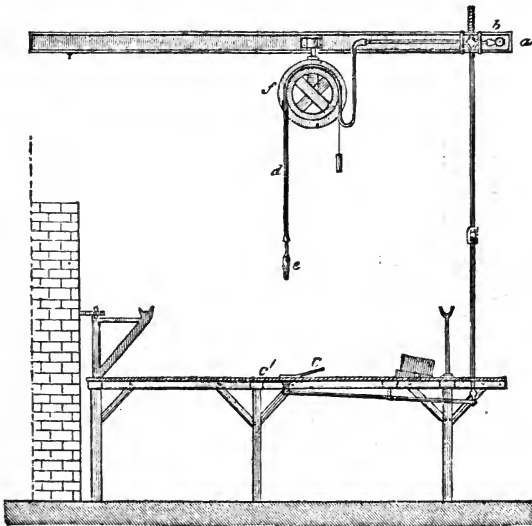

Fig. 69.

b. Air reservoir under a pressure of 6½ ounces.

c. High-pressure air conduit.

d. Low-pressure air conduit.

Fig. 65. Cross section through the work-room of the glass-blowers.

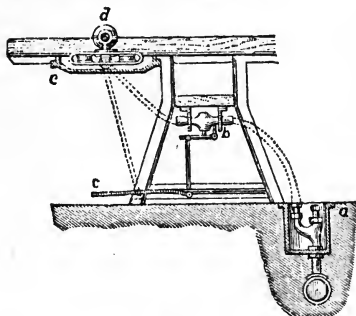

Fig. 71.

f. Machine for compressing air.

g. Pressure regulator.

oo. Distributing openings with stop-cocks.

Fig. 66. Automatic pressure regulator (Delaneare's system).

Fig. 67. View of the movable appa-

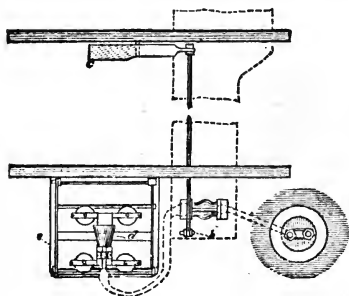

Fig. 72.

ratus called a "swan neck," which serves for blowing gas and lamp chimneys, bottles, etc.

Fig. 68. Side view of the same apparatus.

Fig. 69. General arrangement of mirror rollers.

a. Distributing plane for the compressed air.

b. Distributing cock turned by treadles.

cc'. Treadles upon which the workman places his foot.

d. Distributing pipes.

f. Compensation roller, which, according to need, permits the shortening or lengthening of the rubber pipe.

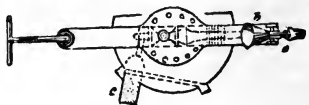
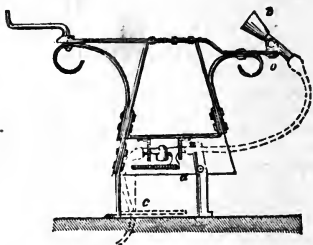

Figs. 73 and 74.

Fig. 70. Side view of this apparatus.

Fig. 71. Glass-blower's bench. Side view.

Fig. 72. Ground-plan of the same.

a. Vessel containing compressed air.

b. Cock for decreasing pressure, which is turned by the treadle c.

d. Nozzle into which the workman inserts his blowing-pipe.

e. Frame with hinge-joints, in which moves the roller arrangement carrying the air-nozzle.

Figs. 73 and 74. Apparatus for "free blowing," for the manufacture of lampshades, flasks, and retorts.

a. Distributing cock turned by means of the pedal c.

b. Nozzle movable around the shaft o, which allows the pipe to assume all positions in a vertical plane.

Cutting Glass with a Carbon Pencil. The carbon pencils are made according to different receipts, of which we give three:

1. Dissolve 100 parts of gum-Arabic in 240 parts of water, and mix the solution with a paste prepared by triturating 40 parts of powdered gum tragacanth with 640 parts of hot water. Then, having dissolved 20 parts of storax and 20 parts of benzoin in 90 parts of alcohol, strain the latter solution and add to it the mixed mucilage. Finally mix the whole intimately with 240 to 280 parts of powdered charcoal, so as to be uniform throughout. The charcoal should be previously passed through a fine sieve. The doughy mass is cut into suitable pieces, which are rolled between two boards dusted over with coal dust until cylindrical strips about $\frac{1}{4}$ inch in thickness are formed, which are allowed to dry slowly between blotting-paper. When using them, one end is pointed like a lead-pencil, and, after having previously made a scratch in the glass with a file or diamond, the heated and glowing end of the pencil is carried along the line in which the glass is intended to be fractured.

2. Dissolve 8 to 10 parts of gum tragacanth in about 100 parts of hot water, add to the mixture, with constant stirring, 30 parts of acetate of lead and 60 parts of finely-sifted beach-wood charcoal, and proceed as in the previous receipt.

3. Sticks of soft wood (willow or poplar) of about the thickness of a finger, and thoroughly dry, are immersed for about one week in a concentrated solution of acetate of lead, after which they are again dried. When ignited these sticks burn like glaziers' charcoal.

The first receipt yields the best product, as it burns much slower than the others. These pencils maintain a more uniform heat than a hot iron which is constantly getting cold.

Etching Ink for Glass. Equal parts of hydrofluoric acid, fluoride of ammonium, and dry precipitated barium sulphate are rubbed together in a porcelain mortar. When intimately mixed, the mass is transferred to a dish made of platinum, lead, or gutta-percha, and fuming hydrofluoric acid poured over it successively and rapidly stirred with a gutta-percha rod, shaped like a pestle, until the impression left

by the rod quickly vanishes. The resulting fluid can be applied with an ordinary steel-pen, and the glass written on is etched immediately, the etched portions being so beautifully roughened that they are visible at a long distance. The ink only needs to act for 15 seconds on the glass, and a longer action may cause the edges to lose their sharpness.

The ink cannot of course be kept in glass bottles, but only in gutta-percha vessels closed with corks protected with wax or paraffine. Owing to its greater specific gravity the barium compound used to thicken it settles; hence the bottle must be well shaken each time before using.

In making good etching ink the quality of the barium sulphate is of great consequence. It is best prepared by precipitating barium chloride with an excess of sulphuric acid, washing well by decantation, filtering, and drying at 248° F. It is only in this manner that it can be obtained sufficiently fine and impalpable. Concentrated hydrofluoric acid may cause serious inflammation and even ulcers if left in contact with the skin for some time, so that care should be taken, both in making and using the ink, not to touch it to the fingers.

To make ordinary etchings more distinct and visible at a greater distance it is frequently necessary with delicate lines, especially on graduated chemical ware, burettes, endimeters, etc., to rub some clay, red lead, or soot over them. A small quantity adheres to the roughened surface, but it soon rubs off. The etchings made with this ink are so much rougher that if a strip of metal is rubbed over the lines some will adhere, and they acquire the color and lustre of the metal. If a name is written on glass with this ink and the spot rubbed with a thick brass wire, the name will appear in golden letters, and may be protected by a thin coat of colorless varnish. Lead may also be used, but for chemical apparatus platinum is preferred, as it easily rubs into the lines and requires no protective coating.

Glass with Copper Lustre. Pins with glass heads of a beautiful coppery appearance are found in commerce. The glass used for such heads is composed of

45 per cent. of fine quartz sand containing some ferric oxide and lime (so-called silver sand), 36 per cent. of minium, 11 per cent. of soda, 2 per cent. of saltpetre, 3.25 per cent. of pyrolusite, 2.5 per cent. of cupric oxide, and 0.25 per cent. of crystallized bismuth nitrate.

Mix the ingredients thoroughly and, after melting in a clay crucible, stir the melted mass and keep it in flux for some time. The resulting product when cold is a nearly black transparent glass, which can be easily shaped into pin-heads and fastened to steel pins by melting in the blast lamp. The heads show at first the dark appearance of the glass, but by bringing the melted glass mass, when no longer at a red heat, into the interior of the blast flame, it acquires in a few seconds the appearance and lustre of polished copper.

Lead-pencils for Glass and Porcelain. *A. Black Pencils.* Ten parts of best lampblack, 40 parts of white wax, and 10 parts of suet.

B. White Pencils. Forty parts of Kremser white, 20 parts of white wax, and 10 parts of suet.

C. Light-blue Pencils. Ten parts of Berlin blue, 5 parts of white wax, and 10 parts of suet.

D. Dark-blue Pencils. Fifteen parts of Berlin blue, 5 parts of white wax, and 14 parts of suet.

E. Yellow Pencils. Ten parts of chrome-yellow, 20 parts of white wax, and 10 parts of suet.

The coloring material is mixed with the heated wax and suet, the mixture ground and sufficiently dried in the air to allow of its being pressed into round pencils by means of a hydraulic press, and treated like ordinary lead-pencils. After pressing, the pencils are dried in the air until they have acquired sufficient solidity to be glued into wooden cases.

Lithium Glass. Lepidolite is continuously heated 6 to 8 hours, without, however, being allowed to fuse, then cooled in water and converted into a fine powder, which is melted in clay pots like ordinary glass material and worked into glass. All fluxes, clarifying material, and coloring matters used in the manufacture of glass can be added as required or desired.

Manufacture of Plate Glass. The following is one of the formulæ generally employed: Silica 78 parts, potash 2, soda 13, lime 5, alumina 2. The materials in a comminuted form are fused in crucibles or pots, exposed to an intense heat in a furnace, complete fusion requiring about 20 hours. From the pots it is ladled into a cistern, called the cuvette, which is also placed in a hot furnace, where it remains until the glass is fired and in proper condition to flow readily and equably. When this is the case the cuvette is lifted out of the furnace by means of tongs and hoisted on to a carriage by which it is moved to the casting table. It is then skimmed to remove impurities from its surface, and hoisted by a crane immediately over the casting table. The casting table is surrounded by side and end ledges corresponding in depth to the thickness of the plate to be made, to prevent the escape of the liquefied glass which is poured upon it by tilting the cuvette. During the pouring a washer is drawn immediately in front of the glass to remove any dirt from the casting slab, and when this has been covered to the requisite depth a heavy copper roller is drawn over the surface of the glass, causing it to exhibit a beautiful iridescent play of colors; this roller flattens its upper surface and causes an excess of the metal to be thrown off at the end of the table, where it is received in a trough of water.

A thick flange of the glass is turned up at the end of the plate, to which, when somewhat hardened, a rake-shaped iron is applied, by which it is forced into the annealing oven, or upon a carriage by which it is conveyed to the oven. As the plate is yet plastic, its under side takes an impression from the bricks of the oven, while the upper surface, though smooth, is uneven; it consequently requires to be ground and polished. After remaining in the oven about 5 days, and being allowed to cool gradually, it is carefully examined to see if it will admit of being finished as a single plate, or whether it has flaws or knots which necessitate it being cut into smaller pieces. If the latter be the case the defective portions are cut out and the remainder serves for plates of less size. In either

case the plates are embedded in plaster-of-Paris upon stone tables about 8 feet wide and 15 feet long. The tables are arranged in pairs at about 10 feet distance apart.

Other plates of glass are cemented to the under surfaces of the two swing-tables or runners, which by means of a horizontal frame between each are caused to traverse backward and forward, a circular motion being at the same time imparted by means of a vertical crank shaft pivoted to the central and upper part of the table and actuated by bevel-gearing; four other cranks, one at each corner of the frame, serve to guide and limit its motion, causing its central point to describe a circle about 4 feet in diameter, so that different portions of the faces of the upper and lower glass plates are continually applied to each other. Sharp river-sand sifted into two different sizes is used as an abradant; when the surface of the lower plate has been ground quite flat by the coarser sand, it is removed by careful washing, and the finer sand substituted for it; to this succeeds emery powder, a coarser and then a finer quality being applied, the glass being thoroughly washed previous to each change of material, so that none of the coarser particles previously used may remain to cause scratches on its surface. The plates are then inverted and the same process is repeated on the other side. For this purpose the frame above described is suspended by chains, which admit of its being raised from the surface of the lower table. These machines do not permit the use of very fine emery, as their weight and velocity at such near proximity as they would necessarily be would tear the surface of the glass; the velocity is consequently reduced when the finer emery is employed, and a different machine worked by hand-power is used for the final smoothing, preparatory to the process of polishing. This is effected upon stone benches about 2 feet high, having plane upper surfaces which are covered with wet canvas. Upon this one of the larger plates is laid, the wetted surface of the canvas serving to retain it in its place. A smaller plate is used as a grinder or runner; if this be of such size that a

uniform pressure of it cannot be imparted to it by hand, leaden weights are distributed over its surface. Emery powders of gradually increasing fineness are applied with water, and the runner is traversed back and forth by hand with a semicircular stroke, its path being slightly changed at each stroke, while the runner itself is gradually turned around as on an axis during the progress of the work. These combined movements serve to evenly distribute the emery, and insure an equal amount of grinding, both to the bed-plate and runner.

About six sizes of carefully washed emery are used in smoothing, and between each change the plates and everything about the apparatus are carefully washed, including the hands of the operators. The fine emery powder last employed imparts a very smooth surface to the plates, which are now ready for polishing. The polishing machine has a bed mounted upon rollers, and traversed slowly back and forth sideways by a rack and pinion beneath. Two carriages supported on wheels on each end, which run on rails at each end of the table, have a reciprocation of about 2 feet by means of two opposed cranks, so that one advances while the other recedes. They are placed about 4 feet apart, and to their under surfaces are attached rubbers having sockets in their upper parts into which bars with rounded ends on the under side of the carriage are fitted, allowing a certain freedom of motion independent of each other; they measure 6 × 8 inches, are placed at distances of 1 foot apart, and their faces are covered with thick felt. By the reciprocating motion of the carriage and the transverse movement of the bed they are caused to act on every part of the surface of the glass, a sufficient pressure being imparted to each by weights.

The powder generally employed in polishing is "Venetian pink," a substance containing a small proportion of oxide of iron mingled with earthy matter. It is used with water, which reduces the friction and prevents the glass from becoming heated. Tripoli, crocus, and putty powders, when used with water, cut too actively to produce a high polish in this way; though

they are employed dry for the last finish in hand-polishing, the amount of surface acted on, with the velocity and power of the machinery, would render these liable to tear the surface of the glass, besides exposing it to the contingency of being broken by the heat evolved.

Ornamenting Frosted Glass. A method of ornamenting frosted glass for those who cannot draw is to choose some pretty pattern of lace curtains, lay it smoothly on thin paper, and with a pencil trace the outlines. Then, after making as many layers as you require patterns, cut out the designs at one time through the several layers of the paper with a pair of sharp-pointed scissors. Fasten the patterns with tacks to the frame around each pane of glass you wish to decorate. Tie up a piece of putty in a piece of thin muslin, leaving enough of the latter to hold instead of a handle. With this dabble all over that part of the glass which the pattern leaves bare. When the putty on the glass has dried, remove the paper and varnish the glass.

To Transfer Photographs to Glass. Separate the paper print from the background by steaming it, dry thoroughly and, having given the warmed glass an even coating of balsam or negative varnish, place the face of the print on the surface thus prepared. Smooth it out and let it stand in a cool place until the varnish has hardened. Then apply water, and with a soft piece of gum rubber rub off the paper so as to leave the photographic image on the varnished glass.

Platinizing Glass. In order to succeed in coating porcelain or glass with a perfectly faultless film of platinum of the brilliancy of silver it is indispensable to make use of a perfectly dry chloride of platinum, as free from acid as possible. To that end pour some oil of rosemary over the perfectly dry chloride of platinum in a small porcelain mortar and knead it up with the pestle, renewing the oil about three times; and continue this operation until there is produced from the brownish-red chloride a black plastic mass, wherein no particles of undecomposed chloride of platinum can be found. The oil of rosemary assumes

hereby a more or less yellow color, in consequence of partially taking up chlorine from the chloride of platinum. When the whole of the chloride of platinum is thus reduced, and after pouring the oil of rosemary off, rub it up well with the pestle with about five times its weight of oil of lavender until it has become a perfectly homogeneous, thin fluid. Then after leaving it to stand for half an hour or so apply the mass as uniformly as may be and in the thinnest possible layer to the object of porcelain, earthenware, or glass by means of a soft, delicate brush. The thinner the coat of the application the more brilliant the film of platinum. All that is required further is to subject the articles for a few minutes to a very low, scarcely perceptible red heat, either in a muffle or in the flame of a Bunsen's gas-blowpipe used with caution. The articles receive from this baking a beautiful lustre as brilliant as silver. If, by an oversight, the coating of platinum upon the articles has turned out faulty, or if breakages occur during the baking, every trace of the metal can be recovered from the objects. Nothing more is required than to pour common hydrochloric acid over them and then touch them with a zinc rod. In consequence of the hydrogen evolved, both at the upper and lower surface of the film of platinum which acts as the negative pole, the shining metallic coating instantly peels off in the form of extremely thin leaves from the base of porcelain or glass and, notwithstanding the specific gravity of the metal, these ascend partially and float on the surface of the acid. On separating the hydrochloric acid by the use of a filter the whole of the platinum is recovered. One should prepare only as much of the platinizing fluid as is required for immediate use, as it loses in efficiency by keeping.

Toughened Glass. In this process the red-hot glass is dipped into a warm bath consisting of water and starch, or gum kept at 212° F. It is taken out again when the red glow has almost gone, and is then allowed to cool in an oven kept at a slightly lower temperature than the glass. Any article of glass can be treated by this method,

and the glass can be cut by a diamond or ground, etc., with sand, and is quite as tough as glass prepared by the "oil process."

HORN-COMBS, MANUFACTURE OF.

The first operation is to cut the horn in such a manner that when opened it shall be of rectangular shape. This cutting involves the loss of several large pieces and also of the tips so far as comb-making is concerned; but the pieces are sold to manufacturers of other commodities, so that the total loss is comparatively small. To assist the action of the knife the horn is heated to a certain degree over a fire, by the side of which the operative sits. When cut the horn is often softened and opened by tongs, and placed between screw-plates, wherein, under the influence of a strong pressure, the pieces are flattened out. It is a characteristic of horn to remain when cold just as it is shaped when warm; so that, when the pieces are removed from the screw-plates, they do not warp or curl up again. Such pieces as are intended to be used for imitation tortoise-shell are subjected to an enormous pressure between heated and oiled iron plates. This heavy pressure, however, weakens the horn and renders it liable to split. Omitting the drying process, the next operation is to cut the pieces into suitable sizes and shapes for combs; and, after that, the teeth are cut. Originally this was done by hand; now it is done by circular saws, some of which are so fine and thin as to cut from 70 to 80 teeth per lineal inch. They revolve at a very rapid rate, but, instead of travelling up to the horn, the horn travels up to the saw. After each cut the horn is automatically moved forward the exact breadth of a tooth, and it is possible to arrange that a fine or a coarse tooth shall be cut at pleasure.

There is a second method of cutting the teeth by which a pair of combs is made from a single plate of horn; what is cut out to form the tooth of one comb being utilized to form the tooth of the second comb, which lies immediately opposite to the first. This may be un-

derstood by dovetailing two combs into each other. The two end teeth, being thicker than the others, show a gap when the two combs are separated; but a little warming and a slight bending make that unsightliness disappear. The cutting in this case is done by a pair of chisels, which travel fast or slow, as may be required, according to the character of the teeth to be cut, each chisel descending alternately.

After the tooth-cutting, the combs are next thinned or tapered down to their outer edges. This is done on grindstones; and in due succession the teeth are rounded, pointed, or bevelled, as the case may require, by a special kind of file or rasp. If it is necessary to treat the horn to make it an imitation of tortoise-shell, the object is effected by first applying dilute nitric acid, which imparts a light yellow tinge, and afterwards by dropping over certain spots a composition containing caustic soda, litharge, and dragon's-blood. After some time the composition is washed off, but the spots beneath it are found to be slightly swollen up, and stained a deep orange tinge. It then only remains to polish the combs, whether they are in plain horn or in imitation tortoise-shell. This is done by first sandpapering to get a smooth surface, then buffing on leather wheels, and finally polishing on wheels made up of circular pieces of calico with frayed edges, which, though soft in themselves, do the work of polishing very well when rapidly revolved.

LUBRICANTS, BLACKING, ETC.

Belt Grease. To prevent belts from slipping from the pulley the following preparation is highly recommended: Prepare a soap by boiling 9 parts of linseed oil with 4 parts of bolted litharge, with an addition of a small quantity of water, until a sample taken from the boiler shows the consistency of plaster. This is ascertained by allowing a few drops of the boiling mass to fall into cold water, and testing with the thumb and forefinger whether the mass is still smeary or can be twisted into a small ball. If the latter is the case, it is taken from the fire, allowed

to cool somewhat, and sufficient of a mixture of equal parts of rape-seed oil and oil of turpentine or petroleum is added to make a mass of the thickness of cream.

Caoutchouc Lubricant for Driving-belts. One-half pound of rubber in small pieces and $\frac{3}{4}$ pint of oil of turpentine are brought into an iron boiler, tightly covered with a lid, and gently digested over a coal fire, until the rubber is melted. Then add 14 ounces of rosin, stir thoroughly, melt again, and add in the same manner 14 ounces of yellow wax. Stir the mass occasionally while melting. Next heat in a large pot 3 pounds of fish oil and $\frac{1}{2}$ pound of tallow until the tallow is melted, and then add with constant stirring the first mixture, while still hot. Continue stirring until the mass solidifies. For use, the lubricant is applied with a brush to both sides of old, cracked belts, in the sun or a warm room, and allowed to dry. The durability of new or good belts is much increased by an occasional application, while running, of a small quantity of the lubricant. Instead of caoutchouc, old rubber waste can also be employed, but it must first be boiled with soda-lye for $\frac{1}{2}$ to $\frac{3}{4}$ hour, and instead of $\frac{1}{2}$ pound about $\frac{3}{4}$ pound must be used.

Harness Grease. Ammonia soap 4 parts, palm oil 1 part, ordinary hard soap 3 parts, solution of tannin (9 to 16 parts of tannin in 4 of water) $1\frac{3}{4}$ parts. Melt the oil and soap together, add the ammonia soap, then the tannin solution, and stir thoroughly. The preparation will keep for some time if kept in stone bottles well corked. In greasing, no more grease should be used than the leather will absorb.

The ammonia soap used in the preparation is made by heating oleic acid to the boiling point and adding sesquicarbonate of ammonium until the odor of ammonia no longer disappears.

Harness Polish. Four ounces of glue, $1\frac{1}{2}$ pints of vinegar, 2 ounces of gum-Arabic, $\frac{1}{2}$ pint of black ink, and 2 drachms of isinglass. Break the glue in pieces, put it in a basin, and pour over it about 1 pint of the vinegar; let it stand until it becomes perfectly soft. Put the gum-Arabic in another vessel, with the ink, until it is entirely dis-

solved; melt the isinglass in as much water as will cover it, which may be easily done by placing the cup containing it near the fire about an hour before it is wanted for use. To mix them, pour the remaining vinegar with the softened glue into a dish over a moderate fire, stirring it until it is entirely dissolved, being careful not to let it reach the boiling point, that it may not burn the bottom, about 182° F. being the best heat. Next add the gum; let it arrive at about the same heat, and then add the isinglass. Take from the fire and pour it off for use.

To use it put as much as required in a saucer, heat sufficiently to make it fluid, and apply a thin coat with a dry sponge. If the article is dried quickly, either in the sun or by the fire, it will show the better polish.

Thurston's Machine for Testing Lubricating Oils. Prof. R. H. Thurston, whose investigations on this subject are of much importance, has devised several machines for the determination of the value of lubricating oils. The form shown in Fig. 75 is designed for testing oils used in railway service, and for all other purposes where it is important to reduce to a minimum the friction of bearing surfaces under heavy pressures. With its use it is possible to determine which is the best and consequently the cheapest oil for lubricating purposes, a matter of great importance in respect to the question of the economical use of power. The principle of the machine will appear from the following description, viz.: It comprises a spindle revolved in horizontal bearings by a belt from the main shaft of the workshop. On the overhanging end of this spindle is formed a journal, from which is hung a heavily-weighted rod. The two halves of the bearings in this rod by which it hangs on the journal are pressed down upon the journal with any desired pressure by means of a spiral spring placed in the centre of the rod. The weight of this pendulum prevents it revolving along with the spindle, but the friction at the journal deflects the pendulum from the vertical through an angle whose line is a measure of the frictional effort. There is also inserted in the bearings a thermometer, by which the effect of the friction in

increasing the temperature is observed.

With this machine Prof. Thurston has obtained extremely interesting re-

In the form of the machine here shown, the journal, which is master car-builders' standard, $3\frac{3}{4}$ inches diameter, is a hardened steel sleeve, ground

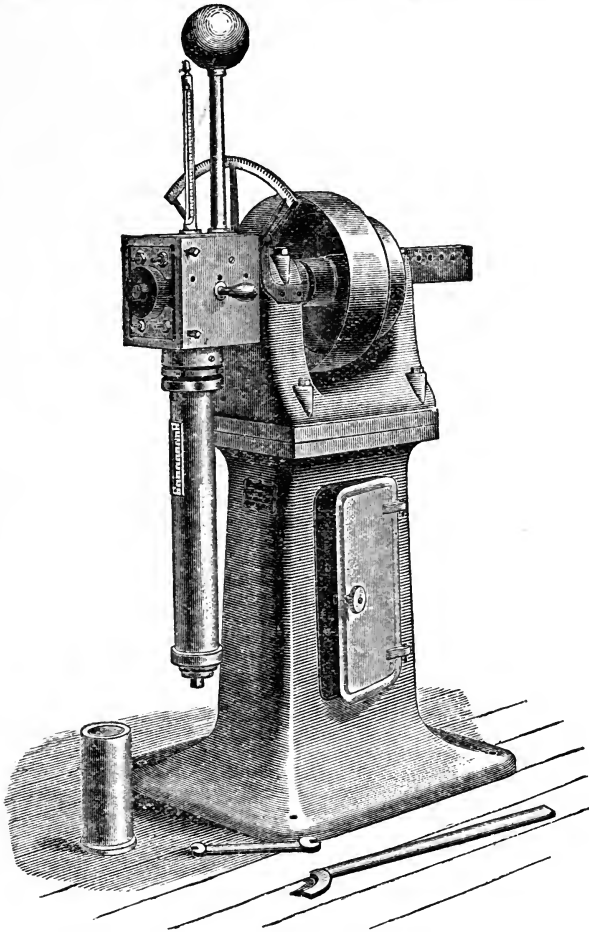

Fig. 75.

sults regarding the variation of the coefficient of friction with temperature, pressure, and velocity of rubbing.

truly cylindrical. The boxes in which this journal runs are of phosphor-bronze, and are designed for internal

water circulation. A late improvement includes a thin lining of phosphor-bronze or other metal ordinarily used, which can be accurately weighed before and after a test, determining the percentage of wear for any given mileage. By being made interchangeable these linings can be renewed at any time, or special linings of any other metal or alloy may be inserted, using the same water brasses.

Pressures up to 9000 pounds are obtained by the use of a heavy helical spring secured within a 4-inch wrought-iron pendulum tube. By a convenient taper-key adjustment (not shown in the cut) the pressure may be easily and quickly relieved for removal of the pendulum and brasses from the journal, without release of pressure of the spring within the tube.

The standard boxes may be replaced by the ordinary brasses used in regular railway service if desired, thus imitating the actual conditions of practice. The graduated arc on which the friction is indicated is conveniently placed above the pendulum. The standard thermometer used is graduated from 40° to 350° F. A positive automatic revolution-counter which reads up to one million is attached, enabling the experimenter to determine the comparative mileage run. The apparatus may be speeded to correspond to the rates usual for trains by suitable provision of counter-shaft and cone pulleys. This machine, including the counter-shaft, weighs 1125 pounds, and is manufactured by the Pratt & Whitney Company of Hartford, Conn. (W.)

Lubricants. Admixtures of mineral oil with animal oil lessen the liability of the latter to spontaneous combustion. A series of experiments, which were made to test the inflammability of such mixtures, by saturating balls of cotton waste with oil and measuring the increase in temperature, showed the following results: With pure lard oil the temperature increased to 428° F. in 4 hours; with pure neat's-foot oil to 446° F. in 6 hours, and in $\frac{1}{2}$ hour more the cotton was converted into glowing coal. With a mixture of 50 per cent. of pure mineral oil and 50 per cent. of neat's-foot oil the temperature did not increase to over 214° F.

in 7 hours. A mixture of 75 per cent. of neat's-foot oil and 25 per cent. of mineral oil became heated to about 425° F. in 6 $\frac{1}{2}$ hours, and gave off an odor of burning. With 67 per cent. of neat's-foot oil and 33 per cent. of mineral oil the highest temperature attained was 214° F. and the cotton showed no trace of charring. According to these experiments it would seem that, if it is desired to give mineral oil greater tenacity and consistency for certain purposes, a mixture of 67 per cent. of neat's-foot oil and 33 per cent. of mineral can be considered as entirely safe.

Purification of Lubricants after Use.

Dissolve 2 $\frac{1}{2}$ parts by weight of potassium chromate, 2 parts of calcined soda, 2 $\frac{1}{2}$ parts potassium chloride, and 5 parts of common salt in a wooden vat. Bring into this 1000 parts of the oil to be purified previously heated to about 167° F., and after stirring thoroughly for 10 to 15 minutes let it stand quietly 8 to 10 days in a warm place. At the end of the time draw the clear oil off by means of a cock on the vat.

Used lubricants can also be purified in the following manner: Heat 1000 parts by weight of the oil to be purified to about 167° F. and add with constant stirring a mixture of 10 parts by weight of concentrated sulphuric acid and the same quantity of 96 per cent. alcohol. After 24 to 48 hours rest the oil is drawn off from the sediment and, to remove all traces of sulphuric acid, washed with boiling water.

New Receipts for Blacking. No. 1.

Melt 90 parts by weight of beeswax, 30 of spermaceti, 350 of oil of turpentine, and 20 of asphaltum lacquer, and mix with 10 parts by weight of borax 20 of lampblack, 10 of Berlin blue, and 5 of nitro-benzole.

No. 2. Dissolve 150 parts of wax and 15 of tallow in a boiling mixture of 200 parts of linseed oil, 20 of litharge, and 100 of molasses. Heat to 230° to 248° F. with an addition of 100 parts of lampblack. When cold dilute with 280 parts of linseed oil and mix with a solution of 5 parts of gum-lac and 2 of aniline violet in 25 of alcohol.

No. 3. Mix intimately 6 parts of fine bone-black, 28 of syrup, 4 of sugar, 3 of train oil, and 1 of sulphuric acid,

and allow the mixture to stand 8 hours. Then add with constant stirring 4 parts of decoction of tan, 18 of bone-black, and 3 of sulphuric acid, and pour into boxes.

No. 4. Boil 1 part of extract of log-wood, 30 of gall-nuts coarsely powdered with 25 of their combined weight of strong vinegar. Filter the fluid and after adding 8 parts of green vitriol allow it to settle 24 hours. Then draw off the clear liquid and mix it with constant stirring with 8 parts of gum, 100 of sugar, and 80 of syrup. Strain and add 50 parts of spirit of wine, 40 of shellac solution, and 40 of pulverized indigo.

METAL INDUSTRY.

Hardening Composition for Steel.
To the ordinary hardening composition consisting of $4\frac{3}{4}$ quarts of fish oil, 2 pounds of beef suet, and $\frac{1}{4}$ pound of wax, it is recommended to add 1 pound of rosin. Another composition consists of 95 quarts of spermaceti oil, 20 pounds of melted tallow, $4\frac{1}{2}$ quarts of neat's-foot oil, 1 pound of pitch, and 3 pounds of rosin. After melting the last two together the other ingredients are added and the mass is heated in an iron vessel until all moisture is driven out and the heated mass ignites from a burning chip of wood held over it; the flame is at once extinguished by a close-fitting lid. In using either of the methods for saw blades they are first heated in a suitable furnace and then placed vertically, teeth upward, in troughs filled with the mixture. After sufficient cooling they are taken out and wiped with a piece of leather so that only a slight film of fat remains. They are then placed flat over a coal fire until the coating of fat ignites, which may burn as freely as required for great hardness. Screws or other articles which are to receive a less degree of hardness are dipped into the hot mixture and brought to a red heat.

Iridium, its Preparation and Use.
With the exception of alloying with platinum the principal use of iridium up to the present time has been for pointing gold pens. The iridosmine, called by the manufacturers "diamond

point," consists simply of a grain of iridium soldered on the point of the pen, which is afterwards sawed in two to make the two nibs and ground into proper shape.

For preparing larger pieces of iridium than found in nature for making points for the Mackinnon stylographic pen, Mr. John Holland, of Cincinnati, has devised the following ingenious process: The ore is heated in a Hessian crucible to a white heat, and after adding phosphorus the heating is continued for a few minutes. In this manner a perfect fusion of the metal is obtained which can be poured out and cast into any desired shape. The material is about as hard as the natural grains of iridium, and in fact seems to have all the properties of the metal itself.

For making points for the Mackinnon pen, the fused metal is poured between two iron plates which are kept apart a proper distance so as to make a sheet of iridium of the desired thickness. To obtain very compact castings, the plates are brought suddenly together, on the plan of a closed ingot with a hinge, so that as the metal cools it is subjected to great pressure. The sheets required for the Mackinnon pen are about $\frac{1}{2}$ inch in thickness, and are cut up into small irregular pieces, which are soldered on a strip of bronze and ground down to a flat surface upon a copper lap. Corundum or diamond dust mixed with oil is applied to the flat surface of the lap by means of a flat steel instrument, upon which pressure is applied in order to force the corundum or diamond dust into the copper, thereby making a cutting surface. The lap makes about 800 to 1000 revolutions per minute. After the pieces are ground to a surface they are first countersunk by means of a diamond drill making about 900 revolutions per minute. After countersinking the iridium is finally pierced by means of a copper wire held by a suitable drilling apparatus, which makes about 3500 revolutions per minute. Some corundum or diamond dust and oil are put in the countersunk opening in the iridium and then it is held up against the piece of revolving copper.

The holes having been drilled, the

strips of bronze to which the pieces of iridium were soldered are dissolved by means of nitric acid, and the pieces of iridium are then soldered in proper position to the end of a Mackinnon pen. The iridium is then ground to a proper shape upon an apparatus consisting of three or more copper cylinders on a common spindle making about 3500 revolutions per minute. The operation of sawing the iridium is carried on by means of a copper disk from 4 to 8 inches in diameter, made of soft thin sheet-copper, held between two clamps and placed on a spindle revolving at the rate of about 2500 revolutions per minute. It revolves in a box which contains corundum or diamond dust and cotton-seed oil.

Phosphor-iridium, as this metal may be called, possesses some very remarkable properties. It is as hard, if not harder, than iridosmine from which it is prepared. It is somewhat lighter, owing to its percentage of phosphorus and increase of volume. It is homogeneous and easy to polish, and forms some alloys impossible to prepare in any other manner. It combines with small quantities of silver and forms with it the most flexible and resisting alloy of silver. With gold or tin no alloy has thus far been obtained. Added in small quantities to copper it furnishes a metal possessing very small resistance to friction, and especially adapted for articles subjected to great pressure. This alloy seems to possess more than any other metal the power of retaining lubricants. With iron, nickel, cobalt, and platinum, phosphor-iridium forms combinations in all proportions, which are of great importance. With iron an alloy is obtained which retains the properties of phosphor-iridium, although its hardness decreases with a larger addition of iron. The alloy is slightly magnetic, and is not attacked by acids and alkalis, and the best file produces no effect upon it even if it contains as much as 50 per cent. of iron. With more than 50 per cent. of iron the power of resistance decreases gradually and the nature of the metal approaches that of iron.

In casting phosphor-iridium it is observed that the mould fills up better after a second and third fusion.

The most difficult objects are obtained with the aid of open or closed iron or steel moulds, which are previously heated to prevent too rapid cooling. By fusing the phosphor-iridium several times, a part of the phosphorus evaporates, and the melting point becomes higher. If heating is continued too long, the metal does not fuse, and phosphorus must be added in order to give it its former properties. The process of removing the phosphorus after casting is as follows: The metal to be dephosphorized is placed upon a perforated fire-resistant bed upon the bottom of the crucible and surrounded with powdered lime, and then heated for some time to a red heat. The phosphorus combines with the lime and forms a green slag which collects upon the bottom of the crucible. After some time the crucible is taken from the fire and the metal, after cooling, is once more treated in the same manner in another crucible. The temperature is gradually raised until the metal is completely dephosphorized.

Cowles' Electric Furnace. The Cowles Brothers, of Cleveland, Ohio, have lately invented a process of reducing the refracting ores of many metals by electrical means, which promises to become very important in the arts. They construct a rectangular box of fire-resisting material, lined with a mixture of fine charcoal and lime. It has a removable cover, which is perforated with openings to allow the escape of gases evolved. In the sides of this furnace the electrodes—2 plates of gas carbon—are let in, by means of which the current of a powerful dynamo-electric machine is introduced. The charge consists of a mixture of the coarsely crushed ore and coke fragments. The essential feature of the process consists, therefore, in employing in the furnace a substance like carbon whose high resistance to the passage of the current causes the production of a prodigiously high temperature, and which at the same time is capable of exercising a powerful reducing action on the ore. With such an arrangement of apparatus, and by the use of a powerful electric current, the inventors have succeeded in reducing aluminium from corundum, boron from boracic acid,

and silicium from quartz. They have greatly cheapened the cost of aluminium-bronzes and brasses, and, it is expected, will be able to produce pure aluminium in quantity at much lower prices than it has heretofore been possible to produce it. (W.)

Refining Nickel (Fleitmann's Process.) Dr. Fleitmann, of Iserlohn, has devised a very simple and successful process of refining and toughening nickel, which is now very largely used. It produces a very homogeneous metal from which castings may be made with much less liability to the presence of blow-holes than with other methods. Fleitmann's procedure consists in adding to the molten charge, in the pot, when ready to pour, a very small quantity of magnesium. The magnesium is added in small quantities at a time and stirred into the charge. About one ounce of magnesium is found to be sufficient for purifying 60 pounds of nickel. The theory of the operation is that the magnesium reduces the occluded carbonic oxide, uniting with its oxygen to form magnesia, while carbon is separated in the form of graphite. The nickel refined by this method is said to become remarkably tough and malleable, and may be rolled into sheets and drawn into wire. Cast plates (intended for anodes in nickel-plating), after reheating, can be readily rolled down to the required thickness, which greatly improves them for plating purposes, as they dissolve with greater uniformity in the plating-bath. Nickel so heated may be rolled into sheets as thin as paper, and has been successfully welded upon iron and steel plates. (W.)

Wrought-iron (or Mitis) Castings. Ostberg, a Swedish inventor, has lately devised an ingenious process of making castings (clean and sharp) of wrought-iron, by taking advantage of the observation which he made that the addition of an extremely small quantity of aluminium to wrought-iron, kept at a white heat in a crucible, forms a combination which has a much lower point of fusion than wrought-iron.

When wrought-iron is heated in crucibles until it has become pasty, the aluminium in the form of an alloy of iron and aluminium is introduced.

The mass almost instantly becomes thinly fluid—the fusion point of the resulting metal being lowered about 500° F. The surplus heat which it now contains, beyond that required for fusion, is sufficient to keep it thoroughly fluid during the operation of casting. The addition of aluminium required to produce this remarkable effect does not exceed $\frac{1}{10}$ of one per cent. The process bids fair to become valuable. (W.)

Mechanically Hardened Steel. A bar of steel heated to a cherry-red is placed in a space enclosing it accurately and subjected to an enormous pressure by means of a hydraulic press. It is then allowed to cool under pressure, when it will be found that the steel has acquired a high degree of hardness and is very much inclined to become strongly magnetic. Magnets prepared according to this method possess an extraordinary power of resistance, and are already used for telephones. Steel hardened by pressure is also very suitable for edge tools, and finally the degree of hardness can be modified at pleasure by regulating the pressure.

New Solder for Metal, Glass, and Porcelain. A soft alloy which adheres to metal, glass, and porcelain, and can be used in the same manner as soft solder, is prepared from finely-powdered copper—copper dust—which is obtained by shaking a solution of blue vitriol with granulated tin. The solution becomes considerably heated, and a fine brown powder is precipitated. Of this copper dust, 20, 30, or 36 parts by weight, according to the desired hardness of the solder, are mixed in a cast-iron or porcelain mortar with sulphuric acid of 1.85 specific gravity to the consistency of paste, and 70 parts of mercury added with constant stirring.

When the amalgam is thoroughly mixed, it is carefully washed with water to remove all traces of acid, and then cooled off. In 10 to 12 hours the mass becomes harder than tin. When the solder is to be used, it is heated to 1300° F., and can be kneaded like wax in an iron mortar. In this plastic condition it is applied to the surfaces to be joined and the latter pressed together. After cooling, the solder is hard and adheres very firmly.

Oxidized Silver. Solution of penta-

sulphide of potassium (liver-of-sulphur of the shops) is generally used for oxidizing silver. Liver-of-sulphur is prepared by intimately mixing and heating together 2 parts of thoroughly dried potash and 1 part of sulphur powder. Dissolve 2 to 3 drachms of the compound in $1\frac{1}{2}$ pints of water, and bring the liquid to a temperature of from 155 to 175° F., when it is ready for use. Silver objects, previously freed from dust and grease with soda-lye and thorough rinsing in water, plunged in this bath are instantly covered with an iridescent film of silver sulphide which in a few seconds more becomes blue-black. The objects are then removed, rinsed off in plenty of fresh water, scratch-brushed, and, if necessary, polished. It is advisable to use the oxidizing liquid as soon as prepared. After it has been used for some time, the deposit becomes dull and gray and lacking in adherence. There is danger in using the alkaline liquid too strong; the coating will form quicker, but does not adhere as well.

The process is very readily executed upon pure silver, but with articles of cupriferous silver the result is not quite so beautiful, and it is therefore advisable to subject them to blanching before oxidizing.

A velvety-black color is obtained by dipping the article previous to oxidizing in solution of mercurous nitrate, by which it becomes coated with a thin film of mercury, which forms a silver amalgam with the silver. When brought into the liver-of-sulphur solution a mixture of mercury sulphide and silver sulphide is formed which is much darker than silver sulphide by itself. By dipping the oxidized article in a liquid composed of 10 parts of blue vitriol, 5 of sal-ammoniac, and 100 of vinegar, the places of the silver left bright acquire a warm, brown shade.

Another method of oxidation is effected by dipping the article in diluted chlorine water, in chloride of lime solution, or in *eau de Javelle*. The action of these baths is based upon the formation of a thin layer of silver chloride which becomes dark on exposure to light.

Beautiful effects and tasty colored designs can be produced by combining

various shades of oxidation with the bright or gilded silver surface. By executing the design, for example, with asphalt lacquer, and placing the articles in the liver-of-sulphur solution, only the places left free become oxidized, and the result, after removing the asphalt lacquer with oil of turpentine, will be a white design upon a dark ground. Dark designs upon a white ground are executed with ink prepared by thickening concentrated liver-of-sulphur solution by the addition of gum-Arabic solution. When the designs are dry, the article is heated so that the gum cracks off or can be removed by a gentle tap. Black and light designs upon a dark gray ground are carried out by executing the first with asphalt solution and the latter with ink composed of mercurous nitrate and gum-Arabic solution, and dipping the article in the liver-of-sulphur bath.

A deep black oxidized surface may be obtained directly on copper, properly cleansed, by immersion in a concentrated solution of hydrous carbonate of copper, either cold or tepid. The copper surface at once becomes coated with a fine black deposit, which will stand subsequent treatment very well. A fine oxidized surface may also be produced by depositing on the surface of the articles, or on certain portions thereof, a film of metallic platinum. For this purpose prepare a solution of platinic chloride in sulphuric ether or alcohol, and apply the solution with a brush to the parts of the surface to be oxidized. The ether or spirit speedily evaporates, leaving behind a film of metallic platinum adhering to the surface of the object, which film, according to its thickness, imparts either a steel-gray or nearly black lustre to the surface. A hot aqueous solution of platinic chloride will give the same results.

Phosphorizing Bronze or Brass. Bronze or brass wire is placed for some time in a solution of $\frac{1}{2}$ to 5 per cent. of phosphorus dissolved in ether, carbon di-sulphide, or olive oil, 5 to 10 per cent. of sulphuric acid and 85 to 95 per cent. of water. The metal takes up phosphorus. The wire is then drawn a size finer and introduced into a closed retort; the bottom is covered

with a thin layer of phosphorus so that the resulting vapors come in contact with the wire. After this the wire is packed in wood-charcoal, and ignited and heated until it softens and can be drawn a size still smaller. This treatment is alternately repeated until the wire has been reduced to the desired fineness. Wire prepared in this manner is claimed to be more indestructible, takes a higher polish, and is less subject to corrosion.

Prevention of Rusting-in of Screws.

The screws in machines exposed to heat and moist air soon rust in even if oil is used, which makes the taking apart of a machine a difficult task. By dipping the screws before putting them in place in a thin paste of graphite and oil they can be removed without difficulty even after several years.

To Mark Tools with a Name. Protect the tool with a thin layer of wax or hard tallow, by coating the heated steel with wax and allowing it to cool. When the wax is hard the name is written in it with a pointed instrument, so that each stroke penetrates to the steel. Then pour some nitric acid over the waxed surface, let it stand for a short time, and after washing off the acid with water heat the metal until the wax melts and wipe it dry. The name will appear engraved in the steel.

Utilization of Nickel Waste. For the utilization of waste from rolled and cast-nickel anodes and of the nickel sand gradually collecting upon the bottom of the vats, the following method is recommended:

Wash the waste repeatedly in clean hot water and then boil in dilute sulphuric acid (1 part of acid to 4 of water) until water poured upon the waste is no longer clouded by it. Then pour off the liquid and treat the waste or sand with concentrated nitric acid. This must be done very carefully and a large porcelain vessel should be used to prevent the solution from boiling over. When the solution is sufficiently concentrated, so that it contains little free acid, it should be filtered, and slowly evaporated to dryness over the water-bath. The product is nickel nitrate.

[The nickel nitrate thus obtained is dissolved in hot distilled water, and the

solution precipitated with caustic soda carefully and gradually added. The precipitate of hydrated nickel oxide is then carefully filtered and washed, then treated with dilute sulphuric acid with the aid of heat until solution has taken place. The solution is concentrated by evaporation and an excess of concentrated solution of ammonium sulphate is added. The precipitate is the double sulphate of nickel and ammonium, or Adams' nickel-plating salt, which is commonly used for nickel-plating.]

(W.)

Zincing Screw Bolts. To free the screw bolts from dirt and grease, place them in an aqueous solution of soda or potash-lye, and for the purpose of stirring and mixing the ingredients and raising the temperature of the bath introduce steam.

After remaining in the bath a sufficient length of time the bolts are rinsed in cold water. They are then placed in a second bath consisting of 5 parts of water and 1 part of hydrochloric acid, to remove rust, which would prevent the zinc from firmly adhering to the iron. In this bath the bolts remain until all traces of rust have disappeared, and they show a uniform gray color. The bolts are then dried and placed in a bath of zinc chloride in which the free acid has been neutralized by ammonia. The bolts are then thoroughly dried in a drying-room, care being had to avoid all contact with the atmospheric air. This precaution is not used in many shops, but experience has shown that an incomplete drying in the air exerts an injurious influence upon the lower layer of zinc, so that it adheres badly and defective places are formed in the coating. For the baths it is best to use wooden vessels, as they are not affected by the acids.

After treating the bolts in the above manner and drying as thoroughly as possible, they are placed in an iron wire basket and dipped into the melted zinc in a pot of cast or wrought-iron heated by direct firing. One of the greatest inconveniences in the use of such baskets is that the iron forms an alloy with the zinc, and the baskets soon wear out, and besides the contaminated zinc must be replaced by fresh metal. To overcome this evil

baskets of burnt clay have been recently introduced and used with success.

It is best to use large crucibles, as practical experience has shown that the zincing turns out better with large quantities of melted zinc. It is advantageous to add some tin to the zinc, which increases the whiteness of the coating in the crucible.

By quickly cooling the bolts in cold

The bolts, when taken from the bath, are treated in a revolving drum filled with sawdust, fine sand, or iron filings, to remove superficial inequalities and unevenness.

MISCELLANEOUS.

Continuously-working Furnace for the Manufacture of Animal Charcoal.

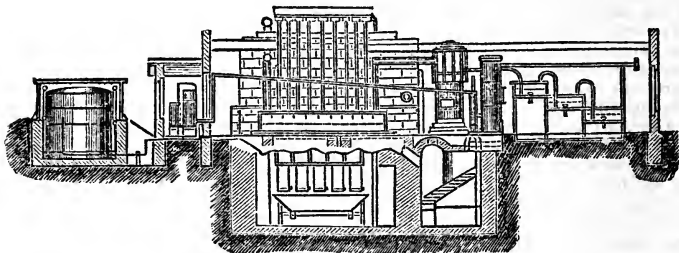

Fig. 76.

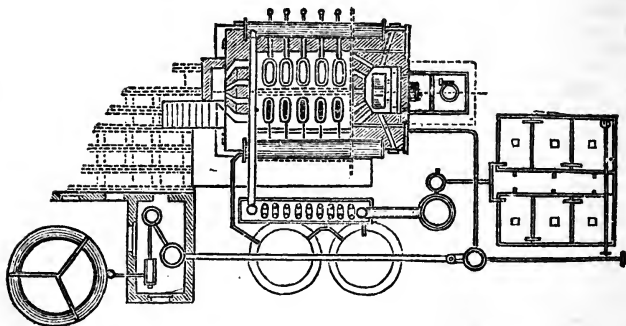

Fig. 77.

water a dull, lustreless white color is obtained. To protect the melted metal from constant oxidation some ammonium chloride, which forms a good flux, is thrown into the pot after removing the oxide layer formed in the commencement; rosin is also used for the same purpose. The time of immersion depends on the thickness of the zinc layer desired, and on the quality of the iron.

Figs. 76 and 77 represent the furnace. It is provided with an equal number of retorts of cast-iron and of fire-clay with interspaces for the passage of the heating gases. The retorts are filled without the admission of outer air through slides in reservoirs above them. The finished charcoal falls from the retorts into boxes of iron or tin, and from there, when cold, into wagons. By the circulation of the heating gases through

the hollow spaces a very uniformly burnt product is obtained. The gases pass from the furnace, which is about 8 feet wide, 10 feet long, and 7½ feet high, into a receiver and condenser, and, after cooling, into a column with milk of lime. The ammonia is absorbed by sulphuric acid in lead tanks. Two or three men are required for attendance. The furnace has a capacity of 7500 to 11,000 pounds of raw material per day, and can be built with or without gas-firing and of any size with 4, 6, 8, and 12 retorts for working horn, hoofs, blood for the manufacture of albumen, and any other animal waste, and as no disagreeable odors occur can be used in any locality.

Gilding and Silvering Leather. Thoroughly tanned leather free from all fatty substances is soaked in a medium strong bath of caustic soda for a time varying according to its thickness. When taken out it is dried and saturated with a solution of isinglass and alum. After drying in the air it is coated once or twice, according to its quality, with a mixture of 2 pounds of collodion and 1 drachm of castor oil, again dried and then treated with a weak solution of caoutchouc in benzine, after which the gilding varnish, prepared from old linseed-oil varnish boiled with litharge and Venetian turpentine, is applied. When dry so far that it is only slightly sticky the gold or other metal leaf is laid on, brushed over with a brush, and finally, to protect the gilding, coated with a solution of mastic in alcohol.

Coating Leaden Water Pipes to Prevent Contamination of the Water Supply. To avoid the contamination of drinking water by the lead of the service pipes commonly used it has been proposed to coat them on the interior with some chemical substance which will form an insoluble compound with the metal and protect it from the solvent action of the water. Several suggestions to this end have been made. One is to fill the pipes with water slightly acidulated with sulphuric acid, which will speedily form a coating of sulphate of lead on the inside surfaces—a coating which, being almost absolutely insoluble in water, should serve as a very effectual barrier against the action of

the water on the underlying metal. Another suggestion is to pass through the pipe a solution of an alkaline sulphide (such as sodium or potassium sulphide), by which a film of insoluble lead sulphide will be formed, which will answer the same purpose of protecting the underlying metal from the action of the water. Ordinarily the only danger to be feared from lead contamination is when the pipes are new and the water that is passed through them contains impurities of an organic nature, or when, on the other hand, the water is very pure. In the great majority of cases the interior of the pipes speedily becomes coated with a thin, adhesive film of lead carbonate, which protects the lead very effectually, and the alleged dangers of poisoning by the use of the lead water pipes have, in our opinion, been greatly exaggerated.

(W.)

New Floor Covering. Clean the floor thoroughly, then fill the holes and cracks with paper putty, made by soaking newspapers in a paste made of wheat flour, water, and ground alum, as follows: To 1 pound of flour add 3 quarts of water and a table-spoonful of ground alum, and mix thoroughly. The floor is then coated with this paste and a thickness of manilla or hardware paper is put on. If two layers are desired a second covering of manilla paper is put on in the same manner, and allowed to dry thoroughly. The manilla paper is then covered with paste, and a layer of wall paper of any style or design desired is put on. After allowing this to thoroughly dry it is covered with two or more coats of sizing, made by dissolving ½ pound of white glue in 2 quarts of hot water. After this is allowed to dry, the surface is given one coat of hard oil-finish varnish, which comes already prepared. This is allowed to dry thoroughly, when the floor is ready for use. This covering is cheap and durable, makes the floor air-tight, and can be washed or scrubbed.

New Process of Manufacturing Gold Wall Paper. Dissolve one part of gutta-percha and 2 parts of caoutchouc in 5 parts of benzole, and 10 parts of white rosin in 30 parts of benzine, and mix the last solution with the

first. With the lacquer thus obtained the wall paper is printed in the usual manner, the gold dust strewn upon it and the surplus shaken off. The paper is then quickly dried upon a hot steam-cylinder which effects an intimate union of the gold dust with the lacquer and gives the paper a very high and durable lustre. Such wall paper can be washed.

Phosphorescent Mixtures. The following are approved formulæ for phosphorescent mixtures which will produce light of various colors, so that after exposure to bright light all the colors of the rainbow may be shown in the dark. The mixtures must be sealed up in glass tubes and kept in the dark. If exposed for a few seconds to direct sunshine or to the light of burning magnesium and then taken into the dark, they will be luminous for a considerable time, sometimes for half an hour.

No. 1. Pulverized oyster-shells 12 parts, flowers of sulphur 4 parts, oxide of zinc 0.5 part.

No. 2. Pure calcium carbonate 12 parts, flowers of sulphur 4 parts, realgar 0.5 part.

No. 3. Strontium nitrate 12 parts, flowers of sulphur 4 parts, sulphide of antimony 0.5 part.

No. 4. Barium sulphate stirred into a paste with white of an egg and ignited in an open coal fire for 1 hour.

No. 5. Strontium carbonate 12 parts, sulphur 4 parts, oxide of zinc 1 part.

No. 6. Strontium carbonate 12 parts, sulphur 4 parts, sulphide of antimony 0.5 part.

No. 7. Strontium carbonate 12 parts, sulphur 4 parts, sulphide of barium 2.2 parts.

No. 8. Pure calcium carbonate 12 parts, sulphur 12 parts.

All these mixtures, with the exception of No. 4, require to be ignited or exposed to a red heat for $\frac{1}{2}$ hour. A little practice will show the temperature and time best adapted for their preparation.

Preparation of Precipitated Chalk for Tooth-powders. Dissolve 1 part of calcium chloride in 15 parts of distilled water, filter, and add to the filtrate a previously filtered solution of crystal-

lized soda in distilled water until a precipitate is no longer formed.

This fine white precipitate thus formed is prepared chalk. After it has settled on the bottom, pour off the supernatant fluid, moisten the precipitate with a little distilled water and bring it into a funnel provided with filtering paper. Wash the precipitate 6 to 8 times and finally dry it at a moderate heat.

Precipitated chalk thus prepared is absolutely free from particles of sand, which cannot be said of tooth-powders, prepared as they mostly are with natural chalk.

Process of Joining Two Pieces of Horn. Heat the pieces of horn before a fire and carefully scrape the edges where they are to be joined until they fit together exactly. Then take a pair of pincers, previously heated quite hot, and, after moistening the edges to be joined, press them together firmly and quickly. If the operation is skilfully performed a perfect joint will result; and after the edges have been made smooth with a fine file and polished with tripoli and water, it will be difficult to tell where the two pieces are joined together.

To Make Horn Combs Elastic. Place the horn from which the combs are to be made for 12 hours in a mixture of 3 parts of nitric acid, 15 parts of white wine, 2 parts of vinegar, and 2 parts of soft water. Then dry it and place it in a bath of 100 parts of warm water and 50 parts of nitric acid. The horn is then dyed and placed for 10 hours in a bath of vinegar and water.

Combs made from horn thus prepared are so soft that they can be trodden upon without breaking.

Roach and Moth Exterminator. Dissolve 2 parts of thymol and 2 parts of salicylic acid in 200 parts of alcohol, and perfume the mixture with 1 part of lemon oil.

This preparation makes no stain and kills the vermin immediately. The odor is not unpleasant and is quickly removed by airing the room.

Shaving Cream. To make shaving cream that can be used without water melt 20 pounds of lard in a steam-bath at a temperature of 212° F., then let 5 pounds of caustic potash-lye of 36° B. run in very slowly during constant

stirring with a wooden paddle; when the paste becomes thick, 5 pounds more of lye are added in the same manner. After several hours stirring, the mixture becomes firm and is finished. It is then transferred to a mortar and triturated until the soap becomes perfectly smooth throughout and assumes a pearly appearance. Attar of almonds is the perfume for almond cream and attar of rose for rose cream. They are dissolved in a little alcohol and added during trituration.

To Preserve India Rubber Goods from Becoming Hard and Cracking. Dip the goods, according to their size, for a few seconds to some minutes in a bath of melted paraffine of about 212° F., and dry them in a room heated to 212° F.

To Render Rubber Hose Odorless. To obviate the disagreeable smell of rubber hose used for gas conductors, etc., it is recommended to rub the hose with a rag dipped in a solution of equal parts of linseed oil and alcohol of 36 per cent., thoroughly shaken together. Stretch the hose moderately and continue the rubbing until the mixture is nearly dry, and repeat the operation three or four times in intervals of a few days. By this treatment the hose is made gas-tight and odorless without losing color and elasticity.

Washing White Straw Hats. Remove the hat band and wash the hat with a 5 per cent. solution of citric acid by means of a small sponge. Then rinse with clean water and hang the hat in the sun to dry.

Window Panes which Indicate the Moisture of the Atmosphere. A neat utilization of the property of cobalt and nickel salts of indicating every change of moisture by a change of color is as follows: By coating window panes or wall paper with solutions of—*I.*: cobaltous chloride 1 part, gelatine 10 parts, and water 100; *II.*: cuprous chloride 1 part, gelatine 10 parts, and water 100 parts; *III.*: cobaltous chloride 1 part, gelatine 20 parts, water 200 parts, nickel protoxide 0.75 part, and cuprous chloride 0.25, the painted surfaces remain colorless in cloudy weather, and in clear weather No. I. turns blue, No. II. yellow, and No. III. green. Other attractive devices are likewise made.

OILS AND FATS.

Bleaching of Bone-fat. Melt the fat at from 158° to 167° F., then stir into it 1 per cent. of soda-lye of 30° B., to which has been added $\frac{1}{2}$ per cent. of common salt, and let the mass stand for 12 hours. The clear fat is then brought into a barrel of soft wood and allowed to cool to 104° F. Now dissolve 1 per cent. of the fat of potassium bichromate in sufficient hot water that the hot solution shows 22° B., add 3 per cent. of fuming hydrochloric acid of 22° and stir the mixture into the fat. The fat is then washed with hot water, covered, and allowed to settle.

Bleaching of Paraffine and Similar Substances for the Manufacture of Candles. Filter the crude paraffine and boil it 2 hours with 5 per cent. of its weight of sodium sulphide and a sufficient quantity of water. When cold, the paraffine, which floats on the top, is washed in water, pressed, and dissolved in 20 per cent. of amyl alcohol, from which it separates as a pasty mass. It is then allowed to rest for some time, filtered through charcoal, and subjected to powerful pressure.

Bleaching of Oils and Fats. The following method, which is adapted for solid and fluid fats, can be used for bleaching and clarifying oils and fats for domestic and industrial purposes. Cotton-seed oil, rape-seed oil, and all other fat oils are prepared for treatment by mixing in a large tank with 2 to 3 per cent. of common salt and thoroughly stirring for 5 to 10 minutes with 25 to 50 per cent. of water. After a rest of 24 to 48 hours it will be found that a portion of the impurities and the water and salt have settled on the bottom. The supernatant oil is then drawn off into another tank and again thoroughly washed with cold water, and again drawn off after a rest of 6 to 12 hours.

This treatment with common salt is especially valuable for the preparation of fine table-oils, but can also be used for other oils, such as linseed oil, train oil, etc. By conducting at the same time during the mechanical treatment an electrical current through the mixture the oil is bleached by the decomposition of the common salt by the

action of the electric current, and the formation of secondary combinations of strong bleaching power.

For many oils and fats which readily become rancid or spoil, it is recommended to add 2 to 3 per cent. of bicarbonate of sodium to the above process. Besides the second washing with cold water, the oil can also be treated with steam conducted through it in a finely divided state, 5 to 10 minutes being sufficient for cotton-seed oil, while 15 to 20 minutes are required for rapeseed oil and 30 minutes for fish oil. By this treatment the rancid constituents are removed and the slimy particles precipitated.

Instead of steam, repeatedly heated air mixed with 20 to 30 per cent. of hot water may also be forced through the oil by means of a blowing engine. By filtering the oil thus prepared and storing it for some time, a pure product of an agreeable taste and clear pale yellow color is obtained. For filtering, the ribbed sides and bottom of the filtering vessel are covered with endless filtering paper.

For the preparatory treatment of varnish oil, burning and lubricating oils, etc., the oil is compounded with a solution of 2 per cent. of common salt in 15 to 20 per cent. of water of 176° to 212° F., which, during the stirring, is still further heated by the introduction of steam. One to 1½ per cent. of hydrochloric acid diluted with 15 to 20 per cent. of water is then added with constant stirring, and finally steam is introduced in intervals of 5 minutes. The oil is then allowed to collect in settling tanks.

In many cases an addition of potassium permanganate, or potassium chlorate, or potassium bichromate previously dissolved in as little warm water as possible is useful. For 100 parts of oil about ½ part of the last-named salts and 1½ to 2 parts of common salt are used. The heated oil to be bleached is successively mixed with the salt solutions, 2 to 3 per cent. of hydrochloric acid or 1 to 1½ per cent. of sulphuric acid being added by means of a rose with constant stirring for one hour. Then add 30 per cent. of warm water to the mixture and allow it to rest.

After the oil is drawn off it is several

times washed with water with an addition of some soda and finally treated with steam. The slimy sediment can be used for the manufacture of soap. This method is applicable to mineral, vegetable, and animal oils.

Bleaching Tallow. About 50 pounds of caustic soda-lye are placed in a clean boiler and the steam is turned on. Salt is then added to the lye until it shows 25 to 28° B.; 300 pounds of fat are now placed in the boiler and the steam is turned on until the mass is brought to a boil, when the steam is shut off to prevent overflowing. It is then allowed to boil up 1 to 2 inches at the most, and then left to itself for 3 to 5 hours so that the fat will clarify. At the end of this time the upper saponified layer is ladled off, the pure tallow is removed and passed through a hair sieve or linen into a clean vessel, until the lower saponified layer is reached. The residue in the boiler, consisting of saponified fat and lye, is removed and used in the preparation of curd soap, together with the upper layer.

The boiler is then thoroughly cleansed and about 30 to 35 pounds of water with ¾ to 1 pound of alum are heated to boiling. To this solution the fat is added, and the mass is allowed to boil for about 15 minutes, until all the filth has disappeared from the fat. The mass is then transferred to another vessel and left to itself from 3 to 5 hours. The pure fat is then again placed in the boiler and heated until it shows a temperature of 338° to 392° F. In this last operation the fat becomes snow-white. The steam must be turned off as soon as the slightest trace of vapor of a disagreeable odor is thrown off. The fat may then be directly used or left to cool. As stated, the steam must be turned off or the fire removed as soon as a trace of disagreeable vapors becomes manifest, whether the temperature be 306° or 338° F., for if this is not done the fat will again turn dark.

Freshly rendered, sweet fat (not acid or rancid) is most readily bleached and may be heated quite high. Still the fat should not be too fresh, or one will take the risk of saponifying the 300 pounds without leaving any to bleach. Tallow treated in this way, when used for toilet soaps, gives them a white

color and agreeable odor. It is also well adapted for candle-making, as it becomes exceedingly hard.

Clarifying Olive Oil. The most common method is to have a series of boxes, one above the other, each with cotton batting in the bottom; the oil passing the sixth box will be beautifully clear and ready for market. Some use cylindrical tin vessels holding about 3 gallons each, one fitting into the other in tiers of three, with fine wire sieves in the bottom of each. On these sieves lie two or three layers of cotton batting. The oil is passed from one tier to the other until clear. Clarifying can be done by the sunlight also: it can be bleached and made much lighter in color, but not without injuring it. When it is adulterated artificial heat is necessary in the process. When once heated it loses a part of the nutty flavor, and is liable to become rancid when exposed to the air. It should be kept in an ordinarily cool place and not exposed to sunlight or heat; neither should it be handled any more than absolutely necessary in the filtering and bottling and should not be shaken after it is bottled. The mucilage contained in the oil will not separate for a long time after the oil is ready for use, and, as it does not injure it, it is not therefore objectionable. It will sometimes form in the bottle like globules of water, in films settling to the bottom as sediment, and when shaken will give it a muddy appearance, which frequently renders it unsalable, as consumers have a prejudice against all table oils that are not perfectly clear. The oil is better when new and fresh, and what is gained by its appearance from remaining a longer time in the tank is more than lost in freshness and delicacy of flavor.

Detection of Water in Essential Oils. Essential oil distilled from the respective parts of the plants with water contain water, even if apparently perfectly clear. By adding to such oils 3 to 5 times their volume of petroleum ether of 0.67 to 0.675 specific gravity, an immediate cloudiness will make its appearance in consequence of the separation of the drops of water. The more water the oil contains the greater the cloudiness. This simple test is infallible.

Manufacture of Cotton-seed Oil. The cotton seed having been screened from all dust and foreign substances, is freed from adhering cotton by passing it through a machine similar to a gin, only with teeth placed closer together. The seed is then delivered into the huller, which consists of a cylinder armed with steel blades and surrounded about two-thirds way by a concave box also armed with corresponding knives. The cylinder revolves at great speed, and as the seed is forced between the knives the pericarp or hull is broken and forced from the kernel. The mass of crushed seed then falls into a large revolving sieve. The kernels, many of which are broken into fine pieces, pass through the meshes of the wire sieve, and the pericarp to which the lint adheres is carried away and either burned under the boiler or used as cattle-feed. The clean seed is now carried by a system of elevators into the attic story and then passes down into the crushers or rollers. These consist chiefly of two rollers revolving towards each other with unequal velocity, so geared as to produce both a crushing and a tearing effect upon the seed. The meal, as the seed is now called, falls to the bin on the first floor and is shovelled into the heater, which is a short double cylinder so arranged as to heat the meal in the inner cylinder by steam, which circulates in the space between the inner and the outer walls. Here the meal is heated until the water it contains is converted into steam and escapes. The hot meal is then placed in wedge-shaped bags of woollen duck, each holding sufficient seed for a cake. The bags are then placed between the sides of wrappers formed of thickly woven horsehair backed with corrugated leather to facilitate the escape of the oil, which are called "hairs" or "books." The hair and its contained bag of seed are then placed in the hydraulic press. The press usually has spaces for four cakes, one above another. The ram is 12 inches in diameter and is worked at a pressure of 1½ tons to the square inch. The pressure is given by pumps, two with 1 inch rams and two with 2½ inch rams being in one set; the larger diameter of pumps gives the pressure quickly until

it reaches about 3 cwt. per square inch, when the small pumps give the final squeeze. Fifteen minutes' pressure suffices to completely extract the oil, which collects in a reservoir. The hairs are then thrown out, the duck bags are stripped from the meal, now pressed into solid cakes, the cakes are set up in racks to dry, and the operation is completed.

Two merchantable articles are produced at the press: crude cotton-seed oil and cotton-seed cake. After the oil has cooled down to atmospheric temperature, and the floating impurities have separated from it, it is of a deep red color, and weighs about $7\frac{1}{2}$ pounds to the gallon. It is estimated that out of a bushel of seed weighing 30 pounds, three quarts of oil will be produced, leaving about 10 pounds of oil cake, which is very valuable for feeding cattle, horses, and hogs.

It has been proven in England by fair tests that the manure of cattle fed with cotton-seed meal is better than any other animal manure other than guano from birds. The meal as food for merino sheep produces an exceedingly valuable result. The usual effect of feeding cotton-seed meal to female cattle when they are with young is a tendency to produce miscarriage. Strangely enough, the effect upon merino ewes is to make them bear twins. A sheep farmer in Arkansas, by careful feeding of cotton-seed meal to his flock, caused three-fourths of his ewes to bear twins. Another valuable result to be got from feeding on cotton-seed meal is the oil from the wool, which is more abundant than from other food, and by the use of naphtha in its preparation can be made into the best tanning oil in use.

Fat from Sheep's Wool. Under the name of *lanolin* Prof. Liebreich has introduced a fat obtained from sheep's wool, which is believed to possess valuable properties for the preparation of ointments. Various medicaments combined with lanolin are said to be more promptly absorbed than when prepared with other bases as a vehicle. Liebreich prepares lanolin in the following manner:

He takes the suds from the washing of wool in the mills, submits it to the action of a centrifugal machine which

separates the soapy, oily suds from the dirt associated therewith, decomposes the suds by an acid, whereby the acid and the saponifying alkali unite, and the saponified wool-fat is separated, combined with about 100 per cent. of water; this is then thoroughly washed with cold water, then heated so as to separate the water and the wool-fat, and again combined with a definite proportion of water, and lanolin is the result; or, he treats wool with alkaline water, producing his suds in that way, and then proceeding as above outlined.

A much quicker and less complex way of making the article is to treat the wool directly with petroleum benzine; distil off the benzine, and the wool-fat remains; combine this with a proper proportion of water, and lanolin results.

The last process is objectionable, however, on account of the great difficulty of entirely removing the odor of benzine from the product. (W.)

"Suint," or Potassic Sudorate in Sheep's Wool. This is the name given by the French to the sweat exuded from the skin of the sheep and retained in the wool. This substance, which forms nearly 15 per cent. of the raw wool, may readily be removed from the wool by simple washing in water. It contains considerable potash, and from this source there are produced annually in France about 250,000 pounds (or 100 tons) of potash. This substance must not be confounded with the oil or grease of the wool (which constitutes about $8\frac{1}{2}$ per cent. of the weight of the raw wool, and is combined largely with earthy matter, chiefly lime, as an insoluble soap). The "suint" is a neutral salt of potassium with an animal acid contained in the sweat. The wash-waters of the large woollen manufactories are utilized for this purpose, the liquors being valued according to their strength. The process consists in boiling down the liquors to dryness, calcining the mixture, lixiviating, and crystallizing. It is estimated that if the wash-water of all the fleeces handled in France could be utilized the country could derive from that source all the potash she requires for agricultural and other uses. (W.)

Refining of Cotton-seed Oil. One hundred gallons of the crude oil are placed in a tank and 3 gallons of caustic potash-lye of 45° B. are gradually added and well stirred for several hours; or, the same quantity of oil is treated with about 6 gallons of soda-lye of 25° or 30° B., and heated for an hour or more to about 200° or 240° F. under perpetual stirring and left to settle. The clear oil is then separated from the brown soap stock and this dark soap sediment is placed into bags, where the remainder of the oil will drain off.

Refined cotton-seed oil has the color, transparency, and taste of olive oil, and it has the same character for lubricating and pharmaceutical purposes. It has the property of resisting cold, remaining limpid, when pure, at 30° F., and quite fluid at 20°, hardening only at 8° to 10° F. It is not volatile, but is a fixed oil like lard, sperm, or olive oil, and is therefore not explosive. It gives a brighter light and burns longer than lard oil, owing to the absence of the gum which always exists in lard; and for this reason it is a better lubricator than lard oil. It is almost impossible to distinguish good refined cotton-seed oil from olive oil, and for this reason the latter is frequently adulterated with it, the general proportion being about 75 parts of cotton-seed oil to 25 parts of olive oil.

In the Southern and Western States refined cotton-seed oil is largely used for culinary purposes, and it is claimed that for "shortening," as for pie-crusts, it is far superior to lard or any other grease, both as to taste of the finished pie and its appearance.

Production of Light-colored Soap, or Light-colored Sebacic Acids, from Crude Cotton-seed Oil, or from Residues Obtained by its Purification. The oil is freed from impurities by settling or filtering. The residues are slightly warmed with a little water, and after cooling drawn off from the aqueous layer. The oil or the residues are then treated with sufficient strong soda-lye, so that the soap separates in flakes which are removed from the strongly colored under-layer. The soap is dissolved in as little water as possible, and decolorized by the addition of chlorine

water. Instead of the latter, bleaching powder, potassium chlorate, potassium permanganate, or potassium bichromate can be added and afterwards acids. By the addition of an excess of such acids purified sebacic acids are separated.

To Remove the Disagreeable Odor of Soap made from cotton-seed oil, boil the oil to be used for white soap with an equal quantity of 25 per cent. soda-lye for 3 to 4 hours.

Utilizing Cotton-seed Hulls. Instead of treating the hulls as refuse or burning them for fuel, potash and phosphate of lime can be extracted from them by the following process: The hulls are first burnt and the resulting ashes boiled for two hours in about ten times their weight of water. Then gradually add about half the weight of ash of lime to the boiled solution and allow it to settle. The clear liquid is next drawn off in any suitable manner. The residue is then put in a percolator and exhausted with water, and the solution is added to the clear liquid, and both evaporated to dryness, after which the potash is fused and run into moulds. The process of exhaustion is repeated and the subsequent washings are used to dissolve the next batch of ash and to slake the lime. The residue left in the percolator contains 50 per cent. of phosphate of lime.

New Process of Extracting Fish Oil. The fish are sprinkled with 5 per cent. of their weight of ferric chloride or sulphate solution of 45° B., and can then be kept 3 or 4 days without undergoing alteration. They are then crushed, made into a paste, and pressed, when a large quantity of oil and water is forced out. The cake from the press dries readily, becomes friable, and is easily pulverized. A further quantity of fatty matter may be obtained from it, either by pressing between heated metal plates, or by extraction with benzine or carbon di-sulphide. The residue forms an excellent fertilizer.

Preparation of Heavy Oils and Paraffine from Petroleum Residues. A large percentage of paraffine oil can be obtained by distilling the residues in vacuum with superheated steam. At from 59° to 68° F. these oils are gelatinous and contain from 22 to 24 per cent. of paraffine, 20 per cent. of which

can be gained. The oils are first purified by filtering through cloths at from 86° to 104° F., and treating with 4 to 5 per cent. of sulphuric acid of 66° B. After allowing the tarry substances to settle at 114° F., the oil is drawn off, the acid removed with quicklime, and the oil gradually cooled off to 41° F. The paraffine crystallizes and can be obtained by pressing, after which it is further purified by pressing with amyl alcohol or benzine and filtration through animal charcoal.

Purification of Oils. Linseed oil should be warmed in an iron boiler and melted lead poured into it, in a thin stream, a little at a time. It should then be left for several days in a warm place, when a deposit separates and the oil becomes quite clear. Oil thus treated possesses in a high degree the property of drying quickly, and is especially suited for the manufacture of varnishes and lacquers. Cocoanut oil should be rubbed up, thoroughly incorporated with warm water, placed in a bag and pressed through it. The fluid thus obtained is brought to the boiling point, and the separating oil clarified with sugar and alum. The oil thus obtained is odorless, white, and well adapted for use in perfumery. The purification of fatty oils may be conducted in the following manner: In a tub provided with a faucet 2 lbs. of potassium permanganate are dissolved in 6½ gallons of water. Eighteen gallons of oil are added and thoroughly agitated, and then left to settle for 2 days. After this time 4 gallons of warm water are added with 11 lbs. of crude hydrochloric acid, and the whole vigorously agitated. After several days' rest the water is drawn off from the oil and the latter is washed with hot water to remove the acid. For the quicker separation of the oil from the water the whole is placed in a carboy with a perforated cork, in which two tubes are fitted. One of these is a funnel tube, reaching nearly to the bottom; the other is a bent delivery tube, reaching a little way below the cork. By pouring water through the funnel tube the oil is delivered bright and clear. It is colorless and odorless.

Solidification of Liquid Hydrocarbons. The liquid hydrocarbon, such as

crude petroleum, refined petroleum, etc., is mixed with some melted fat, after which the mixture is acidulated, and in the form of a spray introduced into an alkaline solution. The mass coagulates and is mechanically separated from the aqueous solution. The coagulum thus obtained is made still more resisting to the influence of heat, etc., by mixing with water-glass solution to which has been added burnt lime, gypsum, or magnesia. To regain the hydrocarbons the melted mass is compounded with dilute sulphuric or hydrochloric acid, whereby fat and hydrocarbon are separated on the surface. By using ammonia for coagulating the hydrocarbon the dried mass after heating can be formed into candles or torches. For preparing solid fuel the coagulum is mixed with powdered eoake, etc.

The same method can also be used for the solidification of volatile oils, fat oils, etc. It is best not to add the acid at one time, but in several portions, and to stir thoroughly after each addition. If crude petroleum is to be solidified to be used for candles or torches, it is previously purified by treatment with oxidizing agents, such as potassium manganate and permanganate, etc.

Substitute for Linseed Oil. Melt 5½ parts of light Burgundy pitch and mix with 2½ parts of crude cotton-seed oil and ½ part of fat oil, both previously heated to 176° F. Then add 3½ parts of petroleum heated to the same temperature and heat the mixture. When cold add a trace of a mixture of oil of valerian and essence of mirbane, and allow the mixture to clarify. By boiling the cotton-seed oil before use with 3 per cent. of gold litharge a mass is obtained which can be used as a substitute for boiled linseed oil in preparing paints, varnishes, etc.

To Purify Oils. Heat the oil with 2 to 3 per cent. of sodium di-sulphide to 77° to 95° F., and stir until all the sulphurous acid has escaped.

The following method is especially used for rancid and bitter peanut oil and oil of almonds: Make an emulsion of the oil with a base (good results have been obtained with potash dissolved in twenty times its weight of water), add

about double the volume of oil of water and agitate. In an hour the emulsion is destroyed with sulphuric acid and diluted with ten times its weight of water. The reforming process commences immediately; the oil appears on the surface, and after a few hours of rest is completely separated. The oil is then decanted and filtered.

White Vaseline Oil. To 100 parts of yellow Russian mineral oil add with constant stirring 25 parts of fuming sulphuric acid in a thin stream. Continue the stirring for 30 minutes and allow the mixture to rest 4 to 5 hours. Then draw the supernatant oil from the black tar-like sediment into another boiler, and add gradually and in small portions 30 per cent. of best well-dried decolorizing powder (residue from the manufacture of potassium ferrocyanide.) Continue the stirring with constant heating for 2 hours and then let the oil rest 4 to 6 hours. Draw the oil off and bring it into a double walled filter heated by steam and filled $\frac{1}{2}$ with decolorizing powder.

Should the oil coming from the filter not be entirely white, pass it through a second filter and if necessary through a third until the desired whiteness is attained.

The major portion of the oil retained by the decolorizing powder can be regained by pressing the latter in a filtering press, and by boiling the pressed powder with water acidulated with 5 per cent. of sulphuric acid nearly all the remainder of the oil is obtained.

Solvent Power of Glycerine. Although not used to a great extent in the chemical industries as a solvent, glycerine is of considerable service for this purpose in pharmacy. Below is a table showing the solvent power of this substance. It is found that 100 parts (by weight) of glycerine will dissolve:

Parts by weight.	Substance.
20	Arsenious acid.
20	Arsenic acid.
10	Benzoic acid.
10	Boracic acid.
15	Oxalic acid.
50	Tannic acid.
40	Alums.
20	Ammonium carbonate.
20	Ammonium chloride.
$5\frac{1}{2}$	Tartar emetic.
10	Barium chloride.

30	Cupric sulphate.
$7\frac{1}{2}$	Mercuric chloride.
27	Mercuric cyanide.
2	Iodine.
$\frac{1}{8}$	Phosphorus.
20	Plumbic acetate.
50	Potassium arsenate.
$3\frac{1}{2}$	Potassium chlorate.
25	Potassium bromide.
32	Potassium cyanide.
40	Potassium iodide.
8	Hydrogen sodium carbonate.
60	Borax.
98	Sodium carbonate.
20	Sodium chlorate.
$\frac{1}{10}$	Sulphur.
50	Zinc chloride.
35	Zinc sulphate.
50	Urea.
$\frac{1}{2}$	Morphine.
$\frac{1}{2}$	Quinine.
$\frac{1}{4}$	Strychnine.

(W.)

PAPER.

Cupro-ammonium for Rendering Paper and Textile Fabrics Water-, Rot-, and Insect-proof. By a recently patented process called "Willesdenizing," paper, canvas, cordage, etc., are rendered water-proof and rot-proof, and are protected against liability to injury from mould and the attacks of insects. These products are made on the large scale at Willesden, England, by the Patent Water-proof Paper and Canvas Co. Two classes of products are made. 1. Round or "made up" goods, consisting of rope and cordage, Willesdenized netting, etc.; and, 2. Flat goods turned out in the roll. All of these fabrics are water-proof and free from any tendency to rot or mildew. The "Willesdenized" paper and canvas are made in endless rolls, and of any desired thickness. They are adapted for diverse uses, such as panel-work where great strength is required, as a roofing material which will be unaffected by the weather, and for building purposes generally. Any desired thickness of material is obtained in the finished product by pressing into one compact, homogeneous sheet several layers while they are still superficially gelatinized or "pectized" by the action of the cupro-ammonium solution.

The paper, canvas, etc., by this process is treated with a solution of cupro-ammonium hydroxide, which is prepared by the action of strong am-

monia on copper turnings, in a current of air. The action of the solution on vegetable tissues (cellulose) is a solvent action. The extracts to be treated, however, are passed through the solution at such a rate as to simply gelatinize the exterior of the fibres without disintegrating them, so that on their emergence from the bath the goods possess sufficient coherence to permit them to be passed through a suitable drying apparatus. By this treatment the exterior film of "pectized" cellulose is converted into an elastic varnish in which all the copper taken up by the materials is retained in the combination (probably as a cupro-cellulose) and forms a perfect water-proof coating.

Instead of cupro-ammonium the analogous zinc compound may be used, though its action is not so prompt as that of the copper compound. Good results are obtained by using a mixture of the two metallic compounds. The products here described have only lately been placed upon the market, but enough is known of them to make it safe to state that they possess most valuable qualities. (W.)

Fabrication of Parchment. A solid parchment impermeable to water and adapted for the osmose of molasses, etc., is prepared as follows: Woollen or cotton tissues are freed by washing from gum, starch, and other foreign substances, and then passed between two rollers in a bath containing some paper pulp. The product is passed through a bath of concentrated sulphuric acid and then repeatedly dipped into one of aqueous ammonia until the acid is completely neutralized. It is then pressed between rollers, dried between two other rollers covered with felt, and finally calendered.

Fire-proof Papers, Colors, and Printed Matter. Actually fire-proof paper, *i. e.*, such as will bear a temperature of 1482° F., in connection with printers' ink or ink not affected by such a strong heat, has not been known up to this time. Some papers manufactured with asbestos will stand certain degrees of heat, but they are not suitable for writing or printing paper. L. Forberr, of Berlin, now prepares such papers of the desired qualities according to a method patented by him. As-

bestos fibres of the best quality are washed in solution of potassium permanganate and bleached with sulphuric acid. To 95 parts of fibre thus prepared are added 5 parts of ground cellulose such as is used in paper mills. The mass is then thoroughly mixed with an addition of glue water and borax and then worked into paper. The product is smooth and is made fit for writing by satinizing; it is claimed to resist a strong red heat.

For the preparation of fire-proof printing and writing ink a mixture of platinum chloride and oil of lavender is used, to which, for black printing ink, lampblack and varnish are added, and for writing ink, Chinese ink, water, and gum-Arabic.

For a good fire-proof printing ink 10 parts of platinum chloride and 25 parts of lavender oil are heated in a porcelain dish until the development of gas ceases, and 35 parts of lampblack and 30 parts of varnish added in small portions. On heating paper printed with this preparation the platinum is reduced and remains as a black-brown coating.

For fire-proof writing ink a mixture of 5 parts of platinum chloride, 15 of lavender oil, 18 of Chinese ink, 1 of gum-Arabic, and 64 of water is used.

Colored fire-proof inks are produced by an admixture of metallic underglaze colors.

Gas-pipes from Paper. A strip of manilla paper equal in width to the length of the pipe to be made is passed through a vessel with melted asphalt, and then wrapped firmly and uniformly around an iron core until the required thickness is attained. The pipe is then subjected to powerful pressure, after which the outside is strewn over with sand, and the whole cooled in water. The core is then removed and the inside of the pipe coated with a water-proof composition. These pipes are claimed to be perfectly gas-tight and much cheaper than iron pipes, and very resisting to shocks and concussions.

Luminous Paper. The luminous mass consists of 4 parts of potassium bichromate, 4 of gelatine, and 50 of calcium sulphide. The constituents are thoroughly dried and mixed by

grinding. One part of the resulting powder is stirred with 2 parts of boiling water to a thickly fluid paint, 1 or 2 coats of which are applied with a brush to the paper or pasteboard to be made luminous. To avoid inequality in the thickness of the layer of paint the paper is passed through a sort of calender with rolls at a proper distance to insure a uniform spreading of the luminous mass. The rolls may be heated, if desired.

Manufacture of Bottles, etc., from Paper. Well-sized paper made of 10 parts of rags, 40 of straw, and 50 of brown wood-pulp is generally used. The paper is impregnated or coated on both sides with a mixture of 60 parts of defibrinated blood, 35 parts of lime powder, and 5 parts of sulphate of aluminium. After drying 10 or 12 rolled leaves are coated again, placed over each other, and then brought into heated moulds. The albumen in the blood forms a combination on pressure with the lime which is perfectly proof against spirits, etc. Bottles are made in 2 pieces, which are joined afterwards with caoutchouc cement.

New Method of Manufacturing Paper Pulp. Straw or wood is digested for 12 hours in dilute milk of lime; it is then saturated with sulphur dioxide under a pressure of four atmospheres, which effects a complete disintegration of the mass in 1 or 2 hours. The mass is washed with water and subjected under pressure to the action of 3 per cent. of calcium chloride and 0.5 per cent. of aluminium sulphate dissolved in a small quantity of water. After a final washing the product resembles cotton wool in appearance and can be used for the manufacture of the finest kind of paper.

Paper for Covering Boilers. Impregnate the paper with a silicate and, when dry, coat with a mixture of 2 parts of magnesia, 2 of zinc white, 4 of sodium silicate, and 1 of linseed oil. When dry apply a coat of sodium silicate.

Preparation of Soap Paper. The material for impregnating the paper consists of 10 parts of glycerine, 30 of alcohol, 60 of dry glycerine soap, and 50 of ordinary dry neutral soap at a temperature varying between 162°

and 180° F. In the trough containing the mixture are three rollers driven by steam and revolving in the same direction, over the lower side of which the paper is passed. During the manipulation a thin spray of oil of turpentine is allowed to fall upon the paper, which makes it dry more quickly and gives it a beautiful lustrous appearance. The patent applies not only to paper but to all materials containing 40 or more per cent. of cotton.

To make Parchment Paper Impermeable to Oil. Dip the parchment in a hot solution of gelatine to which has been added 2½ to 3 per cent. of glycerine and dry. To make the same parchment water-proof soak in a solution of 1 per cent. of linseed oil and 4 per cent. of caoutchouc in carbon di-sulphide.

STRAW, BLEACHING AND DYEING OF.

Before straw is available for the many industrial purposes for which it is used it is subjected to a bleaching process, which is generally preceded by a cleansing bath. For the purpose of dissolving the natural coloring matter the straw is steeped in hot water and then treated with alkaline lye, consisting of 50 parts of water, 8 of potash, and 12 of soda. When taken from this bath it is successively immersed in two or three of weaker lye, and finally rinsed in boiling water. The bleaching process commences in a chlorine bath and is finished in one of sulphuric acid. Good results are also obtained by treating the straw, after the cleansing process, with sulphur vapors, but in order to obtain beautiful shades of color it is advisable in this case to color the straw after the treatment with a little picric acid by immersing it in a bath consisting of 24 pounds of water and ¾ drachm of crystallized picric acid. Besides, with sulphur vapors, the straw can also be bleached in the following manner: Immerse 30 pounds of straw in warm water for a few hours, then treat it with a soda solution of 40° B. for 6 hours, and boil it for 1 hour with 1 pound of chloride of lime. Then add to the bath 1 ounce 12 drachms of hydrochloric acid diluted with 3 gallons of water and allow the

straw to remain in it for $\frac{1}{2}$ hour, after which it is placed in a 1 per cent. soda bath, and finally rinsed in water. By this method the straw acquires a beautiful white color and great suppleness and elasticity.

Before dyeing it is advisable to thoroughly soak the straw in order to fix the color uniformly. The most important colors are black, brown, and gray.

Black for 22 Pounds of Straw. Boil the straw for 2 hours in a dye-bath of 4 pounds of logwood and 1 pound of sumach or gall nuts, and then place it in a bath of nitrate of iron (best 4° B.), rinse and dry.

Black for 22 Pounds of Straw. Boil for 2 hours with logwood 4 pounds, sumach $\frac{1}{2}$ pound, and fustic or turmeric 1 pound. Then darken with green vitriol, rinse and dry.

Black for 22 Pounds of Straw. Boil for 2 hours with green vitriol 4 pounds, tartar 2 pounds, and blue vitriol 1 pound. Finish in a bath of 8 pounds of logwood, with an addition of some turmeric.

Gray for 22 Pounds of Straw. Soak the straw in a solution of sodium carbonate, with an addition of some lime to remove the sulphur. Then boil for 2 hours in a dye-bath consisting of alum 4 pounds, tartaric acid $3\frac{1}{2}$ ounces, and, according to the desired shade, some cochineal or indigo carmine. To neutralize the cochineal add some sulphuric acid. After boiling wash the straw in slightly acidulated water.

Brown for 22 Pounds of Straw. Boil for 2 hours in a dye-bath of 1 pound 10 ounces of sanders wood, 2 pounds of turmeric, $\frac{1}{2}$ pound of sumach, and 1 pound 5 ounces of logwood. Then rinse and darken according to the desired shade with 3 to 4 per cent. of green vitriol.

Chestnut-brown for 22 Pounds of Straw. Catechu 1 pound 10 ounces, turmeric 2 pounds, gall nuts 6 ounces, and logwood 1 ounce. Boil for 2 hours, rinse, and finally treat with nitrate of iron of 4° B. and rinse again.

Havana Brown for 22 Pounds of Straw. Soak the straw in solution of $4\frac{1}{2}$ to $6\frac{1}{2}$ pounds of alum, then dye in a bath of 13 ounces of sanders wood, 1 pound of turmeric, 3 ounces 8 drachms

of sumach, and $12\frac{1}{2}$ ounces of logwood, and rinse.

Violet for 22 Pounds of Straw. Boil for 2 hours with alum 4 pounds, tartaric acid 1 pound, and tin salt 1 pound. According to the shade desired add some extract of logwood or indigo. After dyeing, wash in water compounded with alum.

Red for 22 Pounds of Straw. The mordant consists of tartar 1 pound and some tin salt. Boil for two hours. Then boil for one hour with fustic 1 pound, turmeric 7 ounces, madder 7 ounces, cudbear 1 pound, and logwood 1 pound. Then add, according to the shade desired, cudbear, archil, or madder.

Green for 22 Pounds of Straw. Boil for 2 hours in a mordant of sumach 7 ounces, alum 2 pounds, and tartar 1 pound, and then add some picric acid, turmeric, and aniline green.

Straw can also be dyed with aniline colors, the manipulation of which presents no difficulties.

To give lustre to the articles manufactured from the dyed straw, gum or gelatine is frequently used.

STRENGTH OF MATERIALS.

Autographic Torsion Testing Machine, made by the Pratt & Whitney Co., Hartford, Conn. This instrument has been devised by Prof. R. H. Thurston for the special purpose of determining the torsional strength of materials of construction. It gives the investigator an autographic record of the values of elasticity, ductility, homogeneity, and ultimate resistance of the various metals, alloys, woods, etc., used in engineering constructions, enabling him to pass a sound judgment upon the relative usefulness of such materials for the various purposes in construction for which they may be intended. The machine is constructed with special reference to convenience of operation, and provides improved methods of subjecting specimens to torsional strains, either continuously or intermittently, through all degrees of strain to final rupture; and the autographic recording device with which the same is provided exhibits graphically throughout

the entire investigation the relation between the moment of torsion and the angle of torsion. The following description will make its construction and operation clear:

men to the weighted pendulum on the opposite side of the frame. A yoke, carrying a pencil, is attached or pivoted to the pendulum, and is guided at its upper end by a brass semi-circular tem-

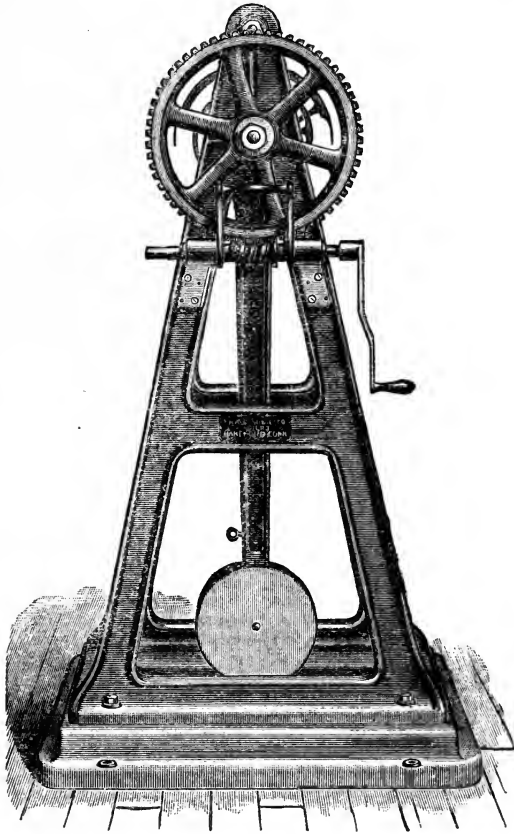

Fig. 78.

The jaws (Fig. 78) which receive the specimen each have their axis in the same plane horizontally and vertically, and motion given to the worm wheel is imparted through the speci-

plate or "curve of lines," its inner edge being made to represent a curve, the ordinates of which correspond to the torsional resistance of the weighted pendulum while moving through an

arc to which the corresponding abscissæ are proportional; while the rotation of the jaw attached to the worm wheel causes the pencil to be moved forward by the action of the guide curve.

Upon the shaft connecting the worm wheel and the jaws which receive the end of the specimen is a brass drum $5\frac{1}{2}$ inches wide, and circumference equal to 36 inches; upon this drum is stretched a special blank of section-lined paper, upon which strain diagrams are thus autographically traced.

The motion of the pencil in the direction of the axis measures the torsional moment, from which the tensile strength of the specimen may be deduced; while the rotation of the drum carrying the diagram represents the angle of torsion, from which is deduced the ductility of the specimen.

By an improved device the worm can be readily disengaged from the worm wheel, and by carefully allowing the pendulum to swing back to its normal position the limit of elasticity may be determined.

By placing a number of the diagrams representing strains or tests of various metals, alloys, etc., upon the same sheet, the results obtained may be readily compared. (W.)

WILLOW-WARE.

Bleaching Willow-ware. This can be effected either by means of sulphurous acid, chlorine, or peroxide of hydrogen. The latter process, though but little practised, is preferable to the others, as no unwholesome gases or bad odors are evolved.

For bleaching with sulphurous acid place an iron dish filled with flowers of sulphur in the bleaching room, and, after igniting the sulphur, leave the door open until the sulphur burns freely. Then close the door all but a small crack, and only shut it entirely when the sulphur is nearly consumed. Leave the articles 5 to 6 hours in the room.

For bleaching with chlorine mix 1 part of chloride of lime with 15 parts of water, acidulate the mixture with sulphuric acid and place the vessel in the bleaching room, which should be

air-tight and previously filled with the articles to be bleached so arranged that they are not in contact with the floor or the walls.

Peroxide of hydrogen, which is now an article of commerce, is the most effective and harmless bleaching agent. It is entirely odorless, bleaches the articles in less time than the others, and no special bleaching room is required. Place the articles in a bath of commercial peroxide of hydrogen for $\frac{1}{4}$ hour, then take them out and expose them to the sun. By this treatment even yellowish and brownish willow-ware is bleached snow-white.

Stains for Willow-ware. All kinds of osiers take stains remarkably well, but in order that they may penetrate deeper and remain more constant when exposed to air and light it is advisable to treat the osiers first with a chemical agent, lime-water being especially adapted for the purpose. It is prepared by gradually slaking fresh-burnt lime with lukewarm water until it falls to a fine powder, and stirring 1 part of this with 15 to 16 parts of soft water, allowing it to settle and pouring off the supernatant fluid. The osiers are placed in this for $\frac{1}{2}$ to 6 hours, according to their thickness. They are then taken out and dried at about 96° to 104° F. The warm wood eagerly absorbs every kind of stain.

The osiers are generally colored before working them into articles by boiling in the stain for a shorter or longer time, according to their thickness and the depth of the color desired. Small finished articles are, however, sometimes colored by applying the hot stain by means of a brush or dipping them in the boiling stain. For the latter process large vessels and considerable quantities of stain are, of course, required.

Black Stain. Place the osiers in a boiling solution of 100 parts of aniline nitrate and 5 parts of cupric chloride in 1500 parts of water for 1 hour. Then take them out, dry thoroughly and place them for $\frac{1}{4}$ hour in a boiling bath of 100 parts of potassium bichromate in 2000 parts of water.

No. 2. Boil 250 parts of logwood extract with 2500 parts of rain-water and 15 parts of alum. After straining the

liquid to remove the impurities contained in the logwood extract, immerse the osiers for 2 to 6 hours, according to their thickness, keeping the bath constantly boiling to effect a thorough penetration of the stain. After taking them out and drying place them for 2 to 4 hours in a boiling solution of 150 parts of sulphate of iron in 1500 parts of rain-water.

A very beautiful black color is obtained by placing the osiers in the above-mentioned decoction of logwood extract, and, after drying, bringing them for 4 to 6 hours in a boiling solution of 130 parts of cupric sulphate in 2000 parts of rain-water.

Blue Stain. Boil 200 parts of indigo with 4000 parts of soft water and leave the osiers 5 to 6 hours in the boiling stain.

Brown Stains. Place the osiers in a solution of 10 parts of potassium permanganate in crystals in 300 parts of water. By taking them out immediately and allowing them to drain as quickly and uniformly as possible a pale yellow-brown color is obtained; by allowing them to remain $\frac{1}{4}$ hour a somewhat darker color, which, by an immersion of 2 to 3 hours, may be made a dark chestnut-brown.

No. 2. Place the osiers for 2 hours in a boiling solution of 15 parts of potash in 200 parts of water, and, after drying, place them for 2 hours in a boiling solution of 5 parts of pyrogallie acid in 200 parts of water. The color thus obtained is a beautiful light chestnut-brown and very constant.

No. 3. Place the osiers for 4 hours in a strained decoction of 15 parts of prepared catechu and 3 parts of soda with 200 of water, and, after drying, for 1 hour in a solution of 10 parts of potassium bichromate in 250 parts of water.

Gray Stains. Blue-gray. Place the osiers for 2 hours in a boiling solution of 35 parts of sulphate of iron in 150 parts of water, and, after drying, $\frac{1}{2}$ hour in a boiling solution of 3 parts of pyrogallie acid in 100 parts of water.

Dark Gray. Place the osiers for 2 to 6 hours, according to the depth of color required, in a boiling solution of 45 parts of sulphate of iron in 150 parts of water, and, after drying, for the same

length of time in a boiling solution of 20 parts of pyrogallie acid in 100 parts of water.

For the production of beautiful pure gray colors only fine green sulphate of iron is to be used, while for yellowish-gray shades the weathered, rusty material is employed.

Green Stain. Place the osiers for 3 to 4 hours in a boiling solution of 20 parts of indigo and 10 parts of picric acid in 500 parts of water. The shades of green can be varied at pleasure by using different proportions of the two coloring matters. Bluish-green and blue-green shades are obtained by taking more indigo and yellowish-green and yellow-green by adding more picric acid.

Yellow Stain. Boil 20 parts of Avignon berries, powdered or ground as fine as possible, and $2\frac{1}{2}$ parts of soda with 200 parts of water, strain, and, after boiling the clear liquor, place the osiers in it for 2 to 4 hours.

Yellow Stain from Picric Acid. Dissolve 10 parts of crystallized picric acid in 200 parts of boiling water. By treating the osiers for 2 hours in this solution a beautiful yellow color, of great constancy, is obtained.

Coloring Osiers with Aniline Colors. It is best, as a general rule, to produce only black, brown, gray, and yellow colors by means of stains, and the more vivid colors, such as red, blue-green, etc., with aniline colors.

In coloring with aniline colors the treatment of the osiers with lime-water is omitted, as in the presence of the smallest quantity of quicklime the aniline colors frequently undergo a change. The osiers are instead treated in a bath prepared by boiling 12 parts of Marseilles soap in 500 parts of water until the soap is dissolved. After sufficient soaking in the soap-bath the osiers are thoroughly dried in a heated room.

Aniline colors soluble in water should be used, though such as are soluble in water and alcohol may also be employed by dissolving them in a small quantity of alcohol and diluting with water. The colors soluble in water are mixed with the required quantity of water, best heated from 86° to 140° F., and, after stirring for a few

minutes, the osiers are kept in the bath until they are sufficiently colored.

Blue Stains. Dark Blue. Fifteen parts of Bengal blue (deep blue) and 350 parts of water.

Greenish-blue. Fifteen parts of *bleu très vert* and 300 parts of water.

Light Blue. Fifteen parts of *bleu de lumière* and 400 parts of water.

Sky-blue. Fourteen parts of *bleu de ciel* and 400 parts of water.

Brown Stains. Bismarck Brown. Fifteen parts of Bismarck brown and 400 parts of water.

Chestnut Brown. Eighteen parts of maroon and 450 parts of water.

Dark Brown. Eighteen parts of leukaniline brown and 350 parts of water.

Gray Stains. Blue-gray. Fifteen parts of gris-bleu and 350 parts of water.

Iron-gray. Twenty parts of gris-rouge and 350 parts of water.

Gray. Fourteen parts of gris and 300 parts of water.

Yellowish-gray. Fifteen parts of gris-jaune and 300 parts of water.

Green Stains. Dark Green. Fifteen parts of methyl green, 3 parts of *bleu de lumière*, and 400 parts of water.

Leaf-green. Fifteen parts of malachite green, 4 parts of naphthaline yellow, and 300 parts of water.

Dark Leaf-green. Fifteen parts of malachite green, 3 parts of *bleu de lumière*, and 300 parts of water.

Light Green. Fifteen parts of methyl green and 300 parts of water.

Malachite Green. Fifteen parts of malachite green and 300 parts of water.

Red Stains. Crimson. Twelve parts of *rouge cochenille* and 400 parts of water.

Coral Red. Twelve parts of coraline and 400 parts of water.

Dark Red. Twelve parts of fuchsine, 4 parts of orange, and 400 of water.

Delicate Pale Red. Five parts of eosine and 400 parts of water.

Ponceau Red. Twelve parts of ponceau and 400 parts of water.

Rose Color. Twelve parts of rose bengale and 400 parts of water.

Violet Stains. Bluish-violet. Fifteen parts of methyl violet, 30 parts of *bleu de lumière*, and 500 parts of rain-water.

Dark Violet. Fifteen parts of methyl violet and 400 parts of water.

Light Violet. Fifteen parts of methyl violet and 400 parts of water.

Reddish-violet. Fifteen parts of methyl violet, 3 parts of fuchsine, and 400 parts of water.

Yellow Stains. Dark Yellow. Eighteen parts of phosphine and 300 parts of water.

Pure Yellow. Fifteen parts of naphthaline yellow and 400 parts of water.

Reddish-yellow. Twenty parts of orange, 50 parts of fuchsine, and 550 parts of water.

Saffron Yellow. Eighteen parts of saffronine and 300 parts of water.

By mixing several colors an innumerable variety of shades can be produced; but, to avoid mistakes, it is best to always experiment first with small quantities.

Varnishing, Gilding, and Painting Willow-ware. If willow-ware is to be varnished without staining, it is best, after bleaching the articles, to give them a coat of a hot solution of white glue. This closes the pores and makes the coat of varnish more uniform and more lustrous. Dammar varnish and cheap copal varnish should never be used.

For white ware use colorless spirit lacquer; for dark ware, light and dark brown spirit lacquer or quick-drying copal varnish; and for black, deep-black spirit lacquer or quick-drying asphaltum lacquer.

If the ware is to be painted, give two coats of good oil paint, and when thoroughly dry a coat of varnish.

For gilding, apply first a coat of well-covering pale yellow oil paint (white lead and ochre), and when dry a coat of gilders' varnish. Before the latter is entirely dry lay on the gold or silver-leaf cut into suitable pieces, and press it down with a cotton pad. When dry remove the superfluous leaf with a soft brush.

Bronzing is done by applying a coat of good copal varnish, and before the latter is entirely dry dusting over the bronze powder by means of a soft brush. To avoid unnecessary loss, place the article upon a sheet of clean white paper, so that superfluous bronze powder can be saved.

INDEX.

- Abbe elixir, 16.**
Absinthe tincture, 13.
 veritable extract, 25.
Acetate of indigo, 184, 185.
 potassium, to prepare, 74.
Acetic acid, pure, to prepare, 73.
 acid, to prepare, 360.
 ether, to prepare, 358.
Acid, acetic, 360.
 acetic, to prepare, 73.
 molybdc, to prepare, 73, 74.
 nitric, detection of in vinegar, 2.
 oleic, to prepare, 73.
 oxalic, preparation of, 73.
 sulphocyanic, to prepare, 73.
 sulphuric, detection of in vinegar, 2.
 tartaric, detection of in vinegar, 2.
 tar, to extract oil from, 251.
Adrielle's process of silvering metals, 112.
Adulterations, imitations, etc., how to detect them, 1-3.
 in beer, 223-226.
Agate, how to imitate, 11.
 Schrader's formula, 12.
 to convert into onyx, 177, 178.
Agents, cleansing, polishing, and renovating, 75-78.
Air, compressed, blowing glass by means of, 426-430.
Alabaster glass, 144.
 soap, 333.
 to cleanse, 78.
Albumen, from blood, 324, 325.
 natural, manufacture of, 324, 325.
 patent, 325.
Alcohol, absolute, to prepare, 227.
 amyl, 229, 230.
 and compressed yeast from uncrushed cereals, 226.
 of 70 per cent. to convert to 90 per cent. in the cold way, 226.
 to purify, 226, 227, 230.
 use of in detecting adulteration of wax, 2.
Alfieri's receipt for removing incrustations, 40.
Alizarine, artificial, 186.
 dyeing Turkey red with, 106, 107.
 inks, 196, 197.
 liquor, 187.
 oil, English patent, 107.
 preparation of, 184-187.
 process of obtaining, 185-187.
Alkaline copying ink, 198.
 gelatine developer, 298.
 tooth-powder, 94.
Allataim du Harem, 58.
Alloy for imitation of gold and silver wires, 8.
 for music printing plates, 6.
 for soldering aluminium, 4.
Alloy, new, for silvering, 404.
 new nickel, 5.
 of copper, platinum, and palladium, 403.
 resembling gold, 8.
 resembling silver, 8.
 Robertson's, for filling teeth, 3.
 unalterable, 7.
 which will not oxidize, 5.
Alloys, 3-8, 403-406.
 aluminium, 3, 4.
 available for spoons and forks, 6.
 density of, 405.
 English copper, 7, 8.
 exhibiting greater density than the mean of their constituents, 405.
 exhibiting less density than the mean of their constituents, 405.
 for dental purposes, 6.
 for journal-boxes, 6.
 for taking impressions of coins, medals, etc., 3.
 fusibility of, 405.
 manganese, 403, 404.
 resembling silver, 5, 403.
 silver and aluminium, 4.
 table of composition of, 8.
 which can be rolled at red heat, 6.
Almond, bitter, essence, 13.
Almonds, glazed, 84.
 roasted, 83.
Altars, to cleanse and renovate, 260.
Altwater's process of manufacturing vinegar, 355-358.
Alumina and iron mordants on cotton-prints, linen, etc., fixing of by water-glass, 379.
Aluminium acetate, 187.
 alloy for soldering aluminium, 4.
 alloys, 3.
 and gold alloys, 4.
 and iron alloy, 4.
 and silver alloys, 4.
 and tin alloys, 4.
 and zinc alloys, 4.
 bronze, 404.
 bronze, solder for gold on, 339.
 bronzes, 4.
 flux for soldering, 4.
 hydrate, 187.
 nitrate, 187.
 palmitate, its uses in industrial works, 211, 212.
 plating with, 111.
Alum in red wine, 3.
 manufacture of, from residues from shale oil, 247.
Ambergris essence, 13.
 water, 18.
Ambrosia, a new nourishing flour food, 133.

- American nickelling, 109.
 sleigh-bells, 5.
 woods, strength of some, 396.
- Amethyst, formula for, 11.
- Amianthus paper, 277.
- Ammoniacal liquor from coal-tar, utilization of, 373, 374.
- Ammonia, from gases of coke ovens, 374, 375.
 from nitrogeous organic substances, 377.
 liniment, 167.
- Ammonium, cupio, 453.
 nitrate, to protect from moisture, 32.
- Amorcés d' Allumettes, 237.
- Amorphous phosphorus, preparation of, 237, 238.
- Amyl alcohol, 229, 230.
- Anatomical specimens, fluids for preserving, 310, 311.
- Angel elixir, 17.
- Angelic cordial, 18.
 essence, 13.
 sweetmeat, 82.
- Anhydrous glucose, 341.
- Aniline colors, coloring osiers with, 459, 460.
 colors, to dye buttons with, 184.
 colors, to dye feathers with, 122.
 colors, to dye wool, silk, and cotton with, 100-105.
 inks, 198.
- Animal charcoal, furnace for continuous manufacture of, 444, 445.
 charcoal, to detect adulterations of, 1.
 oils, to purify, 251, 252.
 skins, dyeing and patterning, 219.
 skins, preparation, free from arsenic, for preserving, 408.
 skins, to preserve, 161.
- Animal waste, manure from, 169.
- Animalizing of hemp and jute, 105.
- Animals, stuffed, to preserve, 161.
- Anise-seed cordial, 17.
 essence, 13.
 extract, 13.
 tincture, 13.
- Anisette cordial, 17.
 French, 17.
 Holland, 18.
- Annoto and turmeric, the least stable yellow dyes, 3.
- Antarthritis papers, 298.
- Anthoine and Genaud, process for dynamite, 29.
- Antifricition brasses, 7.
- Antiphosphorus matches, 237.
- Antique green, 44.
- An.iscorbutic sweetmeat, 83.
- Antiseptic agents, effective power of different, 407.
 and preservative agents, 405-408.
- Antiseptics, new, 406, 407.
- Ants, to drive from closets, etc., 162.
- Apœnite, Ransome's patent, 50, 51.
- Apparatine sizing, 327.
- Apparatus for purifying water, 72.
 for testing percentage of nicotine in tobacco, 74.
- Appert's method of blowing glass by means of compressed air, 426-430.
- Apple champagne, 158.
 ratafia, 26.
 wine, 158.
- Aqua Bianca, 18.
 marine, formula for, 11.
 reale, 18.
 Turco liqueur, 18.
- Aquaria, cement for, 64.
- Armenian glue, 66.
- Aromatic balsam, 295, 296.
 cordial, 18.
 tincture, 13.
- Arsenical enamel, 144.
- Artificial alizarine, 186.
 building stone, 49.
 butter, 130-133.
 butter, to distinguish from genuine, 3.
 chalk, 174.
 cognac, 227.
 ebony, 177.
 eyes, manufacture of, 408, 409.
 flowers, mass for, 157.
 flowers, stains for paper for, 279.
 fruits, mass for, 157.
 gems, minerals for coloring, 12.
 gems, pearls, and Turkish beads, 9-12.
 gems, Wagner's formula for, 12.
 grindstones, 51.
 ivory, 43, 416.
 ivory for photographic purposes, 43.
 ivory, new, 43.
 leather, 174.
 marble, 51.
 millstones, 51.
 pearls, Geissler's process, 12.
 sandstone for filtering, 71.
 sharpening stone for pencils, 177.
 whalebone, 178.
 wines, 230, 231.
 wood for ornaments, 93.
 wool, 175.
 yeast, 401, 402.
- Artists' colors, 271, 272.
- Asbestos and its uses, 409.
 and rubber packing, 62.
 industry in England, 409.
- Ash and blood cement, 65.
- Asiatic dentifrice, 94.
- Asphaltum, adulteration of, 2.
 for paving, 53.
 Lyon's, 54.
 pitch, lampblack from, 371, 372.
- Asthma and colds, balsam for, 294.
- Astronomical instruments, lubricating oil for, 234.
- Atmography, 87.
- Atmosphere, window panes to indicate the moisture of, 447.
- Aubriat's process of decorating glass, 92.
- Augender's white powder, 30.
- Autogenous soldering, 337.
- Autographic ink, 192.
 method of printing, 86.
- Automatic gas-lighter, 173.
- Aventurine glass, 144.
- Axle boxes, Fenton's alloy for, 7.
- Axles, lubricants for, 232, 233.
- Backing glass signs with shades, pearl insertions, and with tinfoil, 148.
- Bacteria, to produce vinegar with, 358-360.
- Baeder, Adamson & Co.'s process of extracting castor oil, 247.

- Bags, to water-proof, 385, 386.
 Baking powders, 85, 86.
 Ballatschano and Trenck's new tanning process, 214.
 Balling's method of preparing caustic soda-lye, 335.
 Balloon varnish, 207, 208.
 Balls, billiard, composition for, 62.
 Balm of Gilead, 294.
 Balsam, aromatic, 295, 296.
 for colds and asthma, 204.
 for sprains, 296.
 for wounds, etc., 167, 168, 296.
 fumigating, 293.
 Bandage, plastic, 297.
 Bandoline, receipts for, 85, 86.
 Barbadoes essence, 13.
 ratafia, 25, 26.
 Bärenburg snuff, 353.
 Barium, sulphate of, for sizing, 327.
 Barff's preserving compound, 405, 406.
 Barley, germinating the, for brewing, 221.
 kiln-drying for brewing, 221.
 steeping the, for brewing, 221.
 Barrels and wooden articles, to preserve by use of water-glass, 382.
 leaky, cement for, 66.
 new glaze for, 223, 396, 397.
 to cleanse, 76.
 Baths, coppering, for iron and steel articles, 115.
 for coating wire, 114.
 for nickelling iron, steel, brass, copper, tin, Britannia metal, lead, zinc, and tinned sheet metal, 109-111.
 for photographic purposes, 300, 301.
 nickel, 109.
 Batiste, to wash, 363.
 Baudet's preventive of incrustations, 40.
 Beads, Turkish, 9-12.
 Turkish, formula for, 12.
 Becker, Delivaire & Co.'s process of water-proofing fabrics, 385.
 Bed-bugs, to destroy, 162.
 Beef's gall, as a varnish for oil paintings, 259.
 Beef, to smoke, 315.
 tea, to prepare, 165, 166.
 Beer, adulterations in, 223-226.
 brewing, 221-226.
 cooling, 222.
 flaxseed pulp for clarifying, 222, 223.
 ginger, 160.
 malt, 295.
 root, 160.
 spruce, 160.
 tests for, 223-226.
 to clarify, 222, 223.
 yeast, to prepare pressed yeast from, 402.
 Beeswax, to bleach, 387.
 Belladonna ointment, 166.
 Bell metal, best quality, 8.
 Bells, alloy for, 5.
 American sleigh, 5.
 and gongs, metal for, 8.
 metal for large and small, 8.
 Belmontine and Sherwood oils, 254.
 Belt grease, 435.
 Belts, caoutchouc lubricant for, 436.
 leather, cements for, 64.
 lubricant for, 233.
 Bending of glass tubes, 146.
 Bengal lights, 124.
 Benzine, in the extraction of fat of bones, 250.
 substitute for, in cleansing gloves, etc., 254.
 test of, 254, 255.
 Benzole, test of, 254, 255.
 Bergamot essence, 13.
 snuff, 353.
 Berlin bitters, 18.
 Beryl, formula for, 11.
 Bessemer steel, to silver, 112.
 Betton's cattle liniment, 167.
 Bianca, aqua, 18.
 Billiard balls, composition for, 62.
 Birch wine, 158.
 Birdlime, description of, 156.
 Bird of Paradise plumes, 118.
 Biscuit, meat, 130.
 Bismuth and platinum alloy, 4.
 lustre, 422.
 solder, 337.
 to silver wooden figures with, 91.
 Bisulphide of carbon in extracting oils, 247.
 of carbon, to purify, 77.
 of carbon, use of in determining oils in seeds, 1.
 Bitter almond essence, 13.
 almond soap, 331.
 elixir, 294.
 rossoli, 18.
 Bitters, Berlin, 18.
 coloring substances for, 12, 13.
 cordials, elixirs, liqueurs, ratafias, and essences; extracts, tinctures, and waters used in their manufacture, and the manner of coloring them, 12-27.
 English, 22.
 Greek, 22.
 Grünwald, extract for, 14.
 Hamburg, 22.
 Spanish, 24.
 Stettin, 24.
 stomach, 24, 25.
 Thiem's, 25.
 Vienna, 25.
 Vienna stomach, 25.
 Bitumen mortar, 53.
 Black and colored drawings upon ivory, 42.
 Blackboards, artificial slating for, 177.
 coating for, 266.
 Blackberry wine, 158.
 Black bronze, 46.
 bronze on brass, 46.
 colors, test for, 3.
 crayons, 79.
 gloss for leather, 215.
 ground for lacquering, 392.
 inks, 194, 195.
 mustard seed, yield of, in oil, 2.
 pigments, various kinds of, 266, 267.
 polish on iron and steel, 210.
 varnishes, 208.
 Blacking, new receipts for, 438, 439.
 Blacksmiths' pitch from coal tar, 257.
 Blasting cartridges, 424.
 compound, Faure & French's, 32.
 compound from potato-starch, 31.
 compound of honey and glycerine, 32.
 compounds by nitrating crude-tar oils, 33.

- Blasting compounds, blasting powder, dynamite, gun-cotton, gunpowder, nitro-glycerine, fulminates, etc., 27-34.**
 compounds, new, 32, 33.
 compounds, nitro-glycerine, fulminates, etc., 27-34.
 paper, 424.
 powder, by Martinsen, 32.
 powder, Green's, 31.
 powder, new, 425.
 powder, Trets', 30.
 under water with compressed gun-cotton, 424, 425.
- Bleach and harden tallow, to, 37.**
- Bleaching, 34-39, 409, 410.**
 bones and ivory, 41.
 bones for turners' use, Hedinger's method, 40.
 bristles, 37.
 copper plate engravings, 37.
 cotton, Frohnheiser's method, 34.
 cotton goods with woven borders, 34.
 cotton piece goods, 34.
 David's new process for, 38, 39.
 ivory articles, 43.
 ivory turned yellow, 40.
 muslin, 34.
 novelties in, 410.
 of bone fat, 447.
 of clothes which have turned yellow, 366.
 of oils and fats, 447, 448.
 of paraffine and similar substances for the manufacture of candles, 447.
 of silk, 36.
 of sponges, 37.
 straw, 455.
 shellac, 37, 38.
 stained marble, 39.
 tallow, 448, 449.
 willow-ware, 458.
 without chlorine, 409, 410.
 wool without sulphur, 36.
 with water-glass, 379, 380.
 yarns and fabrics, 410.
- Blistering ointment, 294.**
- Blood albumen, to prepare, 324, 325.**
 and ash cement, 65.
 from meat cattle, to prepare as a food, 312.
 manure powder from, 169.
- Blotters, porous substitute for, 178.**
- Blue bronze, 46.**
 chalks, 79.
 dyes, boiled with hydrochloric acid, 3.
 dyes, effect on alcohol, 3.
 pigments, 267.
 prints, 87.
 stamp color, 80.
 washing, manufacture of, 368-370.
- Bobbinet, size for, 325.**
- Boegel's quick process of tanning, 216.**
- Bohemian crystal and other glasses, 142, 143.**
- Boiler for glue, 150.**
 incrustations, 39, 40.
- Boilers, paper for covering, 455.**
- Bolts, screw, zincing of, 443, 444.**
- Bone and ivory, cement for, 65.**
 and ivory dyeing, 41.
 and ivory glue for, 66.
 fat, bleaching of, 447.
 glass, 144.
- Bone glue, 154.**
 horn, and ivory, to bleach and dye them, and make imitations and compositions, 40-44.
- Bones and ivory, bleaching, 41.**
 fat of, to bleach and purify, 250.
 receipts for coloring, 41, 42.
- Bon-bons, carrot, 81.**
 cream, 81.
 malt, 81.
 of caramel sugar with soft filling, to prepare, 81.
 pectoral, 81.
 raspberry, 81.
- Bonnet-frames, size for, 326, 327.**
- Bookbinders' lacquer, 210, 412.**
- Bookbinding, gilding and ornamenting, 410-412.**
- Book covers, improvement in the manufacture of, 412.**
- Books, glue for, 154.**
 to remove stains from, 77.
- Boots and shoes, French process of water-proofing, 385.**
 to make water-proof, 322.
 to prevent squeaking in, 322.
- Bordeaux wines, 230.**
- Borlinetto's gunpowder, 31.**
- Boro-glyceride, 405, 406.**
- Boro-glycerine, for preserving organic substances, 310.**
- Boro-tartrate for preserving meat, etc., 310.**
- Böttger, process for nitro-glycerine, 29.**
- Böttger's process of making petroleum clear as water without distilling, 252.**
 water-glass and lime cement, 382.
- Bottle-glass, 142, 143.**
- Bottles, manufacture of, from paper, 455.**
 transparent lacquer for closing, 211.
- Bouilhet and Christoffe, recipe for nickel alloy, 5.**
- Bouquets, 284.**
- Bouquet soap, 331.**
- Brass, bath for nickelling, 109.**
 black bronze on, 46.
 coatings, salts for, 114.
 cold black stain for, 413.
 dead black bronze on, 48.
 fire-proof bronze on, 45.
 for turned articles, 7.
 gold and orange stain for, 414.
 hard solder, 337.
 malleable, receipt for, 241.
 phosphorizing, 442, 443.
 steel-blue bronze on, 46.
 to cleanse, 415.
 to coat wire with, 114.
 very tenacious, 241.
 with zinc and copper, 7.
- Brasses, anti-friction, 7.**
 table of metal for, 406.
- Bread for horse-feed, 130.**
- Breslau bitter cordial, 18, 19.**
- Brewing beer, 221-226.**
 improved processes of, 222.
- Brewers' pitch, 223.**
- Brianchon's process of painting glass, etc., 137.**
- Brick and stone walls, to protect from moisture, 164.**

- Brick masonry made impervious to water, 55.
work, cheap paint for, 263, 264.
- Bricks, enamelled, 415, 416.
red wash for, 264.
size and weight of, 55.
- Bridges, iron, to protect from rust, 243.
- Bright lustre, 91.
- Brise-rocs, by Robaudi, 30.
- Bristles, to bleach, 37.
substitute for, 174.
- Britannia metal, bath for nickelling, 109.
metal, Köller's preparation of, 3.
metal, solder for, 339.
- Brocade, to wash, 362.
- Bronze alloy, platinum, 5.
aluminium, 404.
at time of Louis XIV., 7.
black, 46.
blue, 46.
brown, 46.
Chinese, 44.
color for direct printing upon paper, oil-cloth, etc., 190, 191.
colors, substitute for gum-Arabic in making, 48.
fire-proof, 45.
for cocks, 8.
for medals, 8.
for objects of art, 7.
for ornaments, 8.
for plaster of Paris figures, 45.
for rivets, 8.
gold, on iron, 46.
green, for brass, 44.
lacquer, 210.
manganese, 6, 405.
monuments, 48, 49.
phosphor, 404, 405.
phosphorizing, 442, 443.
powder, copper colored, 45.
powders, 45.
red, for turned articles, 8.
statuary, 8.
surface on iron, process for producing, 414.
Walker's, 46.
- Bronzes, aluminium, 4.
Chinese and Japanese, 7.
commercial, 45.
for castings, 8.
- Bronzing and coloring of metals, 44-49.
copper, 413.
gilding, silvering, 412-415.
Gourlier's salt mixtures for, 114.
green, 414.
in Paris mint, 44.
liquids, Graham's, 47, 48.
on iron, new process of, 414.
willow-ware, 460.
- Brown bronze, 46.
crayons, 79.
dyes, test for, 3.
- Brunswick black, 267.
- Brush, for marking boxes, 201.
- Brushes, paint, 260.
paint, to cleanse, 76.
- Buck-horn jelly, 85.
- Buffalo-skin, as substitute for horn, 178.
- Building materials, artificial stones, mortars, etc., 49-55.
materials, fire-resisting properties of, 415.
stone, artificial, 49.
stones, 51.
- Burgundy wines, 230.
- Busks for corsets, artificial whalebone for, 178.
- Busts, composition for, 62.
marble, to cleanse, 78.
- Butcher's fire-extinguishing powder, 124.
- Butter, artificial, 130-133.
rancid, to purify, 168.
to distinguish genuine from artificial, 3.
to pack for ocean transportation, 312.
to preserve, 312.
Vienna, 133.
- Buttons, compound for, 43.
from pulverized leather, 176.
from waste of horn, 44.
to color with aniline colors, 184.
to dye, 183, 184.
- Café, crème du, 83.
- Calamus liqueur, 19.
tincture, 14.
- Calcium acetate, 187.
and sodium glyceroborates, 406, 407.
chloride, concentration of vinegar with, 358.
silicate, use of in fixing mordants on cotton prints, linens, etc., 379.
- Calf-kid, manufacture of in Philadelphia, 214, 215.
- Calf leather, with a white flesh-side, smooth, 217.
- Calfskin, gilding on, 412.
- Callograph, Jacobsen's, 88.
- Cameos, how to produce, 202.
- Camphor and sulphur soap, 331.
ice, 294.
liniments, 167.
powdered, 298.
soap, 331.
- Canaster tobacco, 350.
- Candied cherries, 83, 84.
fruits, 84.
oranges, 84.
- Candle materials, coloring, 172.
- Candles, bleaching of paraffine and similar substances for manufacture of, 447.
colored firework, 124.
"Melanyl," 171.
stearine, cheap mode of making, 173.
tallow, Junemann's process of making, 172, 173.
tallow, to coat with a hard substance, 171, 172.
wax, 388.
wick-consuming, 172, 173.
wicks for, 171.
- Cane-heads, composition for, 183.
- Canes, walking, stain for, 392.
- Canned vegetables, new process of greening, 407.
- Cantharides, ointment, 166.
- Canvas, cordage, etc., to preserve, 169.
paint for, 263.
- Caoutchouc blackings, 320.
cements, 61.
cement, transparent, 61.

- Caoutchouc composition for sharpening and polishing knives, 60.
 dried, to remove stickiness from, 60.
 how to color green or black, 60.
 impregnating cloth with, 385.
 lubricant, 232.
 lubricant for driving-belts, 436.
 metallized, 60.
 new substitute for, 417, 418.
 oil, 320.
 solutions for photographers, 299.
 substitute for, 61, 62, 182.
 vulcanized cement for, 60.
 vulcanized, utilization of waste of, 60.
- Capsules, gelatine, 296.
- Capuchin cordial, 19.
- Caramel sugar bon-bons with soft filling, 81.
- Caraway essence, 14.
- Carboazotine, 29, 30.
- Carbolic acid paper, 275.
 preparation of lustre-colors with, 422.
- Carbon, bisulphide of, to purify, 77.
 bisulphide of, used in determining oils in seeds, 1.
 pencils, manufacture of, 430, 431.
- Cardamon, extract, 14.
- Cardinal de Rome, 19.
 water, 19.
- Carding engines, oil for, 234.
- Cards, enamel for, 421.
 to gild and silver, 91.
- Carlsbad water, artificial, 294.
- Carminative cordial, 19.
- Carmine and lake pigments, 268.
 indigo, 184, 185.
 indigo, to make, 269.
- Carpets, Clark's wash for, 366.
- Carriage lacquers, 214.
- Carrot bon-bons, 81.
- Cartridges, blasting, 424.
 for extinguishing fire, 124.
- Cartridge shells of easily combustible substances, 33.
- Cartwright's tooth powder, 94.
- Carved work, to polish, 209, 210.
- Case-hardening compound, 240.
- Caseine cements, 65.
- Cast-iron, substitute for, 176.
 tinning of, 113, 114.
 to enamel, 115, 116.
 to harden, 238.
 welding to steel, 238.
- Cast-steel, to restore burnt, 238.
- Castings, cement for repairing, 64.
 copper, dense and flexible, 242.
 mitis, 441.
 to obtain smooth, 240.
 wrought-iron, 441.
- Casts, plaster, which can be washed, 308-310.
- Castor oil, to make, 247.
- Cattle feed, from alcohol and yeast waste, 313.
 feed, to prepare, 312.
 liniment, 167.
- Caustic, lunar, to prepare, 73.
 potash; to purify water with, 72.
 soda-lye, to prepare, 335.
 soda to purify water, 72.
- Cedar wood, imitation of, 396.
- Ceilings, plaster for, 416.
- Celery ratafia, 27.
- Celluloid, caoutchouc, gutta-percha, and similar compositions, 58-63.
 how to work and treat, 59.
 imitations, substitutes, etc., 416-418.
 new, 59.
 preparation of, 58.
 preparation of, Magnus & Co.'s formula for, 58.
 printing plates, 416, 417.
 substitute for, 43.
- Cellulose dynamite, 29.
- Cement, artificial, Schüttler's, 52.
 blood and ash, 65.
 for glass retorts, 63.
 Chinese blood, 65.
 Davy's universal, 64.
 fire and water-proof, 63.
 for aquaria, 64.
 for fastening iron in stone, 64.
 for fastening rubber upon metal, 64.
 for filling teeth, 68, 69.
 for horses' hoofs, 61.
 for injured trees, 69.
 for iron stoves, 66.
 for ivory and bone, 65.
 for leaky barrels, 66.
 for leather, 65.
 for leather belts, 64.
 for meerscham, 65.
 for mending enamelled dial-plates, 421.
 for petroleum lamps, 65.
 for porcelain, 63.
 for repairing defective castings, 64.
 for repairing sandstone, 64.
 for rubber combs, 61.
 for rubber shoes and boots, 61.
 for steam-pipes, 63.
 for stone troughs, 64.
 for tortoise shell, 65.
 for vulcanized caoutchouc, 60.
 for wooden vats, 64.
 from blast-furnace slag, 51, 52.
 glycerine, 65.
 gutta-percha and linseed oil, 61.
 hard and durable, 52.
 hydraulic water-glass, 382.
 iron to iron, 63.
 jewellers', 66.
 mastic, 63.
 substitute for, 176.
 to harden, 52.
 water-glass, for glass and porcelain, 382.
 water-glass, with zinc and pyrolusite, 382.
 white, 52.
 work, 418.
 work, weather-proof, 418.
- Cementing cracked bottles with water-glass, 382.
 of metals, 116, 117.
- Cements, caoutchouc, 61.
 colors, enamels, glue, varnishes, water-proofing substances, etc., 421-423.
 for fastening metal letters upon glass, marble, etc., 64.
 gutta-percha, 61.
 pastes, and putties, 63-69.
 water-glass, 381, 382.
 water-glass and caseine, for glass and porcelain, 382.
 water-glass and lime, 382.
- Cerate, lead, 167.

- Chalk, artificial, 174.**
 precipitated, preparation of, for tooth powder, 446.
Chalks, blue, 79.
Chamois skins, dyeing, 217.
Champagne from fruits and berries, 157, 158.
 powder, 157.
 wines, 230.
Champagnes, artificial, 230, 231.
Charcoal, animal, furnace for continuous manufacture of, 444, 445.
 animal, to detect adulterations in, 1.
 tooth powder, 95.
Chartreuse, 19.
Cheese, English Stilton, 129.
Cheltenham salts, 294.
Chemical and techno-chemical expedients, preparations, 70-75.
 bronze, Walker's, 46.
 test of written documents, 201.
Cherries, candied, 83, 84.
Cherry cordial, 19, 20.
 extract, 14.
 liqueur, 19.
 marmalade, 84, 85
 sweetmeat, 82.
 water, 14.
 wine, 159.
Chestnuts, coated, 83.
Chicken feathers, utilization of, 165.
Chilblains, remedy for, 160.
Children, milk foods for, 132.
Chinese blood cement, 65.
 bronze, 44.
 bronze, imitations of, 7.
 bronzes, 7.
 drying oil, 248.
 liqueur, 26.
 lozenges, 84.
 silver alloy, 7.
 silver, preferable to pure or German silver for utensils, 7.
 varnish, 208.
Chip-hats, to wash, 366, 367.
Christoffe and Bouilhet, recipe for nickel alloys, 5.
Chlorine, fumigating with, 293.
 gas, to prepare, 72.
Chloride of gold, to prepare, 73.
 of silver and gelatine emulsion, 298.
 of sulphur ointment, 166.
 of zinc, to prepare, 72.
Chocolade, crème du, 83.
Chocolate and cocoa, 55-58.
 essence, 14.
 hygienic, 57.
 Iceland moss, 57.
 iron, 57.
 liqueur, 20.
 lozenges, 57.
 machines for manufacture of, 55, 56.
 Milan, 57.
 ordinary, 56.
 Paris, 57.
 Spanish spiced, 57.
 spiced, 56, 57.
 sweetmeat, 81.
 Vienna, 57.
 white, 58.
 with carbonate of iron, 57.
 with meat extract, 57.
Chrome-red, 269.
 yellow, 269, 270.
Chromium glue, 67.
Chrysolite, formula for, 11.
Chrysoprase, dark, formula for, 10.
 formula for, 10, 11.
 light, formula for, 11.
Chrysoline, composition and use of, 3.
Cider, 158.
Cigarette paper, 274.
Cigars, perfumes for, 354.
Cinnabar, imitation of, 421, 422.
Cinnamon essence, 14.
 sweetmeat, 82.
Circassian tooth powder, 95.
Citrate of magnesium, 296.
Citronat ratafia, 26.
Citronelle, 20.
Claret ratafia, 26.
Clarifying of beer, 222, 223.
 of varnishes and liquids, 205.
 olive oil, 449.
 slime in sugar houses, white or black pigment from, 376.
 the glue, 151.
Clay plaster, 53.
Clay, substitute for, 176.
Cleaning compound for cloth, 419.
 glass, silverware, and marble, 420, 421.
 powder for show windows, 419.
 smoky walls, 421.
Cleansing and washing clothes with the Panama essence, 368.
 brass, 415.
 cotton and other vegetable fibres, 34.
 fluid for tissues, 368.
 mixture for glass plates, 298, 299.
 oil paintings, 257.
 polishing, and renovating agents, 75-78, 419-421.
 rags for polishing metal, 419.
 silk, cloth, and hats, 76.
 silver dial plates, 42.
 wash leather, 419.
 woollen tissues, 35, 36.
Cloth as a substitute for leather, 383.
 cleaning compound, 419.
 down, 345.
 impregnating with caoutchouc, 385.
 Johnson's varnish for water-proofing, 423.
 oil, 345, 346.
 water proof, which is not impervious to the air, 383.
Cloths, red, cleansing salt for, 365.
 scouring soap for, 76.
Clove essence, 14.
Coach varnishing, 212-214.
Coal and rosin, fuel from, 137.
Coal ashes and blood, black pigment from, 267.
Coal ashes, manure from, 169.
Coal dust fuel, 137.
Coal-tar, ammoniacal liquor from, utilization of, 373, 374.
 blacksmiths' pitch from, 257.
 for printing ink, 190.
 lampblack from the resinous sodic residues of, 372.
 manures from the residues of, 373.
 naphtha, test of, 254, 255.
 oil, process of producing in England, 256, 257.

- Coal-tar oils, shoemakers' wax from, 257.
 oil, to deodorize, 252.
 varnish oil, 190, 256.
 varnish oil, lubricating oils from, 234.
 varnish oil, varnishes with, 212.
 waste, lampblack from, 370-372.
- Coated chestnuts, 83.
 filberts, 83.
 orange blossoms, 84.
- Cobalt, 111.
 blue for crayons, 79.
 electroplating metal with, 111.
- Cochineal syrup, 136.
- Cockroaches, to destroy, 162.
- Cocks, bronze for, 8.
- Cocoa and chocolate, 55-58.
- Cocanut oil and molasses soap, 329, 330.
 oil soap, 328, 329.
- Cocoa ratafia, 26.
- Cod-liver-oil and iodide of iron, 294, 295.
 to disguise the taste of, 166, 296.
- Coffee and tea trays, to clean, 78.
 essence, 14.
 malt as a substitute for, 157.
 substitute for, 169.
 to regain the volatile products developed in
 roasting, 377, 378.
- Cognac, artificial, 227.
 essence, 14.
 manufacture of, 227.
- Coignet's artificial stone, 49.
- Coin metal, 8.
- Coke ovens, to preserve the ammonia, tar, and
 other products from, 374, 375.
- Cold tinning, 114.
 water soap, 329.
- Colds and asthma, balsam for, 294.
- Collodion emulsion, 306.
 for plant slips, 165.
 glycerine, 296.
 styptic, 296.
 varnish for water-proofing fabrics, prepara-
 tion of, 383.
- Cologne waters, 282.
- Colombat elixir, 17.
- Colored chalks (crayons), pencils, and inks for
 marking linen, etc., 78-80.
 designs upon glass, 145.
 enamels, 117.
 fluids for paper and foils, 202.
 glass, compositions for, 144, 145.
 indelible inks, 80.
 sands, 201.
- Coloring materials for wood, 391, 392.
 metals, 46, 47.
 substances for cordials, bitters, etc., 12,
 13.
- Colorless varnish, 210.
- Colors, artists', 271, 272.
 enamels, cements, glue, varnishes, water-
 proofing substances, etc., 421-423.
 fireproof, 454.
 for painting, receipts for, 262, 263.
 fusible, for porcelain painting, 137-141.
 grinding of, 260.
 lustre, preparation of with carbolic acid,
 422.
 new, on wood, 398, 399.
 printing, German patent, 190.
 printing in, 86, 87.
 sympathetic, 273.
- Colors, water, 272, 273.
- Combs, horn, manufacture of, 435.
 horn, to make elastic, 446.
- Combustion, spontaneous, experiments with
 oils in regard to, 438.
- Commercial bronzes, 46.
- Composition for billiard balls, 62.
 for ornaments, etc., 62.
 for picture frames, 62.
 for razor strops, 63.
 for rollers, 62.
- Compound for buttons, dice, etc., 43.
 water-glass, preparations of, 378, 379.
- Compressed yeast, to make, 227-229.
- Concrete marble, 64.
- Condensed milks, 132.
- Conductors, electrical, insulating material for,
 417.
- Confectionery, 80-86.
- Cooking utensils, tinning of, 114.
- Copal varnish, to make, 202-206, 208.
 varnishes with coal-tar varnish oils, 212.
- Copper alloys, 7, 8.
 as a solder for iron, 337.
 bath for nickelling, 109.
 bronzing on, 413.
 castings, dense and flexible, 242.
 cold silvering of, 112, 113.
 fireproof bronze on, 45.
 gilding of, by boiling, 111.
 plate engravings, to bleach, 37.
 platinum and palladium alloy, 403.
 steel, receipt for, 242.
 sulphate of, to prepare, 74.
 to give it a durable lustre, 46.
 to weld, 241.
 vessels, to enamel, 116.
- Coppering bath for iron or steel articles, 115.
 galvanic, Gourlier's salt mixture for, 114.
- Copying, 423.
 and printing, 86-89.
 drawings in black lines on white ground,
 87.
 inks, 103, 196-198.
 paper, that can be washed, 276.
 polygraphic method of, 87, 88.
- Corals, to dye imitations of, 105.
- Cordage, to preserve, 169.
- Cordial, Angelica, 18.
 anisette, 17.
 anise seed, 17.
 aromatic, 18.
 Breslau bitter, 18, 19.
 capuchin, 19.
 carminative, 19.
 cherry, 19, 20.
 cumin, 20.
 kümmel, 20.
 orange-peel, 23.
 peach, 23.
 peppermint, 23.
 quince, 23.
 quittico, 23.
 rosemary, 23, 24.
 Swiss, 25.
 Tivoli, 25.
 vanilla, 25.
 wormwood, 25.
- Cordials, bitters, liqueurs, and ratafias, 17-27.
 coloring substances for, 12, 13.
 liqueurs, etc., mode of coloring, 12.

- Cordova blacking, 320.
 Cork, gas from, 170.
 paper, 275.
 stone, 415.
 waste, utilization of in the manufacture of
 vinegar, 358.
 Corks, rubber, to cut and pierce, 164.
 rubber, to restore, 377.
 Corn oil from corn mash, 251.
 Corns, remedy for, 160.
 Corset busks, artificial whalebone for, 178.
 Cosmetic and medicated waters, 290-292.
 powders, rouges, 292.
 Cosmoline, to prepare, 248, 249.
 Cotton and linen goods, finishing of by water-
 glass, 380.
 and muslin prints, to wash without injury
 to the colors, 368.
 and silk goods, soap for removing stains
 from, 76.
 and vegetable fibres, cleansing of, 34.
 fabrics, to tan, 220.
 goods and yarns, 20.
 goods, sizing for, 322, 323.
 goods with woven borders, to bleach, 34.
 Cotton, gun, 32.
 Cotton piece goods, to bleach, 34.
 prints, dressing for, 325, 326.
 Cotton-seed hulls, utilizing, 451.
 oil in olive oil, 1.
 oil, manufacture of, 449, 450.
 oil, production of soap and sebacic acids
 from crude, 451.
 oil, refining, 251, 451.
 Cotton tissues, to compress and give more
 lustre to, 345.
 to bleach as it comes from the spinning-
 machine, 34.
 to gild, 91, 92.
 wool, and silk, to dye with aniline colors,
 100-105.
 yarns and tissues, Banes' and Grisdale's
 method for bleaching, 34.
 yarn, size for, 325.
 Cowles' electric furnace, 440, 441.
 Crambambuli, 20.
 Cramer's process of preparing pressed yeast
 from beer yeast, 402.
 Crape, white silk, to wash, 363.
 Crayons, black, 79.
 brown, 79.
 crimson, 79.
 green, 79.
 materials, how to select, 78, 79.
 red, 79.
 white, 79.
 yellow, 79.
 Cream bon-bons, 81.
 of tartar, to prepare, 73.
 shaving, 446, 447.
 walnuts, 81.
 Creams, soap, 332, 333.
 Crème du café, 83.
 du chocolate, 83.
 Fondant, 85.
 ground mass for, 85.
 Creosote ointment, 166.
 to prepare from wood-tar oil, 255.
 Creuzburg's process of making water-glass
 paint more durable than oil or varnish,
 381.
- Crimson crayons, 79.
 dye starch, 365.
 Crock, W. G., process for detecting artificial
 butter, 3.
 Crocus vernus, adulteration of saffron with, 2.
 Crown glass, 143.
 Cryolite glass, 142.
 Crystal glass, 142.
 Crystalline coating for wood or paper, 421.
 Crystallized indigo, 184.
 Cumin cordial, 20.
 essence, 14.
 liqueur, 20.
 Cupro-ammonium for rendering paper and
 textile fabrics water-, rot-, and insect-
 proof, 453, 454.
 Curaçoa, 20.
 French, 20.
 Holland, 20.
 Currant wine, 159.
 Currier's black gloss, 215.
 Cutlery, fluid for hardening, 240.
 Cyanide of potassium, from nitrogeous or-
 ganic substances, 377.
 Cyanotype, 87.
 Cyclostyle, the, 88, 89.
 Cypre, eau de, 21.
- D'Absynth Citronné, eau, 21.
 D'Amour parfait, 23.
 Damask, genuine, 89.
 imitation of, 89.
 silk, to wash, 362.
 Damaskeening steel, 89.
 steel with gold or silver, 89.
 Damp walls, glue for, 235.
 walls, how to dry, 54.
 walls, plaster for, 53.
 Damson wine, 159.
 Danzig crambambuli, 20.
 Darcet's metal, 337.
 Dauphin, eau de, 21.
 David's new process for bleaching, 38, 39.
 Davy's universal cement, 64.
 Dead black bronze on brass, 48.
 Dead lustre, 91.
 Debray on the effect of iron in aluminium,
 5.
 Decoration, ornamentation, etc., 89-94.
 Decorations, to make incombustible, 124.
 wood-tar for, 93.
 Denninger's process of staining wood for fine
 cabinet work, 391.
 Density of alloys, 405.
 Dental purposes, alloys for, 6.
 Dentifrice, Asiatic, 94.
 Quillaya, 95.
 Dentifrices and mouth washes, 94, 95.
 Depilation of hides, 215, 216.
 Deschamps' tooth powders, 94.
 Designs, to copy, 86.
 De Soulages and Cahuc, process for carboï-
 zotine, 29, 30.
 Detection of water in essential oils, 449.
 Developer, alkaline gelatine, 298.
 for photographic dry plates, 301.
 Sutton's new, 306.
 Developers, photographic, for hot weather,
 306, 307.
 Dextrine and sugar in malt, 221.
 milk adulterated with, 2.

- Dextrine, to prepare, 325.
 Dextrose, 341, 342.
 Dial-plates, enamelled, cement for mending, 421.
 silvered, to cleanse, 421.
 Dials, watch, enamel for, 117.
 Diamond glue, best quality, 66, 67.
 Dice, compound for, 43.
 Dictamia, composition of, 129.
 Disinfectants, 163, 164.
 Dittmar's dualin, 29.
 Documents, chemical test of written, 201.
 papers for, 274.
 Dolls' heads, mass for, 62, 63.
 Dominos, compound for, 43.
 Donault-Wieland's flux, 10.
 Dougal's powder for purifying air in stables, 168.
 Doumesnil's process of platinizing metals, 110, 111.
 Down cloth, 345.
 Drawing-paper that can be washed, 276.
 Drawings, lacquer for, 211.
 new method of copying, 423, 424.
 to copy, 86.
 to copy in black lines on white ground, 87.
 to duplicate, 86.
 to make black and colored on ivory, 42.
 Dressing cotton prints, 325, 326.
 for dancing shoes, 320.
 for Panama hats, 326.
 for shoes free from sulphuric acid, 320.
 Dried caoutchouc, to remove stickiness from, 60.
 Drops, peppermint, 84.
 punch, 84.
 Dryers for oil colors and varnish, 266.
 receipts for, 266.
 Drying oil, 266.
 oil, Chinese, 248.
 wood, new method of, 397.
 Dry pocket paste, 68.
 Dualin, Dittmar's, 29.
 Dupasquier's process of preparing bone glue as a substitute for isinglass, 155, 156.
 Durability of mine timbers, 395, 396.
 Durable paste, 69.
 Dutch Musino snuff, 353.
 Dye, new, from shoots of poplar tree, 107.
 starch, 365.
 Dyeing and printing, inspissation for, 323, 324.
 bone and ivory, 41.
 cotton yarn Turkey red with alizarine, 106, 107.
 leather, 217-221.
 naturally white skins, 220.
 rabbit skins, 219.
 sheepskins, 219, 220.
 straw, 455, 456.
 woollen and cotton goods and yarns, silk, straw hats, felt hats, kid gloves, horse-hair, etc., etc., 107.
 wool, silk, and cotton with aniline colors, 100-105.
 Dyes for straws, 456.
 hair, 289, 290.
 testing of, for adulteration, 3.
 Dynamite, A. Nobel's process, 29.
 by Anthoine and Genaud, 29.
 cellulose, 29.
 Dynamite, frozen, 30.
 giant, 31.
 gun-cotton, gunpowder, nitro-glycerine, fulminates, etc., 27-34.
 Norbin and Ohlson's patent, 29.
 properties of, 29.
 Sobrero's process, 29.
 Earthenware, fire and water-proof cement for, 63.
 glazes for, 146.
 to give it a marbled or granite appearance, 147.
 varnish for, 208.
 Eau Americaine, 20.
 D'Amour, 21.
 D'Absynth Citronné, 21.
 D'Ardelle, 21.
 D'Argent, 21.
 d'Or, 21.
 d'Orient, 21.
 de Cologne, 282.
 de Cypre, 21.
 de Dauphin, 21.
 de Lavande Ambra, 282.
 de Napoléon, 21.
 de Paradise, 22.
 de Paris, 282.
 de Santé, 22.
 de Sept Graines, 22.
 des Alpes, 282.
 des Princesses, 22.
 precieuse, 22.
 royal, 22.
 Ebony, artificial, 177.
 stains, 393.
 Edinburgh ink, 196.
 Edison's electric pen, 88.
 Effervescing vinegar, 361.
 Egg syrup, 136.
 Eggs, to preserve, 312, 313.
 yelks of in tawing, to preserve, 217.
 Elaeosaccharum, 80.
 Elaine soap, 329.
 Elastic lacquer, 211.
 Elderberry ointment, 166.
 wine, 159.
 Elder blossoms, extract of, 166.
 Electrical conductors, insulating material for, 417.
 Electric furnace, Cowles', 440, 441.
 pen, Edison's, 88.
 Electricity, 110.
 Electro-plating, galvanoplasty, gilding, nickelling, silvering, tinning, etc., 107-115.
 Elemi ointment, 166.
 Elixir, Abbé, 16.
 Angel, 17.
 Colombat, 17.
 de St. Aur, 17.
 des Troubadours, 17.
 juniper, 17.
 Monpou, 17.
 of life, 17.
 Tabourey, 17.
 vital, 17.
 Elixirs, 16, 17.
 Email photographs, 300.
 Embossing, preparation of surfaces for, 345.
 Embroidered fabrics woven with gold, to wash, 364.

- Embroidered linen, to wash, 364.
 muslin, to wash, 364.
- Embroideries, pearl, to wash, 366.
- Embroidery, silver, to polish, 364.
- Emerald, formula for, 10.
 green for gems, formula of, 10.
- Emery paper, 278, 279.
- Emulsion, for photographers, 298.
 sensitive collodion, 306.
- Emulsions, gelatine, photographic, 300.
- Enamel, arsenical, 144.
 for fine cards, etc., 421.
 for sheet-iron, 116.
 for watch dials, 117.
 free from lead and metallic oxides for iron
 and sheet-iron, and utensils manufact-
 ured from them, 422.
 glass for iron, 118.
 opaque white, 118.
 phosphorescent, 422.
 tin, 144.
- Enamelled bricks, 415, 416.
 dial-plates, cement for mending, 421.
 photographs, 300.
- Enamelling and cementing of metals, etc.,
 116, 117.
 cast-iron utensils, 115, 116.
 of copper vessels, 116.
 of iron, 116.
 of pasteboard, 277.
- Enamels and enamelling, 115-118.
 colors, cements, glue, varnishes, water-
 proofing substances, etc., 421-423.
 colors for, 117, 118.
 imitations of, 179.
- English bitters, 22.
 bitters essence, 14.
 bitters ratafia, 26.
 copper alloys, 7, 8.
 inks, 196.
 method of varnishing coaches, 212-214.
 Stilton cheese, 129.
- Engraving on glass, 145.
- Engraviugs, to copy, 86.
- Erasing powder, 295.
- Esprit de Pachouli, 282.
 de rose triple, 282.
 de toilette Française, 282, 283.
- Essence, ambergris, 13.
 angelica, 13.
 anise-seed, 13.
 Barbadoes, 13.
 bergamot, 13.
 bouquet, 283.
 chocolate, 14.
 cinnamon, 14.
 clove, 14.
 coffee, 14.
 cognac, 14.
 cumin and caraway, 14.
 de Goudron, 231.
 English bitter, 14.
 extracts, tinctures, and waters, 13-16.
 fennel, 14.
 gold water, 14, 15.
 herb cordial, 15.
 juniper berry, 15.
 lavender, 15.
 lemon, 15.
 marjoram, 15.
 musk, 15.
- Essence, nut, 15.
 nutmeg, 15.
 Panama, for washing, 368.
 Parfait d'Amour, 15.
 peach, 15.
 peppermint, 16.
 quince, 16.
 rose, 16.
 rosemary, 16.
 sage, 16.
 Spanish bitter, 16.
 vanilla, 16.
 wormwood, 16.
- Essential oils, detection of water in, 449.
- Estragon vinegar, 361.
- Etching ground, printing ink which can be
 used as, 191.
 ink for glass, 431.
 on glass, 147.
- Ether, acetic, to prepare, 358.
 naphtha, 170.
- Eugenie's nosegay, 282.
- Expedients, preparations, 70-75.
- Explosive agents, 424-426.
 and pyrotechnic substances, 424.
 combination, 424.
 substances, 424.
 substances, use of hyponitric acid for,
 425, 426.
- Exterminator, moth and roach, 446.
- Extract, anise-seed, 13.
 cardamon, 14.
 Koch's herb, 23.
 mace, 13.
 of elder blossoms, 166.
 orange blossom, 15.
 orange peel, 15.
 raspberry, 16.
 soup, 129.
 strawberry, 16.
- Extracts, 283, 284.
 essences, tinctures, and waters, 13-16.
 malt, 296.
- Eyes, artificial, manufacture of, 408, 409.
- Fabrics, colored, to give a lustre to, 316.
 double, water-proof not impermeable to
 air, 385.
 linen, hempen, and cotton, to tan, 220.
 metallic lustre upon, 348.
 new process for water proofing, 385.
 textile, to render water-, rot-, and insect-
 proof, 453, 454.
 textile, to water-proof, 384.
 textile, to water-proof and give greater con-
 sistence to, 386.
 to water-proof and protect against moths,
 386, 387.
 water-proof and incombustible, new method
 for the production of, 422.
 woollen, to water-proof, 384.
- Facon rum, 229.
- Faded manuscripts, to restore, 74, 75.
- Falcon plumes, 118.
- Fancy articles, alloy for, 5.
- Fat, bone, bleaching of, 447.
 from sheep's wool, 450.
 of bones, to utilize in the manufacture of
 soap, 250.
 oils, vegetable, French process of cleans-
 ing, 247.

- Fat, to recover from waste wash liquors, 376, 377.
rancid, to purify, 168.
- Fats, separating and purifying, 255, 256.
and oils, 247-257, 447-453.
and oils, bleaching of, 447, 448.
new process of treating, 334, 335.
- Faure & French's blasting powder, 32.
- Feather plush, 244.
- Feathers, chicken, utilization of, 165.
how to restore and dye, 118-122.
to bleach, 119.
to cleanse, 365.
to dye with aniline colors, 122.
to restore crushed and bent, 119.
to wash, restore, and dye ostrich marabouts, etc., 118-122.
- Fecal substances, to work in a rarefied space, 376.
- Feed, pressed horse, 129.
- Felted fabrics, to dye with aniline colors, 103, 104.
- Felt, to water-proof, and give greater consistence to, 384.
hats, to water-proof, 386.
substitute for, 176.
roofing, oil paint for, 52.
- Female pills, 294.
- Fennel essence, 14.
ratafia, 26.
- Fenton's alloy for axle boxes, 7.
- Fermentation, 222.
- Ferrocyanide, potassium, 70.
- Ferrous nitrate syrup, 136.
- Fibres from nettles, hemp, jute, etc., to prepare, 346, 347.
vegetable, improved treatment of, 345.
vegetable, to animalize, 346.
vegetable, to water-proof, 384.
- Fibrous substances, to gain from different plants, 274.
- Field rats and mice, to destroy, 162.
- Filberts, coated, 83.
roasted, 83.
- Filbert sweetmeat, 82.
- Files, to cleanse, 76.
to harden, 239.
to sharpen, 239, 240.
- Filling for caramel sugar bon-bons, 81.
- Filtering, artificial stone for, 71.
of varnishes, 205, 206.
- Fire and water-proof cement, 63.
cartridges for extinguishing, 124.
extinguishing agents and means of making tissues, wood, etc., incombustible, 122-124.
extinguishing hand grenades, 124.
extinguishing powders, Munich and Vienna, 123.
plating for iron, 115.
- Fire-proof bronze, 45.
ceilings, mass for, 416.
floors, mass for, 416.
papers, colors, and printed matter, 454.
wood, preparation of, 399.
resisting properties of building materials, 415.
- Fires, white, 125.
- Fireworks, 124-129.
for rooms, 128.
- Fish, fluids for preserving, 311.
- Fish oil, new process of extracting, 451.
to preserve, 313.
- Fixateur, receipts for, 85, 86.
- Flaxseed pulp, for clarifying beer, 222, 223.
yield of oil in, 2.
- Flax yarn, C. Hartmann's quick method of bleaching, 36, 37.
- Fleas on animals, to destroy, 162.
- Fleece, to remove oil from, 346.
- Fleitmann's process of refining nickel, 441.
- Flexible insulating mass, 417.
mirrors, 178.
- Flint glass, 143.
- Floating soap, 329.
- Floor covering, new, 445.
wax, 389.
- Floors, cheap paint for, 263.
fire-proof, mass for, 416.
new compound for waxing, 389.
stain for, 393.
- Flour, meat, 129.
potato, for soups, 130.
potato, to prepare, 157.
- Flowers, artificial, mass for, 157.
artificial, paper stains for, 279.
extraction of perfume from, 282.
guano solution for, 169.
lacquer for, 209.
on glass, 94.
- Fluid hydrastis, 297.
le François, scouring, 75.
paste, 68.
- Fluids for making tissues incombustible, 123.
- Flux, Donault-Wieland's, 10.
for soldering aluminium, 4.
Schrader's, components of, 9.
- Fluxes, components of, for artificial gems, 9, 10.
for enamels, preparation of, 117.
- Fly glue, composition for, 156, 157.
paper, to prepare, 161.
- Focal distances for enlarging photographic pictures, 299.
- Foils, gelatine, 181, 182.
jewellers', 202.
- Folbacci's process of rendering wood incombustible and impermeable, 390.
- Food and food preparations, 129-133.
- Foods, strengthening, 129.
- Forcite, 33.
- Forks, alloys for, 6.
- Foul air in wells, to remove, 168.
- Fountain, table, to construct, 157.
- Fournaise's water-proofing compound, 386.
- Frames, gilding, 90, 91.
- Frame work of old altars, to cleanse and renovate, 260.
- Frankfort black, 267.
snuff, 354.
- Franzl, process for cellulose dynamite, 29.
- Frear's artificial stone, 51.
- Freckles, vinegar to remove, 285.
- Freezing mixtures, 133, 134.
salt, 133.
- French anisette, 17.
curaçoa, 20.
putty for wood, 67.
- Frohnheiser's method of bleaching cotton, 34.
- Frosted glass, ornamenting, 434.
limbs, soap for, 332.
- Frozen dynamite, 30.

- Frozen ground, to thaw, 70, 71.
 Fruit and other syrups, 134-136.
 -drying apparatus, new, 407.
 jellies, to prevent moulding, 315.
 stains, to remove, 75.
 to dry by cold air blast, 312.
 to pack for transportation, 312.
 wines, 158-160.
 wrapping paper for, 276.
 Fruits, artificial, mass for, 157.
 candied, 84.
 fluids for preserving, 311.
 to keep, in ice-houses, 169.
 to preserve, 314, 315.
 Fulminate, 33, 34.
 of mercury, 33.
 of silver, 33.
 Fulminating gold, 34.
 platinum, 33, 34.
 Fumigating articles, 292-294.
 Furnace, continuously working, for manufac-
 ture of animal charcoal, 444, 445.
 Cowles' electric, 440, 441.
 Jesem's glass melting, 9.
 Furniture glue, 154.
 oak, to cleanse and beautify, 78.
 renovator, 419.
 varnish, 209.
 wax, 389.
 Furs, to protect, 161.
 to protect from moths, 220.
 Fusel oil, to destroy, 229, 230.
 Fusible alloy, 5.
 alloys, lowest melting points of, 6.
 colors used in porcelain painting, 137-141.
 Fusibility of alloys, 405.
 Fustic as a yellow dye, 3.
 Galbanum and saffron plaster, 297.
 Gall, beef's, as a varnish on paintings, 259.
 -nut ointment, 166.
 soap, 331.
 Galvanic coppering, salt mixtures for (Gour-
 lier's), 114.
 Galvanizing and nickelling of iron in Cleve-
 land, 413.
 iron, new process of, 114.
 Galvano-plastic deposits, moulds for, 115.
 silvering, 112.
 Galvanoplasty, 107-115.
 "Gantein," for cleansing gloves, 75.
 Garnet, formula for, 11.
 Garvey's lithomarlite, 51.
 Gas, chlorine, to prepare, 72.
 from cork, 170.
 from lignoin and air, 171.
 from nitrogenous organic substances, 377.
 leaks, to detect, 171.
 lighter, automatic, 173.
 lime, sulphur and sulphuric acid from, 376.
 meters, dry, 170, 171.
 meters, tissue for, 170, 171.
 pipes from paper, 451.
 purification of, 171.
 Gases, of coke ovens, distillation of, 374, 375.
 Gauze, silk, 348.
 white, to wash, 363.
 Geitner's alizarine liquor, 187.
 Gelatine, alcoholic solution of, 298.
 capsules, 296.
 emulsions, photographic, 300.
 Gelatine foils, 181, 182.
 jelly, 85.
 Maclagan's apparatus and process for
 making, 153.
 plates, developer for, 299.
 to make from glue, 154.
 Gelatinography, for duplicating drawings, 86.
 Gelatinous nitro-glycerine, 33.
 Gems, artificial, 9-12.
 artificial, minerals for coloring, 12.
 artificial, Wagner's formula for, 12.
 German silver solder, 337, 338.
 tree wax, 69.
 Giant dynamite, 31.
 powder, 32.
 powder, new method of preparing, 425.
 Gilding and silvering cards, 91.
 and silvering, detection of imitations, 2.
 and silvering leather, 445.
 and silvering silk, cotton and woollen
 yarns, 92.
 an ornamental frame, 90, 91.
 bronzing, silvering, etc., 412-415.
 copper by boiling, 111.
 cotton, 91, 92.
 glass, 89, 90, 147, 148.
 of steel, 413, 414.
 on wood, 394, 395.
 paper, leather, etc., rosin compound for,
 411.
 porcelain, 90.
 soap varnish for, 423.
 to restore the lustre of, 260.
 willow-ware, 460.
 wood, Italian method of, 90, 92.
 Ginger beer, 160.
 lozenges, 84.
 ratafia, 26.
 wine, 159.
 Gin, Holland, receipt for, 229.
 Glacé photographs, 300.
 Glass, 426-435.
 alabaster, 144.
 and metals, painting with water-glass, 381.
 and other signs, 147-149.
 and porcelain, water-glass and caseine
 cement for, 382.
 and porcelain, water-glass cement for, 382.
 aventurine, 144.
 black and colored lead-pencils for, 432.
 blowing, by means of compressed air,
 426-430.
 Bohemian chalk, 142.
 Bohemian crystal, 142.
 bone, 144.
 caoutchouc cements for, 61.
 colored, compositions for, 144, 145.
 colored designs on, 145.
 compositions of, as actually used in various
 glass-works, 142-144.
 composition of colors for and processes
 for enamelling, engraving, gilding, bend-
 ing, etc., 141-146.
 compound water, to prepare, 378, 379.
 crown, 143.
 cutting, with a carbon pencil, 430, 431.
 decorating, 92.
 Elli's cryolite, 142.
 enamel for iron, 118.
 engraving on, 145.
 etching ink for, 431.

- Glass, etching on, 147.
 flint, 143.
 for bottles, 141-143.
 for champagne bottles, 142.
 French soda, 142.
 frosted, ornamenting, 434.
 gilding and silvering, 147, 148.
 gilding of, 89, 90.
 gutta-percha cements for, 61.
 headed pins with copper lustre, 431, 432.
 impressions of flowers on, 94.
 iridescent, 145.
 lead crystal, 143.
 -like varnish, 210.
 lithium, 432.
 melting furnace, by Th. Jesem, 9.
 new materials for, 145.
 new solder for, 441.
 opal, 144.
 opaque, compositions for, 144.
 pencils for writing on, 79.
 plate, 142.
 plate, manufacture of, 432-434.
 plates, cleansing mixtures for, 298, 299.
 plate, polishing powder for, 77.
 platinizing, 434.
 polishing agents for, 433, 434.
 polishing powder for, 76.
 potash water, to prepare, 378.
 retorts, cement for, 63.
 roofs, to make water-tight, 55.
 semi-white, potash window, 143.
 signs, backing of, 148.
 soda, 142, 143.
 to clean, 420.
 to make opaque or frosted, 92.
 to pulverize, 146.
 toughened, 434, 435.
 to wood, joining, 66.
 transferring photographs to, 434.
 tubes, how to bend, 146.
 water, as a bleaching agent, 379, 380.
 water, characteristics of, 378.
 water, for finishing linen and cotton goods, 380.
 water, for silicifying stones, 379.
 water, from infusorial earth, 378.
 water, its uses, 378-382.
 water, Kuhlmann's process, 379.
 water, preparation of fixing, 379.
 window, 142.
 window, substitute for, 178.
 with copper lustre, 431, 432.
- Glasses and saucers, to cleanse, 76.
- Glazed almonds, 84.
 papers, stains for, 279, 280.
- Glaze for beer barrels, 223.
 for common earthenware, 146.
 new, for barrels, vats, etc., 396, 397.
- Glazes, Berlin white, etc., 146, 147.
 for colored goods, 326.
 for earthenware, 146, 147.
 for metals, 244, 245.
 free from lead, 146.
- Gloss on wall papers, 323, 324.
 for toilet soaps, 334.
- Gloves, kid, to dye with aniline colors, 104, 105.
 preparation for cleansing, 75.
 to cleanse without wetting, 78.
- Glucose, anhydrous, 341.
 sugars, etc., 340-344.
 to remove gypsum from solutions of, 342.
- Glue and wood putty, 67
 Armenian, 66.
 as a substitute for isinglass, 155.
 boiling, with wet and dry waste, 150.
 bone, 154.
 chromium, 67.
 clarifying, the, 151.
 cold liquid, 154.
 diamond, 66, 67.
 fly, composition for, 156, 157.
 for books, 154.
 for fancy articles, etc., 66.
 for fine leather, 66.
 for imitations of pearl and marble, 178-181.
 for ivory and bone, 66.
 for joining glass to wood, 66.
 for labels, 66.
 from seaweeds, 177.
 furniture, 154.
 glycerine for enclosing microscopic objects, 68.
 liquid steam, 154.
 liquid, to prepare, 66.
 MacLagan's apparatus and process for making, 153.
 manufacture of, 149.
 marine, 235.
 moulding, 1
 mouth, 67.
 new liquid, 154.
 parchment, 411.
 stock, materials of, 149.
 stock, steeping in lime, 149, 150.
 taking it from the moulds, 152.
 to color yellow, 151.
 to make from tannery waste, 152.
 to whiten, 151.
 water-proof, 154, 423.
- Glutine, for wall papers and for dyeing and printing purposes, 323, 324.
 thickening of, 323, 324.
- Glycerine cement, 65.
 collodion, 295.
 glue for enclosing microscopic objects, 68.
 soap, 331, 332.
 solvent, power of, 453.
 to gain from soapboilers' lye, 250, 251.
 use in sizing and dressing, 323.
 Wilson's process for preparing, 74.
- Glyceroborates, calcium and sodium, 406, 407.
- Gold, alloy resembling, 8.
 and aluminium alloys, 4.
 and orange stain for brass, 414.
 and silver lace, to wash, 362, 363.
 and silver wires, alloys for imitating, 8.
 bronze on iron, 46.
 chloride of, to prepare, 73.
 color, brilliant, on plated articles, 111.
 for illuminating, 90.
 fulminating, 34.
 polishing powder for, 76.
 size, 149.
 solders, 338.
 substitute for, 4.
 to cleanse, 78.
 to regain from old toning baths, 304.
 varnish on iron, 208.

- Gold wall paper, new process of manufacturing, 445, 446.
 water, 21.
 water essence, 14, 15.
- Gongs and bells, metal for, 8.
- Goudron, essence de, 231.
- Gourlier's salt mixtures for galvanic coppering, bronzing, etc., 114.
- Grafting wax, 69.
- Graham's bronzing liquids, tables, 47, 48.
- Graining, 261.
- Grease, Belgian wagon, 233.
 belt, 435.
 carriage, excellent, 233.
 for machine belts, 231.
 for water-proofing leather, 231.
 French's machine, 233.
 harness, 436.
 stains, to remove from paper, 75.
 stains, water for removing, 75.
 to remove from silk, 75.
 wagon, Persoz's patent, 234.
- Greases, patent, 232, 233.
- Greek bitters, 22.
- Green, antique, 44.
 bronze for brass, 44.
 bronzing, 414.
 color, innocuous, for candies, 85.
 crayons, 79.
 for artificial gems, formula for, 10.
 marble, to grain imitation of, 262.
 paint for outside work, 264.
 pigments, 268, 269.
- Green's blasting powder, 31.
- Grenades, hand, 124.
- Grenoble, ratafia de, 26.
- Grinding colors, 260.
- Grindstones, artificial, 51.
 plastic water-proof, 51.
- Ground mass for crême, 85.
- Grünevald bitters, extract for, 14.
- Guano, solution for flowers, 169.
 substitute for, 169.
- Gum-Arabic, artificial substitute for, 324.
- Gum, artificial, 324.
 substitute for in making bronze colors, 48.
- Gun and blasting powder of Hafenegger, 30.
 barrels, English process of staining, 244.
 barrels, processes for staining, 244.
 barrels, to harden, 240.
 -cotton, 32.
 -cotton, compressed, blasting under water with, 424, 425.
 -cotton, gunpowder, nitro-glycerine, fulminates, etc., 27-34.
 stocks, composition for, 133.
- Gunpowder, Borlinetto's, 31.
 Sharp and Smith's patent, 31.
- Guns, cleaning with petroleum, 243.
- Gutta-percha and linseed oil cement, 61.
 blacking, 321.
 cement for horses' hoofs, 61.
 cements, 61.
 composition, 60.
 how to color green or black, 60.
 solution of, for shoemakers, 60.
 substitute for, 182, 418.
- Gypsum, to remove from solutions of glucose, 342.
- Hafenegger's gun and blasting powder, 30, 31.
- Hager's composition for the destruction of vermin, 162, 163.
 tooth paste, 95.
 tooth powder, 95.
- Hair dyes, 289, 290.
 in tanneries, to preserve, 217.
 oils, 286-288.
 restorers, tonics, washes, etc., 288, 289.
 short, utilization of, 348.
- Hamburg bitters, 22.
- Hand grenades, 124.
- Hard coating for wood, 396.
 nut shell buttons, to dye, 183, 184.
 solder, 337.
 water, to soften, 168.
- Hardened steel, mechanically, 441.
- Hardening and welding compounds, 238-241.
 cement, lime, 52.
 composition for steel, 439.
- Harness grease, 436.
 lacquer for, 211.
 polish, 436.
- Hartmann's quick method of bleaching flax yarn, 36, 37.
- Hats, felt, to water-proof, 386.
 scouring soap for, 76.
 straw and chip, to wash, 366, 367.
 straw, to cleanse, 76.
 white straw, washing, 447.
- Heat, effect of on textile fabrics, 344.
 insulation, 137.
- Heating and fuel, 137.
- Hedinger's method of bleaching bones, etc., 40.
- Heel leather, imitations of, 183.
- Heels of boots and shoes, 176.
- Heinzerling's quick process of tanning, 215, 216.
- Hektograph, the, 88.
- Heliotrope sweetmeat, 82.
- Hemlock ointment, 166.
- Hempen fabrics, to tan, 220.
- Hemp seed, yield of oil, 2.
 to dye, 105.
 to prepare for spinning, 346, 347.
- Heptane, from California digger or nut pine tree, 254.
- Herb cordial essence, 15.
 extract, Koch's, 23.
 soap, Swiss, 333.
- Heron plumes, 118.
- Heterogeneous alloy (Jean's), 6.
- Hides and skins, to improve, 217.
 to depilate, 215, 216.
- Hoarseness, remedy for, 166.
- Hoff's malt beer, 295.
- Holland, anisette, 18.
 curaço, 20.
 gin, receipt for, 229.
- Hollow articles, mass for, 63.
- Honey and glycerine compound for blasting, 32.
 from beets and carrots, 129, 130.
 wine, 159.
- Hop stalks, to make cloth from, 349.
- Hops, to preserve, 313, 314.
- Hörmann's experiments with tin salt, 368.
- Horn combs, manufacture of, 435.
 combs, to make elastic, 446.
 new method of treating, 43.
 process of joining two pieces of, 446.

- Horn, substitute for, 174, 178.
to imitate tortoise-shell, 43, 44.
treatment of for manufacture of combs, 435.
waste of, for buttons, 44.
- Horse feed, bread for, 130.
feed, pressed, 129.
- Horsehair, to dye with aniline colors, 105.
- Horses' hoofs, cement for, 61.
- Hose, rubber, how to soften, 60.
rubber, to render odorless, 447.
- Household and rural economy, 157-170.
- Hufeland's tooth powder, 95.
- Huilard's substitute for tartar in dyeing, 105.
- Hyacinth, formula for, 11.
- Hydraulic mortar, 53.
motors, oil for, 234.
water-glass cement, 382.
- Hydrocarbons, liquid, solidification of, 452.
- Hydrochloric acid, used in the manufacture of gelatine, to regain, 375.
- Hydroleine, 133, 296.
- Hygienic chocolate, 57.
- Hyponitric acid, preparation of, and use for explosive and illuminating substances, 425, 426.
- Iceland moss chocolate, 57.
moss jelly, 85.
- Ice, to keep, without an ice-house, 168, 169.
- Illuminating, gold for, 90.
materials, 170-173.
oil, to purify, 251.
substances, use of hyponitric acid for, 425, 426.
- Imitation of cedar wood, 396.
of cinnabar, 421, 422.
of ivory, new, 417.
- Imitations, adulterations, etc., how to detect them, 1-3.
of mother-of-pearl and marble, with glue, 178-181.
substitutes, etc., 174-184.
- Incombustible fabrics, new method for the production of, 422.
ink and paper, 200.
tissues, 123, 124.
torches, material for, 170.
varnish for wood, 208.
wicks, 170.
- Incrustations, Alfieri's receipt for removing, 40.
Baudet's preventive, 40.
boiler, 39, 40.
Roger's preventives, 40.
Saillard's receipt for removing and preventing, 39.
- Indelible marking inks, 80.
- Indestructible inks, 193, 198, 199.
- India-rubber goods, to prevent becoming hard and cracking, 447.
hose, to render odorless, 447.
- Indigo, acetate of, 184, 185.
carmines, 184, 185.
carmines, to make, 269.
crystallized, 184.
indigotine, and alizarine, 184-187.
to cleanse, 76.
to regain from residues of colors, 377.
violet, 185.
- Indigotine, indigo, and alizarine, 184-187.
- Indigotine, Kopp's process of obtaining, 185-187.
- Infants' foods, 132.
- Inflammable compounds, 236.
- Insuforial earth for insulating steam-pipes, 137.
- Ink, alkaline, 198.
autographic, 192.
cake, 199, 200.
etching, for glass, 431.
for bleached cotton and woollen goods, 200.
incombustible, 200.
lithographic, English, 192.
lithographic printing, 192.
marking, 200.
pale writing, to make black, 200.
powders, 194.
powder in capsules, 199.
printers', with coal-tar varnish oil, 190.
printing and stamping, containing iron, 190.
printing from coal-tar, 190.
printing, good, the properties which it must possess, 187, 188.
printing, the manufacture of, 187-190.
stains, to remove, 75.
stains, to remove from silk, 75.
stones, 194.
vanadium, 196.
yellow, 198.
- Inks, alizarine, 196, 197.
aniline, 198.
black, 194, 195.
blue, 198, 199.
colored indelible, 80.
fire-proof, 454.
for marking glass and metal labels, 200.
for steel pens, 195, 196.
for writing on glass, 200.
green, 198.
indestructible, 193, 198, 199.
lithographic, 191, 192.
lithographic, printing, and writing, 187-202.
not acted upon by acids, 200.
patent copying, 193.
printing, new process for, 190.
red, 198-200.
solid, 194, 199.
stamping and sympathetic, 200.
violet, 198, 199.
writing, 192-198.
- Innoxious green color for candies, 85.
- Insects and worms, to destroy, 161, 162.
- Insect powder, Persian, 161.
- Insole leather, imitation of, 183.
- Insulating mass, flexible, 417.
material for electrical conductors, 417.
- Insulation, heat, 137.
- Intensifier, Davanne's, for spoiled photographic plates, 299.
- Intensifying bath, Abney's photographic, 307.
- Iodide of lead ointment, 166.
of mercury ointment, 166.
of potassium ointment, 166.
of sulphur ointment, 166.
soap, 332.
- Iodine pastils, 293.
solution of, to detect dextrine in milk, 2.
- Iodoform, 295.
pencils, 295.
- Iridescent glass, 145.
paper, 277.

- Iridium, its preparation and use, 439, 440.
 phosphor, casting of, 440.
 phosphor, properties of, 440.
 points for pens, 439, 440.
- Irish moss jelly, 85.
- Iron, 238.
 and alumina mordants on cotton prints, linens, etc., fixing of by water-glass, 379.
 and aluminium alloy, 4.
 and steel, black polish for, 210.
 and steel, silvering of, 113.
 and steel, solder for, 339.
 and steel, staining, 243, 244.
 and steel, to cleanse from rust, 76.
 bath for coppering, 115.
 bath for nickelling, 109.
 carbonate of, with chocolate, 57.
 cast, substitute for, 176.
 cast, to harden, 238.
 chocolate, 57.
 constructions, paint for, 265.
 enamelling of, 116.
 fire-plating for, 115.
 galvanizing, 114.
 galvanizing and nickelling of, in Cleveland, 413.
 glass enamel for, 118.
 gold bronze on, 46.
 gold varnish for, 208.
 injurious effect on aluminium, 5.
 lacquers, 205.
 lustre, 422.
 new process of bronzing on, 414.
 in stone, cement for fastening, 64.
 rods, effect of aluminium on, 4.
 separation of, from aluminium, 5.
 stoves, cement for, 66.
 to convert into steel, 241.
 to give it a bright lustre, 238.
 to iron, to cement, 63.
 to prevent rust on, 164.
 to protect from rust, 242.
- Isinglass, composition of, 156.
 glue, substitute for, 156.
 jelly, 85.
- Italian government, process of testing olive oil for cotton-seed oil, 1.
- Ivory and bone, cement for, 65.
 and bone, dyeing, 41.
 and bone, glue for, 66.
 and bones, bleaching, 41.
 articles, how to bleach, 43.
 artificial, 43, 416.
 black, 267.
 bleaching, Peineman's method, 40.
 new imitation of, 417.
 receipts for coloring, 41, 42.
 substitute for, 43, 174, 175.
 to make it soft and flexible, 40, 41.
 to produce black and colored drawings upon, 42.
 vegetable, 174.
- Jaline, 32.
- Japanese bronzes, 7.
 matches, 128.
 transparent varnish, 208.
- Japan gold size, 149.
- Jasmine sweetmeat, 82.
- Jellies, red color for, 85.
 to prevent the moulding of, 315.
- Jelly, buck-horn, 85.
 gelatine, 85.
 Iceland moss, 85.
 Irish moss, 85.
 isinglass, 85.
 sago, 85.
 tapioca, 85.
- Jepp's apparatus and process of manufacturing starch, glucose, and dextrose, 341-343.
- Jewellers' cement, 66.
 foils, 202.
 rouge, 77.
- Jewelry, alloy for, substitute for gold, 4.
- Jewreinoeff on platinizing copper and brass, 111.
- Johnson's process for potassium ferrocyanide, 70.
- Journal-boxes, alloys for, 6.
- Juice, orange, 15.
- Jungschläger's quick process of tanning, 216.
- Juniper berry essence, 15.
- Juniper elixir, 17.
 liqueur, 22.
- Juneman's process for wick-consuming candles, 172, 173.
- Jute, to dye, 105.
 to prepare for spinning, 346, 347.
 working of, 348, 349.
- Kahl's patent plaster, 416.
- Kid, calf, manufacture of in Philadelphia, 214, 215.
 leather, dyes for, 218, 219.
 leather, to make soft, 232.
- Kindling compound, 137.
- King's patent fuel, 137.
- Knife-sharpeners, caoutchouc composition for, 60.
- Knives and forks, alloy for, 5.
- Koch's herb extract, 23.
- Koeben's healing powder, 57.
- Kolbe's mouth wash, 95.
- Kopp's process of obtaining alizarine and indigotine, 185-187.
- Koumiss, artificial, 294.
- Krebs & Co., process for dynamite, 29.
- Kuhr's receipt for water-proofing linen, 386.
- Kümmel cordial, 20.
- Labels, glue for, 66.
 inks for, 200.
 on machines, paste for, 69.
- Lace, point, to wash, 365.
 silver and gold, to polish, 364.
 silver and gold, to wash, 362, 363.
 to whiten, 365.
- Laces, size for, 326.
 to wash, 364, 365.
- Lacquer and varnish, German patent process of making, 212.
 bookbinders', 210, 412.
 bronze, 210.
 elastic, 211.
 for closing bottles, 211.
 for drawings, 211.
 for flowers, maps, playing cards, prints, etc., 209.
 for harness, etc., 211.
 for leather, 209, 210.

- Lacquer for spring steel, 211.
 spirit, for wax tapers, 389.
- Lacquered wood, to cleanse, 164.
- Lacquering, background for, 392.
 of sheet metal, 244, 245.
- Lacquers and varnishes, 202-214.
 for carriages, 214.
 iron, 205.
 photographic, 308.
 spirit, 205.
- Lactopepsin, 297.
- Lake pigments, carmine and others, 268.
- Lampblack, 266.
 from the resinous sodic residues in the
 working of coal-tar, 372.
- Lampblacks, manufacture of, from asphaltum
 pitch or blacksmiths' pitch, 371, 372.
 manufacture of, from waste in working
 coal-tar, 370-372.
- Lamps, cement for, 65.
- Lange & Son's patent aluminium alloys, 4.
- Lanolin, Liebreich's process of preparing, 450.
- Lapis lazuli, formula for, 11.
- Lard and tallow, to prevent becoming rancid,
 168.
 and tallow, to purify, 169.
- Lavender, essence, 15.
- Lead, adulteration of vinegar with, 2.
 and aluminium, do not alloy, 4.
 bath for nickelling, 109.
 crystal glass, 143.
 ointment, 166.
 pencils, black and colored, for glass and
 porcelain, 432.
 pipes, to protect, 242.
 plasters, 297.
- Leaden water-pipes, coating of, 445.
- Leather, artificial, 176, 177.
 artificial, for lithographers' rollers, 174.
 belts, cements for, 64.
 black gloss for, 215.
 calf, with a white flesh-side, smooth, 217.
 cement for, 65.
 cloth, 176.
 dyeing of, 217-221.
 elastic mass resembling, 417.
 fine, glue for, 66.
 from seaweeds, 177.
 gilding and silvering, 445.
 grease for water-proofing, 231, 232.
 gutta-percha cements for, 61.
 Hall's substitute for, 176.
 imitations of, 183.
 lacquer for, 209, 210.
 marbled and dark of one color, gilding on,
 411, 412.
 ointments, 321.
 ornaments, to fasten, on metal, 94.
 prepared cloth as a substitute for, 383.
 pulverized, for boot heels, 176.
 Reichard's and Reber's processes for gild-
 ing, 411.
 tanning and dyeing, including furs, etc.,
 214-221.
 to give it the smell of Russia leather, 220,
 221.
 to water-proof, 384.
 transparent, to prepare, 216.
 vegetable, 418.
 wash, cleansing of, 419.
 waste, use of in manufacture of paper, 277.
- Lemonade powders, 157.
 syrups for, 134, 135.
- Lemon essence, 15.
 juice, to preserve, 312.
 lozenges, 84.
 soap, 332.
 sweetmeat, 82.
- Levulose, to prepare, 342.
- Liebreich's process for preparing lanolin, 450.
- Life, elixir of, 17.
- Light blue ultramarine colors with potash
 water-glass, 380.
- Lightning-rods, to protect from rust, 242.
- Lights, Bengal, 124.
- Ligroin and air, gas from, 171.
- Lily soap, 332.
- Lime and sugar paste, 68.
 burnt, to preserve, 312.
 liniment, 167.
 putty for wood, 67.
 to harden, 52.
- Linen and cotton goods, finishing of, by water-
 glass, 380.
 fabrics, to tan, 220.
 gold embroidered, to wash, 364.
 goods, sizing for, 322, 323.
 Kuhr's receipt for water-proofing, 386.
 marking ink for, 79, 80.
 pencils for marking, 79.
 sizes for, 326.
 to wash, 363.
 tracing, 276.
- Liniments, various, 167.
- Linseed oil and gutta-percha cement, 61.
 oil, substitute for, 452.
- Lipowitz, fusible alloy of, 5.
- Liqueur, calamus, 19.
 cherry, 19.
 Chinese, 26.
 chocolate, 20.
 cumin, 20.
 juniper, 22.
- Liqueurs, bitters, cordials, ratafias, 17-27.
 cordials, etc., mode of coloring, 12.
- Liquid cement for coating metals, papier
 maché, etc., 414.
 glue, cold, 154.
 glue, to prepare, 66.
 Graham's bronzing, 47, 48.
 wash blues, 370.
 water-glass, Kuhlmann's process at Lille,
 379.
- Liquids, hermetically closing bottles con-
 taining, 311.
- Liquor, Geitner's alizarine, 187.
- Liquors and beverages, beer, brandy, gin,
 whiskey, wines, etc, 221-231.
 to purify, 230.
- Litharge ointment, 166.
- Lithium glass, 432.
- Lithoextract made by Krebs & Co., of Deutz,
 29.
- Lithographers' rollers, artificial leather for,
 174.
- Lithographic ink, English, 192.
 inks, 191, 192.
 printing ink, 192.
- Lithomarlite, Garvey's, 51.
- Litmus, tincture of, to prepare, 71.
- Liver-of-sulphur, to prepare, 74.
- London purple for the destruction of insects, 162.

- Love sweetmeat, 82, 83.
 Lowget's polishing powder, 76.
 Lozenges, 84.
 Chinese, 84.
 chocolate, 67.
 ginger, 84.
 lemon, 84.
 peppermint, 84, 295.
 spice for, 84.
 stomachic, 84.
 Lubricant, caoutchouc, 232.
 caoutchouc, for driving belts, 436.
 for axles, shafts, etc., 232.
 for belts, 233.
 for industrial purposes, 232.
 from oil residues, 233.
 from paraffine residues, 232.
 from seaweed, 234.
 pulverulent, 232.
 pyroleine, 233.
 Lubricants, 438.
 blackening, etc., 435-439.
 for machines, wagons, etc., 231-235.
 mixtures of mineral and animal oils for, 438.
 purification of, after use, 438.
 Lubricating oil for astronomical instruments, 234.
 oils, Thurston's machine for testing, 436-438.
 Lumber, terra-cotta, 416.
 Luminous paper, 454, 455.
 Lunar caustic, to prepare, 73.
 Lustre, bright, 91.
 colors, 140.
 colors, preparation of with carbolic acid, 422.
 dead, 91.
 durable on copper, 46.
 Lustres, bismuth, tin, uranium, and iron, 422.
 metallic, upon fabrics, 348.
 Lustrine, Alsacienne, 370.
 Lutecine, components of, 5.
 Lye, caustic soda, Balling's method of preparing, 335.
 Lyes, percentage of soda and potash in, 335.
 Lyons asphaltum, 54.
 Mace extract, 15.
 Machine oil, consistent, 232, 233.
 Machines for manufacture of chocolate, 55, 56.
 lubricants for, 231-235.
 Machinery metal for various purposes, table of, 406.
 Mackinnon pen, iridium points for, 439.
 Madder, yellow, the most stable yellow dye, 3.
 Madeira wine, 231.
 Magnesium, neutral extract of, 296.
 Magnus' patent to polish slate, 78.
 Mahogany, to grain imitation of, 261.
 Malachite, imitations of, 180.
 Malaga wine, 231.
 Malleable brass, receipt for, 241.
 nickel, receipt for, 241, 242.
 Malt beer, 295.
 bon-bons, 81.
 extracts, 296.
 fabrication of, 221.
 mashing, 221, 222.
 mashing the, for brewing, 221, 222.
 sugar, 80.
 Malt with pepsin wine, 297.
 Manganese alloys, 403, 404.
 bronze, 6, 405.
 Mannite, 342, 343.
 Manure for meadows, 373.
 from animal waste, 169.
 from coal-ashes, 169.
 powder from blood, 169.
 salt from urine, 169.
 Manures, artificial, from residues in the working of coal-tar, 372.
 for meadows, 373.
 for turnips, etc., 169.
 Manuscripts, faded, to restore, 74, 75.
 Maple, to grain imitation of, 262.
 Maps, lacquer for, 209.
 Marabouts, how to restore and dye, 118, 122.
 Maracaibo tobacco, 350.
 Maraschino, 23.
 Marble, artificial, 51.
 bleaching stained, 39.
 busts, to clean, 78.
 concrete, 64.
 imitation of, 178.
 imitation of for plastic ornaments, 183.
 to clean, 420, 421.
 to grain imitation, 262.
 variegated, to imitate, 51.
 Marbleizing sandstone, 53.
 Margarine, 131-133.
 Marine glue, 235.
 Marjoram essence, 15.
 Marking brush for boxes, 201.
 ink for linen, 79, 80.
 inks, 200.
 tools, 443.
 Marmalade, cherry, 84, 85.
 Marmorin, 63.
 Martin and Delamotte's process of nickel-plating, 108.
 Martinsen's blasting powder, 32.
 Masonry, brick, made impervious to water, 55.
 Mass, flexible insulating, 417.
 for hollow articles, 63.
 for plastic models, 417.
 for roofing, fire-proof ceilings, etc., 416.
 for toys, vessels, dolls' heads, etc., 62.
 resembling leather, 417.
 Mastic cement, 63.
 Matches, 236-238.
 antiphosphorus, 237.
 inextinguishable in the wind, 237.
 Japanese, 128.
 parlor, 236, 237.
 quick, 125.
 Swedish, 236.
 without phosphorus, 237.
 without sulphur, 236.
 Materials, strength of, 456-458.
 Meat biscuit, 130.
 English pickle for, 310.
 extract with chocolate, 57.
 flour, 129.
 preservatives of, 310, 311.
 quick process of corning, on a small scale, 312.
 to preserve, 314.
 Medals, bronze for, 8.
 Medicated and toilet soaps, 331-335.
 waters, 290-292.
 Medicinal sweetmeats, 83.

- Medicines, new patent, 296, 297.
 Meerschau, caseine cement for, 65.
 substitute for, 175, 176.
 Mège's process for oleomargarine, 131.
 Meiffren's patent alloy, 8.
 Melanyl candles, 171.
 Mercury, fulminate of, 33.
 Metal, cement for fastening rubber upon, 64.
 coin, 8.
 electroplating with cobalt, 111.
 fire and water-proof cement for, 63.
 for brasses, table of, 406.
 for gongs and bells, 8.
 industry, 238-245, 439-444.
 letters, cement for fastening on glass, etc.,
 64.
 machinery for various purposes, 406.
 new solder for, 441.
 polishing powder for, 76.
 rags for polishing, 419.
 Spence's, 6, 405.
 stop-cocks, composition for, 7.
 surfaces, ornamenting, 92.
 to lacquer, 244, 245.
 type, components of, 6.
 water-proof paint for, 266.
 Metals, and glass, painting with water-glass,
 381.
 bronzing and coloring, 44-49.
 caseine cement for, 65.
 coloring, 46, 47.
 glazes for, 244, 245.
 liquid coating for, 414.
 platinizing, 110, 111.
 polishing pastes for, 77.
 polishing rags for, 77.
 preparation of, for nickelling, 110.
 staining, 243, 244.
 to enamel and cement, 116, 117.
 Warne and Trabak, 403.
 Metallic colors, zinciferous, 137, 138.
 lustre, to impress upon fabrics, 346.
 sulphides as mordants, 106.
 surfaces, paint for, 264.
 wicks, 170.
 Metalline, manufacture of, 234.
 Metallique, moire, 45, 46.
 Metallized caoutchouc, 60.
 Meters, dry gas, 170, 171.
 Mice, paste for destroying, 162.
 Microscopic objects, paste for, 68.
 preparations, 68.
 Mignonette soap, 332.
 Mildew stains, to remove, 75.
 Milk, adulterations of, 2.
 foods for children, 132.
 sugar, 340, 341.
 to keep from souring, 157.
 to preserve, 314.
 Milks, condensed, 132.
 Millstones, artificial, 51.
 Minargent, 8, 403.
 Mineral oils, to purify, 247.
 oils, to free from sulphuric acid and sul-
 phur, 256.
 waters, syrups for, 134, 135.
 Mine timber, preparation of, 395, 396.
 Mint, Paris, bronzing in, 44.
 Mirror-glass, 142.
 Bohemian, 142.
 Mirrors, flexible, 178.
 Mirrors, polishing powder for, 77.
 silvering of telescopic, 113.
 Mitis castings, 441.
 Modelling wax, 389.
 wax, superior, 418.
 Models, plastic mass for, 417.
 Mogador, 23.
 Moiré metallique, 45, 46.
 Molasses soap, 320.
 Molskin, a substitute for leather, 383.
 Molybdic acid, to prepare, 73, 74.
 Monpou elixir, 17.
 Monuments, bronze, 48, 49.
 to repair with water-glass paste, 379.
 Moody's new polish for wood, 394.
 Mordants, 105, 106.
 iron and alumina, fixing of by water-glass,
 379.
 Morocco paper, stains for, 280, 281.
 Mortar, bitumen, 53.
 hydraulic, 53.
 requisites for, 52.
 water-proof, 53.
 water-glass and chalk, 382.
 Mosaics, staining wood for, 393, 394.
 Mosquitoes and gnats, to destroy, 162.
 Moth and roach exterminator, 446.
 Mother-of-pearl, imitation of, 178.
 Moths, packing paper to protect cloths, furs,
 etc., from, 408.
 receipts for destroying, 161, 162.
 to protect furs from, 220.
 Moulding figures, pasteboard mass for, 63.
 the glue, 151.
 Moulds for galvano-plastic deposits, 115.
 taking glue from, 152.
 Mouth glue, 67.
 paste, antiseptic, 95.
 washes, 95.
 Mowbray's process for nitro-glycerine, 27-29.
 Mulberry ratafia, 26.
 Munich fire-extinguishing powder, 123.
 Musical instruments, steel wire for, 241.
 Music printing plates, alloy for, 6.
 Musk extract, 283, 284.
 essence, 15.
 soap, 332.
 Muslin and cotton prints, to wash without in-
 jury to the color, 368.
 fine, to wash, 363.
 gold embroidered, to wash, 364.
 to bleach, 34.
 Mustards, 245-247.
 Mustard-seed, yield of oil by, 2.
 Must, wine, to improve, 231.
 Naples yellow, 270.
 Naphtha, ether, 170.
 test of, 254, 255.
 Naphthaline colors, to dye with, 103.
 to prepare, 248.
 Napoléon, eau de, 21.
 Nectar, 23.
 Negative layer, to remove from glass-plate in
 photography, 305.
 process, Wothly's, without intensifying
 bath, 308.
 Nettles, to prepare for spinning, 346, 347.
 Neutral soaps, 330.
 Nicotine in tobacco, apparatus for testing per-
 centage of, 74.

- Nickel alloy, prepared by Christoffe and Bouilhet, 5.
baths, 109.
Fleitmann's process of refining, 441.
malleable, receipt for, 241, 242.
waste, utilization of, 443.
- Nickelling, American, 109.
and galvanizing of iron in Cleveland, O., 413.
latest Anglo-American, 109, 110.
preparation of the metals for, 110.
- Nickel-plating, 107-109.
- Niello, 118.
- Nitric acid, adulterating vinegar with, 2.
- Nitrogenous organic substances, productions made from, 377.
- Nitro-glycerine, 27-34.
Böttger's process, 29.
gelatinous, 33.
to protect from moisture, 32.
- Nobel's process for dynamite, 29.
- Non-explosive powder, 31.
- Norbin & Ohlsson's patent for dynamite, 29.
- Nut essence, 15.
- Nutmeg essence, 15.
- Nutritive substances, fluids containing, to preserve, 313.
- Nuts, pea, yield of oil by, 2.
- Oak furniture, to cleanse and beautify, 78.
to grain imitation of, 261.
- Offal and waste, utilization of, 370-378.
- Oil and wood putty, 67.
a new, from California, 254.
Belmontine and Sherwood, 254.
castor, manufacture of, 247.
cement paint for felt roofing, 52.
-cloth, 345, 346.
-cloth, bronze color, for printing on, 190, 191.
coal-tar, process of producing in England, 256, 257.
coal-tar varnish, 256.
colors, dryer for, 266.
corn, from corn mash, 251.
cotton-seed, manufacture of, 449, 450.
cotton-seed, refining, 451.
crude cotton-seed, production of soap or sebatic acids from, 451.
drying, Chinese, 248.
fish, new process of extracting, 451.
for pumicing wood, 252.
for watchmakers, 235.
from acid tar, 251.
from sunflower seed, 252.
illuminating, to purify, 251.
linseed, substitute for, 174, 452.
machine, consistent, 232, 233.
machine, from coal-tar varnish oil, 234.
neat's-foot, manufacture of, 248.
of lemon, effect of on oil paintings, 258.
of turpentine, effect of on oil paintings, 258.
of turpentine, substitute for, 174.
olive, clarifying, 449.
oxidized, 412.
painting, green borate of copper for, 268.
painting, to transfer from an old to a new canvas, 259.
paintings, effects of different solvents on, 257-259.
- Oil paintings, how to cleanse, pack, and varnish, and to restore gilt-work, 257-260.
paintings, how to pack, 259.
paintings, special instructions for cleansing, 258, 259.
paintings, to lacquer and cleanse, 259.
paintings, to paste on wood, 259.
paintings, varnishing of, 259, 260.
poppy-seed, to purify, 251.
rape-seed, to detect, 252, 253.
residues, lubricant from, 233.
rosin, and its uses, 248, 249.
shale, residues of, 247.
sugar, to prepare, 80.
to disguise the taste of, 166.
to make parchment paper impermeable to, 455.
to remove from fleece, wool, silk, and woollen fabrics, 346.
to remove from silk, 75.
train, to purify, 251.
Vulcan, 234.
white vaseline, 453.
wood-tar, purification of, 255.
- Oils and fats, 447-453.
and fats, animal, vegetable and mineral, 247-257.
and fats, bleaching of, 447, 448.
and paraffines, from petroleum residues, 451, 452.
animal and mineral, lessening of the liability to spontaneous combustion by mixing, 438.
animal, to purify, 251, 252.
coal-tar, shoemakers' wax from, 257.
cruciferal, to detect, 252.
essential, detection of water in, 449.
hair, 286-288.
light, to distinguish from petroleum and tar-oils, 254.
lubricating, machine for testing, 436-438.
mineral and animal, lessening of the liability to spontaneous combustion by mixing, 438.
mineral, to purify, 247.
mineral, to remove sulphuric acid and sulphur from, 256.
mineral, to solidify, 248.
percentage of, in seeds, 12.
purification of, 452, 453.
testing, 257.
to deodorize, 252.
vegetable fat, French process of cleansing, 247.
- Ointment, blistering, 294.
- Ointments, leather, 321.
various, 166, 167.
water-proof, for shoes, 321, 322.
- Oleic acid, purified, to prepare, 73.
- Oleomargarine, 131-133.
separating and purifying the fats for, 235.
- Oleum aromaticum, 297.
- Olive oil, clarifying, 449.
oil, effect of on oil paintings, 258.
process of testing for cotton-seed oil, 1.
- Onyx, to make from agate, 177.
- Opal, formula for, 11.
glass, 144.
- Opaque glass, composition for, 144.
glass, substitute for, 178.
- Opera glasses, alloy for, 5.

- Opium liniment, 167.
 ointment, 167
- Opodeldoc, 297.
- Orange and gold stain for brass, 414.
 blossom extract, 15
 blossom sweetmeat, 82.
 blossom water, 15.
- Orange blossoms, coated, 84.
 blossoms, preparation of, 15.
 dyes, test for, 3.
 juice, 15.
 peel cordial, 23
 peel extract, 15.
 ratafia, 26
 soap, 332
 sugar, 80.
 sweetmeat, 81
 wine, 159.
- Oranges, candied, 84.
- Oranienburg soap, 330.
- Ordway's artificial stone, 50.
- Ores, refractory, Cowles' electric furnace for reducing, 440, 441.
- Organic substances, novelties in preserving, and apparatus used, 407, 408.
- Orient, eau d', 21.
- Ornamentation, decoration, etc , 89-94.
- Ornamenting frosted glass, 434.
- Ornaments, artificial wood for, 93.
 bronze for, 8.
 composition for, 62
 imitation of marble for, 183.
 leather, to fasten upon metal, 94.
 wood mass for, 93, 94.
- Oroide, composition of, 3.
- Osiers, coloring with aniline colors, 459, 460.
 how they can be peeled in winter, 391.
- Ostberg's process of making wrought-iron castings, 441.
- Ostrich feathers, 118.
- Otto's process of manufacturing pressed yeast, 401.
- Ott's artificial stone, 50.
- Oxalic acid, preparation of, 73
- Oxidized oil, 412.
 silver, 44, 441, 442.
- Ozotine, from woolly fibre, 274.
- Packing, asbestos and rubber, 62.
- Painters' cream, 273.
- Paint brushes, to clean from dried paint, 76.
 cheap, for outside work, 264.
 flexible, 263.
 for constructions of iron, 265
 for metallic surfaces, 264.
 for outside walls, 264.
 for outside work, 265, 266.
 for roofs, 265.
 for tin roofs, 264.
 for vessels, submarine works, etc., 263, 264
 for wooden posts, etc., 397.
 for wood or stone which resists moisture, 264.
 green, for outside work, 264.
 oil cement, for roofing, 52.
 parafine, receipt for, 265.
 quickly drying, 265.
 Swedish, for wood work, 265.
 universal, for oil or water, 264.
 water-proof, 263
- Paint, water-proof, for metals, 266.
 white, for metallic surfaces, 264.
 whitewash closely resembling, 165.
- Painting on zinc, 414, 415.
 receipts for colors for, 262, 263.
 sign, 148, 149.
 water-glass in, 381.
 willow-ware, 460.
- Paints and pigments, grinding and mixing colors, graining, imitation of marbles, paints, and washes for various purposes, 260-273
 cheap, for floors, stone-work, etc., 263, 264.
 for various purposes, 263-266.
 poisonous, 271.
- Palamaud, 58.
 composition of, 129
- Palladium, platinum and copper alloy, 403.
- Palmgrène, 58.
- Palm oil wagon grease, 232.
- Panama essence, 368.
 hats, dressing for, 326.
- Paper, 453-455.
 amianthus, 277.
 and paper materials, manufacture, staining, etc., glass, sand, and emery paper, 273-281.
 blasting, 424.
 cigarette, 274.
 carbolic acid, 275.
 colored, for tying up bottles, 277.
 crystalline coating for, 421.
 electro-chemical telegraph, 277.
 emery, 278, 279.
 fly, to prepare, 161.
 for artificial flowers, stains for, 279.
 for covering boilers, 455
 for documents, 274.
 for wrapping fruit in, 276.
 gas-pipes, 454.
 glazed, stains for, 279, 280.
 gold wall, new process of manufacturing, 445, 446.
 how to split, 281.
 imitation of mother-of-pearl on, 277, 278.
 incombustible, 200.
 iridescent, 277.
 Johnson's varnish for water-proofing, 423.
 luminous, 454, 455.
 manufacture of bottles from, 455.
 matrices for stereotype plates, 115
 morocco, stains for, 280, 281.
 parchment, 275.
 parchment, to make impermeable to oil, 455.
 photo-lithographic transfer, 276.
 pulp, new process of manufacturing, 455.
 raw materials for, 273, 274.
 Reichardt's process of gilding, 411.
 safety, 274, 275.
 soap, preparation of, 455.
 tar, 276, 277.
 to free from fatty substances, 77.
 to make incombustible, 124.
 to make transparent, 278.
 to protect cloth, furs, etc., from moths, 408.
 to remove grease stains from, 75.
 to render water-, rot-, and insect-proof, 453, 454.

- Paper, to water-proof, 384.
 tracing, 276.
 wall, paste for, 68.
 water-proof 275.
 waxed, to prepare, 388.
 writing and drawing, which can be washed, 276.
- Papers, cork, 275.
 fire-proof, 454.
- Papier maché, from flour, 63.
 maché, liquid cement for coating, 414.
- Paradise, eau de, 22.
 water, 22.
- Paraffine and heavy oils from petroleum residues, 451, 452.
 bleaching of, for manufacture of candles, 447.
 paint, receipt for, 265.
 preparation and uses of, 253, 254.
 purifying, 259.
 residues, lubricants from, 232.
- Parasol ribs, artificial whalebone for, 178.
- Parchment, fabrication of, 454.
 fluid, 211.
 glue, 411.
 paper, 275.
 paper, to make impermeable to oil, 455.
 to gild and silver, 91.
- Parfait D'Amour, 23.
- Paris green, to make, 268.
 metal, components of, 5.
 mint, bronzing in, 44.
 tooth powder, 95.
- Parisian rappée snuff, 354.
 wood varnish, 209.
- Parlor matches, 236, 237.
- Pasteboard, for moulding large figures, 63.
 plastic, for surgical bandages, 276.
 to enamel, 277.
 to make water-proof, 277.
- Paste, durable, 69.
 dry, 68.
 fluid, 68.
 for fixing printed labels on machines, 69.
 for microscopic objects, 68.
 for patent leather, 321.
 for postage stamps, 68.
 for wall-paper, 68.
 lime and sugar, 68.
 safety for post-office packages, 69.
- Pastes, cements and putties, 63-69.
 polishing, for metals, glass, etc., 77, 420.
- Pastiles, 293, 294.
- Patchouli soap, 332.
- Patent dynamite, Norbin and Ohlsson's process, 29.
 leather, paste for, 321.
 medicines, 296, 297.
- Paving, asphaltum for, 53.
- Peach cordial, 23.
 essence, 15.
- Peanuts, yield of oil in, 2.
- Pear ratafia, 26.
- Pearl embroideries, to wash, 366.
 imitations of, 178-181.
 imitation of on paper, 277, 278.
 lustre, to imitate, 182.
 mother-of, to dye with aniline colors, 104.
 veneers, to imitate, 179.
 yarn, 345.
- Pearls, artificial, 9-12.
- Pearls, artificial, Geissler's process, 12.
 genuine, to wash, 365.
- Pectoral bon-bons, 81.
 troches, 80.
- Peineman's method of bleaching ivory turned yellow, 40.
- Pencils for marking linen, 79.
 for writing on glass, 79.
 iodoform, 295.
 sharpening stone for, 177.
- Pens, iridium points for, 439.
- Peppermint cordial, 28.
 drops, 84.
 essence, 16.
 lozenges, 84, 295.
 sweetmeat, 82.
- Pepsin, lacto, 297.
 wine, with malt, 297.
- Peralite, 32.
- Perfume from flowers, extraction of, 232.
- Perfumes for cigars, 354.
- Perfumery, aromatic vinegars, cosmetics, extracts, hair oils, pomades, powders, washes, fumigating articles, etc., 282-294.
- Permanent inks, 198, 199.
- Perron's fireworks for rooms, 128.
- Persian insect powder, 161.
- Persimmon seeds, substitute for coffee, 169.
- Petroleum, cleaning guns with, 243.
 lamps, cement for, 65.
 residues, heavy oils and paraffine from, 451, 452.
 to clarify without distilling, 252.
 to detect, 254.
 to solidify, 248.
- Petum optimum, 351.
- Pewter, solder for, 339.
- Pfauth's process of preparing pressed yeast from beer yeast, 402, 403.
- Pharaoh's serpents, 128.
 serpents, substitute for, 129.
- Pharmaceutical preparations, 294-298.
- Phosphor bronze, 404, 405.
 iridium, casting of, 440.
 iridium, properties of, 440.
- Phosphorescent enamel, 422.
 illuminating powder, 70.
 mixtures, 446.
- Phosphorizing bronze or brass, 442, 443.
- Phosphorole, 296.
- Phosphorus, amorphous, preparation of, 237, 238.
- Photo-diaphanic process of transferring, 302.
 -emulsions, Vogel's improvements in, 302.
- Photographic baths, 300, 301, 305, 307.
 developers, 298, 299, 301, 305-307.
 developing solution, 299.
 emulsion, 301.
 emulsions, 298, 300-302, 306.
 lacquers, 308.
 negatives, varnish for, 212.
 plates, intensifier for, 299.
 plates, new developer for, 301.
 purposes, artificial ivory for, 43.
 process with phosphorescent substances, 303.
 reproduction, 303, 304.
 varnishes, 307.
- Photographs, email, 300.
 enamelled, 300.

- Photographs on wood, 308.
transferring to glass, 434.
- Photography, 298-308.
rapid method for, 304, 305.
use of gelatine in, 298-305, 307.
various practical receipts for, 306-308.
- Photo-lithographic transfer paper, 276.
-negatives, fluid for, 301.
-negatives, reproduction of, 305, 306.
-operating room, painting the, 301.
-paper, sensitive, 306.
-plates, Petchlers' new method of preparing, 302.
-printing receipts, 301.
-printing without a press, 302, 303.
- Phylloxera, to destroy, 163.
- Phytochromotypy, 423, 424.
- Picture frame composition, 62.
frames, imitation of marble for, 183.
- Piffard's galvano-plastic silvering, 112.
- Pigment, white or black, from the clarifying slime in sugar-houses, 376.
- Pigments, 266-272.
innocuous for toys, 270, 271.
- Pills, female, 294.
- Pinchbeck, composition of, 3.
origin of name, 3.
- Pine needles, a substitute for hair, etc., 157.
- Pins with glass heads of a coppery appearance, 431, 432.
- Pipes, leaden water, to coat, 445.
steam, cement for, 63.
- Pistol-stocks, composition for, 183.
- Pistons, from buffalo skins, 178.
- Pitch, 223.
asphaltum, lampblack from, 371, 372.
blacksmiths', from coal-tar, 257.
brewers', 223.
hop, 223.
ointment, 167.
varnish for buildings, 208, 209.
- Plant slips, collodion for, 165.
- Plaster, clay, 53.
for ceilings, 416.
for damp walls, 53.
galbanum and saffron, 297.
gelatine, 296.
Kahl's patented, 416.
of Paris casts which can be washed, 308-310.
of Paris figures, bronzes for, 45.
soap, 298.
- Plasters, lead, 297.
sticking, 297.
- Plastic bandage, 297.
masses, treatment of pyroxyline in the manufacture of, 58, 59.
models, mass for, 417.
- Plated ware, solder, silver, for, 339.
- Plate glass, manufacture of, 432-434.
glass, of the mirror manufactory at Aix la Chapelle, 142.
- Plates, developers for, 299.
- Plating with aluminium, 111.
with nickel, 107-109.
- Platinizing copper and brass, Jewreinoff on, 111.
glass and porcelain, 434.
metals, 110, 111.
- Platinotypy, recent improvement in, 304.
- Platinum and bismuth alloy, 4.
bronze, alloy, 5.
fulminating, 33, 34.
palladium, and copper alloy, 403.
- Playing cards, lacquer for, 209.
- Plumes, description of, 118.
- Plush, feather, 344.
restoring of, 420.
- Poch's pudrolith, 30.
- Poisonous paints, 271.
- Polish for carved work, 209, 210.
for wood, 394.
French, 209, 210.
harness, 436.
liquid, for silver-plated ware, 419.
new, for wood, 419.
water, 23.
whiskey, 23.
- Polishing agents, 75-78.
metal, rags for, 419.
of wood, 211.
pastes for metals, 77.
powder for glass and metal, 76.
powder for plate, 77.
powder for silverware, 78.
powder, Louget's, 76.
rags for metals, 77.
soaps and pastes, 420.
substances for glass, 433, 434.
wax, 387.
wax for woods, 398.
wax, Wabeck's, 77.
- Polygraphic method of copying, 87, 88.
- Pomades, 287, 288.
- Poplar tree, new dye from shoots of, 107.
- Poppy seed oil, to purify, 251.
seed, white, yield of oil, 2.
- Porcelain and glass, water-glass and casein cement for, 382.
and glass, water-glass cement for, 382.
black and colored lead-pencils for, 432.
cement for, 63.
fire and water-proof cement for, 63.
gilding of, 90.
new solder for, 441.
painting, fusible colors used in, 137-141.
painting, green borate of copper for, 268.
platinizing, 434.
to give it a marbled or granite appearance, 147.
- Portocarero tobacco, 351.
- Porto Rico tobacco, 351.
- Port wine, 231.
- Positive paper for photographers, 298.
- Postage stamps, paste for, 68.
- Posts, wooden, new paint for, 397.
- Potash, caustic, to purify water, 72.
- Potash, effect of on oil paintings, 258.
from sheep's wool, 450.
percentage of in lye, table of, 335.
water-glass as a binding and fixing medium for ground colors on cotton goods, 380.
water-glass, substitute for albumen in printing with ultramarine, 380.
water-glass, to prepare, 378.
- Potassium acetate, to prepare, 74.
ferrocyanide, Johnson's process and apparatus for manufacturing, 70.
- Potatoes and other tubers, to preserve, 311, 312.

- Potatoes, pressed yeast from, 401.
 Potato flour for soups, 130.
 flour, to prepare, 157.
 starch, blasting compound from, 31.
 Powder, Augendre's white, 30.
 blasting, Green's, 31.
 blasting, new, 425.
 cleaning, for show windows, 419.
 copper colored bronze, 45.
 for cannon of large calibre—Spence's, 31.
 for polishing silver, 78.
 giant, 32.
 light, new method of preparing, 425.
 Koeben's healing, 57.
 non-explosive, 31.
 tooth, preparation of precipitated chalk for, 446.
 Powders, bronze, 45.
 cosmetic, 292.
 pudding, 130.
 sneezing, 354.
 washing, 370.
 Powell's improvements in nickel-plating, 108, 109.
 Precious stones, to cleanse, 78.
 Preservative agents, 405-408.
 papers, 315.
 salt, to prepare a, 311.
 Preserving meat, milk, vegetables, vegetable substances, wood, etc., and preservatives, 310-316.
 Pressed yeast from potatoes, 401.
 yeast, Otto's method of manufacturing, 401.
 Prince's metal, composition of, 3.
 Princesses, eau des, 22.
 Printed matter, fire-proof, 454.
 Printers' ink with coal-tar varnish oil, 190.
 rollers, 201, 202.
 rollers, from glue and glycerine, 156.
 varnish, with coal-tar varnish oil, 190.
 Printing and copying, 86-89.
 autographic method of, 86.
 bronze color, for direct upon paper, oil-cloth, etc., 190, 191.
 colors, German patent, 190.
 colors, paste for, 187.
 in colors, 86, 87.
 ink containing iron, 190.
 ink from coal-tar, 190.
 ink, good, the properties which it must possess, 187, 188.
 ink, new process for, 190.
 ink, the manufacture of, 187-190.
 plates, celluloid, 416, 417.
 preparation of surfaces for, 345.
 Prints, lacquer for, 209.
 Prinze's soap-boiling tables, 336.
 Prismatic colors, 140.
 Pudding powders, 130.
 Puddings, vanilla, almond, and chocolate, 130.
 Pudrolith, Poch's, 30.
 Pulverize glass, to, 146.
 Pumice soap, 332.
 Pump pistons, to make from buffalo skins, 178.
 Punch drops, 84.
 Purple colors, how composed, 3.
 colors, test for, 3.
 Putties, pastes, and cements, 63-69.
 Putty for wood floors, 67.
 for wood lime, 67.
 wood, and glue, 67.
 wood, and oil, 67.
 Pyrogallic acid, to prepare, 306.
 Pyroleine lubricant, 233.
 Pyrolith, Wattle's, 30.
 Pyrotechnic and explosive substances, 424.
 Pyroxyline, treatment of, in the manufacture of plastic masses, 58, 59.
 Quesnot's artificial stone, 49.
 Quillaya dentifrice, 95.
 Quince essence, 16.
 Quittico cordial, 23.
 Rabbit skins, to dye, 219.
 Racachout des Arabes, 57.
 Raisin wine, 159.
 Rancid butter, to purify, 168.
 fat, to purify, 168.
 Ransome's artificial stone, 50.
 patent apoenite, 50, 51.
 Rape seed, yield of oil in, 2.
 Rappée snuff, 354.
 Raspberry bon-bons, 81.
 extract, 16.
 vinegar, 362.
 water, 16.
 wine, 160.
 Ratafia, apple, 26.
 Barbadoes, 25, 26.
 celery, 27.
 chinoise, 26.
 citronat, 26.
 claret, 26.
 cocoa, 26.
 de Grenoble, 26.
 English bitters, 26.
 fennel, 26.
 ginger, 26.
 mulberry, 26.
 orange, 26.
 pear, 26.
 Scotch, 27.
 stomachic, 26, 27.
 vanilla, 27.
 wormwood, 27.
 Ratafias, 25-27.
 bitters, cordials, and liqueurs, 17-27.
 Ratan, to substitute for whalebone, 183.
 Rats, paste for destroying, 162.
 to clear from buildings, 162.
 Razor strops, composition for, 63.
 Reale aqua, 18.
 Receipts for coloring bones, horn, ivory, etc., 41, 42.
 Red bronze for turned articles, 8.
 chrome, 269.
 cloths, cleansing salt for, 365.
 color for jellies, 85.
 color for sweetmeats, 85.
 copper bronze on tin, 46.
 cracons, 79.
 dyes, affected by boiling, 3.
 dyes, effect upon soap solution and upon lime-water, 3.
 inks, 198-200.
 tooth powder, 95.
 Vandyke, 270.
 wine, alum in, 3.

- Refining cotton-seed oil, 451.
nickel, 441.
- Refractory solders, 338.
- Reichardt's rosin compound for gilding paper, leather, etc., 411.
- Remedy for warts, 160.
- Renovating agents, 75-78.
- Renovator, furniture, 419.
- Residues of colors, to regain indigo from, 377.
- Restoring pictures, colors for, 271, 272.
- Retorts, glass, cement for, 63.
- Ribbons, silk, mixed with gold and silver threads, to wash, 362.
silk, to wash, 362.
- Riber's process of gilding leather, 41.
- Rice soap, 332.
- Riley, Prof. C. V., recommendation of, for destruction of potato-bugs, etc., 162.
- Rivets, bronze for, 8.
- Roach and moth exterminator, 446.
- Roasted almonds, 83.
filberts, 83.
malt, substitute for coffee, 157.
- Robandi process for brise-rocs, 30.
- Robertson's alloy for filling teeth, 3.
- Roelandt's water-proofing compounds, 385.
- Roger on the presence of aluminium in steel, 5.
- Roger's preventive of incrustation, 40.
- Rollers, printers', 156, 201, 202.
- Roofing, mass for, 416.
oil cement paint, 52.
- Roofs, glass, to make water-tight, 55.
paint for, 265.
- Root beer, 160.
- Ropes, to make incombustible, 124.
- Rose essence, 16.
leaves, preservation of, 15.
soap, 332.
sweetmeat, 82.
- Rosemary cordial, 23, 24.
essence, 16.
- Rosewater, 16.
- Rosewood, to grain imitation of, 261, 262.
- Rosin, as protection against moisture in walls, 164.
oil and its uses, 248, 249.
oil, to deodorize, 252.
soap, 327, 328.
- Rosoli, bitter, 18.
- Rossolio de Turin, 24.
- Rostopschin, 24.
- Rotting, to prevent, 164.
- Rouge for jewellers, 77.
- Rouges, 292.
- Rough-cast walls, water-glass for, 381.
- Rubber and asbestos packing, 62.
combs, cement for, 61.
corks, to cut and pierce, 164.
corks, to restore, 377.
hose, how to soften, 60.
hose, to render odorless, 447.
shoes and boots, cement for, 61.
stamps, manufacture of, 59, 60.
substitute for hard, 174.
upon metals, cement for fastening, 64.
- Ruby, Schrader's mixture for, 10.
Splittgerber's mixture for, 10.
- Rum, to manufacture, 229.
- Russia leather, to imitate the smell of, 220, 221.
- Rust and ink stains, to remove, 75.
- Rust on iron, to prevent, 164.
stains, to remove from clothes by tin salt, 368.
to protect iron metal roofs, wire, etc., from, 242, 243.
to remove from iron and steel, 76.
- Rusting in of screws, preventing, 443.
- Rutabagas, manure for, 169.
- Ruthay's process for making glue from tannery waste, 152.
- Sable skins, imitation of, 220.
- Sacking, to make water-proof, 383.
- Safety paper, 274, 275.
paste for post-office, 69.
- Saffron plaster, 297, 298.
- Sage essence, 16.
- Sago jelly, 85.
- Sail-cloth, to make pliable and water-proof, 265.
water-proof, 386.
- Saillard's receipt for removing and preventing incrustations, 39.
- Salt, mixtures for galvanic coppering, bronzing, etc., 114.
preservative, 311.
- Saltpetre, use of to separate iron from aluminium, 5.
- Sands, colored, 201.
- Sand soap, 330, 331.
- Sandstone, cement for repairing, 64.
marbleizing, 53.
steps, to repair, 54.
to make tough and impermeable, 54.
- Sapphire, formula for, 10.
- Satin, to wash, 362.
wood, to grain imitation of, 262.
- Satori's process of silvering Bessemer steel, 112.
- Saucers and glasses, to cleanse, 76.
- Savin ointment, 167.
- Savon de Riz, 332.
ess. bouquet, 332.
orange, 332.
- Sawdust, utilization of, 416.
- Saws and springs, to harden, 240, 241.
to solder, 340.
- Schaeffer's artificial stone, 49.
- Schrader's flux, components of, 9.
mixture for ruby, 10.
- School slates, artificial slating for, 177.
- Schöttler's artificial cement, 52.
- Schubert's method of manufacturing pressed yeast, 399, 400.
- Scotch ratafia, 27.
- Scouring and washing, 362-370.
fluid, le François, 75.
soap, 76.
soap for cotton and silk goods, 76.
soap for glass mirrors, 77.
soap, green, 76, 77.
soaps, black and green, 76.
water for removing grease stains, 75.
- Scubac, 24.
- Scurvy grass sweetmeat, 83.
- Screw bolts, zincing of, 443, 444.
- Screws, to prevent from rusting-in, 443.
- Sealing wax and wafers, 316-319.
- Seaweed leather, 177.
lubricant, 234.
soap, 177.

- Seaweeds for leather, soap, and glue, 177.
 Sebacid acids, production of, from crude cotton-seed oil, or from its residues, 451.
 Seed, black mustard, yield of oil by, 2.
 flax, yield of oil by, 2.
 hemp, yield of oil by, 2.
 rape, yield of oil by, 2.
 watermelon, yield of oil by, 2.
 white mustard, yield of oil by, 2.
 white poppy, yield of oil by, 2.
 Seeds, percentage of oil in, 1, 2.
 yield of per cent. of oil, 2.
 Sensitive photo-paper, 306.
 Sept graines, eau de, 22.
 Serpents, Pharaoh's, 128.
 Serviette magique, for metals, 77.
 Sevilla snuff, 353.
 Shafts, lubricants for, 232.
 Shale oil, residues of, 247.
 Sharp and Smith's patent gunpowder, 31.
 Sharpening stone for pencils, 177.
 Shaving cream, 446, 447.
 soap, 334.
 Sheepskins, to dye, 219, 220.
 Shellac, to bleach, 37, 38.
 Shell, tortoise, cement for, 65.
 tortoise, dyeing, how to imitate, 43, 44.
 Shellinger's artificial stone, 50.
 Sheet-iron, enamel for, 116.
 Sheet-metal, to lacquer, 244, 245.
 Ships' bottoms, to protect, 266.
 Shoddy, how made, 347, 348.
 Shoe blacking, dressings, etc., 319-322.
 blackening, good, requirements for, 319, 320.
 dressings, 319-322.
 Shoes and boots, French process of water-proofing, 385.
 Shoemakers, gutta-percha solution for, 60.
 Shoemakers' wax from coal-tar oils, 257.
 Short hair, utilization of, 348.
 Show windows, cleansing powder for, 419.
 windows, gilding on, 148.
 Shrinking of wood, 396.
 Sign painting, 148, 149.
 Signs, glass and other, 147-149.
 Silex soap, 328.
 Silica-hydrate, purification of sugar beet juice by, 344.
 Silicium, 242.
 Silk and cotton goods, soap for removing stains, 76.
 and silk fabrics, to wash, 363.
 and woollen fabrics, to restore the color of, 366.
 bleaching of, 36.
 cleansing old, 95, 96.
 cloth, and hats, scouring soap for, 76.
 cotton, and wool, to dye with aniline colors, 100-105.
 damasks, to wash, 362.
 dresses, to wash, 366.
 dyeing of, 95, 96.
 gauze, 348.
 gilding on, 412.
 goods, soap for washing, 334.
 ribbons mixed with gold and silver thread, to wash, 362.
 ribbons, to wash, 362.
 silvering or gilding, 92.
 stockings, to wash, 364.
 to remove ink stains from, 75.
 Silk, to remove oil from, 346.
 to remove tar, grease, oil, and varnish from, 75.
 Silver, alloys resembling, 8, 403.
 and aluminium alloys, 4.
 and gold lace, to polish, 364.
 and gold lace, to wash, 362, 363.
 bath, Sutton's, 306.
 Chinese, alloy, 7.
 fulminate of, 33.
 hard, receipt for, 241.
 oxidized, 411, 442.
 polishing powder for, 78.
 size, preparation of, 91.
 solder, 338.
 to cleanse, 78.
 to regain from gelatine emulsions, 305.
 to restore the lustre of, 260.
 Silvered dial plates, to cleanse, 421.
 telescopic mirrors, 113.
 Silvering, 91.
 and gilding, detection of imitations, 2.
 and gilding leather, 445.
 and gilding silk, cotton, and woollen yarns, 92.
 galvano plastic, 112.
 gilding, bronzing, etc., 412-415.
 iron and steel, 113.
 metals, Adricelle's process, 112.
 new alloy for, 404.
 of copper, 112, 113.
 of steel, 112.
 on glass, 148.
 steel, Satori's process, 112.
 tincture, 112.
 Silver-plated ware, liquid polish for, 419.
 Silverware, to clean, 420.
 Size, a new, from starch, 324.
 for bonnet frames, 326, 327.
 for laces, 326.
 for woollen goods, 327.
 Sizes for linen, 326.
 Sizing and dressing for cotton, wool, straw, etc., 322-327.
 Skins and hides, to improve, 217.
 animal, dyeing and patterning, 219.
 animal, preparation, free from arsenic, for preserving, 408.
 animal, to preserve, 161.
 naturally white, to dye, 220.
 to preserve and make water-proof, 216, 217.
 Slag, cement from, 51, 52.
 Slate, substitute for, 182.
 to polish, 78.
 Slating for blackboards, etc., 177.
 Sleight bells, American, 5.
 Smoked beef, 315.
 Smoking tobacco, Turkish, 354, 355.
 Smoky walls, to clean, 421.
 Sneezing powders, 354.
 Snuff manufacture, 353, 354.
 Soap balsam for sprains, 296.
 Soap-boiling table, Priuz's practical, 336.
 Soap, coconut oil and molasses, 329, 330.
 cold water, 329.
 creams, 332, 333.
 effect of, on oil paintings, 258.
 elaine, 329.
 fat of bones for, 250, 251.
 floating, 329.
 for frosted limbs, 332.

- Soap for washing silk goods, 334.
 for water-proofing woollen cloth and other fabrics, 383.
 from cotton-seed oil, to remove the disagreeable odor of, 451.
 from seaweeds, 177.
 hard and soft soaps, medicated and toilet soaps, etc., 327-336.
 liniment, 167.
 molasses, 329.
 Oranienburg, 330.
 paper, preparation of, 455.
 plaster, 298.
 preparation of, from crude cotton-seed oil, or from residues obtained by its purification, 451.
 rosin, 327, 328.
 sand, 330, 331.
 scouring, 76.
 silix, 328.
 soft, 329.
 varnish for gilding, 423.
 varnishes, 423.
 wax, 387, 388.
- Soaps, American, 327, 328.**
 medicated and toilet, 331-335.
 neutral, 330.
 polishing, 420.
 scouring, 76, 77.
 water-glass, 330.
- Sobrero's process for dynamite, 29.**
- Soda, caustic, to purify water, 72.**
 lye, caustic, to prepare, 335.
 percentage of, in lyes, tables of, 335.
 water-glass for protecting white colors in printing fabrics, 379.
 water-glass, preparations of, 378.
- Soft solder, 337.**
- Solder, brass, hard, 337.**
 copper as a, for iron, 337.
 for argentan, 337, 338.
 for brass and sheet tin, 339.
 for Britannia metal, 339.
 for German silver, 337, 338.
 for gold on aluminium bronze, 339.
 for iron and steel, 339.
 for pewter, 339.
 for steel on sheet-iron, 340.
 hard, 339.
 hard, containing tin, 337.
 hard, soft, and bismuth, 337.
 hard white, 339.
 liquefiable, 338.
 new, for metal, glass, and porcelain, 441.
 refractory, 338.
 silver, 338.
 silver, for plated ware, 339.
 soft, 339.
 soft, to color yellow, 415.
- Soldering and solders, 336-340.**
 autogenous, 337.
 liquid, causing no rust, 340.
 liquid, free from acid, 340.
 small articles, 340.
 saws, 340.
 without a soldering iron, 340.
- Solders for articles to be enamelled, 338.**
 for gold, 338.
 hard, 337-339.
 hard yellow, 339.
 soft, 337, 339.
- Solders, tables of, 337-339.**
- Sole leather, imitations of, 183.**
- Soles, shoe, to improve the appearance of, 322.**
- Solid inks, 194, 199.**
- Soluble glass and its uses, 378-382.**
- Solutions, caoutchouc, 299.**
- Sorel's artificial stone, 50.**
- Sounding-board wood, extraction and impregnation of, 369.**
- Soup extract, 129.**
 tablets, 129.
- Soya aqua vitæ, 24.**
- Spanish bitters, 24.**
 bitters essence, 16.
- Spavin, remedy for, 294.**
- Spence's metal, 405.**
 powder for cannon of large calibre, 31.
- Spermaceti ointment, 167.**
- Spiced chocolate, 56, 57.**
 vinegar, 361.
- Spice for lozenges, 84.**
- Spindles, oil for, 234.**
- Spirit gold lac varnishes, 206, 207.**
 lacquers, 205.
 of wine, to produce from wine-lees, 375, 376.
- Splittgerber's mixture for ruby, 10.**
- Sponges, to bleach, 37.**
- Spontaneous combustion, experiments with oils in regard to, 438.**
- Spoons and forks, alloys for, 6.**
- Spoonwort sweetmeat, 83.**
- Sprains, balsam for, 296.**
- Springs and saws, to harden, 240, 241.**
- Spring steel, lacquer for, 211.**
- Spruce beer, 160.**
- Stables, to purify the air in, 168.**
- Stained wood, to cleanse, 164.**
- Stain for walking canes, 392.**
- Staining maple wood silver-gray, 392, 393.**
 metals, receipts for, 243, 244.
 wood for fine cabinet work, 391.
 wood for veneers, mosaics, etc., 393, 394.
- Stains, ebony, 393.**
 for papers, 279-281.
 for veneers, 393.
 for willow-ware, 458-460.
 ink, to remove, 75.
 ink, to remove from silk, 75.
 means of removing, 369.
 mildew, wine, or fruit, to remove, 75.
 rust, to remove from clothes, 368.
 to remove from books, 77.
 wine and vinegar soap for, 76.
- Stamp color, blue, 80.**
- Stamping ink, 200.**
 ink, containing iron, 190.
- Stamps, postage, paste for, 68.**
 rubber, manufacture of, 59, 60.
- Starch, crimson dye, 365.**
 dye, 365.
 gloss, 370.
 glucose and dextrose, Jepp's process of manufacturing, 341-343.
 sugar, refining of, 341.
- Statuary bronze, 8.**
- St. Vincent Rappée snuff, 354.**
- Steam glues, 154.**
 pipes, cement for, 63.
 pipes, earths for insulating, 137.
 pipes, heat insulating coverings for, 137.

- Stearine candles, cheap mode of making, 173.**
Steel and iron, black polish for, 210.
 and iron, silvering of, 113.
 and iron, solder for, 339.
 and iron, staining, 243, 244.
 and iron, to cleanse from rust, 76.
 bath for coppering, 115.
 bath for nickelling, 109.
 blue bronze on brass, 46.
 cast, to restore burnt, 238.
 copper, 242.
 damaskeening, 89.
 etched with sulphuric acid, 5.
 gilding of, 413, 414.
 hardening composition for, 439.
 hardening water for, 240.
 instruments, to harden, 239.
 mechanically hardened, 441.
 on sheet-iron, solder, 340.
 pens, inks for, 195, 196.
 Poncelet's fluids for hardening, 240.
 silvering of, 112.
 thin, Hartmann's hardening compound for, 240.
 to convert iron into, 241.
 to harden in sealing wax, 240.
 to soften, 238.
 welding, 239.
 wire for musical instruments, 241.
Stein's receipts for compositions of glass, as actually used in various glass works, 142-144.
Steps, sandstone, to repair, 54.
Stereotyping, paper matrices for, 115.
Sternutative powders, 354.
Stettin bitters, 24.
Stickiness of dried caoutchouc, how to remove, 60.
Sticking plasters, 297.
Stockings, silk, to wash, 364.
Stomach bitters, 24, 25.
 bitters, Vienna, 25.
Stomachic elixir, 295.
 lozenges, 84.
 ratafia, 26, 27.
Stone and brick walls, to protect from moisture, 164.
 and wood, wash for, 164, 165.
 artificial building, 49.
 artificial, for filtering, 71.
 cement for fastening iron on, 64.
 cheap paint for, 263.
 cork, 415.
 substitute for, 176.
 troughs, cement for, 64.
 walls, water-glass for, 381.
 water-proof paint for, 264.
Stones, building, 51.
 porous, to make tough and impermeable, 54.
 precious, to cleanse, 78.
 silicifying of, by water-glass, 379.
Stonework, to prevent disintegration of, 264, 265.
Stop cocks, metal, composition for, 7.
Storax pills, 295.
Stove polish, 169.
Stoves, iron, cement for, 66.
Stramonium pastils, 293.
Strass, basis of artificial gems, 10.
 compositions for, 143, 144.
Strawberry extract, 16.
 vinegar, 362.
Straw, bleaching and dyeing of, 455, 456.
 dyes, 456.
 goods, to dye, with aniline colors, 104.
 hats, to cleanse, 76.
 hats, washing, 366, 367, 447.
 preparation of, in making paper, 273, 274.
 to bleach, 38.
 to make incombustible, 124.
Strengthening tincture, 16.
Strength of materials, 456-458.
Strontia sugar from treacle and syrup, 344.
Strops, razor, composition for, 63.
Stumps, tree, to destroy, 165.
Submarine works, paint for, 263.
Substitute for caoutchouc, new, 417, 418.
 for gutta-percha, 418.
Substitutes, imitations, etc., 174-184.
Sudorate, potassic, in sheep's wool, 450.
Sugar and dextrine in malt, 221.
 and lime paste, 68.
 beet juice, clarification of, 344.
 beets, to preserve, 311.
 house clarifying slime, pigments from, 376.
 malt, 80.
 of milk, 340, 341.
 oil, to prepare, 80.
 orange, 80.
 strontia, preparation of, from treacle and syrup, 344.
 syrups, to clarify, 135.
Sugars, glucose, etc., 340-344.
Suint, 450.
Sulphate of barium, preparation of, for sizing, 327.
 of copper, to prepare, 74.
Sulpho-cyanic acid, to prepare, 73.
Sulphur, from gas lime, 376.
 liver of, to prepare, 74
 ointments, 167.
 soap, 333.
Sulphuric acid, adulterating vinegar with, 2.
 acid and sulphur, to remove from refined oils, 256.
 acid, from gas lime, 376.
Sunflower seed oil, 252.
Surgical bandage, plastic pasteboard for, 276.
Swedish matches, composition of, 236.
 matches, striking surface, 236.
Sweetmeat, Angelica, 82.
 antiscorbutic, 83.
 carnation, 82.
 cherry, 82.
 chocolate, 81.
 cinnamon, 82.
 filbert, 82.
 heliotrope, 82.
 jasmine, 82.
 lemon, 82.
 love, 82, 83.
 orange, 81.
 orange-blossom, 82.
 peppermint, 82.
 rose, 82.
 scurvy grass, 83.
 spoonwort, 83.
 sweet smelling, 83.
 vanilla, 82.
 violet, 83.
 water-cress, 83.

- Sweetmeats (conserves), 81.
 medicinal, 83-86.
 red color for, 85.
- Sweet smelling sweetmeat, 83.
- Swicent tobacco, 351.
- Swiss cordial, 25.
 herb soap, 333.
- Sympathic colors, 273.
- Sympathetic ink, 200.
- Syrups for lemonades and mineral waters,
 134, 135.
 fruit and other, 134-136.
 how to clarify, 135.
- Tables, Graham's bronzing liquids, 47, 48.
- Tablets, soup, 129.
- Tabourey elixir, 17.
- Taffeta, black, to wash, 364.
 to wash, 364.
- Tallow, adulteration of wax with, 2.
 and lard, to prevent becoming rancid, 168.
 and lard, to purify, 169.
 bleaching, 448, 449.
 candles, Juneman's process of manufacture, 172, 173.
 candles, to coat with a hard substance, 171, 172.
 to bleach and harden, 37.
- Tannery waste, Ruthay's process for making glue from, 152.
- Tannin black, for printing ink, 191
 method of extracting, 71.
 plates, 299.
 soap, 333.
 solution of, 299.
- Tanning linen, hempen and cotton fabrics, 220.
 liquor, heating, 215.
 new process of Ballatschano and Trenck, 214.
 processes, quick, 214-216.
- Tapers, wax, 388.
- Tapioca jelly, 85.
- Tar, from gases of coke ovens, 374, 375.
 from nitrogeous organic substances, 377.
 oils, nitrating for blasting compounds, 33.
 ointment, 167.
 paper, 276, 277.
 soap, 333.
 to extract oil from, 251.
 to remove from silk, 75.
 varnish, 211.
 wood, for decorations, 93.
- Tartar, cream of, to prepare, 73.
 emetic ointment, 167.
 substitute for, in dyeing wool, 105.
- Tartaric acid, adulterating vinegar with, 2.
- Tartrate of calcium, to produce from wine lees, 375, 376.
- Tawed leather, to dye, 217, 218.
- Tawing, yolks of eggs in, to preserve, 217.
- Tea and coffee trays, to clean, 78.
 beef, to prepare, 165, 166.
- Teapots, alloys for, 3.
- Teeth, cement for filling, 68, 69.
 Robertson's alloy for filling, 3.
- Telegraph paper, electro-chemical, 277.
- Telescopes, alloy for, 5.
- Telescopic mirrors, silvered, 113.
- Terra-cotta lumber, 416.
- Test for detection of water in essential oils, 449.
- Testing lubricating oils, 436-438.
 oils, Maumené's process of, 257.
- Tests for foreign substances in beer, 223-226.
- Textile fabrics and tissues, 344-349.
 fabrics, effect of heat upon, 344.
 fabrics, to coat with metallic substances, 344.
 fabrics, to render water-, rot-, and insect-proof, 453, 454.
 fabrics, to water-proof, 384.
- Thaw, frozen ground, to, 70, 71.
- Theatre scenes, to make incombustible, 124.
- Thermaline, 297.
- Thiem's bitters, 25.
- Thurston's autographic torsion testing machine, 456-458.
 machine for testing lubricating oils, 436-438.
- Tiles, to paint red, 266.
- Timbers, mine, preparation of, 395, 396.
 relative durability of mine, 395, 396.
- Tin and aluminium alloys, 4.
 bath for nickelling, 109.
 enamel, 144.
 red copper bronze on, 46.
 roofs, durable paint for, 264.
 salt, for removing rust stains, 368.
 to decorate with copper plates and lithographs, 94.
- Tincture, absinthe, 13.
 anise-seed, 13.
 aromatic, 13.
 calamus, 14.
 of litmus, to prepare, 71.
 silvering, 112.
 strengthening, 16.
 vanilla, 16.
- Tinctures, extracts, essences, and waters, 13-16.
- Tin foil, substitute for, 178.
- Tinning, cold, 114.
 cooking utensils, 114.
 of cast-iron, 113, 114.
 of tissues, 348.
- Tin-plates, bath for nickelling, 109.
- Tinsmiths, varnish for, 208.
- Tissier on the effect of iron in aluminium, 5.
- Tissues and fabrics, 344-349.
 bleaching woollen, 35, 36.
 cleansing fluid for, 368.
 incombustible, 123, 124.
 tinning of, 348.
 to make incombustible, 122-124.
 to size with alkaline solutions of silk, wool, or feathers, 325.
 to water-proof, 382.
 various processes of water-proofing, 383.
- Tivoli cordial, 25.
- Tobacco, American, to give it the flavor of Havana, 354, 355.
 apparatus for testing percentage of nicotine in, 74.
 Brazilian, 349.
 canasters, 350.
 Chinese or star, 350.
 improvement of inferior qualities of, 352, 353.
 "Legitimo," 349.
 new process of preparing, 355.
 petum optimum, 351.
 Portocarero, 351.
 Porto Rico, 351.

- Tobacco**, preparation of leaf, for cigars, 355.
 smoking tobacco, snuff, sternutative powders, etc., 349-355.
 sweet scented, 351.
Swicent, 351.
 to remove disagreeable smell from, 353.
Varinas, 351.
Tobaccos, smoking, 349.
Toilet and medicated soaps, 331-335.
 soaps, to gloss, 334.
Tonics, hair, 288-290.
Toning bath for photography, Parkinson's, 306.
 baths, to regain the gold from, 304.
Tools, apparatus for coating, 412.
 marking, with a name, 443.
 protecting from acids, 412, 413.
Toothache, elixir for, 295.
Tooth paste, Hager's, 95.
 powder, American, 94.
 powder, Cartwright's, 94.
 powder, charcoal, 95.
 powder, Circassian, 95.
 powder, Hager's, 95.
 powder, Hufeland's, 95.
 powder, Paris, 95.
 powder, preparation of precipitated chalk for, 446.
 powder, red, 95.
 powders, Deschamps, 94.
Topaz, formula for, 11.
Torches, incombustible, 170.
Torsion testing machine, 456-458.
Tortoise-shell, cement for, 65.
 dyeing horn to imitate, 43, 44.
Toughened glass, 434, 435.
Tourmaline, formula for, 11.
Toys, innoxious paints for, 270, 271.
 mass for, 62.
Trabak metal, 403.
Tracing linen, 276.
 paper, 276.
Train oil, to purify, 251.
Transferring photographs to glass, 434.
Transfer paper for lithographic work, 276.
 paper with collodio-chloride of silver for photography, 306.
Transparent glass signs, 148.
 lacquer for closing bottles, 211.
 varnish, 208.
Trappistine, 25.
Trays, to clean, 78.
Trees, cement for injured, 69.
Tree stumps, to destroy, 165.
 wax, German, 69.
Tret's blasting powder, 30.
Troches, pectoral, 80.
Troughs, stone, cement for, 64.
Tunnersmann's tables of percentage of soda, and of anhydrous potash in lyes, 335.
Turco liqueur aqua, 18.
Furin, rossolio de, 24.
Turkey-red, dyeing with alizarine, 106, 107.
 oil, to prepare, 107.
Turkish beads, 9-12.
 beads, formula for, 12.
 smoking tobacco, 354-355.
Turnips, manure for, 169.
Turpentine liniment, 167.
 substitute for, 174.
Type metals, composition of various, 6.
Ulcers and wounds, balsam for, 296.
Ultramarine, artificial, 267.
Umbrella ribs, artificial whalebone for, 178.
Umbrellas, varnish for, 208.
Unalterable alloy, 7.
Universal cement, Davy's, 64.
Upholstering, pine needles in, 157.
Uranic oxide for yellow colors for gems, 10.
Uranium lustre, 422.
Urine, manure salt from, 169.
Utilizing cotton-seed hulls, 451.
Vakaka indorum, 58.
Vanadium ink, 196.
Vandyke red, receipt for, 270.
Vane's water-proof composition, 385.
Vanilla cordial, 25.
 essence, 16.
 ratafia, 27.
 sweetmeat, 82.
 tincture, 16.
 vinegar 362.
 water, 16.
Varnish, balloon, 207, 208.
 black, for zinc, 209.
 Chinese, 208.
 colorless, 210.
 copal, to make, 202-205, 208.
 copal, with coal-tar varnish oil, 212.
 dryer for, 266.
 for fancy articles, 208.
 for photographic negatives, 212.
 for tinsmiths, 208.
 for umbrellas, 208.
 for violins, etc., 209.
 for water-proofing paper or cloth (Johnson's), 423.
 for wood, 209.
 furniture, 207-209.
 glass-like, 210.
 gold, for iron, 208.
 gold, without lac, 206.
 incombustible, for wood, 208.
 linseed oil, 207.
 oil from coal-tar, 256.
 pitch, for buildings, 208, 209.
 printers', with coal-tar varnish oil, 190.
 soap, for gilding, 423.
 tar, 211.
 to remove from silk, 75.
 transparent, 208.
Varnishes and lacquers, 202-214.
 black, 208.
 filtering, 205, 206.
 for earthen-ware, 208.
 for wood, not affected by fire or boiling water, 208.
 photographic, 307.
 soap, 423.
 spirit gold lac, 206, 207.
 to clarify, 205.
Varnishing coaches, English method of, 212-214.
 gilding, and painting willow-ware, 460.
Variegated marble, to imitate, 51.
Varinas tobacco, 352.
Vaseline oil, white, 453.
 soap, 333.
 to prepare, 248, 249.
Vats, new glaze for, 396, 397.
 wooden, cement for, 64.

- Vegetable fat oil, process of cleansing, 247.
 fibres, improved treatment of, 345.
 fibres, to animalize, 346.
 fibres, to water-proof, 384.
 ivory, 174.
 leather, 418.
- Vegetables, garden, manures for, 169.
 new process for greening, 407.
 preserved, to give a natural color, 311.
 to preserve, 314.
- Vegetaline, 174.
- Veils, to wash, 363, 364.
- Velvet, to gild, 412.
 to remove wax from, 75.
 to wash, 363.
 which has become hard, to soften, 363.
- Veneers, drying, 181.
 imitations of, 179, 180.
 staining wood for, 393, 394.
 stains for, 393.
- Verdigris liniment, 167.
 to make, 269.
- Véritable extrait d'Absinthe, 25.
- Vermin, destruction of, 162, 163.
 Hager's composition for the destruction of, 162, 163.
- Vessels, paint for, 263.
- Vibrotypes, 308.
- "Victoria" stone, Highton's, 50.
- Vienna butter, 25, 133.
 fire-extinguishing powder, 123.
 pressed yeast, 400.
 pressed yeast, Zettler's process of manufacturing, 400, 401.
 stomach bitters, 25.
- Vinaigre à la Bordin, 362.
 à la Ravigote, 362.
- Vinegar, adulterations of, 2.
 Altwater process of manufacturing, 355-358.
 anise, 360.
 aromatic, 360, 361.
 by means of bacteria, 358-360.
 concentration of, 358.
 dragonswort, 361.
 estragon, 361.
 from cork waste, 358.
 herb, 361.
 lemon, 361.
 manufacture of ordinary and fine table vinegars, 355-362.
 orange, 362.
 pine-apple, 362.
 producers, plunging, 358.
 quick process, 358.
 raspberry, 362.
 stains, soap for, 76.
 strawberry, 362.
 vanilla, 362.
 white wine, 360.
 yellow coloring for, 358.
- Vinegars, fine table, 360-362.
 from raisins, potatoes, and rice, 360.
 spiced and effervescing, 361.
 toilette, 284, 285.
- Vine props, to preserve by impregnation, 315, 316.
- Violet indigo, 185.
 soaps, 333.
 sweetmeat, 83.
- Violins, varnish for, 209.
- Vital elixir, 17.
- Volatile products developed in roasting coffee, to regain, 377, 378.
- Vulcanized caoutchouc, cement for, 60.
 caoutchouc waste, utilization of, 60.
- Vulcan oil, 234.
- Waback's polishing wax, 77.
- Wafers and sealing wax, 316-319.
 white and colored, 318, 319.
- Wagons, lubricants for, 231-235.
- Walker's chemical bronze, 46.
- Wall-paper, gold, new process of manufacturing, 445, 446.
 paste for, 68.
- Wall-papers, glutine for, 323, 324.
 to give a gloss to, 323, 324.
 damp, glue for, 235.
- Walls, damp, how to dry, 54.
 damp, plaster for, 53.
 rough-cast and stone, water-glass for, 381.
 smoky, to clean, 421.
 to protect from moisture, 164.
- Walnut, cream, 81.
 to grain imitation of, 262.
- Warne metal, 403.
- Warts, remedy for, 160.
- Wash blues, liquid, 370.
 for carpets, Clark's, 366.
 for wood and stone, 164, 165.
 leather, cleansing of, 419.
 process, new, 366.
 red, for brick pavements, 264.
- Washed silk, to make glossy, 366.
- Washes, hair, 288, 289.
- Washing and scouring, manufacture of washing blue, etc., 362-370.
 blue, manufacture of, 368-370.
 crystal, 370.
 machines, composition of rollers for, 62.
 Palmer's process of, 366.
 powders, 370.
 silk goods, soap for, 334.
 with water-glass, 366, 366.
 woollen goods, 367, 368.
- Waste and offal, utilization of, 370-378.
 caoutchouc, utilization of, 60.
 nickel, utilization of, 443.
 of sheep wool, to utilize, 377.
 wash liquors, to recover fat and color from, 376, 377.
 woollen, to cleanse, 377.
- Watch dials, enamel for, 117.
 -makers, oils for, 235.
 -makers' oils, test for, 235.
- Water, ambergris, 18.
 and fire-proof cement, 63.
 apparatus for purifying, 72.
 blasting under, with compressed gun-cotton, 424, 425.
 cardinal, 19.
 cherry, 14.
 colors, 272, 273.
 -cress sweetmeat, 83.
 detection of in essential oils, 449.
 essences, extracts, and tinctures, 13-16.
 gold, 21.
 -melon seed, yield of oil, 2.
 hard, to soften, 168.
 orange blossom, 15.
 paradise, 22.

- Water pipes, leaden, to coat, 445.
 Polish, 23.
 raspberry, 16.
 rose, 16.
 to prevent contamination of, in leaden pipes, 445.
 vanilla, 16.
- Waters, cosmetic and medicated, 290-292.
- Water-glass and caseine cement for glass and porcelain, 382.
 and chalk mortar, 382.
 and lime cements, 382.
 as a bleaching agent, 379, 380.
 as a substitute for cow-dung in fixing alumina and iron mordants on cotton-prints, linen, etc., 379.
 as a substitute for borax and boracic acid in soldering and welding, 381.
 cement for glass and porcelain, 382.
 cement, hydraulic, 382.
 cement with zinc and pyrolusite, 382.
 cements, 381, 382.
 cementing cracked bottles with, 382.
 characteristics of, 378.
 compound, to prepare, 378, 379.
 for coating rough-cast and stone walls, 381.
 for finishing linen and cotton goods, 380.
 for preserving barrels and other wooden articles, 382.
 for silicifying stones, 379.
 from infusorial earth (Liebig), 378.
 in painting, 381.
 in painting metals and glass, 381.
 paint, Creuzburg's process of making more durable than oil or varnish, 381.
 potash, as a binding and fixing medium for ground colors on cotton goods, 380.
 potash, cheap substitute for albumen in printing with ultramarine, 380.
 potash, to prepare, 378.
 preparation of fixing, 379.
 soaps, 330.
 soda, for protecting white colors in printing fabrics, 379.
 soda, preparations of, 378.
 (soluble glass) and its uses, 378-382.
 to paint wood with, 381.
 washing with, 365, 366.
- Water-proof and incombustible fabrics, new method for the production of, 422.
 blacking, 320, 321.
 boots, 322.
 cloth which is not impervious to the air, 383.
 compounds, of Zwillings, Fournaise's, 386.
 glue, 154, 423.
 glue for wooden utensils, 66.
 mortar, 53.
 grindstones, 51.
 ointments for shoes, 321, 322.
 paint, 263.
 paper, 275.
 sail-cloth, 386.
 skins, to make, 216, 217.
- Water-proofing boots and shoes, French process, 385.
 compound, English patented, 386.
 compound, new, 383.
 compounds, 382-387.
 fabrics, new process for, 385.
- Water-proofing linen, Kuhr's receipt, 386.
 sugar bags for transportation, 385, 386.
 textile fabrics and paper, and giving them greater consistence, 386.
 textile fabrics, and protecting them against moths, 386, 387.
 tissues, preparations for, 382.
 tissues, various processes for, 383.
- Wattlen's pyrolith, 30.
- Wax, adulterated with tallow, 2.
 and wax preparations, 387-389.
 candles, 388.
 floats in alcohol, 2.
 floor, 389.
 for modelling, 389.
 for polishing furniture, 387.
 for threads to be woven, 388.
 from velvet, to remove, 75.
 grafting, 69.
 modelling, superior, 418.
 polishing, 387.
 soap, 387, 388.
 tapers, 388.
 tapers, spirit lacquer for, 389.
 tree, German, 69.
 yellow, for shoemakers, from coal-tar oils, 257.
- Waxed paper, to prepare, 388.
- Waxes, coloring of, 387-389.
- Waxing floors, new compound for, 389.
 threads, to be woven, 388.
- Weather-proof cement work, 418.
- Welding and hardening compounds, 238-241.
- Wells, to remove foul air from, 168.
- Westermeyer's artificial stone, 49.
- Weston's process of nickel-plating, 108.
- Whalebone, artificial, 178.
 ratan as a substitute for, 183.
- Whiskey, Polish, 23.
 to remove the taste of the barrel from, 230.
- White cement, 52.
 chocolate, 58.
 crayons, 79.
 fires, 125.
 metal, components of, 5.
 mustard seed, yield of oil in, 2.
 poppy seed, yield of oil in, 2.
 powder, Augendre's, 30.
 wine vinegar, 360.
- Whitewash closely resembling paint, 165.
- Wickersheimer's fluids for preserving corpses.
 anatomical specimens, etc., 310, 311.
 process of preserving meat for food, 314.
- Wicks for stearine candles, 171.
 incombustible, 170.
 metallic, 170.
- Willesdenizing, 453, 454.
- Willow-ware, 458-460.
 stains for, 458-460.
 varnishing, gilding, painting, and bronzing, 460.
- Wilson's preparation of glycerine, 74.
- Window glass, 142-144.
- Window-panes which indicate the moisture of the atmosphere, 447.
- Windows, gilding on, 148.
- Windsor soap, 334.
- Wine and vinegar stains, scouring soap for, 76.
 apple, 158.

- Wine barrels, to preserve by impregnation, 315, 316.
 blackberry, 158.
 birch, 158.
 lees, for production of tartrate of calcium and spirit of wine, 375, 376.
 must, to improve, 231.
 port, 231.
 red, alum in, 3.
 stains, scouring soap for, 76.
 stains, to remove, 75.
 to remove the taste of the barrel from, 231.
- Wines, artificial, 230, 231.
 Bordeaux, 230.
 Burgundy, 230.
 from fruits, 158-160.
 Madeira, 231.
 Malaga, 231.
 remedy for ropiness or viscosity, 231.
- Wire for musical instruments, 241.
 to coat with brass, 114.
 to protect from rust, 242, 243.
- Wires, gold and silver, alloys for imitating, 8.
- Wood, American process of preserving, 395.
 and glue putty, 67.
 and oil putty, 67.
 and stone, wash for, 164, 165.
 artificial, for ornaments, 93.
 cedar, imitation of, 396.
 cheap paint for, 263.
 coloring materials for, 391, 392.
 cuts, to bleach, 39.
 crystalline coating for, 421.
 Denninger's process of staining, for fine cabinet work, 391.
 -filler, American, 421.
 floors, putty for, 67.
 floors, to restore the original color of, 316.
 fire-proof, preparation of, 399.
 gilding on, 394, 395.
 gilding, polishing, staining, etc., 389-399.
 hard coating for, 396.
 how to make almost incombustible, 54.
 how to preserve, 55.
 maple, to stain silver-gray, 392, 393.
 mass for ornaments, 93, 94.
 method of gilding, 91, 92.
 Moody's new polish for, 394.
 new colors on, 398, 399.
 new method of drying, 397.
 new polish for, 419.
 new process of preserving, 397, 398.
 painted with water-glass, 381.
 -polishing, 211.
 polishing-wax for, 398.
 shrinking of, 396.
 -tar creosotes, 255.
 -tar for decorations, 93.
 -tar oil, purification of, 255.
 to cleanse lacquered and stained, 164.
 to glass, joining, 66.
 to make flexible and fire-proof, 389.
 to make incombustible, 122-124.
 to prevent from rotting, 315, 316.
 to render incombustible and impermeable, 390.
 to remove ink-stains from, 75.
 to render fire-proof, 390.
- Wood, to render impermeable to water, 390.
 varnishes, 208.
 water-proof paint for, 264.
- Wooden labels, preservation of, 165.
 posts, new paint for, 397.
 posts, to prevent from rotting, 164.
 utensils, water-proof glue for, 66.
 vats, cement for, 64.
- Woods, American, strength of some, 396.
- Wood's metal, components of, 5.
- Wool, artificial, 175.
 sheep's, fat from, 450.
 sheep's, potassic sudorate in, 450.
 to bleach white, 36.
 to bleach without sulphur, 36.
 to remove oil from, 346.
 to utilize waste of, 377.
- Woollen and half-woollen fabrics, to water-proof, 384.
 fabrics, to remove oil from, 346.
 fabrics, to restore the color of, 366.
 fabrics, to water-proof, 384.
 goods and yarns, dyeing of, 96-99.
 goods, sizing for, 322, 323.
 goods, to keep white, 36.
 goods, to protect, 161.
 goods, washing, 367, 368.
 tissues, bleaching, 35.
 tissues, cleansing of, 35, 36.
 waste, to cleanse, 377.
 yarns, size for, 325.
- Woolly fibre, precipitation of, 274.
- "Wootz," or Indian steel, 5.
- Worms and insects, to destroy, 161, 162.
- Wormwood cordial, 25.
 essence, 16.
 ratafia, 27.
- Wort, boiling of, with hops for brewing, 222.
- Wounds and ulcers, balsam for, 296.
 balsam for, 167, 168.
- Wringers and washing-machines, composition of rollers for, 62.
- Writing inks, 192-198.
 paper which can be washed, 276.
- Writings, to duplicate, 86.
- Wrought-iron castings, 441.
- Yarn, a new French, 349.
 flax, Hartmann's quick method of bleaching, 36, 37.
 pearl, 345.
- Yarns, cotton, size for, 325.
 silvering or gilding, 92.
 woollen, size for, 325.
- Yeast, American dry, 401.
 artificial, 401, 402.
 compressed, from uncrushed cereals, 226.
 compressed, to make, 227-229.
 improvements in treating, 402.
 manufacture of pressed, bakers' and brewers', etc., 399-403.
 pressed, from beer yeast, 402, 403.
 pressed, Schubert's method of manufacturing, 399, 400.
 Vienna pressed, 400.
- Yelks of eggs in tawing, to preserve, 217.
- Yellow crayons, 79.
 dyes, boiled with alcohol, water, and lime water, 3.
 dyes, the least stable, 3.

Yellow dyes, the most stable, 3.
pigments, 269, 270.
Ylang ylang, 284.

Zeidelite, preparation of, 178.

Zettler's process of manufacturing Vienna
pressed yeast, 400, 401.

Zinc and aluminium alloys, 4.
bath for nickelling, 109.

Zinc, black varnish for, 209.

chloride of, to prepare, 72.

ointment, 167.

paint, dryer for, 266.

painting on, 414, 415.

wash, to prepare, 264.

Zinciferous metallic colors, 137, 138.

Zincing screw-bolts, 443, 444.

Zwilling's water-proofing compound, 286.

THE END.

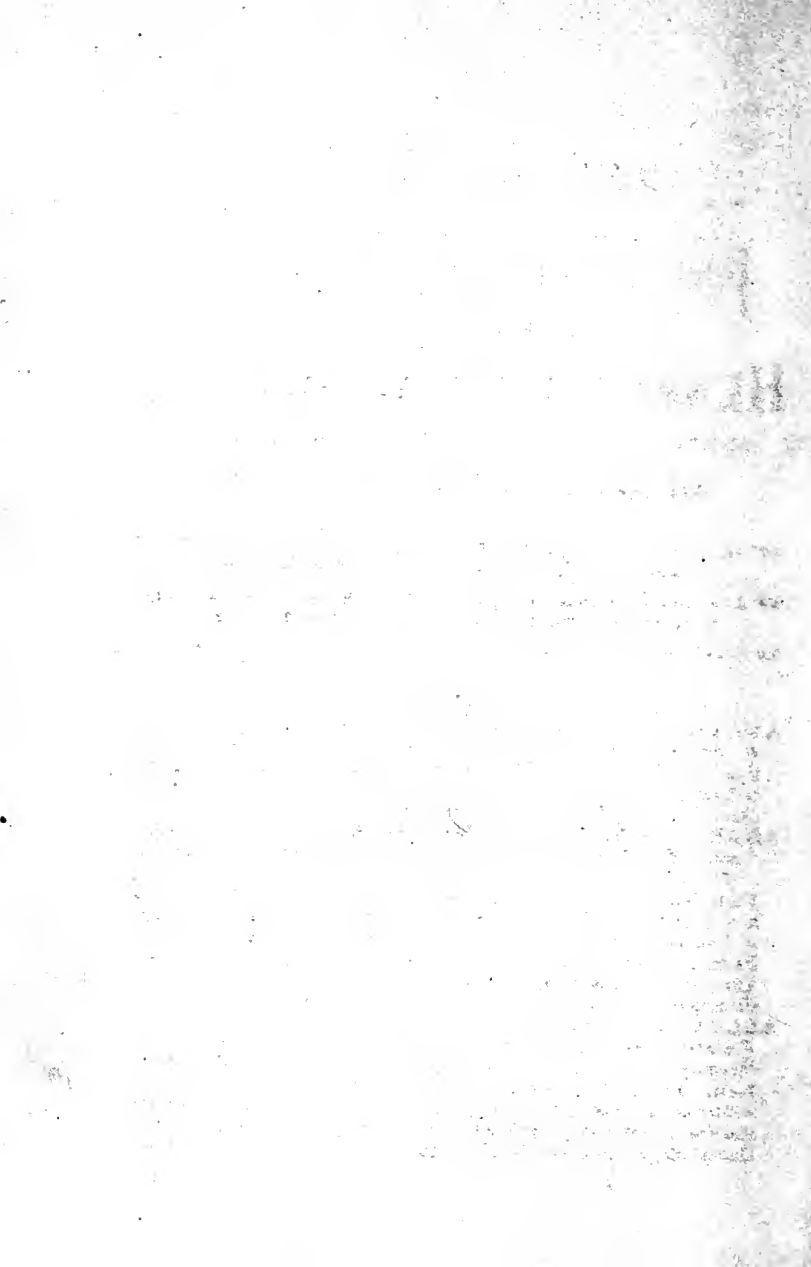

CATALOGUE
OF
Practical and Scientific Books
PUBLISHED BY
HENRY CAREY BAIRD & Co.

INDUSTRIAL PUBLISHERS, BOOKSELLERS AND IMPORTERS,

810 Walnut Street, Philadelphia.

Any of the Books comprised in this Catalogue will be sent by mail, free of postage, to any address in the world, at the publication prices.

A Descriptive Catalogue, 96 pages, 8vo., will be sent free and free of postage, to any one in any part of the world, who will furnish his address.

Where not otherwise stated, all of the Books in this Catalogue are bound in muslin.

AMATEUR MECHANICS' WORKSHOP:

A treatise containing plain and concise directions for the manipulation of Wood and Metals, including Casting, Forging, Brazing, Soldering and Carpentry. By the author of the "Lathe and Its Uses." Third edition. Illustrated. 8vo. \$3.00

ANDRES.—A Practical Treatise on the Fabrication of Volatile and Fat Varnishes, Lacquers, Siccatives and Sealing Waxes.

From the German of ERWIN ANDRES, Manufacturer of Varnishes and Lacquers. With additions on the Manufacture and Application of Varnishes, Stains for Wood, Horn, Ivory, Bone and Leather. From the German of DR. EMIL WINCKLER and LOUIS E. ANDES. The whole translated and edited by WILLIAM T. BRANNT. With 11 illustrations. 12mo. \$2.50

ARLOT.—A Complete Guide for Coach Painters:

Translated from the French of M. ARLOT, Coach Painter; for eleven years Foreman of Painting to M. Eherler, Coach Maker, Paris. By A. A. FESQUET, Chemist and Engineer. To which is added an Appendix, containing Information respecting the Materials and the Practice of Coach and Car Painting and Varnishing in the United States and Great Britain. 12mo. \$1.25

ARMENGAUD, AMOROUX, AND JOHNSON.—The Practical Draughtsman's Book of Industrial Design, and Machinist's and Engineer's Drawing Companion:

Forming a Complete Course of Mechanical Engineering and Architectural Drawing. From the French of M. Armengaud the elder, Prof. of Design in the Conservatoire of Arts and Industry, Paris, and MM. Armengaud the younger, and Amoroux, Civil Engineers. Rewritten and arranged with additional matter and plates, selections from and examples of the most useful and generally employed mechanism of the day. By WILLIAM JOHNSON, Assoc. Inst. C. E. Illustrated by fifty folio steel plates, and fifty wood-cuts. A new edition, 4to., half morocco \$10.00

ARMSTRONG.—The Construction and Management of Steam Boilers:

By R. ARMSTRONG, C. E. With an Appendix by ROBERT MALLET, C. E., F. R. S. Seventh Edition. Illustrated. 1 vol. 12mo. 75

ARROWSMITH.—Paper-Hanger's Companion:

A Treatise in which the Practical Operations of the Trade are Systematically laid down: with Copious Directions Preparatory to Papering; Preventives against the Effect of Damp on Walls; the various Cements and Pastes Adapted to the Several Purposes of the Trade; Observations and Directions for the Panelling and Ornamenting of Rooms, etc. By JAMES ARROWSMITH. 12mo., cloth \$1.25

ASHTON.—The Theory and Practice of the Art of Designing Fancy Cotton and Woollen Cloths from Sample:

Giving full instructions for reducing drafts, as well as the methods of spooling and making out harness for cross drafts and finding any required reed; with calculations and tables of yarn. By FREDERIC T. ASHTON, Designer, West Pittsfield, Mass. With fifty-two illustrations. One vol. folio \$10.00

AUERBACH—CROOKES.—Anthracen:

Its Constitution, Properties, Manufacture and Derivatives, including Artificial Alizarin, Anthrapurpurin, etc., with their applications in Dyeing and Printing. By G. AUERBACH. Translated and edited from the revised manuscript of the Author, by WM. CROOKES, F. R. S., Vice-President of the Chemical Society. 8vo. \$5.00

BAIRD.—Miscellaneous Papers on Economic Questions. By Henry Carey Baird. (*In preparation.*)

BAIRD.—The American Cotton Spinner, and Manager's and Carder's Guide:

A Practical Treatise on Cotton Spinning; giving the Dimensions and Speed of Machinery, Draught and Twist Calculations, etc.; with notices of recent Improvements: together with Rules and Examples for making changes in the sizes and numbers of Roving and Yarn. Compiled from the papers of the late ROBERT H. BAIRD. 12mo.

. \$1.50

BAIRD.—Standard Wages Computing Tables :

An Improvement in all former Methods of Computation, so arranged that wages for days, hours, or fractions of hours, at a specified rate per day or hour, may be ascertained at a glance. By T. SPANGLER BAIRD. Oblong folio \$5.00

BAKER.—Long-Span Railway Bridges :

Comprising Investigations of the Comparative Theoretical and Practical Advantages of the various Adopted or Proposed Type Systems of Construction; with numerous Formulæ and Tables. By B. BAKER. 12mo. \$1.50

BAKER.—The Mathematical Theory of the Steam-Engine :

With Rules at length, and Examples worked out for the use of Practical Men. By T. BAKER, C. E., with numerous Diagrams. Sixth Edition, Revised by Prof. J. R. YOUNG. 12mo. 75

BARLOW.—The History and Principles of Weaving, by Hand and by Power :

Reprinted, with Considerable Additions, from "Engineering," with a chapter on Lace-making Machinery, reprinted from the Journal of the "Society of Arts." By ALFRED BARLOW. With several hundred illustrations. 8vo., 443 pages \$10.00

BARR.—A Practical Treatise on the Combustion of Coal :

Including descriptions of various mechanical devices for the Economic Generation of Heat by the Combustion of Fuel, whether solid, liquid or gaseous. 8vo. \$2.50

BARR.—A Practical Treatise on High Pressure Steam Boilers :

Including Results of Recent Experimental Tests of Boiler Materials, together with a Description of Approved Safety Apparatus, Steam Pumps, Injectors and Economizers in actual use. By WM. M. BARR. 204 Illustrations. 8vo. \$3.00

BAUERMAN.—A Treatise on the Metallurgy of Iron :

Containing Outlines of the History of Iron Manufacture, Methods of Assay, and Analysis of Iron Ores, Processes of Manufacture of Iron and Steel, etc., etc. By H. BAUERMAN, F. G. S., Associate of the Royal School of Mines. Fifth Edition, Revised and Enlarged. Illustrated with numerous Wood Engravings from Drawings by J. B. JORDAN. 12mo. \$2.00

BAYLES.—House Drainage and Water Service :

In Cities, Villages and Rural Neighborhoods. With Incidental Consideration of Certain Causes Affecting the Healthfulness of Dwellings. By JAMES C. BAYLES, Editor of "The Iron Age" and "The Metal Worker." With numerous illustrations. 8vo. cloth, \$3.00

BEANS.—A Treatise on Railway Curves and Location of Railroads :

By E. W. BEANS, C. E. Illustrated. 12mo. Tucks \$1.50

BECKETT.—A Rudimentary Treatise on Clocks, and Watches and Bells :

By Sir EDMUND BECKETT, Bart., I.L. D., Q. C. F. R. A. S. With numerous illustrations. Seventh Edition, Revised and Enlarged. 12mo. \$2.25

BELL.—Carpentry Made Easy:

Or, The Science and Art of Framing on a New and Improved System. With Specific Instructions for Building Balloon Frames, Barn Frames, Mill Frames, Warehouses, Church Spires, etc. Comprising also a System of Bridge Building, with Bills, Estimates of Cost, and valuable Tables. Illustrated by forty-four plates, comprising nearly 200 figures. By WILLIAM E. BELL, Architect and Practical Builder. 8vo. \$5.00

BEMROSE.—Fret-Cutting and Perforated Carving:

With fifty-three practical illustrations. By W. BEMROSE, JR. 1 vol. quarto \$3.00

BEMROSE.—Manual of Buhl-work and Marquetry:

With Practical Instructions for Learners, and ninety colored designs. By W. BEMROSE, JR. 1 vol. quarto \$3.00

BEMROSE.—Manual of Wood Carving:

With Practical Illustrations for Learners of the Art, and Original and Selected Designs. By WILLIAM BEMROSE, JR. With an Introduction by LEWELLYN JEWITT, F. S. A., etc. With 128 illustrations, 4to. \$3.00

BILLINGS.—Tobacco:

Its History, Variety, Culture, Manufacture, Commerce, and Various Modes of Use. By E. R. BILLINGS. Illustrated by nearly 200 engravings. 8vo. \$3.00

BIRD.—The American Practical Dyers' Companion:

Comprising a Description of the Principal Dye-Stuffs and Chemicals used in Dyeing, their Natures and Uses; Mordants, and How Made; with the best American, English, French and German processes for Bleaching and Dyeing Silk, Wool, Cotton, Linen, Flannel, Felt, Dress Goods, Mixed and Hosiery Yarns, Feathers, Grass, Felt, Fur, Wool, and Straw Hats, Jute Yarn, Vegetable Ivory, Mats, Skins, Furs, Leather, etc., etc. By Wood, Aniline, and other Processes, together with Remarks on Finishing Agents, and Instructions in the Finishing of Fabrics, Substitutes for Indigo, Water-Proofing of Materials, Tests and Purification of Water, Manufacture of Aniline and other New Dye Wares, Harmonizing Colors, etc., etc.; embracing in all over 800 Receipts for Colors and Shades, *accompanied by 170 Dyed Samples of Raw Materials and Fabrics.* By F. J. BIRD, Practical Dyer, Author of "The Dyers' Hand-Book." 8vo. \$10.00

BLINN.—A Practical Workshop Companion for Tin, Sheet-Iron, and Copper-plate Workers:

Containing Rules for describing various kinds of Patterns used by Tin, Sheet-Iron and Copper-plate Workers; Practical Geometry; Mensuration of Surfaces and Solids; Tables of the Weights of Metals, Lead-pipe, etc.; Tables of Areas and Circumferences of Circles; Japan, Varnishes, Lackers, Cements, Compositions, etc., etc. By LEROY J. BLINN, Master Mechanic. With over One Hundred Illustrations. 12mo. \$2.50

BOOTH.—Marble Worker's Manual:

Containing Practical Information respecting Marbles in general, their Cutting, Working and Polishing; Veneering of Marble; Mosaics; Composition and Use of Artificial Marble, Stuccos, Cements, Receipts, Secrets, etc., etc. Translated from the French by M. L. BOOTH. With an Appendix concerning American Marbles. 12mo., cloth \$1.50

BOOTH and MORFIT.—The Encyclopædia of Chemistry, Practical and Theoretical:

Embracing its application to the Arts, Metallurgy, Mineralogy, Geology, Medicine and Pharmacy. By JAMES C. BOOTH, Melter and Refiner in the United States Mint, Professor of Applied Chemistry in the Franklin Institute, etc., assisted by CAMPBELL MORFIT, author of "Chemical Manipulations," etc. Seventh Edition. Complete in one volume, royal 8vo., 978 pages, with numerous wood-cuts and other illustrations \$5.00

BRAMWELL.—The Wool Carder's Vade-Mecum:

A Complete Manual of the Art of Carding Textile Fabrics. By W. C. BRAMWELL. Third Edition, revised and enlarged. Illustrated. Pp. 400. 12mo. \$2.50

BRANNT.—A Practical Treatise on Animal and Vegetable Fats and Oils:

Comprising both fixed and volatile oils, their physical and chemical properties, the manner of extracting and refining them, and practical rules for testing them; as well as the manufacture of Artificial Butter, Lubricants, etc. Edited chiefly from the German of Drs. KARL SCHAEGLER, G. W. ASKINSON, and RICHARD BRUNNER, with additions. By WILLIAM T. BRANNT. Illustrated by numerous Engravings. About 600 pages. 8vo. (In Press.) \$.

BRANNT.—A Practical Treatise on the Manufacture of Soap and Candles:

Based upon the most Recent Experiences in the Practice and Science; comprising the Chemistry, Raw Materials, Machinery, and Utensils and Various Processes of Manufacture. Edited from the German of Dr. C. DEITE, A. ENGELHARDT, Dr. C. SCHAEGLER, and others. By WILLIAM T. BRANNT. Illustrated by numerous Engravings. 8vo. (In Preparation.) \$.

BRANNT.—A Practical Treatise on the Raw Materials and the Distillation and Rectification of Alcohol, and the Preparation of Alcoholic Liquors, Liqueurs, Cordials, Bitters, etc.:

Edited chiefly from the German of Dr. K. Stammer, Dr. F. Elsner, and E. Schubert. By WM. T. BRANNT. Illustrated by thirty-one engravings. 12mo. \$2.50

- BRANNT—WAHL.**—**The Techno-Chemical Receipt Book :**
Containing several thousand Receipts covering the latest, most important, and most useful discoveries in Chemical Technology, and their Practical Application in the Arts and the Industries. Edited chiefly from the German of Drs. Winckler, Elsner, Heintze, Mierzinski, Jacobsen, Koller, and Heinzerling, with additions by WM. T. BRANNT and WM. H. WAHL, PH. D. Illustrated by 78 engravings. 12mo. 495 pages \$2 00
- BROWN.**—**Five Hundred and Seven Mechanical Movements.**
Embracing all those which are most important in Dynamics, Hydraulics, Hydrostatics, Pneumatics, Steam-Engines, Mill and other Gearing, Presses, Horology and Miscellaneous Machinery; and including many movements never before published, and several of which have only recently come into use. By HENRY T. BROWN. 12mo. \$1.00
- BUCKMASTER.**—**The Elements of Mechanical Physics :**
By J. C. BUCKMASTER. Illustrated with numerous engravings. 12mo. \$1.50
- BULLOCK.**—**The American Cottage Builder :**
A Series of Designs, Plans and Specifications, from \$200 to \$20,000, for Homes for the People; together with Warming, Ventilation, Drainage, Painting and Landscape Gardening. By JOHN BULLOCK, Architect and Editor of "The Rudiments of Architecture and Building," etc., etc. Illustrated by 75 engravings. 8vo. \$3.50
- BULLOCK.**—**The Rudiments of Architecture and Building :**
For the use of Architects, Builders, Draughtsmen, Machinists, Engineers and Mechanics. Edited by JOHN BULLOCK, author of "The American Cottage Builder." Illustrated by 250 Engravings. 8vo. \$3.50
- BURGH.**—**Practical Rules for the Proportions of Modern Engines and Boilers for Land and Marine Purposes.**
By N. P. BURGH, Engineer. 12mo. \$1.50
- BYLES.**—**Sophisms of Free Trade and Popular Political Economy Examined.**
By a BARRISTER (SIR JOHN BARNARD BYLES, Judge of Common Pleas). From the Ninth English Edition, as published by the Manchester Reciprocity Association. 12mo. \$1.25
- BOWMAN.**—**The Structure of the Wool Fibre in its Relation to the Use of Wool for Technical Purposes :**
Being the substance, with additions, of Five Lectures, delivered at the request of the Council, to the members of the Bradford Technical College, and the Society of Dyers and Colorists. By F. H. BOWMAN, D.Sc., F. R. S. E., F. L. S. Illustrated by 32 engravings. 8vo. \$6.50
- BYRNE.**—**Hand-Book for the Artisan, Mechanic, and Engineer :**
Comprising the Grinding and Sharpening of Cutting Tools, Abrasive Processes, Lapidary Work, Gem and Glass Engraving, Varnishing and Lacking, Apparatus, Materials and Processes for Grinding and

- Polishing, etc. By OLIVER BYRNE. Illustrated by 185 wood engravings. 8vo. \$5.00
- BYRNE.—Pocket-Book for Railroad and Civil Engineers :**
Containing New, Exact and Concise Methods for Laying out Railroad Curves, Switches, Frog Angles and Crossings; the Staking out of work; Levelling; the Calculation of Cuttings; Embankments; Earth-work, etc. By OLIVER BYRNE. 18mo., full bound, pocket-book form \$1.75
- BYRNE.—The Practical Metal-Worker's Assistant :**
Comprising Metallurgic Chemistry; the Arts of Working all Metals and Alloys; Forging of Iron and Steel; Hardening and Tempering; Melting and Mixing; Casting and Founding; Works in Sheet Metal; the Processes Dependent on the Ductility of the Metals; Soldering; and the most Improved Processes and Tools employed by Metal-Workers. With the Application of the Art of Electro-Metallurgy to Manufacturing Processes; collected from Original Sources, and from the works of Holtzapffel, Bergeron, Leupold, Plumier, Napier, Scoffern, Clay, Fairbairn and others. By OLIVER BYRNE. A new, revised and improved edition, to which is added an Appendix, containing The Manufacture of Russian Sheet-Iron. By JOHN PERCY, M. D., F. R. S. The Manufacture of Malleable Iron Castings, and Improvements in Bessemer Steel. By A. A. FESQUET, Chemist and Engineer. With over Six Hundred Engravings, Illustrating every Branch of the Subject. 8vo. \$7.00
- BYRNE.—The Practical Model Calculator :**
For the Engineer, Mechanic, Manufacturer of Engine Work, Naval Architect, Miner and Millwright. By OLIVER BYRNE. 8vo., nearly 600 pages \$4.50
- CABINET MAKER'S ALBUM OF FURNITURE :**
Comprising a Collection of Designs for various Styles of Furniture. Illustrated by Forty-eight Large and Beautifully Engraved Plates. Oblong, 8vo. \$3.50
- CALLINGHAM.—Sign Writing and Glass Embossing :**
A Complete Practical Illustrated Manual of the Art. By JAMES CALLINGHAM. 12mo. \$1.50
- CAMPIN.—A Practical Treatise on Mechanical Engineering :**
Comprising Metallurgy, Moulding, Casting, Forging, Tools, Workshop Machinery, Mechanical Manipulation, Manufacture of Steam-Engines, etc. With an Appendix on the Analysis of Iron and Iron Ores. By FRANCIS CAMPIN, C. E. To which are added, Observations on the Construction of Steam Boilers, and Remarks upon Furnaces used for Smoke Prevention; with a Chapter on Explosions. By R. ARMSTRONG, C. E., and JOHN BOURNE. Rules for Calculating the Change Wheels for Screws on a Turning Lathe, and for a Wheel-cutting Machine. By J. LA NICCA. Management of Steel, Including Forging, Hardening, Tempering, Annealing, Shrinking and Expansion; and the Case-hardening of Iron. By G. EDE. 8vo. Illustrated with twenty-nine plates and 100 wood engravings . . . \$5.00

CAREY.—A Memoir of Henry C. Carey.

By DR. WM. ELDER. With a portrait. 8vo., cloth . . . 75

CAREY.—The Works of Henry C. Carey :**Harmony of Interests: Agricultural, Manufacturing and Commercial.** 8vo. . . . \$1.50**Manual of Social Science.** Condensed from Carey's "Principles of Social Science." By KATE MCKEAN. 1 vol. 12mo. . . \$2.25**Miscellaneous Works.** With a Portrait. 2 vols. 8vo. . . \$6.00**Past, Present and Future.** 8vo. . . . \$2.50**Principles of Social Science.** 3 volumes, 8vo. . . \$10.00**The Slave-Trade, Domestic and Foreign; Why it Exists, and How it may be Extinguished (1853).** 8vo. . . \$2.00**The Unity of Law: As Exhibited in the Relations of Physical, Social, Mental and Moral Science (1872).** 8vo. . . \$3.50**CLARK.—Tramways, their Construction and Working :**

Embracing a Comprehensive History of the System. With an exhaustive analysis of the various modes of traction, including horse-power, steam, heated water and compressed air; a description of the varieties of Rolling stock, and ample details of cost and working expenses. By D. KINNEAR CLARK. Illustrated by over 200 wood engravings, and thirteen folding plates. 2 vols. 8vo. . . \$12.50

COLBURN.—The Locomotive Engine :

Including a Description of its Structure, Rules for Estimating its Capabilities, and Practical Observations on its Construction and Management. By ZERAH COLBURN. Illustrated. 12mo. . . \$1.00

COLLENS.—The Eden of Labor; or, the Christian Utopia.

By T. WHARTON COLLENS, author of "Humanics," "The History of Charity," etc. 12mo. Paper cover, \$1.00; Cloth . . \$1.25

COOLEY.—A Complete Practical Treatise on Perfumery :

Being a Hand-book of Perfumes, Cosmetics and other Toilet Articles. With a Comprehensive Collection of Formulæ. By ARNOLD J. COOLEY. 12mo. . . . \$1.50

COOPER.—A Treatise on the use of Belting for the Transmission of Power.

With numerous illustrations of approved and actual methods of arranging Main Driving and Quarter Twist Belts, and of Belt Fastenings. Examples and Rules in great number for exhibiting and calculating the size and driving power of Belts. Plain, Particular and Practical Directions for the Treatment, Care and Management of Belts. Descriptions of many varieties of Beltings, together with chapters on the Transmission of Power by Ropes; by Iron and Wood Frictional Gearing; on the Strength of Belting Leather; and on the Experimental Investigations of Morin, Briggs, and others. By JOHN H. COOPER, M. E. 8vo. . . . \$3.50

CRAIK.—The Practical American Millwright and Miller.

By DAVID CRAIK, Millwright. Illustrated by numerous wood engravings and two folding plates. 8vo. . . . \$5.00

CRISTIANI.—A Technical Treatise on Soap and Candles :

With a Glance at the Industry of Fats and Oils. By R. S. CRISTIANI, Chemist. Author of "Perfumery and Kindred Arts." Illustrated by 176 engravings. 581 pages, 8vo. . . . \$7.50

CRISTIANI.—Perfumery and Kindred Arts :

A Comprehensive Treatise on Perfumery, containing a History of Perfumes from the remotest ages to the present time. A complete detailed description of the various Materials and Apparatus used in the Perfumer's Art, with thorough Practical Instruction and careful Formulæ, and advice for the fabrication of all known preparations of the day, including Essences, Tinctures, Extracts, Spirits, Waters, Vinegars, Pomades, Powders, Paints, Oils, Emulsions, Cosmetics, Infusions, Pastilles, Tooth Powders and Washes, Cachous, Hair Dyes, Sachets, Essential Oils, Flavoring Extracts, etc.; and full details for making and manipulating Fancy Toilet Soaps, Shaving Creams, etc., by new and improved methods. With an Appendix giving hints and advice for making and fermenting Domestic Wines, Cordials, Liquors, Candies, Jellies, Syrups, Colors, etc., and for Perfuming and Flavoring Segars, Snuff and Tobacco, and Miscellaneous Receipts for various useful Analogous Articles. By R. S. CRISTIANI, Consulting Chemist and Perfumer, Philadelphia. 8vo. . . . \$5.00

CUPPER.—The Universal Stair-Builder :

Being a new Treatise on the Construction of Stair-Cases and Hand-Rails; showing Plans of the various forms of Stairs, method of Placing the Risers in the Cylinders, general method of describing the Face Moulds for a Hand-Rail, and an expeditious method of Squaring the Rail. Useful also to Stonemasons constructing Stone Stairs and Hand-Rails; with a new method of Sawing the Twist Part of any Hand-Rail square from the face of the plank, and to a parallel width. Also, a new method of forming the Easings of the Rail by a gauge; preceded by some necessary Problems in Practical Geometry, with the Sections of Prismatic Solids. Illustrated by 29 plates. By R. A. CUPPER, Architect, author of "The Practical Stair-Builder's Guide." Third Edition. Large 4to. . . .

DAVIDSON.—A Practical Manual of House Painting, Grain-ing, Marbling, and Sign-Writing :

Containing full information on the processes of House Painting in Oil and Distemper, the Formation of Letters and Practice of Sign-Writing, the Principles of Decorative Art, a Course of Elementary Drawing for House Painters, Writers, etc., and a Collection of Useful Receipts. With nine colored illustrations of Woods and Marbles, and numerous wood engravings. By ELLIS A. DAVIDSON. 12mo. \$3.00

DAVIES.—A Treatise on Earthy and Other Minerals and Mining :

By D. C. DAVIES, F. G. S., Mining Engineer, etc. Illustrated by 76 Engravings. 12mo. . . . \$5.00

DAVIES.—A Treatise on Metalliferous Minerals and Mining:

By D. C. DAVIES, F. G. S., Mining Engineer, Examiner of Mines, Quarries and Collieries. Illustrated by 148 engravings of Geological Formations, Mining Operations and Machinery, drawn from the practice of all parts of the world. 2d Edition, 12mo., 450 pages \$5.00

DAVIES.—A Treatise on Slate and Slate Quarrying:

Scientific, Practical and Commercial. By D. C. DAVIES, F. G. S., Mining Engineer, etc. With numerous illustrations and folding plates. 12mo. \$2.50

DAVIS.—A Practical Treatise on the Manufacture of Bricks, Tiles, Terra-Cotta, etc.:

Including Common, Pressed, Ornamentally Shaped, and Enamelled Bricks, Drain-Tiles, Straight and Curved Sewer-Pipes, Fire-Clays, Fire-Bricks, Terra-Cotta, Roofing-Tiles, Flooring-Tiles, Art-Tiles, Mosaic Plates, and Imitation of Intarsia or Inlaid Surfaces; comprising every important Product of Clay employed in Architecture, Engineering, the Blast-Furnace, for Retorts, etc., with a History and the Actual Processes in Handling, Disintegrating, Tempering, and Moulding the Clay into Shape, Drying Naturally and Artificially, Setting and Burning, Enamelling in Polychrome Colors, Composition and Application of Glazes, etc.; including Full Detailed Descriptions of the most modern Machines, Tools, Kilns, and Kiln-Roofs used. By CHARLES THOMAS DAVIS. Illustrated by 228 Engravings and 6 Plates. 8vo., 472 pages \$5.00

DAVIS.—The Manufacture of Leather:

Being a description of all of the Processes for the Tanning, Tawing, Currying, Finishing and Dyeing of every kind of Leather; including the various Raw Materials and the Methods for Determining their Values; the Tools, Machines, and all Details of Importance connected with an Intelligent and Profitable Prosecution of the Art, with Special Reference to the Best American Practice. To which are added Complete Lists of all American Patents for Materials, Processes, Tools, and Machines for Tanning, Currying, etc. By CHARLES THOMAS DAVIS. Illustrated by 302 engravings and 12 Samples of Dyed Leathers. One vol., 8vo., 824 pages \$10.00

DAWIDOWSKY—BRANNT.—A Practical Treatise on the Raw Materials and Fabrication of Glue, Gelatine, Gelatine Veneers and Foils, Isinglass, Cements, Pastes, Mucilages, etc.:

Based upon Actual Experience. By F. DAWIDOWSKY, Technical Chemist. Translated from the German, with extensive additions, including a description of the most Recent American Processes, by WILLIAM T. BRANNT, Graduate of the Royal Agricultural College of Eldena, Prussia. 35 Engravings. 12mo. \$2.50

DE GRAFF.—The Geometrical Stair-Builders' Guide:

Being a Plain Practical System of Hand-Railing, embracing all its necessary Details, and Geometrically Illustrated by twenty-two Steel Engravings; together with the use of the most approved principles of Practical Geometry. By SIMON DE GRAFF, Architect. 4to.

\$2.50

DE KONINCK—DIETZ.—A Practical Manual of Chemical Analysis and Assaying:

As applied to the Manufacture of Iron from its Ores, and to Cast Iron, Wrought Iron, and Steel, as found in Commerce. By L. L. DE KONINCK, Dr. Sc., and E. DIETZ, Engineer. Edited with Notes, by ROBERT MALLET, F. R. S., F. S. G., M. I. C. E., etc. American Edition, Edited with Notes and an Appendix on Iron Ores, by A. A. FESQUET, Chemist and Engineer. 12mo. . . . \$2.50

DUNCAN.—Practical Surveyor's Guide:

Containing the necessary information to make any person of common capacity, a finished land surveyor without the aid of a teacher. By ANDREW DUNCAN. Illustrated. 12mo. . . . \$1.25

DUPLAIS.—A Treatise on the Manufacture and Distillation of Alcoholic Liquors:

Comprising Accurate and Complete Details in Regard to Alcohol from Wine, Molasses, Beets, Grain, Rice, Potatoes, Sorghum, Asphodel, Fruits, etc.; with the Di-tillation and Rectification of Brandy, Whiskey, Rum, Gin, Swiss Absinthe, etc., the Preparation of Aromatic Waters, Volatile Oils or Essences, Sugars, Syrups, Aromatic Tinctures, Liqueurs, Cordial Wines, Effervescing Wines, etc., the Ageing of Brandy and the improvement of Spirits, with Copious Directions and Tables for Testing and Reducing Spirituous Liquors, etc., etc. Translated and Edited from the French of MM. DUPLAIS, Aîné et Jeune. By M. MCKENNIE, M. D. To which are added the United States Internal Revenue Regulations for the Assessment and Collection of Taxes on Distilled Spirits. Illustrated by fourteen folding plates and several wood engravings. 743 pp. 8vo. \$10 00

DUSSAUCE.—A General Treatise on the Manufacture of Vinegar:

Theoretical and Practical. Comprising the various Methods, by the Slow and the Quick Processes, with Alcohol, Wine, Grain, Malt, Cider, Molasses, and Beets; as well as the Fabrication of Wood Vinegar, etc., etc. By Prof. H. DUSSAUCE. 8vo. . . . \$5 00

DUSSAUCE.—Practical Treatise on the Fabrication of Matches, Gun Cotton, and Fulminating Powder.

By Professor H. DUSSAUCE. 12mo. . . . \$3 00

DYER AND COLOR-MAKER'S COMPANION:

Containing upwards of two hundred Receipts for making Colors, on the most approved principles, for all the various styles and fabrics now in existence; with the Scouring Process, and plain Directions for Preparing, Washing-off, and Finishing the Goods. 12mo. \$1 25

EDWARDS.—A Catechism of the Marine Steam-Engine,

For the use of Engineers, Firemen, and Mechanics. A Practical Work for Practical Men. By EMORY EDWARDS, Mechanical Engineer. Illustrated by sixty-three Engravings, including examples of the most modern Engines. Third edition, thoroughly revised, with much additional matter. 12mo. 414 pages . . . \$2 00

EDWARDS.—Modern American Locomotive Engines,

Their Design, Construction and Management. By EMORY EDWARDS. Illustrated 12mo. . . . \$2 00

EDWARDS.—Modern American Marine Engines, Boilers, and Screw Propellers,

Their Design and Construction. Showing the Present Practice of the most Eminent Engineers and Marine Engine Builders in the United States. Illustrated by 30 large and elaborate plates. 4to. \$5.00

EDWARDS.—The Practical Steam Engineer's Guide

In the Design, Construction, and Management of American Stationary, Portable, and Steam Fire-Engines, Steam Pumps, Boilers, Injectors, Governors, Indicators, Pistons and Rings, Safety Valves and Steam Gauges. For the use of Engineers, Firemen, and Steam Users. By EMORY EDWARDS. Illustrated by 119 engravings. 420 pages. 12mo. \$2 50

ELDER.—Conversations on the Principal Subjects of Political Economy.

By Dr. WILLIAM ELDER. 8vo. \$2 50

ELDER.—Questions of the Day,

Economic and Social. By Dr. WILLIAM ELDER. 8vo. . . \$3 00

ELDER.—Memoir of Henry C. Carey.

By Dr. WILLIAM ELDER. 8vo. cloth. 75

ERNI.—Mineralogy Simplified.

Easy Methods of Determining and Classifying Minerals, including Ores, by means of the Blow-pipe, and by Humid Chemical Analysis, based on Professor von Kobell's Tables for the Determination of Minerals, with an Introduction to Modern Chemistry. By HENRY ERNI, A.M., M.D., Professor of Chemistry. Second Edition, rewritten, enlarged and improved. 12mo. \$3 00

FAIRBAIRN.—The Principles of Mechanism and Machinery of Transmission.

Comprising the Principles of Mechanism, Wheels, and Pulleys, Strength and Proportions of Shafts, Coupling of Shafts, and Engaging and Disengaging Gear. By SIR WILLIAM FAIRBAIRN, Bart. C. E. Beautifully illustrated by over 150 wood-cuts. In one volume, 12mo. \$2.50

FITCH.—Bessemer Steel,

Ores and Methods, New Facts and Statistics Relating to the Types of Machinery in Use, the Methods in Vogue, Cost and Class of Labor employed, and the Character and Availability of the Ores utilized in the Manufacture of Bessemer Steel in Europe and in the United States; together with opinions and excerpts from various accepted authorities. Compiled and arranged by THOMAS W. FITCH. 8vo. . . \$3 00

FLEMING.—Narrow Gauge Railways in America.

A Sketch of their Rise, Progress, and Success. Valuable Statistics as to Grades, Curves, Weight of Rail, Locomotives, Cars, etc. By HOWARD FLEMING. Illustrated, 8vo. \$1 50

FORSYTH.—Book of Designs for Headstones, Mural, and other Monuments:

Containing 78 Designs. By JAMES FORSYTH. With an Introduction by CHARLES BOUTELL, M. A. 4 to., cloth \$5 00

FRANKEL—HUTTER.—A Practical Treatise on the Manufacture of Starch, Glucose, Starch-Sugar, and Dextrine :

Based on the German of LADISLAUS VON WAGNER, Professor in the Royal Technical High School, Buda-Pest, Hungary, and other authorities. By JULIUS FRANKEL, Graduate of the Polytechnic School of Hanover. Edited by ROBERT HUTTER, Chemist, Practical Manufacturer of Starch-Sugar. Illustrated by 58 engravings, covering every branch of the subject, including examples of the most Recent and Best American Machinery. 8vo., 344 pp. . \$3.50

GEE.—The Goldsmith's Handbook :

Containing full instructions for the Alloying and Working of Gold, including the Art of Alloying, Melting, Reducing, Coloring, Collecting, and Refining; the Processes of Manipulation, Recovery of Waste; Chemical and Physical Properties of Gold; with a New System of Mixing its Alloys; Solders, Enamels, and other Useful Rules and Recipes. By GEORGE E. GEE. 12mo. . \$1.75

GEE.—The Silversmith's Handbook :

Containing full instructions for the Alloying and Working of Silver, including the different modes of Refining and Melting the Metal; its Solders; the Preparation of Imitation Alloys; Methods of Manipulation; Prevention of Waste; Instructions for Improving and Finishing the Surface of the Work; together with other Useful Information and Memoranda. By GEORGE E. GEE, Jeweller. Illustrated. 12mo.

\$1.75

GOTHIC ALBUM FOR CABINET-MAKERS :

Designs for Gothic Furniture. Twenty-three plates. Oblong \$2.00

GREENWOOD.—Steel and Iron :

Comprising the Practice and Theory of the Several Methods Pursued in their Manufacture, and of their Treatment in the Rolling-Mills, the Forge, and the Foundry. By WILLIAM HENRY GREENWOOD, F. C. S. Asso. M. I. C. E., M. I. M. E., Associate of the Royal School of Mines. With 97 Diagrams, 536 pages. 12mo. . \$2.00

GREGORY.—Mathematics for Practical Men :

Adapted to the Pursuits of Surveyors, Architects, Mechanics, and Civil Engineers. By OLINTHUS GREGORY. 8vo., plates . \$3.00

GRIER.—Rural Hydraulics :

A Practical Treatise on Rural Household Water Supply. Giving a full description of Springs and Wells, of Pumps and Hydraulic Ram, with Instructions in Cistern Building, Laying of Pipes, etc. By W. W. GRIER. Illustrated 8vo. 75

GRIMSHAW.—Modern Milling :

Being the substance of two addresses delivered by request, at the Franklin Institute, Philadelphia, January 19th and January 27th, 1881. By ROBERT GRIMSHAW, Ph. D. Edited from the Phonographic Reports. With 28 Illustrations. 8vo. . . \$1.00

GRIMSHAW.—Saws :

The History, Development, Action, Classification, and Comparison of Saws of all kinds. *With Copious Appendices.* Giving the details

of Manufacture, Filing, Setting, Gumming, etc. Care and Use of Saws; Tables of Gauges; Capacities of Saw-Mills; List of Saw-Patents, and other valuable information. By ROBERT GRIMSHAW. Second and greatly enlarged edition, *with Supplement*, and 354 Illustrations. Quarto \$4.00

GRIMSHAW.—A Supplement to Grimshaw on Saws:

Containing additional practical matter, more especially relating to the Forms of Saw-Teeth, for special material and conditions, and to the Behavior of Saws under particular conditions. 120 Illustrations. By ROBERT GRIMSHAW. Quarto \$2.00

GRISWOLD.—Railroad Engineer's Pocket Companion for the Field:

Comprising Rules for Calculating Deflection Distances and Angles, Tangential Distances and Angles, and all Necessary Tables for Engineers; also the Art of Levelling from Preliminary Survey to the Construction of Railroads, intended Expressly for the Young Engineer, together with Numerous Valuable Rules and Examples. By W. GRISWOLD. 12mo., tucks \$1.75

GRUNER.—Studies of Blast Furnace Phenomena:

By M. L. GRUNER, President of the General Council of Mines of France, and lately Professor of Metallurgy at the Ecole des Mines. Translated, with the author's sanction, with an Appendix, by L. D. B. GORDON, F. R. S. E., F. G. S. 8vo. \$2.50

GUETTIER.—Metallic Alloys:

Being a Practical Guide to their Chemical and Physical Properties, their Preparation, Composition, and Uses. Translated from the French of A. GUETTIER, Engineer and Director of Foundries, author of "La Fonderie en France," etc., etc. By A. A. FESQUET, Chemist and Engineer. 12mo. \$3.00

HASERICK.—The Secrets of the Art of Dyeing Wool, Cotton, and Linen,

Including Bleaching and Coloring Wool and Cotton Hosiery and Random Yarns. A Treatise based on Economy and Practice. By E. C. HASERICK. *Illustrated by 323 Dyed Patterns of the Yarns or Fabrics.* 8vo. \$25.00

HATS AND FELTING:

A Practical Treatise on their Manufacture. By a Practical Hatter. Illustrated by Drawings of Machinery, etc. 8vo. \$1.25

HENRY.—The Early and Later History of Petroleum:

With Authentic Facts in regard to its Development in Western Pennsylvania. With Sketches of the Pioneer and Prominent Operators, together with the Refining Capacity of the United States. By J. T. HENRY. Illustrated 8vo.

HOFFER.—A Practical Treatise on Caoutchouc and Gutta Percha,

Comprising the Properties of the Raw Materials, and the manner of Mixing and Working them; with the Fabrication of Vulcanized and Hard Rubbers, Caoutchouc and Gutta Percha Compositions, Water-

proof Substances, Elastic Tissues, the Utilization of Waste, etc., etc. From the German of RAIMUND HOFFER. By W. T. ERANNT. Illustrated 12mo. \$2.50

HOFMANN.—A Practical Treatise on the Manufacture of Paper in all its Branches :

By CARL HOFMANN, Late Superintendent of Paper-Mills in Germany and the United States; recently Manager of the "Public Ledger" Paper-Mills, near Elkton, Maryland. Illustrated by 110 wood engravings, and five large Folding Plates. 4to., cloth; about 400 pages \$35.00

HUGHES.—American Miller and Millwright's Assistant :

By WILLIAM CARTER HUGHES. 12mo. \$1.50

HULME.—Worked Examination Questions in Plane Geometrical Drawing :

For the Use of Candidates for the Royal Military Academy, Woolwich; the Royal Military College, Sandhurst; the Indian Civil Engineering College, Cooper's Hill; Indian Public Works and Telegraph Departments; Royal Marine Light Infantry; the Oxford and Cambridge Local Examinations, etc. By F. EDWARD HULME, F. L. S., F. S. A., Art-Master Marlborough College. Illustrated by 300 examples. Small quarto \$3.75

JERVIS.—Railroad Property :

A Treatise on the Construction and Management of Railways; designed to afford useful knowledge, in the popular style, to the holders of this class of property; as well as Railway Managers, Officers, and Agents. By JOHN B. JERVIS, late Civil Engineer of the Hudson River Railroad, Croton Aqueduct, etc. 12mo., cloth \$2.00

KEENE.—A Hand-Book of Practical Gauging :

For the Use of Beginners, to which is added a Chapter on Distillation, describing the process in operation at the Custom-House for ascertaining the Strength of Wines. By JAMES B. KEENE, of H. M. Customs. 8vo. \$1.25

KELLEY.—Speeches, Addresses, and Letters on Industrial and Financial Questions :

By HON. WILLIAM D. KELLEY, M. C. 544 pages, 8vo. \$3.00

KELLOGG.—A New Monetary System :

The only means of Securing the respective Rights of Labor and Property, and of Protecting the Public from Financial Revulsions. By EDWARD KELLOGG. Revised from his work on "Labor and other Capital." With numerous additions from his manuscript. Edited by MARY KELLOGG PUTNAM. Fifth edition. To which is added a Biographical Sketch of the Author. One volume, 12mo. Paper cover \$1.00
Bound in cloth 1.50

KEMLO.—Watch-Repairer's Hand-Book :

Being a Complete Guide to the Young Beginner, in Taking Apart, Putting Together, and Thoroughly Cleaning the English Lever and other Foreign Watches, and all American Watches. By F. KEMLO, Practical Watchmaker. With Illustrations. 12mo. \$1.25

KENTISH.—A Treatise on a Box of Instruments,

And the Slide Rule; with the Theory of Trigonometry and Logarithms, including Practical Geometry, Surveying, Measuring of Timber, Cask and Malt Gauging, Heights, and Distances. By THOMAS KENTISH. In one volume. 12mo. \$1.25

KERL.—The Assayer's Manual:

An Abridged Treatise on the Docimastic Examination of Ores, and Furnace and other Artificial Products. By BRUNO KERL, Professor in the Royal School of Mines; Member of the Royal Technical Commission for the Industries, and of the Imperial Patent-Office, Berlin. Translated from the German by WILLIAM T. BRANNT, Graduate of the Royal Agricultural College of Eldena, Prussia. Edited by WILLIAM H. WAHL, Ph. D., Secretary of the Franklin Institute, Philadelphia. Illustrated by sixty-five engravings. 8vo. \$3.00

KINGZETT.—The History, Products, and Processes of the Alkali Trade:

Including the most Recent Improvements. By CHARLES THOMAS KINGZETT, Consulting Chemist. With 23 illustrations. 8vo. \$2.50

KINSLEY.—Self-Instructor on Lumber Surveying:

For the Use of Lumber Manufacturers, Surveyors, and Teachers. By CHARLES KINSLEY, Practical Surveyor and Teacher of Surveying. 12mo. \$2.00

KIRK.—The Founding of Metals:

A Practical Treatise on the Melting of Iron, with a Description of the Founding of Alloys; also, of all the Metals and Mineral Substances used in the Art of Founding. Collected from original sources. By EDWARD KIRK, Practical Foundryman and Chemist. Illustrated. Third edition. 8vo. \$2.50

KITTREDGE.—The Compendium of Architectural Sheet-Metal Work:

Profusely Illustrated. Embracing Rules and Directions for Estimates, Items of Cost, Nomenclature, Tables of Brackets, Modillions, Dentals, Trusses, Stop-Blocks, Frieze Pieces, etc. Architect's Specification, Tables of Tin-Roofing, Galvanized Iron, etc., etc. To which is added the Exemplar of Architectural Sheet-Metal Work, containing details of the Centennial Buildings, and other important Sheet-Metal Work, Designs and Prices of Architectural Ornaments, as manufactured for the Trade by the Kittredge Cornice and Ornament Company, and a Catalogue of Cornices, Window-Caps, Mouldings, etc., as manufactured by the Kittredge Cornice and Ornament Company. The whole supplemented by a full Index and Table of Contents. By A. O. KITTREDGE. 8vo., 565 pages

LANDRIN.—A Treatise on Steel:

Comprising its Theory, Metallurgy, Properties, Practical Working, and Use. By M. H. C. LANDRIN, JR., Civil Engineer. Translated from the French, with Notes, by A. A. FESQUET, Chemist and Engineer. With an Appendix on the Bessemer and the Martin Processes for Manufacturing Steel, from the Report of Abram S. Hewitt

LARKIN.—The Practical Brass and Iron Founder's Guide:

A Concise Treatise on Brass Founding, Moulding, the Metals and their Alloys, etc.; to which are added Recent Improvements in the Manufacture of Iron, Steel by the Bessemer Process, etc., etc. By JAMES LARKIN, late Conductor of the Brass Foundry Department in Reany, Neafie & Co.'s Penn Works, Philadelphia. Fifth edition, revised, with extensive additions. 12mo. . . . \$2.25

LEROUX.—A Practical Treatise on the Manufacture of Worsted, and Carded Yarns:

Comprising Practical Mechanics, with Rules and Calculations applied to Spinning; Sorting, Cleaning, and Scouring Wools; the English and French Methods of Combing, Drawing, and Spinning Worsted, and Manufacturing Carded Yarns. Translated from the French of CHARLES LEROUX, Mechanical Engineer and Superintendent of a Spinning-Mill, by HORATIO PAINE, M. D., and A. A. FESQUET, Chemist and Engineer. Illustrated by twelve large Plates. To which is added an Appendix, containing Extracts from the Reports of the International Jury, and of the Artisans selected by the Committee appointed by the Council of the Society of Arts, London, on Woolen and Worsted Machinery and Fabrics, as exhibited in the Paris Universal Exposition, 1867. 8vo. . . . \$5.00

LEFFEL.—The Construction of Mill-Dams:

Comprising also the Building of Race and Reservoir Embankments and Head-Gates, the Measurement of Streams, Gauging of Water Supply, etc. By JAMES LEFFEL & CO. Illustrated by 58 engravings. 8vo. . . . \$2.50

LESLIE.—Complete Cookery:

Directions for Cookery in its Various Branches. By MISS LESLIE. Sixtieth thousand. Thoroughly revised, with the addition of New Receipts. In 12mo., cloth \$1.50

LIEBER.—Assayer's Guide:

Or, Practical Directions to Assayers, Miners, and Smelters, for the Tests and Assays, by Heat and by Wet Processes, for the Ores of all the principal Metals, of Gold and Silver Coins and Alloys, and of Coal, etc. By OSCAR M. LIEBER. 12mo. . . . \$1.25

Lockwood's Dictionary of Terms:

Used in the Practice of Mechanical Engineering, embracing those Current in the Drawing Office, Pattern Shop, Foundry, Fitting, Turning, Smith's and Boiler Shops, etc., etc., comprising upwards of Six Thousand Definitions. Edited by a Foreman Pattern Maker, author of "Pattern Making." 417 pp. 12mo. . . . \$3.00

LOVE.—The Art of Dyeing, Cleaning, Scouring, and Finishing, on the Most Approved English and French Methods:

Being Practical Instructions in Dyeing Silks, Woolens, and Cottons, Feathers, Chips, Straw, etc. Scouring and Cleaning Bed and Window Curtains, Carpets, Rugs, etc. French and English Cleaning, any Color or Fabric of Silk, Satin, or Damask. By THOMAS LOVE, a Working Dyer and Scourer. Second American Edition, to which

- are added General Instructions for the use of Aniline Colors. 8vo. 8vo.
343 pages \$5.00
- LUKIN.—Amongst Machines:**
Embracing Descriptions of the various Mechanical Appliances used
in the Manufacture of Wood, Metal, and other Substances. 12mo. \$1.75
- LUKIN.—The Boy Engineers:**
What They Did, and How They Did It. With 30 plates. 18mo. \$1.75
- LUKIN.—The Young Mechanic:**
Practical Carpentry. Containing Directions for the Use of all kinds
of Tools, and for Construction of Steam-Engines and Mechanical
Models, including the Art of Turning in Wood and Metal. By JOHN
LUKIN, Author of "The Lathe and Its Uses," etc. Illustrated.
12mo. \$1.75
- MAIN and BROWN.—Questions on Subjects Connected with
the Marine Steam-Engine:**
And Examination Papers; with Hints for their Solution. By
THOMAS J. MAIN, Professor of Mathematics, Royal Naval College,
and THOMAS BROWN, Chief Engineer, R. N. 12mo., cloth . \$1.50
- MAIN and BROWN.—The Indicator and Dynamometer:**
With their Practical Applications to the Steam-Engine. By THOMAS
J. MAIN, M. A. F. R., Ass't S. Professor Royal Naval College,
Portsmouth, and THOMAS BROWN, Assoc. Inst. C. E., Chief Engineer
R. N., attached to the R. N. College. Illustrated. 8vo. . \$1.50
- MAIN and BROWN.—The Marine Steam-Engine.**
By THOMAS J. MAIN, F. R. Ass't S. Mathematical Professor at the
Royal Naval College, Portsmouth, and THOMAS BROWN, Assoc.
Inst. C. E., Chief Engineer R. N. Attached to the Royal Naval
College. With numerous illustrations. 8vo. \$5.00
- MARTIN.—Screw-Cutting Tables, for the Use of Mechanical
Engineers:**
Showing the Proper Arrangement of Wheels for Cutting the Threads
of Screws of any Required Pitch; with a Table for Making the Uni-
versal Gas-Pipe Thread and Taps. By W. A. MARTIN, Engineer.
8vo. 50
- MICHELL.—Mine Drainage:**
Being a Complete and Practical Treatise on Direct-Acting Under-
ground Steam Pumping Machinery. With a Description of a large
number of the best known Engines, their General Utility and the
Special Sphere of their Action, the Mode of their Application, and
their Merits compared with other Pumping Machinery. By STEPHEN
MICHELL. Illustrated by 137 engravings. 8vo., 277 pages . \$6.00
- MOLESWORTH.—Pocket-Book of Useful Formulæ and
Memoranda for Civil and Mechanical Engineers.**
By GUILFORD L. MOLESWORTH, Member of the Institution of Civil
Engineers, Chief Resident Engineer of the Ceylon Railway. Full-
bound in Pocket-book form \$1.00

MOORE.—The Universal Assistant and the Complete Mechanic:

Containing over one million Industrial Facts, Calculations, Receipts, Processes, Trades Secrets, Rules, Business Forms, Legal Items, Etc., in every occupation, from the Household to the Manufactory. By R. MOORE. Illustrated by 500 Engravings. 12mo. . . . \$2.50

MORRIS.—Easy Rules for the Measurement of Earthworks:

By means of the Prismoidal Formula. Illustrated with Numerous Wood-Cuts, Problems, and Examples, and concluded by an Extensive Table for finding the Solidity in cubic yards from Mean Areas. The whole being adapted for convenient use by Engineers, Surveyors, Contractors, and others needing Correct Measurements of Earthwork. By ELWOOD MORRIS, C. E. 8vo. . . . \$1.50

MORTON.—The System of Calculating Diameter, Circumference, Area, and Squaring the Circle:

Together with Interest and Miscellaneous Tables, and other information. By JAMES MORTON. Second Edition, enlarged, with the Metric System. 12mo. . . . \$1.00

NAPIER.—Manual of Electro-Metallurgy:

Including the Application of the Art to Manufacturing Processes. By JAMES NAPIER. Fourth American, from the Fourth London edition, revised and enlarged. Illustrated by engravings. 8vo. \$1.50

NAPIER.—A System of Chemistry Applied to Dyeing.

By JAMES NAPIER, F. C. S. A New and Thoroughly Revised Edition. Completely brought up to the present state of the Science, including the Chemistry of Coal Tar Colors, by A. A. FESQUET, Chemist and Engineer. With an Appendix on Dyeing and Calico Printing, as shown at the Universal Exposition, Paris, 1867. Illustrated. 8vo. 422 pages \$5.00

NEVILLE.—Hydraulic Tables, Coefficients, and Formulæ, for finding the Discharge of Water from Orifices, Notches, Weirs, Pipes, and Rivers:

Third Edition, with Additions, consisting of New Formulæ for the Discharge from Tidal and Flood Sluices and Siphons; general information on Rainfall, Catchment-Basins, Drainage, Sewerage, Water Supply for Towns and Mill Power. By JOHN NEVILLE, C. E. M. R. I. A.; Fellow of the Royal Geological Society of Ireland. Thick 12mo. . . . \$5.50

NEWBERY.—Gleanings from Ornamental Art of every style:

Drawn from Examples in the British, South Kensington, Indian, Crystal Palace, and other Museums, the Exhibitions of 1851 and 1862, and the best English and Foreign works. In a series of 100 exquisitely drawn Plates, containing many hundred examples. By ROBERT NEWBERY. 4to. . . . \$12.50

NICHOLLS.—The Theoretical and Practical Boiler-Maker and Engineer's Reference Book:

Containing a variety of Useful Information for Employers of Labor. Foremen and Working Boiler-Makers, Iron, Copper, and Tinsmiths.

Draughtsmen, Engineers, the General Steam-using Public, and for the Use of Science Schools and Classes. By SAMUEL NICHOLLS. Illustrated by sixteen plates, 12mo. \$2.50

NICHOLSON.—A Manual of the Art of Bookbinding:

Containing full instructions in the different Branches of Forwarding, Gilding, and Finishing. Also, the Art of Marbling Book-edges and Paper. By JAMES B. NICHOLSON. Illustrated. 12mo., cloth \$2.25

NICOLLS.—The Railway Builder:

A Hand-Book for Estimating the Probable Cost of American Railway Construction and Equipment. By WILLIAM J. NICOLLS, Civil Engineer. Illustrated, full bound, pocket-book form \$2.00

NORMANDY.—The Commercial Handbook of Chemical Analysis:

Or Practical Instructions for the Determination of the Intrinsic or Commercial Value of Substances used in Manufactures, in Trades, and in the Arts. By A. NORMANDY. New Edition, Enlarged, and to a great extent rewritten. By HENRY M. NOAD, Ph.D., F.R.S., thick 12mo. \$5.00

NORRIS.—A Handbook for Locomotive Engineers and Machinists:

Comprising the Proportions and Calculations for Constructing Locomotives; Manner of Setting Valves; Tables of Squares, Cubes, Areas, etc., etc. By SEPTIMUS NORRIS, M. E. New edition. Illustrated, 12mo. \$1.50

NYSTROM.—A New Treatise on Elements of Mechanics:

Establishing Strict Precision in the Meaning of Dynamical Terms; accompanied with an Appendix on Duodenal Arithmetic and Metrology. By JOHN W. NYSTROM, C. E. Illustrated. 8vo. \$2.00

NYSTROM.—On Technological Education and the Construction of Ships and Screw Propellers:

For Naval and Marine Engineers. By JOHN W. NYSTROM, late Acting Chief Engineer, U. S. N. Second edition, revised, with additional matter. Illustrated by seven engravings. 12mo. \$1.50

O'NEILL.—A Dictionary of Dyeing and Calico Printing:

Containing a brief account of all the Substances and Processes in use in the Art of Dyeing and Printing Textile Fabrics; with Practical Receipts and Scientific Information. By CHARLES O'NEILL, Analytical Chemist. To which is added an Essay on Coal Tar Colors and their application to Dyeing and Calico Printing. By A. A. FESQUET, Chemist and Engineer. With an appendix on Dyeing and Calico Printing, as shown at the Universal Exposition, Paris, 1867. 8vo., 491 pages \$5.00

ORTON.—Underground Treasures:

How and Where to Find Them. A Key for the Ready Determination of all the Useful Minerals within the United States. By JAMES ORTON, A.M., Late Professor of Natural History in Vassar College, N. Y.; Cor. Mem. of the Academy of Natural Sciences, Philadelphia, and of the Lyceum of Natural History, New York; author of the "Andes and the Amazon," etc. A New Edition, with Additions. Illustrated \$1.50

OSBORN.—The Metallurgy of Iron and Steel :

Theoretical and Practical in all its Branches; with special reference to American Materials and Processes. By H. S. OSBORN, LL. D., Professor of Mining and Metallurgy in Lafayette College, Easton, Pennsylvania. Illustrated by numerous large folding plates and wood-engravings. 8vo. \$25.00

OSBORN.—A Practical Manual of Minerals, Mines and Mining :

Comprising the Physical Properties, Geologic Positions, Local Occurrence and Associations of the Useful Minerals; their Methods of Chemical Analysis and Assay: together with Various Systems of Excavating and Timbering, Brick and Masonry Work, during Drilling, Lining, Bracing and other Operations, etc. By Prof. H. S. OSBORN, LL. D., Author of the "Metallurgy of Iron and Steel." Illustrated by 171 engravings from original drawings. 8vo. \$4.50

OVERMAN.—The Manufacture of Steel :

Containing the Practice and Principles of Working and Making Steel. A Handbook for Blacksmiths and Workers in Steel and Iron, Wagon Makers, Die Sinkers, Cutlers, and Manufacturers of Files and Hardware, of Steel and Iron, and for Men of Science and Art. By FREDERICK OVERMAN, Mining Engineer, Author of the "Manufacture of Iron," etc. A new, enlarged, and revised Edition. By A. A. FESQUET, Chemist and Engineer. 12mo. \$1.50

OVERMAN.—The Moulder's and Founder's Pocket Guide :

A Treatise on Moulding and Founding in Green-sand, Dry-sand, Loam, and Cement; the Moulding of Machine Frames, Mill-gear, Hollowware, Ornaments, Trinkets, Bells, and Statues; Description of Moulds for Iron, Bronze, Brass, and other Metals; Plaster of Paris, Sulphur, Wax, etc.; the Construction of Melting Furnaces, the Melting and Founding of Metals; the Composition of Alloys and their Nature, etc., etc. By FREDERICK OVERMAN, M. E. A new Edition, to which is added a Supplement on Statuary and Ornamental Moulding, Ordnance, Malleable Iron Castings, etc. By A. A. FESQUET, Chemist and Engineer. Illustrated by 44 engravings. 12mo. \$2.00

PAINTER, GILDER, AND VARNISHER'S COMPANION :

Containing Rules and Regulations in everything relating to the Arts of Painting, Gilding, Varnishing, Glass-Staining, Graining, Marbling, Sign-Writing, Gilding on Glass, and Coach Painting and Varnishing; Tests for the Detection of Adulterations in Oils, Colors, etc.; and a Statement of the Diseases to which Painters are peculiarly liable, with the Simplest and Best Remedies. Sixteenth Edition. Revised, with an Appendix. Containing Colors and Coloring—Theoretical and Practical. Comprising descriptions of a great variety of Additional Pigments, their Qualities and Uses, to which are added, Dryers, and Modes and Operations of Painting, etc. Together with Chevreul's Principles of Harmony and Contrast of Colors. 12mo. Cloth \$1.50

PALLET.—The Miller's, Millwright's, and Engineer's Guide.

By HENRY PALLET. Illustrated. 12mo. \$2.00

PERCY.—The Manufacture of Russian Sheet-Iron.

By JOHN PERCY, M. D., F. R. S., Lecturer on Metallurgy at the Royal School of Mines, and to The Advance Class of Artillery Officers at the Royal Artillery Institution, Woolwich; Author of "Metallurgy." With Illustrations. 8vo., paper . . . 50 cts.

PERKINS.—Gas and Ventilation :

Practical Treatise on Gas and Ventilation. With Special Relation to Illuminating, Heating, and Cooking by Gas. Including Scientific Helps to Engineer-students and others. With Illustrated Diagrams.

By E. E. PERKINS. 12mo., cloth . . . \$1.25

PERKINS AND STOWE.—A New Guide to the Sheet-iron and Boiler Plate Roller :

Containing a Series of Tables showing the Weight of Slabs and Piles to Produce Boiler Plates, and of the Weight of Piles and the Sizes of Bars to produce Sheet-iron; the Thickness of the Bar Gauge in decimals; the Weight per foot, and the Thickness on the Bar or Wire Gauge of the fractional parts of an inch; the Weight per sheet, and the Thickness on the Wire Gauge of Sheet-iron of various dimensions to weigh 112 lbs. per bundle; and the conversion of Short Weight into Long Weight, and Long Weight into Short. Estimated and collected by G. H. PERKINS and J. G. STOWE. \$2.50

POWELL—CHANCE—HARRIS.—The Principles of Glass Making.

By HARRY J. POWELL, B. A. Together with Treatises on Crown and Sheet Glass; by HENRY CHANCE, M. A. And Plate Glass, by H. G. HARRIS, Asso. M. Inst. C. E. Illustrated 18mo. . . \$1.50

PROCTOR.—A Pocket-Book of Useful Tables and Formulæ for Marine Engineers :

By FRANK PROCTOR. Second Edition, Revised and Enlarged. Full-bound pocket-book form . . . \$1.50

REGNAULT.—Elements of Chemistry :

By M. V. REGNAULT. Translated from the French by T. FORREST BETTON, M. D., and edited, with Notes, by JAMES C. BOOTH, Melter and Refiner U. S. Mint, and WILLIAM L. FABER, Metallurgist and Mining Engineer. Illustrated by nearly 700 wood-engravings. Comprising nearly 1,500 pages. In two volumes, 8vo., cloth . . . \$7.50

RICHARDS.—Aluminium :

Its History, Occurrence, Properties, Metallurgy and Applications, including its Alloys. By JOSEPH W. RICHARDS, A. C., Chemist and Practical Metallurgist, Member of the Deutsche Chemische Gesellschaft. Illustrated by 16 engravings. 12 mo. 346 pages \$2.50

RIFFAULT, VERGNAUD, and TOUSSAINT.—A Practical Treatise on the Manufacture of Colors for Painting :

Comprising the Origin, Definition, and Classification of Colors; the Treatment of the Raw Materials; the best Formulæ and the Newest Processes for the Preparation of every description of Pigment, and the Necessary Apparatus and Directions for its Use; Dryers; the Testing, Application, and Qualities of Paints, etc., etc. By MM. RIFFAULT, VERGNAUD, and TOUSSAINT. Revised and Edited by M.

- F. MALEPEYRE.** Translated from the French, by A. A. FESQUET, Chemist and Engineer. Illustrated by Eighty engravings. In one vol., 8vo., 659 pages \$7.50
- ROPER.—A Catechism of High-Pressure, or Non-Condensing Steam-Engines :**
Including the Modelling, Constructing, and Management of Steam-Engines and Steam Boilers. With valuable illustrations. By STEPHEN ROPER, Engineer. Sixteenth edition, revised and enlarged. 18mo., tucks, gilt edge \$2.00
- ROPER.—Engineer's Handy-Book :**
Containing a full Explanation of the Steam-Engine Indicator, and its Use and Advantages to Engineers and Steam Users. With Formulæ for Estimating the Power of all Classes of Steam-Engines; also, Facts, Figures, Questions, and Tables for Engineers who wish to qualify themselves for the United States Navy, the Revenue Service, the Mercantile Marine, or to take charge of the Better Class of Stationary Steam-Engines. Sixth edition. 16mo., 690 pages, tucks, gilt edge \$3.50
- ROPER.—Hand-Book of Land and Marine Engines :**
Including the Modelling, Construction, Running, and Management of Land and Marine Engines and Boilers. With illustrations. By STEPHEN ROPER, Engineer. Sixth edition. 12mo., tucks, gilt edge. \$3.50
- ROPER.—Hand-Book of the Locomotive :**
Including the Construction of Engines and Boilers, and the Construction, Management, and Running of Locomotives. By STEPHEN ROPER. Eleventh edition. 18mo., tucks, gilt edge \$2.50
- ROPER.—Hand-Book of Modern Steam Fire-Engines.**
With illustrations. By STEPHEN ROPER, Engineer. Fourth edition, 12mo., tucks, gilt edge \$3.50
- ROPER.—Questions and Answers for Engineers.**
This little book contains all the Questions that Engineers will be asked when undergoing an Examination for the purpose of procuring Licenses, and they are so plain that any Engineer or Fireman of ordinary intelligence may commit them to memory in a short time. By STEPHEN ROPER, Engineer. Third edition \$3.00
- ROPER.—Use and Abuse of the Steam Boiler.**
By STEPHEN ROPER, Engineer. Eighth edition, with illustrations. 18mo., tucks, gilt edge \$2.00
- ROSE.—The Complete Practical Machinist :**
Embracing Lathe Work, Vise Work, Drills and Drilling, Taps and Dies, Hardening and Tempering, the Making and Use of Tools, Tool Grinding, Marking out Work, etc. By JOSHUA ROSE. Illustrated by 356 engravings. Thirteenth edition, thoroughly revised and in great part rewritten. In one vol., 12mo., 439 pages \$2.50
- ROSE.—Mechanical Drawing Self-Taught :**
Comprising Instructions in the Selection and Preparation of Drawing Instruments, Elementary Instruction in Practical Mechanical Draw-

- ing, together with Examples in Simple Geometry and Elementary Mechanism, including Screw Threads, Gear Wheels, Mechanical Motions, Engines and Boilers. By JOSHUA ROSE, M. E. Illustrated by 330 engravings. 8vo, 313 pages \$4.00
- ROSE.—The Slide-Valve Practically Explained:**
Embracing simple and complete Practical Demonstrations of the operation of each element in a Slide-valve Movement, and illustrating the effects of Variations in their Proportions by examples carefully selected from the most recent and successful practice. By JOSHUA ROSE, M. E. Illustrated by 35 engravings \$1.00
- ROSS.—The Blowpipe in Chemistry, Mineralogy and Geology:**
Containing all Known Methods of Anhydrous Analysis, many Working Examples, and Instructions for Making Apparatus. By LIEUT.-COLONEL W. A. ROSS, R. A., F. G. S. With 120 Illustrations. 12mo. \$2.00
- SHAW.—Civil Architecture:**
Being a Complete Theoretical and Practical System of Building, containing the Fundamental Principles of the Art. By EDWARD SHAW, Architect. To which is added a Treatise on Gothic Architecture, etc. By THOMAS W. SILLOWAY and GEORGE M. HARDING, Architects. The whole illustrated by 102 quarto plates finely engraved on copper. Eleventh edition. 4to. \$10.00
- SHUNK.—A Practical Treatise on Railway Curves and Location, for Young Engineers.**
By W. F. SHUNK, C. E. 12mo. Full bound pocket-book form \$2.00
- SLATER.—The Manual of Colors and Dye Wares.**
By J. W. SLATER. 12mo. \$3.75
- SLOAN.—American Houses:**
A variety of Original Designs for Rural Buildings. Illustrated by 26 colored engravings, with descriptive references. By SAMUEL SLOAN, Architect. 8vo. \$1.50
- SLOAN.—Homestead Architecture:**
Containing Forty Designs for Villas, Cottages, and Farm-houses, with Essays on Style, Construction, Landscape Gardening, Furniture, etc., etc. Illustrated by upwards of 200 engravings. By SAMUEL SLOAN, Architect. 8vo. \$3.50
- SLOANE.—Home Experiments in Science.**
By T. O'CONNOR SLOANE, E. M., A. M., Ph. D. Illustrated by 91 engravings. 12mo. \$1.50
- SMEATON.—Builder's Pocket-Companion:**
Containing the Elements of Building, Surveying, and Architecture; with Practical Rules and Instructions connected with the subject. By A. C. SMEATON, Civil Engineer, etc. 12mo. \$1.50
- SMITH.—A Manual of Political Economy.**
By E. PESHINE SMITH. A New Edition, to which is added a full Index. 12mo. \$1.25

SMITH.—Parks and Pleasure-Grounds :

Or Practical Notes on Country Residences, Villas, Public Parks, and Gardens. By CHARLES H. J. SMITH, Landscape Gardener and Garden Architect, etc., etc. 12mo. \$2.00

SMITH.—The Dyer's Instructor :

Comprising Practical Instructions in the Art of Dyeing Silk, Cotton, Wool, and Worsted, and Woolen Goods; containing nearly 800 Receipts. To which is added a Treatise on the Art of Padding; and the Printing of Silk Warps, Skeins, and Handkerchiefs, and the various Mordants and Colors for the different styles of such work. By DAVID SMITH, Pattern Dyer. 12mo. \$3.00

SMYTH.—A Rudimentary Treatise on Coal and Coal-Mining.

By WARRINGTON W. SMYTH, M. A., F. R. G., President R. G. S. of Cornwall. Fifth edition, revised and corrected. With numerous illustrations. 12mo. \$1.75

SNIVELY.—A Treatise on the Manufacture of Perfumes and Kindred Toilet Articles.

By JOHN H. SNIVELY, Phr. D., Professor of Analytical Chemistry in the Tennessee College of Pharmacy. 8vo. \$3.00

SNIVELY.—Tables for Systematic Qualitative Chemical Analysis.

By JOHN H. SNIVELY, Phr. D. 8vo. \$1.00

SNIVELY.—The Elements of Systematic Qualitative Chemical Analysis :

A Hand-book for Beginners. By JOHN H. SNIVELY, Phr. D. 16mo. \$2.00

STEWART.—The American System :

Speeches on the Tariff Question, and on Internal Improvements, principally delivered in the House of Representatives of the United States. By ANDREW STEWART, late M. C. from Pennsylvania. With a Portrait, and a Biographical Sketch. 8vo. \$3.00

STOKES.—The Cabinet-Maker and Upholsterer's Companion :

Comprising the Art of Drawing, as applicable to Cabinet Work; Veneering, Inlaying, and Buhl-Work; the Art of Dyeing and Staining Wood, Ivory, Bone, Tortoise-Shell, etc. Directions for Lacking, Japanning, and Varnishing; to make French Polish, Glues, Cements, and Compositions; with numerous Receipts, useful to workmen generally. By J. STOKES. Illustrated. A New Edition, with an Appendix upon French Polishing, Staining, Imitating, Varnishing, etc., etc. 12mo. \$1.25

STRENGTH AND OTHER PROPERTIES OF METALS;

Reports of Experiments on the Strength and other Properties of Metals for Cannon. With a Description of the Machines for Testing Metals, and of the Classification of Cannon in service. By Officers of the Ordnance Department, U. S. Army. By authority of the Secretary of War. Illustrated by 25 large steel plates. Quarto . \$10.00

SULLIVAN.—Protection to Native Industry.

By Sir EDWARD SULLIVAN, Baronet, author of "Ten Chapters on Social Reforms." 8vo. \$1.50

- SYME.—Outlines of an Industrial Science.**
By DAVID SYME. 12mo. \$2.00
- TABLES SHOWING THE WEIGHT OF ROUND, SQUARE, AND FLAT BAR IRON, STEEL, ETC.,**
By Measurement. Cloth 63
- TAYLOR.—Statistics of Coal:**
Including Mineral Bituminous Substances employed in Arts and Manufactures; with their Geographical, Geological, and Commercial Distribution and Amount of Production and Consumption on the American Continent. With Incidental Statistics of the Iron Manufacture. By R. C. TAYLOR. Second edition, revised by S. S. HALDEMAN. Illustrated by five Maps and many wood engravings. 8vo., cloth \$10.00
- TEMPLETON.—The Practical Examiner on Steam and the Steam-Engine:**
With Instructive References relative thereto, arranged for the Use of Engineers, Students, and others. By WILLIAM TEMPLETON, Engineer. 12mo. \$1.25
- THAUSING.—The Theory and Practice of the Preparation of Malt and the Fabrication of Beer:**
With especial reference to the Vienna Process of Brewing. Elaborated from personal experience by JULIUS E. THAUSING, Professor at the School for Brewers, and at the Agricultural Institute, Mödling, near Vienna. Translated from the German by WILLIAM T. BRANNT, Thoroughly and elaborately edited, with much American matter, and according to the latest and most Scientific Practice, by A. SCHWARZ and DR. A. H. BAUER. Illustrated by 140 Engravings. 8vo., 815 pages \$10.00
- THOMAS.—The Modern Practice of Photography:**
By R. W. THOMAS, F. C. S. 8vo. 75
- THOMPSON.—Political Economy. With Especial Reference to the Industrial History of Nations:**
By ROBERT E. THOMPSON, M. A., Professor of Social Science in the University of Pennsylvania. 12mo. \$1.50
- THOMSON.—Freight Charges Calculator:**
By ANDREW THOMSON, Freight Agent. 24mo. \$1.25
- TURNER'S (THE) COMPANION:**
Containing Instructions in Concentric, Elliptic, and Eccentric Turning; also various Plates of Chucks, Tools, and Instruments; and Directions for using the Eccentric Cutter, Drill, Vertical Cutter, and Circular Rest; with Patterns and Instructions for working them. 12mo. \$1.25
- TURNING: Specimens of Fancy Turning Executed on the Hand or Foot-Lathe:**
With Geometric, Oval, and Eccentric Chucks, and Elliptical Cutting Frame. By an Amateur. Illustrated by 30 exquisite Photographs. 4to. \$3.00
- URBIN—BRULL.—A Practical Guide for Puddling Iron and Steel.**
By ED. URBIN, Engineer of Arts and Manufactures. A Prize Essay,

read before the Association of Engineers, Graduate of the School of Mines, of Liege, Belgium, at the Meeting of 1865-6. To which is added A COMPARISON OF THE RESISTING PROPERTIES OF IRON AND STEEL. By A. BRULL. Translated from the French by A. A. FESQUET, Chemist and Engineer. 8vo. \$1.00

VAILE.—Galvanized-Iron Cornice-Worker's Manual:

Containing Instructions in Laying out the Different Mitres, and Making Patterns for all kinds of Plain and Circular Work. Also, Tables of Weights, Areas and Circumferences of Circles, and other Matter calculated to Benefit the Trade. By CHARLES A. VAILE. Illustrated by twenty-one plates. 4to. \$5.00

VILLE.—On Artificial Manures:

Their Chemical Selection and Scientific Application to Agriculture. A series of Lectures given at the Experimental Farm at Vincennes, during 1867 and 1874-75. By M. GEORGES VILLE. Translated and Edited by WILLIAM CROOKES, F. R. S. Illustrated by thirty-one engravings. 8vo., 450 pages \$6.00

VILLE.—The School of Chemical Manures:

Or, Elementary Principles in the Use of Fertilizing Agents. From the French of M. GEO. VILLE, by A. A. FESQUET, Chemist and Engineer. With Illustrations. 12mo. \$1.25

VOGDEN.—The Architect's and Builder's Pocket-Companion and Price-Book:

Consisting of a Short but Comprehensive Epitome of Decimals, Duodecimals, Geometry and Mensuration; with Tables of United States Measures, Sizes, Weights, Strengths, etc., of Iron, Wood, Stone, Brick, Cement and Concretes, Quantities of Materials in given Sizes and Dimensions of Wood, Brick and Stone; and full and complete Bills of Prices for Carpenter's Work and Painting; also, Rules for Computing and Valuing Brick and Brick Work, Stone Work, Painting, Plastering, with a Vocabulary of Technical Terms, etc. By FRANK W. VOGDEN, Architect, Indianapolis, Ind. Enlarged, revised, and corrected. In one volume, 368 pages, full-bound, pocket-book form, gilt edges \$2.00
Cloth 1.50

WAHL.—Galvanoplastic Manipulations:

A Practical Guide for the Gold and Silver Electroplater and the Galvanoplastic Operator. Comprising the Electro-Deposition of all Metals by means of the Battery and the Dynamo-Electric Machine, as well as the most approved Processes of Deposition by Simple Immersion, with Descriptions of Apparatus, Chemical Products employed in the Art, etc. Based largely on the "Manipulations Hydroplastiques" of ALFRED ROSELEUR. By WILLIAM H. WAHL, Ph. D. (Heid), Secretary of the Franklin Institute. Illustrated by 189 engravings. 8vo., 656 pages \$7.50

WALTON.—Coal-Mining Described and Illustrated:

By THOMAS H. WALTON, Mining Engineer. Illustrated by 24 large and elaborate Plates, after Actual Workings and Apparatus. \$5.00

WARE.—The Sugar Beet.

Including a History of the Beet Sugar Industry in Europe, Varieties of the Sugar Beet, Examination, Soils, Tillage, Seeds and Sowing, Yield and Cost of Cultivation, Harvesting, Transportation, Conservation, Feeding Qualities of the Beet and of the Pulp, etc. By LEWIS S. WARE, C. E., M. E. Illustrated by ninety engravings. 8vo.

\$4.00

WARN.—The Sheet-Metal Worker's Instructor:

For Zinc, Sheet-Iron, Copper, and Tin-Plate Workers, etc. Containing a selection of Geometrical Problems; also, Practical and Simple Rules for Describing the various Patterns required in the different branches of the above Trades. By REUBEN H. WARN, Practical Tin-Plate Worker. To which is added an Appendix, containing Instructions for Boiler-Making, Mensuration of Surfaces and Solids, Rules for Calculating the Weights of different Figures of Iron and Steel, Tables of the Weights of Iron, Steel, etc. Illustrated by thirty-two Plates and thirty-seven Wood Engravings. 8vo.

\$3.00

WARNER.—New Theorems, Tables, and Diagrams, for the Computation of Earth-work:

Designed for the use of Engineers in Preliminary and Final Estimates, of Students in Engineering, and of Contractors and other non-professional Computers. In two parts, with an Appendix. Part I. A Practical Treatise; Part II. A Theoretical Treatise, and the Appendix. Containing Notes to the Rules and Examples of Part I.; Explanations of the Construction of Scales, Tables, and Diagrams, and a Treatise upon Equivalent Square Bases and Equivalent Level Heights. The whole illustrated by numerous original engravings, comprising explanatory cuts for Definitions and Problems, Stereometric Scales and Diagrams, and a series of Lithographic Drawings from Models. Showing all the Combinations of Solid Forms which occur in Railroad Excavations and Embankments. By JOHN WARNER, A. M., Mining and Mechanical Engineer. Illustrated by 14 Plates. A new, revised and improved edition. 8vo.

\$4.00

WATSON.—A Manual of the Hand-Lathe:

Comprising Concise Directions for Working Metals of all kinds, Ivory, Bone and Precious Woods; Dyeing, Coloring, and French Polishing; Inlaying by Veneers, and various methods practised to produce Elaborate work with Dispatch, and at Small Expense. By EGBERT P. WATSON, Author of "The Modern Practice of American Machinists and Engineers." Illustrated by 78 engravings.

\$1.50

WATSON.—The Modern Practice of American Machinists and Engineers:

Including the Construction, Application, and Use of Drills, Lathe Tools, Cutters for Boring Cylinders, and Hollow-work generally, with the most Economical Speed for the same; the Results verified by Actual Practice at the Lathe, the Vise, and on the Floor. Together

- with Workshop Management, Economy of Manufacture, the Steam Engine, Boilers, Gears, Belling, etc., etc. By **EGBERT P. WATSON**. Illustrated by eighty-six engravings. 12mo. \$2.50
- WATSON.**—The Theory and Practice of the Art of Weaving by Hand and Power :
With Calculations and Tables for the Use of those connected with the Trade. By **JOHN WATSON**, Manufacturer and Practical Machine-Maker. Illustrated by large Drawings of the best Power Looms. 8vo. \$7.50
- WATT.**—The Art of Soap Making :
A Practical Hand-book of the Manufacture of Hard and Soft Soaps, Toilet Soaps, etc., including many New Processes, and a Chapter on the Recovery of Glycerine from Waste Leys. By **ALEXANDER WATT**. Ill. 12mo. \$3.00
- WEATHERLY.**—Treatise on the Art of Boiling Sugar, Crystallizing, Lozenge-making, Comfits, Gun! Goods,
And other processes for Confectionery, etc., in which are explained, in an easy and familiar manner, the various Methods of Manufacturing every Description of Raw and Refined Sugar Goods, as sold by Confectioners and others. 12mo. \$1.50
- WIGHTWICK.**—Hints to Young Architects :
Comprising Advice to those who, while yet at school, are destined to the Profession; to such as, having passed their pupilage, are about to travel; and to those who, having completed their education, are about to practise. Together with a Model Specification involving a great variety of instructive and suggestive matter. By **GEORGE WIGHTWICK**, Architect. A new edition, revised and considerably enlarged; comprising Treatises on the Principles of Construction and Design. By **G. HUSKISSON GUILLAUME**, Architect. Numerous Illustrations. One vol. 12mo. \$2.00
- WILL.**—Tables of Qualitative Chemical Analysis.
With an Introductory Chapter on the Course of Analysis. By Professor **HEINRICH WILL**, of Giessen, Germany. Third American, from the eleventh German edition. Edited by **CHARLES F. HIMES**, Ph. D., Professor of Natural Science, Dickinson College, Carlisle, Pa. 8vo. \$1.50
- WILLIAMS.**—On Heat and Steam :
Embracing New Views of Vaporization, Condensation, and Explosion. By **CHARLES WYE WILLIAMS**, A. I. C. E. Illustrated 8vo. \$3 50
- WILSON.**—A Treatise on Steam Boilers :
Their Strength, Construction, and Economical Working. By **ROBERT WILSON**. Illustrated 12mo. \$2.50
- WILSON.**—First Principles of Political Economy :
With Reference to Statesmanship and the Progress of Civilization. By Professor **W. D. WILSON**, of the Cornell University. A new and revised edition. 12mo. \$1.50

WOHLER.—A Hand-Book of Mineral Analysis :

By F. WÖHLER, Professor of Chemistry in the University of Göttingen. Edited by HENRY B. NASON, Professor of Chemistry in the Rensselaer Polytechnic Institute, Troy, New York. Illustrated. 12mo. \$3.00

WORSSAM.—On Mechanical Saws :

From the Transactions of the Society of Engineers, 1869. By S. W. WORSSAM, JR. Illustrated by eighteen large plates. 8vo. \$2.50

RECENT ADDITIONS.
ANDERSON.—The Prospector's Hand-Book :

A Guide for the Prospector and Traveler in Search of Metal Bearing or other Valuable Minerals. By J. W. ANDERSON. 52 Illustrations. 12mo. \$1.50

BEAUMONT.—Woollen and Worsted Cloth Manufacture :

Being a Practical Treatise for the use of all persons employed in the manipulation of Textile Fabrics. By ROBERT BEAUMONT, M. S. A. With over 200 illustrations, including Sketches of Machinery, Designs, Cloths, etc. 391 pp. 12mo. \$2.50

BRANNT.—The Metallic Alloys :

A Practical Guide for the Manufacture of all kinds of Alloys, Amalgams and Solders used by Metal Workers, especially by Bell Founders, Bronze Workers, Tinsmiths, Gold and Silver Workers, Dentists, etc., etc., as well as their Chemical and Physical Properties. Edited chiefly from the German of A. Krupp and Andreas Wildberger, with additions by WM. T. BRANNT. Illustrated. 12mo. \$2.50

CROSS.—The Cotton Yarn Spinner :

Showing how the Preparation should be arranged for Different Counts of Yarns by a System more uniform than has hitherto been practiced; by having a Standard Schedule from which we make all our Changes. By RICHARD CROSS. 122 pp. 12mo. \$1.25

GRANT.—A Hand-Book on the Teeth of Gears :

Their Curves, Properties, and Practical Construction. By GEORGE B. GRANT. Illustrated. Second Edition, enlarged. 8vo. \$1.00

MAKINS.—A Manual of Metallurgy :

By GEORGE HOGARTH MAKINS, M. R. C. S., S. C. S. Illustrated by 100 engravings. Second edition rewritten and much enlarged. 8vo., 592 pages \$3.00

POSSELT.—Technology of Textile Design :

Being a Practical Treatise on the Construction and Application of Weaves for all Textile Fabrics, with minute reference to the latest Inventions for Weaving. Containing also an Appendix, showing the Analysis and giving the Calculations necessary for the Manufacture of the various Textile Fabrics. By E. A. POSSELT, Head Master Textile Department, Pennsylvania Museum and School of Industrial Art, Philadelphia, with over 1000 illustrations. 292 pages. 4to. \$5.00

POSSELT.—The Jacquard Machine Analysed and Explained :

With an Appendix on the Preparation of Jacquard Cards, and Practical Hints to Learners of Jacquard Designing. By E. A. POSSELT. With 230 illustrations and numerous diagrams. 127 pp. 4to. \$5.00

ROPER.—Instructions and Suggestions for Engineers and Firemen :

By STEPHEN ROPER, Engineer \$2.00

ROPER.—The Steam Boiler : Its Care and Management :

By STEPHEN ROPER, Engineer. 12mo., tuck, gilt edges . \$2.00

ROPER.—The Young Engineer's Own Book :

Containing an Explanation of the Principle and Theories on which the Steam Engine as a Prime Mover is Based. By STEPHEN ROPER, Engineer. 160 illustrations, 363 pages. 18mo., tuck . \$3.00

ROSE.—Modern Steam-Engines :

An Elementary Treatise upon the Steam-Engine, written in Plain language ; for Use in the Workshop as well as in the Drawing Office. Giving Full Explanations of the Construction of Modern Steam-Engines: Including Diagrams showing their Actual operation. Together with Complete but Simple Explanations of the operations of Various Kinds of Valves, Valve Motions, and Link Motions, etc., thereby Enabling the Ordinary Engineer to Clearly Understand the Principles Involved in their Construction and Use, and to Plot out their Movements upon the Drawing Board. By JOSHUA ROSE, M. E. Illustrated by 422 engravings. 4to, 320 pages . . . \$6.00

ROSE.—Steam Boilers :

A Practical Treatise on Boiler Construction and Examination, for the Use of Practical Boiler Makers, Boiler Users, and Inspectors; and embracing in plain figures all the calculations necessary in Designing or Classifying Steam Boilers. By JOSHUA ROSE, M. E. Illustrated by 73 engravings. 250 pages. 8vo. \$2.50

SULZ.—A Treatise on Beverages :

Or the Complete Practical Bottler. Full instructions for Laboratory Work, with Original Practical Recipes for all kinds of Carbonated Drinks, Mineral Waters, Flavorings, Extracts, Syrups, etc. By CHAS. HERMAN SULZ, Technical Chemist and Practical Bottler. Illustrated by 428 Engravings. 818 pp. 8vo. . . . \$10.00

A Great Repository of Practical and Scientific Information.

**One of the Fullest, Freshest and Most Valuable Hand-books
of the Age. Indispensable to Every Practical Man.**

NOW READY.

PRICE, \$2.00

FREE OF POSTAGE TO ANY ADDRESS IN THE WORLD.

THE TECHNO-CHEMICAL RECEIPT BOOK:

CONTAINING

**Several Thousand Receipts, covering the Latest, Most
Important and Most Useful Discoveries in Chemical
Technology, and their Practical Application
in the Arts and the Industries.**

Edited chiefly from the German of Drs. Winckler, Elsner, Heintze,
Mierzinski, Jacobsen, Koller, and Heinzerling,

WITH ADDITIONS BY

WILLIAM T. BRANNT,

Graduate of the Royal Agricultural College of Eldena, Prussia,

AND

WILLIAM H. WAHL, PH. D. (Heid.),

Secretary of the Franklin Institute, Philadelphia; author of "Galvanoplastic Manipulations."

Illustrated by Seventy-eight Engravings.

In one volume, xxxii, 475 pages, 12 mo., closely printed, containing an immense amount
and a great variety of matter. Elegantly bound in scarlet cloth, gilt.
Price \$2.00, free of postage to any address in the world.

*✉ The above or any of our books sent by mail, free of postage, at the publication
price, to any address in the world.*

*✉ Our New and Enlarged Catalogue of Practical and Scientific Books, 96 pages,
8vo., and our other Catalogues, the whole covering every branch of Science applied to the
Arts, sent free and free of postage to any one, in any part of the world, who will furnish
his address.*

HENRY CAREY BAIRD & CO.,

Industrial Publishers, Booksellers and Importers,

810 Walnut Street, Philadelphia, Pa., U. S. A.





**THIS BOOK IS DUE ON THE LAST DATE
STAMPED BELOW**

—————
**RENEWED BOOKS ARE SUBJECT TO IMMEDIATE
RECALL**

LIBRARY, UNIVERSITY OF CALIFORNIA, DAVIS

Book Slip-70m-9,'65 (F7151s4)458

No 404533

TP151
B8

Brannt, W.T.
The techno-chemical
receipt book.

PHYSICAL
SCIENCES
LIBRARY



3 1175 02088 4360

404533	Call Number:
Brannt, W.T. The techno-chemical receipt book.	TP151 B8

LIBRARY
UNIVERSITY OF CALIFORNIA
DAVIS

