

UNIVERSITY OF
ILLINOIS LIBRARY
AT URBANA-CHAMPAIGN
BOOKSTACKS

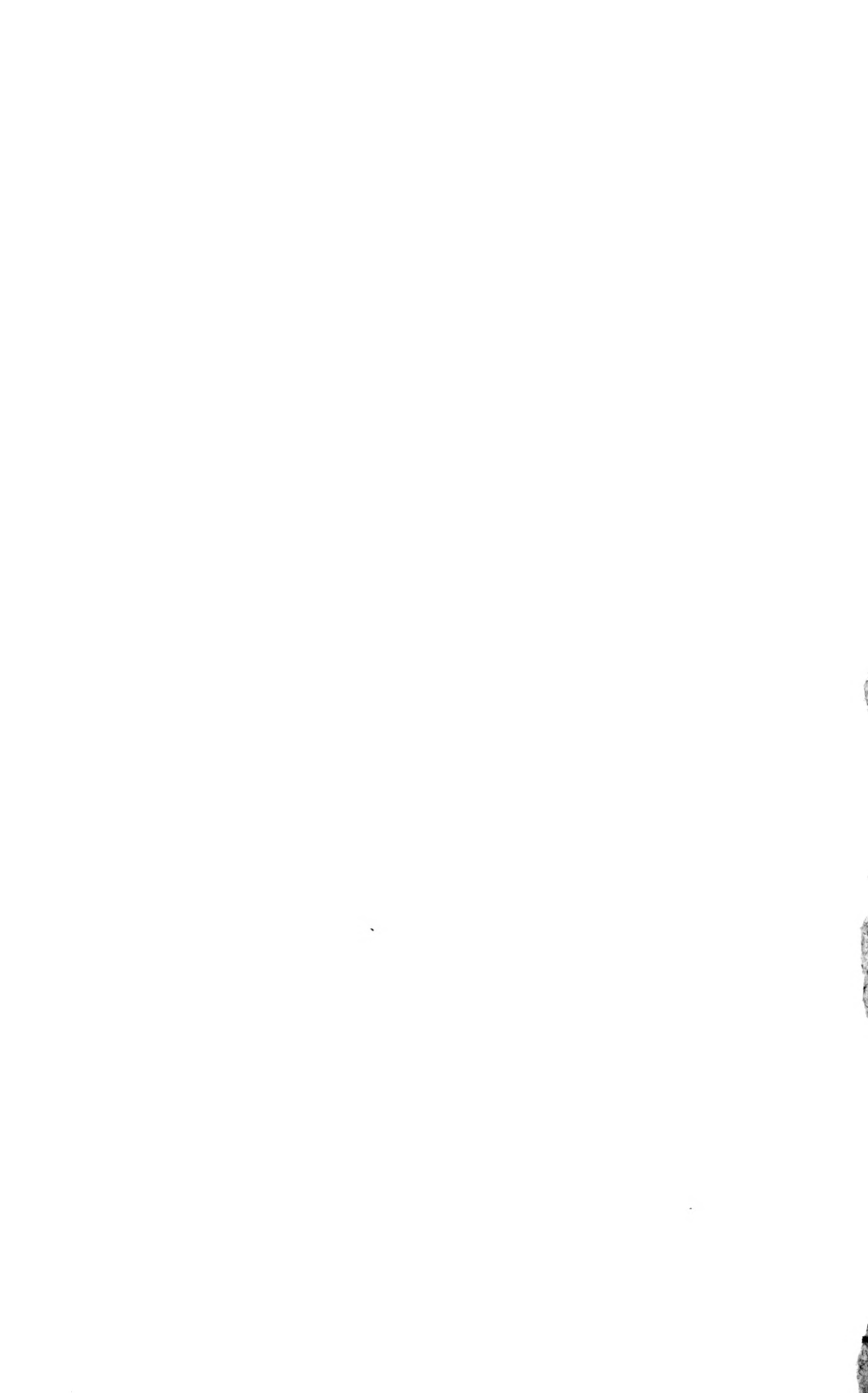

JH
ESTABLISHED 1885

THE TECHNOGRAPH

PUBLISHED BY THE
ENGINEERING SOCIETIES
OF THE UNIVERSITY
OF ILLINOIS

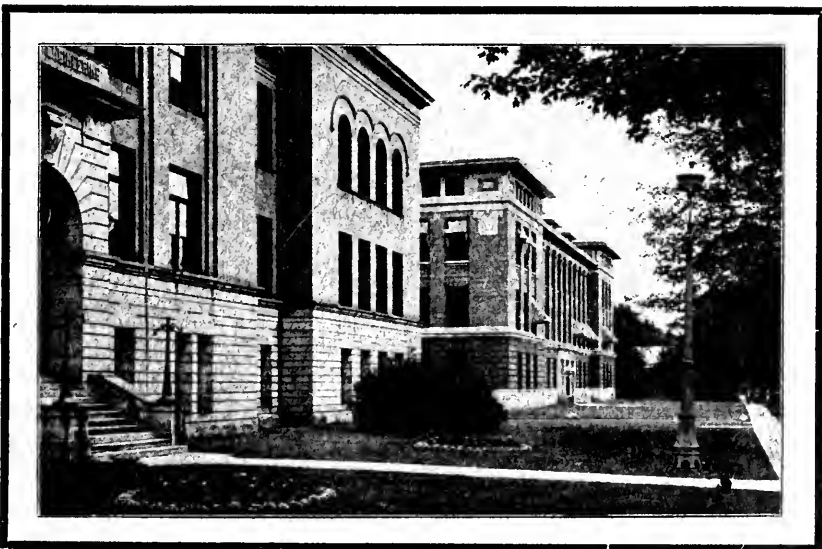

VOL. XXVII

DECEMBER, 1912

NO. 1

PRICE 25 CENTS

Special Laboratory Instruments

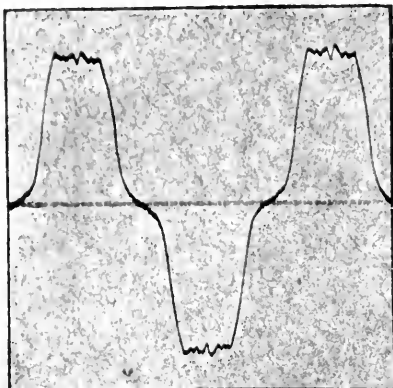

No Load

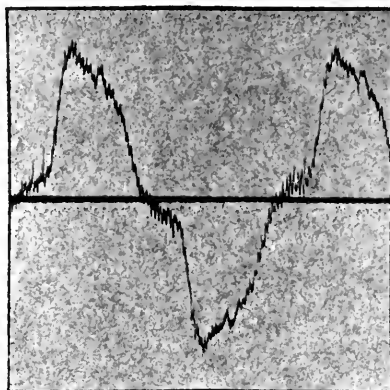

1 1/2 Load

The Oscillograph

The most useful and best known instrument for investigating all kinds of complex electrical phenomena is the oscillograph.

It can be used as either an indicating or recording instrument to show the wave form of any alternating current machine or circuit. It is especially useful for making photographic records of transient phenomena, such as the operation of circuit breakers or oil switches under short circuit conditions, or the operation of lightning arresters in discharging abnormal voltages.

Our laboratories have made important improvements in the oscillograph and it has been found very useful in the development of new types of apparatus and protective devices.

The General Electric Company is the only maker of this improved oscillograph and every instrument is made and tested under the direct supervision of our standardizing laboratory.

General Electric Company

Largest Electrical Manufacturer in the World

3820

General Office: Schenectady, N. Y. Sales Offices in Forty-eight Cities

The Guarantee of
Excellence



on Goods
Electrical.

When writing to advertisers please mention THE TECHNOGRAPH

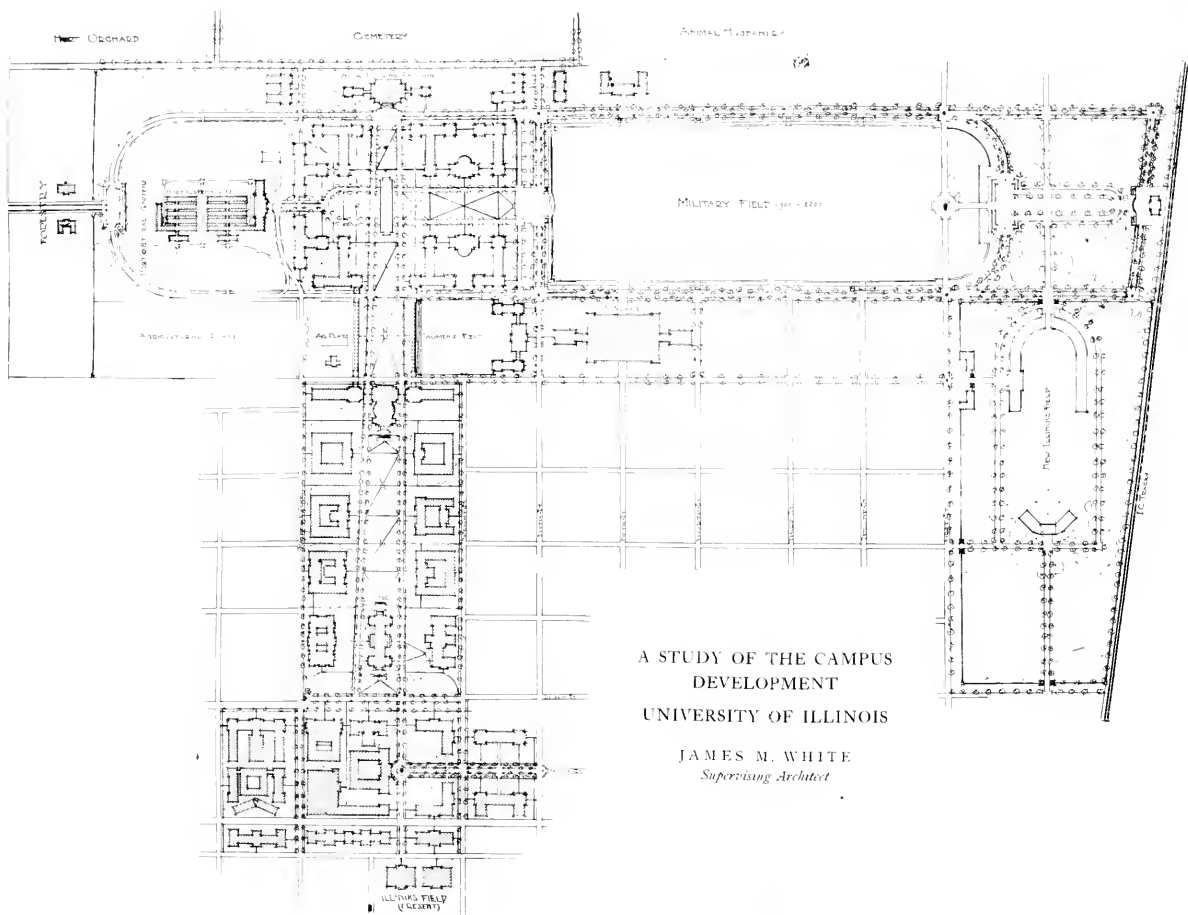

A STUDY OF THE CAMPUS
DEVELOPMENT
UNIVERSITY OF ILLINOIS

JAMES M. WHITE
Supervising Architect

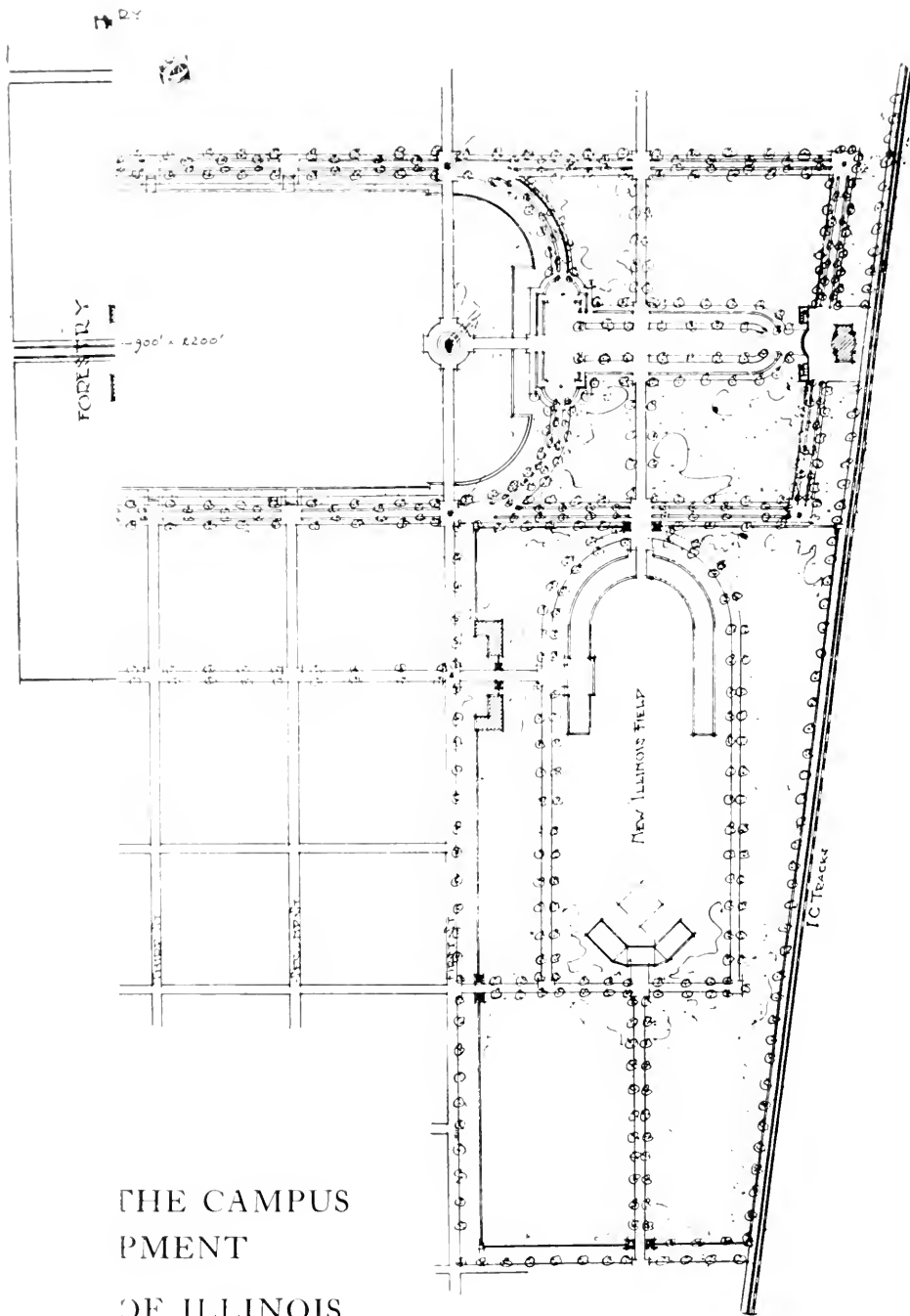

THE CAMPUS
PLAN
OF ILLINOIS

L. WHITE
Architect

The Technograph

VOL. XXVII

DECEMBER, 1912

No. 1

THE NEW ILLINOIS

H. W. UNDERHILL, '13

Editor-in-Chief, The Technograph

It is not the purpose of this article to review the various plans which have been conceived for our campus development but rather to sum up conditions as they are today and survey the outlook for the future. From the time when Doctor Gregory and Doctor Burrill first forecasted the future campus by laying out Burrill Avenue and locating University Hall, down through the various studies submitted by C. H. Blackall, '77, State Architect W. C. Zimmerman and others, the growth towards a comprehensive and adequate scheme for the future development of our campus has been steady but rather erratic. At the present time Prof. James M. White, Supervising Architect has charge of the campus development and under his regime a feasible plan has been worked out with more admirable features than would seem possible considering the restrictions imposed by existing conditions. It is this plan that the writer will discuss.

The plan provides for a future growth south of the present South Campus to the Cemetery Grounds and west to the I. C. tracks. Of this area the University now owns the 160 acres between the auditorium and the cemetery and extending from Lincoln Avenue to Fourth street. The portion east of Mathews Avenue will be reserved for the outdoor laboratory work of the departments of Horticulture and Agronomy and about thirty acres between the line of Sixth Street extended and Fourth Street will be immediately available for the military department.

The main axis of the campus is the Meridian passing through the center of the Auditorium which will be intersected by an east and west axis a few feet south of the road in front of the present row of barns.



TRANSPORTATION BUILDING

In locating the buildings, departmental relations have been given first consideration. The Engineering Group occupies the area north of Green Street, the Literature and Arts Group the west side of the Main Quadrangle, the Science Group the east side, the Auditorium becomes the center of a Fine Arts Group, the Agricultural buildings dominate the New South Campus, and the Military and Athletic fields extend west to the tracks.

Part of this development will be so far in the future that it may be considered more of a dream than of a certainty and many modifications will be necessary as the needs of the future become more definitely defined, but the essential features have been settled by the locating of the buildings now under way. The alignment of the facades of Lincoln Hall, the Women's Building and the Commerce Building definitely establishes the outlines of the central court and the locating of the Armory, Stock Pavilion and Horticulture Group establish limits within which the south court must be developed.

The plan as illustrated herewith involves some radical changes. University Hall and the Law Buildings have disappeared and also the two-story annexes to the Agricultural Building. The main Agricultural building has been moved half its length northward to center opposite the Women's Building, thus freeing a site opposite Lincoln Hall for a New Science Hall.

The Engineering Group provides for an increase in all the various departments east and west between Green Street and Springfield Avenue. The Main Building is to be left unchanged. The square of the Physics Building is to be completed and the E. E. and T. and A. M. Laboratories are to be joined together and surmounted by an imposing central feature. The power plant is to be extended over the space now occupied by the Machine Shops. Across the street car tracks an entirely new group of shop buildings will be located. The Transportation Group and the Mining and Ceramics Laboratories are to be completed as shown. The Locomotive Testing Laboratories and smoke stack are now being constructed and the Electrical Testing Laboratory and Car Barn will soon follow. West of Burrill Avenue are locations for four new Engineering Buildings.

A new avenue to balance Burrill Avenue is to be built along the east side of the Main Quadrangle. University Hall is to be replaced by either an Administration Building or Library located further north or the facade of the present Library Building may



THE WOMAN'S BUILDING

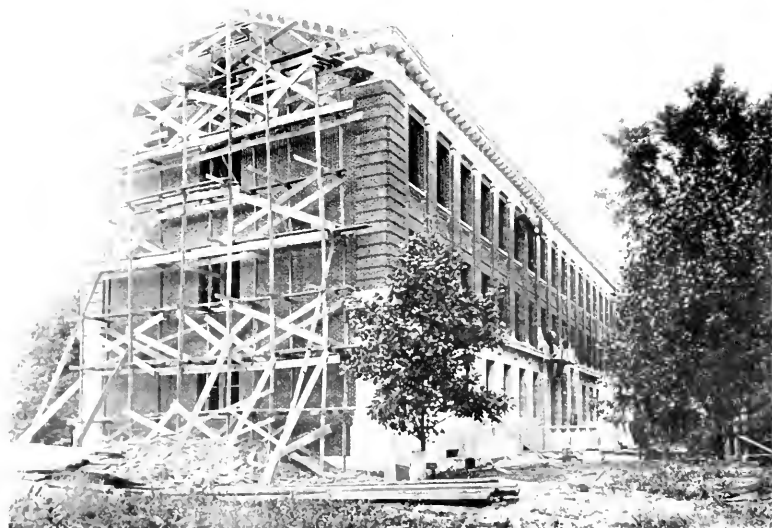

COMMERCE BUILDING

(These photographs were taken in October)

be swung around to face east and additions built to the south and north to make it adequate in size. The Commerce Building facade is to be extended north and south and the square completed. The Women's Building is now nearing its final state. The hollow square on the west side of Lincoln Hall will be enclosed and the Chemistry and Natural History Buildings are

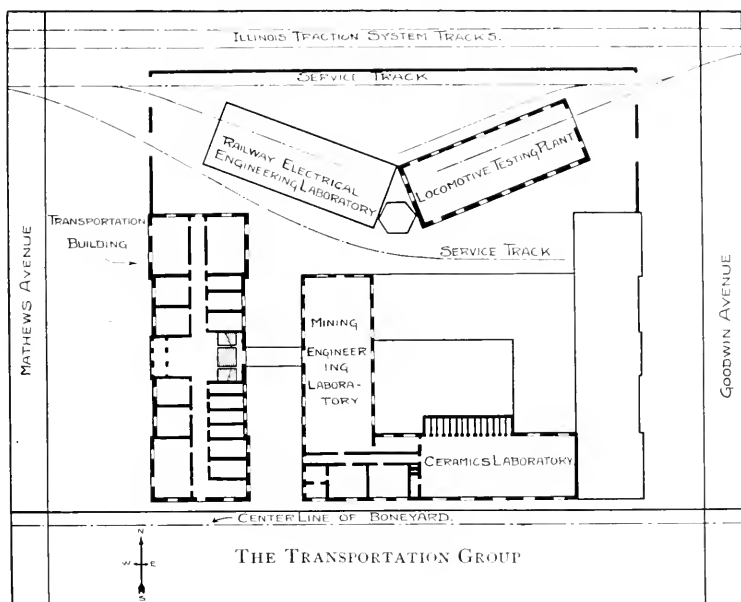

to be finished by additions in the very near future. The present Agricultural Building will be converted into a Science Building on a new location opposite the Women's Building and on the location south of it a new building will be erected conforming in design to Lincoln Hall.

A large stage with accessory rooms is to be built on the rear of the Auditorium thus completing it so it can be used for theatricals. The south side of the building is to be constructed in the form of a band shell, facing on an open plaza for the use of mass meetings and campus concerts. It is to be connected on each side by colonades along the two avenues with the south campus group to be built about the new east and west axis.

The site west of the Auditorium will probably be reserved for a new Music school which will contain an auditorium to seat 1000 persons with the necessary music studios and class rooms.

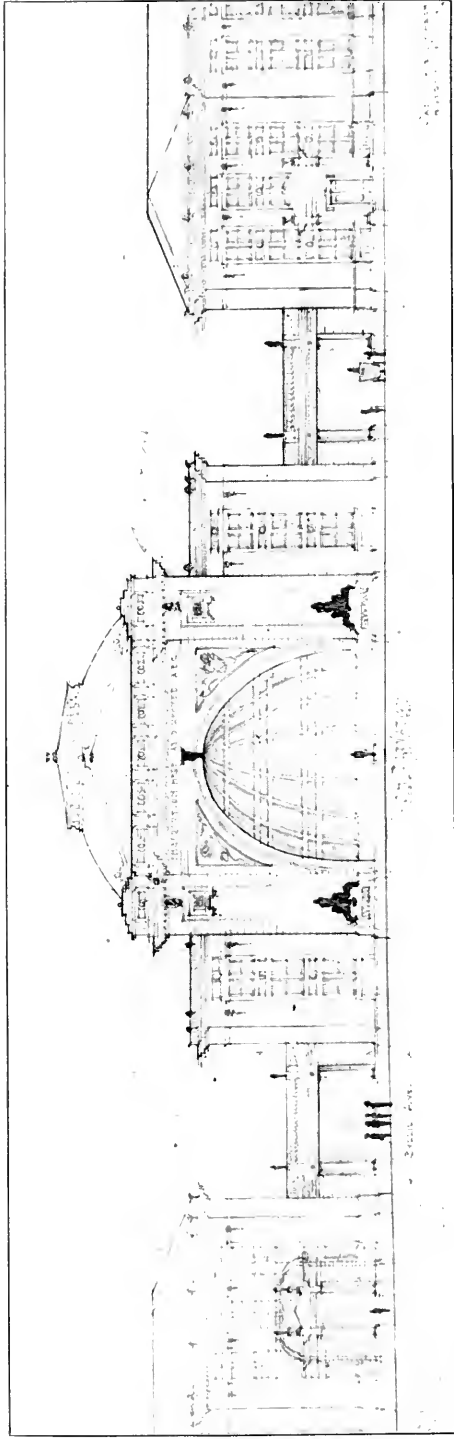

MUSIC SCHOOL

AUDITORIUM

FINE ARTS SCHOOL

SOUTH ELEVATION OF AUDITORIUM ADDITIONS

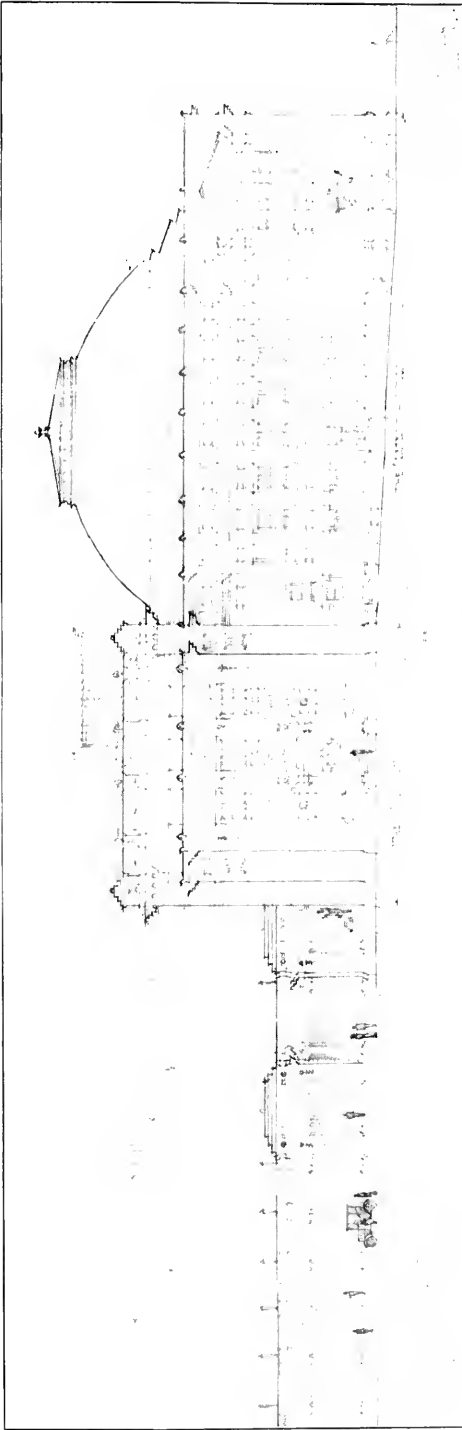

EAST ELEVATION OF AUDITORIUM AND ADDITIONS

The corresponding site on the east side is a desirable one for the departments of Fine Arts and Architecture, but would be well located for a School of Education.

South of the Auditorium is to be formed a new quadrangle, the sites surrounding which will be occupied by the College of Agriculture with its many departments, for public museums and other interests now unthought of. The Horticultural Buildings and grounds are to be located east of this group. \$50,000 is being spent now in the construction of vegetable and plant breeding greenhouses to replace those removed from the present grounds. A large stock pavilion is to close the main axis south of the group. Plans are now being prepared and construction will follow next year.

West of this quadrangle to First Street a Military Field is to be built—900 by 2200 feet. The new Armory is now being constructed north of it and when completed will be the largest building of its kind in this country. The clear floor will measure 200 by 400 feet and it will be 100 feet to the crown of the barrel-vaulted roof. Three-story wings will be built on each side containing locker rooms and shooting tubes. Locations are left for two future units to contain swimming pools and a banquet hall.

A new Illinois Field is to be provided for along the I. C. tracks from Davidson to Green Streets. Of this property the Athletic Association has already purchased twenty acres lying approximately in the area marked New Illinois Field. The present gymnasium will continue to be used with the Armory as an annex and field houses will be built on the new location. When this improvement is completed Illinois Field will be used as a recreation ground. The Women's Gymnasium and Field are to be located east of the Armory as shown.

The plan is one that is comprehensive and adequate as far as can now be foreseen. All buildings will be fireproof and equipped in the most modern manner. The acquisition of property and the construction of buildings will take many years to come, but every year brings us nearer to our goal—A New Illinois.

THE ELECTRICAL SHOW

L. A. DOLE, '13

After abandoning the Electrical show project last year, the Electrical engineers, having gained the sanction of Dr. E. J. Berg, have decided to hold a show this year. There are to be three days in which the students will be given an opportunity to show their ability as to the handling of electrical apparatus, for the amusement and edification of the general public. The dates decided upon are February 6, 7, 8, 1913. The last three days of the first week of the second semester.

This seems to be the only logical time for such an undertaking as at this period no one is extremely busy. It will also give the Electrical Engineering students ample time during the mid-year recess to get the laboratory properly arranged and all attractions in perfect working order.

On account of the enlarged floor space a greater number of exhibits can be handled than in any previous year and visitors taken care of with less confusion and trouble. Guides or "Live Wires" will be furnished and as far as possible a regular line of travel will be laid out and followed.

Electrical manufacturing concerns throughout the United States are being notified of the coming event and as they are to be allowed to exhibit there is no reason whatever for any floor-space to be without something occupying it to attract the public. These companies will be given a helper or a man to take charge of their advertisement. The attractions for the most part will be of a non-technical nature and are to consist of apparatus and supplies such as will be of interest to the general public and electric power consumer.

Considering the fact that there will be no show in Chicago this year and that an extensive advertising campaign is being carried on, it is confidently expected that the attendance will be more than double that of any show which has ever been held by the University.

Wireless telephony, telegraphy, and speaking arcs will be featured as well as wireless transmission of power. Automatic motor starters will be installed with a self-contained dynamic breaking circuit using a system of remote control showing clearly its advantage as a labor-saving and protective device. Negoti-

ations are being carried on for a lifting magnet with the accompanying control such as is used in large steel mills.

Several different types of oscillographs will be open to inspection and will be in actual operation showing waves of electrical potential and current. An attendant will explain the operation of the instrument and will give short lectures on wave forms for the benefit of the technically inclined. Electric furnaces melting iron, lead, zinc, and alloys are to be installed. The cost of operation and principal of working as well as the economical advantages will be taken up from the commercial point of view. The wireless apparatus that will be in use is one that has recently been in operation and has established communication with Saint Louis, Chicago and New York. Many amateurs throughout the state have been "picked up" and all of these men will be notified as to the time of the show and communication will be established with their stations on the three days of the exhibition. Two licensed operators will have charge of this exhibit. Numerous other items of interest such as Electric Fountains, Mercury Arcs, "X"-Rays, Refrigerating machines, Gyroscopic clocks and exhibitions of restitution may be seen by the visitor.

The house-wife will not be slighted, for electric heaters, pads, flatirons, power-washing and sewing machines will be displayed. For the ladies not interested in these things, there will be a display of chafing dishes and curling irons. All kinds of artistic, ornamental and useful lighting will be on exhibition; and a lighting expert will be on hand to tell the house-owners how to make their homes attractive, but with reduced light bills.

The management has been undertaken entirely by undergraduates who are devoting most of their time to the plans and business of the coming event. The President of the E. E. Society, D. C. Wood, is acting as general manager and the other departments are being taken care of as follows: L. A. Dole, Advertising; C. R. Horrell, Business; G. L. Greves, Chief Engineer. Any of these men will be glad to receive correspondence in regard to the show.

Undergraduates and graduate students are to be allowed to put on personally conducted exhibits and novelties which are planned to amuse and mystify the non-electrical public.

A DESIGN OF A WING ABUTMENT

GEORGE L. JENSEN, C. E., '09

A design of a wing abutment is not a difficult undertaking if approached in the proper way and if the proper sequence of computations to be made is understood. If attempted, however, without this proper understanding of the necessary procedure, the design becomes a difficult one and is sure to cause trouble for the designer. But after a design has once been made, provided the design is an honest one and no "fudging" of dimensions has been attempted, then much of the trouble with the abutment designing disappears; when once the necessary computations have been carried through, and the sequence in which these computations should be made is understood, then the entire process proves simple indeed. It is with the object of presenting what the writer considers proper procedure in abutment designing that the writing of this article has been attempted; it is with the hope of lightening some of the labors of this first and most difficult design that standardized methods will be introduced and detailed computations will be made.

Fig. 1 illustrates a typical wing abutment. The notes accompanying the figure are self-explanatory. The footing dimensions (offsets from neatwork) are standard. The batters for the face and back of abutment should be such that the resulting footing area will be large enough to produce a bearing on the soil not in excess of the allowable bearing. The length of the wings will be determined in the following way. The abutment is laid out to approximate scale in its proper position on the bridge survey, this position being fixed by predetermined span length and with reference to the desired span opening. Then at a distance from the center line of track of 8 ft. 6 in. (see Fig. 1) and at the angle of the wing wall it has been decided upon to use, lay out the abutment with its wings. As shown in Fig. 1, the wing-wall will be carried down until its top at the end is about four ft. above the surface of the ground at that point. What the length of the wing-wall will be can be easily determined, for, knowing the base of rail elevation, the slope of the wing-wall top, (usually $1\frac{1}{2}$ to 1), and the contours crossed by the wing wall as it is carried down, a condition can be determined that will comply with the requirement that the end of the wing-wall be about four ft. above the ground level.

DESIGN OF AN ABUTMENT FOR A 65' SHALLOW DECK GIRDER

Fig 2

CONCRETE
Nearwork — 953 Cu yd
Footing — 175 Cu yd

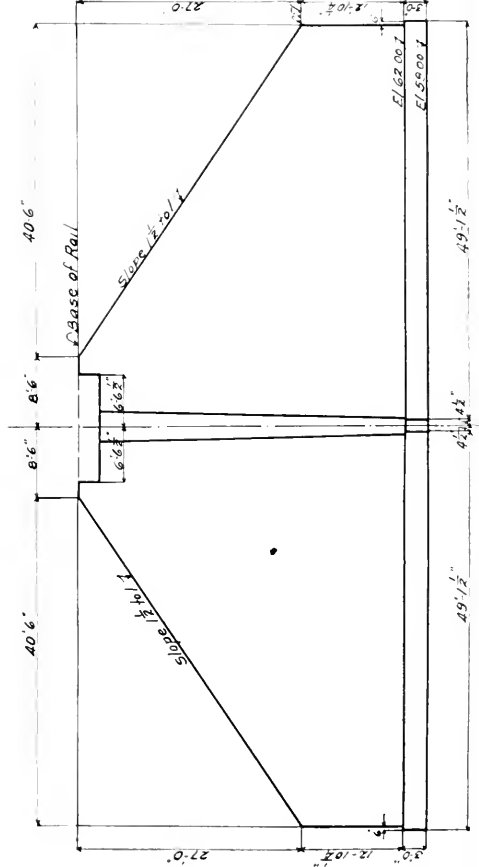
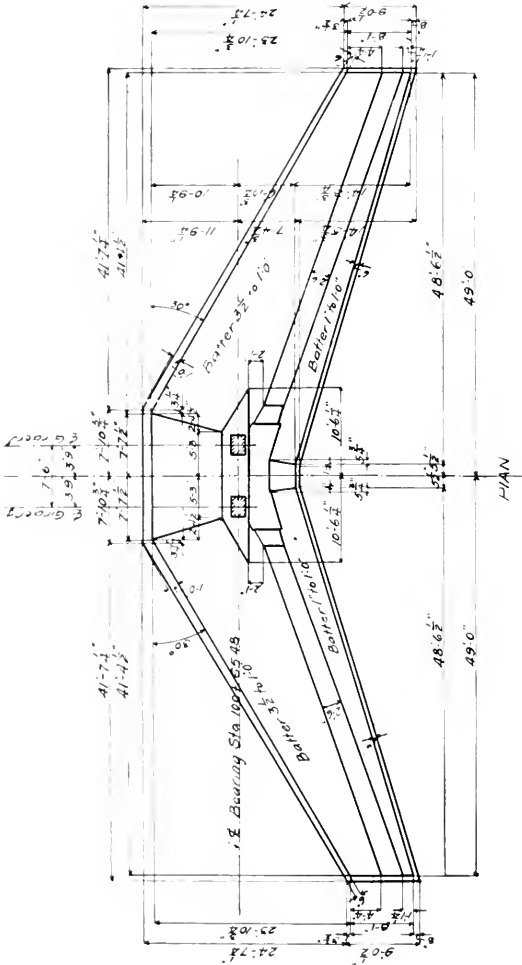

REAR ELEVATION

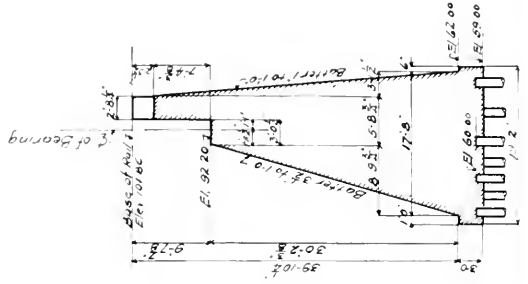

SECTION AT END OF TRACK

Referring again to Fig. 1, plan view, a jog in the wing-wall line will be noticed where the top of the wing-wall meets the top of the parapet. This jog usually catches the eyes of a novice and he is almost sure to question its purpose. The explanation is simple enough. The top of the parapet is level, as shown in the elevation and in the section on the center line of the track. If level, it is at a uniform height above the top of the footing, and if at a uniform height above the top of the footing the batter to it must be uniform. But the batter is measured from the line of intersection of the wing-wall base with the top of the footing, hence the wing-wall line at the top of the parapet must be run parallel with this line of intersection. The same explanation applies to the jog which will be noticed above the bridge seat line. The end of the wing-wall is, of course, parallel to the center line of track.

The various angles shown are derived in the following way. To begin with, the governing angle is the angle of the base of the wing-wall. This governing angle is usually at 15, 30 or 45 deg. to a line perpendicular to the center line of track. Now, knowing Θ , the angle of the base of the wing-wall (see Fig. 1) then $\tan. \Phi = \frac{B \cos. \Theta}{(18 - B \sin. \Theta)}$ —where B equals the batter of the face of the wing-wall in inches per foot.

To better illustrate the derivation of this formula, a section of the wing-wall formed by two parallel horizontal planes one foot apart (see Fig. 3) will be taken. For this height the wing-wall being at a slope of $1\frac{1}{2}$ to 1 will have approached the center line of track a distance equal to $1\frac{1}{2} \times 1$ ft. = 18 in. and at the same time the face of the wing-wall will have battered back a distance equal to B inches, where B, as stated before, equals the batter per foot of height. Then AC represents the slope of the front edge of the top of the wing-wall, AD the slope of the front edge of any horizontal section, CG the slope of the front edge of any horizontal section one foot above. AD and CG are both at an angle Θ to the face of the abutment. The problem is to find Φ the angle that AC makes with AD. Draw CD perpendicular to AD. Then CD equals the batter B. Draw ED at an angle Θ to CD. Then EC = FH = B sin. Θ . Therefore AF = 18 - B sin. Θ . Then in triangle AFD, $AD = \frac{(18 - B \sin. \Theta)}{\cos. \Theta}$. But $\tan. \Phi = \frac{CD}{AD} = B \div \frac{(18 - B \sin. \Theta)}{\cos. \Theta} = \frac{B \cos. \Theta}{(18 - B \sin. \Theta)}$

By the same line of reasoning the formula $\sin. \Delta = \frac{B \cos. (\Theta - \Phi)}{18}$ can be derived, where B in this case equals the batter of the back face of the wing-wall. With these two equations, and with the height of the abutment and the depth of the bridge seat known, all the computations for a particular abutment can be made.

To illustrate the computations that are necessary a specific abutment will be designed (see Fig. 2). A 65 foot shallow deck plate girder is to be used. Reference to steel plans shows that the distance from the base of the rail to the bottom of the sole plate is 8 ft. 9 $\frac{3}{4}$ in. The depth of the abutment casting is 10 in. Below this casting $\frac{1}{8}$ in. of lead is usually placed. These three dimensions added together give 9 ft. 7 $\frac{7}{8}$ in. from the base of the rail to the bridge seat. The width of the bridge seat equals the width of the casting plus the casting clearance (see Fig. 1) which is equal to 3 ft. 0 $\frac{1}{2}$ in. With these two dimensions known and the elevation of the top of the footing and the batter of the face and the back of the abutment predetermined, the other elevation dimensions can be found. Now, with the elevation dimensions, batters, angles and length of wings known, the abutment can be laid out on detail paper. The dimensions to be computed can then be roughly checked by scaling them from the abutment as laid out.

The angle of the wing-wall Θ , is 30 degrees. Then the distance from the center line of the track to the line of intersection of the planes of the face of the abutment and wing-wall at the bridge-seat equals 3 ft. 9 in. ($\frac{1}{2}$ the distance between center lines of girders), plus $\frac{2' 6''}{2}$, ($\frac{1}{2}$ the length of the abutment casting), plus 3" ($12 \cos. \frac{30^\circ}{2}$ (casting clearance)) which equals 5 ft. 3 in. At the base of the abutment this distance equals 5 ft. 3 in. (the width at the bridge seat) + 2' 4 $\frac{1}{2}$ " (batter $\times \tan. \frac{30^\circ}{2}$) = 7 ft. 7 $\frac{1}{2}$ in. The distance from the center line of the track to the edge of the intersection of the wing-wall footing equals 7 ft. 7 $\frac{1}{2}$ in. plus $12 \tan. \frac{30^\circ}{2} = 7$ ft. 10 $\frac{3}{4}$ in. The elevation of the wing-wall at the end equals 74.85. The elevation of the base of the rail is 101.86. Therefore the distance from the center line

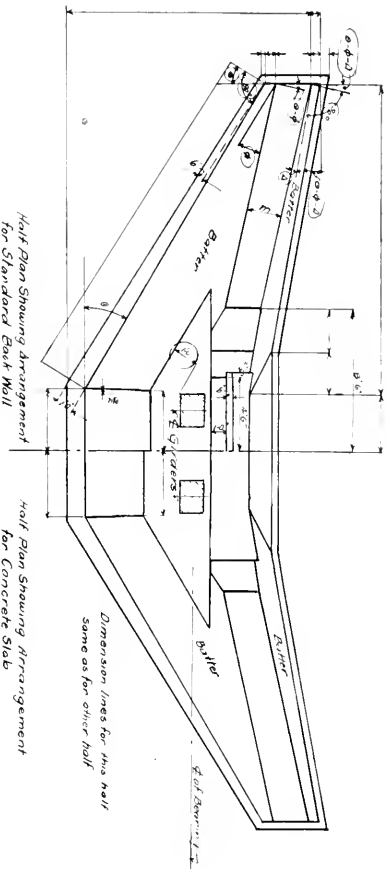

Half Plan Showing Arrangement for Standard Back Wall

Half Plan Showing Arrangement for Concrete Slab

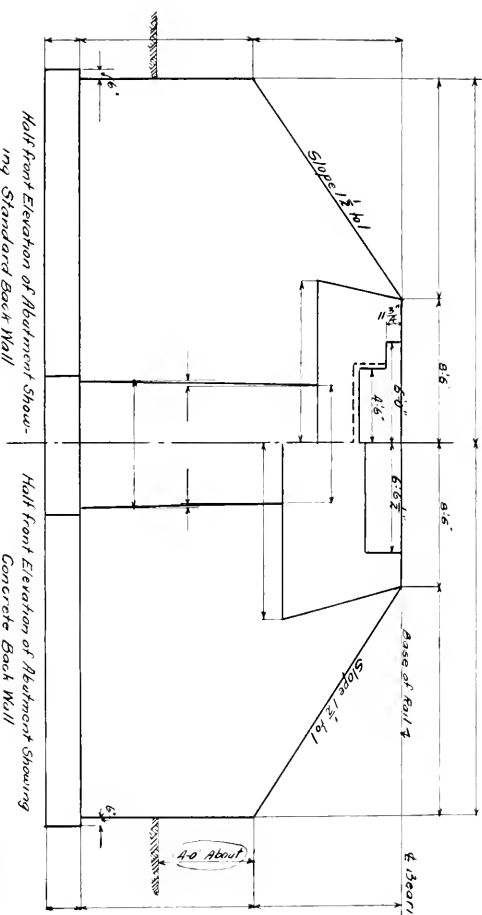

Half Front Elevation of Abutment Showing Standard Back Wall

Half Front Elevation of Abutment Showing Concrete Back Wall

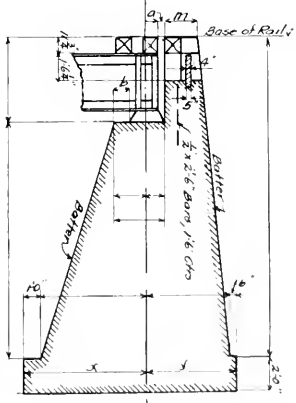

Section thru 1/2 of track showing Standard Back Wall Foundation without piles

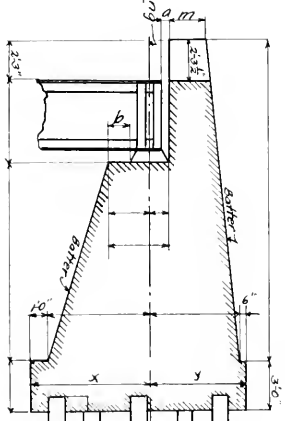

Section thru 1/2 of track showing Arrangement for Concrete Floor Slab and Pile Foundation

Notes:

Distance 'x' should never be less than 'y'

a = 4" for Deck Girders

5" for Truss Girders

6" for Truss Spans

b = about 12"

Batter in face of wing same as in face of abutment

m = 3/4" for heavy work

3/8" for light work

Distribute piles according to intensity of bearing

Dimensions to be filled in where shown

Dimensions circled not to be shown on masonry drawings

* Footing is located by offset from neat lines

$$\tan \phi = \frac{A \cos \theta}{B \sin \theta}$$

$$\sin \Delta = \frac{A \cos \theta}{B \sin \theta}$$

Where θ = Batter in inches per ft

TYPICAL ABUTMENTS

of the track to the end of the wing-wall equals 8 ft. 6 in. (see Fig. 1) + $(101.86 \div 74.85) \times 1\frac{1}{2} = 49$ ft. The distance from the edge at the base of the wing intersection with the face, to the end of the wing-wall is 49 ft. - 7 ft. 7½ in. = 41 ft. 4½ in. The front edge of the top of the wing-wall at the end is 41 ft. 4½ in. $\times \tan. 30^\circ = 23$ ft. 10¾ in. from the front edge at the base of the face of the abutment. The distance from the top of the footing to the top of the wing-wall at the end is 12 ft. 10¼ in., (see rear elevation), therefore the batter offset at the end is 12 ft. 10¼ in. $\times 3\frac{1}{2}$ in. (the batter of the wing-wall) $\times \sec. 30^\circ = 4$ ft. 4 in. Now from formula previously derived $\tan. \Phi =$

$$\frac{B \cos. \Theta}{(18 - B \sin. \Theta)} = \frac{3\frac{1}{2} \times \cos. 30^\circ}{(18 - 3\frac{1}{2} \times \sin. 30^\circ)} \text{ from which } \Phi = 10^\circ 34'$$

$$\sin. \Delta = \frac{B \times \cos. (\Theta - \Phi)}{18} = \frac{1 \times \cos. (30^\circ - 10^\circ 34')}{18} \text{ from}$$

which $\Delta = 3^\circ 0'$, then batter offset at end = 12' 10¼ in. $\times 1$ (batter of back of wing) $\times \sec. (\Theta - \Phi - \Delta) = 1$ ft. 1¼ in. Width of top of wing-wall equals 2 ft. 6 in. (See Fig. 1) but width parallel to end of wing-wall = 2 ft. 6 in. $\times \sec. (\Theta - \Phi) = 2$ ft. 7¾ in. Total width of end of wing-wall at base = 2 ft. 7¾ in. + 4 ft. 4 in. + 1 ft. 1¼ in. = 8 ft. 1 in. Distance edge of wing-wall to edge of footing at front corner = 6 in. (see Fig.

1) $\times \tan. \frac{(90^\circ - \Theta)}{2} = 3\frac{1}{2}$ in. Distance edge of wing-wall to

edge of footing at back corner = 6 in. $\times \tan. \frac{[90^\circ + (\Theta - \Phi - \Delta)]}{2}$

= 8". Width of footing at end = 8 ft. 1 in. + 3½ in. + 8" = 9 ft. 0½ in. Distance from end of wing-wall to line of intersection of back of wing-wall with back of abutment at base = (23 ft. 10¾ in. + 8 ft. 1 in. - 17 ft. 8 in.) $\times \cot. (\Theta - \Phi - \Delta) = 48$ ft. 6½ in. This line of intersection from base of abutment to bottom of slab opening (see Fig. 2, rear elevation) offsets a distance equal to 37 ft. 6¾ in. $\times 1$ (batter at back) $\times \tan.$

$\frac{(\Theta - \Phi - \Delta)}{2} = 5\frac{3}{4}$ in. Distance edge of wing-wall intersection

at base of abutment to edge of footing = 6 in. $\times \tan.$

$\frac{(\Theta - \Phi - \Delta)}{2} = 1$ in. The remaining dimensions shown on the

plan are too easily determined to require any explanation.

The dimensions all known, the abutment yardage can now be

determined. Take a typical horizontal section as shown in Fig. 4. The dimensions for the section at the base of the abutment being known then for any parallel section above the base the dimensions for the section will be determined in the following manner. Let A' = the value of A at the base of the abutment, then for any height, h , A will equal $A' - h \times (B' + B'')$ where B' and B'' are the batters at the front and back of the abutment. Let C' = the value of C at the base, then for any height, h , $C = C' - B' \tan. \frac{\Theta}{2} \times h$, and for problem at hand $C = C' - 3\frac{1}{2} \times \tan. \frac{30^\circ}{2} \times h = C' - 0.938 \text{ in.} \times h$. Let E' = the value of E at base, then for any height, h , $E = E' + B'' \times \tan. \frac{\Theta - \Phi - \Delta}{2} \times h$, and for problem at hand $E = E' + \tan. \frac{16^\circ 26'}{2} \times h = E' + 0.1444 \times h$. Let D' = the value of D at the base, then for any height, h , between base of wing-wall and top of end, $D = D' + B' \times \tan. \frac{\Theta}{2} \times h = D' + 0.938 \times h$, but for heights above the top of the end the slope of the top of the wing-wall will enter in, then the end the slope of the top of the wing-wall will enter in, then $D = D' + 0.938 \times h - 1\frac{1}{2} \times h'$ where h' equals the height above the top of the wing-wall at the end. E at base and at top is known and for intermediate sections can be interpolated. A , C , D , and F being known, then the areas shown in dotted lines in Fig. 4 marked [1], [2] and [3] can be computed from the following formulae:

$$[1] = A \times C.$$

$$[2] = \frac{(C - E)^2 \times \tan. (\Theta - \Phi - \Delta)}{2}$$

$$[3] = \frac{[F + A + (C - E) \times \tan. (\Theta - \Phi - \Delta)] \times D}{2}$$

If section is symmetrical about the center line then total area of cross-section = $2 \times ([1] + [2] + [3])$.

If section is not symmetrical then sections at advantageous planes for each half will be taken and the computations for each will be made independently.

Area at Base of Abutment

$A' = 17' 8''$, $F' = 8' 1''$, $C' = 7' 7\frac{1}{2}''$, $D' = 41' 4\frac{1}{2}''$, $E' = 5\frac{1}{2}''$ and $F' = 8' 1''$.

$$[1] = 17.67' \times 7.625' = 134.734 \text{ sq. ft.}$$

$$[2] = \frac{(7.625 - 0.458)^2 \times 0.295}{2} = 7.576 \text{ sq. ft.}$$

$$[3] = \frac{8.083 + 17.67 + (7.625 - 0.458) \times 0.295}{2} \times 41.375 = 576.633 \text{ sq. ft.}$$

$$\text{Total Area} = 2 \times (134.734 + 7.576 + 576.633) = 1437.886 \text{ sq. ft.}$$

Area at top of end of wing-wall

$$h = 12' 10\frac{1}{4}''$$

$$A = 17' 8'' - 12.854 \times 4\frac{1}{2}'' = 12' 10\frac{1}{4}''.$$

$$C = 7' 7\frac{1}{2}'' - 0.938'' \times 12.854 = 6' 7\frac{1}{2}''.$$

$$D = 41' 4\frac{1}{2}'' + 1' 0'' = 42' 4\frac{1}{2}''.$$

$$E = 5\frac{1}{2}'' + 0.1444 \times 12.854 = 7\frac{1}{4}''.$$

$$F = 2' 6'' \times \sec. (\Theta - \Phi) = 2' 7\frac{3}{4}''.$$

$$[1] = 12.8542 \times 6.625 = 85.159 \text{ sq. ft.}$$

$$[2] = \frac{(6.625 - 0.694)^2 \times 0.295}{2} = 5.397 \text{ sq. ft.}$$

$$[3] = \frac{2.646 + 12.854 + (6.625 - 0.694) \times 0.295}{2} \times 42.375 = 366.035 \text{ sq. ft.}$$

$$\text{Total Area} = 2 \times (85.159 + 5.397 + 366.035) = 913.182 \text{ sq. ft.}$$

Area at Mid-section

A, C, D, E and F are found by taking the mean of the values given for these dimensions on the base and end wall sections given above.

$$A = \frac{(17' 8'' + 12' 10\frac{1}{4}'')}{2} = 15' 3\frac{1}{8}''.$$

$$C = \frac{(7' 7\frac{1}{2}'' + 6' 7\frac{1}{2}'')}{2} = 7' 1\frac{1}{2}''.$$

$$D = \frac{(41' 4\frac{1}{2}'' + 42' 4\frac{1}{2}'')}{2} = 41' 10\frac{1}{2}''.$$

$$E = \frac{(5\frac{1}{2}'' + 7\frac{1}{4}'')}{2} = 6\frac{3}{8}''.$$

$$F = \frac{(8' 1'' + 2' 7\frac{3}{4}'')}{2} = 5' 4\frac{3}{8}''.$$

$$[1] = 15.2604 \times 7.125 = 108.233 \text{ sq. ft.}$$

$$[2] = \frac{(7.125 - 0.531)^2 \times 0.295}{2} = 6.413 \text{ sq. ft.}$$

$$[3] = \frac{5.365 + 15.2604 + (7.125 - 0.531) \times 0.295}{2} \times 41.875 = 471.572 \text{ sq. ft.}$$

Total area = $2 \times (108.233 + 6.413 + 471.572) = 1172.436$ sq. ft.

The areas computed above are the areas of the two bases, and the mid-section of a prismatoid the volume of which equals $\frac{h}{6}$

$$(A' + 4 \times M + A'') = \frac{12.854}{6} \times (1437.886 + 4 \times 1172.436 + 913.182) = 15083.766 \text{ cu. ft.}$$

Area of section at bridge seat

$$h = 30' 2\frac{3}{8}''$$

$$A = 17' 8'' - 30.198 \times 4\frac{1}{2}'' = 6' 4\frac{1}{8}''.$$

$$C = 7' 7\frac{1}{2}'' - 0.938'' \times 30.198 = 5' 3''.$$

$$D = 41' 4\frac{1}{2}'' + 0.938'' \times 30.198 - 1\frac{1}{2} \times 17.344' = 17' 8\frac{5}{8}''.$$

$$E = 5\frac{1}{2}'' + 0.1444'' \times 30.198 = 9\frac{7}{8}''.$$

$$F = 2' 7\frac{3}{4}''.$$

$$[1] = 6.344' \times 5.25' = 33.300 \text{ sq. ft.}$$

$$[2] = \frac{(5.25 - 0.823)^2 \times 0.295}{2} = 2.904 \text{ sq. ft.}$$

$$[3] = \frac{2.646 + 6.344 + (5.25 - 0.823) \times 0.295}{2} \times 17.72 = 91.249 \text{ sq. ft.}$$

Total area = $2 \times (33.300 + 2.904 + 91.249) = 254.916$ sq. ft.

Area at mid-section between section at top of wing-wall end and section at bridge seat. Mean dimension found as explained above.

$$A = \frac{(12' 10\frac{1}{4}'' + 6' 4\frac{1}{8}'')}{2} = 9' 7\frac{3}{16}''.$$

$$C = \frac{(6' 7\frac{1}{2}'' + 5' 3'')}{2} = 5' 11\frac{1}{4}''.$$

$$D = \frac{(42' 4\frac{1}{2}'' + 17' 8\frac{5}{8}'')}{2} = 30' \frac{9}{16}''.$$

$$E = \frac{(7\frac{1}{4}'' + 9\frac{7}{8}'')}{2} = 8' 9\frac{1}{16}''.$$

$$F = 2' 7\frac{3}{4}''.$$

$$[1] = 9.599 \times 5.938 = 57.000 \text{ sq. ft.}$$

$$[2] = \frac{(5.938 - 0.714)^2 \times 0.295}{2} = 4.030 \text{ sq. ft.}$$

$$[3] = \frac{2.646 + 9.599 + (5.938 - 0.714) \times 0.295}{2} \times 30.047 = 207.14 \text{ sq. ft.}$$

$$\text{Total Area} = 2 \times (57.00 + 4.03 + 207.14) = 536.34 \text{ sq. ft.}$$

Then by prismoidal formula the volume of the prismatoid between the top of end of wing wall and bridge seat equals $\frac{17.344}{6} \times (913.182 + 4 \times 536.34 + 254.916) = 9579.39 \text{ cu. ft.}$

For parapet volumes consider a prismatoid between bridge seat and bottom of slab opening (see Fig. 5). Shaded portions show part of bridge seat section under parapet. The dimensions and angles shown in Fig. 5 need no explanation.

Area of section of parapet at bridge seat

$$[1] = (5.25 + 5.27) \times 3.302 = 34.735.$$

$$[2] = \frac{(5.25 + 5.27 - 0.823)^2 \times 0.295}{2} = 13.90 \text{ sq. ft.}$$

$$[3] = \frac{(2.646 + 3.302 + 2.864 \times 12.448)}{2} = 54.85 \text{ sq. ft.}$$

$$\text{Total area} = 2 \times (34.735 + 13.90 + 54.85) = 206.97 \text{ sq. ft.}$$

Fig. 6 shows section under slab opening. Dimensions and areas solved for in the following manner:

$$X = 11.927 \times 0.295 = 3.52'.$$

$$y + 2' 7\frac{3}{4}'' = 2' 6\frac{3}{4}'' + X.$$

$$y = 3.561'.$$

$$z = 3.56 \times \cot. 30^\circ = 6.168'.$$

$$a = 11.927 - 6.168 = 5.76'.$$

$$[1] = 5.76 \times 2.687 = 15.477 \text{ sq. ft.}$$

$$[2] = \frac{1.329 \times 4.832}{2} = 3.216 \text{ sq. ft.}$$

$$[3] = \frac{(2.646 + 2.687 + 1.428) \times 6.168}{2} = 20.85 \text{ sq. ft.}$$

$$\text{Total area} = 2 \times (15.477 + 20.851 + 3.216) = 79.088 \text{ sq. ft.}$$

Mid-section

For mid-section take mean of the dimensions of the two sections given above.

$$[1] = 8.14 \times 3.00 = 24.42 \text{ sq. ft.}$$

$$[2] = \frac{2.097 \times 7.273}{2} = 7.635 \text{ sq. ft.}$$

$$[3] = \frac{(3.00 + 2.146 + 2.646) \times 9.308}{2} = 36.264 \text{ sq. ft.}$$

Total area = $2 \times (24.42 + 7.635 + 36.264) = 136.638$ sq. ft.

Volume of prismatoid between bridge seat and bottom of slab

$$\text{opening} = \frac{7.365}{6} \times (79.088 + 4 \times 136.638 + 206.97) = 1022.00 \text{ cu. ft.}$$

Fig. 7 and Fig. 8 show base and top, respectively, of the parapet to right and to left of slab opening. The volume of these two small sections when solved for by prismoidal formula gives $V =$

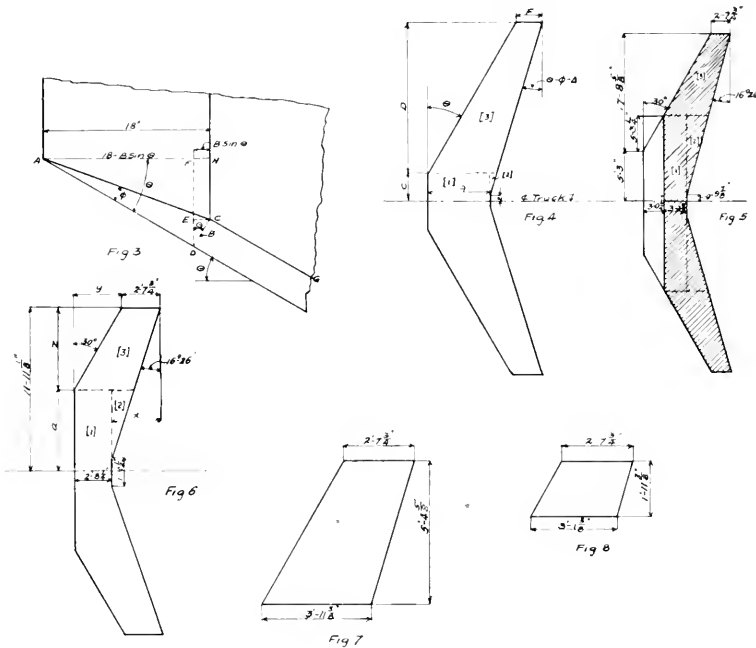

$$2 \times \frac{2.292}{6} \times (5.61 + 4 \times 11.33 + 17.75) = 52.47 \text{ cu. ft.}$$

Total neat-work then equals

$$\frac{(15083.766 + 9579.390 + 1022.00 + 52.47)}{27} = 953 \text{ cu. yds.}$$

Total footing volume by same general method can be easily computed.

Footing volume = 175 cu. yds.

The preceding computations have been made with what may seem to be unnecessary precision. In maintenance of way, reconstruction and other railroad work where company forces are

employed refinement in computations as great as has here been used will seldom be required, but in new construction work where quite frequently the bridge work is done by contract the computations for masonry quantities cannot be made too accurately and carefully. If approximate quantities only are required the work can be very greatly simplified by using the average end-area method instead of prismoidal formula, but the results arrived at in this way will be in excess of those determined by the prismoidal formula. When speed is of greater moment than accuracy approximations even greater than the average end area can be resorted to. But, knowing the accurate method, for the method outlined in this article is absolutely accurate, the approximate methods will be apparent and can easily be developed.

THE CIVIL ENGINEERING TRIP TO CHICAGO

W. CLIFFORD SADLER, '13.

The senior class of the civil engineering department made its annual inspection trip to Chicago during the week of October 30th. The party, consisting of fifty students and professors Baker, Malcomb, Dufour and McDaniel, left Champaign for the north early Wednesday morning. A special car was chartered on the Illinois Central and upon its arrival in Chicago, the party made its headquarters at the Palmer House.

The men first inspected the mechanical plant of Sears, Roebuck, and Company. Guides took the party around to different departments, and explained the systems of management and operation. The apparatus for determining the quantity of smoke in the flue gases was pointed out, one of the guides telling what were the requirements of the city ordinance on the smoke annoyance, and how the instruments recorded whether the flue gases were fulfilling these requirements or not. He next showed and explained an instrument for the determination of carbon dioxide. He explained how the greater the per cent of carbon dioxide, the greater the economy of the plant, but that with an increase of the per cent of C. O., the smoke so increased that a high economy was prevented by the above ordinance on the smoke annoyance. The next thing to be observed was the mechanical stokers of the boiler plant. They were of a green chain type, similar to the ones used in our power house here. In connection with the feeders was an operation wherein old paper boxes and useless advertising literature were carried by belt conveyors to mechanical shredders to be cut up, and then by mechanical draft through a pipe on to the grate of the fire.

As the guide swung open the door and the party entered the corridor leading from the boiler room to the engine room, the hum of the machines ahead could be heard. Perhaps as the men walked down the corridor they formed a mental picture of what the room at the further end of the hall would look like, for when they entered the room they seemed quite surprised at the magnitude of the entire layout. The Corliss engines, generators, pumps and all seemed larger than they anticipated. Everything from polished brass railing to the white floor, bespoke perfect cleanliness, and the men seemed greatly pleased with the general ap-

pearance. The morning's trip was finished by a visit to the large fans which furnish ventilation for the ten thousand employees. At noon we had luncheon at the invitation of the company.

In the afternoon several buildings in progress of construction were visited. In everyone of the buildings the two-way reinforced concrete flat slab construction was used, in preference to the girder construction. The party was under the direct guidance of Mr. T. L. Condron, the designing engineer of the three jobs. He explained his principle of steel reinforcement, and then brought to notice such details as the repeating steel forms for the columns, and the surface finished secure by a special grout wash. One interesting thing was the test load of cement put on floor. Rods, graduated to thousandths of feet, were suspended from the ceiling to the floor below so that a levelman could detect deflections of the loaded floor by the different rod readings from day to day. Mr. Condron was most accommodating in answering the questions of the fellows, and he received very favorable comment as a result.

In the evening the men gathered together at the Western Society of Engineers' Club rooms for a smoker. A little program was arranged and several officers of the society, and prominent engineers in Chicago gave stories of their college days or of camp life many years ago. The usual refreshments were served during the entertainment and before the party broke up every man expressed himself as having had a fine time.

Thursday forenoon the party visited a plant of the American Bridge Company. This proved unusually interesting to the men as it furnished something concrete and definite on what a man might expect to do, should he deserve to work in a drafting room. In the shops on the other hand, one was given the opportunity of seeing in practice what he had studied in the class room. The unusual interest the fellows took in going around to the different machines showed that they appreciated the opportunity.

Thursday noon the party had luncheon at the Boston Oyster House with the Alumni. The football men stopped there on their way to meet the University of Minnesota team on the following Saturday, and everybody had a jolly time giving songs and yells.

Friday forenoon a trip was made to the South Chicago Steel mills. The party saw three large Bessemer furnaces charged, operated and emptied, the sight being one of the most spectacular of the trip. In one building there was a long row of open hearth

furnaces, several being charged as the party came up. In the rolling mills there were plates, rails, and channels in the progress of shaping. The particular part that most interested the men was the operation of the rollers, which could be revolved in either direction and which should be lowered or raised in tiers. In spite of its vastness and complications the work went on without a slip during the entire length of the trip.

Friday afternoon the party visited the Gibbon, Lytton and Continental-Commercial Bank buildings. In the Gibbon building the steel was partly in place and the tile flooring was over half done. The fellows inspected the steel details, noticing in particular the connections, stiffness and wind bracing. The work here was closely connected to the class room work on detailing so they were especially interested. In the Lytton, the work involved considerable excavation and the men went down into the subcellar to see the system used. The Continental-Commercial Bank building was perhaps the most interesting. Large caissons were in construction which went down one hundred and five feet below street level. The lower half was filled with cement, then came the grillage followed by the steel work. The size of the caissons seemed to indicate that the building would stand for many years. In this connection of age of buildings, it might be interesting to note that during the destruction of the old building, the workmen had to take up the old foundation. This was composed of about six tiers of railroad, each tier running at right angles to the bed below and all encased in a bed of concrete. This foundation appeared to be as good as when it was installed twenty years ago.

Saturday the party took a tug boat and visited the intake cribs in Lake Michigan, four miles from shore. The masonry construction was examined and the general arrangement of the facilities was noticed. The party returned to shore about the middle of the afternoon and then disbanded. The men were very well pleased with the tour, and satisfied that they had acquired a considerable number of points on the practical side of engineering.

The **TECHNOGRAPH** believes that its value to you as a student will lie wholly in the fact that it represents *your* interests. Hence it earnestly solicits contributions from the students

STUDENT If you have any original or interesting ideas on
ARTICLES any engineering subject write them up and drop in our office, Room 100. It's up to us all, as participants in our magazine, to boost it all we possibly can, and this is one of the very best ways to do this.

From an editorial in the February number of the "Wisconsin Engineer" on Thesis Work we have noted the following: "It is the usual experience of students starting their thesis work that they do not know how or where to begin, especially if the problem be of the nature of research work. . . . Perhaps for the first time the undergraduate finds it necessary to consult the original literature of a subject. . . . Perhaps, too, the student will first meet contradictory statements and opinions and it becomes necessary to judge for himself of the accuracy of the opinions or observations of others. The necessity for doing the work in such a way that he can safely draw correct conclusions is an additional incentive to careful and painstaking effort on the part of the student. . . . The thesis training which develops initiative, self-reliance, patience and perseverance is certainly worth while. . . ."

Whatever measure of success we shall be able to reach, must after all, be credited to the patronage of our advertisers. A firm advertises in the belief that this action will produce results. We represent reliable and successful advertisers and respectfully ask you to help us show them that **THE TECHNOGRAPH** does produce results.

Do we, as Engineering students, want the honor system introduced? **THE TECHNOGRAPH** believes that the general sentiment is, that we do. What are your own opinions?

HONOR The next number will contain a discussion of this
SYSTEM increasingly vital subject and so every student who has given the question some serious thought is urged to send his opinions in.

COLLEGE NOTES

THE ENGINEERING COLLEGE

Registration figures from the College of Engineering show a great predominance of freshmen. This class has a total of 354 members, while the junior class, which is the closest competitor, has but 287. Following these come the sophomores with 285 and the seniors with 210. In addition to these there are 13 specials, making a total of 1,149 students not including those registered in the Graduate School.

Among the various courses, architecture and architectural engineering lead with 334; the others in order of numbers are, electrical engineering, 280; mechanical engineering, 253; civil engineering, 213; mining engineering, 26; municipal and sanitary engineering, 23; and railway engineering, 20.

Professor A. N. Talbot, of the department of theoretical and applied mechanics, has recently returned from attending a meeting of the sixth congress of the International Association for Testing Materials, which has been holding sessions in New York with excursions to Washington, Pittsburgh, and other points of interest. Professor Talbot is an influential member and officer of the congress.

GERMANS USE ILLINOIS BULLETIN

In the number of the "Elektrotechnische Zeitschrift" for September 26, 1912, appears an article by Mr. T. D. Yensen, on "Starting Currents of Transformers, With Special Reference to Transformers With Silicon Steel Cores". The article is a detailed abstract of a bulletin published by the Engineering Experiment Station, with the same title, which was issued last spring.

An Illinois graduate, Walter Burley Griffin, has found the capital of Australia and is just now the recipient of a large amount of newspaper publicity and public comment. He has won the first prize in an international competition for the design of a federal capital for Australia.

Recently a world-wide contest was opened with a prize of \$8,750 for the best plans submitted in accordance with which a

capital city could be built. The winning plans were drawn up by Walter Burley Griffin, '99, a Chicago landscape architect, and according to the "Independent", "The honor of having produced the winner of this world-wide competition goes to the University of Illinois, which is known to possess one of the most enterprising architectural schools in the west".

Under the caption, "Hunting For The Capital of Australia", the Independent for September 10, gives a detailed and profusely illustrated account of the contest, the winners and the plans submitted.

For many years the British government attempted to find a suitable location for the seat of the government and until recently Australia has been a country without a capital. The proposed site is now at Yass-Canberra, about two hundred miles from Sidney.

Walter Burley Griffin was a graduate of the department of architecture in 1899. While an undergraduate here he was known as a stellar student.

Other evidences of Mr. Griffin's ability, on a smaller scale, are the planning of the grounds of the Northern and Eastern Illinois State Normal Schools.

The Midvale Steel Company of Philadelphia has presented to the railway engineering department four axles and four pairs of supporting wheels for the new locomotive laboratory.

These wheels and axles constitute one of the most important and costly elements in the locomotive laboratory equipment. The gift is an unusual expression of interest in the railway department work.

The axles and wheels are made of heat treated steel of unusually high grade, and represent the finest product of this sort obtainable. The monetary value of the gift is \$2,700.

The municipal and sanitary engineers while on their trip to Chicago Friday, November 8, visited the plant of the Chicago sanitary district experimental sewage purification, as special guests.

DEPARTMENT NOTES

ELECTRICAL ENGINEERING DEPARTMENT

DR. STEINMETZ DELIVERS TALK BEFORE ENGINEERS— LARGE CROWD GREETED NOTED EXPERT—LEC- TURES ON THE POTENTIAL OF THE ELECTRICAL CIRCUIT

A crowd that filled the physics lecture room to overflowing heard Dr. C. J. Steinmetz, foremost electrical authority of the world, deliver a lecture recently. Dr. E. J. Berg, of the electrical engineering department, in opening said that Doctor Steinmetz needed no introduction as he was well known to most of the students, having lectured here several times before.

Doctor Steinmetz spoke on the potential of the electrical circuit, and his talk was principally on abnormal voltage and high frequency in the circuit and how to take care of these. He stated that lightning always had abnormal voltage and discussed two principal types of lightning arresters. The protection that alternating current transmission lines require from discharges of lightning is done by aluminum arresters.

The multigap arrester is all right for a single discharge but not for a series of discharges as in such a case it would be melted down, according to Dr. Steinmetz. But the aluminum cell arrester furnishes a counter electromotive force which cuts down the current to the very small transient current of the line.

Such an arrester can stand discharge for hours, although it requires much more attention than a multigap arrester. It must be subjected daily to the circuit voltage in order to reform the film which causes a counter electromotive force, the film cutting down the discharge current. This sort of arrester is used to protect important parts of a system, while the multigap arresters can be used for ordinary installations.

Protection must be afforded also against high frequency of a current. For instance, a high frequency current reaching a transformer inside the station will cause large electromotive force locally, between the terminals of the transformer. If we interpose a reactance between the transmission line and the apparatus in the station, the high frequency surge will cause the voltage to rise between the first few turns of the reactance, but we will not

have the enormous voltage arising which would otherwise result if the high frequency was impressed upon the transformer.

Electric waves travel along a circuit in the same manner as waves do in water, said the speaker. Thus the use of inductance in an electric circuit stops the traveling wave and reflects it upon itself, and makes a standing wave in the line. So an inductance is interposed between the line and the apparatus to be protected, and stops the traveling wave, but it does not stop the standing wave, which little by little builds up on the station side of the reactance. Therefore, in this case, the reactance serves only to retard the building up of high voltages inside the station.

A regular meeting of the E. E. Society was held in the Electrical Engineering Laboratory on Friday evening, November 8, at 6:45. A. B. Van Deusen gave a demonstration of the oscillograph, after which there was a short business meeting.

Several additions are being made to the equipment of the engineering laboratories. An entire car load of machinery which is to form a part of the equipment of the locomotive laboratory arrived on the grounds and will be installed as soon as possible.

A new 100 kilowatt, 200,000 volt transformer, arrived at the testing laboratory. It was built to order for the University by the General Electric Company, and is to be used in high potential tests. Owing to the extreme weight of the machine, about 56,000 pounds, some difficulty in installing was feared. A new storage battery with a capacity of 240 ampere hours has also been added to the equipment of this laboratory.

Over three hundred were present at the electrical engineering meeting and feed in the E. E. laboratory. Dean W. F. M. Goss and several members of the faculty and prominent students made talks. Dr. E. J. Berg told the purpose of the department in giving their annual feed. He said:

"The object of this gathering is largely to familiarize the freshmen with the ways of the electrical engineering department and especially with the system in appointing an adviser for each freshman. This is the only department of the University which util-

izes the scheme, the idea being to help each of the new men individually.

"In order to keep up interest of the freshmen and sophomores, a series of demonstration lectures will be given every two weeks during the year.

"I wish to impress upon the freshmen the fact that if they only take their first year algebra seriously they will find no difficulty throughout the course."

After the speech, the electrical engineers were given a bountiful feed and taken on a trip of inspection through the building. Plans for the E. E. Show were discussed.

ELECTRICAL ENGINEERS GO FOR ANNUAL INSPECTION

The electrical engineers will leave on their annual inspection trip on November 24, over the Illinois Central, bound for Keokuk, where they will inspect the new power dam being constructed across the Mississippi river. They will spend all of Monday at the dam.

Tuesday they will spend the day inspecting the Washington and Commonwealth Electric Company's plant in Chicago. Wednesday the time will be occupied at the Illinois Steel Plants in South Chicago. It is thought that there will be over sixty students who will take the trip.

E. E. FEED

The Electrical Engineering Society gave its annual feed on October 4, 1912, in the E. E. Laboratory. The feed was exceptionally well planned by the committee consisting of L. A. Dole, N. P. Heath, L. C. Kent, H. C. Hohman, and C. H. Kessler.

Two new features were tried and proved to be successful. A reception committee consisting of seniors was appointed to see that every man present met the faculty and students. To get the freshmen and sophomores familiar with the laboratory and its equipment five seniors were on hand to conduct them through the building explaining every thing in sight.

The applications for membership were so numerous that the treasurer had to call on some assistants to help him fill out blanks and make change. The membership was doubled that night. The total being about 175 members.

When about 200 had gathered in the main room the bread line

was started. Ice cream cones, peanuts, apples, gingerbread and cider were on hand in sufficient quantity to supply the desires of every man present. The arrangement to dole out the eats was so efficient that the usual rush was avoided. From the "free lunch" room the crowd was lead to the lecture room where the talks were given.

President D. C. Wood opened the program by a welcome to the audience which was larger than the seating capacity of the large room. The first talk was given by Dean W. F. M. Goss expressing the interest of the A. I. E. E. in the E. E. Society, and the electrical engineering students in general. He explained what the two societies stood for and the part each man should take in each.

Dr. E. J. Berg followed with an interesting discussion of mathematics and its importance in engineering. Mr. R. S. Seese spoke on the possibilities of an electric show here this year. Impromptu speeches were made by L. V. James, H. G. Hake, S. P. Farwell and all faculty men.

At a late hour the meeting came to a close and another round of the bread line was made. The most successful E. E. feed for years was over, every man felt more interest in the department and the society than ever before.

MECHANICAL ENGINEERING DEPARTMENT

Only eighty per cent of the junior mechanical engineering class of last year are back this year and only seventy-five per cent of this number will graduate. The class numbers just twenty-two which is the smallest senior mechanical engineering class that has been here for some time.

No definite reason can be given for this decrease in mechanical engineers. In many cases poor scholarship had much to do with the men dropping out. Some of the juniors of last year are now registered in other colleges.

A number of the faculty members of the College of Engineering have been heard to remark that this class has had the poorest scholarship of any other class that has graduated. The class has gradually fallen off in numbers since its entrance in 1909.

The junior class in mechanical engineering this year is the largest that has been registered. This class has lost very few of its freshman number.

A bond tester and recording table was built this summer in the machine section of the Engineering College, to be used in the electric test car. This machine was designed by Professor A. M. Buck of the railway engineering department and records the speed and record of uses of different currents, and tests the bonds of electric lines.

The recording table was built entirely in the University laboratories, including the patterns, and represents a grade of workmanship that cannot be excelled in any other laboratory. The work was completed with half the cost and time that it would take in most commercial shops.

The work was under the supervision of G. H. Radebaugh and D. L. Scroggin, instructors in the machine laboratory. The machine is on exhibition in the laboratory.

A new hydraulic resistance dynamometer is being built in the machine laboratories. The dynamometer was designed by Professor C. R. Richards of the mechanical engineering department and is built on different principals than any other on the market. The resisting medium is to be water instead of copper plates, separated by a layer of oil, as used in the testing laboratories at present. The new machine will be tested and used in the gas engine testing department, and if it proves satisfactory will be a regular product of the machine laboratory.

STUDENT BRANCH OF THE A. S. M. E.

On October 4th, the society gave its first feed of the year. An exceptionally large crowd turned out. The special feature of the entertainment was an engineering orchestra composed entirely of mechanical engineering students. Among the speakers of the evening were Dean Goss and Professor Richards, who spoke about the aims of the Society and its value to the mechanical engineering student.

C. R. Velzy gave an illustrated talk on the life of James Watt at the meeting on October 25.

"The Slide Rule" was the subject of an interesting and instructive talk by Mr. A. S. Buyers at the meeting on November eight.

A house-to-house canvas was made of all the mechanical engineering students with the result of quite materially increasing the membership.

The new 8x18 inch Corliss engine installed during the past spring is now in good running order and will soon be used by the Engineering Experiment Station in a series of tests in which a mixture of steam and hot air is to be used in place of the ordinary wet steam. The air is to be heated in a preheater and will be mixed with the steam before entering the cylinder.

The Ideal High Speed Engine originally in the power plant, was rebuilt and a throttling governor added to the centrifugal shaft governor. The two are independent so that one can be operated at a time, and tests can be made comparing economy of the different methods of governing with different ranges of load.

Two new Chandler and Taylor steam engines are being installed. They will be coupled to the same shaft and may be run as a compound engine, one cylinder taking the partially expanded steam from the other.

A Fairbanks Morse pumping engine of 300 gallons per minute capacity with compound steam cylinders and duplex plungers has been added to the laboratory. In connection with the pump a Lea Water Recorder of the "self-contained" pressure type is being installed. The latter records automatically the flow of water by means of a V-notched weir and automatic recording advice.

The new C. H. Wheeler surface condenser has arrived. It has 450 square feet of cooling surface, and is fitted with a fly wheel air pump and motor driven circulating pump.

In order to make possible the use of the York refrigerating equipment for short laboratory tests, a new brine-ammonia coil has been installed. The coil consists of a double pipe one inside the other, one of the pipes carrying ammonia and the other the

brine. By means of this arrangement the amount of brine circulated, along with the heat extracted from it may be obtained for any length of time, thus making short tests possible which were not practical when the entire brine tank had to be cooled.

The fourteen horse power Bogart Gas Engine has been set up. It is unique in having an adjustable piston rod and a cross-head. The adjustable piston rod makes possible different degrees of compression by changing the clearance of the engine.

A reducing mechanism designed by Professor Richards and made in the machine shops was recently attached to the new Corliss engine. A shaft in which a spiral groove is cut is mounted along the side of the engine. A wedge-shaped pin extends out from the cross head and works in the cut groove. Thus the straight line motion of the piston imparts a circular motion to the shaft. A sector clamped onto this shaft transmits the motion of the indicator by means of a short cord.

The department of Mechanical Engineering has been fortunate in securing for members of its faculty the services of the following men:

Mr. Brainard Mitchell, a graduate of the University of Arkansas and until this year associate professor in mechanical engineering in that institution, is now instructor in machine design.

Mr. Herbert S. Eames, a graduate of the Massachusetts Institute of Technology, and for the past three years instructor in mechanical engineering at the Rhode Island College, Kingston, R. I., has been appointed instructor in experimental mechanical engineering.

Mr. E. B. Flanigan, assistant in the M. E. Laboratory is a graduate of Princeton 1910, and of the Massachusetts Institute of Technology 1912.

Mr. J. P. Pendleton takes the place of Mr. Gawn in the Foundry. He is a man of considerable experience having been with the Newport News Shipbuilding Co, at Newport News, Va., for several years. He is a graduate of the Winona Technical Institute at Indianapolis.

Mr. Walter Wohlenberg is this year's fellow in the Engineer-

ing Experiment Station. He is a graduate of the University of Nebraska and for the last two years has been in the employ of the Westinghouse Machine Company.

Mr. Wm. V. Dunkin, former instructor in machine design, is now with the Deere Company of Moline.

Mr. John M. Snodgrass has been transferred from assistant professor in steam engineering in the mechanical engineering department to be assistant professor in railway mechanical engineering.

Mr. J. Paul Clayton has resigned in the Engineering Experiment Station, and is now with the Central Illinois Public Service Corporation at Mattoon, Ill.

CIVIL ENGINEERING DEPARTMENT

Fifty-two senior civil engineering students in charge of Professor I. O. Baker and three other professors of the civil engineering department made the annual inspection trip to Chicago. The party was the guest of Sears, Roebuck & Co. for luncheon.

On October 30 they were given a smoker in the rooms of the Western Society of Engineers, to which all civil engineering graduates were invited. A considerable number of the prominent engineering alumni of Chicago were present.

On Thursday, October 31, the party took lunch with the Illinois alumni at the Boston Oyster House. On Saturday morning the students were guests of Assistant City Engineer Baker on a trip to the lake cribs and the city water supply; and in the afternoon they were the guests of Mr. Hammond, city bridge and harbor engineer, for a trip in his steam launch down the south branch to inspect the movable bridges.

In addition the party inspected bridges on the main branch of the Chicago River, steel-frame buildings in the loop district, bridge manufacturing the steel works at South Chicago and three re-inforced concrete buildings near Sears, Roebuck & Co's plant.

The party made their headquarters at the Palmer house while in Chicago. The following men made the trip: Professors Ira O. Baker, F. O. Dufour, C. W. Malcom, and A. B. McDaniel, and the following seniors: R. H. Albright, W. O. Andrews, N. Arnold, R. A. Bennett, P. T. Bock, E. W. Bullard, N. L. Bunn, H. Corley, C. J. Cragmile, H. W. Dahringer, A. L. Epstein, E. M. Fijardo, A. S. Fry, W. E. Flood, C. M. Fuller, W. C. Giessler,

M. R. Hansen, E. J. Healy, E. N. Heidkamp, T. McD. Hepburn, C. T. Holton, R. F. Huxmann, W. Karkow, A. W. Kimbell, S. F. Kosters, F. X. Loeffler, K. T. Murphy, M. Osmena, H. Petersen, H. C. Petersen, R. G. Petersen, F. J. Prindiville, E. E. Reddersen, E. A. Reed, H. E. Reum, F. C. Rohrbough, E. Rundles, W. C. Saddler, G. S. Sangdahl, G. H. Stough, E. H. Swensen, M. P. Taylor, R. E. Turley, E. Wallace, L. G. Wheeler, J. M. Whelan, J. G. White, C. E. Whitney, R. C. Williams, C. R. Wold.

ENGINEERS' TRIP SUCCESSFUL—HOLD SMOKER WEDNESDAY NIGHT WITH TRUE SPIRIT

The annual inspection trip of the senior civil engineering students has been particularly successful, according to the reports received from Professor I. O. Baker, who is in charge of the trip.

On Wednesday night a smoker was held in the rooms of the Western Society of Engineers. W. L. Abbot, '84, former president of the board of trustees and also former president of the Western Society of Engineers, acted as master of ceremonies. The president of the Society and ex-president made short speeches as did Mr. Pastel, president of the Chicago Illini Club, and Mr. Peter Junkersfeld, president of the Alumni Association. Messrs. Fuller and Turley, of the senior civil engineering class also made short talks.

A considerable number of the leading members of the society and prominent engineering graduates attended the smoker. Smokes, cider and gingerbread were served at the smoker. Music contributed by Mr. Abbot, was furnished by a ten-piece orchestra.

MINING AND CERAMICS DEPARTMENTS

HUNTS FOR COAL LANDS

R. Y. Williams, mining engineer for the United States Bureau of Mines at the University, has been spending the last three months in Alaska in search of coal lands in the Behring district. The investigation is made for the United States Navy in an effort to locate coal supplies which can be used for coaling the battle-ships on the Pacific coast. It is the desire to get the coal from the West rather than to send the big ships East. Mr. Williams has had two camps established with forty men under him.

The mining engineering department has just purchased for the new laboratory a battery of three gold stamping machines each weighing 500 pounds, a "Challenge" ore feeder, and two silver-plated copper plates for catching the gold crushed in the battery.

A clay working plant for use in experimental work is to be a part of the equipment of the new ceramics laboratory. With the machine running at full capacity it would be possible to make about fifteen thousand bricks per day. The cost will be from two thousand to twenty-five hundred dollars.

This plant will be complete for all ordinary purposes. It will contain machinery for making ordinary brick, drain tile, hollow blocks, roof tile, and practically all kinds of clay work.

The machinery used in its construction will be purchased from various companies in order to demonstrate the comparative efficiency and merits of the different makes of machinery. One of its uses will be the testing of the workability of different clays.

The clay plant will occupy a floor 20 by 40 feet not including kilns, and will require about fifty horse-power for its operation. It will be run by electricity.

MINING ENGINEERING

The Department of Mining Engineering has moved into the new Transportation Building and now occupies the south end of the second floor. There is a large drafting room equipped with desks, a complete set of catalogues of the manufacturers of mine machinery and a card index of the same, a very complete set of blue prints of mine maps, mine structures and the principal text and reference books upon mine buildings.

The mine lecture room is equipped with a chemical table for demonstration of safety lamps and mine gases, etc. There is also a stereopticon and in an adjoining room there is a museum of mine appliances.

The ventilation laboratory contains a dark room and an Oldham gas testing machine, a very complete set of safety lamps, and a complete equipment of testing apparatus for work with mine gases. The offices of the mining faculty are in the southeast corner of the building on the second floor.

During the summer of 1912 a systematic sampling of the mines in Illinois was carried on in connection with Co-operative Investigation of Mining Conditions in the State by the Department of Mining Engineering, in State Geological Survey, and the United States Bureau of Mines. Six seniors and juniors in mining gathered samples from about 100 mines throughout Illinois and these were shipped to Urbana where analyses were made by the chemical department. These analyses included the approximate analysis and determination of calorific power. These results in addition to the analyses already in the possession of the State Geological Survey and of the University will furnish a large amount of valuable data in regard to the coal resources of the State, which was not formerly to be had.

During the summer in connection with the work of the Co-operative Investigation, Mr. H. H. Lauer, Instructor in Mining, visited a number of mines in Illinois, gathering samples of the cuttings made by various types of mining machines. These cuttings were sampled and screening tests are being made to show the sizes of coal made by different machines working under different conditions. In addition to gathering the samples, electrical instruments were used to record the amount of power used by different machines working under different conditions. This data will be published in the form of a bulletin to be published by the Co-operative Investigation.

During the summer vacation of 1912, Dr. F. C. Lincoln, Assistant Professor in Mining, made a detailed study of the coal washeries in Illinois, gathering material for a bulletin, which will be published in the near future as one of the series being issued by the Engineering Experiment Station. At each washery visited, samples were taken of the different sizes of coal being washed; these samples have been analyzed, and are being placed in the museum of the Mining Department, so there will soon be a complete exhibit of the washed coal being put out by all of the washeries of the State. The bulletin will include a bibliography of coal washing in Illinois, and a general study of the entire problem of washing as applied to the coals of the State.

During the summer vacation, Professor H. H. Stoek of the Mining Department made a detailed study of secondary mining education as it is being carried on in the various parts of the United States, gathering material for a bulletin upon the subject, which will be issued in the near future.

During the summer several of the juniors in mining engineering worked in the copper mines of Arizona and report having had a most valuable experience, as they were assigned to all classes of work about the mines.

On Thursday evening, November 7, the University of Illinois Student Branch of the American Institute of Mining Engineers held a smoker in the smoking room of the Y. M. C. A. Among the guests were Dean Goss, Professors Stoek, Lauer and Savage, Doctors Lincoln and MacFarland, and Messrs. Willis, Kay and Andros. The principal speaker of the evening was Dean Goss who spoke on the value of student gatherings. Professor Stoek and Doctor MacFarland gave interesting talks about mining swindles. Mr. Willis gave a lengthy discourse upon precious ore mining in Mexico. Professor Savage and Mr. Kay entertained the audience with a number of witty stories. An abundance of good eats, smokes, and drinks aided materially in making the affair a success.

Professor H. H. Stoek, head of the mining engineering department, entertained the students and faculty of that department on Thursday evening, October 24, at his home on Oregon St. Practically all the students in that course were present, and among the guests were Dean Goss, Professor Lauer, Doctor Lincoln, Mr. Andros, mining engineer for the state, and Mr. Scholl of the U. S. G. S. The juniors and seniors gave short talks describing their summer experiences as did Dean Goss, Professors Stoek and Lauer, and Mr. Scholl. Refreshments were served and a very delightful evening was enjoyed by all present.

W. LERICHE, '13.

MINING ENGINEER FACULTY TO GIVE ANNUAL SMOKER

A smoker was to be held November 7 for students and faculty members of the mining engineering department. It was in the Y. M. C. A. smoking room, starting at 7:30. The smoker was given by the members of the faculty in mining engineering to the students in these courses, and was free to them.

Dean W. F. M. Goss was the principal speaker of the evening. H. H. Stoek, head of the mining department and Frank Kay, an

officer of the state mining department, also talked. A musical program was also planned. A plentiful supply of smokes and eats was furnished.

CHEMISTRY DEPARTMENT

The opening of the new year brings many changes to the Chemical Department. We regret the loss of many of the instructional staff who have long been connected with the institution.

Doctor Hawk left to become a member of the staff of Jefferson Medical College. Doctor Curtis went to Pasadena, California, on the Throop Polytechnical Institute faculty; Doctor Burgess to Saskatchewan University, Saskatoon, Canada; Doctor Jesse to the University of Montana; Doctor Jones to Harvard; Doctor Hoew to Columbia; and Doctor Isham resigned.

Our new faculty members are Doctor Weber, who takes Doctor Smith's place in qualitative chemistry. Doctor Smith takes the place left open by the leaving of Doctor Burgess. Doctor Thorpe takes Doctor Derick's place, who in turn takes Doctor Curtis's place. Doctor Hirschkind fills Doctor Jesse's place. Doctor MacArthur comes to Doctor Hawk's position. Doctor Nelson works in Chemistry one and Doctor Hopkins is also working in that department. The student assistants this year are Miss Darrah and Messrs. Valentine, Becker, Dunham, Prasil, Glenz, S. C. Taylor, Lievert, Simpson, Leslie and Cohn.

Anton Kessler has been made an assistant in Glass Blowing.

The Chemistry Club held its first meeting on October first. The returning members were greeted by a generous supply of "eats" and all had a jolly good time. On October 8, 15 and 16, Miss Sparks, the Chemistry librarian, gave some interesting talks on the use of the Library. On October 22 Professor Noyes described some of the European laboratories and the various researches he saw on his trip. Mr. Seevert accompanied by Mr. Swanson filled out the evening pleasure with a violin solo. On November 12 Professor Parr and Mr. Burton took up the question of Coal Wastes. Music was also provided for the evening.

GEO. MENGEL, *President, Chemistry Club.*

Six representatives from the department of the University recently attended the eighth annual international congress of applied chemistry, which met in Washington and New York City, during the second and third weeks of October. The congress met

at Washington, where it conducted business for several days; after which it adjourned to New York City.

It is reported that this congress was the most successful one ever held. Delegates from the majority of foreign countries were present in addition to representatives from all parts of the United States. After the adjournment of the congress many of the foreign delegates continued their visits and investigations throughout the country.

All of the University delegates read papers before the congress on subjects of various interests. A paper by Dr. S. W. Parr discussed some of his researches for the production of a new alloy. It was commented on and quoted in the last number of *Popular Mechanics*.

PARR GOES TO SPRINGFIELD

Professor S. W. Parr, of the chemistry department, leaves today for Springfield to confer with the state board of administration in regard to the inspection of coal supplies for the state charitable institutions. Later in the year Justa Lindgren, under whose direction the tests are to be made, will visit each of the eighteen institutions.

Charles Rascher, '12, of Chicago, who graduated here in chemical engineering, has accepted a position as instructor in the Catholic University of America in Washington, D. C. Mr. Rascher will teach chemistry. The university is one of the largest Catholic Colleges in the United States.

THESIS SUBJECTS IN THE COLLEGE OF ENGINEERING 1912-13

ELECTRICAL ENGINEERING

Coffey, E. W. }	A Study in Illumination.
Ralston, S. A. }	A Study of Striking Distance.
Coolidge, E. R.	Methods of Starting Motors.
Dole, L. A.	A Study in Illumination.
Ferrell, D.	Corona in D. C. Circuits.
Fornoff, G. G.	A Study of Striking Distance.
Gates, C. W.	
Wood, D. C. }	Power Requirements of Industrial Machines.
Greves, G. L. }	
Hall, L. M.	Methods of Starting Motors.
Henry, P. C.	Design of 1000 K. W. Turbine Set.
Hohman, H. C.	A Study in Illumination.
Horrell, C. R.	The "E. E. Show".
Kent, L. C.	A Study in Illumination.
Kessler, C. H.	Electric Constants of Steel Conductors.
Kramer, J. }	The Primary Cell as a Source of Power.
Richi, H. L. }	
Lee, E. S. }	Installation and Description of U. of I.
Wittich, F. P. }	High Potential Laboratory.
Matthews, H. }	
Wolf, H. C. }	Dielectric Strength of Air.
Mesner, F. D.	Insulators and Transformer.
Ogden, P. L.	Connections in Modern Transmission Lines.
	Power Plant Design.

CIVIL ENGINEERING

Andrews, W. O.	Review of Methods of Garbage Disposal.
Bennitt, R. A.	The Construction of the Madeira-Mamoré Ry.
Bullard, E. W.	Construction of an Artificial Lake in an Amusement Park.
Bunn, N. L.	Design of a Railroad Bridge for the C. & A. Ry.
Corley, H.	Study of Concrete Mixers.
Cragmile, C.	An Irrigation Project.
Dahringer, H.	Design of a Reinforced Concrete Coaling Station.
Fajardo, M. E.	Design of a Reinforced Concrete Water Tower.
Hansen, M. R.	Design of Buildings for a Brick Yard.
Healy, E. J.	Design of Steel Framework for an Office Building.
Holton, C. A.	Roads for Motor Traffic.
Karkow, W.	Reinforced Concrete Highway Bridge Floors.
Kosters, S. F.	Investigation of the Wabash R. R. at Danville, Ill.
Murphy, K. L.	Methods of Making and Placing Concrete.
Osmensa, M.	Design of Reinforced Concrete Arch Bridge.

- Peterson, H. Design of Steel Framework for an Office Building.
- Petersen, H. C. Comparative Design of a Steel and Concrete Highway Bridge.
- Peterson, R. G. Construction of Pavements to Meet Modern Traffic.
- Prindiville, F. Weight of Steel per Unit of Volume in Skeleton Frame Buildings.
- Reed, E. A. Comparative Design of a Steel and Concrete Bridge, for Sidney, Ill.
- Reum, H. E. Construction of a Department Store Building.
- Rohrbough, F. C. Improvement of the Boneyard.
- Swenson, E. H. Reinforced Concrete Design.
- Wallace, E. Strauss-Trunnion Bascule Bridge.
- Wheeler, L. G. Improvement of the Boneyard.
- White, J. G. Review of the work of Various Highway Commissions.
- Whitney, C. E. Preservation of Timber.
- Williams, R. C. Design of Steel Grand-Stand.
- Wold, C. A. Design of a Concrete Arch with Fixed Ends.
- Albright, R. N. Reinforced Concrete.
- Bock, P. T. Column Lacing.
- Flood, W. E. Design of a Water Supply for Springdale Cemetery, Peoria, Ill.
- Fry, A. S. Tests of Columns.
- Hepburn, T. McD. Loss of Head in Elbows and Tees.
- Kimbell, A. W. Transmission of Pressure Through Sand.
- Sangdahl, G. S. Water Supply System for C. C. C. & St. L. Shops.
- Schmitz, E. A. Reinforced Concrete.
- Taylor, M. P. Transmission of Pressure through Sand.
- Whelan, J. M. Variation in Mechanical Properties of Reinforced Bars.
- Loeffler, F. X. Economic Construction of Conduits.

MECHANICAL ENGINEERING

- Smith, L. G. A Study of the Stub Tooth System of Gearing.
- Ordonez, B. R. Graphical Representation of Rankine Cycle Efficiencies.
- Claussin, A. W. Study of Automobile Clutches.
- Ermeling, L. B. A Study of the Water Rates of Various Prime Movers.
- Reitz, W. R. Determination of the Overhead Charges in Shop Laboratories.
- Skoglund, C. A. Design of a 6 hp. Water Cooled Two Cylinder Gas Engine.
- Crist, E. B. Design of a Water Flow Recorder Whose Flow is Directly Proportional to the Head.
- McLaughlin, J. W. Design of a Vacuum Pumping System for the Chemical Laboratory.

Simpson, A. M.	A Study of the Operating Mechanism for Rolling Lift Bridges.
Ferguson, L. S.	Strength of Wire Rope Fasteners.
Luney, E. R.	
Harris, R. C.	The Effect of Variable Conditions on the Value of "n" in Gas Engines.
Gibbs, P. H.	
Crooks, H. F.	Tests of a Bogart Gas Engine.
Mix, M. I.	
Masters, J. H.	Duty Tests of a Compound Duplex Steam Pump.
McIntosh, H.	
Larsen, L. R.	Tests of a York Refrigerating Machine.
Hawkins, R. R.	
Overmeier, E.	The Power Required in Drilling Metals.
Shapland, E. P.	
Blakeslee, W. A.	Gas Producer Tests With Varying Sizes of Fuel.
Ogle, C. R.	
Myers, A. L.	Comparative Tests of Long and Short Stroke Automobile Engines.
Schoessel, C. A.	

MINING ENGINEERING

Middleton, W. S.	An Investigation of the Gasoline Locomotive for Use in Mines.
Becker, M. L.	A Study and Comparison of the Organization and Methods of Working the Mines.
Nebel, M. L.	The Sampling of Coal.
Smith, C. W.	
Newton, L. V.	Electric Locomotive Haulage in and about Mines.

RAILWAY CIVIL ENGINEERING

Redderson, E. E.	The Concrete Tie on American Railroads.
Sadler, W. C.	The Automatic Block Signal System on American Railroads.

RAILWAY ELECTRICAL ENGINEERING

Welson, H. S.	The Development of the Storage Battery for Traction Purposes.
---------------	---

RAILWAY MECHANICAL ENGINEERING

Young, E. G.	Locomotive Laboratory Tests for the Year 1912-1913.
Wu, Chai Kao	
Prout, F. J.	

MUNICIPAL AND SANITARY ENGINEERING

Arnold, N.	Plan for Experimental Sewage Treatment Plan.
Epstein, A. L.	A Sanitary Survey of the Sangamon River near Decatur.
Fuller, C. M.	The Run-Off Conditions of the Boneyard Branch Drainage Area.
Gressler, W. C.	The Filtration Plant of the Champaign and Urbana Water Co.
Schnellbach, J. F.	Washing of Rapid Sand Water Filters.
Stough, Glenn	Sewage Treatment for Champaign and Urbana.

ALUMNI NOTES

Items of interest are here given concerning our former society members in the hope that they may be of value. In seeking a position it is well to know where the graduates are employed as they can very often be of material use to the student.

Editor

1882

F. B. Maltby, c. e., has severed his connection with Gehren and Dodge, general contractors, and is now with John F. Stevens Construction company, 55 Wall Street, New York City.

1888

The Roberts and Schaefer company, of which Warren R. Roberts, c. e., is president, has removed to more commodious quarters in the McCormick Building, Chicago.

1890

F. H. Clark, m. e., is still general superintendent of motive power of the Baltimore & Ohio Railroad company, and is located at Baltimore, Maryland. He was one of the active men on the executive committee that entertained the international association for testing materials, held at New York City, September 2 to 15, 1912.

James Barr, m. e., has recently bought a large tract of land in central Florida, and is having it cleared, and will this winter plant it to grape fruit. He says he expects eventually to go down there to live, and would like to have some member of the class of '90 as a neighbor.

Professor J. M. White, arch., who was appointed one of the commissioners to represent Illinois at the Panama-Pacific exposition, visited San Francisco in June to select a site for the Illinois building. While on the coast he visited Los

Angeles, Portland, Tacoma, and Seattle, and met nearly a hundred old University people. Professor White has recently been appointed chairman of the committee on tests of the American Society of Plumbing Inspectors and Sanitary Engineers, and was the first week in August a delegate from that society to the fourth National Conservation Congress held at Indianapolis.

C. H. Snyder is still located in San Francisco as the representative of the Milliken Structural Iron Company.

E. S. Keene, m. e., is still the main man of the engineering department of the North Dakota Agricultural College. He has been spending the summer in working up some practical things for a course in home economics which he gives the young women of that institution. He says it is the stuff that women ought to know about the house, but don't.

R. J. Cooke, c. e., is plugging along at the Lake Shore and Michigan Central railway, trying to keep the railroad running.

The address of Hugh Hazelton, c. e., is 42 Sherwood Place, Englewood, New Jersey. He says that although he has always been a republican, he is going to be loyal to New Jersey's candidate this year. He is engaged in some extensive electrical work in Pennsylvania and New York.

Fred W. Waterman, m. e., writes concerning the gathering of University people near Cleveland, Ohio.

He said it is pretty hard to keep up enthusiasm when one has been absent so long. Fred's address is Lorraine, Ohio, and he is with the National Tube Company.

1802

The address of Roy A. Mather, c. e., is changed from 632 Summerlea street, Pittsburgh, Pennsylvania, to 214 Beaver street, Scwickley, Pa.

E. L. Scheedenhelm, c. e., is chief engineer of the hydro-electric department of the American Water Works and Guaranty company, 808 First National Bank building, Pittsburgh, Pennsylvania.

The address of B. A. Wait, c. e., is changed from Davenport, Iowa to 1430 West Fifth street, Des Moines, Iowa.

1803

B. V. Swenson, e. e., lives at 43 Cedar Place, Yonkers, New York.

J. A. Kinkad, chem., who is resident sales manager for the Parkesbury Iron company, 30 Church street, New York, was a member of the committee on arrangements for the recent International congress for testing materials in New York.

1804

The address of Martin J. Engberg, chem., is changed from 358 West Chicago Avenue, to 204 Cleveland avenue, Chicago.

1805

Joseph William Royer, arch., was one of the ushers at the Chicago convention which nominated Taft.

Peter Junkersfeld, e. e., and Anna Boyle (Junkersfeld), la, '00, arrived at Liverpool, England, on September 3.

The address of Armin Harms, chem., is 1660-608 South Dearborn street, Chicago.

Oscar B. Mueller, m. e., ex-'95

who for some years has been New York resident manager of the H. Mueller Manufacturing company of Decatur, Illinois, has established a branch and become manager at Sarina, Ontario, Canada.

A. M. Munn, c. e., is secretary of the Munn-Reise Construction company, contractors in railroad, irrigation, and drainage work. His company has a large amount of very important work in the southwest. His address is Rich Hill, Missouri.

Alexander M. Munn, c. e., is a member of the firm of Munn-Reise Construction company, at Rich Hill, Missouri.

1807

The address of T. J. Klossowski, c. e., is in care of Edmonton Cement company, Marlboro, Alberta, Canada.

A. J. Wharf, c. e., is superintendent of construction for J. E. and E. C. Wharf, 5036 Sunnyside avenue, Chicago.

1809

Harry Anderson, e. e., 333 Henry building, Seattle, Washington.

C. L. Clifford, e. e., 1729 New York avenue, Washington, D. C.

George Dodds, e. e., 10 Stanurt street, Albany, New York.

John M. Herwig, m. e., Landsburg, California.

J. A. Mesiroff, e. e., 48 Evergreen street, Chicago, Illinois.

P. F. A. Rudnick, chem., 2007 Milwaukee avenue, Chicago, Ill.

S. O. Swenson, e. e., 3229 McGee street, Kansas City, Missouri.

The Independent for September contains a write-up on the international competition for the design of plans for a capital city for Australia, in which W. B. Griffin, arch., won first prize. A portrait and

sketch of the successful contestant are given, and the three designs which were awarded prizes are described.

A. D. DuBois, e. e., of the electrical engineering department of Purdue University, is the author of a recent series of articles in the *Electrical World*, on Adjustable Speed Motors.

G. E. Tebbetts, e. e., is a member of the coroner's jury selected to investigate the failure of the Alameda Hotel at Kansas City, Missouri, in which several floors of reinforced concrete gave way, killing four men and injuring several others. J. E. Trogden, ex-'08, is deputy coroner in charge of the investigation.

1900

John Charles Thrope, m. e., was appointed to take command for eastern Illinois of the auto tours to the State Fair, October 4 to 12.

Thomas Wilson, e. e., is associate editor of *Power* at New York City. He lives at 153 Humphrey avenue, Bayonne, New Jersey.

A. L. Kuehn, e. e., spent the summer in Europe on business for the American Creosoting company, of which he is the general superintendent. His offices are now in Louisville, Kentucky, but his residence is still 220 south Ridgeland avenue, Oak Park, Illinois.

1901

Arthur C. Hobble, sci., e. e., '11, is an electrical and hydraulic construction engineer with S. Pearson and Son, Successors, South America, on the Conchos River Hydroelectric Development near Santa Rosalia, State of Chihuahua, Mexico. His postal address is Ciudad, Camargo, Chihuahua, Mexico.

1902

The address of Edward O. Keator, e. e., is 33 The Navarre, Walnut Hills, Cincinnati, Ohio. He has opened an office in Cincinnati as civil engineer and contractor.

Elrick Williams, chem., and Florence Somers (Williams), la-'07, have returned to the States. They are at home on furlough from West China and may be addressed at 1318 7th avenue, N., Fort Dodge, Iowa.

1903

Fred W. Rose, e. e., has recently opened an office at 903 Palace building, Minneapolis, Minnesota, for general consulting engineering.

W. V. Dunkin, m. e., is chief draftsman in the experimental department of Deere and company, Moline, Illinois. His street address is 1810 12th avenue.

Robert H. Kuss, m. e., is now assistant sales manager of the Chicago office of the Edge Moore Iron company, manufacturers of water tube boilers.

The address of G. L. Sawyer, m. s. e., is 410 Lindell Block, Spokane, Washington.

The address of Albert M. Johnson, m. e., is 611 Auburn street, Rockford, Illinois.

J. A. McFarland, chem., is chemist and engineer of tests with the St. Louis and San Francisco Railroad company, at St. Louis, Missouri.

The address of W. P. Ireland, e. e., is 2414 Tea street, Sacramento, California.

1904

The address of Ray L. Horr, e. e., has been changed from 6220 Kimbark avenue, Chicago, to 346 south 7th avenue, LaGrange, Illinois.

The address of P. D. Gillham, e.

e., is 205 Park avenue, west, Princeton, Illinois.

1905

T. N. Davidson, c. e., is assistant western manager of the Concrete Steel company of Chicago.

The address of Fred S. Sawyer, c. e., is 407 White Building, Seattle, Washington.

The address of G. R. Bascom, m. s. e., is 708 Flynn building, Muskogee, Oklahoma.

F. A. Randall, c. e., is chief engineer with Morey, Newgard and company, engineers, Lake View building, 116 South Michigan boulevard, Chicago.

The address of F. I. Blair, c. e., is changed from 509 East Graham street, Bloomington, to his country address, Box 1, R. R. No. 2, Normal, Illinois.

The address of A. G. Schutt, c. e., is 2352 Arkansas avenue, St. Louis, Missouri.

1906

J. W. Stromberg, c. e., has been appointed to take charge of the Chicago office of the Clinton Wire Cloth company, at 342 River Street.

E. J. Mehren, c. e., formerly associate editor of the *Engineering Record*, and for the past year secretary and manager of the Emerson Company, efficiency engineers, New York, has rejoined the *Engineering Record*, in the capacity of managing editor. His address is 60 Amherst street, East Orange, New Jersey.

The address of Paul E. Howe, chem. e., is 437 west 50th street, New York City.

The address of N. R. Porterfield, c. e., is 107 north 4th street, Reading, Pennsylvania.

The address of Paul Augustinus, c. e., has been changed from Pitts-

burgh, Pennsylvania, to 336 south Ashland avenue, LaGrange, Illinois.

N. H. Jacobson, '06, has recently taken a position with R. W. Huston Company, consulting and constructing engineers at Memphis, Tennessee, and has been placed in charge of the municipal design and construction in the state of Arkansas, with headquarters at Little Rock.

1907

The address of W. A. Knapp, c. e., has been changed from 113 south Grant street, to 105 Fowler avenue, West Lafayette, Indiana.

P. J. Freeman, m. e., is in the regulator department of the H. Mueller Manufacturing company of Decatur, Illinois.

Frank S. Luney, m. e., is with the American steel and Wire company of DeKalb. His residence address is 232 north Fourth street.

The address of Frank W. Padfield, e. e., has been changed from 409 West White street, Champaign, Illinois, to 1107 Franklin street, Danville, Illinois.

The address of Ivan G. Harmon, c. e., is 1431 California street, Denver, Colorado.

Fred C. Taylor, c. e., '07, recently with the Cowley Frog and Switch Co., of Memphis, has just accepted a position with the H. W. Johns Manville Co., with headquarters at St. Louis, Mo., and is to handle material for cork and cold storage insulation.

1908

J. B. Cabanis, c. e., may be addressed at 323 Plymouth building, Minneapolis, Minnesota.

The address of E. J. Bartell, chem., is 1007 Hodge building, Seattle, Washington.

T. R. Houser, c. e., has returned to Porto Velho, Brazil, where he

has an engineering position with the Maderia-Mamoré Railroad Company

The address of F. L. Hanson, e. e., is 434 Park street, Peterboro, Ontario.

The address of J. M. Warner, c. e., is 301 Slocum avenue, Syracuse, New York.

R. M. Van Petten, c. e., has left the employ of the Oregon Short Line railroad and is now in the employ of the Utah Construction company, in charge of grading work at Driggs, Idaho.

Harold H. Dunn, ry. e. e., is an assistant in railway engineering at the University.

W. E. Underwood, e. e., is employed with the National Electric Lamp association of Cleveland, O.

1909

The address of Carl H. Hoge, ry. e. e., is 1712 Summitt avenue, Seattle, Washington.

The address of John J. Miller, chem. e., is 1436 Neil avenue, Columbus, Ohio.

The address of E. H. Ashdown, m. s. e., is 51 west 1st street, Chicago Heights, Illinois.

C. A. James, c. e., is located at Danville, Illinois.

Walter C. Patton, m. e., has removed from Sedalia, Missouri, to Excelsior Springs, Missouri.

K. H. Talbot, c. e., may be addressed care of the Universal Portland Cement company, Frick building, Pittsburgh. He is assistant engineer in the information and inspection bureau.

Other '09 men with the Universal Portland company are C. E. Powell, c. e., A. B. Becker, ex-'09 and Louis Buenger, ex-'09.

Charles S. Pope, e. e., recently resigned his position as chief engineer and designer of the Midland

Motor company at Moline, and has taken a place as assistant order foreman in the stationary gas engine plant of Root and Van Dervoort Engineering company of Moline.

Albert Penn, e. e., may be addressed care of the Fort Wayne Electric Works, 623 Marquette building, Chicago.

Lion Gardiner, m. e., E. C. McMillen, m. e., and W. W. Reece, m. e., are in charge of the employment bureau of the Chicago Illini Club. Information in regard to positions will be received and distributed by them among the alumni. Their address is 903 First National Bank building, Chicago.

Henry Pollard, m. e., is superintendent of the machine shop of Fidelity Brass Manufacturing company, 730-734 west Monroe street, Chicago.

The address of J. J. Walledom, c. e., has been changed from 6717 Perry Avenue, to 7943 south Elizabeth street, Chicago.

The address of Sidney B. Wright, m. e., is 1109 east 62nd street, Chicago.

The address of R. H. Arnold, e. e., is 1662 Maumee avenue, Fort Wayne, Indiana.

H. R. DeWitt, c. e., is assistant division engineer of the central division of the Missouri-Pacific railway. His address is box 411, Van Buren, Arkansas.

H. A. McCrea, e. e., writes from Schenectady that the Illinois alumni connected with the General Electric company joined the Purdue men in a clam bake last summer, and maintained our supremacy over the Hoosiers by beating them in a five-inning game of baseball, score 8 to 5. McCrae's address is care of Power and Mining Engineering De-

partment, General Electric company, Schenectady.

Lion Gardiner, m. e., has been elected treasurer of W. H. Zimmerman company, engineers and constructors, Chicago. W. W. Reese, m. e., is with this company, and recently completed three months' power plant efficiency work at the National Enameling and Stamping company at Granite City.

Bruce L. Jones, m. s. e., is constructing engineer with Harris & Dillavou, manufacturers of silos at Champaign. His address is 1000 west Park avenue.

1910

E. D. Doyle, ry. e. e., is employed in the Technical Associated Electric Testing Laboratories, 556 east 80th street, New York City. His residence address is 257 west 129th street.

Donald A. Pierce, e. e., is employed with the Public Service company of Northern Illinois. His address is 230 north Genesee street, Waukegan, Illinois.

The address of William A. North, c. e., is 3880 Washington avenue, St. Louis, Missouri.

N. W. Overstreet, a. e., is a member of the firm of Overstreet and Spencer, architects and engineers, Scutter building, Jackson, Mississippi.

L. A. McElhiney, c. e., may be addressed care of the assistant engineer, Illinois Central railroad, Fort Dodge, Iowa.

The address of O. F. Schulzke, chem., has been changed from 3877 Washington street, to 3866 Washington street, St. Louis, Missouri.

Edson H. Stone, m. e., lives at 3483 Cornell Place, Cincinnati, Ohio.

The address of H. A. Moore, e. e., has been changed from 5800

Curtis street to 1686 east 86th street, Cleveland, Ohio.

Omer Gaston, ex-'10, is representing the George W. Stiles Construction company, general contractors, 1036 The Rookery, Chicago.

H. E. Crossland, ry. e. e., is a bridge inspector for the Illinois Highway commission, with headquarters at 518 Hillsboro avenue, Edwardsville.

George Harold Myrick, e. e., and Hazel Lewis were married on May 15, 1912, at East Gary, Indiana. Mr. Myrick is superintendent of the Minellie Electric company of Chicago. They will live at 1257 Congress street, Chicago.

1911

John Mench, e. e., is employed by the Chicago sanitary drainage district.

Arthur L. Enger, e. e., has a position as assistant engineer in the Arizona Agricultural Experiment station at Tucson, Arizona.

Albert Frank Westlund, m. e., and Nella Walsh were married on September 18, 1912, at Mt. Zion, Illinois. Mr. Westlund is in the employ of the Illinois Steel company at Chicago. He was editor-in-chief of THE TECHNOGRAPH, 1910-11.

A. R. Anderson, e. e., after a year of graduate work in electrical engineering, entered the employ of the Jeffrey Manufacturing company, Columbus, Ohio, late in July. His address is 380 Alden avenue.

The address of Earl K. Burton, c. e., has been changed from 5008 A Fairmount avenue, to 925 Beach avenue, St. Louis, Missouri.

The address of Charles A. Carlson, m. e., has been changed from 1717 Sixth avenue, to 1532 Eleventh avenue, Moline, Illinois.

C. S. Huntington, m. e., is with

the Johns-Manville company, 92 Arthur street, Winnipeg, Canada.

E. B. Van de Greyn, m. s. e., is with Waddell and Harrington, 11th and St. Paul avenue, Tacoma, Washington.

The address of R. W. Leutwiler, m. e., is 840 Barry avenue, Chicago.

The address of Fred Benton, ry. c. e., is 1524 east 61st street, Chicago.

E. F. Blakeslee, m. s. e., is with Stone and Webster, at Keokuk, Iowa.

The address of J. VanDervoort, c. e., is changed to 598 A Fairmount avenue, St. Louis, Missouri. He is with the Unit Construction company, 801 Liggett building.

W. A. Wallice, m. e., is connected with the American Creosoting company at Hugo, Oklahoma.

F. J. Gray, e. e., and O. E. Grigsby, e. e., have entered the testing department of the General Electric Company at Schenectady, New York, after a year of graduate work in electrical engineering.

D. R. Lagerstrom, e. e., is now assistant head of induction motor test in the Schenectady works of the General Electric company.

E. M. Jasper, e. e., left the Westinghouse Electric and Manufacturing company last fall to go into business with his father in Newton, Illinois. He was married April 30, 1912.

C. E. Anderson, e. e., after a year of graduate work in electrical engineering, entered the commercial department of the General Electric lamp works at Harrison, New Jersey, on September 1.

C. T. Anderson, e. e., and C. D. Black, e. e., after a year of graduate work in electrical engineering, began their duties in the research laboratories of the General Electric

company at Pittsfield, Massachusetts, during the summer. Their address is 33 Dalton, Pittsfield, Massachusetts.

E. E. Boone, e. e., has recently entered the commercial course of the Westinghouse Electric and Manufacturing company, East Pittsburgh, Pennsylvania.

1912

The address of C. B. Thvedt, e. e., is 218 Clayton street, Waukegan, Illinois.

Frank Wilson, e. e., has a position in the lamp department of the General Electric Company at Newark, New Jersey.

Frank Spencer Kailer, e. e., has taken a position with the American Telephone company at New York City.

Harry F. Glair, m. e., is employed as an engineer with Curtis and company, of St. Louis.

Otis B. Dorsey, e. e., has a position with the General Electric company at Newark, New Jersey.

Harold A. Otis, e. e., is an electrical engineer for the Metropolitan Elevated Railroad, in Chicago.

Victor A. Mathis, ry. m. e., is employed by the Pittsburgh and Lake Erie railroad in the motive power department at Pittsburgh, Pennsylvania.

Leo V. Schunder, e. e., is employed as an electrical engineer with the Western Union Telegraph company in New York City.

Chas. K. Hewes, chem. e., is an assistant in chemistry at the University.

John E. Wright, e. e., is with the contract department of the Commonwealth Edison company of Chicago.

H. E. Marquette, ry. m. e., has a position with the Santa Fe Railroad

company at San Bernardino, California.

W. W. Manspeaker, c. e., has taken a position as draftsman for the Illinois Traction System at Decatur, Illinois.

L. L. Powell, c. e., is employed as civil engineer in the Chicago office of the Illinois Central Railroad company.

C. A. Klooster, a. e., is superintendent of construction in the building of a large sugar refinery in Pekin, Illinois.

Fred D. Hull, e. e., is a telephone engineer for the Western Electric company at Hawthorne, Illinois.

Donald E. Buyers, m. e., is working at the coke plant of the Indiana Steel plant at Gary, Indiana.

Harry F. Geist, e. e., has taken a position with the testing department of the Western Electric company of Pittsburgh.

F. M. Nourse, e. e., is a contract agent for the Illinois Utilities company at Mendota, Illinois.

C. W. Fick, e. e., has taken a position with the Chicago Telephone company at Chicago.

Charles Gordon, ry. e. e., is employed as testing engineer for the Chicago Railway company.

Guy G. Mills, c. e., has a position as draftsman for the American Bridge company at Toledo, Ohio.

G. W. Philleo, m. e., is superintendent of motive power of the Arkansas Valley Smelter at Leadville, Colorado.

Claude Van Gundy, e. e., is employed with the National Electric Lamp association of Cleveland, Ohio.

Frank E. Gooding, m. e., is assistant chemist for the People's Gas Light and Coke company. His address is 4008 Clarendon avenue, Chicago, Illinois.

E. B. Stiles, c. e., is doing concrete work for the Illinois Central railroad. His address is Box 100 West, Mississippi.

F. W. Mohlman, chem., is chemist at the State Water Survey office at the University.

L. L. Powell, c. e., is working as civil engineer for the Illinois Central in the Chicago office.

Alexander W. Erskin, c. e., is instrument man with the Chicago and Northwestern railroad.

Charles Bremmer, c. e., is in the employ of the Marquette Construction company, Chicago. His address is 37 north Madison avenue.

John Francis Siefried, c. e., is with the Chicago, Milwaukee and St. Paul at Cambridge, Iowa.

S. L. Miller, s. m. e., who was with the State Highway Commission on road construction during the summer, is now with Dabney H. Maury, Chicago, consulting engineer on water works construction.

John W. Davis, c. e., assistant foreman with the Federal Creosoting company, Paterson, New Jersey, resides at 19 Church street, Paterson.

Paul Kircher, c. e., has been travelling in Europe during the summer. He expects to take up graduate work in Berlin.

F. G. Gordon, m. s. e., has been transferred from Peoria to the Chicago office of Dabney H. Maury, Monadnock block, Chicago.

C. I. Haven, m. s. e., is on the engineering corps of the city of Baltimore in connection with large sewer construction.

W. C. Lorenzen, m. s. e., is with Chester and Fleming, consulting engineers, Pittsburgh, a firm which is handling a large amount of filter work and other water works construction.

A. L. Israel, chem., is at the chemical laboratory of Armour and company, at Union Stock Yards, Chicago.

P. E. Johnson, chem., is in the testing department of the Frisco road. His address is 2209 Pine street, St. Louis, Missouri.

H. P. McGregor, chem. e., is in the laboratory of Marriner and Hoskins, 111 west Monroe street, Chicago.

R. I. Quimm, chem. e., is with the Morrison company, Union Stock Yards, Chicago.

C. Rascher, chem. e., is with the Abbott Alkaloidal company in Chicago.

F. C. McNary, c. e., is with the street railway at Duluth, Minnesota.

H. T. Leo, chem., is employed by the Pullman-Leo Fruit Product company at Pullman, Washington.

G. E. Warren, H. F. Wagner, and L. M. Fisher are in Baltimore, Maryland, on the construction of a sewer system.

J. W. Davis, c. e., is employed by the American Creosoting com-

pany, Paterson, New Jersey.

H. J. Leviton, ex-'12, is with the United States Engineering department at Kansas City, Missouri.

D. B. Maver, c. e., masonry inspector for the Illinois Central railroad, is at 1511 65th Place, Chicago.

Robert H. Nau, c. e., is employed by the Smoke Abatement and Electrification committee, Chicago. His address is 1212 south 5th avenue, Maywood, Illinois.

Oscar Bulkeley, c. e., is with the Water Company of Rockford, Illinois.

Alexander Erskine, c. e., is working for the Chicago and Northwestern railroad on ballast track elevation.

W. R. McIntire, c. e., is with D. H. Burnham and company, architects, Chicago, as assistant superintendent in the sinking of caissons for a new building on La Salle and Madison streets, Chicago.

G. A. Harnack, c. e., is in the sales department of the Universal Portland Cement company, Chicago.

RESEARCH WORK

"THE COKING OF COAL AT LOW TEMPERATURES WITH A PRELIMINARY STUDY OF THE BY-PRODUCTS", by S. W. Parr and H. L. Olin, has just been issued as Bulletin No. 60 of the Engineering Experiment Station of the University of Illinois. *Price, Twenty-five cents.*

This bulletin gives details of experiments in the carbonization of coal at relatively low temperatures, not exceeding 750 degrees F. The studies indicate that the bituminous matter in Illinois coals is in excess of the amount necessary to produce bounding materials for the non-coking or cellulose residuum of the coal and that the best cokes are produced when mixtures of fresh coal and non-coking coal materials, such as coke breeze or powdered anthracite, are used. The tests show that the by-products consist of a gas of high illuminating power and heat value (1030 B t. u.), and tarry material which consist in the main of oils of low viscosity having marked oxygen-absorbing properties.

In a very important aspect, this work constitutes a study in smoke prevention from a chemical rather than a mechanical standpoint, and the results show that bituminous coal in a form for combustion without smoke is at least a theoretical possibility. An interesting feature of the work is the information it affords as to the theory of the coking of coal. The summary touching this point concludes, that "for the formation of coke there must be present certain bodies which have a rather definite melting point" and further that "the temperature at which decomposition and carbonization take place must be above the melting point".

Copies of Bulletin No. 60 may be obtained upon application to

W. F. M. Goss

Director of the Engineering Experiment Station
University of Illinois, Urbana, Illinois.

Have You Learned How



"From the Raw to the Finished Product"

—a 72 page booklet descriptive of the "Chicago AA" process of manufacture. Illustrated with 66 halftone engravings from photos taken at our mills.

FREE

to cement-users. Write for a copy *today*.



"Chicago AA"

Portland Cement is made?

It is a story of great interest to the man who uses cement. It tells how the raw materials are taken from the quarries, how they are weighed, proportioned, crushed and conveyed to the mills; it describes the "*Chicago AA*" process of drying, grinding and then burning the raw mixture to a "clinker" and explains, in an interesting way, the method of cooling the "clinker" and grinding and re-grinding it, thus producing "*Chicago AA*" Portland Cement, "the best that can be made."

Read this story: It will enable you to better appreciate the superiority of the "*Double A*" brand—it will guide you in the selection of a cement for your work in the future.

Chicago Portland Cement Co.
30 No. LaSalle Street, Chicago, Ill.

Manufacturers of the

"Chicago AA" Brand

"The Best That Can Be Made"

Present Output **1,500,000** Barrels Annually

When writing to advertisers please mention THE TECHNOGRAPH

J. M. KAUFMAN AND COMPANY

Champaign's Largest Clothiers



Norfolk No. 4
Copyright
THE SYSTEM

KEEP POSTED ON STYLES

☞ The character of the clothes you buy isn't wholly a matter of the responsibility of the firm that makes them—or the store that sells them—You, yourself, are an important factor in correct selection. May we have the pleasure of showing you what is correct

For Fall and Winter

\$15.00, \$17.00 to \$30.00

When writing to advertisers please mention THE TECHNOGRAPH

TH
copy 2

ESTABLISHED 1885

THE TECHNOGRAPH



A QUARTERLY PUBLICATION OF THE
ENGINEERING SOCIETIES OF THE
UNIVERSITY OF ILLINOIS

VOLUME XXVII

FEBRUARY, 1913

NUMBER 2

PRICE TWENTY-FIVE CENTS

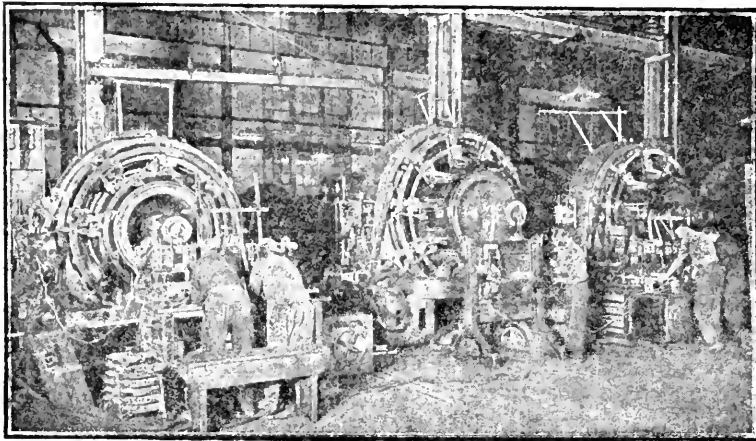

Pumping Back Tests on Synchronous Converters

The three large converters here shown are running together for a pumping back test on the two 2000 kilowatt converters at the right. The losses are supplied by the smaller machine at the left, running on a direct current supply circuit.

The two machines under test are connected together on both the A. C. and D. C. sides and the load is regulated by boosting the A. C. voltage of one machine with an induction regulator until the desired current flows around the two armatures.

When the photograph was taken the machines were ready to be connected together on the D. C. side. The man at the switch is checking the voltage across the switch to be sure that the voltage of the two machines is the same, before connecting them together.

The testing of these machines, and of all other apparatus made at the Schenectady and Pittsfield Works of the General Electric Company, is done by student Engineers. These students wire up the machines and run the tests, and are responsible for the safety of the machines during the tests. Engineering students, who desire a year or so of this experience after graduation, may write to Mr. G. H. Pfeiff, Secretary Students' Committee, General Electric Company, Schenectady, New York.

General Electric Company

Largest Electrical Manufacturer in the World

General Office, Schenectady, N. Y. Sales Offices in forty-eight cities

3823

The Guarantee of
Excellence



on Goods
Electrical.

When writing to advertisers please mention THE TECHNOGRAPH

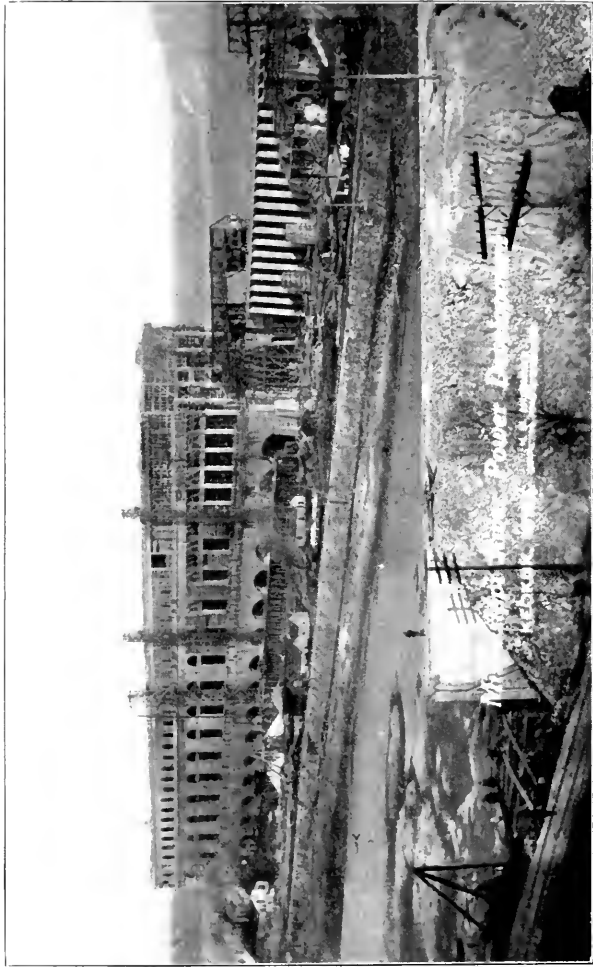

MISSISSIPPI RIVER POWER DEVELOPMENT, KEOKUK, IOWA

See page 91

The Technograph

VOL. XXVII

FEBRUARY, 1913

No. 2

TRAINING ENGINEERS IN THE SCIENCE OF MANAGEMENT

BRUCE W. BENEDICT, B. S.,

Director Shop Laboratories

With the passing of the nineteenth century the frontier of our country—that typical feature of our national life—disappeared in a great wave of expansion, and the material conquest of America was complete. Approaching so gradually this change in the physical structure of our country passed almost unnoticed in the march of seemingly greater events, yet it presaged a transformation in national life of tremendous significance.

The pioneer is a prodigal. Surrounded with abundance to support life and the lavish gifts of a virgin country, he has little cause to give heed to immediate personal demands. The bountiful harvest of nature untouched by the hand of man seems boundless and the requirements of future generations remote. We have within the memory of this generation heard of our inexhaustible resources in forests, coal, ores and oil, yet now we know there are well defined limits to all of these.

The indomitable purpose which led the Pilgrim fathers to these shores and drove them and their descendants to transform an unknown wilderness into a great nation within the short space of time covered by less than three centuries, has left the distinguishing mark of the pioneer spirit upon us as a people. Americans are essentially pioneers; in thought and in act. Combined with the hardy traits of character are also the habits of wastefulness. The spirit which led to an immoderate exploitation of our resources has likewise built up great industries with tragic disregard for human life. Extravagance in the use of natural resources, great as it has been, is not comparable with the greater wastes in the utilization of labor. While wasteful-

ness is still a typical national trait, the frontier has passed and with it those misconceptions of the pioneer regarding the extent of our material possessions and wealth. Conservation is taking the place of reckless waste, a stirring conscience awakening to responsibilities in safeguarding human life, and an enlightened intelligence aroused to the necessities of conserving labor.

The magnitude of industrial development in America during the nineteenth century gave the distinguishing mark to this period in the history of the world. From the bare land a myriad of industrial centers arose almost by magic. Production increased by leaps and bounds but ever lagged behind demand. In this industrial period when every resource was strained to the utmost to meet the requirements of colonization and internal growth, the cost of output and conditions surrounding the worker of necessity received but little or no consideration. Local exceptions where the economic and social features of industry received their share of attention serve through contrast to illustrate more forcibly the general conditions that prevailed. Production was the governing factor in this era and it was achieved under a regime of wastefulness characteristic of the pioneer.

This period of industrial expansion witnessed a remarkable development in labor saving and automatic machinery. While supplanting the worker in certain occupations, machine processes opened a vast field of opportunity which otherwise would have remained untouched and perhaps unknown. Machinery does not lessen the sum total of labor but multiplies it many fold. This industrial period so rich in material accomplishment shows from our superior point of observation a strange and inconsistent development. On one hand we see perfection of machinery and creative processes of highest efficiency; on the other, the unsolved problems of labor and the enormous losses through waste in human effort. From a lack of standards and fundamental data the extent of these losses and their relation to national wealth have not heretofore been fully realized. But under the searching inquiry of the modern industrial spirit, the true meaning of inefficiency in the utilization of labor assumes a new significance and a place among the larger problems of the nation. That we are entering on an era of industrial readjustment in which old time methods of employing labor will give way to more effective and scientific methods, there is no question. Substitution of the new for the old has already begun, and "scientific

management" is perhaps the most widely discussed topic of the time. Since the day Brandeis made the sensational statement that the railroads did not need higher rates for service, but greater efficiency of management for maintaining revenues under more rigorous operating conditions than formerly, the country has teemed with thought and discussion about the latest phase of industrial development. Naturally much of that said and written was based on misconception arising from superficial knowledge. To organized labor and its sympathizers, scientific management appeared as a menace to individual welfare and liberty. We hear the worker was to be turned into a human treadmill and "speeded up" beyond the limits of flesh and blood. In fact one writer of prominence declared a new race would be needed to stand the pace required in the new order of things. At the other extreme a certain portion of society could see in scientific management the panacea for all the ills that afflict the industrial structure of the nation.

Science is "knowledge gained and verified by exact observation and correct thinking". Applying scientific effort to industrial management is a process with three logical steps; first, determination of present practice; second, development of the most efficient practice, and third, the direct application of the information thus obtained to secure effective operation without losses and waste. Or as the authors of the *Principles of Management*, tersely state (a) the systematic use of experience (b) the economic control of effort (c) the promotion of personal effectiveness. The first step presumes the use of scientific study of existing knowledge and experience, and compilation of records showing exact conditions. The second step includes the scientific treatment of the problem as revealed by the preceding investigation by co-ordinating the executive and producing labor, and developing the most efficient methods of management and production. The last step is the attainment in actual practice of the scientific standards covering executive and productive effort which have been determined upon, by promoting personal efficiency through adequate rewards for service, conserving mental and physical health and establishing just relations between employer and employee.

In the early days when industries were small the proprietor or owner personally directed his men. He knew from personal contact their moral and intellectual characteristics. Management

under such circumstances was a simple thing and frequently it was efficient. With the growth of industries having a few men to organizations with hundreds and thousands the relations of the executive and worker underwent a material change. From a personal acquaintance of the executive, the worker became an impersonal unit, both physically and mentally. The old methods of personal direction would no longer apply under such conditions as these, and we see various forms of organizations coming into being as the size and nature of the industry demanded. While different in conception and detail, these organizations had one feature in common—all were impersonal. The executive did not know his workmen, nor the workmen their executive. The strong bond of sympathetic co-operation between employer and employed, so prominent a feature of the small organization, was from physical if not for other reasons denied the large organization. As a result the mental attitude of the executive and producing elements underwent a change. Common interests gave way to local interests. Apathy took the place of enthusiasm. With the incentive for personal co-operation absent, the workman was content to sell his time rather than his effort. The employer was equally content to buy this time at the lowest price it could be obtained. Exchanging time and compensation on this basis served to destroy the initiative of labor and remove from industrial organization its most essential element. There could be but one result. Labor became increasingly inefficient. Waste is the chief product of inefficiency. Lack of standards for purposes of measuring or even identifying these wastes did not exist, neither had the executive acquired that vital mental attitude toward labor which was indispensable in the solution of its problems.

From the general opinion of organized labor on the scientific management, to which reference has been made, the belief might arise that the aim of the new movement was to drive the workman to a harder task at the same or lower wage. The reverse is true. Modern management owes its origin to a recognition of the fact that "all misdirected effort is simply loss and must be borne either by the employer or employee". The aim is to turn misdirected into productive effort. In the practical attainment of this, a wise and humane policy toward the workman is contemplated. Economy and not philanthropy decrees the worker must be physically and mentally fit, properly trained in the functions

required to perform, and rewarded according to productive effort. The responsibility for misdirected effort belongs upon the executive, not upon the workman, and the new activities of the former are those most effected in the new order of things. As stated in a report of the committee on the art of Industrial Management before the American Society of Mechanical Engineers, "The usual conception of modern management is that it affects the workmen most of all, tending to stimulate them to their possible hurt. This is wrong. If the principles outlined are followed, the executive or non-producing labor is the most affected. Its individuals are compelled to study, plan and direct. They must acquire knowledge and skill in order to transfer it. It is a system of management that forces the executives to manage."

Industrial management of the future will be controlled by scientific principles. Mathematical treatment of material problems has been the rule for ages. Engineers are trained to use the forces and products of nature according to scientifically determined laws. Experts on all matters but labor are common to commercial organizations. But where are the labor experts, equipped with the necessary fundamental training and experience to solve as scientists the problems of labor? The past did not produce them but the future will and in constantly growing numbers. The engineering ranks will be drawn upon heavily. From the nature of the requirements the trained engineer is particularly fitted to apply scientific effort to management. The relation of the engineer to the practice of management is better appreciated with the acquisition of experience. A certain element of mystery has already departed. Labor saving management is a term coming into use as more expressive of the functions of the movement. Applying scientific methods to management involves the same processes as employed in physics or other sciences. Quoting again from the Committee report previously referred to: "The methods used are adopted from the research laboratory. But the purpose of their use is changed. The scientific investigator uses his laboratory to discover facts. Their discovery and declaration is his end and aim. The management investigator uses laboratory methods to discover facts for immediate use. The end and aim is utility."

It is clear the engineer of today has added responsibilities, and new problems to face. Industry is demanding engineers

with special training in the science of management and educators everywhere are discussing and making plans to provide this training. It would seem that a new engineering was in the process of development. Reorganization of the courses in shop practice as generally administered, is held by educators to be essential for reasons clearly expressed by Dean W. F. M. Goss in a recent paper, *Administration of College Shop Laboratories*, as follows: "A demand has developed for men possessing other characteristics—the characteristics of the well trained theorist and analyst—for men who understand the principles underlying the work of the mechanic and who through the application of these principles can aid in a large way in increasing the efficiency of the establishment they serve. The people contributing to the support of the technical schools no longer require the activities of the shop laboratory to convince them of the value of the engineer's training, for they see in the work of men who control the engineering activities which are going around all about them, a better and a broader definition of the true functions of the engineer." In this conception college shops move on to a new field of usefulness becoming laboratories for training in the science of management with skill in manipulation of tools of secondary importance. Manual training is supplanted by mental training.

In the courses in labor-saving management at the University of Illinois the presentation of underlying principles co-ordinate closely with laboratory work. It is aimed to make the laboratory a demonstration ground where the theories advanced in the lecture room are carried out in actual practice. With this intimate relationship between lecture room and laboratory, the training approaches that given in all sciences. In this article attention will be confined to the laboratory portion of the courses and its most important features briefly outlined. In arranging the laboratory work it was assumed the science of management would be most effectively illustrated by creating conditions in the laboratory similar to actual conditions in industrial plants, producing a situation requiring real functions of management. The Shop Laboratories with its five departments becomes under this policy a single producing unit with an organization and manufacturing facilities similar to a commercial enterprise. The motive however is not commercial, and production is not the prime object. Production as the visible results of management

is considered essential for the opportunity it presents for mental development. It is sought for this reason. Efficiency of management is definitely expressed in the amount and cost of production. Mental activity controls the quality of management. Production therefore is not only a measure of but an incentive for the attainment of personal effectiveness.

In operating the Shop Laboratories as a producing unit a wide range of training in the various activities of shop operation and management is given in manufacturing processes, handling of material, maintenance of plant, the manufacture of standard products and the regular shop problems arising in connection therewith constitute a real background for real management.

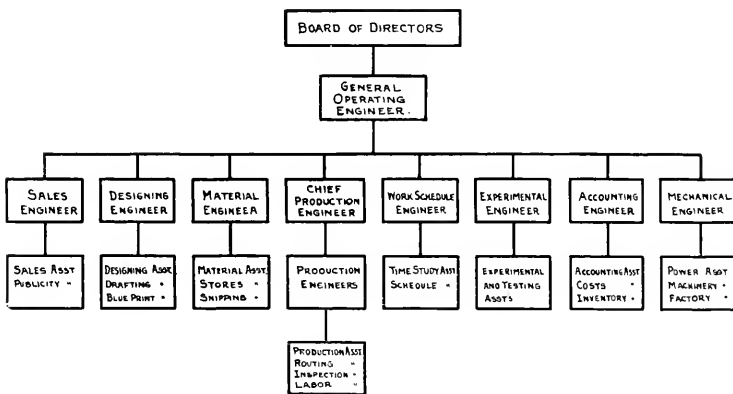

FIG. 1.—Diagram showing organization of the general operating staff of the shop laboratories.

A typical organization with executive and operating members will serve as a medium for training in the functions of management and for practical operating purposes. Figure 1 shows diagrammatically the organization of the operating staff. Executive control is centered in a board of directors who direct affairs through the person of a general operating engineer. The latter has powers similar to that of president or works manager and is vested with supreme executive authority which is exercised through a staff of eight engineers. These have specialized duties after the functional system of management and are provided with a corps of assistants for actual prosecution of the work assigned. With this organization every detail of shop activity is under the direction of an expert qualified by experience and training to obtain a high degree of operating efficiency. The

personnel of the organization and the specialized functions of the individual units are as follows:

Board of Directors. Composed of Professor of Mechanical Engineering, Director and Instructors of Shop Laboratories, and student engineers who compose the operating staff. Board meets once a month to outline and approve plans for efficient operation of the plant and receive reports from general operating engineer on operations for previous month.

General Operating Engineer. Upperclass students specializing in shop management, holding the position in rotation. The chief executive officer and works manager with absolute authority over operations of plant, working of course under the direction and leadership of the Director and instructors of the Shop Laboratories.

Chief Production Engineer. Upperclass students specializing in shop management or sophomores taking M. E. 42 who have shown special aptitude for organization, holding the position for a period of time in rotation. In charge of shop production with supervision over the labor engaged in producing the product of the plant. Has staff of five production engineers, one in each department. The special function of this staff is to obtain maximum output with a minimum expenditure of time, effort and cost. The plant is assumed to be kept in a state of highest efficiency by the engineers composing the general operating staff so the attainment of this ideal condition is a possibility.

Sales Engineer. Upperclass students or sophomores holding the position in rotation, assigned to this duty according to general qualifications and interest displayed. Selection of the remaining staff engineers will also be made on this basis. Sales engineer in charge of disposal of product, advertising and general publicity matters. Correspondence and editorial work in connection with these duties to be a feature of the training received.

Designing Engineer. Has supervision over designs of regular shop products and articles manufactured in the laboratories. Provided with corps of assistants for drafting, blue printing, etc.

Work Schedule Engineer. Directs the preparation of work schedules and instruction cards which embraces determination of the most efficient production methods, the making of time studies of shop operations, and establishment of standard time for same. Has a corps of assistants for carrying on this service simultaneously in all departments.

Experimental Engineer. In charge of testing the shop pro-

ducts and such shop tests as are necessary for keeping the plant up to a state of efficiency. As the main product of the laboratories at present is gas engines, tests of these on the testing rack will develop upon the experimental engineer and his assistants before the same are finished and sold.

Material Engineer. Has supervision over receipt, custody and delivery of all material and supplies used in shop products and maintenance of plant. Makes purchases of same under general instructions of the Director. Assisted by a corps of material, stores and shipping assistants.

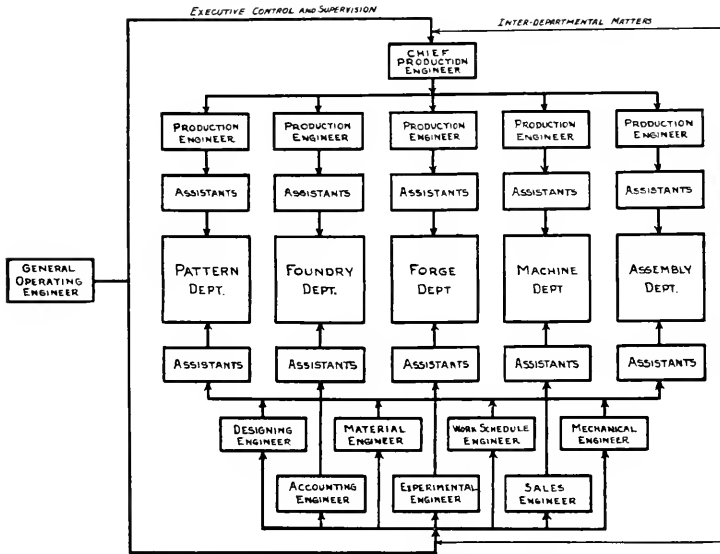

FIG. 2.—Diagram showing departmental organization of the general operating staff with corps of assistants in each of the five departments.

Accounting Engineer. Directs the accounting and auditing of all shop records and the keeping of inventory of the plant. Has corps of assistants who keep the time and cost records of all departments.

Mechanical Engineer. Has supervision over the mechanical efficiency of the plant including maintenance, repairs and general condition of facilities, machinery, belting, tools and devices.

The attainment of efficiency in the operation of the plant is insured by organizing the staff of operating engineers so that the functions of each will be performed effectively and in harmony with the work of the others. Figure 2 shows in chart form the operating organization and the channels through which the

functions of the various engineers are extended over all departments.

The interrelated functions of the engineers on the general staff when the plant is in operation is shown diagrammatically in Figure 3. The chart also indicates the schedule which one of the standard products moves through the various processes from the time of order until delivery. The official order originates in the board of directors and is passed to the general operating engineer who arranges the preliminary details and issues an official order to the designing engineer and chief production engineer. The former proceeds immediately with the designs and specifications and after receiving the approval of the general operating engineer forwards the drawings to the chief production engineer. The latter then arranges a manufacturing schedule, copies of which are furnished the production engineers in the various departments, the material engineer and work schedule engineer. This schedule gives in detail a program for each department and the delivery dates when the product is to move from one department to another. The production engineers proceed at once to set the wheels of industry in motion and the material engineer to order and distribute the necessary material and supplies. Meanwhile the work schedule engineer is preparing time schedules and instruction cards covering the shop operations. After leaving the assembling department the product passes to the experimental engineer who makes the required tests and reports on its condition and fitness. The finishing touches are then applied and the product reported to the material engineer for shipment. Upon delivery the sales department presents an invoice to the buyer and later receives all moneys accruing from such sales. The financial balances and all operation reports are sent direct to the general operating engineer who arranges them in statement form and presents same as a report of operations to the Board on the following meeting.

In performing the various functions of the engineers composing the operating staff, the individual will receive real training in a real problem. From the time of order to the delivery of product the most efficient methods of shop management will be employed with the object of producing without losses and waste. The lesson is not production for production's sake, but the underlying principles of management as manifested through production for the development of that mental attitude and balance which engineers, to be successful, must have.

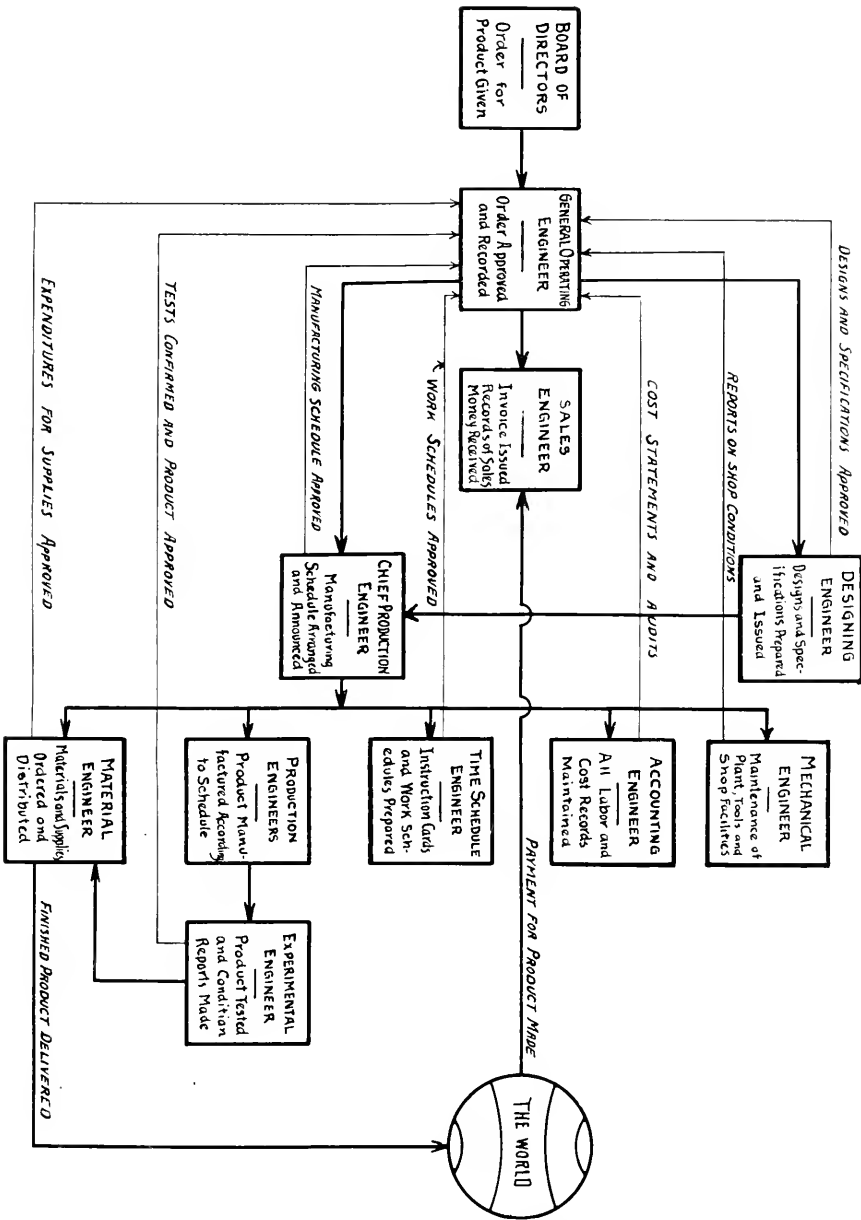

FIG. 3.—Diagram showing the functions of the various engineers on the general operating staff and their relations with each other in the operation of the plant.

THE ELECTRICAL SHOW

A. L. RICHE, '13, AND G. L. GRAVES, '13

Few people, not directly connected with the Electrical Engineering department, realize that the Electrical Show is one of the most effective advertising mediums for the university.

Several of the men who attended the show given in 1910, said that they heard of the University of Illinois for the first time through the Electric Show. Since the present show has been under way, several of the students have received letters from friends on both coasts, who have had their attention called to Illinois by show advertising.

Not only has the show been well advertised, but the engineering and business departments have provided exhibits which will make it a decided success. In laying out the various features, it has been constantly borne in mind that large crowds must be handled, and all the exhibits have been arranged in a manner which will give every one a chance to see all the show with the minimum of personal exertion. It is not to be a show for the technically trained alone, although such will find that ample provision has been made for their entertainment and instruction.

It is frequently charged that engineering students are so steeped in cold realities that they have no taste for form and color. One glance at the transformation which has been made in the aspect of the main laboratory, will convince the most skeptical that engineers are not lacking in an appreciation of the graceful and harmonious.

The whole ceiling is beautifully festooned, and the usual bare appearance of rows of generators and motors is completely changed by the construction of seven uniform booths of unique design. Each booth is supported by four large pillars surmounted with opalescent balls containing tungsten lamps, while its ceiling is studded with nine tungstens. These, together with the lamps on the ceiling of the room, lend a pleasing brilliancy to the scene.

The attractions in this room are of a somewhat miscellaneous character, and can not be fully described here, but a few are worthy of special mention.

In the northeast corner is heard the crash of a high power wireless sending station. The waves from this sender can easily

be picked up by stations within a radius of five hundred miles. Part of this apparatus is the loan of the Physics department, but most of it has been constructed by students of Electrical Engineering. In the opposite corner is a very complete exhibit of electrical measuring instruments, donated by the Sangamo Meter Co., of Springfield, Ill. At this booth, any one desiring to learn how to read his own house meter will be given complete instruction.

Beside this booth there will be a complete gasoline engine outfit for farm lighting. This is exhibited by courtesy of Fairbanks Morse and Co. There will be an attendant at this exhibit who will explain the simplicity of such an installation, and answer any questions which may be asked concerning the operation of stations of this kind.

Any one interested in modern steel apparatus or motor control will be given an opportunity to inspect a late type of automatic controller, as manufactured by the Electric Controller and Manufacturing Co.

This controller will be in operation, showing clearly the advantages gained by such an installation. It will be demonstrated on automatic acceleration, current limit, no voltage protection, overload circuit breaker protection, and dynamic breaking. The dynamic breaking will probably be the most interesting feature, as by this means the motor may be stopped in a very short time, regardless of operating conditions, without the aid of any mechanical brake or with damage to the motor. The motor may be reversed by simply throwing the controller from the forward to the reverse position, since the starter is entirely automatic in its action. This makes it safe to put in the hands of the most careless workmen. Another interesting device is an automatic starter to be attached to motors used to drive air compressors or water pumps. The motor is automatically started when the pressure falls to a predetermined point, and runs until the pressure reaches the desired value.

In the center of the room is a unique clock. It contains only one wheel, has neither pendulum, springs, nor any method of adjustment and may still be depended on for perfect accuracy at any pressure or temperature. It is the only one of the kind ever made, since it was devised by Illinois students and constructed in our own shops.

The large amount of bunting used in decorating necessitated

the most careful preparation for the prevention of fire, and the immediate quenching of any little blaze which may start. A well organized and drilled squad of fire marshals will be on duty, not only to put out fires, but to quell any panic.

The exhibit in the hall just back of the main laboratory is lighted by a quartz lamp which is a new product of the Cooper Hewit factory. Here will be exhibited the new 200,000 volt 100 k. w. transformer which has just been installed. All of the work of installing and testing this machine has been done by students. Should any central station manager or manufacturer wish a breakdown test on some particular insulator, the men in charge of this exhibit will perform the test as a portion of the demonstration.

Further down the hall will be found a complete electric kitchen, equipped with every known electrical device used in the culinary art. A bevy of fair "coeds" will preside over these for the delectation of any hungry members of the crowd. Any such will be attracted by the charming café at the end of the hall, where the eatables, prepared in the kitchen, will be served.

In the center of the café an artistic fountain will play, mingling its streams of water and spray with a flood of vari-colored lights, and will be surrounded by a bank of luxuriant palms. On each of the several tables will be an art lamp, which, together with the light from the fountain will be the only illumination in the room.

A comprehensive exhibit of all forms of electrical apparatus for domestic use will be shown, ranging from electricity driven washing machines to electrically heated curling irons and shaving mugs. Well informed attendants will explain the operation of each machine to those interested, and can give the cost for current to operate them.

Just outside the north door the "Test Car" will be found waiting to take a party over to the power house. Here the several types of reciprocating engines and turbines, used to drive the generators, will be fully explained. The operation of the switch-board will be made a feature of the inspection. Returning from the power plant the company will be treated to a program of magnetic and electrical freaks and fakes which they will never forget. Some will be mirth provoking, some mystifying, and all interesting and instructive. The demonstrators here are not

bound to tell the absolute truth, nor is any one expected to believe all which he may see.

To offset this frivolity, the next important attraction will be an exhibition of the very practical training which every Illinois graduate in electrical engineering receives in "first aid" to those injured by electrical shock.

We read much these days of protecting the movement of trains by means of automatic electric signals, but common as these are, few persons not in railroad work, know any thing about their operation. A complete miniature railroad system, operating several trains will demonstrate clearly how effective block signals are in preventing accidents.

Down stairs there will be exhibits of both resistance and arc type electric furnaces in operation, an electric welding machine, X-Ray, static discharge, and high voltage break-down tests. The high frequency exhibit will be one of the most complete exhibits ever given at any electric show. It will comprise two and possibly three distinct sets of apparatus. One small set will be about 500 watts capacity and may safely be used in demonstrating the physiological effects of high frequency current. The larger set has been built in the electrical laboratory especially for the show. It was designed by a graduate student of the department, and has been constructed by students. It will have a capacity of 10 k. w. which is the largest machine of this kind which has ever been built. The primary is supplied with current at a potential of 100,000 volts and the secondary will deliver it at a potential of from 3,000,000 to 5,000,000 volts at a frequency of 1,000,000 cycles. The current generated by this apparatus produces many strange results which are not observed with currents at ordinary frequencies. At this high frequency the current flows almost entirely on the surface of the conductor, so that sufficient current may readily be passed through the human body to light ordinary incandescent lamps, kindle gun powder, paper, etc., without any inconvenience. At this high voltage, vicious arcs over thirty inches long may easily be drawn. Corona effects are very pronounced. Blue flames shoot out into the air from a ball connected to the coil and an intense electric field exist all around so that without any connection whatever, Geissler tubes may be made to glow when brought in the vicinity. So far no practical use has been found for such current, except in

therapeutics, where good results are claimed for them in the treatment of certain diseases.

The department's storage battery of sixty cells and 240 ampere hours, together with the mercury arc rectifier, will be open to inspection.

The oscillograph is an instrument which is little known outside the electrical engineering profession, but it is so interesting and useful that the public will be given the rare opportunity of seeing it in operation. During the show it will be used to throw the exact form of an electric wave on the screen. It is by the use of this instrument that such men as Doctor Steinmetz have been able to prove their mathematical theories, and compel nature to give up such secrets as just exactly what happens during the first or the millionth of a second after the closing of a switch in an electrical circuit. Illinois is the possessor of three such instruments. The students here do more work with them than is done at any other technical school. The lecture here will explain the nature of alternating current in a manner which will make it understandable to all.

On the second floor a rest room is provided, where the only illumination is from Cooper Hewitt orthochromatic lamps. The light is a combination of mercury vapor and tungsten which is more nearly the equivalent of sun light than any other artificial illuminant.

The telephone and telegraph exhibits will be arranged to particularly interest the non-technical visitors. The methods of switching by automatic, manually operated central energy, and magnetic exchanges will be demonstrated and explained. The military department has loaned a field telegraph outfit, and members of the signal corps will demonstrate how quickly a line may be established and a message sent.

Those interested in illumination will find a novel exhibit arranged to show the effect of the light from various forms of electric lamps on the appearance of the colors of fabrics. Those in charge of this exhibit will be prepared to answer questions concerning the choice of lamps for certain uses.

The Physics department has been very generous in the loan of apparatus. An example of this is the photometry room filled with an exhibit of Geissler tubes. One tube, especially prepared for this show by Doctor Knipp, containing powdered willomite and

other chemicals will yield especially beautiful effects. The mercury still will also be an unusual sight.

For those not interested in the exhibits so far described, a demonstration of black art and magic will be put on by the students. Though the telautograph is not a part of this exhibit, its operation looks sufficiently mysterious to warrant such a combination. By means of this instrument it is as easy to transmit a written message as one which is spoken. The operator writes in the usual way with a pencil to which is attached two very light, freely moving arms. At the other end of the line the pencil of the receiving instrument is driven by two similiar arms which execute motion identical with those of the sending station. As a result the original writing is exactly duplicated.

While both local concerns and large manufacturers have furnished many exhibits complete, much work has been done by the students, many of the exhibits being completely built by them. In all of this work there has been the most complete harmony among the students. Those in charge have had the excellent experience of organizing the show and pushing their plans to completion, and every one who has had anything to do with the work has received full value for his time in experience and satisfaction. The faculty have co-operated with the students in every way, but at no time has it been necessary for them to step in and take charge.

THE EFFECTS OF FILLETS ON THE STRENGTH OF CAST IRON MACHINE PARTS

HARRY J. KLOTZ, '12, AND PAUL K. MILES, '12

The fact that the strength of pieces made of cast iron is increased by means of filleting the corners is generally known. But as far as a quantitative expression of the relation between the dimensions of the section and the radius of the fillet is concerned, no information has been available to guide designers. As was discovered when this investigation was under contemplation, information on the subject is very meager.

The lack of tests on this subject may be explained by two facts. First as generally known, cast iron is at best a very difficult material to investigate on account of its variation in quality. The results that are obtained by experiment and in practice have been found to be so at variance with those predicted by theory that the assumptions on which the theory is based must be seriously in error. This is due, no doubt, to the irregularities

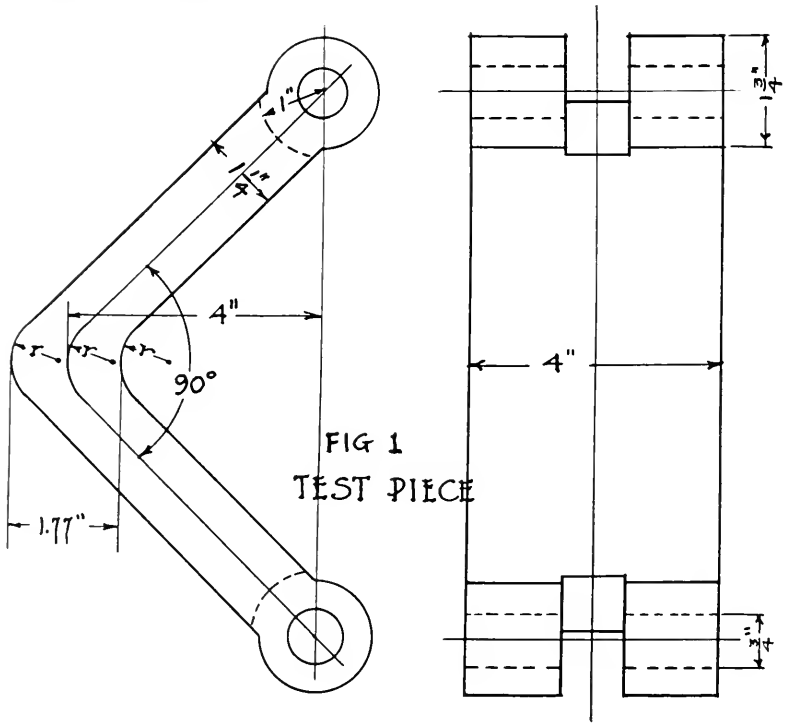

in cast iron. No assurance can be had that the quality of iron in any two pieces is near enough the same to permit of an absolute comparison. In fact, experience shows that the quality of metal in different parts of a specimen may vary considerably. The second reason for the absence of data on this subject is that designers have been content to pass over the problem without giving it due consideration. The usual practice has been to let the radius of the fillet to be governed by the general proportions of the piece. Under this mode of procedure, mistakes are bound to be made, and with the extent to which cast iron is used in the present day machine construction, it is readily seen that definite knowledge on the subject is really of considerable importance.

The character of the specimen which it was decided to use is shown in the Figure 1. The specimen was so designed that while the radius of the fillet might be varied, the depth of the section through the fillet and the moment arm of the applied force about that section would be kept constant. It was imperative that these two factors be maintained constant, in order that the results obtained from the specimens with different radii of fillets could be compared and the effects of the fillets shown directly. The piece was designed by the straight beam formula in ordinary use to break at a load of 10,000 pounds, as this load was a convenient one to handle on the testing machine at the disposal of the writers. It is believed that this test piece is more or less representative of conditions found in actual practice. It was recognized that cast iron is seldom used where subjected to pure tension. However, many cast iron machine parts are required to withstand tension due to combined bending and tensile stress, especially when the bending stress is large in proportion to the direct stress.

In order that the test pieces might be secured which would be strictly accurate and which would meet the requirements the writers themselves did the shop work involved. This consisted in making the patterns of the core boxes and in making the cores and setting up the moulds in the foundry. All this work was performed in the shops of the Mechanical Engineering Department of the university.

As a means of obtaining some clue as to what results might be expected and to aid in mapping out the procedure for the final tests, a series of preliminary tests was made. For these tests, four different sizes of fillets were used, namely fillets of zero

radius, (a sharp corner), one quarter, one half and one inch radii.

As a manner of applying the load it should be noted that the pins which held the eye bars were fitted in the specimens fairly tightly, while the fit of the pins in the eye bars was just sufficient to allow free turning of the bar about the pin. This reduces the friction of the pins to a minimum, thus preventing this source from causing any appreciable error by shifting the action line of the applied force and thus varying its moment arm. Care is taken to secure the piece in the testing machine so that the line of pull would be perpendicular to the transverse plane of symmetry of the piece. This was essential in order that the required four inch moment arm would be secured.

The feature which was strongly brought out by these preliminary tests was the fact that the specimen with the fillet of one half inch radius was the last to break in the fillet itself. That is, in the sharp cornered and the quarter and half inch radii specimens, the line of fracture started from the inside corner or center of the fillet, and proceeded across the section. But in the cases of the specimens having fillets of one inch radius, the fracture occurred in the straight part of the piece approximately at the point of tangency of the fillet with the straight side of the piece. This result showed that the desirable size of fillet for the piece of these proportions was somewhere between one half inch and one inch radius, since any further increase causes the break to occur in the straightest part of the piece closer to the line of action of the applied force. Because of this discovery, it was decided to include specimens with fillets of five-eighths, and three-quarters inch radius in the final test.

The specimens for the final series of tests were six sizes, having fillets of zero, one-quarter, one-half, five-eighths, three-quarters and one inch radii. Four specimens of each size were tested, thus making a total of twenty-four tests. In two of the sizes it was possible to make five tests due to a few extra castings being supplied. It was thought that it would be of interest to determine the effect of the fillets on the deflection of the pieces. For this purpose a Berry type removable extensometer was used. Two small holes were drilled in each specimen six inches apart and on a line parallel to the line of pull, to be used in attaching the extensometer to the piece. The load was increased by increments of five hundred pounds in some cases and one thousand in others, extensometer readings taken after each increase.

The results obtained agreed quite closely with those obtained in the preliminary tests. As before, the sharp cornered specimens failed noiselessly, while the breaking of the pieces with the one-quarter inch fillet was accompanied with a dull and scarcely audible snap. All the other specimens failed suddenly with a loud report. The manner of failure of the sharp cornered specimen bears out the curved beamed theory for curvatures of small radius, that is, pieces bent at right angles on themselves. In pieces of this kind the neutral fiber passes the inside edge of the sharp corner and, hence, no resistance to bending can be offered. Therefore, the slightest bending strain produces incipient rupture. Actually this condition does not exist because the stress distribution is so modified as to shift the neutral axis from its theoretical position. The character of the break, however, indicates that this position was approached.

The variability of cast iron is clearly shown by the results

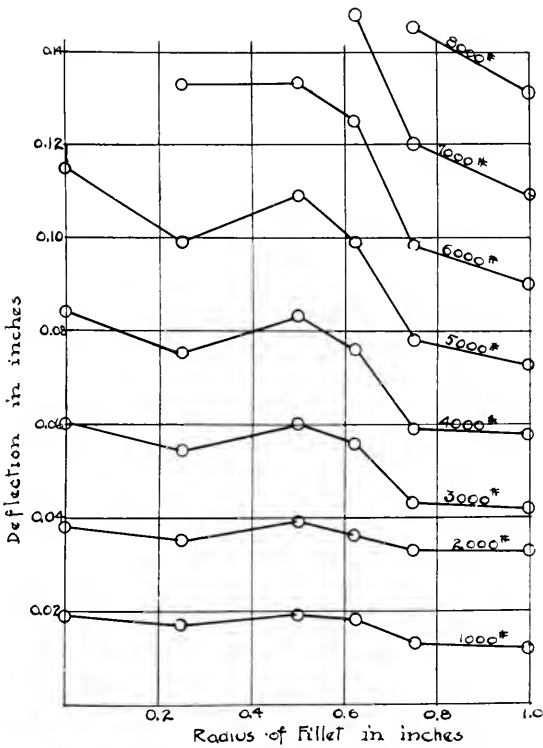

FIG 2- CURVES OF AVERAGE DEFLECTION

obtained. In some cases the breaking load of two specimens of the same dimensions differed as much as two thousand pounds. The curve, Figure 2, plotted between the breaking loads and the radii of the fillets, shows graphically the effect of the increased radius of the fillet on the strength of the piece.

In the case of the fillet of five-eighths radius the ideal condition of having all the specimens cast from the same heat was obtained. As would consequently be expected these specimens exhibited the least variation in breaking load between the several pieces. The curves plotted from the average deflections at various loads for the different radii show as might be expected, that the deflection at a given load decreases as strength of section is increased by increasing the radius of the fillet. Furthermore, the decrease in deflection due to the increased size of fillet is more marked at the higher loads. The quality of the iron accounts for the irregularity in the curves corresponding to those in the curves of average breaking loads.

The curve of average breaking loads indicates that the maximum effect of the fillet was not reached and that a larger fillet would still increase the strength of the piece. However, the fact that the specimens with the one inch fillet broke through the straight part indicate that this size of fillet is large enough to make the filleted section stronger than the straight section. The size of the fillet which will still accomplish this result is the desirable size, beyond which it is not expedient to go. The desirable size lies between the fillets of three-quarter and one inch radius. Therefore, since the one inch size lies on the safe side, and since the thickness of the straight section is one and one-quarter inches, the ratio of the radius of the fillet to the thickness of the section is one to one and a quarter. In other words, the radius of fillet advisable for this type of piece may be taken as eight tenths of a thickness of the section.

Note—The above is an abstract of a thesis prepared by Messrs. Klotz and Miles, for degree of B. S., in Mechanical Engineering, 1912.

POST GRADUATE WORK IN ELECTRICAL ENGINEERING

D. C. PRINCE, '12

Post Graduate in Electrical Engineering

The question is often asked, "What does a P. G. do?" The electrical P. G. does two kinds of things. First: He pursues definite courses of study in mathematics, advanced alternating currents and transient phenomena, electro-chemistry or thermodynamics. The object of these studies is to give the young engineer just enough more knowledge than the four year man to pass the latter on the ladder of progress, other things being equal. In all walks of life the difference between success and failure is found in some small advantage made use of or lost. The graduate students are not going to lose the advantage which this extra year of schooling gives them, you may be sure.

Again, the undergraduate course can not be complete. Here and there something has been omitted which, when added, in the graduate course, will make the engineer's knowledge more complete and rounded. These gaps are particularly apparent in the preliminary mathematics courses. The time allotted to mathematics in a four year engineering course is all too short. The fundamental operations are, indeed, covered, but many details are omitted. Large provinces are just touched upon. These points are all brought up in the graduate mathematics courses and amplified so that the engineer will at least, be able to work out for himself the problems in higher works of mathematics. The case of mathematics is typical. All the thermodynamics and chemistry that the average graduate knows have been crowded into a few short courses. These courses give hardly an idea of the size of the field to which they belong.

Research is the other branch of post graduate endeavor. Numerous times during the undergraduate course subjects have been touched upon, about which not much is known. One of these subjects has touched the imagination of the young engineer and he comes back to school that he may have an opportunity to discover more about this peculiar phenomenon than anybody else has found out. Every student has a different mystery which he

is determined to run down and clarify until it can be added to the store of every day knowledge. Many great fields are being explored by enthusiastic researchers. Their findings may not be of any great importance for some years but the start is being made. The graduate student is attempting to add to the world's wisdom instead of being a mere parasite absorbing, learning and giving nothing in return.

THE ENGINEER'S PLACE IN HISTORY

A. ELMENDORF, '14

In the years A. D. 451 and 732, two great battles were fought upon the plains of Gaul, the first at Chalons which decided that the Christian German folk and not the Pagan Huns should inherit the dominions of the dying Roman Empire; the second at Tours, also a victory of Christendom, but now over the invading Moslems; both were battles which determined the destinies of Europe and the future course of history. Here was committed to the issue of a single battle the existence of many nations. Yet, significant as the events were, they decided merely that one race rather than another should dominate the world. As landmarks on the path of a man's evolution from the savage through the barbarian to civilization, they are not prominent.

In this evolutionary history students of primitive man give places of honor not to battles and their instigators, but to great movements or changes in which man through some physical device acquired power over his environment. Thus, the use of fire gave him comfort and protected him from piercing winds and the night attacks of wild animals. The invention and use of the bow and arrow made him victor over animals physically stronger than he, the introduction of pottery started the home, the domestication of animals gave him additional power, the manufacture of iron produced better weapons. Finally the invention of the written alphabet raised him into a state of civilization. In every case the change was one of material improvement which added to his capacity for surviving unfavorable conditions such as a poor fruit supply, scarcity of game, or chilling north winds. Each invention characterized an epoch.

"But", says George S. Morison in his book, *The New Epoch*, "there is no reason why the epoch which began with writing should be the last. It needed only a new capacity radically unlike those which had gone before, to make an epoch in civilization as distinct as those in primitive society. Such new capacity has now been found; another epoch has begun. Fire, animal strength, and written language have in turn advanced men and nations; something like a new capacity was developed with the discovery of explosives and again in the invention of printing; but the capacity of man has always been limited to his own individual strength and that of the men and animals which he could con-

trol. His capacity is no longer so limited; man has now learned *to manufacture power*, and with the manufacture of power a new epoch began."

Students of prehistoric man name the various epochs by the tool in use then which was not prevalent in previous ages. Each tool passes through two stages, its creation and its introduction into use. Corresponding to these there is the inventor who conceives the instrument, and the engineer who makes a general application of it. In prehistoric races the inventor must have been, not one person, but an indefinite number of persons each of whom devised (perhaps unconsciously) some slight improvement. We are, however, not especially interested in the originators. "It was not the manufacture of the first earthen pot, but the general introduction of pottery which carried a prehistoric race from savagery to barbarism. It was not the invention of a few letters, but the general use of a written language which took the barbarian into civilization. It was not the invention of the first steam engine, but the general control of the manufacture of power which is now taking mankind into the new civilization." Here is manifested the duty of the engineer whose business is commonly defined as the directing of the great sources of power in nature for the use and convenience of man. The inventor precedes the engineer, but the products of his ingenuity are utilized by the latter. The savages who initially rotated the stick for producing friction and a spark were embryo engineers. The millers who first used the rushing rapid and fall were engineers. Often the inventor and the engineer are the same person, but the latter's work is more than complementary to that of the former. Watt developed his first successful steam engine in 1769, making him the inventor; in 1775 he manufactured and applied the engine to mine pumping, giving him the higher title of engineer. The engineer builds dams creating reservoirs, and directs the water either through tubes to exert its pressure upon the blades of a turbine, or leads it into canals to quench the thirst of plants on burning lands. The refreshed soil raises the corn, the turbine furnishes the power wherewith to grind it. In each instance the sources of power have been directed for man's use or convenience. In all ages then, the engineer was the instigator of new epochs.

Scarcely more than a century and a quarter has lapsed since James Watt made his notable improvements on the steam engine marking the dawn of the new era, and yet, when in history was

the face of the earth so transfigured, business methods so changed, government and education so revolutionized? Would United States be possible without its network of railways traversing the country enabling the senator from Oregon to reach the national capital in less time than it took Washington to travel from Virginia to New York? Of what value would Egypt be to Great Britain without the dams across the Nile for stopping the flood waters which subsequently irrigate the fertile yet barren river valley? When were the functions of government so numerous and so intricate; those of the school so extensive? In a few years we will be able to journey from the Cape to Cairo through jungle and over mountains where so many explorers sacrificed their lives. To-day we travel from St. Petersburg to Pekin across the rolling Steppes and wooded Taiga in a *train de luxe*, equipped with all the conveniences of a good hotel. Ocean leviathans designed by the engineer carry in safe confinement from one shore to another the population of a small city. Trainloads of freight are transported in the holds of the same ships. Hundreds of thousands of acres of semi-arid land in our West have been made to bear crops through irrigation. Soon great steamers will be able to pass from the Atlantic to the Pacific ocean in the space of a few hours by means of the Panama Canal. Scarcely less significant are the changes that have been wrought in the industries. Factories sometimes requiring as much as a hundred thousand horsepower, involving the investment of many millions of dollars, and employing ten thousand men or more have been erected. Such an aggregation of capital means concentration of control and management and sometimes of ownership bringing about corporations and monopolies with their problems.

Surely if great leaders and statesmen who determined the destinies of nations deserve a prominent place in the world's history, then too, the names of such eminent engineers as Watt, Ericsson, and Whitney should stand out before all others, for their work was greater than that of causing the rise or fall of a country or group of countries; they were instrumental in bringing about a universal change making possible a vastly larger population than had ever inhabited the earth before, a population composed of individuals who by directing the sources of power in nature must develop intellect rather than muscle, and through the greater output of the machine over human labor, may eventually be granted greater leisure in which to enjoy the satisfactions of life.

THE RELATION OF FRESHMAN AND SOPHOMORE WORK TO THE ENGINEERING COURSES

GUSTAV G. FORNOFF, '13

Business Manager, The Technograph

Every engineering student after having entered the university, at some time or another asks himself the question, "What good is this or that study going to do me in engineering?" The trouble is that the great majority of students, especially freshmen and sophomores who are required to take subjects which have no tangible relation to engineering, do not know the scope of a college education. They do not distinguish between a university and a trade school but enter with the idea that at the end of four years they can go out as engineers and make a fortune. With this conception of a college education they naturally can see no benefit in any but strictly engineering subjects. If they would stop to consider that, although there is only one electrical engineering course, it would be impossible for the university to turn out men that are efficient in all the various branches of the electrical profession, their views would change. If a course were to be given that would make men efficient in the main branches of the electrical profession such as the designing, construction, and operation of telegraph and telephone lines; the electrification of railways; electric light plants; motors; dynamos; switchboards; wiring; transmission lines; and electric devices of all kinds; considerably longer than four years would have to be spent not only in obtaining book information, but in doing extensive research work coupled with a thorough business course.

The general aim of the course at the university is to give the student a thorough training in all the subjects fundamental to the profession and such cultural subjects as will serve to place him on an equal footing, intellectually and socially, with men in other professions. With this object in view, all good technical schools are concerned with the mental development of their students. Everything included in the course should be looked upon as a mental tool to be used in a future career. For this reason some of the work included in the course is useful rather for the sharpening of the intellect and development of the mental faculties than for any real engineering knowledge. Knowledge alone is not power but the ability to use it, is. Most students

assume that the acquisition of information applicable to their proposed profession is the important element of an education. They thereby disregard development of the mental faculties which help them to foresee new methods of procedure and give them the power to acquire information with a knowledge of how to use it when obtained. This assumption is due to a wrong conception of a college education. A college education is not a trade school education but an education which makes wiser and more complete men and not machines. Besides making the student a wiser man, it trains and develops his faculties in the direction most useful to an engineer. To secure the greatest development, it is necessary to grow morally, mentally, and physically.

Students as a rule have very little use for physical training and military drill, but if it were not for the small amount of exercise connected with these requirements, most students would not get any. Many ask, "What good is English or rhetoric going to do me in engineering?" An engineer, if he is worthy of the title, must be capable of expressing his ideas and plans clearly and convincingly before his untrained capitalist; he must be able to direct the men that actually do the work and make his desires plausible to a less educated class of laborers; besides, he is in a position where he must answer numerous business letters each day, write out specifications and contracts, and prepare technical articles.

The only opportunity a student has to acquire expressive speech and composition is at college by becoming acquainted with the best English masterpieces and getting practice in theme writing. One has no idea of the awkward business letters many of our graduates write but when I took a course in business letter writing and the instructor brought a few letters from the morning's mail written by some of our former engineering students, it seemed hardly possible that they had a college education not only from the poor use of English and grammar, but also the crude style of addressing and folding of these letters. The course in descriptive geometry is not given to enable one to earn a living by passing planes through lines but to train the eye and develop the mind to be able to see things in space. An engineer does not have a model to go by, he must make the model and have a good idea of its success before spending capital for its construction. There is no necessity of speaking of the main feature of engineering,

namely: mathematics. It is an unquestionable fact that engineering is applied mathematics.

The university does not claim that its engineering students immediately upon graduation are engineers of mature judgment, but that their training and attainments enable them to make a rapid growth. They have received such training that by intelligent application of what they have learned, they may soon become engineers. My advice to the freshman or sophomore who questions the necessity of any of his studies is, that as long as the university authorities and graduates deem them worthy of the time spent, to stick to them and get as much from them as he can.

THE MAN AND THE INDUSTRY

A LECTURE BY HARRINGTON EMERSON

Reported by L. G. Smith, '13

Mr. Harrington Emerson was enthusiastically greeted by the engineering students and faculty on December 11, when he lectured on "The Man and the Industry". Mr. Emerson has been for some time a strong advocate of scientific management of shops and is well known throughout the country as an efficiency engineer.

Mr. Emerson discussed the development of our natural resources and showed how we have been neglecting the efficiency of our workmen because of the large unexpected returns from our natural resources and machines. We have accomplished a great deal within the last few decades, but this does not mean necessarily that our efficiency is higher than formerly. Efficiency and accomplishment are not synonymous terms. In the study of modern shop management, Taylor, Gilbert and others found that the methods of handling labor and material were so antiquated and inefficient that they have been seeking to perfect systems of organization that will make the workmen as efficient as the machines they operate.

In past years men have gained power and money by reaping the fruits of the labor of others. In the future, men will advance because they have rendered service to society. Marconi made a fortune not by exploiting others, but by giving to the world a new and better form of communication. The Standard Oil Company has been successful mainly because it has given society a better form of heating and lighting. To give society better service, means that the workmen must do their work more efficiently, and the most important instrument for increasing the efficiency is the proper type of organization. The science of organization is just in its infancy. Throughout the country, the systems of organization of the various corporations have been developed in a haphazard way and there are no two systems alike and very few of them are founded on a scientific study of existing conditions.

There is very little literature on the subject, which makes it almost imperative that experimenting be done before attempting to adopt any rational system of organization for any particular plant.

In the development of any system there are three types of men required to carry out the plans effectively, first, the mental type which has the ideals, second, the vital which gives personality, third, the motive which gives life and action to the system. It is of course an excellent thing to find all these types combined in one man, but usually one of these fundamental characteristics predominates in every man. In the United States, we have had our enterprises controlled mainly by men of the third type; our railroad presidents and corporation officials have been men of action rather than men of ideals or personality. The industrial friction between capital and labor has been caused mainly by the lack of leaders with strong personalities and high ideals. The modern trend of industry is to render the most effective service to the public, to the financial backer and to the workman. Service to the public consists in giving the people a larger quantity of goods of a better quality at a lower price. Service to the financial backer is rendered by giving better security and a higher rate of interest. Service to the workman consists in giving him higher reward for his service, fewer hours of labor and a wider field of industrial pursuits.

In the average manufacturing plant a great many precautions are taken to insure the economical use of material and to ascertain whether the quality of the material is up to that required in the specifications, but up to the present time very little attention has been paid to ascertaining the characteristics and aptitudes of the workmen by any scientific methods either before or after they are employed. Over three fourths, Mr. Emerson says, of the men employed in this country are not adapted to their work and this alone causes a tremendous loss in efficiency because no man can work well at a job in which he is not interested and for which he is not fitted. Besides the loss due to inefficiency there is also a great loss due to discontent among the workmen who do not like their work. Fully ninety per cent of the labor trouble in the shop could be eliminated by selecting men according to their aptitude for their work. The four essential qualities that are required of all men in any organization are health, intelligence, honesty and industry. These characteristics can easily be determined by the employer in a short time by a few simple tests.

Mr. Emerson described some of the methods of testing the character of men by their appearance. A single one of these methods does not assure the observer of the character of a man

but if they are all applied by an experienced man a fair estimate can be obtained. The texture of the skin can be taken as an indication of the texture of the brain, that is, a man having a fine, soft skin has a fine, delicately balanced brain and one having a coarse skin is the opposite. The texture of the skin, however, is not an indication of the power of the brain. The color of the skin is another indication of character. The blonde is usually like the lemon, tart, acid, impulsive; the brunette is more like the banana, mild, soft, deliberate; then of course, come all the gradations between the two. The general shape of the face of a man of the mental type is that of an inverted triangle, that of the vital type a circle and that of the motive type a square. A good example of each of these types is found in the three presidential candidates, Mr. Wilson being of the mental type, Mr. Taft of the vital and Mr. Roosevelt of the motive. The shape of the face profile can be used as an index to character. The convex profile signifies impatience, force and a domineering manner while the concave profile shows the opposite characteristics.

THE ELECTRICAL INSPECTION TRIP

H. CARL WOLF, '13

The most interesting inspection trip which has been allotted to the electrical engineers for several years was begun on Sunday evening, November 24, when 35 students, almost all seniors, left Urbana on two special cars. The crowd was under the tutelage of Professors Brooks and Paine, and Messrs. Fiske and James, great credit being due to Professor Brooks for the careful planning of the trip. The party was joined at Keokuk on Monday noon by five more students, and was met by guides of, and entertained at luncheon by, the Mississippi River Power Company.

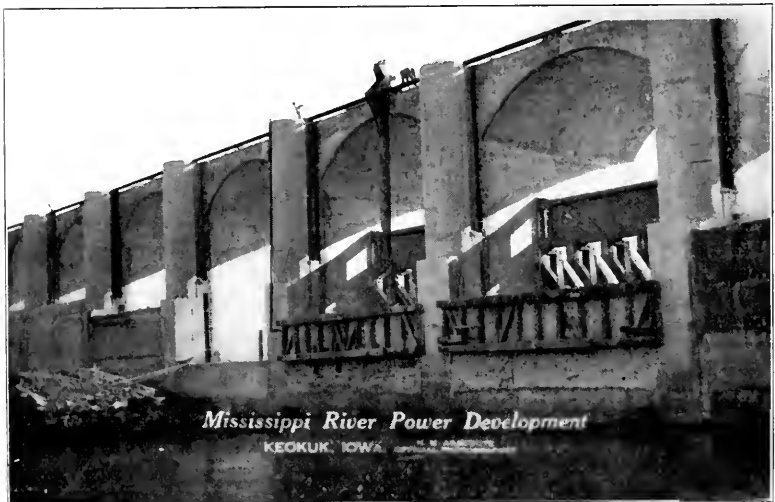

FIGURE 1

Immediately after luncheon, the inspection of the great works was begun and lasted until sundown, the party being broken up into several sections so that the minutest details of construction could be inspected.

The power house and the dam between Keokuk, Iowa, and Hamilton, Illinois, form the largest structure of the kind in the world, being built entirely of concrete and, when completed, will consist of 13,185 feet ($2\frac{1}{2}$ miles) of monolithic structure. The dam is tied to the Illinois shore on the east and ends in the power house on the west, after spanning the Des Moines Rapids in

119 arched spans for a total distance of 4,278 feet. The height of the water above the dam is to be controlled by steel gates set in slots at the side of the arches and controlled by a travelling crane running on a track on the top of the dam. The spillways in the arches which are of such a shape as to let the water down with the same curve that it would assume when flowing over any obstruction, are shown in Figure 1 in the course of construction, the forms being in place at the right. The general construction of the arches is shown in this view, together with the slots in which the control gates are to slide.

The power house which is to contain the first installation of 15 turbine units, each of 10,000 horse power capacity, is almost completed, and work will soon begin on that portion which is to cover the second installation of 15 units. The entire power house lies parallel with the river and extends from the dam, to the lock on the west, which in turn, will be linked to the shore through the government dry dock. The power house proper, covering $5\frac{1}{4}$ acres, consists of four floors, but is as high as an ordinary six story building. Figure 2 (frontispiece) shows the power house with the dam dimly seen in the distance. The wall in the immediate foreground is the sea-wall which is to protect the railroad tracks. Just behind this is the forebay, and all the construction shown within this will be torn away before the water is let into the works. The arches below the power house are the intakes for the turbines, and a portion of those for the second installation, are shown in the process of construction, on the right. The substructure is 78 feet high from the bottom of the river, and contains the intakes, turbines and draft-tubes. The intakes are of special form, each converging into a spiral scroll 39 feet in diameter, as it approaches the turbine in such a way as to give an equal pressure on all sides. The draft tubes empty into the tail-race which is excavated for $\frac{1}{2}$ mile to allow of free passage of the water. The intakes are protected by a double system of control gates, controlled by a travelling crane in the power house above, while a heavy wire screen keeps all debris from the turbines.

The turbines are directly connected through 25 inch shafts to the alternators above on the main floor, the entire weight of each unit, 550,000 pounds, being upheld by a combination roller and high pressure oil bearing. The alternators running at 57 revolutions per minute, develop power at 11,000 volts, three phase.

25 cycle, and are expected to show an efficiency of 85 per cent. The power is carried from the machines through special conduits to the second floor, through the oil switches and thence to transformers where it is stepped up to 110,000 volts. It is then taken through selector oil switches and out on the line. The system is well protected by aluminum cell lightning arresters, by large reactance coils, and by the use of high reactive apparatus throughout.

The exciter turbines, four in number, of 2,500 horse power capacity, have their individual intakes and draft tubes similar to the larger units. These turbines generate alternating current at 6,000 volts which is converted, at the individual power turbines, by rotary converters into direct current for excitation. The speed of all the turbines is controlled by sensitive high pressure oil governors, actuated by fly balls and controlling the guide vanes of the turbine.

The lock, which is to be the only avenue for traffic through the dam, will have a lift of 40 feet, and will convey boats from the upper to the lower level in one step. The inside length of the lock is 400 feet, with a width of 110 feet, thus making it larger than any of the famous Panama locks. A steel riser gate on the up-stream side, and a pair of massive steel swinging gates on the down-stream side are operated by pneumatic power and will control the entire lockage. The numerous concrete culverts in the bottom of the lock are controlled by hand levers and will either fill or empty the lock in 10 minutes. The dry dock will be used for the storage and repair of government river boats, and has been ceded to the government, along with the lock, by the power company.

When the inspection of the works was completed, the party returned to the hotel where dinner was provided for the party at the expense of the power company, and the boys were entertained royally during the short time of their stay. A party of 16 from Kansas University was at the same place, and a very pleasant time was enjoyed by all, a few lusty cheers for all the benefactors of the day, headed by the name of Hugh L. Cooper, chief engineer of the project, being indulged in.

The party departed for Chicago at 7:30 on the same special cars, and arrived there the next morning. Here, seven more students joined the crowd, and, after a short stop for breakfast, all proceeded to the Hawthorne works of the Western Electric

Company. This is the point from which all kinds of electrical machinery is distributed, and where the intricate telephone apparatus, the specialty of that company, is manufactured. The party was cordially welcomed by officials of the educational department of the company, and was shown through the plant by a number of former Illinois men. The immensity of the plant prohibited a minute inspection in the half-day allotted for it, but the principal points of interest were visited, and a general idea of telephone manufacture gained.

The plant of the Western Electric Company covers 200 acres and is a model of its kind, being laid out with commendable symmetry. From the time the raw material is brought under the supervision of the company, until the finished product, crated and stamped, leaves the factory, the least amount of work possible and the greatest system is employed, machinery being employed wherever practicable. The company maintains its own foundry in which are made practically all of the castings used in the telephone manufacture, its private gas and electric plants, water system, and employees' restaurant, besides encouraging athletics among the employees by maintaining a large athletic field. Among the interesting points of manufacture shown the party were the wire twisting, braid making, cable forming, and assembling. With the exception of the cable forming, the plant presents a very good example of small detail work, many of the parts used, and the instruments employed being so small and intricate as to be difficult of perception. In the cable forming plant, the various sizes of cables issue from the lead furnaces, which apply the lead coverings to the cores of twisted wires as they pass through steel dies within the furnace. In the assembly department are carried on the process of switchboard wiring and detail assembly, together with practical demonstrations of actual telephone practice.

The party left the Hawthorne works at noon and proceeded to the Fish Street station of the Commonwealth Edison Company. Here, Mr. W. L. Abbott and other officials of the company met and welcomed the bunch. Luncheon was enjoyed through courtesy of the company in their spacious dining room, after which the inspection of both the Fish and Quarry Street stations was made. The two plants are somewhat similar, differing chiefly in the finer points of construction. Alternating current at 2300 volts is generated by the turbo-alternators whence it is conveyed to the

substations and a large part of it converted into direct current. A careful arrangement of lightning arresters, oil switches and exciters gives the operator full control over the output and action of each machine. The most improved methods of coal handling and of firing, together with the use of air-cooled turbo-alternators, give a high efficiency to the plants.

On Tuesday morning, the trip was continued by a visit to the Illinois Steel Company's plant at South Chicago. Of special interest were the electric furnace, electric drive of the rolling mills and the use of dynamic braking, electric magnets, and electric cranes. The molten metal is carried from the blast furnaces to the Bessemer converters and open hearth furnaces by electric trains, and from there to the rolling mills in the form of ingots which are accordingly heated and rolled into plate or other desirable forms. The gases from the blast furnaces are utilized in engines which pump air back to the furnaces so that the energy of the gases is saved.

Leaving the steel works, the party returned to the city and, after luncheon, divided into two sections. One of these visited the plant of the Automatic Electric Company, while the other inspected the engineering features of Marshall Field's retail store. The Automatic plant was somewhat of a repetition of that of the Western Electric, showing even finer and more intricate detail work. The Marshall Field inspection presented several features in the shape of their illuminating system, electric elevators, refrigerating plant, and branch tunnel, all operated with the greatest smoothness and efficiency.

The inspection trip was officially ended with these towns, and the entire party disbanded for the Thanksgiving vacation, every member declaring himself to be well satisfied with the trip, and having the greatest praise for all who had been their royal hosts.

THE USE OF PERMUTIT IN WATER SOFTENING

J. F. GARRETT, '13

Permutit is the name chosen to designate an artificial zeolite recently produced and patented by Dr. R. Gans of the Royal Prussian Geol. Inst., of Berlin. The use of permutit is comparatively new and its commercial possibilities have been investigated only to a small extent. It is prepared by smelting aluminum silicates with sodium carbonate and sand, and washing out the excess of sodium carbonate with water. Its chemical formula is:— $2\text{SiO}_2 \cdot \text{Al}_2\text{O}_3 \cdot \text{Na}_2\text{O} \cdot 6\text{H}_2\text{O}$.

The most important characteristics of this compound are:

(1) Its property of interchanging bases.

This property is very significant, as by replacing the sodium base by other bases, it is possible to make a permutit of almost any metallic combination. Those of greatest interest however, are the exchange of sodium for calcium or magnesium by which the hardness of water can be reduced to zero. The iron, manganese and organic matter can also be removed from the water in a similar way.

(2) Its property of regeneration.

Upon passing hard water through permutit, the sodium content of the latter will eventually become exhausted, it being replaced by the calcium and magnesium contained in the water, hence it is necessary to regenerate it. This can be done by passing a 5% to 10% solution of common salt (NaCl) through the permutit.

(3) Its length of life.

Permutit can be regenerated an unlimited number of times without loss, hence it is never necessary to renew the charge in the filter.

The permutit filter consists of a steel shell made in various sizes for the treatment of various quantities of water, this shell being fitted with pipes and valves in order to give the necessary mechanical treatment to the water and also enable washing and regeneration with a salt solution. Inside this shell are placed various layers of gravel and sodium permutit, through which the water to be purified is passed at a comparatively rapid rate. In its passage the calcium and magnesium salts react with the permutit, turning the sodium permutit into calcium and magnesium permutit.

This process differs from most water-softening processes, in that an excess of insoluble reagent is used instead of a small amount of a soluble one.

Basch (*Jour. Ind. & Eng. Chem.*, Vol. 4, page 851) in an article on "The Use of Permutit to Purify Boiler Feed Waters", states, that the presence of alkali in waters prevents the corrosion of iron, but causes foaming; and that the presence of NaCl counteracts the effect of alkali on corrosion. Hence waters treated with permutit cause foaming, and yet do not prevent corrosion, because of the presence of small quantities of NaCl. However other writers state that at least fifty boiler plants in Germany and over one thousand in Germany, France, England, and United States are employing this system of treatment and none of them have had any trouble with corrosion, scale, or foaming, since this process was introduced.

It is claimed that for dyeing and bleaching purposes, water treated by the permutit method is equal to distilled water and is much cheaper.

The use of permutit for laundry purposes has many advantages over the lime and soda process. Water cannot be softened to less than $3\frac{1}{2}$ grains per gallon or sixty parts per million (CaCO_3) hardness by the lime and soda process, while it can be softened to zero by means of permutit. The cost of treatment of water of about 350 parts per million (CaCO_3) is approximately $2\frac{1}{2}$ cents per thousand gallons with either method. The permutit-treated waters also contain a considerable quantity of bi-carbonates and carbonates, both of which aid in cleaning and are ordinarily added to waters used for laundry purposes. Another important advantage of the permutit filter for laundries is that it automatically adjusts itself to waters of varying degrees of hardness. The mechanical adjustors used on lime and soda softeners are efficient for a short time, although they require constant attention, but the action of the lime soon throws the gears out of adjustment and hence the water is not properly treated. All of these difficulties are avoided in using a permutit softener.

H. G. Anders recently published the results of his investigations of permutit for use in breweries. (*Wochenschrift für Brauerei*, Vol. 28, page 78). He used a filter 31cm. in diameter and 33cm. in height, and containing 700 gms. of permutit. The analysis of the raw water gave the following composition in parts per million:

Dry residue	690.	
Ignited residue	620.	
SiO ₂	11.	
CaO	224.	
MgO	29.	
Temporary hardness	142.4	(CaCO ₃)
Permanent hardness	320.4	"
Total hardness	471.7	"

The analysis of the permutit treated water gave the following composition:

Dry residue	707	Parts per million.
Ignited residue	683	" " "
SiO ₂	24	" " "
CaO	0	" " "
MgO	0	" " "
NaHCO ₃	260	" " "
Na ₂ CO ₃	29	" " "
Na ₂ SO ₄	372	" " "

Mr. Anders found that the best results, with a filter of the above dimensions, were obtained with a flow of 88cc. per minute. At this rate, 700 gms. of permutit will soften 100 liters of water containing 356 to 498 parts per million (CaCO₃) hardness. But if the rate of flow was increased to four times the normal, the capacity was reduced to fifty liters.

The author states that only a few liters of 5% to 10% NaCl solution were necessary to completely regenerate the filter.

He states that the complete separation of the calcium and magnesium salts from the water can be made without difficulty. And that waters treated by this method fulfill all the requirements for boiler waters.

However upon investigating this water for use as mash and soaking waters he found that small quantities of sodium carbonate were present, and this is very deleterious to the action of malt and hops in the sweetening, clarifying and improving the taste of beer. It was found that this sodium carbonate was formed through the action of the carbon dioxide in the water upon the sodium permutit.

The author concludes that water treated with permutit is unsuitable for mash or soaking water because the alkali carbonates of the permutit-treated waters are less desirable than the cal-

cium salt of the natural waters because they are not precipitated out upon cooking. Also the sodium bi-carbonate is broken down by high temperature to sodium carbonate, which is very disadvantageous.

Thus it seems that permutit-treated waters can come into us in breweries only for boiler purposes.

In conclusion, some of the advantages to be derived from the use of permutit are :

- (1) Any water may be softened to any degree of hardness by regulating the flow.
- (2) The filter works automatically.
- (3) Variations in the feed water do not affect the filtrate.
- (4) The number of regenerations of the filter is unlimited.
- (5) Iron and manganese may be removed by using manganese permutit.
- (6) The process may be used in other industries ; for example, to recover potassium from the waste of sugar refineries.

The Technograph

Published quarterly during the college year, by students of the
ENGINEERING SOCIETIES OF THE UNIVERSITY OF ILLINOIS

Representing the interests of the Electrical, Mechanical, Civil, Chemical
and Mining Engineering Departments.

TECHNOGRAPH BOARD

H. W. UNDERHILL, '13	- - - - -	-	-	<i>Editor-in-Chief</i>
G. G. FORNOFF, '13	- - - - -	-	-	<i>Business Manager</i>
E. C. PROUTY, '14	- - - - -	-	-	<i>Asst. Business Manager</i>
G. H. STOUGH, '13	- - - - -	-	-	<i>President</i>
R. H. BACON, '14	- - - - -	-	-	<i>Secretary</i>
E. P. HERMAN, '13	- - - - -	-	-	<i>Editorial Staff</i>
A. ELMENDORF, '14	- - - - -	-	-	<i>Editorial Staff</i>
H. F. CROOKS, '13	- - - - -	-	-	<i>Editorial Staff</i>
W. LERICHE, '14	- - - - -	-	-	<i>Business Staff</i>

ADVISORY BOARD

W. F. M. GOSS, M. S. D. ENG.	- -	-	<i>Dean of the College of Engineering</i>
G. A. GOODENOUGH, M. E.	- -	-	<i>Professor of Thermodynamics</i>
I. O. BAKER, C. E. D. ENG.	- -	-	<i>Professor of Civil Engineering</i>
E. J. MEHREN, C. E., '06	- -	-	<i>Associate Editor, Engineering Record</i>
AVERY BRUNDAGE, C. E., '09	- -	-	<i>Civil Engineer for Holabird & Roche</i>

THE PUBLISHERS' ANNOUNCEMENT.

Subscription price, \$1.00 a year in advance. Subscriptions payable by Post Office or express money orders, bank checks, drafts or registered letters, made payable to THE TECHNOGRAPH. Money in letters at sender's risk.

ADVERTISING—The rates for advertising will be quoted on application. Copy should be in the hands of the publishers by the 10th of the month preceding publication.

THE TECHNOGRAPH,
Urbana, Ill.

EDITORIAL

THE TECHNOGRAPH is very fortunate in being able to present to its readers the article on "Training Engineers in the Science of Management". We are now in an era of industrial readjustment in which old time methods will give way to more effective and scientific methods. Mr. Benedict has ably covered a subject of vital interest to the college trained engineer. Industry is now demanding engineers with special training in the science of management and the clarion call is for the efficiency engineer.

THE EFFICIENCY ENGINEER

Mr. Benedict discusses scientific organization and the labor

problem. In "The Man and the Industry" by Harrington Emerson the noted efficiency engineer, a method of placing the labor problem upon a scientific basis is proposed whereby employees are chosen, depending upon certain facial characteristics.

The two articles deal with the subject in different and yet important phases, and merit the careful study of every engineering student.

We are proud of this issue! We think it contains more real live engineering discussion than any previous issue, and the best feature of it is—it's all Illinois. One faculty and ten students authors—every one an Illinois man. That is the standard for which we have long been striving—a genuine *student* publication. It is only possible by the co-operation and assistance of various students. If you have some interesting engineering information write it up and drop it in Room 100—it will be appreciated.

We are all human in that we think things in the big cities are better than the things at home. While this may be true in some cases it is not true of the E. E. show we will soon be privileged to attend. It is something that is not equalled in the big cities or by any other university. Boost it by attending and seeing that all of your friends do likewise. It is a big thing—typical of Illinois.

**THE
E. E.
SHOW**

COLLEGE NOTES

The class in mining methods including the juniors in mining engineering and in ceramics, on Saturday, December 7, visited the mine of M. & C. Coal Company of Decatur and the mine of the Niantic Coal Company at Niantic, in order to study the methods of mining used at these two mines. The same bed of coal is mined at the two mines, but by entirely different methods, this giving an excellent opportunity for comparing the different methods of mining.

The locomotive testing plant of the university which is located behind the Transportation Building, on Mathews avenue, and which is now nearly finished, it is said, will be the largest and most efficient of its kind in the world. There are few such plants in the United States and many of the things needed for this building are so hard to get that the construction has been delayed. It is hoped that the plant will be ready for occupancy within a month, and if the concrete roof can be finished before the very cold weather sets in, the erection will be facilitated greatly. A unique feature of the new laboratory will be a cinder separator, which is at present being built. The separator has caused wonder on the part of those who do not know what it is, for it looks like the base to a tall chimney or a silo. The purpose of the separator is to remove cinders from gases in locomotive smoke. With it exact data can be obtained concerning the amount of heat wasted in proportion to the amount of coal burned. The cinder separator is only a detail of the mechanism in the laboratory. Every test possible on locomotives will be possible in this plant, and it will be large enough to accommodate the largest locomotive now in existence.

Recently Dean Benjamin of the college of engineering of Purdue University, gave a very interesting lecture on "Scientific Management". The antiquity of the idea of efficiency was shown, and an interesting Biblical illustration of motion study given from the book of Judges.

The moral right of the employer to drive his men at maximum capacity and then to discard them when worn out, was questioned.

as was the wisdom of the attempt to introduce complex efficiency methods in small establishments. The great value of efficiency methods in handling material things in large quantities was emphasized, and the still greater importance of being sure of the harmonization of any system to existing conditions was clearly shown.

Dean W. F. M. Goss of the college of Engineering of the university was entertained at a dinner recently at the University Club, given by the local members of the American Society of Mechanical Engineers, in recognition of his election to the presidency of that society. President James, the members of the council of administration, and Dean Charles H. Benjamin of Purdue University, were among the guests present. Professor Ira O. Baker acted as toastmaster of the occasion.

Professor A. N. Talbot talked on the national engineering societies. Dean Goss was tendered congratulations by President James, and greetings were also tendered from Purdue University through its representative, Dean Charles H. Benjamin of the college of engineering of that institution. Dean Goss expressed his thanks in his response.

At the meeting of the American Society of Mechanical Engineers held in New York City recently, Dean W. F. M. Goss of the College of Engineering of the university, was elected president of the society for the ensuing year. This election of Dean Goss to the highest office in the gift of the society, comes as a recognition of his attainments as an engineer and educator and of his noteworthy contributions to the science of engineering.

Since the organization of the society in 1880, only three other college professors have been honored with the presidency, Dr. Robert W. Thurston of Cornell University, Professor F. H. Hutton of Columbia University, and President Alexander C. Humphreys of Stevens Institute. Dean Goss makes the fourth collegian to be elected to the position.

On December 18, a special engineering convocation was held to permit the general faculty and the students in the College of Engineering to express their appreciation of the honor paid Dean Goss. Brief addresses were made by President Edmund J.

James and Prof. A. N. Talbot, after which Prof. Ira O. Baker presented to Dean Goss a beautifully engrossed testimonial signed by representatives of the faculty and the various engineering organizations as follows:

Dr. William Freeman Myrick Goss, Dean of the College of Engineering of the University of Illinois, having recently been installed as President of The American Society of Mechanical Engineers,—we, his co-laborers in the College of Engineering, the fellow members in that society at the University of Illinois, and the students of the College of Engineering offer this testimonial of appreciation of the honor that has been conferred upon him, an honor richly deserved because of his long and eminent service in the field of engineering education, his researches and contributions to the advancement of engineering science, and his high qualities as a man and a friend.

About 200 men attended the smoker given jointly by the Electrical Engineering Society and the student section of the American Institute of Electrical Engineers. The object of the meeting was to promote enthusiasm for the E. E. Show, which is going to be given at the Electrical Engineering Laboratory on February 6, 7, and 8. The committee in charge of the smoker furnished an excellent program, and also provided an abundance of smokes and eats.

WOOD ADDRESSES SOCIETY

D. C. Wood, president of the E. E. Society, in the opening address told about the plans which were being made for the E. E. show. He said that the success or failure of it depended entirely upon the work which individual members of these societies did. Two Japanese students, I. Pung and J. Panhoe, who were next on the program played some Japanese pieces which were greatly appreciated by the audience.

President Wood introduced Professor Paine of the E. E. Department. The latter spoke about the work which was being done by the A. I. E. E. and the provisions which it made for accepting student members. He told of the advantages which were offered to members and urged that all upperclassmen should join.

E. E. SHOW MANAGERS SPEAK

Professors Fisk and Hake also of the E. E. Department, each gave very interesting and instructive talks on the A. I. E. E. A musical number by the E. E. glee club made a big hit with the electricians, and they were forced to give several encores. The men in charge of the E. E. Show, C. R. Horrell, business manager; L. A. Dole, advertising manager; and G. L. Levis, chief electrician, each gave short talks, endeavoring to get all the E. E.'s interested in the society's show. They plan to make this one of the best ever given by a university.

MANDOLIN CLUB IN SELECTION

After this the E. E. mandolin and guitar club rendered several pieces, ending with the "Illinois Loyalty", which was sung by everybody present. The last number on the program, although not of a technical nature, was very entertaining. It was given by W. W. Peters, a graduate student who made some prestigitorial remarks. Peters, as an amateur, performed some wonderful magical stunts, mystifying the audience by his card and sleight of hand tricks. His last and best stunt was when he removed "Shorty" Dole's shirt from his back without taking his coat off. Following the program, the remainder of the evening was spent in singing songs.

K. H. Talbot, '09, who has been associated with the Portland Cement Company for the past three years, gave a lecture to the students of the Engineering College on the subject of concrete, which included its use for road construction.

In speaking of the new roads made of concrete, he stated that there are three different types of concrete pavement in use today. The first kind to be used was known as the compressed type and was introduced in the East. A large amount of road of this kind was made in New York. Some of the roads are made of two layers of concrete. Sand is used in the finishing course in place of gravel. In order to hold the road together, it is advised that headers be run into the side of the road bed. The first concrete to be built was made in Ohio in 1893.

One of the principle features to be brought out was the necessity of having a good drainage system. This is secured by a series of curbs which lead the waste to the catch basins. In order to keep the cement from splitting up, expansion joints are used.

Part of the hour was taken up with showing a large number of slides illustrating the manner of carrying on the work in constructing a concrete road.

Mr. S. Rosenzweiz, engineer of the Erie City Iron Works, lectured on poppet valve engines and superheated steam, before the student branch of the American Society of Mechanical Engineers, Friday, December 6, at p. m. in the engineering lecture room.

Mr. Rosenzweiz is an eminent German engineer who has come to this country to demonstrate the great increase in steam engine economy gained by the use of superheated steam; and also to represent the Leutz poppet valve engine. The German engineers, because of the high cost of fuel, have been obliged to seek methods of increasing the efficiencies of their engines, while American engineers until within the last few years, have not been very much interested in steam economy, because of the comparatively cheap cost of fuel. On account of this fact the science of the steam engine has advanced a great deal further in Germany than in this country.

Superheating the steam before it enters the cylinder has proved in practice to be the best and most profitable means of increasing the efficiency, but with the ordinary type of four-valve slide valve engine considerable trouble has been experienced in obtaining packings that will withstand the high temperatures. In Germany several new types of engines have been designed especially for superheated steam. The Leutz engine is one of these which has shown wonderful economy, and is at present very popular in Europe. Mr. Rosenzweiz has been in close touch with the recent development in steam engineering in this country and abroad.

RESEARCH WORK

"An Extension of the Dewey Decimal System of Classification Applied to the Engineering Industries", by L. P. Breckenridge and G. A. Goodenough, was originally issued as Bulletin No. 9 of the Engineering Experiment Station in 1906.

The filing and classification of engineering data has become a matter of much importance, and this bulletin was prepared for use as a guide in carrying out such work. The original edition of Bulletin No. 9 was subject to the usual gratuitous distribution, and the subsequent demands were such that a second edition was printed and ultimately distributed. Altogether 20,000 copies were sent out. The demand having continued, it was finally decided again to revise and to print a limited edition. This has now been accomplished and the revised bulletin, much extended as compared with the original edition, is ready for distribution. It presents subdivisions of subjects in such detail as to constitute a complete classification for most engineering industries, even though they are highly specialized. The revision has been made in accordance with the 1911 edition of "Decimal Classification" by Melvil Dewey.

The revised edition of Bulletin No. 9 will not be subject to gratuitous distribution. A copy will be sent post-paid upon the receipt of fifty cents.

Bulletin No. 61, "Characteristics and Limitations of the Series Transformer", by H. R. Woodrow and A. R. Anderson has just been issued by the Engineering Experiment Station of the University of Illinois. In determining the action of electrical circuits of high voltage or of heavy currents, it is often desirable to connect instruments into a circuit which is not metallically connected with the main circuit, but which is so arranged as to carry a current bearing a known relation to the current of the main circuit. These conditions are met in practice by the use of the "series" or "current" transformer. Bulletin No. 61 presents the results of a theoretical study of such transformers and sets forth the conditions affecting the ratio of secondary to primary current, and the phase angle between them. A typical transformer is chosen as an example and curves are presented showing variations in the value of the different constants of the transformer, in its relation to secondary load and to variations in conditions of operation. It is shown that, in general, the current ratio decreases and the phase angle increases with decreasing primary current. In a series of short-circuited tests on alternators, in which current transformers were used, it was found that the transient phenomena as recorded by the oscillograph did not check closely with the calculated results. The bulletin demonstrates the inadequacy of the series transformer, especially when constructed with an iron core, for the recording of transient phenomena. It shows that in transient work it is desirable to use an air core transformer with low secondary resistance and high secondary reactance.

"The Electron Theory of Magnetism", by E. H. Williams, has just been issued as Bulletin 62 of the Engineering Experiment Station of the University of Illinois.

In the study of physical phenomena various theories have been advanced, from time to time, as to the nature of magnetism. The most interesting and important of these is the electron theory. The bulletin traces the experimental advance leading to the development of this theory in its present status, and points out phenomena which the theory in its present form fails satisfactorily to explain. It shows, for example, that fundamental qualities in nature, such as the mass of a hydrogen atom, when determined by methods based on the electron theory from experimental data obtained with iron, nickel, and cobalt, check very closely with accepted results obtained by various other methods. It shows also that to account for the magnetic properties of purely magnetic substances, there must exist between the molecular magnets of those substances an internal magnetic field whose magnetic force is of a magnitude of not less than 6,000,000 units.

Copies of these bulletins may be obtained upon application to W. F. M. Goss, Director of the Engineering Experiment Station, University of Illinois, Urbana, Illinois.

TRADE NOTES

GRAPHITE AS A SURFACER

Lubrication is the life of a moving mechanical part. If you neglect lubrication or do it on a hit-and-miss principle, you pay for the broken parts, shut-downs and other kindred troubles. The road to the junk heap is made an easy one if insufficient or inferior lubricants are used.

No matter how well you may think a piece of machinery is lubricated, unless provision is made for the time when oil or grease fail to do their duty (caused by an obstructed oil channel, overload, leaks, etc.), serious abrasion is likely to take place and it is then the lubricant which can stand up under adverse conditions, take its knocks and is not thin skinned, that protects against losses. Flake graphite will keep metal surfaces apart, because of its affinity for metal surfaces and its ability to knit up over them a covering, tough, thin and unctuous to a high degree.

—Dixon's *Graphite*.

The Joseph Dixon Crucible Company publish a spicy monthly trade journal termed *Graphite*. It is of value to the efficient engineer and is sent free on request. Apply to the company at Jersey City, New Jersey.

"The Joseph Dixon Crucible Company of Jersey City makes the interesting announcement that the selling price of their Silica-Graphite "One Quality Only" paint is reduced. They say they make this reduction because the decrease in the price of linseed oil, which used as the vehicle, enables them to do it, and because it is their aim at all times to give their customers any benefit possible in reduction of price of materials.

This well-known paint which has been the standard for nearly 50 years with leading railroads and manufacturing plants as a maintenance paint, is a perfect, long service protector of all exposed steel and metal surfaces."

The Wickes Vertical Water Tube Boiler

THE BOILER OF SCIENCE

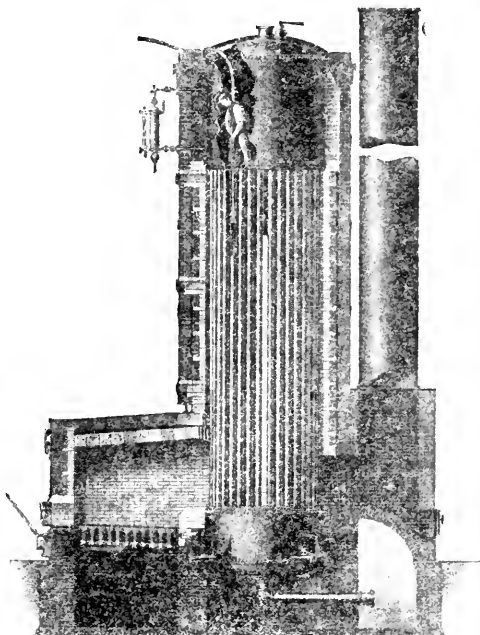

BECAUSE

No idle money required to be tied up in boilers standing idle any length of time for cleaning. Therefore, the unit cost of power due to investment and maintenance is held to a minimum.

Two 12 x 16 inch manholes opened, this boiler is accessible from top to bottom for inspection and cleaning. The tubes are straight; every tube can be looked through, washed or scraped. The cut shows a man standing erect, using turbine cleaner. Is it laborious compared with other forms? Two men can open, scrape and close this boiler in ten hours.

High furnace temperature results from Dutch oven; gases closely scrub heating surface. No chance for short-circuiting; no chance for gases to enter pockets unfilled with heating surface. Very long gas travel provided.

Great height from water level to steam outfit provides room for separation from steam of entrained water, hence dry steam enters steam outlet.

THERE ARE OTHER POINTS

Ask Us for Literature and Investigate. It will Pay You.

THE WICKES BOILER CO.

Main Office and Works: SAGINAW, MICH.

Sales Offices in Principal Cities

When writing to advertisers please mention THE TECHNOGRAPH

Have You Learned How



"From the Raw to the Finished Product"

—a 72 page booklet descriptive of the "Chicago AA" process of manufacture. Illustrated with 66 halftone engravings from photos taken at our mills.

FREE

to cement-users. Write for a copy today.



"Chicago AA"

Portland Cement is made?

It is a story of great interest to the man who uses cement. It tells how the raw materials are taken from the quarries, how they are weighed, proportioned, crushed and conveyed to the mills; it describes the "Chicago AA" process of drying, grinding and then burning the raw mixture to a "clinker" and explains, in an interesting way, the method of cooling the "clinker" and grinding and re-grinding it, thus producing "Chicago AA" Portland Cement, "the best that can be made."

Read this story: It will enable you to better appreciate the superiority of the "Double A" brand—it will guide you in the selection of a cement for your work in the future.

Chicago Portland Cement Co.
30 No. LaSalle Street, Chicago, Ill.

Manufacturers of the

"Chicago AA" Brand

"The Best That Can Be Made"

Present Output **1,500,000** Barrels Annually

When writing to advertisers please mention THE TECHNOGRAPH

cap 2

THE TECH- NOGRAPH



MARCH, 1913

VOLUME XXVII

NUMBER 3

Students' Engineers' Course



Class of Student Salesmen recently transferred from the Student Engineers' Course to the Commercial Department. These men are given thorough training in commercial work and are then assigned to the different commercial offices of the Company. Three of these classes are now transferred each year.

Why We Advertise For Student Engineers

The General Electric Company is now advertising for Technical Graduates to enter its Testing Department (Student Engineer's Course), because the positions open for men who have had this training are so numerous that it is difficult to keep enough men in the Testing Department to test the machines as fast as they are built.

During 1912, 307 men entered the Testing Department, a considerably larger number than entered in any previous year. During the same year 112 men were transferred to the Commercial Department, 73 to the Engineering Department and forty to other departments, while about 100 accepted positions with outside organizations that have asked the Company to recommend trained men for their work.

For further information address Mr. G. H. Pfeif, Secretary Students' Committee, General Electric Company, Schenectady, N. Y.

General Electric Company

Largest Electrical Manufacturer in the World

General Office, Schenectady, N. Y.

Sales Offices in fifty-two cities

3825



When writing to advertisers please mention **THE TECHNOGRAPH**

WELLER-MADE



- Modern Machinery
- Superior Construction and Quality
- Prompt Attention

POWER TRANSMISSION

is the most effective and costs the least, when WELLER equipment is used. Write for prices on: Rope Drives, Shafting, Bearings, Gears, Friction Clutches, Sprockets, Pulleys, Belting

and for our No. 20 Catalog

WELLER MFG. CO.
CHICAGO

New York Office, 50 Church Street

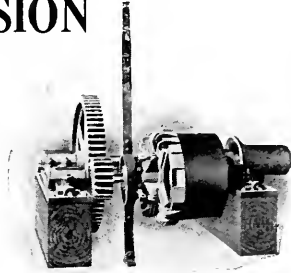

THE CO-OP.

Do you know that Co-Op. carries
nearly every Scientific
Magazine published

Come in and look them over

THE CO-OP.

When writing to advertisers please mention THE TECHNOGRAPH

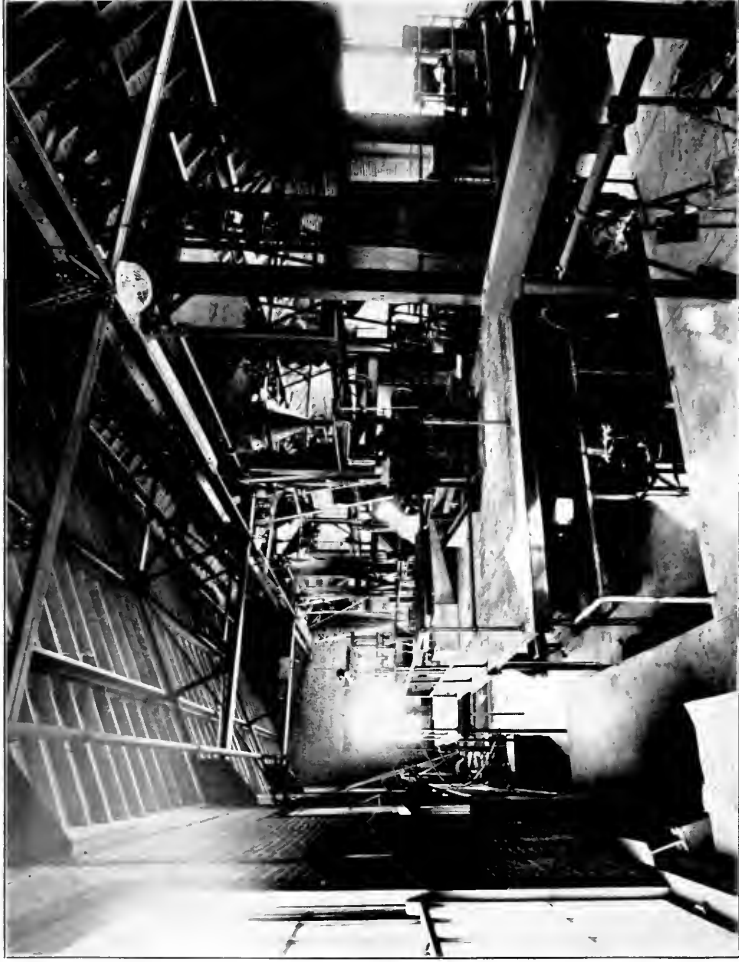

FIGURE 1. (See page 125.)
THE NEW MINING ENGINEERING LABORATORY, UNIVERSITY OF ILLINOIS

The Technograph

VOL. XXVII

MARCH, 1913

No. 3

A FEW MODERN IDEAS OF FACTORY MANAGEMENT SEEN IN APPLICATION

C. W. LINCOLN, Ex-'14

In a large manufacturing establishment, employing hundreds of men, using many machine tools of widely different kinds, and turning out its finished products in immense quantities, the chief problems which arise in the operation of a smaller shop—namely, securing satisfactory design of product, determination of most economical methods of performing various operations required on pieces, and production of tools and equipment for carrying out these methods—give way in degree of importance to such matters as getting to each department of the factory orders and information, whenever needed, such that the department may never lack work and may know which of the work at hand is most badly needed, keeping work moving without delay through the plant, so that one department need not wait upon another, and maintaining quickly available records of things such as amounts of raw materials in stock, progress of various lots of parts through their long respective programs of operations, quantities of finished parts held ready for assembling, and numbers of completed articles shipped on orders. In short, it is harder for a large factory to “go at” its work and to keep in view just how it “stands” than it is for it actually to do the work. It will be the purpose of this article to discuss the general *manner* of manufacture, rather than any particular design of product or any particular machine methods, found in the plant of the Aurora Automatic Machinery Company at Aurora, Illinois. This somewhat broad theme, manner of manufacture, we may divide into the following subtopics—arrangement of plant, organization and administration of factory, design of products, determination of proper machine methods for performing individual operations (including design and manufacture of tools, jigs, and

special machinery), issuing of orders to outside firms for raw materials and purchased parts and to respective factory departments for work to be performed in those departments, inspection of work during its transformation from raw stock into finished parts, and keeping of records concerning quantities of raw materials and finished parts on hand and progress of various lots of parts in process of manufacture; these we shall take up in the order stated.

The plant in question occupies about half of a city block. The construction is of brick and wood, that known among insurance men as "slow burning". The establishment comprises some four buildings, but these are so joined together as to make practically

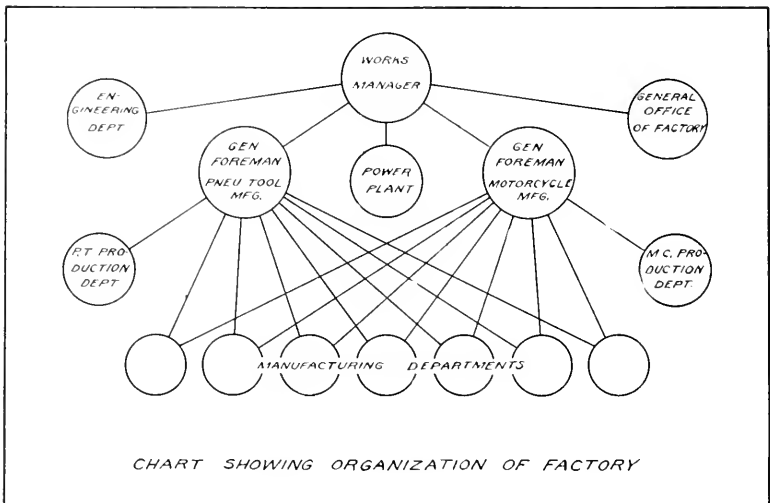

a unit structure consisting of a long continuous section forming one of the longer boundaries and three shorter sections extending from the first perpendicularly toward the rear. One part of the building has five stories, the rest four. Stairways housed in brick vestibules, adjacent to but outside of the buildings proper, are a feature of the structure; it is also worth noting that a complete automatic sprinkler system and self closing fire doors are maintained. The position occupied by certain departments and the reasons why they are occupied by such departments are interesting, and may well be considered briefly. The statement that the two products of the plant are motorcycles and pneumatic tools, such as drills and riveting hammers, will aid in keeping

in mind what departments are needed in making the products and what sort of work we may expect to find in each department. The raw stock departments are on the first floor, and communicate directly with the receiving room. The shipping room is also on the first floor. A small two story building connected with the plant proper by means of covered truckways only, houses in its first story the stocks of castings, forgings, bar and sheet metal, and in its second the enameling department. Hence, a fire in the enameling department could do practically no damage beyond burning the comparatively inexpensive building in which the department is contained. For like reasons, the blacksmith department occupies a one story addition to one of the sections of the plant proper. The sand-blasting room is on the first floor, and is the first room encountered as one progresses from the stock rooms into the rest of the plant. The first operation on all castings being sand-blasting, the stock moves to this room and then on to other operations without going "out of its way". The turret lathe and automatic screw machine departments, in which are performed practically all first operations on bar stock, are located on floors directly above the stock rooms; and the bars, having been cut into convenient lengths in the latter places, are sent by elevator to the departments mentioned, whence they pass on to succeeding operations. The inspection room is located on the second floor, practically in the center of the complete establishment; such a position seems logical when the fact that pieces must travel to and fro between this and all other departments of the factory is taken into consideration. Various machine departments complete the first, second, and third floors. The top floors, however, are occupied by departments that do not, in general, take part in the routine production of duplicate parts, and that do not impose great weight upon floors. The advantage of the former characteristic is that the space traveled to and from which would incur the greatest expenditure of labor and loss of time is occupied by departments to and from which travel is unnecessary. Examples of top floor departments are the general factory office, the offices of the "mechanical", or engineering department, the drafting room, the pattern shop, the tool room, the repair departments, and the motorcycle assembling department. The power plant is situated between two of the shorter sections of the establishment, and is supplied with a switch track for bringing in of coal and hauling away of ashes.

Electricity is the means of transmission of power through the shop, a large generator driven through rope transmission by a Corliss engine being the chief source of supply of current to from one to three motors in each department, each motor being belted to an independent line shaft. The power plant is under the direction of an engineer who has in charge as well all electrical wiring, sanitation, ventilation, steam-fitting and other plumbing, and general maintenance of buildings. Care is taken to keep the buildings neat, clean, and in good repair; the effort made so to do is, no doubt, rewarded by its psychological effect upon the workmen, said effect tending in the end toward increased efficiency.

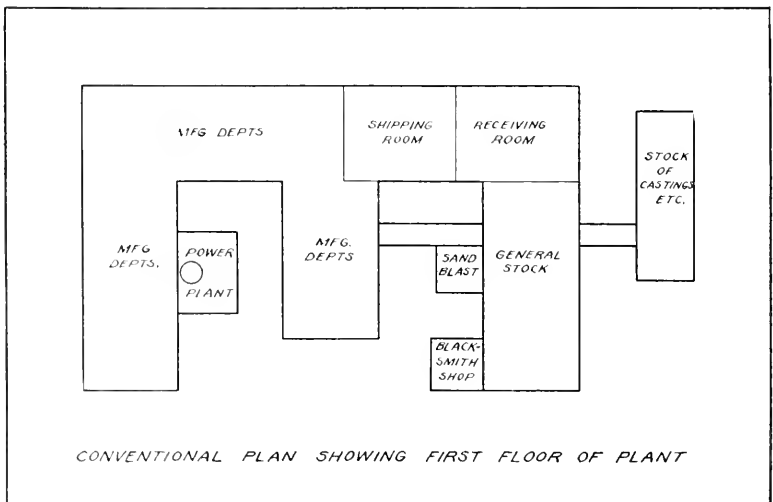

In taking up the organization of the factory we shall leave out of consideration the officers of the company and the sales organization, as these do not concern us. We begin with the works manager, who is responsible to the company officers only, and to whom are responsible all others directly connected with the factory. Beneath the works manager we find five divisions of practically equal rank, none having authority over the other; these are: (1) the general office of the factory, (2) the engineering departments, (3) the general foreman of pneumatic tool manufacturing, (4) the general foreman of motorcycle manufacturing—in most establishments (3) and (4) would be replaced by a single division—and (5) the power plant. The head of the gen-

eral office is the chief clerk, whose forces comprise the purchasing, receiving, shipping, time-keeping, pay-roll, and cost-keeping departments; it falls also upon the general office to maintain messenger service and telephone service in the factory. The head of engineering departments is the chief engineer, below whom stand the chief designer of pneumatic tools and the chief designer of motorcycles. Below these two and subordinate to both are the tool-designing and -making departments, the drafting room, and the foremen of the experimental rooms. Below each general foreman we find his "production" department; below the two general foremen and subordinate to both we find the foremen of the different manufacturing departments—milling machine, drill press, grinding, plating and polishing, and the like. There are, of course, some of the manufacturing departments that do the work of one or the other general foreman only, and in these there is no conflict of authority; but in departments subject to both foremen there must be at times some means of deciding whose orders are to have preference. This means is found in reference on through to the works manager, who gives the final word in case of conflict. It scarcely need be said that the two general foremen are men of some reason, and that in consequence they usually adjust their own differences without calling in a third party. The organization of the power plant was brought up in the preceding paragraph, and need not be discussed further. Attention is called to the fact that the organization of the "actual manufacturing" departments is that in which all machines or all operations of one distinctive type are grouped in one department under a foreman who is an expert on the work placed in his charge. The alternative method, that of performing in one department *all* operations on parts of one type, finds its chief application in factories whose products are made up of few, large, difficultly handled parts; this latter method is, no doubt, the better, as it eliminates a large amount of unnecessary handling. In the plant under discussion, however, the pieces to be made are small and of many different types which facts seem to make the former method of organization the one better adapted to the work.

We shall now glance at the work of the engineering departments. The designers, acting on suggestions received through the chief engineer from the works manager, work out such new devices and improvements on old devices as may seem demanded

by the market. All such devices are made up in the experimental rooms, and are thoroughly tested out before being placed in line for regular manufacture. The designing department supervises the work of the drafting department, in which is done all drafting not classified as designing; likewise the blue-print department. It also has charge of deciding what shall be the order of the various operations which must be performed on respective parts, and what machine methods are to be used in respective operations. These methods, stated for each piece in the order decided upon, constitute what is called the "lay-out" of the part, and each foreman who does work on a piece is given not only a blue-print of it, but a copy as well of that portion of the "lay-out" which concerns him. Each single part is the subject of an individual detail blue-print of one of several standard sizes. The next important function of the designing department is, probably, the supervision of the working out and making of suitable jigs and tools for performing operations rapidly and well; and still another function is to write specifications for purchased material, whether in the form of raw stock or finished parts.

In turning our attention from designing to the issuing of orders for such material and labor as may be needed for completing certain predetermined quantities of machines, we obtain our first view of the "production" departments. As the functions of the two departments correspond throughout, we may limit our consideration to one only, say that having charge of motorcycle production. The three primary functions of this department are: (1) to issue orders for all material and labor required for all motorcycle manufacturing done in the shop, (2) to determine which part of the work ahead in any department is to be done first, and (3) to keep records which will show at any time just how near completion any certain piece of work stands. It having been decided by the company officers to "put through" a certain number of motorcycles, the production department is notified to this effect through the works manager and the general foreman. The department then formulates lists of raw material and purchased parts required to complete the lot of machines in question, making allowances for spoilage during manufacture, and sends to the purchasing department requisitions for said material and parts. Next the department issues orders for work, one covering each operation on the quantity of each different part needed, and sends these orders to the respective

manufacturing departments in which the various operations are to be performed. As the raw material comes in, it passes through the receiving- and stock-rooms to the department which is to perform the first operation. This operation over, the foreman passes the work on to the department next to handle it, sending with it a slip stating the number of pieces in the consignment, the number (one, in this case) of the operation just performed, and the serial number of the lot of machines for which the parts are being made. This slip is made out in triplicate; one copy goes as a notification of arrival to the foreman receiving the work, another remains with the work until replaced by the slip for the next operation, and the third is sent to the production department. For each separate part needed on a motorcycle of the type called for, the latter department keeps a large sheet having a column for each operation to which the part is subject. As soon as a slip is received, the number of pieces marked thereon is posted to the proper column of the sheet; in this way the production department may know at any time, by merely glancing at the sheet, just how the lot of parts is progressing. After assembly has begun, there are times, of course, when some pieces must be worked in shorter order than others; it then falls upon the production department to see that work on these pieces is given preference in the manufacturing departments. This is done by sending notices to the foreman to rush work on the pieces mentioned, and by having each foreman mark with the word "rush" the slip which accompanies these pieces as they leave his department.

If one were to look at the "lay-out" of any part he would notice every third or fourth operation to be listed as "inspection," each lot of parts being examined carefully in the inspection department after each two or three manufacturing operations. The inspection room is equipped with a comprehensive outlay of gauges, testing jigs, and fine measuring instruments, and is provided with the allowable limits of inaccuracy for each dimension found on each part which manufactured in the plant. If any dimension exceeds its limits, the faulty piece is returned to be repaired, or is consigned to the scrap-heap if repair is impossible. With this system of inspection any imperfection of material or workmanship is detected as soon as it is in sight, and no time is wasted doing further work on pieces already spoiled. The system is rather expensive to maintain, but it is excellent insurance of the quality of the work turned out.

Thus have we gone over, in a somewhat hasty manner, the general principles of manufacturing which are applied in the plant discussed, and it is hoped that some few ideas of factory management are now clearer than they were before.

While we have agreed not to discuss machine methods in this article, the interest that such methods arouse may be sufficient excuse for adding that the factory is supplied with strictly modern equipment—for example, vertical turret lathes, single- and multi-spindle automatic lathes (nearly one hundred of these machines alone), thread-milling machines, auto-indexing milling machines, gear-hobbing machines, gear-shaping machines, multi-spindle drill presses, and all types of grinding machines.

TEST-TUBE AND TRANSIT

EDGAR P. HERMAN, '13

If the shoemaker had stuck to his last as he was advised to do in the old motto, we might still be back a hundred years or so in the history of footwear. Shoes would be made by the pair instead of by the million pairs, and would only be made in every village instead of in some urban factory center. But the shoemaker, like many another craftsman has called on modern methods for help. He has seen in the course of years that his craft was not self-sufficient for greatest advancement, and when he called in science, mechanics and modern management there were wonderful transformations.

This evolution was one demanded by economic conditions and similar changes are traceable in many other industries. Sometimes the changes were due to causes that were very evident, and in other cases economic causation was not so plain.

The luxuriant Tudor architecture is due, it has been said, to the introduction of the turnip into England. "For the root crop enabled the sheep raisers to carry their animals through the winter, and as the climate of the British Isles favors sheep raising, the creation of a winter food supply immediately made possible the expansion of wool trade. By this large fortunes were soon accumulated, and the men thus enriched promptly expended the surplus in stately and sumptuous residences."*

In a like way we might trace out many great changes to causes ordinarily unsuspected. We might show that the success of our great textile and pigment industries dated back to the laboratory man who had experimented with the benzene ring—and synthesized the aniline dyes. We might trace the growth of the Steel Trust to the chemical insight of a man with a vision of the metallurgy of the future.

The history of industry is full of similar examples giving evidence that oftentimes matters of seeming little import—things of a business, scientific or artistic nature—affect the whole future of an art or craft. In modern industry the part that chemistry plays is no small one. Working hand in hand with engineering and with business management it has solved many problems of the past, and if we take the word of Professor Duncan of the

*Brander Mathews's *Economics Interpretation of Literary History*.

University of Pittsburgh, it has still more wondrous worlds to conquer.

Modern industry is largely built upon the three firm supports of economics, science and industrial art. But when we try to separate the elements we have a difficult task. We cannot tell what is business and what is engineering and what is chemistry without pulling the industry to pieces. The organization is so intricate and there is such a bewildering network of interrelationships of fundamental principles, of science and art, of manual and mental details, that it is difficult to make any analysis that will more than approximate proportional prominence of different parts in the make-up. But knowing that the combinations are largely reducible to elements of the physical sciences, chemistry and physics, and the social science of economics, one who would be an expert has the foundation of his education. The would-be expert proceeds along these lines until he finds the trail of the past masters of his chosen art.

There have been many classifications of industry, but for present purposes it is sufficient to divide industry into two arbitrary classes, those in which chemical processes are at the basis and those in which they are not. The mere enumeration of some of the more important of the first class shows a number which seems surprisingly large. It includes all metallurgical, fermentation, ceramic and textile industries; the manufacture of soda, acids, drugs, and fertilizers; pigment and glass industries; the manufacture of gas and of coal tar products; soap and oil and starch and sugar manufacture; the production of paper, the tanning of leather; foodstuff industries, the utilization of by-products, and many others.

In the other group might be mentioned the steel and iron division, the wood products division, and others; but it should be noted that nearly every one of these relies on the services of the chemist at some point or other in the manufacturing procedure. Analyses are required to show the purity of raw materials or of product. Cleaning agents of acid or alkali are required. Galvanizing, and plating, and dozens of other operations are found—operations which it is the business of the chemist to understand.

On the other hand nearly every one of the industries which are primarily chemical in nature or which are based on chemical process, require in their actual operation the work of the engi-

neer. There must be power; the power must be transmitted; there must be machinery of various kinds; and various engineering operations must be performed—operations which it is the business of the engineer to understand.

Not only are the chemical and engineering industries in general make-up so entwined, but the work of the individual engineer and chemist, also, is often bound up with, or closely related to the work of the other. The electrical engineer is required to be an expert electro-chemist, to understand the workings and laws of physical chemistry as well as those of engineering. The mechanical engineer has reason to wish to know the chemistry of materials, the chemistry of gases, and the application of chemistry to boiler water purification and things of practical import. The sanitary and ceramic engineers, from the very nature of their work must be chemists to some extent.

In the same way the chemist, if he would put into industrial application his science, must be more or less acquainted with steam and power apparatus, with mechanical contrivances, and with the principles of mechanics.

To illustrate the point may be cited the way in which chemists go into industrial work after completing their technical training. Some statistics of the department of chemistry of the university prepared a few years ago show this to be true of the University of Illinois, that chemists go into the industrial field for employment rather than into the academic. Out of the graduates from the courses in chemistry and chemical engineering for ten years but ten per cent went into the teaching profession while forty per cent went into technical industries. Another eighteen per cent became superintendents in charge of chemical industries and six per cent became industrial or analytical chemists. Twelve per cent became research chemists. The remainder were divided up among general business, medicine, and graduate work. The research chemists were about evenly distributed between government, university experiment station and special research conducted by manufacturing firms. The superintendents were in charge of industrial processes such as the manufacture of sulphuric acid, fertilizers, starch, glucose, etc. The chemists in technical industries included inspection chemists for railroads, supervising chemists for packing houses, soap manufacturers, metallurgical and ceramic industries, etc. Thus we may see that about two thirds of the number were directly engaged

in technical work, and others were indirectly engaged in such work.

Were similar statistics available for the graduates of the engineering colleges it would be possible to show how large a number of engineers secure work in industries such as those mentioned which are primarily chemical, or fundamentally chemical.

But the economic relationship does not end here. Each is constantly making inroads upon the work of the other to the end of greater efficiency, and of more scientific knowledge of technical problems. The engineer perfects arrangements and devices which make new work for the chemist possible, or which eliminate processes or steps in manufacture. He presents machinery and mechanical devices without which much of the work of the chemist would remain undone.

The chemist in turn does the same for the engineer. He finds uses for by-products; he furnishes reliable information as to composition of material and product, and in many ways he steps in to lighten the work of the engineer or to make the industry more efficient.

Much might be learned by a detailed study of the history of the development of economic interrelationship of chemistry and engineering. The latter is so much the older applied art that possibly this survey would be unnecessary for more than the past few hundred years. But with conditions as they now are, it is almost axiomatic that the students of the one should pay some attention to the other, if but for the illumination of their own vocational viewpoint, and with no cultural object.

To what extent the chemist should set aside his test-tubes and retorts to pay attention to engineering is another matter. Even in this university the question is solved variously by the courses in science with major work in chemistry, by the chemistry course, and by the course in chemical engineering.

Engineering students, too, elect varying amounts of chemistry, or find it required by those who have outlined their courses, and it is becoming more and more accepted that such election is wise. This tendency, however, is but one of the many which seem to indicate an even closer harmony in the future between the test-tube and the transit.

THE DEPARTMENT OF MINING ENGINEERING AT THE UNIVERSITY OF ILLINOIS

W. LERICHE, '14*

Mining subjects were taught by means of lectures at the University of Illinois by Professor Robinson, of the Mechanical Engineering Department between the years of 1870-78. During 1882-83 President Peabody lectured on mining subjects to two or three students who were registered in the course. From 1882 until 1894, when the course was dropped, mining subjects were taught by professors who were engaged in teaching other engineering subjects. During this time about two men were graduated, one of whom is Dr. J. B. Rutledge, Mining Engineer of the United States Bureau of Mines. Between the years 1894-1907 instruction ceased entirely.

Dean Goss revived interest in the matter in his first report as Dean of the College of Engineering, under date of May 26, 1908, by recommending that the University enter this field. Closely following this recommendation the Dean sent out letters of inquiry to prominent coal men, mining engineers, and other influential men of the state, explaining the proposed character of the work and asking for their opinions. The replies were in every case heartily in favor of the plan. Accordingly Dean Goss included in his "Statement of the Appropriations Urgently Needed by the College of Engineering for the two years beginning July 1, 1909," provision for instruction and equipment in Mining Engineering. On March 11-12-13, 1909, the Illinois Fuel Conference, held in Urbana, brought together men from Illinois and adjoining states who were connected in all branches of the mining industry. A committee, appointed by the conference, composed of mine operators, miners, mine inspectors and manufacturers of the state introduced a bill into the Legislature "authorizing and directing the establishment of a department of Mining Engineering at the University of Illinois, and providing for the support of the same." Closely following the introduction of this bill

*The writer wishes to acknowledge his indebtedness to Professor Stoek, Doctor Lincoln and Mr. Lauer of the department of Mining Engineering for valuable suggestions and criticisms. Thanks are due Mr. S. O. Andros, also the photographic department of the university from whom the prints were obtained.

an act authorizing the establishment of this department was signed by Governor Deneen.

The next step was to secure a man best qualified for the position of head of the Department. On account of his previous work in mining, H. H. Stock, Editor of Mines and Minerals, was appointed Professor of Mining Engineering on September 21, 1909. From October 1, 1909, when Professor Stock assumed his duties the department has steadily progressed, and now a course is offered which is comparable with other engineering courses at the University and the courses in mining of other Engineering Colleges. While the present course prepares students for the various phases of mining the original purpose of the department, namely, "to concentrate its energies upon the problems of our own state," has not been overlooked and special attention is paid to the mining problems peculiar to the state of Illinois.

Courses were not offered during the first semester of the year 1909-10. Professor Stock's activities during this time were confined to planning a course of study, acquainting himself with conditions, both at the University and throughout the state, by attending meetings of the Illinois Coal Operators' Association, the United Mine Workers, the State Mining Board and similar organizations. Three regular sophomores in mining, one in mechanical and one senior in civil engineering were given instruction in the regular sophomore mining course the second semester of the year 1909-10.

The Cherry Mine disaster which occurred during 1910 had much to do in bringing the department of Mining Engineering to the attention of the people of the state, for, of the measures introduced into the Legislature in special session, two were of the utmost importance in this connection. They were: an act providing for the establishment of Miners' and Mechanics' Institutes and appropriating \$25,000 for the same; and the establishment of a Mine Rescue Service, under the control of a commission representative of the Mining Department of the University. This service was the direct outgrowth of the work of the Mine Rescue Station at Urbana and the University and the State Geological Survey can claim much of the credit for the establishment of the service which now has three fully equipped stations and cars and over 1300 trained men in the field. Only those closely connected with the mining industry of the state can fully appre-

ciate the benefits which both the miners and operators have derived from this work. It alone justifies the establishment of a department of Mining Engineering at the University of Illinois.

During 1910-11 experimental work was begun by securing large samples of coal from the Danville district, and testing them for compressive strength. The department was represented by Professor Stoek on the Mining Investigation Commission appointed in 1909, which commission had the power and authority to investigate the methods and conditions of mining coal in the State of Illinois with special reference to the safety of human lives and property and the conservation of the coal deposits. This Commission prepared a complete revision of the coal mining law, which was passed by the Legislature essentially in the form presented by the Commission.

Another commission upon which the Department of Mining Engineering is similarly represented is the revising of the mining law in the light of the experience of the past two years.

The Legislature of 1911 made possible a decided improvement in the work of the Mining Department by increasing the appropriation for operating expenses and by appropriating \$25,000 for equipment, also authorizing a Co-operative Investigation of coal mining conditions in Illinois by the Department of Mining Engineering, the State Geological Survey and the United States Bureau of Mines. It was hoped that a separate mining building could be obtained, but instead of the \$200,000 asked for this purpose, \$25,000 for equipment was given.

The writer thus far has attempted to show that mining conditions in the state were such that there was a demand, on the part of the operators, for the establishment of a mining school, and that the early work and that carried on at the present time justified such action. The remainder of this article will be devoted to a description of the course of study, the methods of instruction, the new mining laboratory and equipment.

The methods in instruction may be classified as lecture and recitation, drafting and designing, shop and laboratory, field trips and seminar work. The lectures are designed to give information and instruction in special mining problems peculiar to the State of Illinois, which have not, as yet, been covered by text-books. Elementary drafting is given in the freshman year and designing in the senior year. The drafting is the same as that given students in other engineering courses. The designing, however, is

restricted to mining problems such as, the design of Cyanide plants, smelters, coal washers, etc. Shop practice consists of practical work in the wood and forge shops and the foundry. The work in the laboratory consists of general, qualitative and quantitative analysis, gas and fuel analysis, assaying, the study of mine gases and experiments with safety lamps, mine fans, water gauges, coal cutting, coal washing and ore dressing machinery, blasting and explosives.

Trips of inspection are made to points of special mining interest in the state during the four years of the course. Training in technical writing is obtained in connection with these trips since all of them must be written up. The seminar work is optional with the student. It consists of presenting papers on subjects of mining interest before the Student Branch of the American Institute of Mining Engineers, which meets bi-monthly.

The Mining Department has occupied the second floor of the new Transportation Building since the beginning of the school year 1912-13. The ventilation laboratory is situated on the east side of the corridor and just to the left of the south stairs. It contains all the necessary appliances; such as safety and testing lamps, magnets for the locks, electric device for lighting and unlocking certain types of lamps, and other apparatus required for the proper study of mine gases. A dark room contained in the laboratory for photometric work is equipped with an Oldham gas testing machine.

A museum of mining appliances and the recitation rooms are located on the west side of the corridor and extend almost the entire length of the building. The room in the northwest corner has been fitted up as a library and study room. Bound copies of the leading mining magazines, the proceedings of the American Institute of Mining Engineers and a good collection of State Geological Survey Reports are on the shelves.

There is a large drafting room equipped with desks, a complete set of manufacturer's catalogues of mining machinery and an index of the same, an assortment of mine maps and mine structures and a library containing the principal text and reference books on mining. The instruments used in underground surveying—mining transits, hand instruments—levels, transits, etc., are also kept in this room in order that they may be used for class demonstrations. An adjoining recitation room is equipped with a stereopticon and a chemical table used in class demonstrations with mine gases.

The principal mining laboratory Fig. 1 is just east of the Transportation Building. It is divided into two equal sections 50 feet long by forty feet wide one for the treatment of ores and one for washing coal. The north end of the building contains a coal crusher, an Allis Chalmers gyratory crusher and a roll for ore.

The material is crushed and delivered by gravity into a continuous peck carrier which is equipped with an automatic dumping device. On its upper run the carrier may be dumped into any one of five steel bins of 5 tons capacity, by placing the dumping device over the bin. Beneath these bins is a track upon which an Avery automatic scale travels and through which the material is delivered to either the coal washing or ore dressing apparatus. If the material is coal its course is as follows. It is passed through either a shaking or revolving screen, each of which is fitted to separate four sizes. Each size falls into a separate bin from which the coal is taken to a dormant scale, then delivered to the lower run of the carrier and dumped into the upper bins. Through the automatic scale the coal is delivered to a three compartment New Century jig or to a Stewart jig. The washed coal is placed into a 1300 gallon settling tank from which it is elevated by a bucket elevator into an overhead bin, thence by the peck carrier into a bin outside the building. From this bin the coal is carted away to the power plant. The capacity of the washer is five tons per hour.

When ore is treated it is run through the gyratory crusher and next, either through the crushing rolls or the stamp mill. When the stamp mill is used with gold ore, the material, which is almost powdery at this stage, is mixed with water and allowed to flow over amalgamated plates. The free gold in the mixture is collected on the plates. When copper ore is run through the amalgamation process is omitted. The crushed copper ore or the mixture from which part of the gold has been extracted is pumped into two hydraulic classifiers, by a Traylor centrifugal sand pump. These classifiers separate the material into fine and coarse particles; the coarse going to the Traylor concentrator and the fine to the Chalmers & Williams vanner, Fig. 3. The concentrator and vanner further separate the material into two products. The heaviest product is technically spoken of as heads and the lightest as tails. The heads which constitute the most valuable product are caught in tanks and dried. The tails



FIGURE 2
NORTH END OF LABORATORY SHOWING CRUSHER AND ROLLS

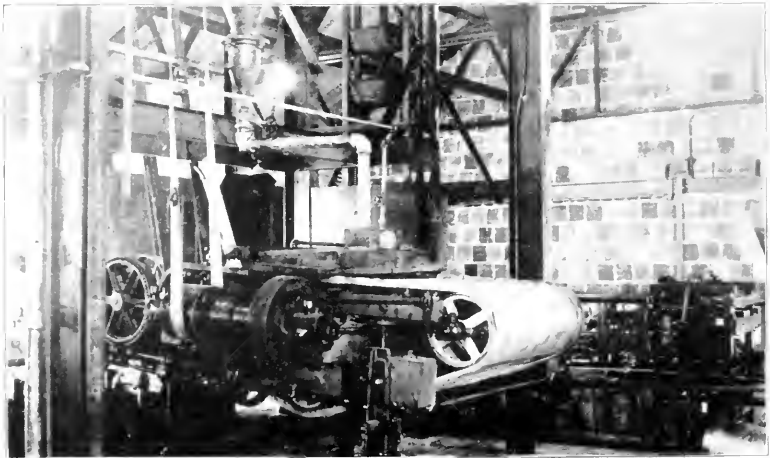

FIGURE 3
CHALMERS AND WILLIAMS VANNER

are allowed to flow into Callow settling tanks beneath which are steam drying tables.

In addition to the gyratory crusher, ore roll and coal pulverizer mentioned above, the north end of the laboratory contains two sampling floors—one for coal and one for ore—a sample crusher, sample grinder, sample pulverizer, bucking board, mechanical bumping screen, a hand screen for separating several sizes at one operation; and on the upper floor a small size concentrating plant, consisting of classifiers, jigs, settling tanks and Wilfley table, which is used for laboratory work.

A blasting and explosives laboratory, a rock drilling and coal cutting laboratory are also contained in the main laboratory building. The equipment includes blasting supplies, rock drills, coal cutters and oxygen helmets with auxiliary apparatus.

The chemical and assay laboratories occupy the south end of the main laboratory. They contain hand jigs, Munroe classifiers, jolly, pulp and button balances, a sink-and-float machine, gas assay furnace gold pans and other equipment necessary for tests, assays and coal analyses.

The Mining Engineering department thus has a very complete equipment and is prepared to give instruction in all branches of Mining Engineering.

A HIGH VOLTAGE TESTING EQUIPMENT

F. C. LORING

Instructor in Electrical Engineering

The Electrical Department has recently received and installed a 200,000 volt testing equipment consisting of a high voltage transformer with controlling and measuring apparatus.

This equipment will be used in studies of Corona and other phenomena of high voltage lines, in the study of the action of lightning arresters and other protective apparatus and in the determination of the breakdown point of oil and of various forms of insulators.

No subject is receiving more attention at the present time than that of the study of the properties of insulators and of insulating high tension transmission lines.

One system is already in operation at 145,000 volts and another is contemplated at 180,000 volts.

It is recognized, however, that operation at 110,000 volts is far from being thoroughly understood for phenomena which were not anticipated have occurred and demand attention before higher voltages should be attempted.

It was thought a few years ago that the suspension type of insulator would adequately meet all requirements for increases in voltages for many years to come. The limiting factor in regard to the use of high voltages at that time was thought to be the effect of corona and leakage into the atmosphere. Now it is seen that these views need revision especially, in regard to the suspension type of insulator.

Some of the uncertain conditions manifesting themselves in a high voltage transmission system, are mainly, the lightning arrester problem, the high tension transformer and the behavior of oil circuit breakers when large amounts of power have to be handled. The transformer is shown in Fig. 1 and has the following characteristics.

Classification 60 cycle—100 kw.—500 2000—200,000 volts.

Rated kw. capacity 100 at 60 cycles.

Volts { High Tension 200,000.
 } Low Tension 500—1000—2000.

Amperes { High Tension 0.5.
 } Low Tension 50.

Ratio of Transformation with full windings in circuit 100 to 1.

APPROXIMATE DIMENSIONS AND WEIGHT

Height to top of high tension leads	9 ft.
Height to top of cover	5½ ft.
Floor space	4¼ ft. dia.
Total weight including oil	3¾ tons
Oil required	5 bbls.

TRANSFORMER CONSTRUCTION

The general design of the transformer is that of having the coils arranged concentrically around the core. The coils and core are contained in a heavy boiler iron tank with a cast iron base. All joints are oil tight by heavy riveting and caulking. The coils and core are fastened to the cover which is provided with lugs for lifting purposes.

The core is built up of steel laminations of high permeability and low hysteresis loss with inappreciable magnetic deterioration. The laminations were annealed and insulated from each other so as to prevent too high a loss of energy due to eddy currents.

The low tension coils were wound on winding forms and insulated and then placed over the core. The high tension winding consists of a number of coils, wound and insulated separately, and assembled over the secondary. The winding is heavily insulated between turns and layers and has a heavily reinforced insulation on the terminal coils. The high and low tension windings are thoroughly insulated from each other and from the core and frame. The windings are provided with ducts for the free access of the oil to all parts. This insures an even temperature throughout the windings.

The core and windings are immersed in a special oil which has a high flashing point and good insulating qualities.

The low tension terminal leads are brought out through porcelain bushings which have sufficient surface to prevent leakage to the frame of the transformer. The high tension leads are specially constructed of annular sections of insulating material, between which are assembled discs which provide large leakage surfaces. The construction of the lead is such that the sections are held firmly together by means of a metal rod passing through the center. This rod also serves as the lead conductor. Provision is made for the expansion and contraction of the filler thus preventing any abnormal pressure within the lead.

The specifications call for a performance as follows: "After a run of 8 hours at 60 cycles, 200,000 volts, and 0.5 amperes, the

rise in temperature of any part of the transformer as measured by thermometer will not exceed 40 degrees C., and the rise in temperature of the coils, as measured by the increase in resistance, will not exceed 50 degrees C., on the basis of normal conditions of ventilation and atmospheric pressure with corrections for variations therefrom made in accordance with the standardization rules of the American Institute of Electrical Engineers.

The insulation between the low tension coils and the core and tank will withstand a test of 10,000 volts alternating current for one minute."

The high voltage test consisted in subjecting the windings, with the voltage supplied from excitation on the low voltage side to 250,000 volts alternating current for five minutes with both high voltage terminals free.

A full load efficiency of 95 % is guaranteed.

CONTROLLING APPARATUS

The controlling apparatus consists mainly of two switchboard panels as shown in Fig. —

The smaller of the two panels is mounted on pipe supports near the transformer, to which are attached the various low tension leads and high tension voltmeter leads.

For making tests a special switchboard is used consisting principally of two slate panels and two drawers with glass tops, for the instruments, these being mounted on a frame work of angle iron and enclosed within a heavy iron wire network.

The panel sections on the front are composed of ebony asbestos lumber. This arrangement while seemingly expensive was considered necessary to eliminate all danger as it is not possible for an operator to come in contact with any live parts unless through carelessness.

MEASURING APPARATUS

The measuring apparatus consists of the following meters:

- (1) Single phase wattmeter—1.5 3 watts max. amp. 0.06—max. volts 75 150.
- (2) Single phase wattmeter—5 10 watts max. amp. 0.2—max. volts 75 150.
- (3) Single phase wattmeter—15 30 watts max. amp. 0.6—max. volts 75 150.
- (4) Single phase wattmeter 37.5 75 watts max. amp. 0.75—max. volts 75 150.

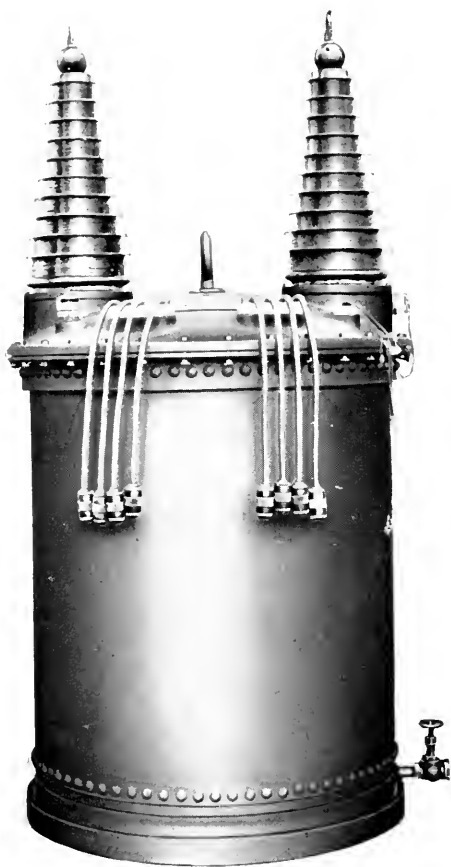

FIGURE I

A 200,000 VOLT TRANSFORMER

Courtesy The General Electric Co.

- (5) Ammeter Type R_1 range 0-15 amperes.
- (6) Ammeter Weston Type range 0-100 amperes.
- (7) Voltmeter Type P_3 ranges 0-30 and 0-60 volts.
- (8) Voltmeter Type P_3 ranges 0-150 and 0-300 volts.
- (9) Voltmeter Type R_1 range 0-175 volts.
- (10) Two potential transformers ratio 4-1.
- (11) Power factor meter.
- (12) Frequency meter (Frahm system) 22.5-90 cycles.

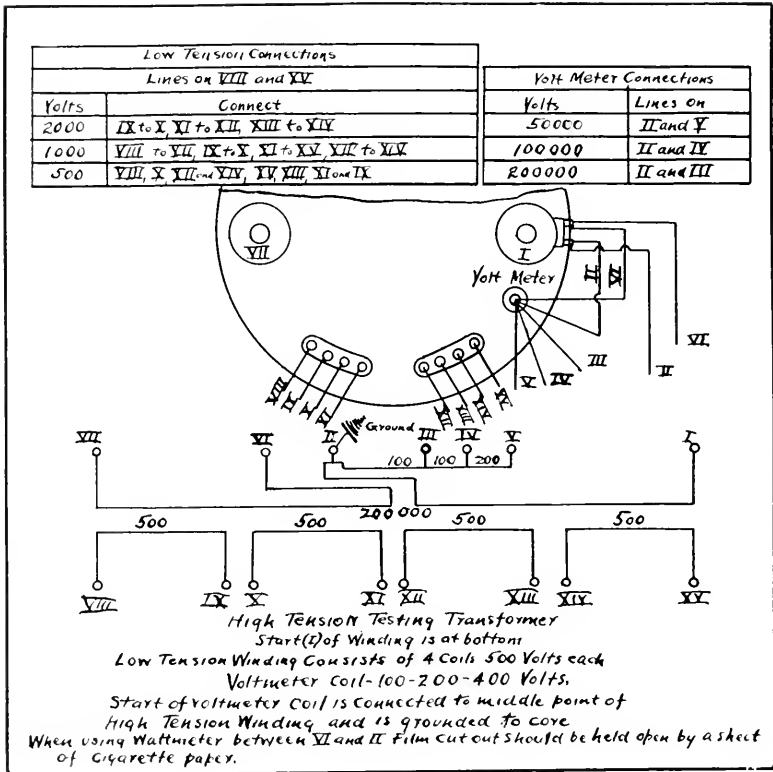

FIGURE 2

The connections for the transformer are as shown in diagram Fig. 2.

The middle point of the high tension winding is permanently grounded on the core. Fastened to the top of the high tension terminal leads are reactance coils. Wires are carried from the tops of these coils and fitted into small long glass rods filled with a conducting liquid. From the upper ends of these glass rods

which are mounted vertically, attachment is made to copper rods which carry the high voltage current to the article under test. These copper rods are fastened to the lower ends of a string of four (50,000 volts each) insulators in series.

The ceiling of the high tension room was covered with one half inch wire gauze. This ceiling together with all conduit, machines and switchboard panels was thoroughly grounded to a water pipe.

The complete arrangement of connections and apparatus for measurements are as shown in diagram Fig. 3.

OPERATION

In operating an equipment of this sort many precautions, safeguarding those conducting the tests and the apparatus itself, must be taken and rigidly adhered to.

The most important instructions covering the operation of the transformer are as follows:

(1) If violent short circuits are to be expected on the high tension side of the transformer, it should be protected by a suitable reactance coil mounted on each terminal.

(2) The transformer should not be excited through the voltmeter coil.

(3) Care must be exercised to see that the voltmeter and wattmeter connections are properly used; also that the middle of the high tension winding be always kept closed, either through the film cut out with the film removed or through the series coil of a wattmeter or by an ammeter.

(4) In connecting the low tension coils to the three double pole, double throw switches, the high tension voltage may be either 200,000, 100,000 or 50,000 volts, with 500 volts impressed on the low tension winding.

(5) The upper end of the lower half of the high tension winding is connected to the start of the voltmeter coil, and permanently grounded to the core. The cable from this point is brought out to the film cut out and ground connections should be made from this and also from the transformer case permanently to a water pipe.

(6) A ratio of 1500 to 200,000 volts can be had by placing two of the low tension coils in parallel and then in series with the other two coils, themselves in series.

(7) A connection to be avoided is that of placing two of the

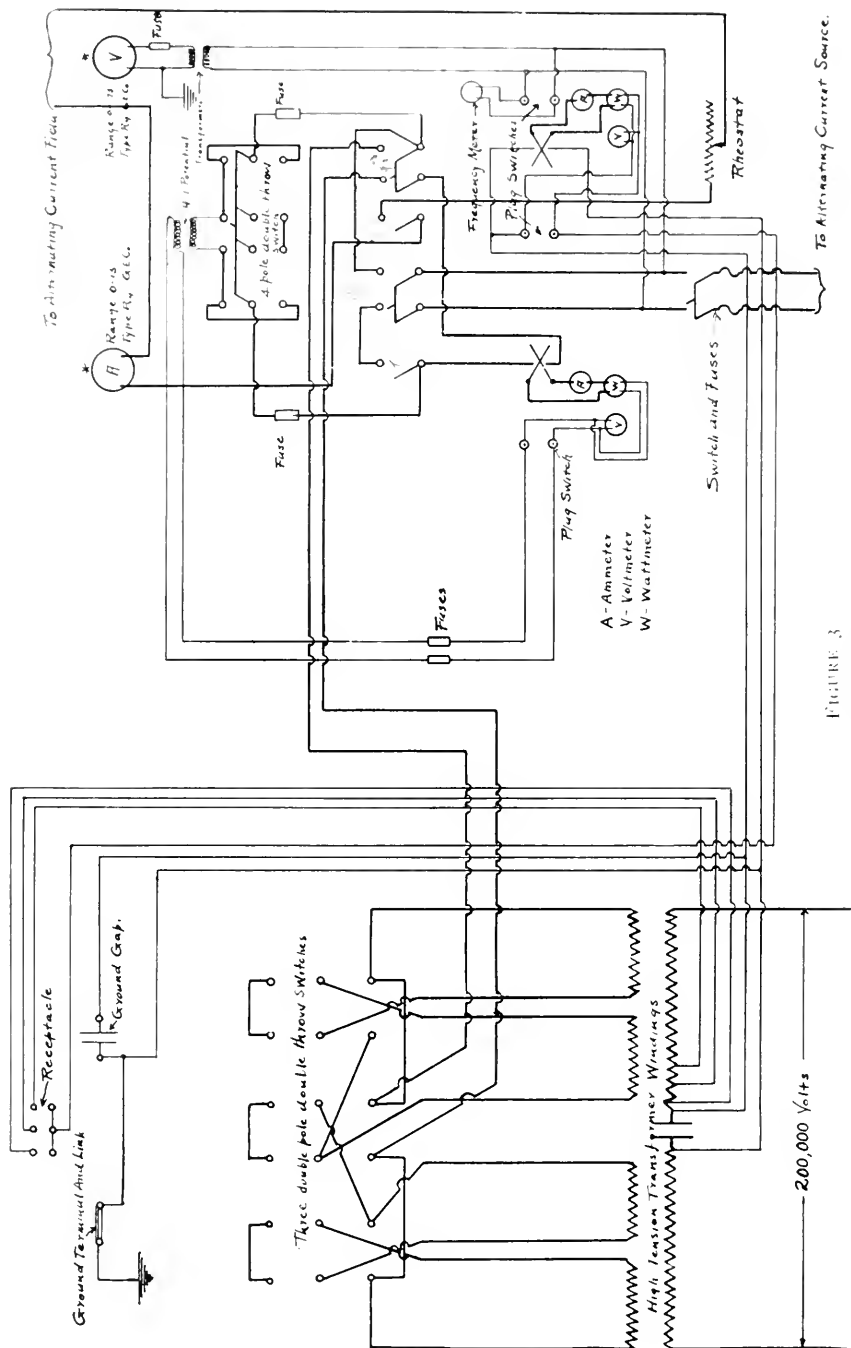

FIGURE 3

SWITCHBOARD WIRING (Back View)

All Meters Not Marked With * Are Enclosed in Drawers

low tension coils in parallel and then in parallel with the other two coils, themselves connected in series.

(8) Samples of the oil should be taken from the top and bottom of the tank occasionally and tested. The transformer should not be operated, unless the samples test at least 40,000 volts for 0.20 inches between 0.5 inch discs.

(9) The tank should be kept filled with No. 8AA transil oil to within one inch of the top. The gaskets under the rim of the tank should always be in place, with the cover bolted down air tight.

(10) The safety valve is for the purpose of relieving the interior pressure if such should result from a short circuit or other accident. It should be adjusted to open at from two to five pounds pressure per square inch.

(11) The transformer is designed for normal voltage at 60 cycles. A higher frequency, while permissible within certain limits, causes additional strains on the insulation beyond the design limits.

(12) A frequency less than 60 cycles may be used provided the voltage is reduced nearly in proportion to the frequency so as not to exceed the normal flux density of the core.

(13) Care should be exercised in carrying the voltage above the 200,000 point, for a little beyond, the transformer, by conversion, will arc between terminals.

(14) The transformer will safely stand double load for $\frac{1}{2}$ hour.

(15) Under no circumstances should the transformer be operated so as to exceed an actual temperature, measured by thermometer, of more than 60 degrees C., in the oil at the top of the tank.

(16) There is some question as to the proper method of regulating the voltage as it must be accomplished by means which do not alter the shape of the alternating current wave form which should be a true sine curve. Induction regulators, auto-transformers, and water rheostats have been used for this purpose but the method adopted, that of controlling the field of the alternating current generator seems to be the best.

(17) The voltage is determined by the means of an ordinary voltmeter in connection with a step down transformer. However, a spark gap is to be used, in addition to the above in order to give more accurate readings.

A BIBLIOGRAPHY OF HIGH VOLTAGE TRANSMISSION AND TESTING

- (1) Some problems of high voltage transmissions.
C. P. Steinmetz, Mch. 8, 1912. A. I. E. E.
- (2) The law of corona and dielectric strength of air.
F. W. Peek, Part I, July, 1911; Part II, June 25, 1912.
A. I. E. E.
- (3) Protection of transmission lines.
E. E. F. Creighton, Mch., 1911. A. I. E. E.
- (4) Measurements of voltage and current over a long artificial power-transmission line at 25 and 60 cycles per second. A. E. Kennelly and F. W. Lieberknecht, June 25, 1912. A. I. E. E.
- (5) Design, Construction and test of an artificial transmission line. J. H. Cunningham, Jan., 1911. A. I. E. E.
- (6) Artificial power transmission line.
A. E. Kennelly and H. Tabossi, *Elec. World*, pp. 359-361. Feb. 17, 1912.
- (7) The electric strength of air. J. B. Whitehead. I, June, 1910; II, June, 1911; III, June, 1912. A. I. E. E.
- (8) Corona losses between wires at high voltages.
C. Francis Harding, July, 1912. A. I. E. E.
- (9) Open atmosphere and dry transformer oil as a high voltage insulators. Ryan, Jan., 1911. A. I. E. E.
- (10) *Electrical World*, V. 56, p. 1179, 1910. Hausmann; Transactions, A. I. E. E., V. 23, p. 101, 1904. Ryan; Proceedings, A. I. E. E., V. 29, p. 1059, 1910. Whitehead; *Electrician*, V. 63, p. 828; 1909; V. 64, 707 and 766, 1910.
- (11) Discussion on "open atmosphere and dry transformer oil as high voltage insulators," Jan. 13, 1911. A. I. E. E.
- (12) The Conductivity of the atmosphere at high voltages.
Ryan. A. I. E. E. Trans. Vol. 21, p. 275, 1904.
- (13) High voltage line loss tests made on the 100,000 volt, 60 cycle, 180 mile transmission line of the Central Colorado Power Co. E. L. West, Jan., 1911. A. I. E. E.
- (14) Test of losses on high tension lines. G. Faccioli. Jan. 1911. A. I. E. E.
- (15) Structural Steel Towers and Poles, *Engineering News*, Nov. 28, 1912, p. 988.

- (16) High Tension Testing of Insulating Materials.
By H. B. Hendricks, Jr., A. I. E. E. Feb. 14-16, 1911.
- (17) Tests of Arcing ground suppressor on the 40,000 volt
system of the Southern Power Co.
By Burkholder and Marvin, Feb., 1911. A. I. E. E.
- (18) Transmission systems from the operating standpoint.
Wood, April, 1911. A. I. E. E.
- (19) Electric Line Oscillations.
S. Faccioli, June, 1911. A. I. E. E.
- (20) Transmission systems of Great Western Power Co.,
Southern Power Co., Great Falls Power Co., Central
Colorado Power Co. June, 1911. A. I. E. E.
- (21) The mechanical and electrical characteristics of Trans-
mission Lines.
Pender & Thomson, June, 1911. A. I. E. E.
- (22) The High Efficiency Suspension Insulator.
Austin, June, 1911. A. I. E. E.
- (23) Tables of Hyperbolic Functions in reference to long
alternating-current transmission lines.
Kennelly, June, 1911. A. I. E. E.
- (24) The Sphere Spark Gap.
Farnsworth and Fortescue. Feb., 1913. A. I. E. E.
- (25) The Calibration of the Sphere Gap Voltmeter.
Chubb & Fortescue. Feb., 1913. A. I. E. E.
- (26) High Frequency Tests of Line Insulators.
Imlay & Thomas, Dec., 1912. A. I. E. E.
- (27) High Tension Insulators.
Sothman, Dec., 1912. A. I. E. E.
- (28) Disruptive Strength with Transient Voltages.
Hayden and Steinmetz, June, 1910. A. I. E. E.
- (29) Potential Stresses in Dielectrics.
Osborne, Oct., 1910. A. I. E. E.

AN APPROXIMATE METHOD OF DETERMINING ELECTRICAL CONSTANTS OF AIR COILS

H. A. BROWN, P. G.

University of Illinois

Until rather recent years the electrical engineer has been handicapped in almost every turn by an undesirable amount of reactance popularly called "self induction". It has seriously affected the line regulation, the voltage control of transformer regulation and the voltage of generators. Within the last few years however, this condition has changed. Long distance transmission systems using 100,000 volts or so have usually a deficiency in reactance and an undesirable amount of capacity. Large transformers can hardly be designed with sufficient self induction for self protection in case of short circuits, and turbo generators are likely to take such excessive current at short circuit that the incidental stresses demand almost prohibitive mechanical construction. It is thus evident that the engineer now is interested in self inductance and in reactive coils for an entirely different reason than that of a few years ago and the manufacturer is calling upon him to design such coils to be inserted in almost all the large systems of today.

While it would look as if the design of such a coil would be a very simple matter it is not the case. To make an accurate determination of these coils requires difficult and laborious calculations. Practically, however, it is possible to get quite fair approximation by relatively simple means and I am proposing this very simple method, not claiming that it is sufficiently accurate where the reactance must be determined within 1% or so but in ninety-nine out of a hundred practical cases.

It is the purpose of this article to explain, how in a very simple way, by means of diagrams and formulas, the constants can be obtained with a very fair degree of accuracy and with little calculation.

It is well known that the relation between density and M. M. F. in a long air coil is expressed by the following equation:

$$\text{M. M. F.} = \text{Amp. turns} = Ni = \frac{B l}{.4 \pi} = .8 \frac{B l}{a} = .8 \frac{\Phi}{a} l \dots (1)$$

Where l is the axial length and a a cross section in cm. and cm^2 respectively of the coil, B is the density and Φ the total flux. For

other coil shapes a constant k differing from .8 can be introduced and this article gives the value of this constant so that for any coil shape the above equation can be written: $Ni = kBl \dots (2)$

It is proven below that this constant k is divided by 10^8 also enters in the inductance formula.

From (1) we get $\Phi = \frac{k a Ni}{l}$

but the inductance L is $\frac{N\Phi}{10^8 i}$

Thus $L = \frac{k a N^2}{10^8 l} = \text{henries}$

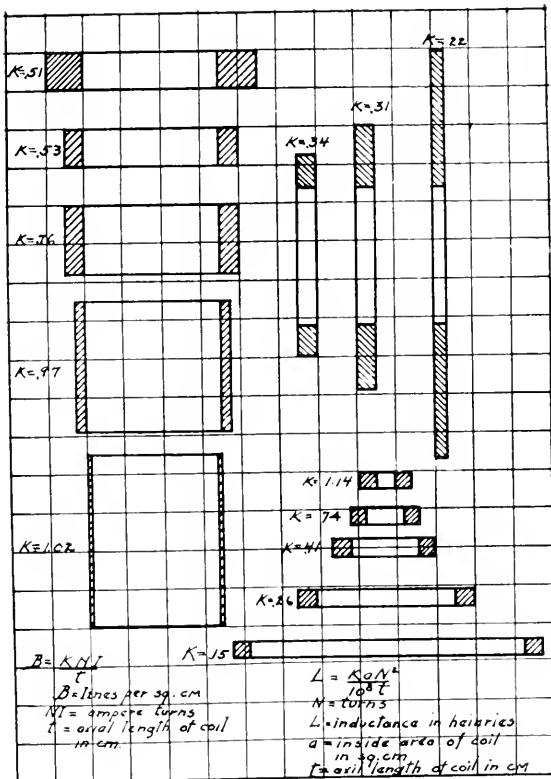

The constant k has been determined under the arbitrary assumption that a is the inside area of the coil even though it is evident that considerable flux exists among the wires.

The value of the constant as shown in the accompanying diagram has been calculated from a Universal formula derived by Professor Morgan Brooks, which is accurate within a fraction of a per cent. The constant is obviously always the same no matter how large or how small the coil may be, or how many turns of wire it may have.

ILLUSTRATION OF THE USE OF THE DIAGRAMS

Determine for instance the relation between M. M. F. and density and the inductance of coil of wire having 1000 turns and carrying 10 amperes, and assume that the proportions are similar to those of the second coil illustrated in the diagram. Let the inside radius be 15 cm. and the axial length of the coil be 7 cm. Thus $K = .53$

$$B = \frac{K a T}{l} = \frac{.53 \times 10000}{7} = 757 \text{ lines per sq. cm.}$$

and

$$L = \frac{K a N^2}{10^8 l} = \frac{.53 \times 706.0 \times 10^6}{10^8 \times 7} = .534 \text{ henries.}$$

The accuracy of the results depends upon how closely the proportions of the coil are the same as those of the diagram.

SURVEYING IN MEXICO

H. R. THOMAS, B. S.

Fellow in Theoretical and Applied Mechanics

If you take a map of Mexico you can readily find the towns of Tampico and Veracruz, and if your map is large enough and you look carefully you can locate the town of Tuxpam. Now if you make a dot some forty or fifty miles inland from Tuxpam you will thus locate the Meza of San Antepec, which in the summer of 1911 was the site of an engineering camp of the Mexican National Railroad.

The Meza of San Antepec is some 1400 feet above sea level and to the northwest it gradually rises up to the elevation of real table land of the interior of Mexico. An hour's ride from the top of the Meza will carry one down to the lowlands, and it is here that is found the real tropical jungle of Mexico.

To the newcomer the tropical forest is a never-ending source of interest and pleasure. Here grow the ojite, zapote, the bamboo and other trees with new and unfamiliar names. One tree in particular called the *higuero* is apt to excite the almost morbid interest of anyone who has seen it enough to realize its method of growth. It will start as a vine which runs along the ground until it reaches a larger tree. It will then grow up the sides of the tree, sending out branches along all the largest limbs of the main tree. All this time it sends out little leafless branches that run around the trunk and limbs of the host until the whole tree is covered with a network of living plant, which then begins to squeeze and squeeze until there is only one possible end. The main tree is unable to grow any more and so in a few years it has died and rotted away, leaving the *higuero* a thriving tree with trunk and limbs built along truly engineering lines for economy of material. Thus the *higuero* demonstrates the survival of the fittest and by its method of growth is able to climb up to the sunlight and air in a most ingenious way.

And this whole forest is as tropical in appearance as one's imagination could picture. All of the trees are so covered with air-plants and parasites until it is hard to tell a dead tree from a live one. One vine in particular climbs up the trunk of a tree and then apparently unable to secure enough food sends down long, snaky roots, some of which may be forty or fifty feet long,

and only as large as your little finger. They present a grewsome appearance, but are extremely useful as cords for tying up bundles or building houses.

The natives are practically all Indians and live in little scattered villages. While they are usually peaceful, they seem to enjoy the excitement of chopping each other up with *machetes*. Each person, from a boy just able to walk to the gray-headed man wears a *machete* in a sheath attached to his belt. And the *machete* is as useful as the proverb—woman's hairpin, being equally serviceable as an instrument to use to cut down a tree or to carve an enemy's neck or one's own toenails.

The houses in which the natives live are usually made of a pole framework tied together with roots. Tied to these poles are sections of bamboo that have been split and flattened out. A few leaves on top for a roof and the house is complete.

The railroad location party that was camped on the Meza of San Antepec in the summer of 1911 was made up of five members besides the Chinese cooks and the Mexican laborers. The chief was from Tennessee and was considered a fine locating engineer. He was inclined to be brusque and retiring, and his biting sarcasm made him a person to avoid when he was not in a good humor. The transitman had gone to Mexico the year before fresh from the University of North Carolina. In the year he had been in the tropics he had developed into a transitman who not only knew his business but also how to get the maximum work out of the Mexican laborers. The levelman was still a student and was with the party only for the summer. The draftsman was a German and full of the sense of his own importance. He dressed as if he were on a hunting trip and wore a big pistol around camp all the time. An English boy worked as level-rodman, and like most new arrivals in Mexico his Spanish vocabulary was made up principally of words he should not have known. Besides these, there were two Chinese cooks and a dozen or so of Mexicans. The head and rear chainmen were both Mexicans, and the way they did the work was enough to give an engineer the apoplexy. Instead of plumb-bobs, they used sticks about six feet long which they sometimes accidentally held vertical while measuring. Of course the inaccuracy of this method was recognized, but it was considered all that was necessary in that rough country.

The camp itself was situated on the Meza near a huge clump

of live-oaks. There were four big tents besides the kitchen and dining fly. The chief had a tent to himself, which also served as an office and drafting room. All these tents were arranged facing the kitchen so that the cook could keep an eye on them and discourage cows or other undesirable visitors. At a distance from these was the corral and the saddle tent, for each member of the party was furnished with a horse and there was a *caballerango* to feed and saddle up.

Just to see how the work was done, let us follow the party through a typical day's routine. Each evening a paper location was made and the following day's work carefully planned. About five o'clock in the morning a Chinaman went around and hammered on the tent-pole at each tent until somebody growled *bucno* to show that he had heard. By the time we have dressed, a hammering on a frying-pan announces that breakfast is ready. After disposing of the "ham and" with the usual accessories, we go to the corral where the horses are saddled and waiting. A ride of a couple of hours through the snappy morning is enough to wake the sleepest person and to bring the party to the place of beginning of the day's work. Here we find that the Mexicans have beaten us and have brought the instruments and other equipments. The instruments are set up and the line given for the axemen, and the work has started. For a while the line runs along nicely up the side of the Meza and then it looks as if we had hit a sink hole. As we get near the bottom of the *arroyo*, some of the real troubles of clearing a line in the tropics become apparent. The line hits fairly in the middle of a clump of bamboo and there is nothing for it but to go through. And that is a job that is wearing on the patience of the engineers and the *machetes* of the axemen. For the bamboo is as tough as bone and will turn the edge of any tool besides, the fearful thorns with which they are equipped make the back-strokes of the branches something to be avoided. On cutting through the stems of the bamboos, they refuse to fall, being so tightly interlaced that they support one another. So it is necessary to make another cut up about six feet and remove sections of the stem before a line can be cleared. By the time that this is done and a point set beyond the bamboo, a halt is called for lunch beside the creek. This takes only a short time to finish and in half an hour we are at it again. The climb up the hill and out of the *arroyo* is a short job for the transit party, but the levelman is heard

growling because the brush is so thick that he can not sight across and set a turning point, but has to turn down to the bottom and then up the other side. And this is no small job, for on this steep hill there are three or four turning points between two stations 66 feet apart and this means that the levelman will have to get a "hump" on if he keeps up with the transit party. But in the afternoon the axeman ran into a big *ojite* and when the levelman hears the clear ring of the axe on hard wood he knows that he will probably catch up before night.

About four o'clock a big cloud is coming up and it is getting so dark in the woods that it is impossible to set a point accurately. Evidently we will not miss our regular rain today (for it is the rainy season), so we drop all the instruments for the men to carry in and hunt up our horses. By the time we saddle up it is pouring rain, but we do not care, for that was what we expected it to do when we left camp.

On arriving in camp we finish up supper in a hurry and then go over to the chief's tent to find out what all this work is about. Here is what we find out from the chief:

For a year or so previous to this time two parties have been in the field, one locating a line from Veracruz up to the Rio de San Pedro on the border of the state of Veracruz; the other party locating a line out of Tampico headed for the Meza of San Antepéc. At this time the line from Veracruz had been located up to the river, while that from Tampico was up to a point about 15 miles away. The object of the party now on the Meza is to locate a line up the side of the Meza from the Veracruz side and then to run down and to tie in with the line from Tampico. The two branches are to unite on the Meza of San Antepéc and from there run to the interior with Mexico City as the final destination. The point where the camp is located is only a few hundred yards from this junction and will be the site of the railroad division yards and shops. The Railroad Company has already secured the money for building the line and it is expected to push the construction as fast as possible.

After plotting up the day's run and laying out the next day's work we all go over to one of the sleeping tents to talk things over. Here we learn still more about life in this part of the world. Here we learn that all the supplies are shipped to the camp from Mexico City by way of Necaxa. From here they are carried

on pack mules to the camp. A trip is made once a month to Necaxa for supplies and takes about a week.

The line up the Meza from the Veracruz side is a straight two per cent and climbs a thousand feet in ten miles. This is a very crooked piece of track and in the ten miles there are four tunnels. One cut is 140 feet deep and contains some two hundred thousand cubic yards of excavation. It was necessary to cross section this on a one to one slope in order to secure enough material for the eighty-foot fills on each side of it. This is one of the biggest cuts in the Republic and the Chief is very proud of it. This line up the Meza is in many places a case on maximum curves and minimum tangents, for the side-hill is so cut up by cross valleys that to follow a contour would break the back of a snake.

Life in this part of the country is continual fight against malaria, and insects. At certain times of the year ticks are so plentiful that a person's clothes will look to be alive after he has been in the woods only a few hours, and every night it is necessary to pick them off. Knee boots and tight clothes are required to keep them out as much as possible. Besides these, the chiggers, or red-bugs, are so thick that the only thing to do for them is to smear on some kerosene to kill as many as possible and even then they are the cause of many a wakeful night. Any kind of a sore on man or animal is a serious matter and demands immediate attention. For after it gets a start it is almost impossible to heal it without getting out of the tropics.

In spite of all this, the life is interesting, and if a person takes reasonable care of himself there is no reason why he should not be able to keep well and do the work almost as well as if he were in a more healthful climate.

THE INTERSTATE COMMERCE COMMISSION

P. T. BOCK, '13

The subject for discussion in this paper is one of vital interest to all Americans, and, more especially to engineers in that it deals with a body whose every ruling has either a direct bearing or an indirect reaction upon the railroad development of this country. In spite of its importance, there are a few persons who have anything but a hazy and indistinct idea of the Interstate Commerce Commission and its place in the complex organization of our national government. This is due in a measure, no doubt to the Commission's infancy, but more largely is the direct result of the confusing alterations of court decisions and amendments by Congress. In fact it has taken the first two decades of the Commission's existence to crystallize, prepare, and shape a definite governmental policy toward the railroad.

Of fundamental importance in molding the economic and political conditions, which were to make this a government strongly centralized and able to endure, was that clause in our constitution which said, *"The Congress shall have the power to regulate commerce with foreign nations, and among the several states, and with Indian tribes." We find, thus, in the annals of the Supreme Court a decision, here and there, based on this clause or one of its components. But the decisions were all lacking in specialization and were, in general very broad.

Toward the end of the nineteenth century, however, the rapid development of the railroad and the phenomenal growth of our internal commerce gave birth to an entirely new set of industrial conditions and, what was almost as important, an entirely new code of business ethics. The comparatively young railroads under the yoke of a fierce competition, recognizing the future magnitude of even minor initial advantages, were sometimes led or sometimes forced into vicious practices. Protected by the constitution from state interference, railroads were allowed the widest latitude in rate making. Consequently to attract the business of communities favorably located they distributed entrepôts, and unfair discrimination of the grossest kind crept in.

Late in 1886 the Supreme Court decided, in the case of the

*Art. I Sec. 8 Clause 3.

**Wabash Railroad vs. Illinois*, that the state had no right to prevent discrimination in interstate rates, even in that part of the rate which was wholly within the confines of the state. Thus we see a clause in our constitution, the evident purpose of which was to prevent one state from discrimination against the citizens of another, successfully invoked by a railroad to prevent that state from securing impartial treatment for its own citizens. At this time the House was considering the Reagan Bill which would have made this discrimination illegal; and the Senate was considering a similar bill sponsored by our own Senator Cullom. A few months after the curious decision mentioned above, the Interstate Commerce Act emerged.

This act, passed early in 1887, provided for the appointment of five commissioners at a salary of \$7,500 and one secretary at a salary of \$3,500, to form what was to be called the Interstate Commerce Commission. This commission derived its power from the act which gave it birth.

Although the fundamental purpose of the act was to prevent unreasonable and extortionate railroad rates, many other reforms were attempted. The act contained a provision which made it unlawful for a common carrier "to charge or receive any greater compensation in the aggregate for the transportation of passengers or of like kinds of property, under substantially similar circumstances and conditions, for a shorter than for a longer distance over the same line, in the same direction, the shorter being included within the longer distance." This became known as the long and short haul clause and was aimed at an especially vicious and barefaced discrimination.

It also required that all companies engaged in interstate commerce keep open to public inspection all rates and tariffs, and that, furthermore, a copy of these be filed with the Commission; and that no advance could be made except after ten days notice had been given to the Commission and no reduction, except after three days' notice.

The Commission was given power to investigate all business transactions of common carriers, either at their own initiative or after a formal complaint had been registered with them. It could demand the production of any witness or evidence, but such

*158 U. S. 557.

evidence could never be used in any subsequent criminal proceeding against the witnesses.

If, after serving due notice on a party for violating the act, that violator did not heed the warning the Commission had the power to invoke the aid of the court in obtaining an injunction, and furthermore, in event of continued disobedience, provision was made for a fine not to exceed \$500 per day. Certain flagrant violations were subject to a fine not to exceed \$5000 and rendered the violator liable to imprisonment for a term not to exceed two years.

Such were the main features of the act which for nearly twenty years governed the rulings of the Interstate Commerce Commission. While it was a distinct advance yet it left much to be desired. In the report of the Cullom Bill in 1886 the committee has said, **"In undertaking the regulation of interstate commerce, Congress is entering a new and untried field. Its legislation must be based upon theory instead of experience, and human wisdom is incapable of accurately forecasting its effect upon the vast and varied interests to be affected."* Subsequent results of the Commission do not make it appear at all unfavorable when viewed with the comprehension of these words.

The attitude of the judiciary to the new commission was eagerly awaited, and, in the first clash, early in 1889, the court decided that the power to force a witness to testify, unless absolute immunity could be guaranteed him, was unconstitutional. In 1893 Congress amended the act and granted this immunity, but the amendment was not universally recognized until 1896, when a Supreme Court ruling settled the matter once and for all in favor of the Commission, thereby materially aiding them in their investigations.

In 1893 Congress passed another amendment placing the regulation of all safety appliances, used on interstate lines, under the jurisdiction of the Commission. This, as the first departure from a strictly economic recognition of the Commission, is of especial interest to engineers.

In the first decade of the Commission's existence there were two other important legal precedents established, both of which were distinctly unfavorable to the Commission. First, in January 1889 it was decided that new evidence could be introduced be-

*Page 214 of Report.

fore the court, thus allowing alleged violators to reserve their most favorable evidence until legal trial. Again, the Commission had always positively claimed the power to set maximum rates, basing their claim on their own interpretation of the commerce act, but in 1897 in the case of the Interstate Commerce Commission vs Cincinnati, New Orleans, and Texas Pacific Railroad, the Supreme Court decided that the Commission had no rate making powers.

In 1903 the Elkins Law strengthened the hands of the Commission somewhat by providing a fine of from \$1,000 to \$20,000 for the violation of the act by a corporation. As most violators were corporations this was a necessary bit of legislation. The Elkins Law also repealed the imprisonment clauses of the original act, but this must have proved unwarranted. At any rate in 1906 the imprisonment clauses were again made effective by the important Hepburn Bill.

In 1904 and 1905 the beef trust and insurance scandals made the public suspicious of corporations while the disclosures regarding the Standard Oil Company's discriminations, Santa Fé rebates, and Pennsylvania Railroad coal operations caused a general demand for an extension of the Commission's powers. President Roosevelt, in his 1904 message to Congress, strongly urged radical reforms, and again in 1905 he expressed similar desires. In 1906 the House almost unanimously passed the Hepburn Bill, and a few weeks later the bill, after being considerably amended, passed the Senate with only three dissenting votes. The bill was finally passed by both houses on June 29, 1906, and became a law some time in August of the same year.

Under the Hepburn Bill the power of the Commission was vastly enlarged and its efficiency increased more than even its ardent advocates had dared to hope. The Commission was given the power to set maximum rates, to go in effect thirty days after set and to hold for two years. All common carriers were placed under its jurisdiction, including all pipe lines (except those for water and gas), express companies etc. Furthermore the term "railroad" was specifically defined to include all elevators, switches, private lines, belt lines, storage facilities, icing plants, etc. This enabled the Commission to combat a subtle method of rebating particularly difficult to handle. Formerly railroads could, by varying the charges on these extra items, give a de-

cided advantage to favored shippers, and still be wholly within the letter of the law.

The bill furthermore authorized the Commission to compel any railroad to build, maintain, and operate at a reasonable rate, a switch at any place the Commission desired. It provided a fine for any company which issued passes to persons other than employees and ministers. Furthermore, carriers were held responsible for a correct quotation of rates and tariffs to shippers, and, in case of loss or damage *en route* the carrier or carriers responsible were liable to the full amount of damages.

Another important provision of the bill was that prohibiting any carrier from interstate transportation of any commodity in whose production that carrier had any direct or indirect interest. This so-called commodities clause, however, excepted lumber and its products. Another clause of the bill enlarged the Commission to contain seven members, and their salary was increased to \$10,000. This would seem to show that Congress had become thoroughly convinced of the Commission's worth.

In 1907 an eagerly awaited Supreme Court decision fixed the validity of the rate making clause. Some months later the same court in a legal decision gave the impression that it would only deal with the legal aspect of interstate commerce cases, and, while it would not hold the commission's ruling sacred, still, on questions of fact it would not be prone to hasty action in overruling decisions of the commission. In 1909 the constitutionality of the commodities clause was upheld.

In 1910 the act again came up before Congress. In this amendment a court of commerce was established consisting of five judges who were to be appointed by the chief justice of the United States or else by the entire Supreme Court. Appeals from this court were to be taken only to the Supreme Court. The act of 1910 amplifies the Hepburn Bill in many other particulars. It allows the commission to suspend an increase in rates for ten months, to enable an investigation to be made. Further, a shipper is given the right to route his shipment, and the commission is given power to establish new joint routes, fix a maximum rate for them, and decide on the distribution of the rate. Other important clauses were those which authorize the commission to investigate the rates of any company at their own initiative, and provided that all exemptions from the "long and short haul clause" must be officially sanctioned by the commission.

On the whole, the Commission and the commerce court have not been in entire harmony. In the first year of its existence the court sustained the commission in only about one third of the important cases, brought before it. In 1911 a powerful legislative attack was made on the court which had the silent sympathy of the commission.

After this somewhat lengthy chronological treatment of our subject it might be worth while to make a rather hasty review from a somewhat different viewpoint. Early in its course the commission was much hampered by the rivalry of the courts, the limitations of the act, and the fierce resentment of railroad men to any rate making supervision. Even at this time, however, it had a great influence for good in that it brought to light the accounts, books, rates, and business transactions of our interstate carriers. By degrees the commission developed. The act of 1893 secured for it jurisdiction over safety appliances. Later amendments to this act gave it almost complete jurisdiction over brakes, signal systems, train rules, and crew regulation. In 1911 an order was issued that all wrecks in which one or more people were killed must be reported by telegraph to the commission in order that they might send a government investigator at once.

The Commission has also lately acquired the power of inspection of all physical structures, and the future promises a very intimate contact between the Commission and the civil engineer. The act of 1910 gave it the right to make valuations of railroad property in order that it might be able to fix equitable rates. The Commission is already eagerly awaiting the power to make an extended complete valuation of the entire interstate railway lines. The railroad man regards this with much foreboding, and even the lay observer feels that this would be the first step taken by an attempt to nationalize the railways; although it may be strongly argued that it is meant to be a step in this direction only in so far as it will afford a basis for a more equitable readjustment of railroad rates.

The personnel of the commission at the present writing (March 3, 1913) is Chas. A. Prouty, chairman, Judson C. Clements, Franklin K. Lane, Edgar E. Clark, James S. Harlan, Chas. C. McChord, and Balthasar H. Meyer. The Commission directs a large corps of examiners and a number of special investigators and inspectors. The Commission issues

three reports annually: 1st, Railroad statistics; 2d, Railroad Rates; 3d, Report of the Rulings of the Interstate Commerce Commission. Numerous bulletins are also issued.

A summary of even a cursory paper like this shows a steady growth in railway regulation. There are few who do not realize that the Commission is not yet at the apex of its power. The majority of the thinking men of the country have faith in it and the idea that it stands for. Nevertheless the representative man, the man who controls our national policies, and the statesman who tries to mold public opinion are intense students of economic unrest. Truly, either would recognize an economic disturbance but would he be able to make a correct diagnosis of it? The interrelation of transportation facilities and industrial prosperity is evident, but the subtle, far-reaching reaction of a change in the first on the second is extremely difficult of correct analysis.

The Commission has admittedly been an enormous factor for good; but it is probable that men of the strong personality apt to be on such a board, and having an intimate knowledge of the vital importance of their decisions to the welfare of their country, see as the only solution of our grave transportation problems, an extension of their own power. The welfare of a railway line is so dependent upon the prosperity of the country it traverses that the road which tries to wax fat by preying on its patrons would ultimately have poor pickings. Perhaps, then, the unbiased students of economics who insist that railway rate regulation is not unfair, but inefficient are traveling on solid ground, and the future may vindicate them. With the civil engineer, however, it behooves him to cultivate the acquaintanceship of the Commission.

SHOULD A THESIS CONSTITUTE A RIGID REQUIREMENT FOR GRADUATION IN THE COLLEGE OF ENGINEERING?

A committee of the faculty of the College of Engineering, working under the chairmanship of Professor Goodenough, after giving more than a year to a study of problems affecting the courses of study of the College, presented a series of recommendations to the college faculty, among which was the following:

"A thesis as a rigid requirement is to be discontinued. A regular student of high standing may, however, with the approval of the head of the department have an option between a thesis and some specified engineering subject."

This recommendation with others was transmitted to the University Council on April 30, 1912, and subsequently was approved by the Council. It was later approved by the University Senate. It will become effective with the beginning of the next academic year, September, 1913.

In the discussion which preceded the action quoted above, the problem was presented from many different points of view. It seemed to be the opinion of the faculty that a thesis possessed high educational value for some students, while its value to others was altogether problematical. To whatever extent the thesis encourages originality and independence in work, its value was conceded, but the opinion of individuals differed as to the extent to which these advantages were secured.

W. F. M. Goss.

March 8, 1913.

Professor Baker seems to think that the preparation of a thesis affords training for a student that he can not get elsewhere in the curriculum. The following is an extract from a printed circular concerning the selection of the subject for, and preparation of a thesis, which he hands to each student early in his senior year. "The thesis differs from other subjects in the course in that the latter the student is expected simply to follow the directions of the instructor—to study specified lessons and recite thereon, to solve the problems assigned, to read the articles recommended;—while the preparation of the thesis is intended to develop the student's ability to do independent work. There is comparatively little in the ordinary college work to stimulate

the student's power of initiative, but in his thesis work he is required to take the lead in devising ways and means. The power of self-direction, the ability to invent methods of attack, the capacity to foresee the probable results of experiments, and the ability to interpret correctly the results of experiments is of vital importance in the future of any engineering student. Within certain limits the thesis is a test of the present attainments of the student and also a prophecy of his future success. The interest of the University in thesis work is shown by the fact that the student receives individual attention and practically has the resources of the institution placed at his command."

THE TECHNOGRAPH

Published quarterly during the college year, by students of the

ENGINEERING SOCIETIES OF THE UNIVERSITY OF ILLINOIS

Representing the interests of the Electrical, Mechanical, Civil, Chemical and Mining Engineering Departments.

H. W. UNDERHILL, '13 - - - - - *Editor-in-Chief*
 G. G. FORNOFF, '13 - - - - - *Business Manager*

E. C. PROUTY, '14 - - - - - *Asst. Business Manager*
 G. H. STOUGH, '13 - - - - - *President*
 R. H. BACON, '14 - - - - - *Secretary*
 E. P. HERMAN, '13 - - - - - *Editorial Staff*
 A. ELMENDORF, '14 - - - - - *Editorial Staff*
 H. F. CROOKS, '13 - - - - - *Editorial Staff*
 C. L. MONROE, '13 - - - - - *Business Staff*
 W. LERICHE, '14 - - - - - *Business Staff*
 M. L. NEBEL, '13 - - - - - *Business Staff*

ADVISORY BOARD

W. F. M. GOSS, M. S. D. ENG., *Dean of the College of Engineering.*
 G. A. GOODENOUGH, M. E., *Professor of Thermodynamics.*
 I. O. BAKER, C. E. D. ENG., *Professor of Civil Engineering.*

THE PUBLISHERS' ANNOUNCEMENT

Subscription price, \$1.00 a year in advance. Subscriptions payable by Post Office or express money orders, bank checks, drafts or registered letters, made payable to THE TECHNOGRAPH. Money in letters at sender's risk.

ADVERTISING—The rates for advertising will be quoted on application. Copy should be in the hands of the publishers by the 10th of the month preceding publication. THE TECHNOGRAPH, Urbana, Ill.

EDITORIAL

The question of senior thesis is being discussed again, pro and con in the various laboratories and drafting rooms and THE

SENIOR THESIS

TECHNOGRAPH has asked several faculty men to give their opinions on it. The editorial staff believes that the courses are so arranged that

only a limited amount of time can be given to thesis work, so limited that ordinarily no important researches can be made. Necessarily the thesis becomes a copy of facts already discovered. Occasionally a student may have had the opportunity to do some important work. In that case he should be permitted to work it up into a thesis.



THE 1912-13 TECHNOGRAPH BOARD

- | | | | | |
|-------------------|--------------------|----------------------|-------------------|------------------|
| E. P. Herman, '13 | W. Leriche, '14 | A. Elmendorf, '14 | H. F. Crooks, '14 | R. H. Bacon, '14 |
| E. C. Prouty, '14 | G. G. Formott, '13 | H. W. Underhill, '13 | G. H. Stough, '13 | |

With this issue the present board of THE TECHNOGRAPH lays down the reins of publication. It is with regret for the year's

**THE NEW
BOARD**

work has been one of interest and advancement. The aim of the board has been to make it more of a *student* publication—one that will appeal to its sponsors—the engineering societies. It wishes to express to the societies and to various individuals who have contributed to its support its hearty appreciation of their efforts.

The new board consisting of Mr. A. Elmendorf, '14, Editor-in-Chief; Mr. E. C. Prouty, '14, Business Manager; Mr. W. Leriche, '14, President and the junior and sophomore representatives will continue the publication with an issue, May 15. That issue will complete volume XXVII and will go to all present subscribers.

With a management that will continue over the summer vacation it is hoped to attain greater efficiency.

The new board has the earnest support and the best wishes of the retiring management.

EDITOR THE TECHNOGRAPH

Dear Sir: Please accept my thanks for the two copies of Volume XXVII of THE TECHNOGRAPH. I have been very much interested in looking over this volume,

A COMMUNICATION and I congratulate you upon its good appearance. I appreciate the fact that it consists chiefly of contributions by students and I think that this indicates real progress in the development of the TECHNOGRAPH idea.

Believe me,

Very truly yours,

W. F. M. Goss.

COLLEGE NOTES

Dean W. F. M. Goss gave an address entitled "Recent Progress in Engineering," before the members of Sigma Xi of the University of Chicago Thursday evening, March 6.

Professor H. F. Moore and Mr. G. E. Boomslder of the T. and A. M. department, have recently started tests upon the new steel armory trusses. A test of this kind will be watched with interest, and will give students who are interested in engineering a chance to see actual tests made upon a building under construction.

M. A. Slater of the T. and A. M. experiment station, has been retained by the city of Chicago as a testing expert on a large reinforced concrete warehouse.

"The Prevention of Industrial Accidents" was discussed March 7, by L. D. Breed-Love at the meeting of the A. S. M. E. Mr. Breed-Love pointed out that in 1896, twenty-one out of one hundred workmen received injuries. Now the annual percentage has been reduced—the injuries now being one man out of two thousand. He also described the various safeguards now in use to prevent accidents.

Mr. A. B. Domonoske has recently joined the staff of the mechanical engineering department, taking the place vacated by Mr. Buyers. Mr. Domonoske, who comes from the University of California, will have charge of work in machine design.

Colonel E. D. Meier of New York City, was the guest of Dean W. F. M. Goss Wednesday and Thursday, March 5 and 6. Colonel Meier is a past president of the American Society of Mechanical Engineers. Dean Goss gave a dinner in his honor at the University Club the evening of February 7.

Professor F. O. Du Four recently attended a meeting of the iron and steel committee of the American Railway Association at Buffalo, New York.

DEPARTMENT NOTES

ELECTRICAL ENGINEERING SOCIETY

Prof. A. M. Buck, of the Railway department, addressed the Electrical Engineering Society, February 28, 1913, on "The History of Electric Traction". He gave a very interesting account of the early attempts to utilize electricity for the propulsion of cars, before the days of the dynamo, and of the primitive types of reciprocating motors employed, supplied with current from large primary batteries. After the advent of the dynamo, many attempts were made to build electric railways, but the first really successful road, from a commercial point of view, was that built and operated at Richmond, Va., by Frank J. Sprague, in 1888. The speaker gave an interesting account of the troubles experienced in the first few years of commercial operation and some of the remedies applied, such as smoothing down a rough commutator by holding a brick against it. The address was greatly enjoyed by all present.

After the address, Business Manager Horrell gave a report of the Electrical Show, showing a probable profit of about \$200. The program committee was appointed, consisting of the following men:

- H. S. Badger, '13, Chairman.
- H. E. Thompson, '14.
- R. L. Hermann, '15.
- C. Wooley, '16.

E. A. James was elected as junior member of the TECHNOMOGRAPH board.

At a meeting of the E. E. Society February 14, the following officers were elected:

- President—E. S. Lee, '13.
- Vice-president—D. J. Smith, '14.
- Secretary—H. R. Tear, '14.
- Treasurer—J. G. Penn, '13.

C. R. Horrell, '13, was elected to represent the E. E. Society in the Engineering Dance committee.

That the Electrical Show was a success is shown by the fact that 3,500 people saw the various exhibits and passed judgment upon them. The receipts were approximately 900 dollars and

the expenditures about 700. The statistical data proved to be very interesting.

Mrs. H. W. Underhill won the prize for the lowest body resistance at 1200 ohms. The average resistance was about 1200 ohms while the maximum was 900,000. Mr. Roy Sievers of White Heath had the highest body voltage with .003225 volts. The average voltage was .001850. Mr. L. D. Clendenen won the flat iron by guessing the nearest to the correct number of dots in the sign. The correct number was 5870 while his guess was 5877. The lowest guess was 105 while the highest was 105,980,665.

AMERICAN SOCIETY OF MECHANICAL ENGINEERS

THE SMOKER

E. M. McCormick, '14

While Illinois was trimming Chicago at Track to the tune of 57-20, and the Ben Greet Players were pleasing their audience with their rendition of "The Comedy of Errors", at the Auditorium, and "Freckles" charmed the theater-goers at the Illinois, 200 Mechanical Engineers showed their loyalty to the Profession by attending the Annual M. E. Smoker at Hessel Hall. The committee, composed of A. L. Myers, Chairman, Elmer McCormick, and E. F. Gehrig, made good their assertion that this smoker would be the best ever held by the society. Immediately on entering the Hall, the strains of exquisite music, rendered by an orchestra composed of Mechanical Engineers, fell upon the ears of those assembling. Cigars, cigarettes, P. A., and pipes were supplied in abundance. Soon after, "eats", consisting of ginger-bread and apples, were brought forth, with plenty of good cider to relieve the "thirst".

When the orchestra had finished its program, chairs were brought around the rostrum by those present and the program began in earnest. "Illinois Loyalty" and "Oske-wow-wow" were sung with a vim. The first speaker to address the meeting was "Baldy" Simpson, Vice-president of the A. S. M. E. He welcomed those present in a manner, such as only "Baldy" can do. He was met with a round of applause as he quitted the platform. Mosher of The Engineering Experiment Station followed. He raised the spirits of the assemblage to a much higher level by telling a few stories and jokes, such as only Mosher can tell.

Mr. Scroggin of the machine shop was called upon to tell a story, which he had promised to tell at the next smoker. His memory failed him badly at this juncture and he was compelled to tell others to make up for it. Chestnut was called upon to add to the program. He responded to the occasion by a vocal solo. His rendition was so good that he had to respond with an encore, so great was the applause. Prof. Richards closed the talk-fest by a rather "somber" talk as he called it. He took upon himself the task of defining "What Mechanical Engineering really is." According to the definitions of his authorities, Mechanical Engineering, could well be called an art, trade, or profession. However he went on to show that the term, profession, really applied to Engineering, more than did art or trade. He spoke at some length of the possibilities of Mechanical Engineering and congratulated those present on their wise choice of a future occupation. Not forgetting the University, he outlined the plans of the Department for the future; and urged each one present to bring back with him next year a student in Mechanical Engineering.

Simpson and Shapland were given an opportunity to show their powers in the ring. Each one was confident of himself. It looked as if the fight would be a draw; but Simpson put Shapland to the mat so hard in the third round, that the referee had counted him out before he could arise. Simpson was declared victor amid the hurrahs of his cohorts.

The meeting broke up soon after, each one declaring that the committee had "outdid itself" in offering so excellent a smoker.

CIVIL ENGINEERING CLUB

In January 10, Professor I. O. Baker gave an illustrated lecture in the Keokuk power development. The most important points on the dam project were clearly shown to the club members.

Professor A. B. McDaniel talked on the "Romance of tunneling" the following week. The Pennsylvania Railroad tunnels at New York City were illustrated in detail.

At a meeting of the C. E. Club January 21, the following officers were elected for the second semester.

President—R. A. Bennett, '13.

Vice-president—R. E. Truley, '13.

Secretary—P. T. Bock, '13.

Treasurer—L. X. Loeffler, '13.

R. A. Bennett talked on his experiences on the Madiera-Mamore railway construction in Brazil, South America.

G. H. Stough, '13, and R. A. Bennett, '13, are the club representatives on the Engineering Dance Committee.

Mr. J. E. Conzelman, Chief Engineer of the Unit Construction Company lectured March 7th on "Reinforced Concrete Construction."

MINING SOCIETY

A lecture on coal-forming plants given by Professor Jeffrey on February 20, proved highly interesting to the men registered in the mining course. New theories regarding the formation of coal were substantiated by lantern slides which clearly illustrated the structure of the coal.

Arrangements are under way for two trips of inspection to points of mining interest near Danville which are to be made by the Mining Society in the near future.

At the regular business meeting of the society held on February 27, it was decided to give a smoker as an inducement to increase the attendance at the meetings, and especially at the journal meetings.

R. Y. Williams, Mining Engineer for the Bureau of Mines who has recently returned from Alaska has consented to lecture to the student body at some later date.

C. C. Kramer was elected to the TECHNOGRAPH staff as junior representative of the Society.

The officers of the society for this semester are as follows:

M. L. Nebel, president.

D. S. Crow, vice-president.

L. W. Swett, treasurer.

Willis Leriche, secretary.

CHEMISTRY CLUB

Chemists on Annual Inspection Trip

On March 20, the junior and senior chemists and chemical engineers in charge of Dr. D. F. McFarland of the department of industrial chemistry left for Chicago on their annual inspection trip. The trip lasted until the 22d and those who desired left the party at that time; the others continued the inspection of plants

on the 24th. On the 25th the party went to Milwaukee to attend the annual meeting of the American Chemical Society.

The plants inspected in Chicago and vicinity were:

The Corn Products Refining Co., at Argo, Illinois, about fifteen miles from Chicago. Here was studied the manufacture of glucose, starch, corn oil, oil cake, dextrin, a substitute for rubber, and other products, all from corn.

The American Linseed Oil Company in Chicago, where linseed oil and oil cake, a valuable cattle food, are manufactured.

The Carter White Lead Company, in Chicago, where white lead is made by the quick process. Also the grinding and mixing of paints was studied here.

The Cemet-Solvoy Coke Company, in Chicago, where coke is manufactured, and the gases given off during the process are worked for coal tar and ammonium salts.

The Illinois Steel Company, at South Chicago. Here the manufacture of iron and steel from the raw ore was observed following it through the blast furnaces, the Bessemer converter, or the open-hearth furnace, the soaking pits and finally through the rolling mills, into rails or boiler plate. A 25-ton electric furnace, for the manufacture of special steels was in operation.

The Grasselli Chemical Company, at Grasselli, Illinois where chemically pure acids and heavy chemicals are manufactured.

The American Metals Refining Company, at East Chicago, where lead bullion is refined electrolytically by the Betts process.

The Linde Air Products Company, at East Chicago, where liquid air and compressed oxygen is put up in cylinders for the market.

The Armour fertilizer works at the Union Stock Yards. Here was seen the manufacture of one of the most important by-products of the packing industry.

The Barrett Manufacturing Company, in Chicago. Here coal tar is distilled, and road paving or binding materials and roofing paper are manufactured.

On Saturday, February 22, Dr. D. F. McFarland took a party of junior and senior chemists and chemical engineers to Danville, to inspect the Haegler Bros.' Zinc works and sulphuric acid plant. One of the owners conducted the party through the works.

The party also visited the Headley Glass Works, where bottles for all purposes are manufactured.

Have You Learned How



“From the Raw to the Finished Product”

—a 72 page booklet descriptive of the “Chicago AA” process of manufacture. Illustrated with 66 halftone engravings from photos taken at our mills.

FREE

to cement-users. Write for a copy *today*.



“Chicago AA”

Portland Cement is made?

It is a story of great interest to the man who uses cement. It tells how the raw materials are taken from the quarries, how they are weighed, proportioned, crushed and conveyed to the mills; it describes the “Chicago AA” process of drying, grinding and then burning the raw mixture to a “clinker” and explains, in an interesting way, the method of cooling the “clinker” and grinding and re-grinding it, thus producing “Chicago AA” Portland Cement, “the best that can be made.”

Read this story: It will enable you to better appreciate the superiority of the “Double A” brand—it will guide you in the selection of a cement for your work in the future.

Chicago Portland Cement Co.
30 No. LaSalle Street, Chicago, Ill.

Manufacturers of the

“Chicago AA” Brand

“The Best That Can Be Made”

Present Output **1,500,000** Barrels Annually

When writing to advertisers please mention THE TECHNOGRAPH

KEEP POSTED ON STYLES



THE SPRING SUIT QUESTION

Are you wrestling with it? Come here and we'll help you solve it.

OUR SPRING SUITS

are ready and the handsomest we've ever shown. Fabrics New, Cut New, Tailoring New, Prices Reasonable.

\$15-\$17 Style Plus

\$18 to \$30

Copyright 1913 The House of Kuppenheimer

Come to Us for Your Outfitting

J.M. KAUFMAN AND COMPANY

Champaign's Largest Store

TH

UNIVERSITY OF ILLINOIS
ENGINEERING LIBRARY
CHAMPAIGN, ILL.

THE TECH- NOGRAPH



MAY, 1913

VOLUME XXVII

NUMBER 4

Steam Flow Meters

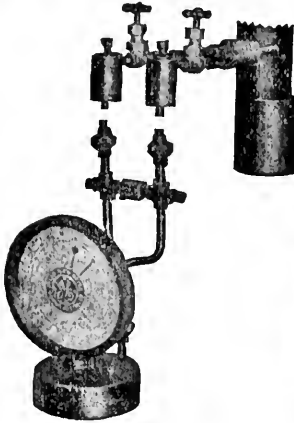

Indicating Flow Meter for Permanent Installation

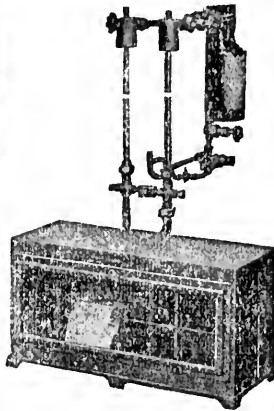

Recording Steam Flow Meter



Portable Flow Meter for Use in Testing

Aids to Power Plant Efficiency

The G-E flow meter was originally developed to give instantaneous readings of the steam input of a turbine, which information could not otherwise be obtained without a long and expensive water rate run. The flow meter operates on the principle of the Pitot tube, but the form of the tube has been improved so that the readings of the flow meter have a high degree of accuracy.

G-E flow meters are of great value in maintaining the efficiency of a steam power plant. In the production of steam they are used to show the output of each boiler. This makes it possible to equalize the load on all the boilers so as to secure maximum efficiency on each. It also shows when any boiler needs cleaning by the decrease in output.

In the use of steam, flow meters show where the steam is used, making accurate distribution of costs possible. They also show whether the efficiency of the turbines or engines is as high as it should be, and are useful in detecting leaks in underground piping. In one large factory a leakage costing \$125 a week was discovered by a G-E flow meter.

G-E Flow Meters are furnished to measure steam, water, air or natural gas. Descriptive Bulletins sent on request.

General Electric Company

Largest Electrical Manufacturer in the World

General Office, Schenectady, N. Y.

Sales Offices in fifty-four cities

3822



When writing to advertisers please mention THE TECHNOGRAPH

The Technograph

VOL. XXVII

MAY, 1913

No. 4

THE NEW LOCOMOTIVE LABORATORY OF THE DEPARTMENT OF RAILWAY ENGINEERING*

EDWARD C. SCHMIDT.

The new locomotive testing plant of the department of railway engineering is the fourth of its kind now in existence in this country. There are two other similar laboratories abroad, one in Russia, the other in England. The first locomotive testing plant was built twenty-one years ago at Purdue University. It was designed by Dr. W. F. M. Goss, who was at that time in charge of the schools of engineering at that institution. The work of this laboratory during its twenty years of operation has given us much original and timely information concerning locomotive performance, which has had a significant influence on locomotive design both here and abroad.

The justification for the existence of locomotive testing plants lies in the fact that in them only can the locomotive be run under conditions which may be rigidly controlled and varied at will. It is also true that in the test plant the difficulty and expense of making tests are both greatly reduced; but this in itself is less important than the control of the operating conditions which test plant service puts in the hand of the experimenter. In the laboratory, the load and speed may be held uniform throughout any period of time or they may be made to vary according to any predetermined program. Variations of wind velocity and air temperature are eliminated. All the advantages which laboratory tests have over road tests lie in this power to control conditions. As a consequence of this control practically all questions relating to boiler performance can be better and more easily settled in the

*An abstract of a paper presented to the Western Railway Club in March 1913.

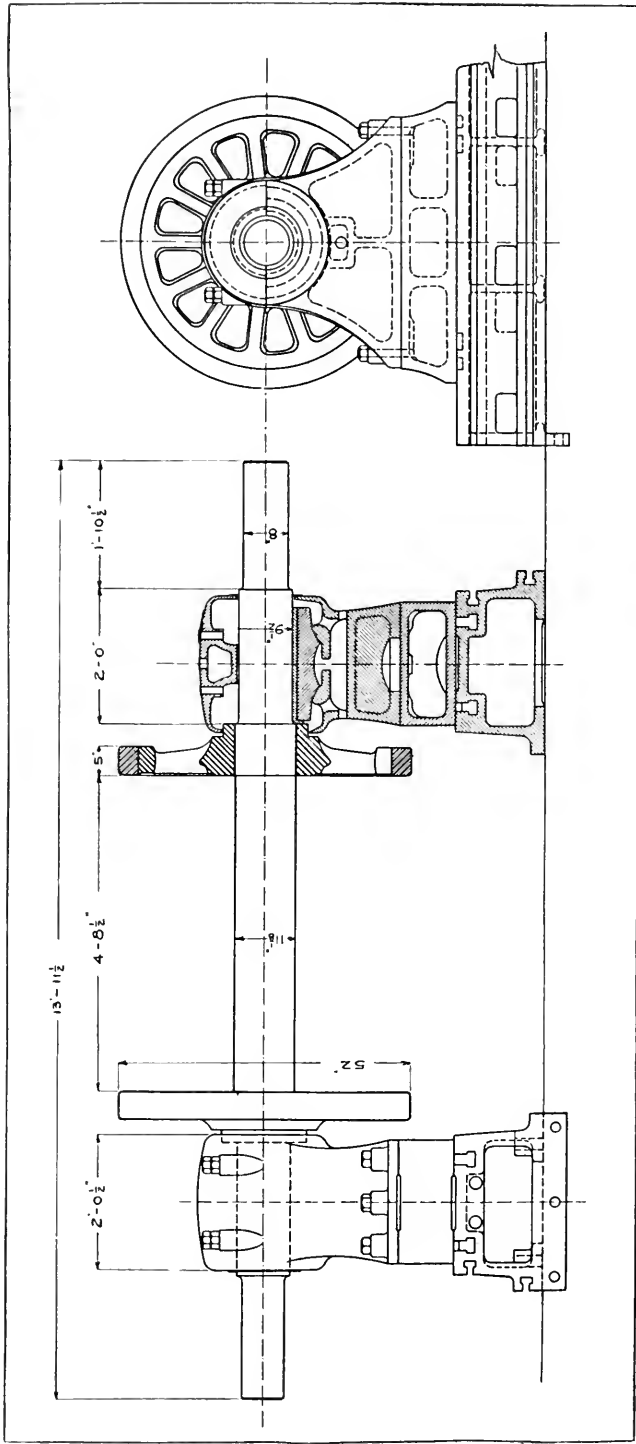

Fig. 1—One Pair of Supporting Wheels, with Axle, Bearings and Red Plates.

testing plant than on the road and the same remark is equally true of questions touching engine performance. There are but few problems relating to fuels which cannot be more easily attacked and more conclusively settled in the testing plant than on the road; and certain problems—like the determination of engine friction—which lie beyond the reach of the experimenter who must rely on road tests, can be successfully attacked in the locomotive laboratory.

Any locomotive laboratory consists essentially of, first, a means for so supporting the locomotive that its wheels may be rotated and that the power developed may be absorbed and either dissipated or transferred; second, a means for anchoring the locomotive when so mounted and for measuring the tractive effort developed; third, means for supplying and measuring coal and water; and finally, means for disposing of the gases and steam from the front end. The supporting mechanism consists in this plant, as in all others, of wheels whose position may be varied to conform to the spacing of locomotive's driving wheels. In this case the supporting wheels are 52" in diameter, provided with plain tires and mounted on $11\frac{1}{8}$ inch axles. The axles and tires are of the highest grade of heat-treated carbon steel and were furnished by the Midvale Steel Company. The use of 52" supporting wheels involves rotating speeds as high as 500 revolutions per minute in testing high speed locomotives. Such speeds may give rise to difficulty in the operation of the bearings although they have been designed with regard thereto. In anticipation of such difficulty however, provision has been made (in the design of the bearing pedestal) for using 72" diameter supporting wheels, if it later proves desirable to do so. The axles are supported at each end just beyond the wheels, in bearings $9\frac{1}{2} \times 20$ " which are provided on the under side of the journal only. These bearings are carried in self aligning shells which are supported in pedestals of exceedingly heavy construction. Oil is provided at two points in the bearing cap, where it is supplied under head from an elevated supply tank. The bearing pedestals rest on massive cast iron bed plates which run the entire length of the testing pit, and are secured thereto by bolts whose heads are held in slots running the length of the bed. The pedestals may therefore be shifted to any desired position on the bed. The general design of the axle, wheels, bearings and bed plate is well represented in figure 1.

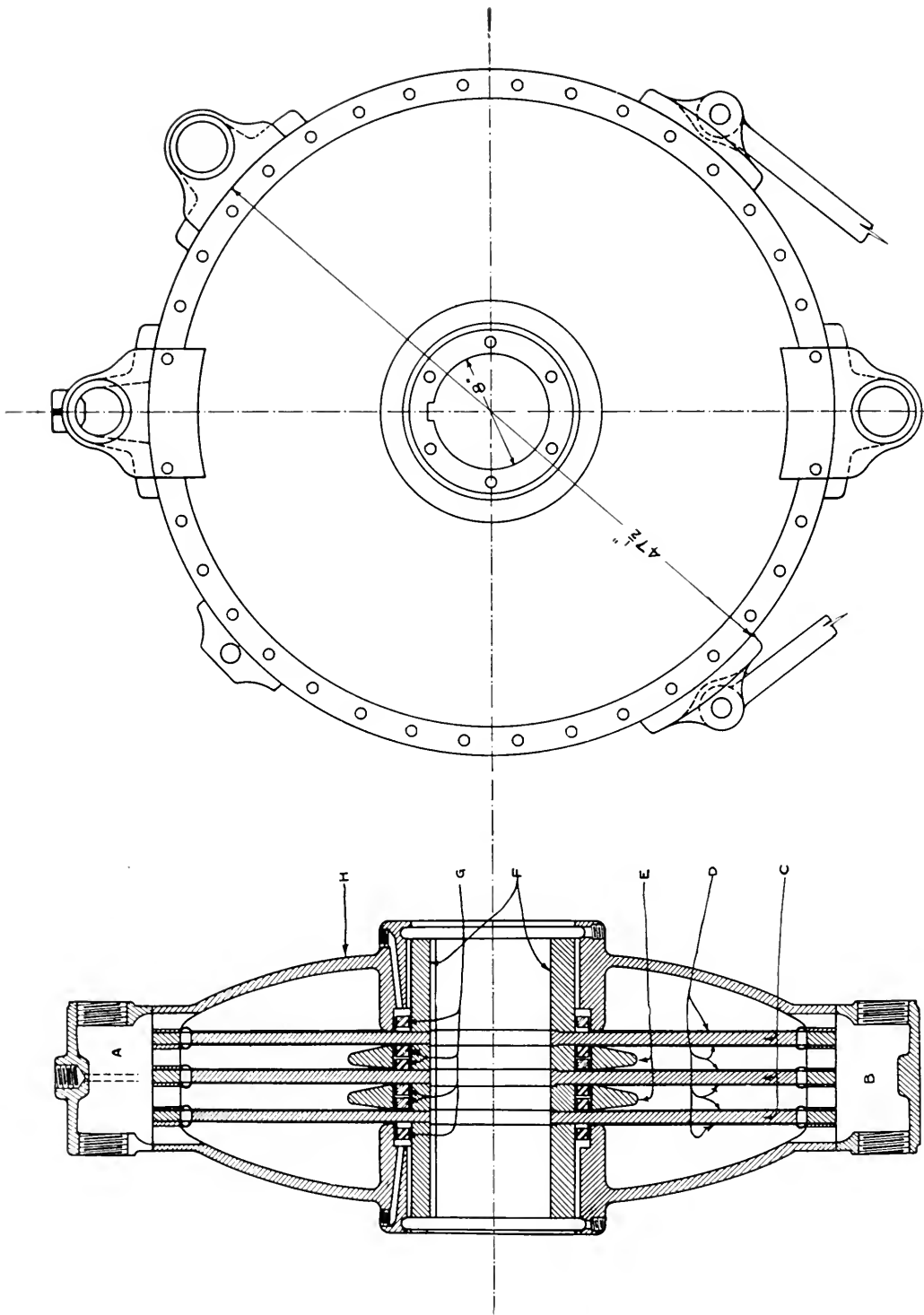

Fig. 2—One of the Brakes. Mounted on the ends of the supporting axles these brakes absorb the power developed by the locomotive,

Each of these units, consisting of an axle, two wheels, and two bearings constitutes the supporting element for one pair of locomotive drivers. So supported, the driving wheels may turn; and there remains to be provided a means for absorbing the power developed at the driving wheel rims.

The brakes shown in figure 2 furnish this means. They are of the type used in all other American testing plants, and were designed and furnished by Professor G. I. Alden of Worcester, Mass., under general specifications prepared by the designer of the plant. One of these brakes is mounted on each end of each supporting axle. Each brake consists essentially of three cast iron discs (C) which are keyed to the supporting axle, and which rotate between water cooled copper diaphragms (D) carried in stationary casing (H). The cast hub F and the three discs form an integral rotating element which is keyed to the axle and turns with it. The casing and its diaphragms are prevented from rotating by means of links attached to the bed plates. The diaphragms provide within the casing three compartments within which the cast iron discs rotate. The surfaces of the discs and of the diaphragms are lubricated by oil fed in at the periphery of the discs and taken off at the hub. The diaphragms form also within the casing four water compartments which have no communication whatever with the compartments within which the discs rotate. Water is fed into these water compartments at B and is taken off at A. The pressure existing in these water spaces may be varied at will by means of suitable valves in the brake piping. The operation of the brakes is as follows: Power received from the driving wheels of the locomotive is transmitted through the supporting wheels and axle to the cast iron brake discs; these in turn transmit it by friction to the surfaces of the copper diaphragms against which they rub. By varying the water pressure, the friction between the discs and the diaphragms may be varied in accordance with the amount of power to be absorbed. The entire power of the locomotive is thus dissipated at the surface of the diaphragms and carried away as heat in the water which circulates through the brakes. Each brake is designed to develop a resisting torque of 18,000 pounds-feet which is more than is likely to be transmitted to it by the most heavily loaded locomotive driver.

The machinery thus far described, which serves only to support the locomotive and to absorb its power, is all carried on a

foundation located at the basement level of the building. This foundation is a slab of reinforced concrete 93 ft. long and 12 ft. wide, varying in thickness from 3½ ft. at the front to 5 feet at the rear. It is surmounted at the rear end by a pyramidal base which serves as the anchorage for the dynamometer. The mounting machinery thus far described is shown in figure 3 arranged for the reception of a consolidation locomotive. The highest point of the supporting heels is at the level of the main floor of the building, which is the same as the rail level of the exterior track. The locomotive to be tested is backed into the laboratory over the track shown in position in this view, the tender having been

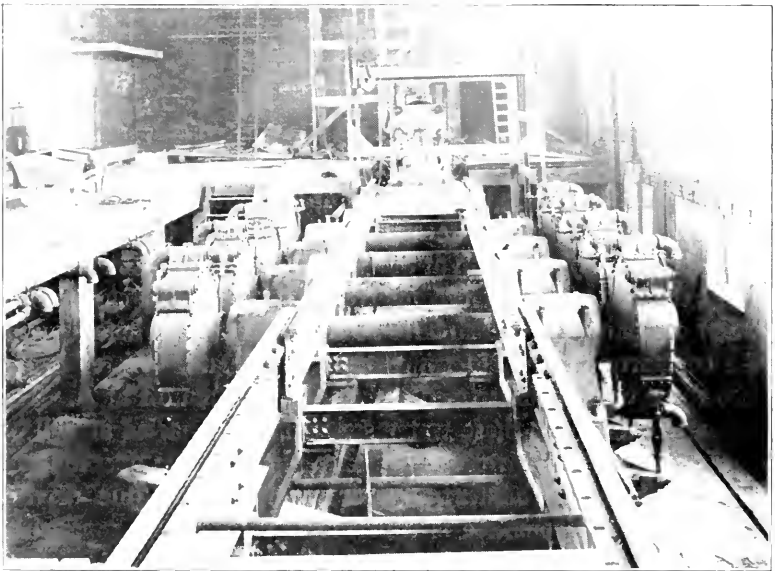

Fig. 3—The Rear End of the Testing Pit. Showing the removable track, the supporting wheels, the bearings and the brakes in position for testing a consolidation locomotive.

removed. Over the last section of track the drivers run on their flanges leaving the treads free to engage the supporting wheels. When the drivers are properly placed and the locomotive securely anchored this track section is removed. Thus mounted, the locomotive is anchored, by means of a massive draw-bar, to the dynamometer which appears in the middle background of figure 3. It is thereby prevented from moving either forward or backward from its proper position on the supporting wheels.

This dynamometer, whose chief function is to permit the tractive effort of the locomotive to be measured, is shown in figure 4. It is of the well known Emery type designed and built by the William Sellers Company of Philadelphia. While its principles of operation are simple its design is complicated, and a detailed description lies beyond the scope of this paper. It will suffice to say that it consists essentially of the "weighing head" shown at the left in figure 4, carried on the housing there shown, and of a weighing scale not included in the picture. Within this weighing head is an enclosed oil chamber with a flexible wall, which receives and balances any force transmitted from the locomotive. The pressure of the oil in this chamber varies with the load and is transmitted through a copper tube of small bore to a similar smaller oil chamber, the pressure within which moves the beam of a substantial but very sensitive scale. The force transmitted to the dynamometer is thus weighed. In design this instrument is similar to that of the original dynamometer furnished for the Purdue University Plant by the same builders. Its capacity however is about four times as great, namely 125,000 lbs.* Up to this limit it will measure with great accuracy any force transmitted to it from the locomotive. The capacity of this instrument is about 15,000 lbs. in excess of the greatest tractive effort which could be imposed upon it by even the most powerful Mallet locomotive now in existence. In this connection it may be remarked that the plant has been designed throughout so that it can receive for test the largest existing locomotives even of the Mallet type; and at the same time all the equipment and the building itself have, in size and capacity, sufficient margin to allow for a very considerable increase in the size, and weight, and power of locomotives before a point is reached when new designs will exceed the capacity of the plant.

It would unduly lengthen this description to describe in detail such minor features of the plant as the means of weighing and supplying the water to the boiler and brakes, and for storing and weighing the coal. These and all other details of the plant have received the most careful consideration in order to insure their accuracy, convenience, and durability. They include the weighing tanks, hydraulic elevator, scales, coal room, and firing platform

*The maximum capacity of the dynamometer used in the Pennsylvania Railroad Company's plant at Altoona is 80,000 lbs.

whose general design and arrangement are shown in figures 6, 7 and 8. The water supply perhaps warrants further mention. The general water supply of the University is from driven wells, the demand upon which approaches at times their full capacity. No other source of cooling water for the brakes is available. Water from the brakes could not therefore be wasted, and provision has been made for cooling and recirculating it. For this purpose there will be built in the round outside the building a reinforced concrete reservoir of 100,000 gallons capacity. A supply pump for the brakes draws water from this reservoir, pumps it through control valves to the brakes, whence it flows through another set of control valves to a pump located in the basement of the laboratory. Another pump returns it from here to the reservoir. The feed water is drawn from this reservoir by a separate pump, passed to the weighing tanks and feed tank and thence to the injectors. This feed water, of course, is wasted and must be restored to the reservoir between tests, by drawing on the general university supply.

Those elements of the equipment which have been thus far described are similar to the corresponding elements in other locomotive laboratories although they differ from them in the details of their design and exceed them in size and capacity. In the design of the means for disposing of the exhaust gases, however, new problems were presented and new solutions have been reached. In view of the importance of determining accurately the total fuel lost in the exhaust gases, it was early decided to try to incorporate in the design of this plant some means for entrapping *all* of the solid matter contained in the gases passing the locomotive front end. This purpose has previously been served by collecting in a sampling tube the solid matter which passes a small section of the exhaust gas stream, and pro-rating the loss of solid fuel thus determined over the entire stream section. This method is not always convenient, and under certain conditions its results have been questioned. The preliminary design of a spark trap or cinder collector which would pass the total volume of gas and exhaust steam from the largest modern locomotive when working at high power, made it clear that such a collector would be too large to be located conveniently within the building. A second fundamental consideration in designing the exhaust system was the necessity of providing a stack of sufficient height to insure that the

exhaust gases would be discharged high enough above ground to prove inoffensive to occupants of neighboring residences and university buildings. It was decided that this would require a stack about eight feet in diameter and at least eighty feet high. Further study made it apparent that these two decisions could be embodied in one structure combining the cinder separator and the stack. This has been accomplished in the construction represented in cross section in figure 5, which is located outside of and at the rear of the laboratory. The system will be most easily understood in following (by reference to figure 7) the course of the exhaust gases as they emerge from the locomotive stack. They are discharged thence into a steel exhaust elbow which carries the gases up and over to the center of the building, where they are received in a horizontal duct running through the center of the roof trusses. The gases are drawn through this elbow and duct by an exhaust fan, located near the roof at the rear end of the building. Probably the heaviest cinders will be dropped in this duct, but the velocity within it is such that all but the heaviest particles of solid matter will be carried on through the fan. Whatever does accumulate here may be removed through traps provided in the bottom of the duct, and weighed. From the fan, the gases and the remaining solid matter are passed through a breeching or flue to the separator above referred to, the action within which may be best explained by recurring to figure 5. The cinder laden gases enter this separator at B and in order to leave they must pass downward and around the sleeve A. In so doing they are given a whirling motion which causes the cinders to move toward the wall along which they drop to the hopper below, while the gases pass downward and out to the stack through the mouth of the sleeve. The cinders collecting at the bottom of the hopper are drawn off and weighed. This separator is surmounted by a 45 foot radial brick stack from which the gases are finally discharged 81 feet from the ground.

The corrosive nature of the mixture of exhaust gas and steam has made it necessary to avoid the use of metal throughout this exhaust system. The exhaust elbow within the building necessarily has been made of steel, and will need occasionally to be renewed. The duct, however, is of asbestos board ("Transite") which will resist corrosion. It is 7 feet in diameter, and made up of separate sections so that its length may be varied. The fan has a runner 6 ft. in diameter, and will pass, at maximum speed,

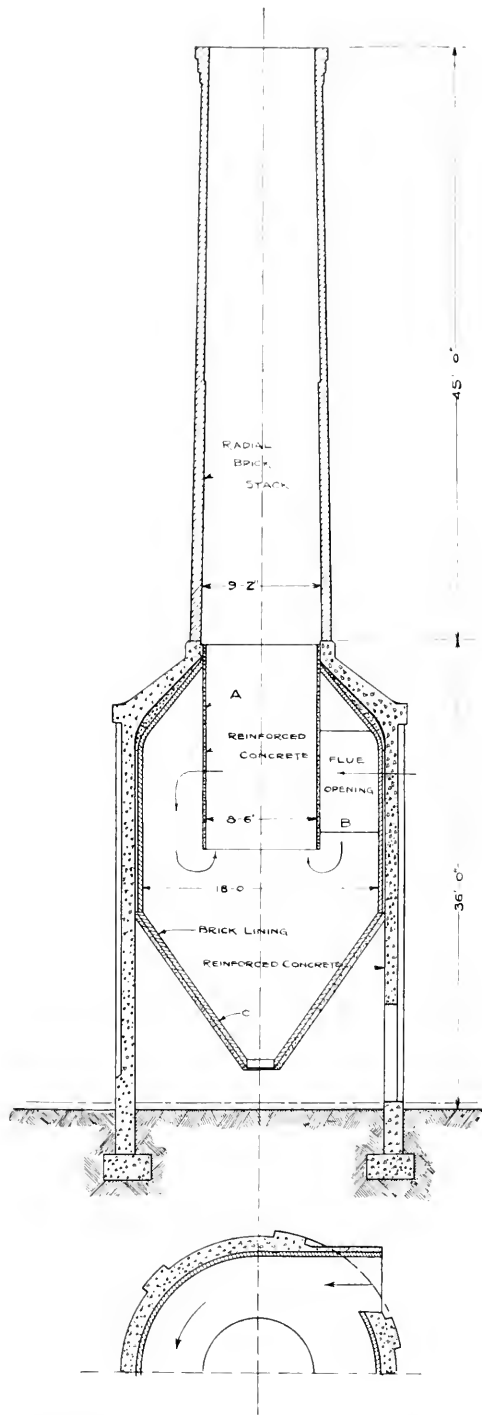

Fig. 5—A Cross Section Through the Cinder Collector and the Stack

140,000 cubic feet of gas per minute. The breeching between fan and separator is built of transite, and has a minimum cross sectional area of about 24 square feet. The outer shell of the separator is built of reinforced concrete. To correct the shell from corrosion, it is lined throughout with a hard burnt red brick. Between this lining and the shell is a 2" air space to act as an insulator to protect the shell from undue heating. Any leakage of gas through the lining into this space is vented to the outside air through openings which are provided in the shell, and which

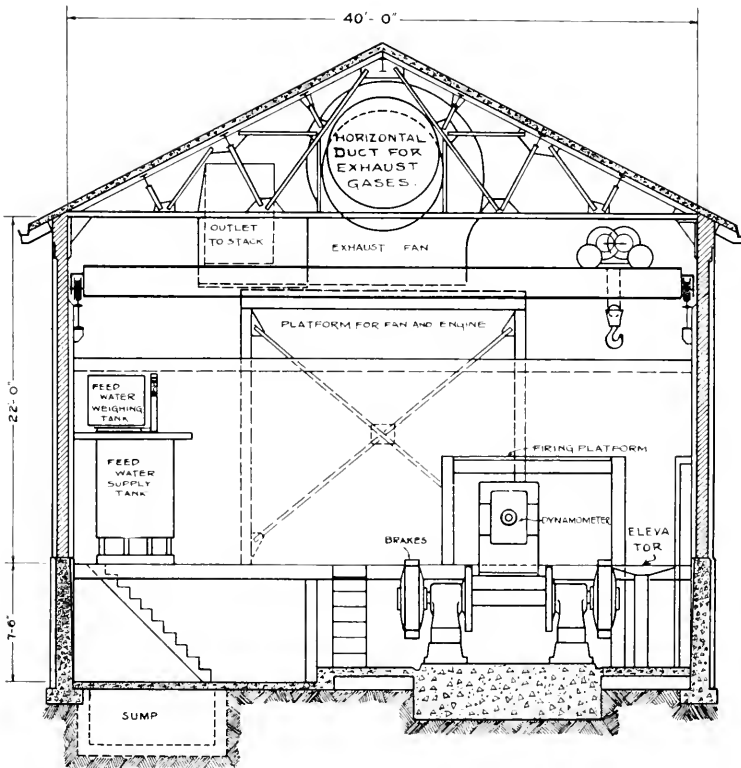

Fig. 6—A Cross Section through the Middle of the Laboratory.

serve also to circulate cool air through the air space. The inside sleeve and hopper are both built of reinforced concrete. The stack itself is unlined, but is laid up in acid proof cement. It is expected that this whole system will not only permit the collection of all solid matter and thus enable front end losses to be determined in a manner beyond criticism; but that it will also dispose

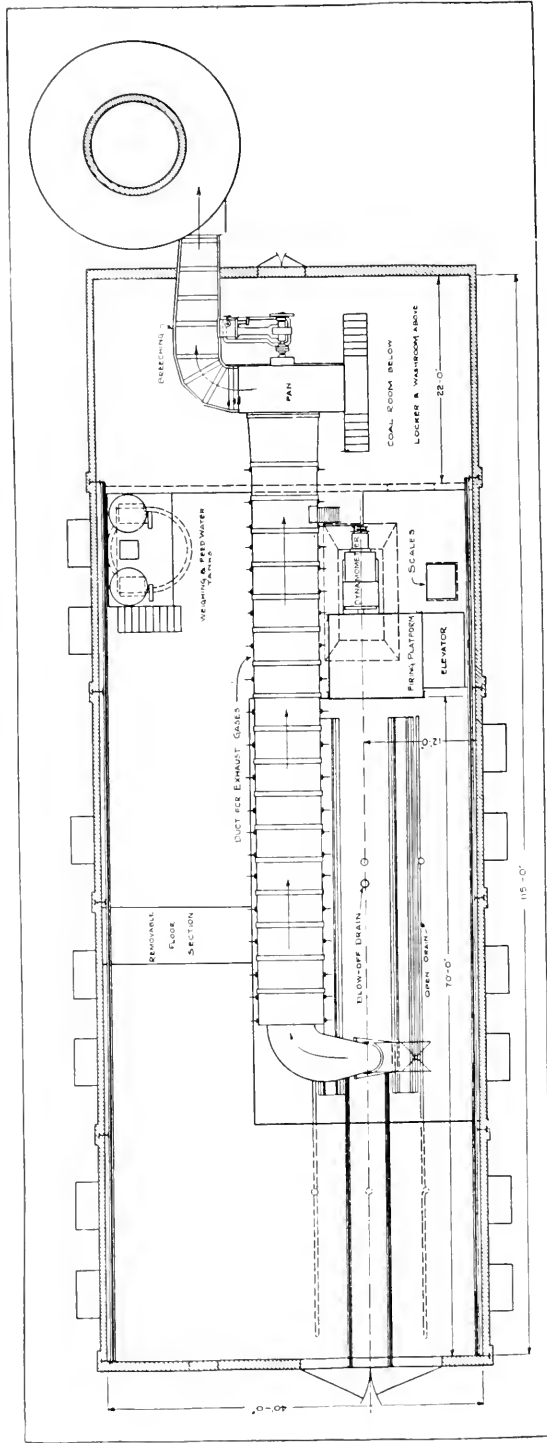

Fig. 7—A Longitudinal Section Through the Laboratory, Showing the General Features of the Building Design and the Positions and Relations of the Apparatus.

of the smoke so that it will be unobjectionable and at the same time act as a muffler and eliminate objectionable noise from the locomotive stack discharge.

The main features of the building which houses this equipment are shown in figures 6, 7 and 8. It is 40 ft. wide and 115 ft. long, with a height under the roof trusses of 22 ft. A basement with a 6 ft. 9 in. clear depth extends throughout all but 22 ft. of its entire length. The construction is fireproof throughout. The

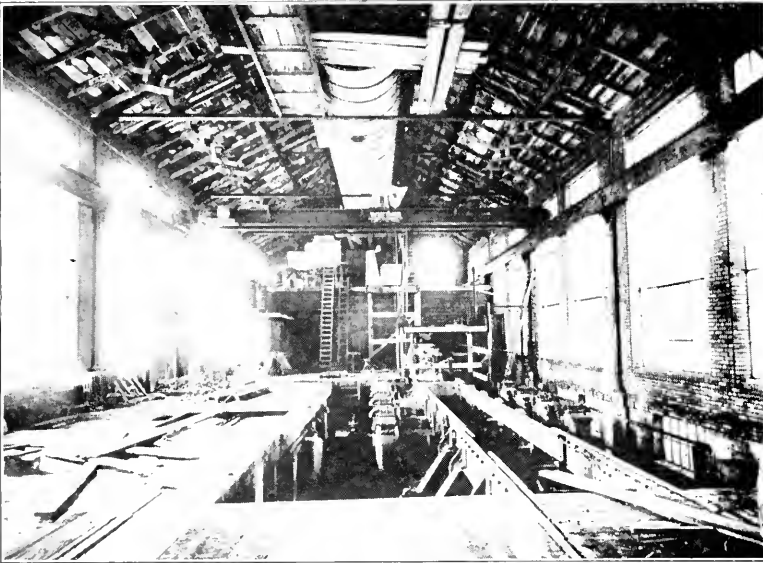

Fig. 8—An Interior View of the Partially Completed Laboratory, Looking Towards the Rear.

walls are laid up both inside and out with red faced brick, the roof is of reinforced concrete covered with slate, and all floors, are of reinforced concrete also. The building is unusually well lighted by windows in the side walls which extend nearly the full height of these walls and occupy almost two-thirds of the wall area. All portions of the building, except the space occupied by the coal room in the west end, are served by a 10-ton traveling crane.

In the design of this plant the University has profited by the generous advice and assistance of those in charge of the laboratories at Lafayette and Altoona. Drawings and records of experi-

ence and of initial difficulties have been courteously placed at our disposal; and if in some details we shall have avoided similar difficulties, it will be largely due to this assistance which it is a pleasure thus to acknowledge. It is a pleasure also to acknowledge the part taken in perfecting the details of the design, by Mr. F. W. Marquis, Mr. H. H. Dunn, and Mr. H. B. Ketzle, members of our own railway department staff.

It is no part of our plan to own a locomotive for service in this laboratory. The whole plant has been designed with the intention of making it suitable to test new designs as they appear, in the confidence that the railroads and builders would be willing to keep upon the plant locomotives of recent design, concerning whose performance all railroad officials desire information; and we have proceeded in this plan with very generous assurance from those interested that we should not be disappointed in this expectation. The first locomotive to be tested is one of the consolidation type owned by the Illinois Central Railroad.

THE USE OF CONCRETE IN CITY PAVEMENTS AND COUNTRY HIGHWAY CONSTRUCTION

H. K. TALBOT

The requirements for a good country road and city pavement are identical, viz., a construction which will stand up under the traffic which comes upon it, and a low ultimate cost. Concrete fulfill these requirements, and there remains only to point out the manner in which cement, sand, and stone or gravel may be mixed and placed to obtain satisfactory results.

The history of concrete roads began in 1893-94 when the City Engineer of Bellefontaine, Ohio, after having put down wide concrete gutters which served as pavement near the curb, was sufficiently impressed by the adaptability of concrete for road purposes to specify its use as a pavement for the four streets surrounding the Court House Square. After the sub-grade was prepared and drainage provided, a 4-inch base mixed in the proportion of 1 part Portland cement, 2 parts sand, and 4 parts of gravel was placed and struck off to grade. Immediately following this a 2-inch top mixed 1 part cement to 1 part of screened bank sand was placed and finished to a smooth true surface. Beginning at the curb, the pavement was laid in 5 foot strips and after being completed was cut into blocks 5 feet square. The engineer believed that by so doing it would be possible to remove the blocks in case repairs were necessary to sewer or water pipes, and after making the repairs to refill trenches and relay the blocks. Although no expansion joints were used, the joints between the blocks gave a sufficient chance for contraction so that no cracking has resulted. To afford foothold for horses the surface was scored with V-shaped grooves $\frac{1}{2}$ inch deep and about $\frac{1}{2}$ inch wide at the top. A few of the longitudinal joints have rutted and have been repaired by placing concrete in them. No serious holes have appeared in the top of this pavement at any time, and a considerable portion of the surface still shows the markings that were made at the time the pavement was laid. It is evident that if the longitudinal joints had been omitted, and that if the transverse joints had been placed further apart and protected, the pavement would be in almost perfect condition at present. The cost of this pavement to the city, constructed as it was by contract, was \$2.25 per square yard, including grading, curb and

drainage. The total cost of repair during 1908-09-10 was \$63,03. The pavement is at present 10 years old and is in condition to withstand many more years of constant wear.

From this small beginning, the use of concrete pavement has grown to such a magnitude that concrete today is one of the foremost paving materials, not only from point of adaptability, but from the amount laid each year.

During the time which has elapsed since 1804, a large variation has appeared in mixtures and methods used in constructing the pavement. Often the engineer or contractor has bent his efforts on building a road which would at least appear satisfactory in the beginning for as little money as possible, instead of trying to construct the best possible pavement with the materials available. The result of this carelessness has been that some of the concrete pavements have not proved satisfactory in the past, nor will concrete pavements be universally successful until the engineer and contractor realize that good pavements mean more than good cement; that they mean good workmanship, good aggregate and proper proportioning.

Concrete pavements as at present laid, may be divided into four general classes; 1st,—The Hassam compressed concrete pavement; 2d, Two-course pavement; 3d, One course pavement; and 4th, Bituminous covered pavement. These classes will be taken up in the order named.

The Hassam compressed concrete pavement, which has been patented and is at present laid either by or under the general supervision of the Hassam Paving Company, has been used extensively in the eastern portion of the country and especially in the vicinity of New York.

Due to the fact that this is a patented pavement and the work placed in the future will probably be handled under the supervision of the patentee, this type will not enter into the discussion of the relative merits of obtaining the best possible concrete road for the money available.

The earlier concrete pavements were constructed of two distinct courses of different thickness and mixture. Two theories may be considered responsible for this design, first, the necessity of obtaining a uniform surface to resist the wear, and second, fear that stones allowed near the surface would ravel under traffic. In order to obtain the smooth and uniform surface cheaply and easily, it was considered advantageous to use a mix-

ture of cement and sand, as the larger stones made finishing more difficult. The most objectionable feature of this construction has been that a hole, when once started, rapidly increases to large dimensions as there is no aggregate in the top of sufficient size to resist the traffic. The belief that ravelling would result if the larger stones were near the surface was undoubtedly the result of experience with lean concrete mixtures. However, it has been demonstrated by the construction of satisfactory one course pavements that if the mortar is sufficiently rich and the stones well bedded, no trouble will be experienced from this source.

The specifications accepted by the National Association of Cement Users in 1912, require that a two course pavement be constructed as follows: The base, which in no case shall be less than 5 inches thick, is mixed in the proportion of 1 part cement, $2\frac{1}{2}$ parts sand, and 5 parts gravel or crushed stone. Immediately after the base is placed and before it has shown any signs of hardening, a top of $1\frac{1}{2}$ to 2 inches mixed in the proportion of 1 part cement and two parts of aggregate for a wearing course, is deposited and finished with a wood float. The aggregate for the wearing course is defined as consisting of screened gravel or stone screenings from granite or other close grained durable rock, sufficiently hard to scratch glass, free from loam or other deleterious matter, mixed in the proportion of 3 parts passing a $\frac{1}{2}$ inch screen and retained on a $\frac{1}{4}$ inch, and 2 parts passing a $\frac{1}{4}$ inch screen and retained on a screen having 50 meshes per linear inch. It will be noticed that a top course so mixed will have both a strong mortar and sufficient large particles to provide against danger from holes appearing in the surface under traffic.

The satisfaction resulting from a two course pavement will depend upon the quality of sand and aggregate used, the care with which the wearing course is placed on the base, and the manner of finishing the street. The objections to it are the danger of loose top and the extra expense entailed both in placing and mixing the concrete as the base must be brought to grade before the top is placed and as the mortar must be handled over the base to the finishers.

Although the two course pavement has been the more popular in the past, this year has seen a larger yardage of the one course type laid. In this construction, the same mixture and aggregate are used throughout the whole thickness of the concrete. Sufficient mortar for finishing the surface is flushed to the top by

tamping. This will require the concrete to be mixed wetter than would be the case with the two course construction. The decision as to which of these types is best adapted to the road in question will depend upon the materials available and the relative cost. For instance, if a concrete road were to be constructed in the vicinity where the cost of good gravel, sand and stone is high, but where soft sand, gravel and stone were available for construction purposes, it might prove economical to ship in sufficient of the first class materials to place a two inch top on the five inch base built of the local materials. The writer does not wish to leave the impression that poor material should ever be allowed in a concrete road, yet a gravel may make good concrete and still have a few mud balls in it which would make it unfit for use in the top. There will be required for 100 square feet of a 7 inch two course pavement consisting of a 5 inch base mixed with 1 part cement, $2\frac{1}{2}$ parts sand and 5 parts stone, and a 2 inch top mixed in the proportion of 1 part cement to 2 parts screened gravel, 3.91 barrels of cement, 1.31 cubic yards sand and 1.42 cubic yards of stone. As against this there will be required for a single course pavement of the same thickness mixed in proportion of 1 part cement, $1\frac{1}{2}$ parts sand and 3 parts gravel, 4.13 barrels cement, .92 cubic yards sand, and 1.85 cubic yards of stone or gravel. It is evident that the latter mixture gives a road which is much stronger and in which there is no danger of separation at the weak plane between the top and the base. The saving in the cost of mixing and placing will more than compensate for the difference of .22 barrels of cement per 100 square feet, as the amount of aggregate is substantially the same for both constructions.

The fourth type of road, which consists of a concrete base with a thin covering of bitumen and sand, is having great popularity at present both for country road construction and for city streets. This construction was developed by Mr. E. W. Groves, City Engineer, of Ann Arbor, Michigan, who in 1907 and 1908 put a thin film of bituminous material over some worn out pavements. After two years wear the appearance was so excellent that he tried this covering on a new concrete base. On top of the concrete about $\frac{1}{2}$ gallon of tar per square yard was applied, and after being swept over the surface with a street sweeper, sand was sprinkled over the whole and traffic turned on to the pavement.

This type of road has had a great following among engineers, especially in the last two years. New York has let contracts for some 280 miles of this work, and Ohio will complete over 50 miles this year. In considering this type of pavement, it will be necessary to determine whether 12 or 14 cents per square yard can be better expended for bituminous protection or for better concrete, more careful preparation of the sub-grade, better workmanship and more expert supervision. Regardless of the material used in this top, it will be necessary to have a good concrete base. The same care must be taken in the selection of the aggregate as though no covering were to be used, for unless a maintenance system is maintained, it is impossible to expect this top to last longer than two years under average traffic, and if this is the case, the concrete must be of such a character that it will withstand the traffic until such time as the top can be renewed.

After deciding upon the type of concrete pavement, the field work of construction commences. The work may be done either by contract or under the direct supervision of the engineer in charge. In case a contractor is put upon the job he may do the work on a commission or for a contract bid. The character and experience of the contractor will determine which method will be the most advantageous.

Drainage is the first point to be considered in the laying out of the road construction. In a flat country, such as the prairies of Illinois, it will often be necessary in certain parts of the road to make artificial drainage. This may be accomplished by varying the depth of the side ditches or by placing tile. In all cases the elevation of high water for any considerable length of time should be at least a foot below the top of the sub-grade of the road in order that there will be no danger of sufficient water getting under the concrete to affect the foundation.

If the concrete is to be laid upon an old earth road which has been well graded by the maintenance force of the township or county, only sufficient grading will be necessary to bring the road to grade. It is not essential to make the road grade absolutely uniform from end to end as this often entails extra expense which might better be utilized in making either a better road or else in constructing more road.

The sub-grade should be thoroughly compacted with a roller weighing approximately 10 or 12 tons, the soft places excavated and refilled with some material which will give satisfactory re-

sults. Fills over 1½ feet high should be placed in layers not to exceed 1 foot in thickness and thoroughly compacted so that no waving appears before the roller. Sufficient culverts and pipes under the road to take care of the lateral drainage are necessary. In case of a steep grade, it may be found advisable to run concrete headers from the road into the embankment to prevent the washing of the grade. After the sub-grade has been prepared it is of the utmost importance that it be kept hard until the concrete is in place. Teams hauling material must be kept off of the finished sub-grade and it will be found advantageous when possible to have the materials dumped outside of the lines of the forms. Soft spots and irregularities will be prevented by rolling the grade within 24 hours of the time of placing the concrete. Wheelbarrows or men must not cut up the sub-grade as the work progresses.

The proportion of cement, sand and gravel or stone used will depend on the type of construction and the material available. With good sand and uniform hard gravel or stone, a one-course pavement mixed in the proportion of 1 part cement, 1½ parts sand and 3 parts stone, will prove the most satisfactory. If, when the construction is started it is found that this proportion does not give sufficient mortar to make satisfactory finishing possible, the proportion may be changed to a 1 : 1¾ : 3 or even a 1 : 2 : 3.

No bank run gravel must be used without being screened over ¼ inch screen and remixed in the above proportions. Reports from the road work carried on in the East show that the unsatisfactory bank run gravel which varies from 30% through a ¼ inch screen to 60% is responsible, to a large degree, for the unsatisfactory condition of some of the pavements. Too much care cannot be taken in keeping a check on the gravel and sand.

On the prepared sub-grade suitable forms must be placed and firmly held, both to line and to grade. The forms which are now being used on the U. S. Experimental Road near Washington, D. C., are very good. They consist of a 3 inch by 6 inch dressed plank with a ½ inch rabbet on the back. The ends are grooved vertically with ¾ inch by 1½ inch grooves. As the forms are set, a small wedge is driven into these grooves, thereby holding the forms solid. Braces may be tacked to the back of the forms, doing away with considerable toe-nailing, and with the trouble so often met of the braces hindering the use of the template.

Before placing the concrete, the sub-grade should be moistened. This is necessary to avoid danger of drawing water from the concrete. The wetting ought not to be sufficient to make the sub-grade soft or muddy. All concrete should be mixed in a batch mixer. It is important to obtain uniform mixing throughout the mass and with the continuous mixer the only way of knowing the amount of cement going into the work is to count the sacks and to measure the work placed during the day. This is unsatisfactory as the concrete is not of sufficiently uniform section to make such calculations accurate. There are on the market a large number of batch mixers specially designed for road work. These may be divided into three general classes, the first having a bucket which runs out on a boom and drops the concrete on the road; the second a swinging chute down which the concrete slides, and the third a revolving cylinder which serves both as a mixer and a chute. Each of these types has its advantages and perhaps its drawbacks. Care must be taken with any of them that the large stones do not separate from the remainder of the mass.

In depositing the concrete it is necessary to make sure that there is no separation of the particles and that the concrete is thoroughly mixed before being finally placed in the pavement. To the finishers and the men following the mixer must be left most of the responsibility for the ultimate satisfaction of the road. They must see that the large stones are raked to the bottom and the road given uniform surface.

After the concrete has been placed there are two general methods of striking off the surface. The first is to give a sawing motion and the second a tamping motion to the template which is cut to the crown of the road. The character of the aggregate used will, in a large degree, determine the method employed. The concrete may be finished either with a large float the width of the street and eight inches wide, which is handled from each end with a tamping motion, or else with a wooden float by men from a bridge. The second method is preferable as the finisher working over the concrete will see the small undulations and spots demanding attention and it is his duty to see that they are satisfactorily filled. Workmen must not go on to the concrete after it has been struck off, as it is impossible to fill even a small hole with material that will give the same appearance and wearing

qualities to the finished road as would have been the case if no hole had been made.

During the summer months and during the time where there is danger from frost, it is advisable to protect the concrete against the elements. The morning following the day in which it is placed, it should be covered with about 1½ inches of earth which is kept moist for a period of several days. Traffic should not be allowed on the concrete for at least a week after the surface is completed.

The life of a concrete road will depend as much upon the construction of the shoulders as upon any other one element with the exception of the construction of the concrete itself. These shoulders should be filled out for at least three or four feet on each side of the concrete and should be given a fall of four to six inches in this distance. Care must be taken to obtain good materials for the shoulders, as a poor, soft gravel or shale will soon wash away and water will get into the sub-grade, thereby undermining the road. If good gravel is available, it will make a satisfactory shoulder, but where gravel is expensive a good clay and loam, well rolled in place, will prove satisfactory.

The question of expansion of joints is one which has provoked much discussion among road engineers and contractors. It is a known fact that temperature changes result in expansion and contraction of concrete, but it is the opinion of men who made a study of this type of construction that it is unnecessary, and probably inadvisable, to use a wide expansion joint. Mr. Logan Waller Page, Director, Office of Public Roads, Department of Agriculture, is at present laying 4,000 feet of concrete pavement, 20 feet wide without joints. He expects to get considerable contraction and expansion and to get transverse cracks through the pavement. However, he does not believe that these cracks will be sufficiently objectionable to make the extra cost of putting in joints and protecting them, necessary. In the State of New York where the roads are all to be covered with bitumen, both methods of construction are being tried. It is the opinion expressed by a number of engineers that it is an unnecessary expense to place expansion joints on roads which are to be protected by bituminous covering.

The experience in Wayne County, Michigan, shows that the joints if unprotected have a tendency to break and chip, but where protected with a steel protection plate the life of the road

is lengthened indefinitely. This plate is about 3 inches wide by $\frac{1}{4}$ inch thick and is cut to the section of the road. Fins are punched out of the center of the plate and bent back to give it a good hold on the concrete. Three thicknesses of tar paper are used between the plates. The cost of these plates is in the neighborhood of 14 cents per linear foot of expansion joints, or five cents per square yard of pavement.

Experience shows that the contraction due to temperature changes must be localized by placing transverse joints across the street about 25 feet apart and that these joints should be protected. The extra cost is little compared with the added life of the pavement.

The average price for concrete pavement either with or without a bituminous wearing surface will range from \$1.00 to \$1.50 per square yard exclusive of grading and curb, depending upon the price of materials and distance of haul. It is evident from the experience with concrete both in country roads and city streets that it fulfills the requirement of a low cost permanent pavement.

"SOCIALIZING" THE ENGINEER

By ARTHUR J. TODD

It is becoming the fashion to "socialize" everything. We hear of socializing industry, religion, the public school, the medical profession, the lawyers. We are urged to socialize the land, to socialize the unearned increment. Political and economic reformers tell us if we would think in "social terms" all would go well. What do these phrases mean? Divested of what Professor Bliss Perry recently called "departmental jargon," they mean simply this: the humanizing of institutions, the utilizing of the community's natural and human resources for community welfare instead of private gain, the redemption of every institution, enterprise, profession, from aloofness or isolation. In plain English, I mean by socializing the engineering profession to make its chief conscious business the enabling of more people to live better.

The editor of *THE TECHNOGRAPH* tried a while ago to convince me that the great end of engineering was to permit *more* people to live. But I cannot subscribe to any such theosophical idea. Few of us know or care whether more people ought to be born into this world or not. But most of us ordinary, unmythical, tax-paying citizens and lovers of fellow men know that *more of our people ought to live better*. We know that some ten millions of our fellow Americans are in poverty. We know that we spend over a hundred millions annually in public charity, to say nothing of perhaps an equal sum flowing through private channels, and of losses through preventable accident and sickness running into the billions. The problem of the engineer is to conserve and improve what human beings and natural resources we already have.

Now, engineering means far more than carrying a transit or designing a steam shovel, constructing a new type of reinforced concrete roof or discovering a new explosive. Morison tells us that nearly ninety years ago Tredgold defined civil engineering as the art of directing the great sources of power in nature for the use and convenience of man. Morison himself insists that the business of the civil engineer is "to design the tools by which the sources of power in nature are directed for the use of man."

But what uses, and for what man? Precisely because men had overlooked these pertinent questions John Stuart Mill uttered his famous doleful comment on the failure of machinery: "Hitherto it is questionable if all the mechanical inventions have

made lighter the day's toil of any human being. They have enabled a greater population to live the same life of drudgery and imprisonment, and an increased number of manufacturers and others to make fortunes. . . . But they have not yet begun to effect those great changes in human destiny which it is in their nature and in their futurity to accomplish." And after sixty years the cry is repeated by an English economist, who proclaimed recently: "Vain have been the strivings of the most gifted of men. The machines they have constructed have but created a new race of machine-slaves, and made it possible for an increasing proportion of civilized men to live by useless work, while liberating entirely from work, useful or useless, a limited leisure class which alone enjoys the fruits of the earth as multiplied and harvested by machinery. . . . Must it be said of civilized man that he can analyze the light of Sirius but cannot shelter all his children?—that he can achieve scientific miracles but is baffled by the commonplace?"

We are assured that not only is machinery not necessarily progressive, but that it may actually condemn to utter ruin and degradation thousands of families. Only dulness of general perception and capitalistic inertia or conservatism hold back the development of labor-saving devices which might turn our whole industrial system topsy-turvy. A professor of physics announced recently that physics and chemistry might soon be expected to produce nitrogen compounds that would put agriculture out of business and consign us all to cities. Engineering may have similar resources up its sleeve.

Only the social spirit and intelligence warmed with humanity can determine whether a given invention or art of saving shall result in bane or blessing. We withhold matches and scissors from babes. Perhaps a social view of his profession may prompt the engineer to refuse to launch on its career a new machine which, however curious and interesting in itself, might curse rather than bless his fellows. The Connecticut Yank with his wooden nutmeg machine was a clever engineer, perhaps, but a poor sort of citizen. Machine making for machinery's sake is just as foolish and unproductive as the silly cry of art for art's sake. All the arts and all the sciences are human instruments for human purposes, and are to be judged solely by the sum of positive good they produce in terms of human welfare.

The same principle applies equally to systems of "scientific management"—to "efficiency engineering." The efficiency expert who fails to take account of *all* the factors concerned in his scheme—laborers, managers, capitalists—may construct a very pretty but also very inhuman, very dangerous, and in the long run very uneconomical machine. It may be efficient to scrap old machinery or work it at higher tension; but to scrap workers at forty is suicidal. Indeed, we cannot scrap men. If we strain and disable them they remain a body of death chained to us. Let the engineer follow the advice of the new Secretary of Commerce, Mr. Redfield, himself a successful manufacturer: "We must be intolerant of inefficient labor by teaching it and by paying it sufficient to stimulate it into efficiency; but this must not be done as a driver would drive slaves, but as a leader would lead men."

This will mean reducing the discrepancy between the values created by labor and the expenditures for care and conservation of the "human machine." It was estimated recently from federal census figures that the average wealth created by each wage-earner in the United States (exclusive of the material he uses, supervision of his work, and his own wages) is \$630 annually. In return for this, society doles out an average of 8.1 cents per year on each factory wage-earner for prevention of accidents, sanitation, preventing illegal employment of children, providing for out-of-works, studying occupational diseases, etc. These are social problems primarily for the engineer.

Suppose, further, we ask why the steel workers, who under Mr. Taylor's scientific management are now able to handle 48 tons of pig iron per day instead of 12 tons under the old system, should receive an increase of only 65 per cent in wages for an increase of 300 per cent in productive efficiency? Does 65 per cent represent the real increment of labor efficiency after making all reasonable deductions for additions to plant, tolls to management experts, etc.? I shall anticipate any objection by saying that the answer to such questions must come from the engineer rather than from the economist, the accountant or the social reformer.

Perhaps the modern city is the greatest engineering problem of today and tomorrow. It is the most dramatic episode in the social and industrial life of the last hundred and fifty years. But too frequently it is a combination of bad engineering and no engi-

neering at all. Whatever of pride and satisfaction we derive from the better types of modern cities is due largely to the engineer who plied his profession with vision and socialized imagination. It is true, and becoming truer, that in urban communities the duties of government have far more to do with good engineering than with good law. In the city's campaign for health we begin to look to the engineer rather than to the doctor. For it is his wonderful opportunity to decide whether we shall have a city—a mere throwing together of hovels and factories—or a City Healthful, a City Sane, a City Beautiful. Streets, parks, playgrounds, sewers, garbage plants, docks, subways, lighting and heating systems, and a myriad of other public and private enterprises rest on his shoulders. If he accepts in the right spirit this responsibility of creation he can banish the Cave forever from our midst, and, I suspect, will by the same strokes raise us from the status of Cave Dwellers to that of citizens of a real City.

Such demands as these cannot be met by engineering conceived merely as a *trade*. They are problems worthy only of a high, dignified and learned profession. What, by the way, distinguishes such a liberal profession from a trade or craft? Aristotle declared that that was the most illiberal occupation "in which there is the least need of excellence." A trade is based on rules and is followed for a livelihood. A profession is based on principles, a deeper knowledge of contributory sciences, and a code of conduct for its members. Such a code aims at professional spirit, mutual co-operation and welfare of clients. In two words, one lives *by* a trade and *for* a profession.

No lawyer, doctor or minister can hope in the near future to stand for anything in his profession unless he is trained liberally in fields outside his special line of work. Engineering must follow suit and include in its program a thorough grasp of economic and sociological principles. If not a full course in the social sciences, let the engineer have at least enough to realize his own deficiencies and to incline him not to obstruct the vision and work of legitimate social reform.

The engineer must of course specialize in engineering. That goes without saying. But he must learn to think liberally outside his specialty. Bernard Shaw declares, "No man can be a pure specialist without being in the strict sense an idiot." Engineering students feel this danger of the "specialist's cramp." One of

them said to me a while ago, "The longer I work in my subject the less educated I feel." The reason was that he had lost the social bearings of his subject. Probably he was defining it in terms of mathematics instead of men. Someone characterized the late George Meredith as not a great writer, but a great man who wrote books. Why should we not adapt the remark and apply it to the engineer?

The professional spirit in engineering demands, I said, a code of ethics; it demands in addition such a conception of life values as will lead members of the profession naturally to devote themselves to the best interests of the community. In other words, they must add enthusiasm and love to knowledge. "Learning is a treasure and a trade can never be lost," said the Roman self-made millionaire, Trimalchio. But not so with a profession. It is a creation of the spirit and with the loss of its spirit degrades into vulgar craftsmanship.

"Knowledge is power? Above
All else, knowledge is love."

A senior engineer a year ago as he came out of his last class exclaimed, "Now I am educated! Now for the money!" What proof did he offer that he is educated? An ideal of money success? Well, with professional men as with nations nothing fails like success—money success. Trimalchio dictated his epitaph thus: "C. Pompeius Trimalchio Maecenatianus was pious, stout and trusty, he rose from nothing, left HS 30,000,000 and never heard a philosopher." But his success brought him only an unenviable rôle as the vulgar boaster in a biting satire.

No profession can go on the principle of *après nous le déluge* and survive. Still less can the engineer chase money and maintain professional standards. We shall not reckon what he is worth by his mere financial reckoning in Dun or Bradstreet. Besides, as Professor Peabody urges, the new test of the rich man is not What is he worth, but How much is he really worth? Is he worth having? Is he worth what he costs?

Engineers like other men must "compete for business." Yet if they are to remain members of a noble profession they must carry their struggle for existence up to that level where it becomes competition between the *good* and the *best* service to fellow men. Aristides said over two thousand years ago, "It is for

us to struggle both now and ever, which of us shall perform the greatest services to our country."

It should be superfluous to add that the good engineer must be honest, not merely honest in paying taxes and gas bills, but honest in his plans and contracts. The profession that engages in the manufacture of power or the exploitation of its natural sources can neither subscribe to nor hide behind questionable practices, however much current trade customs may condone or wink at them. The engineer must not sanction shoddy materials, dangerous construction, questionable or unwholesome processes. It may be true that the average workman "is so used to working upon rubbish that he fails to perceive the irony of it"; but the engineer cannot so fail if he is to rise above the status of mere artisan.

The report of the Colorado Bureau of Labor Statistics for 1909-10 baldly accuses the Colorado Fuel and Iron Company of seeking to nullify and violate laws calculated to protect the interest of the miner and of using its powerful interest to defeat the enactment of any law having for its purpose the safeguarding of the lives and health of its employes. Here again the problem is not of politics but of engineering. For if mining engineers resolutely refused to sanction rotten or insufficient timbering, imperfect ventilating arrangements, etc., there would be no need of appeals to "decent politics," legislative enquiries, "muck-raking," or damage suits.

Sanitation is another problem for the mining engineer, and he must instruct his unwise employers. The president of a great steel and iron corporation of Alabama protested wildly against the report on Birmingham conditions published in "The Survey" a year ago. "Why," he demanded, "who is there in his right senses will deny that hogs are the natural and logical scavengers of a mining camp? Sanitary conditions in a mining camp? Pooh! I'd rather have twelve hogs than fifty men cleaning up my camps!" But a scornful Pooh! insures neither health nor decency, and cannot relieve the engineer from enforcing the demands of his own professional conscience.

The point is this: are engineers to lead or be led by corrupt Big Business? The more they gain and the more they hold the professional spirit the more they will lead Big Business, the less they will connive at its chicanery.

In September, 1911, a break in the dam of the Bayless Pulp and Paper Company wiped out the town of Austin, Pennsylvania. Local sycophants attempted to whitewash the whole affair by pointing out the moral virtues of the Bayless brothers and their wives. But the "Engineering News" refused to be bluffed by such pious frauds and issued the following vigorous protest: "It is our duty to say that the occurrence is without excuse; and that if the dam had been built with proper precautions and proper regard for safety the failure would never have occurred. . . . It was bad to build the dam on such a foundation, with no greater precautions to prevent water getting under it; but it was ten times worse to use the structure in its weakened and perilous condition after the partial failure of 1910."

This editorial sounded the note of Safety First which is now echoed on every side. But to make it more than a mere motto means work, *professional work*. Last year a notable railway engineer lecturing to a class of students is reported to have told them that their first duty would be to earn dividends for their directors; their second to provide a comfortable service; their third to develop a safe service. An astounding exhibition of Cave-Dweller morality and business! Fortunately railroad fashions are changing. The Big Four now has a Safety Department; and other roads are preaching and beginning to live the same gospel. The engineer can preach here better than the moralist. And he should not wait for governmental compulsion, but should lead the way, *by virtue of his profession*.

The engineer can exemplify the principle of service instead of exploitation not only in his professional life, but also, so to speak, in his amateur life. How shall he use his margins of time? There are many things he can do. He can co-operate with the various agencies for social welfare—charities, preventive medicine, recreation. He can serve as an expert adviser, as a beautifier. "It is my pleasure," said a German architect with a wave of the hand towards the municipal dwellings he had created.

But can these things be done? Is it not pure sentimentality to talk of service instead of exploitation? Is it not against human nature? No. They can be done. It is not against human nature. Certain native impulses only need strengthening and training. Read the testimonials of college-trained engineers in an article on "Industrial Service Movement of the Y. M. C. A." in the April

19 issue of the *Survey*. Listen to this: "My class of Italians is the finest bunch of men I've ever come into contact with—bright, keen, appreciative to an embarrassing extent. They have done me more good than I can ever do them." Or this: "Before I undertook any of this work, my one ideal in life was to make all the money I could, regardless of anyone under me. Since I gave some of my time to volunteer service my ideals have all changed. Now I don't care where I go or what my salary, so long as it is some place where I can help my fellow men." Read these and be a pessimist on human nature, if you can.

It is the University's business to see that means for inculcating this spirit of service are developed. That is what the whole modern demand for "social education" means. Senator La Follette looks back with real hero-worship to the college professor who taught him to make a return of service to the State for the superior education it had given him. This should be the burden of every instructor's message. This is the real meaning of ILLINOIS LOYALTY.

THE NEW COURSE IN ENGINEERING

By G. A. GOODENOUGH

In March, 1911, the faculty of the College of Engineering authorized the appointment of a committee to consider and report upon a revision of the several courses of study offered by the College of Engineering. The following extracts from the letter of instruction to the committee indicate in some degree the character of the work undertaken:

1. "The committee is expected to make a general study along broadly scientific lines of the several courses now offered by the College of Engineering."

2. "As a preliminary to the selection of specific subjects, the four years' work of each course is to be represented graphically to show the time given to each of the several general lines, somewhat as follows:

(a) *Language and General Cultural Subjects.*

(b) *Mathematics*, including all Technical subjects strongly mathematical in character.

(c) *General and Technical Laboratory.* To include all subjects that do not involve extensive preparation in class.

(d) *General.* To include technical courses largely informational in character.

3. "The plottings of all courses excepting that of Architecture should be similar, possibly identical."

4. "The present strength of the courses in fundamentals should be undiminished. To provide for the range in applied and descriptive work which is now allowed, and perhaps for a greater range, electives should be introduced."

5. "In the assignment of subjects, the continuity of effort along given lines should be observed."

The committee started its work with an investigation of the present courses of the Engineering College and similar courses in a number of the leading technical schools. The various subjects were assigned as carefully as possible to appropriate groups; thus, group A including language and general cultural subjects; group B, mathematical subjects, etc.; and the results were plotted. It was expected that some general law would be disclosed, that all courses in this college and similar courses in other institutions would show somewhat similar characteristics. On the contrary,

the greatest diversity was found and the plotted courses showed the most erratic behavior.

The statistical method bringing no effective result, the committee proceeded to formulate a set of general principles that might serve as a guide in laying out the courses. Briefly stated, the principles proposed to the faculty and approved were the following:

1. The undergraduate courses should be educational in a broad sense rather than specialized along narrow lines. Hence the course should in each of the eight semesters include general cultural subjects.

2. The "B" subjects (i. e., the pure and applied mathematics) form a distinguishing feature of the course in Engineering. A liberal and approximately constant amount of time should be given to this group.

3. The subjects in the "C" group (laboratory, shop, drawing, etc.) tend to develop dexterity in manipulation rather than ability to think, though there is a wide difference between different subjects in this respect. The amount of work in this group may well be practically constant throughout the four years; but there should be a gradual transition from the mere manipulation in G. E. D. 1 in the freshman year to the kind of laboratory course in the senior year that is distinctly valuable in reinforcing the accompanying theoretical course.

According to these principles the ideal engineering course should show a curve for "A" subjects nearly horizontal, a "B" curve nearly horizontal, if anything rising as the course progresses, and a "C" curve also nearly horizontal.

Proceeding along the lines indicated, the committee has worked out the new courses, as they now appear. Arrangements are being made for putting the courses into effect as soon as possible.

In all courses (except in Architecture) the freshman year is the same. It is as follows:

First Semester	Second Semester
Mathematics 5 hrs.	Mathematics 5 hrs.
G. E. D. 1..... 4 hrs.	G. E. D. 2..... 4 hrs.
Rhet. 1..... 3 hrs.	Rhet. 1..... 3 hrs.
Chemistry 4 hrs.	Chemistry 4 hrs.
Mil. & P. T..... 2 hrs.	Mil. & P. T..... 3 hrs.
—	—
18	19

The work in the sophomore year includes the following subjects, common to all courses:

First Semester		Second Semester	
Math. 7.....	5 hrs.	Math. 9.....	3 hrs.
Phys. 1.....	3 hrs.	Phys. 1.....	2 hrs.
Phys. 3.....	2 hrs.	Phys. 3.....	2 hrs.
Language	4 hrs.	Language	4 hrs.
Mil.	1 hr.	T. & A. M. 7.....	3 hrs.
—	3 hrs.	Mil.	1 hr.
	—	—	3 hrs.
	18		—
			18

The spaces left blank are filled by Surveying in the C. E., Ry. C. E., and M. & S. E. courses; by M. E. 41 (shop) in the E. E., Ry. E. E., M. E. and Ry. M. E. courses; by Geology and an elementary course in mining in the course in mining engineering. Thus, with the exception of one course, the freshman and sophomore years are identical for all courses.

The courses in third and fourth years naturally diverge considerably, but they have two features in common: 1. The present strength of the work in T. & A. M. is maintained. 2. In each course provision is made for at least nine hours of non-technical electives. As space does not permit the details of all courses, the third and fourth years of the course in mechanical engineering are presented:

JUNIOR YEAR.

First Semester		Second Semester	
T. & A. M. 8.....	2½	M. E. 7.....	5
T. & A. M. 9.....	3½	M. E. 8.....	5
M. E. 16.....	4	M. E. 3.....	3
M. E. 42.....	3	M. E. 42.....	2
Math. 9a.....	2	Non-Tech. Elective.....	3
Non-Tech. Elective.....	3		—
	—		18
	18		

SENIOR YEAR.

First Semester		Second Semester	
M. E. 9.....	4	Power Transmission.....	3
M. E. 12.....	3	E. E. 6 and 29.....	4
E. E. 16.....	4	M. E. 9 (4) or M. E. 14 (3)	4 or 3
M. E. 6 or Shop Management	3	*Electives, Technical and Non-Technical	—
Non-Tech. Elective.....	3		—
	—		17
	17		17

*Elect 4 or 5 hours from following list:

Arch. 13.....	(3)	C. E. 10.....	(2)
M. E. 27.....	(2)	Ry. E. 11.....	(2)
Thesis	(3)	Steam Turbines.....	(2)

The present courses, M. E. 5 (Kinematics) and T. & A. M. 11 (Kinematics of Machinery), are merged into a single 5-hour course, M. E. 8. Steam engineering (M. E. 16) is moved to first semester and given 4 hours. Thermodynamics (M. E. 7) is increased from 3 to 5 hours and will include the first semester's work in M. E. 6.

In the senior year it is assumed that the students will choose between two well-defined lines of work: (1) machine design, (2) power engineering. Those in the first group will take 8 hours of design (M. E. 9) and shop management; those in the second group will take gas engineering (M. E. 6) in first semester, M. E. 14, M. E. 27, and steam turbines in second semester.

In all courses a thesis is no longer a requirement, but may be elected by students of ability with the approval of the head of the department.

A comparison of the old and new M. E. courses shows that, notwithstanding the nine hours given to non-technical electives, the strength of the course in purely technical lines has not been impaired. On the contrary, by the merging of one and two-hour courses into strong and effective four and five-hour courses, the strength of the technical instruction has been increased. The same statement may be made of the other departments in the College of Engineering.

The most important changes involved by the new courses may be summarized as follows:

1. The shifting of chemistry from the junior to the freshman year.
2. The interchange of language and rhetoric. In the new courses rhetoric will be a subject in the freshman year.
3. The shifting of the shop work from freshman and sophomore years to sophomore and junior years. In view of the altered character of shop instruction, this change should be specially effective.
4. The abolition of thesis as a requirement for graduation.
5. The requirement of at least nine hours of non-technical electives in the junior and senior years.

THE APPRENTICESHIP SYSTEM FOR TECHNICAL GRADUATES

IN MECHANICAL ENGINEERING

GEORGE MEYER, Jr., '14

Within the past few years many of the large manufacturing concerns have adopted the policy of training and educating young men in the art of manufacturing their products, through the method of a Special Apprenticeship Department. The prime motive which has prompted these concerns to organize such departments is the desire to meet the constant demand for experienced men possessing a thorough knowledge of their products and the various processes of manufacture.

In organizations such as the American Steel Foundries Company, the Allis-Chalmers Company, the Fairbanks-Morse Company, and many others, operating widely distributed plants and employing at times thousands of men who are engaged in production which involves the exercise of good judgment and initiative, there are frequent changes in the personnel of the staff. These changes often result in creating new positions which are filled by men taken from the ranks of the apprentices.

The course of instruction given by the American Steel Foundries Company of Pennsylvania is outlined in the following synopsis. The apprentice on entering the service of the company is given a general talk by the manager of apprentices pertaining to the work in which he is to engage. In addition to this he receives a letter of instructions for his guidance which contains suggestions as to the difficulties he will encounter, mistakes that should be avoided, and some of the details he should study. This gives him some definite ideas of what he is to do and what is expected of him.

A course of instruction along this line is of undoubted value to a college man, not only to teach him the details of the business but to acquaint him with actual working men and conditions. A special apprentice having a technical training, later supplemented by practical shop experience, possesses a distinct advantage over those not so well equipped. Whatever prejudice of shop men there may be against the college graduate is soon overcome if he does not shirk his work and attends to his own duties.

The course offered by the above mentioned company may be briefly outlined as follows:

- Inspection—Three to four months.
- Product designing—Two months.
- Pattern shop—Two months.
- Molding and core-making—Eight months.
- Laboratory—Eight months.
- Open hearth—Six to seven months.
- Gas producer—One month.
- Plant engineering—Five months.
- Cost department—Three to four months.
- Order department—Two months.

This makes a total of three years. The time spent in the various departments varies slightly, depending upon the adaptability of the apprentice and also upon the plant at which he is located.

In all of this work the apprentice is required to study each department with regard to its relation to the others. He is required to take notes while employed in each department, so that he will be able to write an outline of the information he has acquired. He is under the general supervision of the works manager and under the special supervision of the foreman in whose department he is engaged, who sees that he (the apprentice) is fully instructed in the work of that department. The apprentice must hand in his report to the foreman in charge, who in turn reports to the works manager concerning the work of the former. In addition to the above report the apprentice is also required to submit at stated periods a written outline on outside reading, the subjects to be read being of such nature as will aid him in his daily shop work. For this purpose the company maintains a reference library at each plant, supplied with literature of technical nature, together with current magazines.

From time to time the apprentice is rated or graded, in order that his relative efficiency may be determined. The following is the schedule adopted by the American Steel Foundries Company:

Item	Points
1. Punctuality	10
2. Personality	10
3. Executive Ability	25
4. Mechanical Ability	25

5. Written Report—	
(a) Observation	10
(b) Sequence	5
(c) Originality	5
(d) Detail	10

 100

The term "Punctuality" means not only punctuality in attendance, but also punctuality in getting out the work and in submitting his written reports. When the apprentice has prepared and submitted a satisfactory report, he is placed in the next succeeding department. A copy of the apprentice's efficiency record, maintained at the main office, is furnished him every month, thus informing him of his weak points so that he may build them up.

A certain portion of the apprentice's time, usually during the latter part of the period in each department, is given over to creating and developing his executive ability. This is accomplished by assigning him to positions as gang boss. In addition to this he is also assigned to small jobs of outside inspection, thus affording him an opportunity of visiting other plants to learn different methods.

From the records kept at the main office the company selects names of apprentices arranged according to their respective abilities. When a vacancy occurs, or a position is created, the apprentice best equipped to fill the vacancy, as shown by the records, receives the appointment. Thus it is evident that the apprentice's standing and advancement depends entirely upon his own merit and exertion.

IN ELECTRICAL INDUSTRIES

H. R. TEAR, '14

Practically all of the large electrical manufacturing companies conduct training courses for technical graduates. The object of these courses is primarily to give college men a training that will fit them for responsible positions with the concern giving the course, thus serving the two-fold purpose of supplying the company with specially trained employes and preparing the college graduate for commercial work. I will not attempt to discuss here the relative merits of these courses, or of the principle which they represent, but shall merely try to give a description of the courses given by some of the most widely known concerns.

One of the most highly developed and perfected of these train-

ing courses is that offered by the Westinghouse Electric and Manufacturing Co. This company does not aim to train men for employment in the company only, but makes it a point to see that some of the graduates of the course get positions with other electrical concerns, especially in the operating end of the business. The men are thus put in positions where they can influence the purchasers of electrical apparatus, and they are almost certain to specify Westinghouse apparatus because of their familiarity with it, with consequent advantage to the company.

The training course first offered by this company was rather a haphazard affair, where the students were sometimes lost track of and were not held strictly to the course. But as now modified, the course requires that the student be held to a very definite program. The course is from eighteen months to two years in length, the first year being of a general nature and the remainder being specialized, preparing the student for the particular line of work for which he shows preference. For the first six months the students are employed in the various manufacturing departments of the company. Each man is given six weeks in any one department, so that he gets experience in four different shop sections, and consequently in four very different lines of work. The shop schedule is so arranged that the student will obtain experience in lines of work as diverse as possible. A representative schedule of one of these courses gives the student six weeks in winding transformers, six weeks in winding motors, six weeks in machine assembly, and six weeks in switchboard assembly, thus making up the first six months of the course. At the end of this time the student is sent to the testing-floor, where another six months are spent. During all this time the student must attend a three-hour recitation period each week, where he is quizzed on the particular line of work in which he is engaged at the time. In addition, throughout this period an accurate record of the student's conduct, etc., is kept. Each foreman or department head under whom the student works, grades him on his work and also on his personal characteristics, such as originality, adaptability, industry, etc., and a record of these grades is kept. This record is of great assistance to the educational department in determining just what sort of work the student is best suited for, the positions being selected largely on this basis.

At the end of a year the student is supposed to have reached

some definite conclusion as to which department of the company he prefers, and he is put into that department in which he desires to specialize for another term of about a year. The company does not rigidly enforce a stay of a whole year more on the course, but strongly advises the students to do so. When a man is ready to go into the actual employ of the company, he is taken off the course and given a regular job, or if he prefers, the company may locate him with some other concern. During the first eight months the student is paid \$46 per month, during the second eight months \$51 per month, and for the rest of the time he is on the course is paid \$56 per month. As soon as a student is taken off the course and given a regular position with the company he is paid more, his salary being governed by the man's ability, his value to the company and other factors. The important things to notice about this course are that the student is under the direct supervision of the educational department at all times, that the course is rigidly adhered to, so that no department head can step in and take a desirable man off the course to put in his own department, to the detriment of the student, and that a man is free to take his choice in his position—nothing is forced upon him.

The General Electric Co. is another concern that conducts a representative training course. The course offered by this concern consists of nine months in the factory and testing departments, and three months in the particular department for which the student desires to fit himself. The first five or six months are spent in the various shop departments, where the student learns how the different machines, etc., are made and assembled, and also learns much about factory methods. Working right alongside the regular workmen gives him an opportunity to learn a great deal about the handling of men, labor conditions, etc. Besides the regular factory work, the student is required to go to recitations weekly, where the theoretical phase of the work he is doing is taken up, and he is given the opportunity of consulting the engineers of the company, who are big men in their field. The experience gained on the testing-floor is of great value, no matter what department of the work a man expects to take up. The wages paid the students are \$11 per week at the start and \$14 per week during the latter part of the course. After the student is given a regular position with the company his wages will depend upon circumstances, there being no fixed schedule. Many

of those who finish the course are given positions with other concerns who apply to the General Electric Co. for competent men, so that taking the course does not imply that a man must necessarily stay with the company. Further details concerning the course offered by this company were not obtainable, as some of the features have recently been changed and full information about the new changes had not been made public at the time of writing. In addition to the regular course, which lasts about a year, a special training course for engineers is offered. This course extends over nine months, and requires for admission a minimum of twelve months' experience in the testing department. The work consists principally in assisting the consulting engineers, and prepares one for the consulting engineering department. In general, the course offered by this company is similar to that offered by the Westinghouse company.

Another large corporation offering a training course for technical graduates is the Western Electric Co. This company is in reality the manufacturing department of the Bell telephone companies, and its sole business is the manufacture of the electrical apparatus used by them. It offers a course about a year in length, during which time the student works at the regular factory hours, and is given work in nearly every department of the company. The course is so arranged that the student gets practical experience in practically all branches of the work. The pay is \$65 per month. There are three courses offered: the commercial, the manufacturing, and the engineering, each course preparing the student for one of the three general divisions of the company. The student must decide which course he desires to take beforehand, as no general course is offered. This concern prefers to take only those who desire to continue in their employ, and does not undertake to train any who expect to work with some other concern.

Among the other concerns that conduct training courses may be mentioned the Cutler-Hammer Manufacturing Co., whose specialty is the manufacture of motor control apparatus. The course offered by this company consists of from two to six months in the testing-room, three to six months in shop work in the various manufacturing departments, and additional work in the designing department. The course, strictly as a course, leads only this far—that is, to the design of apparatus. From this

point, further progress depends entirely upon the individual. The salary paid during the first six months is \$60 per month, during the second six months \$75 per month, and at the end of a year \$90 per month. After that, the future salary depends upon the man.

As to the value of these courses to the average technical graduate, about all that can be said is that it depends largely upon the individual. There is no doubt that for some men the best thing they could do would be to take such a course, especially if they have not had any previous experience in electrical work. And there are others to whom the time spent on a training course would be practically wasted, and who would probably make a great mistake to take it. No one can deny that the experience gained in these courses is very valuable, and it is really a question of whether one can afford to spend the time required or not, which must be decided by the individual.

IN RAILWAY SERVICE

E. G. YOUNG, '13

In the service of the railways of this country are to be found widely varying types of arrangements for the training of men for official positions in the engineering and other departments. As the courses vary in type, so they vary equally in their attractiveness to the man for whom they are intended—usually the technical graduate. The designation "Special Apprentice" has come to have reference to anyone, who while strictly in the apprentice class, is not entirely governed by those rules which cover the journeyman or artisan apprentice; men under this classification are given special opportunities to become familiar with more than a single phase of the work. As the majority of roads having the special courses specify that only technically educated men are eligible, the purpose becomes virtually to give further training which shall teach the "how" of processes, of which the "why" has already been learned; to build a structure of practical knowledge on the theoretical foundation.

There are probably two dozen of the major roads and systems which have some sort of an organized and formulated plan for handling special apprentices, and as many more which take them into the service under certain circumstances, largely with the idea that a good man will make his own opportunities—a theory that

works out very poorly in a railway shop. The extremes of organization are represented by the high development of the elaborate course long administered by the Harriman lines, and by the mere placing of the man by the side of the regular artisan apprentices with a year or more of time allowance for his preparation, as practiced by the majority of the roads. From the point of view of the officials of the road, the former method has lost its popularity, as it has not produced the results desired in spite of its attractiveness and the care with which it has been administered. From the standpoint of the college man, the latter course is even more objectionable. Assuming that he has had the good sense not to expect "a nice, clean, aisy job" when he entered railway work, there are three grave faults in the system: he is in general put into work for which he is not well fitted, since it is not the purpose of the technical school to turn out machinists or pattern makers; he is at work which will give him little or no incentive to keep up his study and to keep his store of theoretical knowledge useful; and gravest of all is the resentment which the other apprentices are bound to feel (and with very much right) toward this man who is to them an interloper, with an unfair advantage over them. Somewhere between these two extremes of method which have been worked out in the past there must be a mean: a mean which, given the kind of man that is not afraid of work (and hard, dirty work, at that) and who has the determination to "stick," will prove to be the recruiting station for capable men which these employers need.

Though not pioneers in this work, the highest development of the special apprenticeship system has come on the Harriman Lines. For many years the Union Pacific maintained a course open to a few technical graduates each year (though others were occasionally admitted) which gave three years of training, embracing work in nearly every department of operation and maintenance. The apprentice began work on the track, and worked from three to six months in turn, at each of the following: firing, braking, section gang work, bridge and building gang, extra gang timekeeper or assistant foreman, and finally as foreman in one of these departments. At each job he received the regular pay which others in the same position were given, and at the end of the three-year period was appointed to division work: a foremanship, or a Trainmaster or Assistant to the Superintendent.

At the present time this course has been virtually abandoned, with the reason given that men thus appointed and trained have failed to make good.

Some of the other roads which have Special Apprenticeship arrangements are: The Chicago and Northwestern, The Great Northern, The Rock Island Lines, The Santa Fe System, Louisville and Nashville, The Pennsylvania, The New York Central Lines, The Baltimore and Ohio, and The St. Louis and San Francisco. This list makes no pretense of completeness, but among the roads listed are found practically all of the types of courses which are offered.

The Chicago and Northwestern course is open to graduates of technical schools, with the stipulation that they must have entered the school prior to the age of twenty-one. The length of the course is three years, and the work done is largely in the machine shop and on the erecting floor, with the latter part of the period spent in test work of various kinds. The pay at the start is seventeen cents per hour, with a semi-annual increase of two cents per hour, making twenty-seven cents during the last six months of the course. There are at present vacancies, for which men are desired.

The Louisville and Nashville has no set rules for the employing and training of special apprentices, but have at various times taken in men under special agreements, designed to give them a more general knowledge of the mechanical work that is obtained by the artisan apprentice. The results in the case of this road have been unsatisfactory, and there are no such positions open at the present time.

The Pennsylvania has a special apprenticeship course of four years length, embracing work in each of the shop departments; also a Signal Department apprenticeship. Men who are graduates of technical schools of recognized standing, are eligible, with the specification that they must be under the age of twenty-five at the time of appointment. There are, however, no vacancies at present. The wage at the beginning of the course is eighteen cents per hour.

The practice of the New York Central is to appoint no special apprentices, as such, but to make a time allowance on the regular apprenticeship courses to those who have had experience which

warrants this. The time allowance may be as much as two years on the four years' course.

The Baltimore and Ohio offers a course to which college graduates who can pass the regular physical examinations are eligible, in which the apprentice works for three years through the various stages of mechanical processes, both in the shop and on the road. The rate of pay at the start is seventeen cents, and there are several vacancies to be filled at the present time.

The course offered by the Rock Island Lines is of a more technical nature than most of the foregoing. Recommended graduates are eligible, and a strong preference is given to those who have done previous railway work, and who have been out of school at least a year. The apprentice goes onto the "personal staff" of the Master Mechanic or shop foreman, as his assistant and gains incidental experience in shop, erecting-floor and drafting-room operations.

To be grouped with railway apprenticeships rather than those of industrial plants is the course which is offered by the American Locomotive Company. In a sense, this is not a "course," for there is not a prescribed line of work, but the technical graduate is given every opportunity to work, in turn, in the different departments and in the different works of the company, of which there are six in operation. The pay at the start, for men in the shop, is twenty cents an hour, and in the drafting-room, thirty. In the words of Mr. L. L. Park, who was here a short time ago in the interest of the company, "Promotions are hunting for the men that are worthy of them, and our 'specials' are not forgotten."

The Santa Fe's course is open to men who are graduates of technical schools of recognized standing, and consists almost entirely of practical work in the shop and on the erecting-floor with the journeymen-apprentices. The pay increases from fifteen to twenty-seven cents per hour in the three years of the course. Of this course, Mr. F. W. Thomas, Supervisor of Apprentices, says:

"I would like to say that we have been experimenting with special apprentices for the past ten years, and the results have been anything but satisfactory. We used to give them some work in the shops, and a great deal of special work in the Test Department, and with the Mechanical Engineer, both in the laboratory and on the road. Our prime object in getting special apprentices

is to get good material for the making of our mechanical officials. We soon found out that the special work that we had been giving them did not fit them for the positions—the university or technical school having given them all of the special and technical work that they would ever need. Their real need is practical work to get acquainted with the customs and practices of the road, the equipment and shop methods.”

It is plain, from the attitude of the majority of railroads, that the special apprenticeship system is not looked upon with favor, the general claim being that it has been a failure, due apparently to the quality of the men which have been secured. On any such question there are a multitude of arguments on both sides; that of the employer and that of the graduate seeking the further training. There are two plain points in the technical man's case, or against the usual apprenticeship system. To make advancement in railway service it is necessary to know the “how” of the processes as well as the “why,” which has been learned in the technical school; therefore, a degree of manual skill and familiarity with shop methods and practices (on which the school work has little more than touched) must be obtained. But it is manifestly unfair to place the graduate by the side of the artisan apprentice, who has had a year or two of shop experience, and then draw the conclusion that the college man is incompetent, because he can not produce an equal amount of work. The second point is this: seventeen cents an hour is not tempting to the majority of graduates, and it is extremely doubtful whether the railways will get a class of men at this rate which will be generally satisfactory.

In fairness, hear Mr. Thomas, as he states the case of the employer:

“Our chief difficulty in handling special apprentices has been that they will not stick to work. They all want to be Master Mechanic or Engineer of Tests, or Superintendent of Motive Power about six weeks after they are graduated from college. One special apprentice remarked recently that he would be out of his time in a couple of months, and he would be awfully glad, as he would get away from the dirty work, and out of wearing his overalls! This feeling practically paralyzed him for all time to come. A special apprentice, fresh from a college or university, is about as useless an employee as you can have in a railroad shop

for the first six months of his apprenticeship—in ordinary work, he can not begin to hold his own with the ordinary machinist apprentice—in fact, he never will accomplish as much work, while on the very face of the thing, he should be able to accomplish a good deal more. His age, his education and association should all be in his favor, but I regret that for actual shop work, his education does not seem to have benefited him any. There are a few exceptions, but I am speaking of the majority.”

JOHN FRITZ (1822-1913)

W. G. ALTPETER, '15

The death of John Fritz, on February 13th of this year, was a great loss to America and to the iron and steel industry. John Fritz died at his home in Bethlehem, Pennsylvania, at the age of ninety-one years. He was a pioneer iron master and a distinguished manufacturer, who was known and honored abroad as well as in his native country. Starting life in comparatively obscure surroundings, without any of the great advantages of a technical education, he fought his way to the front, leaving behind him a name and a record which will long be honored.

John Fritz was born in Chester County, Pennsylvania, August 21, 1822. He came of parents of exemplary character. His father was born in Germany, and his mother in Chester County, Pennsylvania. The elder Fritz was a millwright and a machinist, and young Fritz, from his early boyhood on the farm, showed a tendency toward the mechanical side of life. At the age of six, he was given his first job. This consisted of light chores about the farm. His father was very strict and exacting, and would allow nothing to be done unless it was done in the best possible manner. Young Fritz at times could not see his father's idea in being so strict and exacting, but he later lays his success in life to the careful and exacting training received in early youth from a kind and exacting father. At the age of eight he was given his first opportunity to attend school. The school term was very short because many of the pupils had to work on the farm, and attended school only for a short time during the winter. Fritz continued to attend school for three months each winter until he was fifteen years old, when he became an apprentice to a blacksmith. Here he had to pump bellows for the better part of six months. During this time his interest in machinery greatly increased, and whenever he had some time to himself, he could always be found at a nearby mill, looking over the different kinds of machines.

In 1839, while he was still an apprentice, he devised a scheme for changing a flint lock shot gun to a percussion cap. This little idea brought him quite a good deal of money. By working late at night he changed all the old flint locks in the neighborhood to percussion caps, charging the owners a small sum for the improvement. During this time, his employer met with an accident, just

as a large piece of work had to be turned out. Fritz had been working with his employer on the job, and the finishing of this piece of work naturally fell to him. He completed the work so well that he was given the position of assistant foreman. His interest in locomotives and in railroading now became so great that he was determined to learn the iron industry at the first opportunity. This opportunity came in the way of an apprenticeship to a mill at Coatesville, Pennsylvania, which had been built for rolling bar iron. Fritz was determined to learn the different processes from start to finish. Each night found him at the puddling furnaces until he had mastered their operation. He then spent his evenings in the heating and rolling departments, where, after gaining the confidence of the working men, he learned each operation in these departments. At that time it was very hard to obtain anything from the workingmen, because many were foreigners who were very jealous of what knowledge they possessed in this line.

John Fritz had but one guiding star, and that was never to shirk a responsibility, and never to miss an opportunity to acquire knowledge. During this entire time he had been so taken up in his work that he had not seen that his employers had taken a good deal of interest in him, and was very much surprised when he was given the position of Night Superintendent, followed closely by a promotion to Day Superintendent. His policy now was to let nothing leave the shop unless it was of the best quality in that line. This, and his many improvements in the puddling, heating, and rolling of iron made his rise very rapid. These improvements had all been made possible by his hard night work when an apprentice. As a result of his untiring work in the iron industry, he was asked to assist in the building of the Cambria Iron Works, at Johnstown, Pennsylvania. During this time his path had not been strewn with roses. He had had trouble with workingmen, sickness had taken a good share of his time, and he had once lost his mill by fire, but undaunted, he came back and fought his way to the front.

Federal recognition of Fritz's genius came during the civil war, when he was given charge of the mill at Chattanooga, Tennessee, where locomotives were repaired and rails manufactured for the Government. When the Bessemer method for the production of cheap iron was introduced into this country, Fritz realized its

enormous value and he, with two other men, applied their genius to the improvement of the process. It was they who laid the foundation of the enormous industries which are now represented by the iron and steel trades in this country. The recreation of our Navy was rendered possible when our ironmasters agreed to take up the manufacture of armor plate and the necessary forging for guns of heavy caliber. John Fritz stood foremost in this movement, and his Bethlehem plant was the first to take up the manufacture of armor plates in the United States.

Lehigh University owes much to the trusteeship and generous assistance of John Fritz. In 1898, Columbia University conferred upon him the degree of Master of Arts. He was an honorary member of the American Society of Civil Engineers, was president of the American Society of Mechanical Engineers, and also of the American Society of Mining Engineers. In 1895, he was awarded the Bessemer gold medal, by the unanimous vote of the Iron and Steel Institute of England. He was also elected an honorary member of that society, at which time there were but five other names carrying that distinction. On Mr. Fritz's eightieth birthday was founded the John Fritz gold medal for achievements in engineering sciences in this country. John Fritz was not more distinguished than he was beloved, and many are the American engineers who are willing to pay tribute to the memory of the aged pioneer ironmaster.

UNCOVERING THE FACTS

By Students in the Shop Management Courses.

Introductory Note by Director B. W. Benedict: A distinguished engineer in recounting, not long ago, the experiences of a life time, made the startling observation that he had found but one man among many—meaning hundreds—who was thoroughly informed as an expert in one particular branch of work. College men and graduates from the school of hard knocks, composed without distinction the ranks from which these conclusions were drawn. No taint of pessimism colored the views of this keen observer and analyst. His was a simple statement of facts as he had found them.

Sweeping as this arraignment of the rank and file may be, it is true. If not, why the scarcity of trained and competent men for positions of responsibility; and the glut in the common occupations of the drafting room and shop? Any large employer of labor would rather have men of the \$10,000 caliber than those of the \$500 type, said Mr. Alexander H. Revell, in a recent address, because the high price man returns service worth many times what it costs, while the other repays on the basis of dollar for dollar—perhaps less. The man who knows—the expert—is cheap at almost any price, and we are entering on an era in which the specialist will become increasingly dominant and receive rewards far greater than those of the present day.

There is no formula for becoming an expert, nor *open sesame* by which the goal may be reached. Some of the qualities that characterize the expert are undoubtedly inherent, but most are acquired. Not every one can become a specialist, but more fail from lack of concentration and hard work, than from personal limitations. The individual of ordinary attainments can by application to one particular problem, become an expert. If the problem is limited in scope, the expert may not rank with those who are specialists in larger things, yet he will become a contributing factor in the progress of civilization, and receive a corresponding reward.

An expert is defined as "one who has special skill, experience, or knowledge, as in some department or branch of science." To qualify under this definition, the individual must quite obviously possess some uncommon attainments. Among these, the personal

element will naturally remain distinctive, but the attributes acquired through training and experience are of necessity more or less common to all individuals of this type. For instance, specialists have the power of observation and analysis developed to a high degree. The ability to see things as they are—to grasp at once the vital elements of a problem, is perhaps the distinguishing characteristic of the expert. This faculty varies with the individual, but it can be greatly developed by training.

In the shop management courses, the young engineer is given an opportunity for developing his powers of observation by the application of methods which approach those of practical life. The functions of the Standard Practice Engineer are essentially those of the expert in shop processes of manufacture and production. By careful analysis—of the movements made by operators; of cutting feeds and speeds of machines; of tool and machinery performance; of efficiency of belting; of movement of parts through the shop; and of a multitude of factors entering into shop operation, the losses in time and wastes of movement (all of which cost money, but do not produce revenue) can be definitely determined. It is then but a step to devise methods without the costly frills of previous practice.

Improvement never precedes investigation. The searching eye of the analyst is the force behind the spirit of progress, as it lays bare the inefficiencies of the moment—and who knowingly continues to use inefficient practices? The trouble is not here, but in the recognition of the bad which lurks unseen and unannounced in all human affairs. In developing the shop courses it has been the aim of the instructional staff to use students as investigators for the value of the training to them. Following are a few representative reports of students, showing general conditions in the machine department. As first efforts they are worthy of special commendation. No specific instructions were given, but the keys of the shop turned over as it were, to the student, with the request to hunt wastes and inefficiencies. Even though the conditions were known in detail to the instructional staff before these assignments were given the students, no suggestions were offered. The student was thrown upon his own resources for the purpose of developing that most important faculty—analysis. The manner in which this opportunity was embraced may be judged by the following reports:

By E. M. BARNUM, '15

The accompanying records, taken in section "P" of M. E. 42, are intended to show any weak points of the system now in use. The time was taken on standard operations, carried out by the students, according to the directions on the instruction cards.

The results show, as was expected, considerable waste of time in the shops. There was, however, no waste of stock, other than the turnings from the castings.

The loss of time was due to a number of different causes. In some cases the instruction cards were incomplete and failed to give the speed of the machine for various operations. This invariably resulted in the student running the machine slower than the intended speed, and thus losing much time as well as doing poorer work. In all such cases a note was made at one side of the record sheet.

While the object of the time study is essentially to improve the instruction cards and thus to make the shop more efficient, the time lost in other ways was not overlooked.

A record was taken at both the tool room window and dispatch window in order to ascertain whether any time was being wasted. The principal business at the dispatch window is to assign new jobs. The average of the time taken for eleven consecutive job assignments, was 58 seconds, which seems very low and goes to show that not much time was lost in this department.

On the other hand, about one-fourth of the time lost in the shop was lost at the tool room window, and chiefly at the beginning of the period. On two occasions, the last man did not leave the window until 20 minutes after stamping in at the beginning of the period. The shortest time required to equip all of the men with tools, etc., was 11 minutes. This was due to the fact that at the beginning of each period all of the men wanted tools at the same time.

A great deal of time was lost owing to the fact that the students were not familiar with their work and machine. A good example of this was found in the piston ring job. No. 76 required 3 minutes to part the first ring and by increasing the depth of cut gradually, he was able to part the last ring in 50 seconds. The loss of time through unfamiliarity is unavoidable to a certain extent in a shop where the students are moved from one machine to another and given different jobs continually.

There were a number of ways in which small losses were caused. Some of them as follows:

(a) One date much time was lost on account of there being but one grindstone in operation.

(b) On three occasions it was necessary to hunt for tool post wrenches.

(c) The chucks invariably jammed on the spindle and thus caused a lot of trouble before they were loosened. This was partly due to the fact that they were screwed on too firmly.

(d) In the case of work on Card No. 4-1 a lot of time was lost owing to the fact that the Bloomfeldt boring tool would not fit in the tool posts of the first two lathes on which it was tried.

Quite a saving of time could be made by having all of the belts in the shop inspected and the loose one tightened. The machines could then be worked harder and it would not be necessary for the student to stop to tighten a belt in the middle of an operation.

The tote boxes which have recently been placed in the shop, have proved to be quite a help in saving of time, and in keeping the different pieces together during the different operations.

Most all of the losses may be remedied and in some cases they have been since the accompanying data was taken.

By R. E. MORRIS, '15

In complying with request to investigate the conditions in the machine department, I, as Standard Practice Engineer, have watched the work of different students in Section "L," with the aid of stop watch and instruction cards, and can report the following conditions:

When a student starts a new job (in most cases the machine is new to him), he loses time getting the instructor to come to his machine and instruct him in the working principles of that machine. No. 11, not being familiar with his machine, only made an efficiency of 53 per cent for one period. When a student understands the machine, the work progresses rapidly.

In beginning a new period, a student after being assigned to a machine, finds that work has been left on the machine from last period, and in order for him to work on his job he must remove the piece from the machine and place his own on it. If this is repeated in every section, each student loses a considerable amount of time.

In all cases, students lost from three to six minutes obtaining tools from the tool room at the beginning of a period. In the case of No. 57, who was familiar with his machine and the work, one-tenth of his time was lost by frequent trips to the tool room.

No. 2, wasted one-third of his time looking for a tool which he had checked from the tool room but had misplaced around his machine.

It seems that most of the time is lost by checking tools from tool room, and not being able to locate exact tool. Short periods are a great disadvantage, as has been shown by the necessity of changing work or machine each period. The students being unfamiliar with machines is expected.

By RUSSEL D. LANIER, '15

I have the honor to report my observations of time of the shop methods and practices in the machine department during section "Q." In practically all jobs that have been timed in the shop, fear of spoiling the work or injuring the machine has been a large factor in slowing the speed of the workman. When this fear is overcome, the efficiency of the workman is greatly increased. For example, No. 51, in grinding piston rings, Instruction card A 18-4, finished the first ring in 18 minutes and 33 seconds; the second in 11 minutes, 39 seconds, and the third, 6 minutes and 19 seconds. His time for the last ring was practically three times faster than for the first. Another case is on the cam shaft, Instruction card A 19-3. In milling cam No. 1, the student worked 70 minutes; later, on the same operation the cam was milled in 7 minutes and 30 seconds, or ten times more rapidly than the first.

Losses due to stamping in and out at the clock were found to be inconsequential; the average time for stamping being 7 seconds.

Taking the average of ten time studies, it was found that an average of 6 minutes and 42 seconds were lost on each job, due to grinding of tools alone. With twenty-seven men working, this means a loss to the shop of 3 hours and 54 seconds in a working period of 2 hours and 40 minutes, or that one and one-eighth hours are lost to the shop in each working hour from this cause alone. On a wage basis of twenty-five cents an hour, the shop losses, or spends for grinding, \$2.83 in a ten-hour working day. There would never be a time when *each* man would put in his

6 minutes and 42 seconds grinding, but the total loss is not to be overlooked.

Time lost in giving out tools and stock amounts to much less. The maximum loss was found to be 1 hour and 35 minutes in a working period of 2 hours. Very little more would be lost in an 8 or 10 hour day. In money wages, this amounts to a loss to the shop of thirty-seven and one-half cents a day for an organization the size of this section.

The sum total of these losses forms a loss worthy of serious consideration.

By THOMAS WHITE, '15

With the general efficiency of the shop in mind, I made time studies of the different operations (Section "M") in the manufacturing processes of the machine department. Attached are tabulated forms on which the time of several operations is shown, what time was lost, if any, and the reason for the loss of time is indicated. These separate reports are self-explanatory as far as they go, but the defects which reduce the efficiency of the shop would not be sufficiently brought out unless properly classified; consequently this report will treat under their particular headings, the causes for loss of efficiency.

Improper inspection is the cause of such loss of time. In operation 3-3, the student spent practically two afternoons turning up a crankshaft, only to discover at the end of that time that the student who had performed the previous operation on the drill press, had drilled the holes too deep in the pin, and the work was thus spoiled. Had the piece of work been properly inspected, the student's time would have been used to the better advantage of the shop. In the case of bases and crank cases, I have noticed that there were several castings at the horizontal boring mill, which should have at this stage needed only one operation to complete them. This was not the case, however, for on some of the castings a few holes had not been bored, while on others a complete operation had been omitted; consequently the production engineer could not count so many castings as about to be finished, for the castings had yet to be drilled on the drill press. Had these crank cases been inspected after each operation, this could not have happened.

Other sections disturb or remove work from machines and cause much confusion and loss of time. In one instance the rout-

ing assistant assigned a student to a job on the bases, and after the student had gotten his card and his tools, he found on arriving at the machine that no such job was in evidence. Another section had evidently removed or finished the job. At any rate thirteen minutes were lost. (See No. 48, operation 2-1.) Pieces that have been chucked at the end of the period are taken from the chuck before the next period and the process of chucking has to be repeated. (See No. 61, operation 6-1.)

The student not being familiar with the machines causes time to be lost. The turret lathe and bolt cutter offer the most trouble. At best the student can only get started after the instructor has spent a great deal of time in setting up the tools (See Nos. 23 and 18, operation 34-1). A considerable amount of time is also lost at the Cincinnati milling machine, because the student is not acquainted with the speeds, and the method of changing the direction of the cutters.

Quite frequently, the student is called upon to go to the forge department for material. This consumes a great deal of time, when it seems that this is unnecessary.

Another potent factor in lessening the shop efficiency is the fact that the necessary tools for performing an operation are not at the machines. This causes the student to lose much time in going to and from the tool room. At the beginning of a period a number of students apply to the tool room at once. Congestion for a few minutes is the result and the student loses from three to ten minutes getting his tools. In (No. 35, operation 10-5) the caps did not fit the jig for the drill press, and time was lost in filing them until they did. In (No. 97, operation 2-4) the shank on the drill was not long enough to reach the slot in the tool holder of the boring mill, and over thirteen minutes was lost in loosening the tool. In (No. 97, operation 8-2), there was no taper shank drill to fit the chuck in the drill press; consequently the tool slipped continually, and much time was lost.

In instances where stock should be forwarded to the next machine when an operation has been completed, this has not been done. Frequently, when a student is assigned a job, he loses five minutes in finding the stock. The routing assistant is responsible for this, but he can hardly be held accountable, for when he arrives, he never finds his work as he left it—other sections have moved the work and he has to spend a busy half hour trying to

find how the "land lays," before he can with any degree of certainty, assign a job.

Outside work interferes with the shop efficiency. On one occasion when a machinist was cutting test pieces of boiler plate, a student had to wait for an hour before he could use the milling machine.

The records kept in the office are not accurate. In no case have I seen the material despatch sheet in a condition so that it could be relied upon to give definite and exact information telling at what stage of completion a casting was, or how many of its kind were completed. In such a case the routing assistant and material engineer were called upon to hunt up what castings could be found.

In my opinion, a conservative estimate of the time lost by the average student in a period of 2 hours and 40 minutes, is from 15 to 30 minutes, due to the causes enumerated. In some cases the time lost does not approach this, but in others it exceeds it by a half hour or more.

In summing up the chief causes which reduce the efficiency of the shop, I would say that there are eight: (1) lack of proper inspection when an operation is complete; (2) interference from other sections, especially in the case where work is left in chucks; (3) the students not being familiar with some of the machines; (4) the necessity of going to the forge department; (5) the necessary tools are not at the machines, and time is lost going to the tool room; (6) the stock is not forwarded promptly for the next operation; (7) outside work keeps the students from working at the machine they need to use, and (8) the records of the office are inaccurate.

As a remedy for this loss of time, I would suggest: (1) rigid inspection of each operation when complete; (2) devising some means by which work could be left in a chuck undisturbed by other sections; (3) instruction early in the semester on the turret lathe, bolt cutter, and milling machine; (4) keeping sufficient stock in the tool room to obviate the necessity of going to the forge department; (5) having all the tools necessary for an operation kept together so that the student need apply but once for them at the tool room; (6) devising some means by which the routing assistant can continue with his work from one period to another, with-

out having to lose time in looking over the entire shop each period before he can safely assign jobs; (7) outside work should be done after the students have left the shop; and (8) each casting should be brought to the production engineer when finished and inspected, or positive information on some printed form should be given him so that the stock book and despatch sheet tally with the stock on hand. If the material and production engineers co-operated in this matter, I think better records would result.

The Technograph

Published quarterly during the college year, by students of the
 ENGINEERING SOCIETIES OF THE UNIVERSITY OF ILLINOIS
 Representing the interests of the Electrical, Mechanical, Civil, Chem-
 ical and Mining Engineering Departments.

TECHNOGRAPH BOARD

A. ELMENDORF, M. E. '14	- - - - -	<i>Editor-in-Chief</i>
E. C. PROUTY, C. E. '14	- - - - -	<i>Business Manager</i>
W. LERICHE, E. M. '14	- - - - -	<i>President</i>
R. H. BACON, E. E. '14	- - - - -	<i>Secretary</i>
E. A. JAMES, E. E. '15	- - - - -	<i>Editorial Staff</i>
H. E. AUSTIN, M. E. '15	- - - - -	<i>Editorial Staff</i>
G. B. RUBY, Ch. E. '15	- - - - -	<i>Editorial Staff</i>
E. P. HERMAN,	- - - - -	<i>Editorial Staff</i>
J. E. DEMUTH, C. E. '15	- - - - -	<i>Business Staff</i>
C. G. KRAMER, E. M. '15	- - - - -	<i>Business Staff</i>

ADVISORY BOARD

W. F. M. GOSS, M. S. D. ENG.	- -	<i>Dean of the College of Engineering</i>
G. A. GOODENOUGH, M. E.	- - -	<i>Professor of Thermodynamics</i>
I. O. BAKER, C. E. D. ENG.	- - -	<i>Professor of Civil Engineering</i>
E. J. MEHREN, C. E., '06	- -	<i>Associate Editor, Engineering Record</i>
AVERY BRUNDAGE, C. E., '00	- -	<i>Civil Engineer for Holabird & Roche</i>

THE PUBLISHERS' ANNOUNCEMENT.

Subscription price, \$1.00 a year in advance. Subscriptions payable by Post Office or express money orders, bank checks, drafts or registered letters, made payable to THE TECHNOGRAPH. Money in letters at sender's risk.

ADVERTISING—The rates for advertising will be quoted on application. Copy should be in the hands of the publishers by the 10th of the month preceding publication.

THE TECHNOGRAPH,
 Urbana, Ill.

EDITORIAL

THIS ISSUE

It gives the present management of THE TECHNOGRAPH no small pleasure to be able to present to the subscribers this issue, the fourth of the collegiate year. Thanks to the efforts of the outgoing board, consisting of Mr. H. W. Underhill, as Editor-in-Chief, and Mr. G. G. Fornoff, as business manager, THE TECHNOGRAPH has been placed on a firm financial basis. Thanks to the student body, whose interest is manifest in the number of student authors—over half of the contributions having come from undergraduates. With the completion of the present volume, the first in the history of THE TECHNOGRAPH, to consist of four numbers, the prospects for a larger and better TECHNOGRAPH are particularly encouraging.

**PROF.
E. J. BERG**

The resignation of Professor E. J. Berg, as professor of electrical engineering, calls forth the heartfelt regrets of all his students. His cordial personality and kindly guidance will long be remembered. His wonderful ability of presenting the most profoundly technical abstractions by illustration and analogy, such that even those understood who are untutored in the mysteries of the science of which Professor Berg is a master, marked him as one of our most successful teachers. Union College is to be congratulated upon its good fortune in securing the services of such a valuable man.

**THE NEW
COURSES**

We include in this issue, a brief description of the new courses in engineering, as outlined by the committee of which Professor Goodenough was chairman. Besides the changes which involve the shifting and the combination of several courses, the most noteworthy feature in the new arrangement is prevalence of nine hours of non-technical electives in the junior and senior years. The wisdom of this provision should be appreciated by every engineering student.

With the instruction in the humanities thus offered as a sequel to the preceding courses in language and rhetoric, we, as engineers, should, at least to a limited extent, be able to dispel some of the current notions concerning the engineer's culture, due partly to our affable indifference to literature and art, but more to a lack of opportunity for the study of the humanities.

The changes are to affect next year's freshman class, the sophomore class in part, and to a certain extent, the junior class, but the senior course of study will probably not be changed.

**"SOCIALIZING"
THE ENGINEER**

We recommend the reading and the re-reading on the part of every engineering student, of Professor Todd's article. It merits the deepest consideration. A thoughtful perusal of its pages may profoundly influence our ideas regarding the engineer and his relation to his fellowmen. The thrill which pervades its lines must rouse the mind to contemplation of the appalling responsibilities that confront the engineer, but of which he, unfortunately, too often is unaware. Read, and catch its enthusiasm!

**APPRENTICESHIP
COURSES**

But two weeks more, and many of us attend for the last time, the halls and class rooms wherein so many anxious hours were spent during the past four years. The question "Where shall I go?" is now paramount in the minds of all seniors. For the benefit of those who are contemplating to "start on the ladder" by entering the services of a manufacturing company, as special apprentices, a study of this field of employment was made by three competent undergraduates. Their investigations are presented in this issue under Special Apprenticeship Courses for Technical Graduates. The ideas presented are unbiased and are based on facts obtained directly from their employers.

DEPARTMENT NOTES

E. E. SOCIETY.

Prof. A. M. Buck, of the railway department, gave his second lecture on the subject of Electric Traction, the evening of March 14. His discussion was confined chiefly to unit switch systems of motor control, and the development of the railway motor. The unit switch control is a system of control, by which the main motor circuits are opened and closed by individual switches, these switches being operated by a control circuit which is independent of the motor circuit. This eliminates the necessity of the main controller carrying heavy currents and enables the use of a small master controller, and also makes it possible to control several motor cars in a train from one master controller. Railway motors have been developed from the original belted contrivances, open to the dirt and dust, to the modern, high efficiency, enclosed motors, geared direct to the axle. One of the strong features of the modern motors is their rigidity and ability to withstand rough handling.

At a meeting of the Society, March 28, Mr. Stanley P. Farwell, of the T. & A. M. Department, gave an interesting talk on "Corporational Finances." He outlined the growth and development of the Westinghouse and General Electric companies, and gave some details of their organization and of their methods of financing.

"The Fixation of Atmospheric Nitrogen" was discussed at a meeting of the Society, April 11, by Dr. D. A. McInnes, of the Chemistry department. Nearly all of the methods he described involved the use of the electric arc, which causes the oxygen and nitrogen of the air to combine and form usable compounds. Various devices are used to produce suitable arcs, in one method an arc 25 feet in length being used.

A large and appreciative audience heard Doctor Berg give his lecture on Lightning Protection at a meeting of the E. E. Society, April 25. Doctor Berg first discussed the causes of lightning and the nature of the various kinds of discharges. The function of the lightning rod and the requirements for good lightning protection were taken up and worked out on a theoretical basis, and he concluded with recommendations as to the best form of lightning rod to use. He advises the use of a conductor made of $\frac{1}{2}$ -inch

iron pipe, which should be run along the highest parts of the roof and over the chimneys, with points projecting upward at various locations. The pipes should be thoroughly grounded in several places. The type of ground he recommends is one made of an iron pipe with numerous holes drilled in it at the lower end, the pipe to be driven five or six feet into the ground. Common salt or salt water poured in at the top may improve the grounding qualities of this arrangement. He concludes that a building protected in the manner described, is practically immune from destruction by lightning. After the lecture a business meeting was called and it was decided to award the members of the Engineering Dance Committee the Society's share of the proceeds. C. R. Horrell presented a report of the Electrical Show, showing a clear profit of over \$162. It was decided that \$100 of this should be set aside for the next electrical show, to be used for no other purpose.

MECHANICAL ENGINEERING DEPARTMENT.

At a meeting of the A. S. M. E., on April 18, Mr. Domonoske gave an interesting and instructive talk on "The Production of Oil-Gas." Mr. Domonoske, coming as he does from the Pacific coast, where the production of oil-gas is an important industry, is very well qualified to talk on this subject. Mr. H. E. Austin was elected to the TECHNOGRAPH Board.

On May 2, a large number of engineers assembled to hear Professor Goodenough tell "What Mechanical Engineers do." He gave a general classification of the work which mechanical engineers do and then proceeded to tell of the different positions which our graduates are holding. By means of a chart on which years were plotted against technical graduates, he showed those present just about what position they should hold after any term of years.

From April 4 until April 11, through the kindness of the National Acme Co., the entire body of engineers was given an opportunity to witness a demonstration of a multi-spindle automatic turret lathe. The demonstrator answered the numerous questions asked him, and gave a detailed explanation of the operation of the machine.

THE CIVIL ENGINEERS' CLUB.

On April 11th, Mr. Langdon Pearse, Division Engineer of the Sanitary District of Chicago, gave a very interesting illustrated lecture on sewage disposal. He talked on the methods and devices used in disposing of sewage in Chicago as well as in other large cities.

On April 18th, Mr. Will P. Blair, Secretary of the National Paving Brick Manufacturers' Association, gave an illustrated talk on brick pavements. He outlined the economic advantage to be obtained from good roads, and spoke of the necessity for the Federal government supporting the "Good Roads" movement. Mr. Blair entered a plea for the use of proper methods in brick pavement construction, and convinced his hearers that brick pavements are economical.

April 22nd was a holiday for the thirty Senior Civil Engineers who went on the inspection trip to Mohamet, to watch the erection of a 250 foot highway bridge. Mr. Brown, of Frazee & Brown, the contractors on the work, treated the boys royally, and furnished a generous lunch. The bridge is a two span Pratt truss and was designed by Professor Dufour. Two other bridges in the neighborhood were inspected, a highway bridge and a girder bridge. During the recent flood, one end of one of the abutments failed, leaving the bridge resting on three supports. The masonry abutment which failed, was built on two thicknesses of 12"x12" timber as cribbing in quicksand. As a temporary support, four bents on mudblocks were set in the river, and additional falsework of railroad ties replaced the abutment corner. Cables were attached to top and bottom of the bridge and fastened to trees to assist in preventing overturning. The bridge was built by the Indiana Bridge Company, in 1897, and was designed by Professor Baker. The abutment will be replaced by a concrete pier going below the bed of quicksand, and an additional 60 foot span will be constructed at the end of the old bridge.

MINING SOCIETY.

Since the last issue of THE TECHNOCRAPH, the Miners have given two Smokers in connection with the bi-monthly meetings of the society. At the first meeting, talks were given by two student members of the society. A general discussion was held

after the presentation of each paper. The speakers at the first meeting and their subjects were as follows: L. W. Swett, on "Gold Dredging in Siberia"; Willis Leriche, on "Copper Mining at Bisbee." At the second meeting, Mr. Lauer talked about "General Cyanide Practice," and Mr. S. O. Andros described "Placer Prospecting" in vivid terms. Mr. Andros did not neglect to tell about some of the things that had been "slipped" over him.

Director Young, of the Missouri School of Mines, lectured to the members of the faculty and students of the Mining school on "Mine Management," on April 13-14, inclusive. As the subject is a very long one, and contains many subdivisions, Mr. Young confined his remarks to "Scientific Management." A comparison of the costs of mining in various well-known metal districts was one of the principal features of his lectures.

On March 27th, Mr. S. O. Andros, Mining Engineer, lectured before the C. E. Club, and the Mining Society, on "How Coal is Mined in Illinois." During the past summer, Mr. Andros examined a large number of Illinois mines in connection with the Co-operative Coal Mining Investigation, hence he is thoroughly conversant with conditions in the State. The lecture was illustrated with numerous lantern slides.

The junior class in Mine Surveying, "chaperoned" by Mr. Lauer, recently spent three days in Danville, Ill., engaged in the survey of a mine. Dean Clarke at first frowned upon the proposed trip, probably fearing that the students could not conduct themselves in a respectable manner. However, after administering a few words of fatherly advice, he granted the class a leave of absence.

Weston Instruments

A FULL LINE OF

Alternating Current Switchboard Indicating Instruments

Is Offered by this Company, Comprising Wattmeters, Single and Polyphase, Power Factor Meters, Synchrosopes, Frequency Meters, Ammeters, Voltmeters. New Models of Weston D. C. Instruments to Match

This whole group of instruments embodies the results of several years' exhaustive study and scientific investigation of all the complex electrical and mechanical problems involved in the development of durable, reliable, sensitive and accurate instruments for use on alternating current circuits.

Every detail of each of these instruments has been most carefully studied and worked out so as to be sure that each shall fully meet the most exacting requirements of the service for which it is intended. Neither pains nor expense has been spared in the effort to produce instruments having the longest possible life, the best possible scale characteristics, combined with great accuracy under the most violent load fluctuations and also under the many other trying conditions met with in practical work. Every part of each instrument is made strictly to gauge and the design and workmanship and finish is of the highest order of excellence.

We invite the most critical examination of every detail of each member of the group. We also solicit the fullest investigation of the many other novel features and very valuable operative characteristics of these new instruments and request a careful comparison in all these respects with any other make of instruments intended for like service. We offer them as a valuable and permanent contribution to the art of electrical measurement. Their performance in service will be found to justify the claim that no other makes of instruments approach them in fitness for the service required from A. C. Switchboard indicating instruments.

Full particulars of design, construction, prices, etc., are given in Catalogue 10. Write for it.

Weston Electrical Instrument Co.

Main Office and Works: NEWARK, N. J.

SWARTZ ELECTRIC SHOP

Illuminating Engineer

Everything Electrical

Bell 225, Auto 4314

116 S. Race St., Urbana, Illinois

JAHN *and* OLLIER

ENGRAVING CO.

ENGRAVERS, ARTISTS, ELECTROTYPERS.

554 W. ADAMS ST., NEAR CLINTON CHICAGO.

☐ PHONE MAIN 3821 ☐

When writing to advertisers please mention THE TECHNOGRAPH

Wickes Vertical Water Tube Boiler

Ever cleaned a boiler? Lamed your back, bruised your knees, skinned your elbows doing it? If you have, you will appreciate this boiler at a glance.

Cut shows position of man cleaning. He stands erect. Is it laborious compared with usual forms?

The very highest number of horsepower hours per year are obtained from this boiler because of short time out for cleaning.

Two 12 x 16 inch manholes open into this boiler. One top, one bottom. Inspection and cleaning is a simplified matter. TWO men can open, wash or turbine and close this boiler in ten hours.

Is all your "boiler money" busy all the time? When your boilers—any of them—stand idle, there is considerable investment that is NOT earning money—that is not contributing its share to the PROFIT of your Company.

There are other points.

Ask for Our Little Book

SENT FREE

—
THE

Wickes Boiler Company

Main Office and Works
SAGINAW MICHIGAN

Sales Offices in Principal Cities

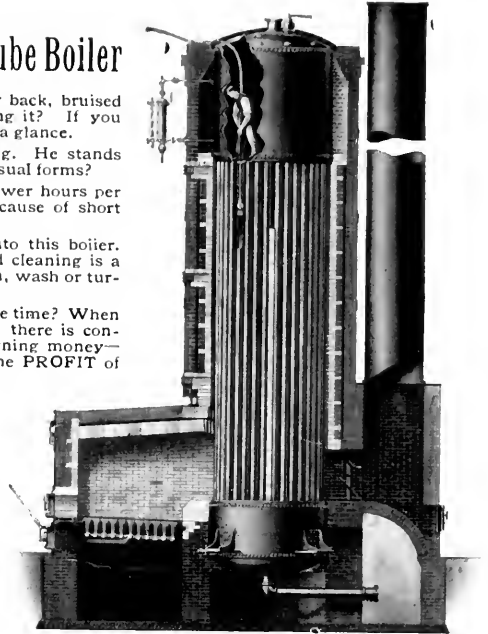

Illinois Malleable Iron Company

CHICAGO, ILL., U. S. A.

The Sign



of Quality

Manufacturers of

Malleable and Cast Iron Pipe Fittings, House Heating Boilers, Garbage Burners and Water Heaters, Street Improvement Castings, Electrical Construction Supplies, Elevator Buckets, Tank Lugs, Clevises, and Castings of every description in Malleable and Gray Iron.

Catalogue Mailed Upon Receipt of Request

LUFKIN Measuring Tapes

In use on the big projects, the precise work, in the hands of the big men of the engineering world.

THEY MEASURE UP TO THE MAN

THE LUFKIN RULE CO. Saginaw Mich.

New York

London, Eng.

Windsor, Can.



When writing to advertisers please mention THE TECHNOGRAPH

IT'S A FACT

Most men in this vicinity come to Jos. Kuhn & Co. Store for their Clothes. The Store proves the Reason.



Jos. KUHN & Co.

**CENTRAL ILLINOIS' MOST
COMMODIOUS CLOTHES STORE**

Every department contains the most comprehensive stock of wearing apparel for the

MAN AND BOY

from the finest grade to the most inexpensive

Homelike atmosphere—the place to shop—
Satisfaction or your money cheerfully refunded

CHAMPAIGN ILL.

NOT
MATCHED
IN
118½
MILES.

JOS. KUHN & CO.

When writing to advertisers please mention THE TECHNOGRAPH

GET YOUR KODAK

out and see if it is in good shape
for the

SPRING SPORTS

If you do not own a Kodak, now
is the time to buy



Interscholastic Week will soon be here and you ought to get a choice bunch of pictures at that time.

A FINE
LINE AT **LLOYDE'S** MAIN ST.
GREEN ST.

Have your valve specifications read:

Jenkins Bros. with Diamond Trade Mark

It is the most certain and direct way of obtaining satisfactory service, for either heating or power installation.

It is freely acknowledged by experienced users and steamfitters that the JENKINS BROS. are the heaviest and strongest radiator valves made. The large, heavy bonnet and union, parts usually slighted in valves of ordinary grade, are but a few of the merits which serve to characterize the Jenkins Bros. Radiator Valves.

The valves are neat in design and well proportioned. They are made of superior grade new steam metal, containing high percentage of copper. Furnished plain, finished, or nickel plated. Finished valves are a rich bronze color when polished, particularly desirable for high grade work.

The valve illustrated is the regular angle valve with wood wheel. Aside from the radiator valves, Jenkins Bros. manufacture superior valves for plumbing and power plant

work, including globe, angle, check, gate, blow-off, and mechanical rubber goods.

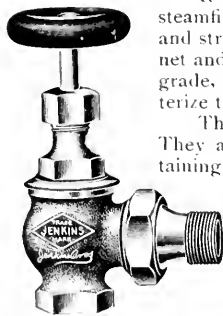

General Catalog Mailed on Application

JENKINS BROS., New York, Boston, Philadelphia, Chicago

When writing to advertisers please mention **THE TECHNOGRAPH**

The Technograph

VOL. XXVII

MAY, 1913

No. 4

CONTENTS

The New Locomotive Laboratory of the Department of Railway Engineering	<i>Edward C. Schmidt</i>	109
Use of Concrete in City Pavements and Country Highway Construction	<i>H. K. Talbot</i>	123
Socializing the Engineer	<i>Arthur J. Todd</i>	132
The New Course in Engineering	<i>G. A. Goodenough</i>	140
The Apprenticeship System for Technical Graduates in Mechanical Engineering	<i>George Meyer, Jr.</i>	144
The Apprenticeship System for Technical Graduates in Electrical Industries	<i>H. R. Tear</i>	146
The Apprenticeship System for Technical Graduates in Railway Service	<i>E. G. Young</i>	150
John Fritz (1822-1913)	<i>W. G. Altpeter</i>	156
Uncovering the Facts		159
<i>E. M. Barnum</i> , '15		161
<i>R. E. Morris</i> , '15		162
<i>R. D. Lanier</i> , '15		163
<i>Thomas White</i> , '15		164
Editorial		168
Department Notes		171

PUBLISHED QUARTERLY DURING THE
COLLEGE YEAR BY
THE ENGINEERING SOCIETIES OF THE UNIVERSITY
OF ILLINOIS, URBANA, ILLINOIS.

Annual subscription, \$1.00, single copies, 25 cents.

MANUFACTURING AND ENGINEERING DIRECTORY

Bowman, Ray L. 9 Champaign Steam Laundry . . . 9 Collegiate Press, The 10 Evens P. Howard Fire Brick Co. 8 General Electric Company . . . 2 Hotel Beardsley 9 Illinois Malleable Iron Company 4 Jahn and Ollier 3 Jenkins Bros. 6 Johnson, Gustave 10	Joseph Dixon Crucible Company 10 Jos. Kuhn & Co. 5 Link Belt Co. 11 Loydes 6 Lufkin Rule Co. 4 Marshall, Fred G. 9 Rail Joint Co. 11 Swartz Electric Shop 3 Vilter Manufacturing Co., The 8 Weston Electrical Instrument Co. 3 Wickes Boiler Co., The 4
--	---

THE VILTER MANUFACTURING COMPANY

Established 1867
 1062-1068 Clinton St., MILWAUKEE, WIS.

**ENGINEERS
 FOUNDERS and MACHINISTS**

Builders of
CORLISS ENGINES
 Girder or Heavy Duty Type Bed, for Belted
 or Direct Connected Service

ICE MACHINES, All Sizes

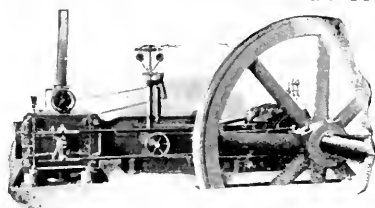

Corliss Engine with Rolling Mill Type Bed

SEWER PIPE—The Standard for over fifty years. 27, 30, 33, 36, 42 inch our specialty. All other sizes constantly in stock.

FIRE BRICK—A grade adapted to every use.

VITRIFIED DRAIN TILE—All sizes.

WRITE US NOW

Evens & Howard Fire Brick Co.
 ST. LOUIS, MISSOURI

Wilson Bros. Furnishings
Tailored Dress Suits for Rent
Full Dress Furnishings

Dress Suits Made to Measure
Anderson Tailored Suits Fit
Wonder Hats, Regal Caps

Arrow Collars

FRED G. MARSHALL

BRADLEY ARCADE

HOTEL BEARDSLEY

C. B. HATCH, Proprietor

Special Attention Given to Banquets

BOTH PHONES

Corner Neil and Hill Streets

CHAMPAIGN, ILLINOIS

Champaign Steam Laundry

MONROE & KEUSINK, Proprietors

Phones—Home 1115, Bell 897

30 North Neil Street

(Opposite Walker Opera House)

Coupon Books 10 per cent Discount

STUDENT TRADE A SPECIALTY

GIFTS FOR THE GRADUATES AT THE GIFT STORE

In the Walker Opera House Block

We Have Them at Prices to Suit All Purses

RAY L. BOWMAN

The Gift Store

WALKER OPERA HOUSE

CHAMPAIGN, ILLINOIS

If your watch goes wrong, we can make it go right



When writing to advertisers please mention THE TECHNOGRAPH

A STUDY IN GRAPHITE

Prof. W. F. M. Goss

J O S E P H
D I X O N
C R U C I B L E
C O M P A N Y

JERSEY CITY
NEW JERSEY

This is a comprehensive report of tests made by Professor Goss to determine the lubricating value of Graphite under varying conditions. A work of this kind by so eminent an authority will be of value to you. It's free upon request. Write for it.  

GUSTAVE JOHNSON, *Florist*

Cut Flowers, Potted Plants, Palms and
Ferns, Trees and Shrubs, Floral Designs

PHONES—Bell 1179, Home 1471

306 East Springfield Ave.

Champaign, Illinois

ON JOHN STREET CAR LINE

THE COLLEGIATE PRESS
GEORGE BANTA PUBLISHING COMPANY
MENASHA, WISCONSIN

When writing to advertisers please mention THE TECHNOGRAPH



Continuous Joint

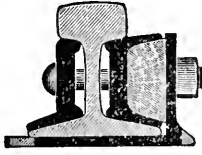

Weber Joint

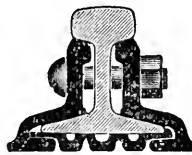

Wolhaupter Joint

CATALOGUE AT AGENCIES

Over 50,000 Miles in use	Boston, Mass.....	India Bldg.	Rolled from Best Quality Steel
	Chicago, Ill.....	Railway Exchange Bldg.	
	Denver, Colo.....	Equitable Bldg.	
	Portland, Ore.....	Wileox Bldg.	
	Pittsburgh, Pa.....	Oliver Bldg.	
	St. Louis, Mo.,	Commonwealth Trust Bldg.	
	Troy, N. Y.....	Burden Avenue	
	Montreal, Can.....	Board of Trade Bldg.	
	London, E. C., Eng.....	36 New Broad St.	

The Rail Joint Co.

GENERAL OFFICES

185 Madison Avenue, New York City

Makers of Base-Supported Rail Joints for Standard and Special Rail Sections, also Girders, Step or Compromise, Frog and Switch, and Insulated Rail Joints, protected by Patents.

Highest Awards—Paris, 1900; Buffalo, 1901; St. Louis, 1904

Write for This New Book

Everyone interested in modern, efficient and economical methods of conveying should have a copy

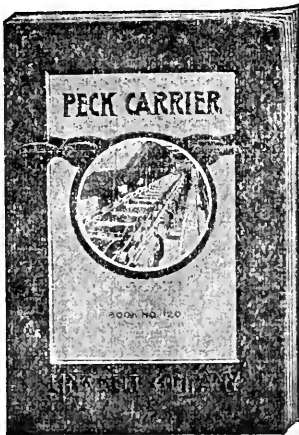

The Peck Carrier

is the recognized standard method of handling coal and ashes in the modern power house, as well as for conveying stone, cement, sand, ore and other materials.

This new catalog contains complete working drawings and clearance dimensions, to enable engineers to make provisions in their plans for the necessary coal and ashes handling machinery, etc.

Sent postpaid upon request.
Address nearest office.

LINK-BELT COMPANY 39th Street & Stewart Avenue, CHICAGO

When writing to advertisers please mention THE TECHNOGRAPH

Have You Learned How

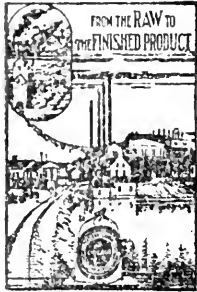

"From the Raw to the Finished Product"

—a 72 page booklet descriptive of the "Chicago AA" process of manufacture. Illustrated with 66 halftone engravings from photos taken at our mills.

FREE

to cement-users. Write for a copy today.



"Chicago AA"

Portland Cement is made?

It is a story of great interest to the man who uses cement. It tells how the raw materials are taken from the quarries, how they are weighed, proportioned, crushed and conveyed to the mills; it describes the "Chicago AA" process of drying, grinding and then burning the raw mixture to a "clinker" and explains, in an interesting way, the method of cooling the "clinker" and grinding and re-grinding it, thus producing "Chicago AA" Portland Cement, "the best that can be made."

Read this story: It will enable you to better appreciate the superiority of the "Double A" brand—it will guide you in the selection of a cement for your work in the future.

Chicago Portland Cement Co.
30 No. LaSalle Street, Chicago, Ill.

Manufacturers of the

"Chicago AA" Brand

"The Best That Can Be Made"

Present Output **1,500,000** Barrels Annually

When writing to advertisers please mention THE TECHNOGRAPH

HECKMAN
BINDERY INC.



OCT 96

Printed in U.S.A. © N. MANCHESTER, N.H.

UNIVERSITY OF ILLINOIS URBANA



3 0112 005649584