



THE UNIVERSITY  
OF ILLINOIS  
LIBRARY

620.5  
TH  
v. 34

610.6 1111 STACKS







RECEIVED



620.5  
TH

*Langley*

# THE TECHNOGRAPH

PUBLISHED QUARTERLY BY THE STUDENTS OF THE  
COLLEGE OF ENGINEERING UNIVERSITY OF ILLINOIS



October  
1921

FOUNDED · EIGHTEEN · HUNDRED · AND · EIGHTY · FIVE  
VOL. XXXIV · PRICE · 40 · CENTS · NUMBER I

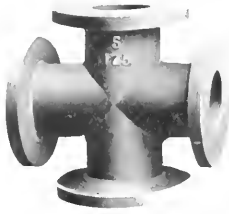

THE THREE ESSENTIALS

**STRENGTH  
ACCURACY  
FINISH**



Make "S" FITTINGS the logical choice when Cast Iron or Semi-Steel is specified.

We are complete line manufacturers of Cast Iron and Semi-Steel pipe fittings.

"S" FITTINGS are equally serviceable for steam, water, gas or air.



SCREWED AND FLANGED FITTINGS  
COMPANION FLANGES, FLANGE UNIONS

DRAINAGE FITTINGS

**STOCKHAM PIPE & FITTINGS CO.**

GENERAL OFFICE AND FACTORY  
BIRMINGHAM

DISTRIBUTING WAREHOUSES

BUSH TERMINAL,  
BROOKLYN

36TH & IRON STREETS  
CHICAGO



# LEFAX

*Leaf Plus Facts Equals  
Lefax*

A loose leaf system  
of tables and notes  
combined with blank  
forms.

LEFAX FOR ENGINEERS



606 E. Green

"Chuck" Bailey —Managers— "Shelby" Himes



Pep  
Snap  
Style

See Gelvin for Good Looking Clothes—  
Priced Right

GELVIN'S CLOTHES SHOP

# Seniors----

If you have not had your Illio picture  
taken, you are wanted at the Maguire  
Studio. We can deliver your photo to  
the Illio on time.

## THE MAGUIRE STUDIO

220 W. Main, Urbana

J. E. Maguire

P. W. Stephens

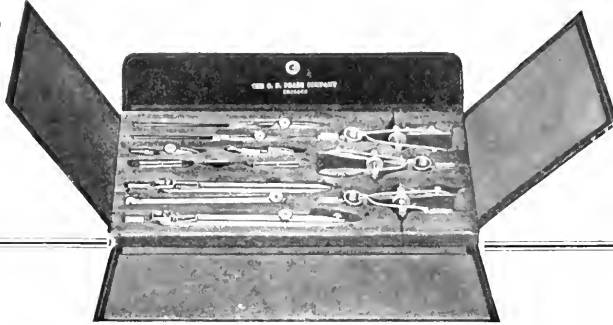

# American Made Drawing Instruments

Manufactured By

**THE C. F. PEASE COMPANY, Chicago, Illinois**

Are unexcelled in accuracy, quality, workmanship and finish. They contain that degree of precision and proper balance only obtained in high grade drawing instruments. We also carry a complete line of Engineering Instruments and Supplies, including T-squares, Triangles and Slide Rules.

## ENGINEERS!

## Get Your Supplies at Your Store

### WE HAVE THE FOLLOWING SUPPLIES IN STOCK

- |                                       |   |                            |
|---------------------------------------|---|----------------------------|
| Typewriter Paper.                     | Leather Note Books.                           | Theme Tables.              |
| Stationery.                           | Letter Files.                                 | Engineering Report Covers. |
| C. E. Field Books, (Leather Binding). | Illinois Belts.                               | Plain Report Covers.       |
| Note Books.                           | Combination Locks.                            | E. E. Papers.              |
| Scratch Pads.                         | Bridge paper.                                 | Paste and Mounting Glue.   |
| Fountain Pen Ink.                     | Partition Wallets.                            | Spring Back Note Books.    |
| Moore's Fountain Pens.                | Drawing Boards.                               | Current Magazines.         |
| G. E. D. Supplies.                    | Second Hand Books.                            | Chemistry Aprons.          |
| Pease, Chicago, Drawing Instruments.  | Whatmans Imperial and Double Elephant Papers. | Tracing Paper.             |
| Slide Rules. K. & E.                  | Imperial Size Detail Paper.                   | Tracing Cloth.             |
| Superite and Autopoint Pencils.       | Strathmore Illustration Board.                | Jack Knife Ruling Pens.    |
| Architects' Scales and Supplies.      | Crane's Jap Linen Paper.                      | Drawing Pencils.           |

# Engineer's Co-Operative Society

Boneyard and Mathews

S. R. Lindley, Manager



# OCTOBER CONTENTS

Volume XXXIV Number 1

MODERN ELECTRIC LOCOMOTIVES.....	1
<i>J. W. Leeming</i>	
THE HUDSON TUNNEL VENTILATION PROBLEM.....	4
<i>A. C. Willard</i>	
FACTORS NECESSARY FOR ENGINEERING SUCCESS.....	8
<i>I. O. Baker</i>	
THE POWER PLANT BOILER METER.....	11
<i>H. D. Rosendale</i>	
100,000 LB. HYDRAULIC TESTING MACHINE.....	16
<i>B. W. Benedict</i>	
MAKING OF CLAY SILO BLOCKS.....	19
<i>J. T. Hutchinson</i>	
COL. WARREN R. ROBERTS.....	20
<i>M. E. Jansson</i>	
EDITORIALS.....	22
MANUFACTURE OF PORTLAND CEMENT.....	24
<i>H. C. Marlin</i>	
THE DEVELOPMENT OF A PEAT BOG.....	26
<i>R. M. Bagg</i>	
MODERN STREET LIGHTING.....	29
<i>E. H. Waldo</i>	
DEPARTMENTAL NOTES.....	32
ALUMNI NOTES.....	36
ONCE-OVERS.....	38

1914

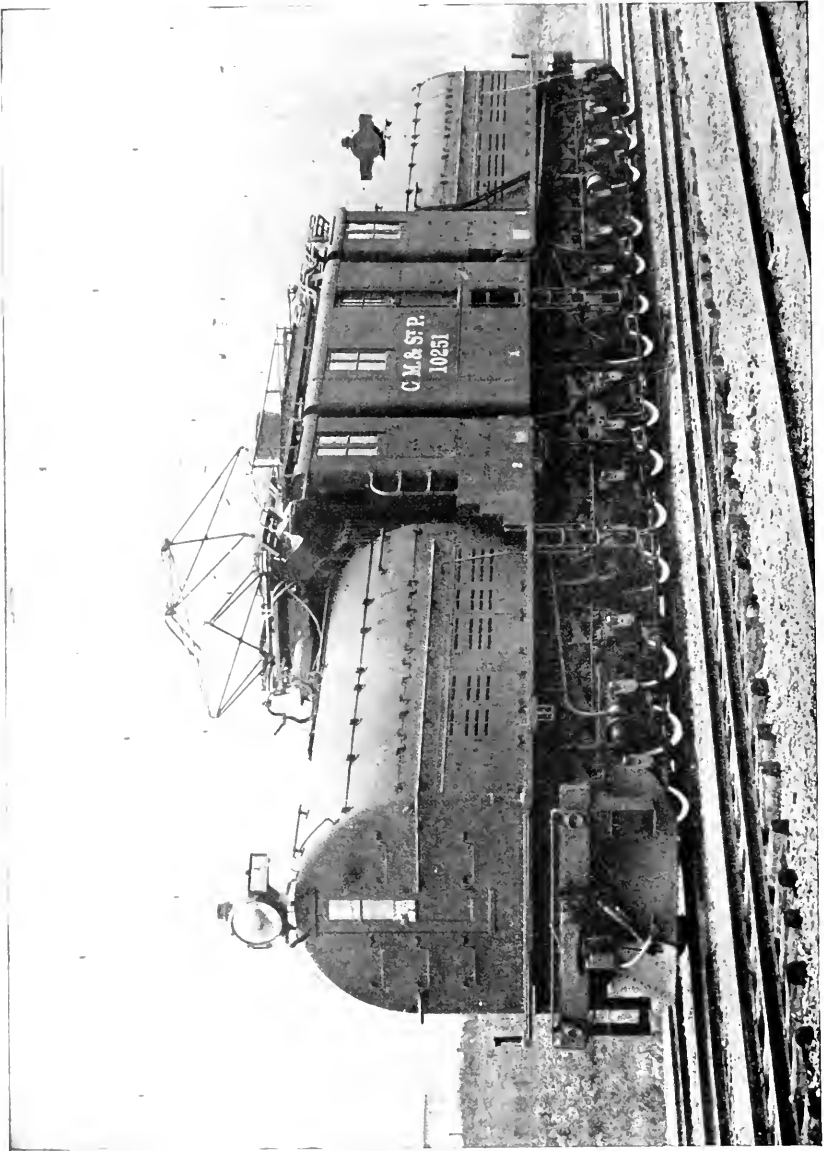



# Modern Electric Locomotives

By JAMES W. LEEING Ry. e. c. '21

One of the most important problems that confronts railway engineers at present is the necessity of meeting the increasing demands of freight and passenger service. The limit of steam locomotives seems to have been reached and some radical change will have to be made if the railroads are to keep pace with the demands upon them. Electrification has solved this problem in the cases of terminals, tunnels, and heavy grades, and it seems probable that it will have to be used on many trunk lines. The longest electrification at present is found on the Chicago, Milwaukee & Saint Paul system, where the limit of the track and motive power was reached about ten years ago. The limit was reached on some 110 miles of this main line track, due to heavy mountain grades and extreme weather conditions in winter time.

In this article I shall consider only such heavy traction electric locomotives as are used on the electrified portion of the Chicago, Milwaukee & Saint Paul. They offer the best examples because of the length of the electrification and the heavy service involved. The question of whether these locomotives are giving satisfaction or not is best answered by the electrification of some 200 miles more of trunk line service. It does not seem improbable, considering the success of this electrified division, that future trunk line electrifications that are bound to come, will follow much the same general principles of design.

Before giving any discussion of the electric locomotive in comparison with the steam locomotive, it must be understood that the two machines have vastly different qualities. The steam locomotive is a unit in itself; that is, it not only uses power, but it generates this power itself. The electric locomotive does not generate power, it is merely a translating device receiving energy from an outside and remote source and converting it into power. Naturally the electric power house has a much larger capacity than a steam locomotive can possibly have and this allows the electric locomotive to exert a tractive effort of two or three times its normal rating for a short duration of time. Also, by means of the multiple-unit control, as many electric locomotives as are necessary can be coupled together and operated by one crew from one cab.

It is impossible to give any general comparison of the efficiency of the two systems because the factors involved in each case vary over wide limits.

It is safe to say that where the cost of electric power is low and the cost of coal high, the electric locomotive has the advantage. The big disadvantage of the electrical system for moving trains is that the steam system is already used. The cost of installing an electric system on a steam railroad varied from \$25,000 to \$50,000 per mile. Where a road of any length considers electrification, the initial cost runs up into the millions of dollars. However, the amount of electrified steam roads has grown until in 1910 about one half of one percent of all railroads in this country was electrified.

The original locomotives used on the Chicago, Milwaukee, & Saint Paul railroad were of the articulated type; that is, they were really two locomotives connected by a flexible joint. They had a total weight of 295 tons, and the motors were connected two in series giving a voltage of 1500 volts per commutators. The power was transmitted from the armature of the motors to the axles by means of a gear and a pinion much the same as in common use on the present day street cars. Although these locomotives were of a much heavier type than have heretofore been built, they gave very satisfactory service and increased the number of trains that could be moved over the electrified division by nearly twice the amount that could be handled with the latest steam locomotive.

It should first be understood that the main disadvantage of the steam locomotive is the high cost of track maintenance. This is due to the reciprocating action of the connecting rod which gives the locomotive a nosing motion. The reason for this is that when the right hand rod is forced back, the front of the locomotive is pushed against the left hand rail, and vice versa. The blows delivered to the rails by this nosing action have been tested and found to be as high as eleven tons. To the average person this seems a very slight difficulty to overcome in the electric locomotive. One might say, "Gear the armature of the motor to the axle." A more detailed study of the problem, however, brings to light the fact that there are many difficulties to be overcome.

In general, the peripheral velocity of the armature should not be more than 7000 feet per minute, and this makes it necessary to have as long an armature as possible in order to gain a given amount of power without increasing the diameter of the armature itself. However, the standard gauge allows a

length of only four feet eight and one-half inches; and when the motor is mounted between the wheels, and the commutator bearings, gears, etc. are accounted for, the armature core can only be about a foot long. If the motor should be placed on the floor of the cab, there would have to be a large amount of play in the gears in order to allow for action of the springs, and the gear wear would be extreme. The problem stated amounts to this: To overcome the disadvantage of side rod construction, the motor should be placed between the wheels, and this would involve the use of a large number of comparatively small motors.

The General Electric Company has eliminated the space required for the gears by mounting the motors directly on the axle, but this type of construction requires the same number of driving axles as motors. In order to gain the required horse power on these locomotives, twelve motors are employed, making a total of twelve driving axles. The big advantage in this type of design is the simplicity of mechanical construction, which eliminates all gears, armatures, and suspension bearings, jack-shafts, side-rods, or other transmission devices. The weight of the armature and wheels is the only dead weight on the track, and this amounts to 9500 pounds per axle.

This type of design has two distinct advantages over the geared locomotive. It has a much higher efficiency at speeds over thirty miles per hour, and the general maintenance cost is lower. It is clear, however, that if a locomotive of this type should break an axle, the replacement cost would be enormous. The motors are of the bi polar type and the two fields are supported upon the truck springs with full freedom of vertical play of the armature between the pole faces. For full speed operation, the motors are connected three in series, giving a voltage of 1000 volts per commutator; control connections are provided for operating four, six, or twelve motors in series, and additional speed variations are obtained by tapping the motor fields in all combinations. Cooling air for the motors is supplied for each motor by a small motor-driven blower.

This locomotive has a weight of 158,000 pounds on the drivers and will pull a twelve-car train weighing 960 tons up a 2% grade at 25 miles per hour. This required a tractive effort of 56,500 pounds, which is the equivalent of a coefficient of adhesion of only 12.3% of the weight on the drivers. Under average conditions, the coefficient of adhesion will run up to 30%, leaving a safe margin for slippery rails, or a large overload capacity. This locomotive has a starting tractive effort of 115,000 pounds, with the coefficient of adhesion of 25%; and in starting on a 2% grade, it has an acceleration of

nearly one half mile per hour per second. This acceleration gives it a speed of 30 miles per hour in one minute starting on a 2% grade.

The Westinghouse Company has solved the problem of connecting the armature of the motors to the driving axles by using what is known as the quill drive. This is a flexible-gear drive, the quill consisting of twelve triangular projections on the gear wheel. This gear wheel is not solid with the axle, and the seven projections on the gear fit into spaces which are cut in the surface of the driving wheels. With these spaces cut in the drivers, the wheels have the appearance of having spokes. Between these "spokes" in the drivers and the projections on the gear wheel that fit in between them, there is a space of about one and one-half inches. A nest of springs is placed between these projections and the spokes, and this gives a little play between the driving wheels and the armatures of the motors.

In order to reduce the number of driving wheels to a minimum, the Westinghouse Company has used a twin-armature motor. In this type of construction, the two armatures have what might be called one field, since the two fields are cast in one solid block. On the end of each armature is placed a pinion, and two pinions mesh with each gear. This connects two driving motors with each driving axle. There are six twin-armature motors or the equivalent of two twelve single-armature motors for each locomotive.

Two of these twin-armature motors are connected permanently in series giving a voltage of 750 volts per commutator or slightly more than the voltage impressed per commutator on the average street car. In this way, the problem of insulation is much simpler and the sparking at the brushes is greatly reduced. The Westinghouse motor combinations are: (1) All six in series, (2) Three motors in series, two in parallel, (3) Two motors in series, three in parallel. The suspension of the twin-armature motor is made much in the same way as with the ordinary street car motor except that it is more symmetrical; that is, the axle is passed through the motor frame just below the center of the twin-motor armature frame instead of being placed to one side of the motor, as in the case in street railway practice. Each motor is supplied with air ducts through which air can be forced for cooling the motors when working on heavy grades or when pulling extremely heavy loads. The cooling action of the air gives the motor the continuous rating of 40% more of forced ventilation than with natural ventilation.

The arrangement of driving wheels and pilots is somewhat different in the case of this locomotive than in the case of the General Electric Company

locomotive, the wheel arrangement being that of two Pacific type locomotives. Reading from one end to the other we have: four pilot wheels, six drivers, two pilot wheels, two pilot wheels, six drivers, and four pilot wheels. This arrangement cuts the number of driving wheels in half with the same number of axles and consequently more weight is centered

be coupled together and operated simultaneously. With a master control, the main line voltage is not connected to the controller as in the case of street car controllers. All the main line switches are actuated by air pressure, and the valves that control this air pressure are operated by the master controller. By means of this device the motorman is not



on each pair of driving wheels. It remains to be seen how this system of arranging the driving wheels and motors will compare with that of the General Electric Company, as there are advantages and disadvantages of each.

The capacity of this locomotive is 66,000 pounds tractive effort for a one-hour rating, or a continuous tractive effort of 49,000 pounds. With a coefficient of adhesion of 33%, the tractive effort of the locomotive will be 112,000 pounds, which will require 50% more current than is used in the one-hour rating. These figures for tractive effort are nearly as high as in the case of the General Electric Company locomotive and are considerably higher than the power requirements that were specified in the contract with the Chicago, Milwaukee, & St. Paul railroad.

Both locomotives are equipped with master controllers; that is, any number of locomotives may

be exposed to the high voltage of the line, and the size of the controller is greatly reduced.

Another great advantage of the electric locomotive is in the regenerative system of braking. The two main factors in regenerative braking are: a positive system of braking independent of the air brakes, and a higher efficiency on long grades. In order to understand the principles of regeneration, it must be clear that the electric motor is merely a translating device; it can receive energy and transform it into work, or it can transform work into energy. In the case of regeneration, the momentum of the train is absorbed by the motors to produce electric energy, and this is returned to the trolley.

In order to "pump" power back into the line, the braking system must generate a higher voltage than the line voltage in much the same way that in order to pump water back into a reservoir it is

(Continued on Page 37)

# The Hudson River Vehicular Tunnel Ventilating Problems

A. C. WILLARD<sup>2</sup>

Head of Department of Mechanical Engineering

The University of Illinois has recently completed the investigation of the frictional losses which must be overcome in moving large volumes of air at relatively high velocities through concrete ducts and elbows. The ducts and elbows were half scale (one quarter area) models of the bottom air supply

Jersey Interstate Bridge and Tunnel Commissions. The Engineering Experiment Station, of which Dean C. R. Richards is Director, represented the University, and the Station will have the right to make the initial publication of the results in an Engineering Experiment Station Bulletin. The Bureau of Mines operated through the Pittsburg Station, of which Mr. A. C. Fieldner is Acting Superintendent, and all work was under the general supervision and control of Mr. C. M. Holland, Chief Engineer of the Tunnel Commissions of New York and New Jersey. The active prosecution of the work was carried on by a technical staff made up of engineers from the University, the Bureau, and the Tunnel Commissions, which numbered from six to twelve men, the number varying with the character of the work to be done.

The problem as taken up by the University was divided as follows:

1. The determination of the coefficient of friction of air flowing in concrete ducts of uniform sections,
  - (a) When all the air goes all the way through the duct and out at the far end.
  - (b) When the air is removed uniformly through ports along the side of the duct and the far end is closed.
2. The measurement of the friction losses in concrete elbows similar to the special compound elbows in the actual tunnel.
3. The determination of the difference in power required to blow air into the lower tunnel ducts as compared with the power required to exhaust air from the upper tunnel ducts. In both cases, the same quantity of air was to be handled.

*Note:*—In all cases the amount of air to be handled was definitely known from tests previously

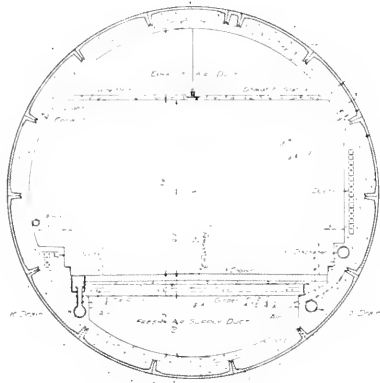

CROSS SECTION  
Fig. 1.

duct and the main down-cast elbows of the proposed Hudson River Vehicular Tunnel, which will run from Canal Street in New York City to 12th Street in Jersey City.

The work was done under a co-operative agreement between the University and the U. S. Bureau of Mines, which is investigating the general subject of mine and tunnel gas through another co-operative agreement with the New York State and the New

<sup>2</sup>Consultant on Ventilation for the Tunnel Commissions.

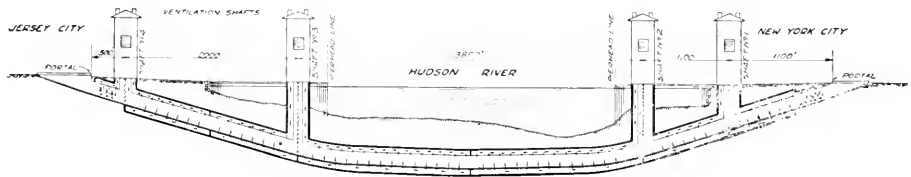

Fig. 2. Elevation of Hudson River Tunnel

conducted by the Bureau of Mines.

In order to understand the problem, the general scheme of ventilation which has been decided upon for the actual tunnel must be briefly explained. A cross section of one of the tubes in the under river portion of the tunnel is shown in Fig. 1. It

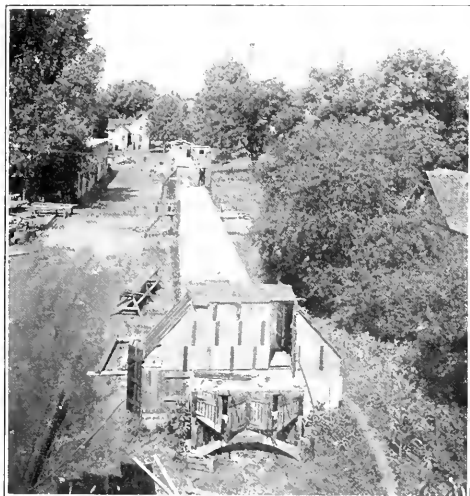

Fig. 3 Model Tunnel

will be seen that the middle portion of each tube provides a roadway 20'-0" wide by 13'-6" high for the movement of two parallel lines of motor vehicles proceeding in the same direction. The north tube takes two lines of west bound traffic and the south tube two lines of east bound traffic.

Fresh air is supplied to the duct below the roadway by blower fans located in four towers (Fig. 2) which are placed as nearly over the tubes as possible making 16 supply units. The vitiated air is removed by exhaust fans placed in these same towers making 16 more units. As all equipment is in duplicate, a total of 64 units will be required. The vitiated air comes from the roadway where the motors are discharging their products of combustion, which include a considerable percentage of the very poisonous gas carbon monoxide. It will be evident that the fresh air supplied to the roadway from the lower duct through numerous inlets serves to dilute the products of combustion as rapidly as they are generated. The proposed scheme of ventilation is designed to maintain a concentration in the air of the tunnel roadway which will be harmless to individuals. The safe concentration has been found to lie between 3 and 4 parts of carbon monoxide in ten thousand parts of air. The experimental work at the University of Illinois has, therefore, been

based on air quantities which will secure this concentration when about 1000 cars per hour are using the tubes. This is the maximum traffic rate considered feasible, and there will be required a total of over 3,600,000 cu. ft. of air per minute at such times.

The cost of power required for supplying this amount of air through ducts of the size and shape shown in Fig. 1 for a tunnel which is more than 8500 ft. in length must be determined in advance, and may easily amount to \$300,000 or \$400,000 per year. This power cost is one of the principal operating expenses. Moreover, the selection of the proper ventilating equipment such as fans, motors, speed control and method of connecting or driving the fans depends not only on the amount of air, but also on the pressure heads to be overcome in moving this air in the various parts of the tunnel ventilating system. No definite specifications can be written until this information is available.

It was for the purpose of securing such data

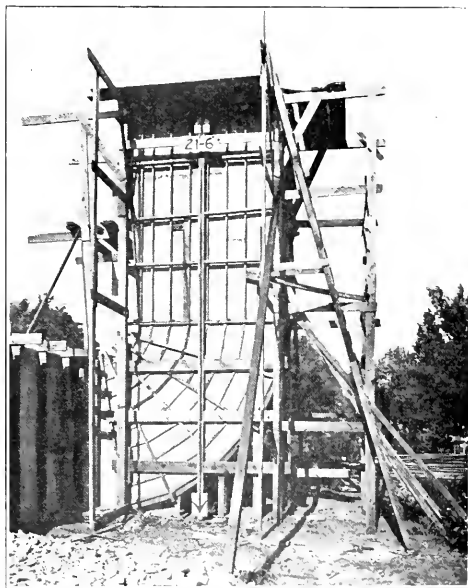

Fig. 4 Special Elbow

from an experimental model of the tunnel air ducts that some 300 tests were made at the University of Illinois between April 1 and August 1 of this year. The experimental model duct is shown in Fig. 3, and the special elbow in Fig. 4. Air was supplied by a multibladed double inlet fan capable of delivering 105,000 cu. ft. of air per min. against a total head of 5" water gage. This fan was belted to a 300

horsepower motor, and during many of the tests the full capacity of the motor was required, as air velocities of practically 6,000 ft. per minute were maintained on some of the tests.

The experimental data included velocity and static pressure readings at three pressure measuring stations spaced 115 ft. apart along the duct, as shown in Figs. 5 and 6. From these data it was possible to calculate the velocity and volume of air flowing at any station. Prof. V. S. Day was largely responsible for the detailed design and installation of the equipment in these stations. A traverse was made (See Fig. 6 Traversing Apparatus) using twenty points across the section of the duct and

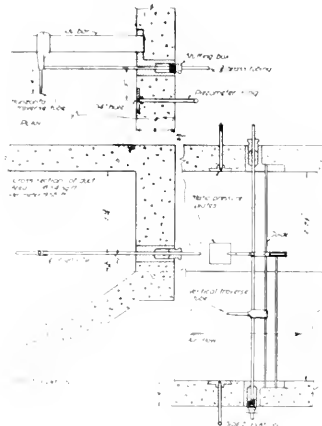

Fig. 5 Pressure Station

from the velocities computed for these twenty points the average velocity for the station was found. In order to find the coefficient of friction at any velocity of air flow, it was necessary to have the static pressure or friction pressure loss between the first and last stations, when air was flowing through the duct at the desired velocity.

The computation for coefficient of friction was then made as follows:

$$h = f \frac{L P}{A} \frac{V^2}{2g} \frac{12d}{k} \quad (1)$$

$$\text{or } f = \frac{h A}{L P} \frac{2g}{V^2} \frac{k}{12d} \quad (2)$$

These equations hold only when all the air goes all the way through the duct and out at the end.

The significance of the terms used in the above equations is: -

- f = coefficient of friction
- h = static pressure difference between Sta-

tions 1 and 3, or for a length L, in inches of water.

- L = length in feet between Stations 1 and 3.
- P = perimeter of inside of duct in feet.
- A = mean area of duct in sq. ft.
- V = mean velocity of air flowing in ft. per sec.
- d = density of air in lb. per cu. ft.
- k = density of water in lb. per cu. ft. used in manometers.
- g = acceleration in ft. per sec. per sec. gravity.

All of the above values except (f) were either measured direct or readily calculated from test data.

It will be evident that with values of (f) known the calculation of the horsepower required to supply air through such a duct is a very simple matter if all the air goes all the way. Case I of Fig. 5. The values of (f) change with the velocity of flow and size and shape of duct, and hence, a great many tests were run to cover all conditions which will exist in the tunnel ducts, and coefficient of friction curves similar to that shown in Fig. 7 were drawn covering all cases. Since all the air does not go all the way in the actual tunnel ducts, but is allowed to escape uniformly along the sides of the ducts it was necessary to run many tests for this condition also, in order to determine what initial head was necessary to supply the proper amount of air and overcome the duct resistance. Case II of Fig. 5. It was found that the total head at entrance (total head = velocity head + static head) in this case was much less than in the first case. This was due to the fact that as the air stream proceeded along the duct, both the quantity and velocity of air moving was decreasing toward zero. In other words, the velocity head which existed at the entrance to the duct was practically all available for overcoming friction in this case, since no velocity existed at the very end of the duct at all.

It is, therefore, possible to calculate the total head for an air duct with open ports by either of two methods.

(a) Determine experimentally the ratio between the total heads required for a duct with closed ports and end open of given section and length and for the same duct with open ports and closed end. In both cases, the same amount of air must be handled. Then using the coefficient of friction, also experimentally determined on the model duct, calculate the friction head for the actual duct by equation (1), and add to this the velocity head. This must then be multiplied by the ratio between the total heads, which was found by test for the model ducts of these same proportions and rates of air flow.

(b) The second method is to derive from the

fundamental equations of flow an expression for total head on the assumption that the total head is all available for overcoming friction in the duct. This may be done by expressing the coefficient of friction as a function of the velocity. Since, in the blowing case, the velocity at any section varies inversely with the distance of that section from the entrance, it is possible to write a differential equation, which integrated gives directly an expression

for total head in any duct used in the tunnel. A mathematical analysis of the problem has been made in inches of water, it is a simple matter to express all elbow losses as a function or a percentage of the velocity head in the straight pipe discharging into the elbow. It is also possible to express the head lost due to elbows as equivalent to a given number of feet of straight pipe of the same cross section as the pipe entering the elbow.

**Computations for Power Required to Operate Ventilated System of a Typical Section. (Blowing Side)**

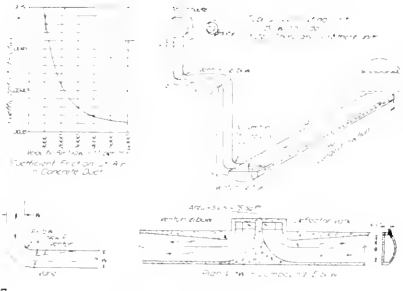
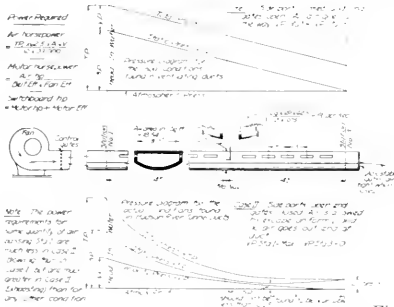

Figs. 6 and 7

by Professor G. A. Goodenough which has been applied to the results obtained on the experimental model with complete success, as the computed and observed heads agree.

Another important part of the work was the study of friction losses in elbows of various radii for a wide range of air velocities. The pressure losses in such turns may be very large and completely defeat the purpose of an otherwise successful ventilating system. This part of the problem was first carefully studied by using small laboratory models of galvanized iron, the proportions of which could be readily and accurately varied to cover all conditions existing in the actual tunnel ducts. Professor A. P. Kratz carried out this part of the investigation, in which it was shown an elbow, Fig. 7, which must be turned with a very small throat radius will have its friction losses materially reduced if the departure end is made of Venturi shape. The use of a deflecting vane was also found of real value. See elbow detail shown in Fig. 6.

The compound elbow shown in Fig. 6 was considered so important that it was finally built to half scale of concrete (Fig. 4) and tested as part of the experimental duct system. The head lost in this compound elbow with a deflecting vane inserted was then accurately measured in inches of water for all velocities of air flow which will be used in the actual tunnel. Since these velocities can readily be expressed in terms of an equivalent head

The significance of the work done at the University of Illinois is best shown by a consideration of the method of finding the power required to supply the air to one section of the tunnel. A somewhat similar method is followed in dealing with the exhaust system for this same section, but this latter case is decidedly more complicated, and the power requirements are much greater than for the blowing case. The experimental work covered the exhaust system in detail, but it is not considered in the present discussion.

The oblique diagram shown in Fig. 6 represents a typical river section with its fan and motor. Air enters the fan and is discharged through the concrete duct system (a, b, and c) into the lower duct (d) below the roadway. After entering this duct, the air is allowed to escape uniformly through the side ports (Fig. 1) which are so adjusted by shutters that each port delivers the same volume of air. No air can pass beyond the bulkhead at the end of the duct.

The total head required at the fan is then:—

(1) Friction loss expressed in inches of water in the rectangular duct (a, b, c,) which is approximately  $5' \times 15'$  inside,  $h_f = f \times \frac{L P V^2}{A 2g k}$  same

as equation (1) except (L) may include equivalent length for the elbows in this duct. The value (V) (Continued on Page IV)

# Factors Necessary for Engineering Success

PROF. I. O. BAKER '87

*Head of Department of Civil Engineering*

In the last few years there has been a rapid and radical change of attitude on the part of engineers as to the elements of education and character necessary for the highest professional success. In the early history of engineering, say a little over a generation ago, many engineers believed that it was impossible to teach in college anything valuable concerning the practice of engineering; but gradually the colleges demonstrated the falsity of this assumption, until, in recent years the college graduate has almost dominated the engineering profession. With the increased development of college education have crept in some unfortunate ideals; and recently there has been a general disposition of the profession to change these standards.

In recent years, the consensus of opinion of the engineering profession has been that the engineer has failed to receive the recognition in society, in industry, and in government that the time devoted to his professional preparation justified and the importance of the matters committed to his charge seemed to demand. If the citizens of a town are called together to consider the installation of water works or a system of sewers, the lawyer and the doctor, the preacher and the editor have been called upon for their views, but seldom under such circumstances has the engineer been asked to speak to his fellow citizen, even though the subject under consideration was primarily an engineering matter. Again, engineers quite generally complain that the salary in their profession is not commensurate with that of the lawyer, the dentist, or the doctor. Further, engineers frequently call attention to the fact that although railroad commissions and public utilities commissions deal with matters relating primarily to engineering affairs, there is seldom, or never, an engineer appointed on such commissions, or on the interstate commerce commission. These facts are part of the evidence that has led engineers during the last few years to attempt to radically change the status of the profession.

In view of these facts, perhaps it is well that we would inquire whether there are any corresponding changes needed in the attitude of engineering educational institutions and of engineering students.

What are the most important elements that contribute to the success of an engineer? They can be included under five heads, viz.: (1) technical ability, (2) breadth of knowledge, (3) initiative, (4)

executive ability, and (5) ability to write and speak clearly and forcefully.

1. TECHNICAL ABILITY. Apparently, in the past at least, the chief aim of the engineer has been to perfect himself in technical details. In this particular, the colleges have been most to blame. Many, if not most, engineering instructors have been impressed with the magnitude of the field of engineering knowledge, and have made it their chief aim to impart to their students what they believed to be



Professor Ira O. Baker

the technical information needed in their future work. Therefore, the sole purpose of the engineering student has been, naturally and almost universally, to acquire facts about his chosen profession.

I have just intimated that by common consent engineers have agreed that one of the mistakes in the past, both in college and out, has been that of considering the sole aim of the engineer to be the acquisition of technical details; and as I have already explained, the profession is now seeking in various ways to overcome this handicap.

What may the engineering student do to correct this mistake? First, he must be thoroughly convinced that the mere accumulation of technical



information has little or no educational value. He should never over-look the fact that the power to observe closely, to reason correctly, and to state clearly are of vastly greater importance than any amount of technical information; and he should not forget that engineering facts without these qualities are absolutely useless. Technical details speedily get out of date; but these fundamentals of an education are never out of date, and are always valuable whatever a man does. Of course, there must of necessity be some intellectual development in the acquisition of technical information; but the student should continually seek to get the maximum educational value as he acquires technical details. He should seek to understand the relations between the facts and fundamental principles, should inquire the reasons for the particular practice, and determine whether it is general or due to some limiting condition of time or cost. He should regard his study as a test of how quickly and certainly he can acquire the significant facts from the printed page; and in reciting he should take pains to see how clearly, fully, and orderly he can state his facts.

Of course, the engineering student must study technical matter, for that is what distinguishes the engineer from other professional men; and his study is the instrument or the means by which he develops his intellectual faculties. The cultivation of the mental powers is the most vital element in an education. It alone confers that power which masters all it touches, which can adapt old forms to new uses, or create new and better means of reaching old ends; and without this power the engineer can not hope to practice his profession with any considerable chance of success. The thing to be sought above all things else is the formation of correct habits of thinking and working, habits of observing, of classifying, of investigating, of understanding, of getting clear and distinct ideas, of proving instead of guessing, of weighing evidence, and of doing thoroughly honest work. The power to acquire information, and the knowledge of how to use it, is of far greater value than any number of the most useful facts.

2. BREADTH OF KNOWLEDGE. The second factor I mentioned as necessary for a large success of an engineer is breadth of knowledge. The engineer should understand at least some of the fundamentals of economic problems, of social conditions, of political questions, of legislative action, and should know something of the subtle relations of labor and capital, of the factors affecting international trade, and of other questions that form the subject of the thinking and conversation of his business associates and of other professional men. If the engineer is found seriously lacking in knowledge

of these subjects, the layman considers him an ignorant man.

As a rule, and almost without exception, engineering students have sought to give all of their time to technical matters to the exclusion of the study of such subjects as language, history, economics, political science, and sociology; and usually when really compelled to take one of these subjects, he does it reluctantly and half-heartedly, and consequently does not get much out of it. An engineer must live with other men; and in his ordinary conversation he will be judged largely by the breadth of his knowledge. If an engineer in ordinary conversation has no opinion concerning some of the vital questions of the day, such as the relations of labor and capital, or the new federal law concerning the water-power development, or the questions pending before the national railroad labor board, then intelligent men will not be interested in cultivating his acquaintance, and will conclude that he is not a man of force or vision, and consequently his position as an engineer will suffer.

What can an engineering student do to broaden his knowledge outside of technical matters? Frankly, I say not very much while in college; but while still a student he can make up his mind that these matters are important, and he can begin by giving increased attention to such discussion of these subjects as he finds in the ordinary newspapers. At first, he will get only a confused idea from such readings; but by persistent effort the leading principles will gradually emerge from the haze, and he will begin to understand something about these questions. Incidentally, such reading will be of inestimable value in teaching him to weigh evidence, to sift the wheat from the straw, and to discriminate between the true and the false. Unfortunately, most of the engineering student's work at college has been to deal with absolute truth, and all he has been expected to do was to accept on faith the principles stated. But when he gets out into actual life, he will find that the principles with which he has to deal are entangled with opposing views; and it will require great insight and patience and perseverance for him to acquire that point of view which he believes to be the wise or the correct one. However, the doing of this is itself a valuable part of any man's education, and particularly of an engineering student who has devoted most of his time to the study of absolute truth.

One of the best means of broadening his horizon is to regularly and systematically read a good technical journal; but an engineering student, in addition to keeping an eye on the less transient and less ephemeral articles of a good daily paper, should also read the political and governmental and finan-

cial articles in at least one of the standard monthly magazines.

3. **INITIATIVE.** The third important factor in the preparation of an engineer is initiative. The most successful engineer must have the ability to devise new solutions for an old problem, the power to discover new methods of accomplishing results, the capacity to find ways and means without waiting to be told. Without the power of initiative, the power of self direction, no one can hope to be trusted with large responsibility. Men who are at the head of great enterprises and who carry large responsibilities are always looking for those who have initiative; and not infrequently they choose the uneducated man, or perhaps I should say the un-schooled man, who has the power of initiative, in preference to the college trained man who does not have this quality.

How may an engineering student cultivate initiative? Here is one way. If he has a problem which baffles him, he should not be content to lay it aside with the expectation that the instructor will explain it at the next recitation. But he should regard such a problem as a challenge to his intellectual power, to his ability to overcome obstacles; and he should earnestly, even enthusiastically, wrestle with the difficulty until he has overcome it. Not infrequently the student says that he does not have time to wrestle with such problems, but that when he has been graduated, then he will cultivate that element of his character. But if the student in the formative period of his life has postponed such contests, he loses the power that would come to him through progressive tussling with such problems; and he finally loses even the desire to accept such a challenge. The student who side-steps such problems in college will continue to side-step them in after life; and thus will lose the opportunity for the largest success, and will become virtually only a hewer of wood and a drawer of water in the engineering profession.

4. **EXECUTIVE ABILITY.** The important factor in the success of an engineer is executive ability, the ability to direct the work of others. A good executive is a man of initiative and self-reliance, but he is also one who understands other men, and who knows how to secure their hearty cooperation. This requires tact, patience, perseverance, courage, the ability to judge men, a knowledge of character, and an understanding of motives. The engineer does not usually give heed to these matters; and this is one reason why he is seldom advanced to the higher administrative positions. Administrative officials are always looking for men who will help them carry their load; and the pay is invariably comparatively high because such men are relatively

scarce. Many high priced positions in the engineering field are held by non-engineers because no engineer could be found with the necessary executive ability.

How may an engineering student cultivate executive ability?

One way is to attend the meetings of your technical society, and rub elbows with other engineering students and learn to participate in team action. Study your fellow members to learn their characteristics, their motives, their methods, their points of view. A chief factor in the success of an executive is his ability to judge men; and in the technical society is a good place to cultivate this important element. Of course, in a fraternity one can learn something about his fellow students, and may study their characteristics; but not to so great an extent as in the technical society nor so much about the engineering features of their character. Some of you may think this matter one of small importance, but I beg you to remember that our lives represent the sum total of all the influences that have acted upon us; and I assure you that the people we associate with goes far to determine our own character and ambitions, and also that the study we give to those we meet is an exceedingly important part of our own education if we really desire a large success. If we hope ever to occupy an executive position of responsibility and trust, we must use every opportunity to prepare for it. The work in the recitation room is of little or no help in cultivating executive ability. A second way to cultivate executive ability is to secure office in a class or fraternity organization or in a technical society, and then discharge the duties of the office in a thoroughly efficient manner.

5. **ABILITY TO WRITE AND SPEAK.** Fifth, and last, I come to the consideration of one of the most serious of all the mistakes engineers have made in the past. The engineer, in college and also after graduation, has been so intent upon perfecting himself in technical details that he has neglected the means of communicating his thoughts by writing or speaking to his fellow men. The engineer, if he is to attain to any considerable prominence or influence in his community, must do business with other men, must write letters, must make reports, must prepare contracts, must explain plans, must give testimony in court; and unless he has acquired the ability to express his thoughts in clear and forceful English, he can not influence others to accept his views, or convince others that he is an intelligent or educated man. Other men are not able to judge him by his technical attainments, but do judge him almost wholly by his ability in writing

(Continued on Page 31)

# The Power Plant Boiler Meter

H. D. ROSENDALE, M. E. '22  
*First Place in Summer Article Contest*

I do not think that there will be any objections or criticisms to the statement that the benefits derived from summer work by a student depends upon two things: his fate in becoming located in interesting or uninteresting work, and the amount of conscientious effort expended by him at the work. I can not say much about the benefits that I derived from the latter source during the past summer's work, for the periods of my "conscientious efforts" were rather intimately mixed with periods of idleness which were due to the general lack of business. But as for my fortune in becoming located, I have much to say.

It was my good fortune to be accepted by the Bailey Meter Co. of Cleveland, O., for work in their Junior Cadet Course for the period of the past summer. I can say without hesitation that it was the most profitable and interesting summer that I have yet spent, for it gave me a fairly good survey of the power plant field, the field I intend to work in after graduation. The Course was open to Junior Mechanical Engineering students only, and was intended to familiarize the Cadets with the various phases of the work. It is to be supplemented the following summer by the Senior Cadet Course for those who elect to return. Upon completing the last named course, the Cadet will be ready to act as a Service Man, one who installs the meters in the power plants. This work requires a very thorough knowledge of the construction and calibration of the meters, and also an understanding of the conditions affecting their operation.

To fit a man for this work, the company employed what to my mind was a very expedient method. Each Cadet spent about two weeks in each of the various departments moving from one to another as long as time permitted. In each department he was able to become familiar with the work performed, the operations involved, and the difficulties encountered, by actually performing the work himself. The method of "learning by observing" did not find a place in the course. In this way the entire summer was spent; in interesting, instructive, ever-changing work absolutely devoid of monotony.

In addition to the work, the Cadets were given three lectures a week. One lecture every week, which was delivered by the President of the Company, was given over to the analysis and discussion of the charts of the meters and to the enlightenment

of the Cadets as to the power plant conditions which had a bearing on the operation of the meters. As the President was very familiar with modern power plant practices, and had also gained much valuable experience through actual work in various plants, these lectures were intensely interesting and instruc-

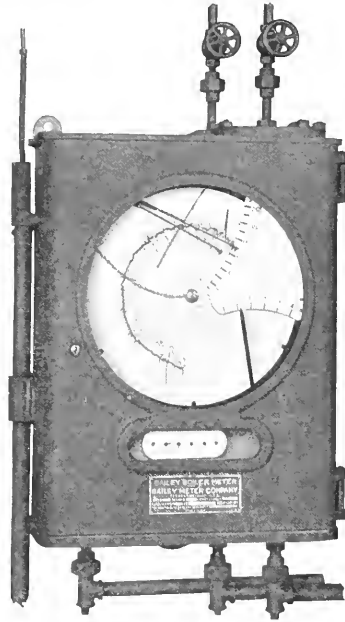

Fig. 1

tive. The other two lectures, given by subordinates, also very capable men, were on the construction and design of the meters. These were also very interesting talks, due, in a large sense, to the fact that the meters are rather ingenious instruments and naturally interesting to investigate.

The Bailey Meter Co. are manufacturers of the following power plant instruments or meters.

1. Boiler Meter
2. Fluid Meter
3. V-Notch Weir Meter
4. Gas Flow Meter
5. Draft Recorder
6. Radiometer
7. Pulverized Coal Feeder and Meter
8. Specific Gravity Meter

9. Wood Pulp Meter.

The first two meters listed form the bulk of the company's output, and of these two, the boiler meter is by far the most interesting. The remainder of the article will be devoted, therefore, to a description and discussion of it.

A Bailey Boiler Meter, Type D26, Class 56, will indicate, record, and integrate (or sum up) the steam flow, record air flow and flue gas tempera-

ture, and indicate the fire box draft of a power plant boiler. With this information always at hand, the power plant engineer can operate his plant at maximum efficiency and thus secure maximum capacity with practically no trouble at all.

Anyone acquainted with present power plant conditions who can recall the low efficiencies on which many of them are operating, can readily see that an instrument of this nature giving such information is filling a much felt want. See, then, just how this simple meter performs the task.

Fig. 1. is an exterior view of the meter, and Figures 2 and 3 are interior views, Fig. 3 having the chart and chart plate removed to show more of the mechanism. Figs. 2 and 3 are of the same type of meter, but the meter in Fig. 3 has an integrating device which the other meter does not possess. This device consists of an aluminum disc and a counter

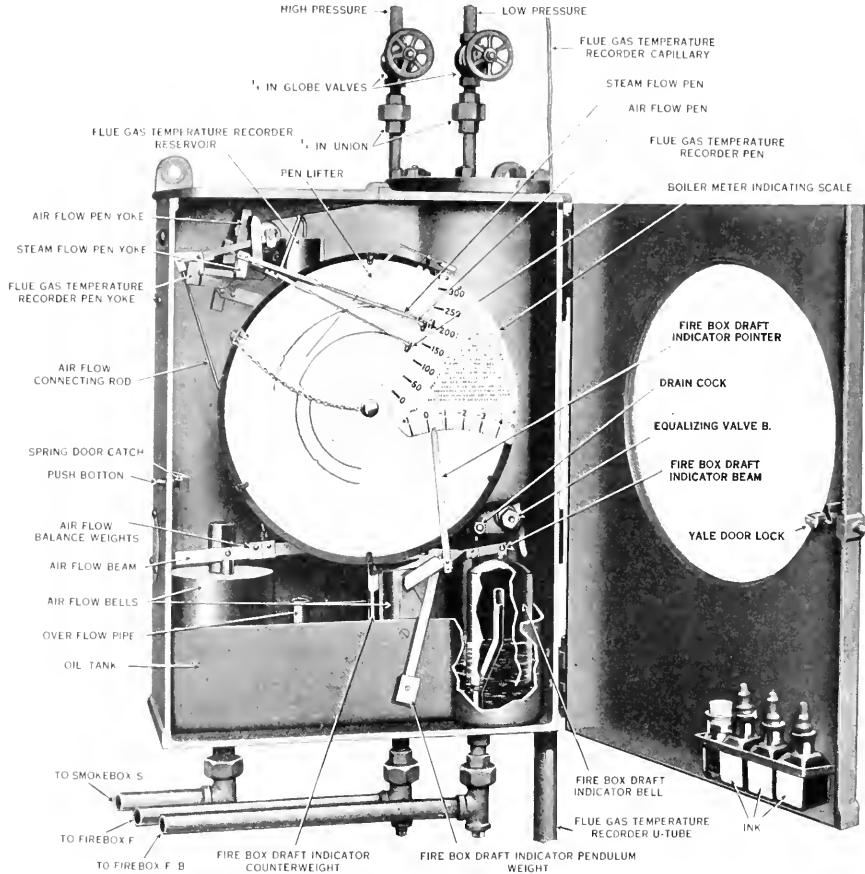

Fig. 2.

ture, and indicate the fire box draft of a power plant boiler. With this information always at hand, the power plant engineer can operate his plant at maximum efficiency and thus secure maximum capacity with practically no trouble at all.

Anyone acquainted with present power plant conditions who can recall the low efficiencies on which many of them are operating, can readily see that an instrument of this nature giving such infor-

shown near the bottom of the figure. It will be discussed later.

Steam Flow Mechanism

This mechanism operates on the pressure differential principle, the differential being obtained by inserting an orifice, made of non-corrosive Monel Metal, in the steam main. This orifice operates on the same principle as the venturi tube. They are designed for various capacities, and when operated

at full capacity with connections made at the proper points, both in front of the orifice and in the vena contracta formed back of the orifice, they will give a pressure difference of about two pounds. In general, about 85% of this pressure difference is restored so that the loss is negligible. Fig. 4 shows the operation of this orifice, and in connection with the diagram below it, it is self explanatory.

Within the cylindrical case on Fig. 3, is the steam flow mechanism. This mechanism is clearly shown the sectional view in Fig. 5. It consists of a mercury reservoir, and a bell whose weight

The differential varies with the square of the velocity of the steam in the main, and the quantity of steam varies directly as the velocity. Therefore, if this square can be extracted in some manner, the motion of the bell and pen will be in direct proportion to the quantity of steam flowing. This is done by making the inside of the bell conform to a carefully determined parabola, and records, therefore, can be made on a uniformly graduated chart. The rate of flow of the steam is simply the chart reading multiplied by a predetermined constant.

It can be seen in Fig. 3 that the long arm attached to the marked counter is connected to the steam flow mechanism by a train of links so that an increase in the rate of steam flow would cause the counter to move to the right. On the rear of this counter mechanism is a small roller wheel which slides over the aluminum disc. It has a number of smaller rollers around its circumference so arranged that as the counter moves backward and forward across the disc the friction is minimized. The disc is driven by the clock and makes one revolution in sixty minutes. The mechanism is calibrated so that the counter will integrate the rate of steam flow. In other words, it will record the total quantity of steam which has flowed past the orifice for any period of time. This integrating device is one of the most valuable features of the meter.

*Air Flow Mechanism*

The Air Flow Recorder operates on the same principle as the Steam Flow, the pressure differential in this case being the draft across the boiler between the firebox and the uptake to the breeching. The pressures at these two points are applied underneath the bells named in Figs. 2 and 3. These bells are sealed in oil and suspended from the end of a bar which swings on a knife edge. The relative motion of these two bells actuates the air flow pen. This transmission of motion can be easily traced in Fig. 3.

The term "air flow" as used in this article is not literally correct, for it does not refer simply to the air supplied to the fuel bed for combustion purposes. It can be seen from the manner in which the pressure differential is secured that the gas measured is the product of combustion; so the term "air flow" really means "flow of the products of combustion". The first term is used, however, due to the length of the latter term.

The setting of the Air Flow, which is done upon installing the meter, is very important, for it is so set that when the steam flow and air flow pens are together, tracing lines which are practically on top of each other, the furnace is receiving the proper amount of air for the most efficient opera-

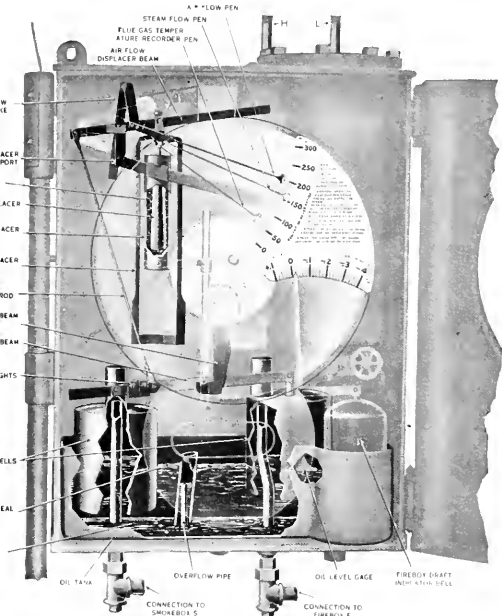

Fig. 3.

is supplemented by a suspended bell weight. The entire casing is filled with water, and the only connections to it are the two pressure connections from the orifice. The pressures are transmitted by means of water filled pipes which have small radiators near the orifice for condensing the steam. The high pressure connection is as can be seen in Fig. 5, so that this pressure is applied underneath the bell. The low pressure connection leads to the casing above the bell so that this pressure is applied to the top of the bell. It can be easily seen, therefore that the bell will rise and fall according to the difference in these two pressures, or the "differential" as it is called. This motion will then actuate the pen labeled "flow pen" in Fig. 5 which will record upon the chart.

tion. When the air flow pen falls below the steam flow pen, there is a deficiency of air, and when it is above, there is an excess of air. This setting is made in the following manner.

The installation or "Service" man, upon conferring with the chief engineer of the power plant, determines upon the proper flue gas analysis for the most efficient operation of that particular plant. After making the Steam Flow connections and getting that mechanism to function, he takes an analysis of the flue gas of the boiler while the latter is in operation. By comparing this analysis with his

in the reservoir "R" in which there is a float connected, as can be seen, to a recording pen. The rise and fall of the mercury level, therefore, will actuate the pen and which will record the flue gas temperature upon the chart.

#### *Fire Box Draft Mechanism*

This mechanism can be seen in Figs. 2 and 3. It consists of a bell and a counterweight suspended from opposite ends of a small bar resting on a knife edge. The bell is sealed in oil in the same manner as the air flow bells. A pipe connection

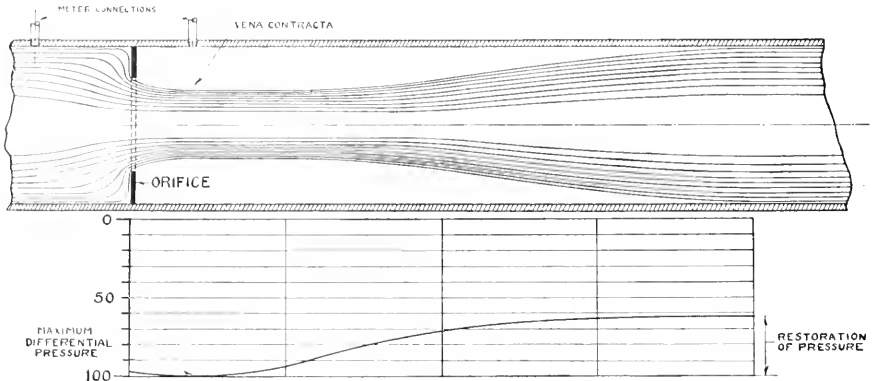

Fig. 4.

calculated, or predetermined, analysis he can determine whether the boiler is operating with the proper amount of air or not. He can then set the air flow pen accordingly. From that time on, the fireman needs only to glance at the relative position of the two pens to see whether the furnace is being supplied with the correct amount of air for the present coal feed and steam production.

#### *Flue Gas Temperature Mechanism*

This mechanism is simply a gas pyrometer. It consists of a number of nitrogen filled  $1\frac{1}{2}$ " seamless steel tubes connected to each other by copper capillary; a mercury U-tube connected at one end to the steel tubes by means of a capillary and terminating at the other end in the reservoir shown in Fig. 2 and 3. The seamless steel tubes are hung on the last pass of the boiler at the opening into the breeching, and they extend across the entire width of the pass. This is the best feature of the apparatus, for the temperature obtained is then an average temperature of the flue gas leaving the furnace.

The operation of the apparatus is very simple. The hot gases leaving the furnace pass by the suspended tubes heating the nitrogen and causing it to expand. As it expands, it forces down the mercury in one side of the U-tube causing it to rise in the other side. This rise in mercury level takes place

to the furnace just above the fire conveys the fire box pressure to the meter, and this pressure, which is less than atmospheric pressure, is applied underneath the bell. The mass of the counterweight is so determined that when this pressure is applied to the bell, the indicator marked "D" will indicate the fire box draft.

The above completes the description of the meter with the exception of the chart. This is operated by the clock which causes it to make one complete revolution every 24 hours. The chart is graduated into hours, and these are subdivided into 15 minute periods so that the condition of the boiler during any past time can readily be referred to by the firemen or engineer.

The Cadets spent the greatest part of their time in the calibration departments, for it is very essential that a man in the field be thoroughly acquainted with this phase of the work. All calibration work in the shop is done with the greatest of care, and tests have been run in various plants that prove the accuracy of the meters.

A complete discussion of the methods of calibrating the Boiler Meter is quite impossible in this article, but briefly it is as follows:

The steam flow mechanism is calibrated by adjusting the weight of the bell, the amount of mer-

cury in the reservoir, and the travel of the pen so the latter will record properly with the bell subjected to the various possible differentials. The differentials are secured by means of two water columns attached to the high and low pressure connections.

until the counter occupies the proper position on the disc to give the correct reading when the steam flow pen occupies various positions on the chart.

The fire box draft recorder is adjusted, of course, by changing the mass of counterweight.

Outside of some special work which practically

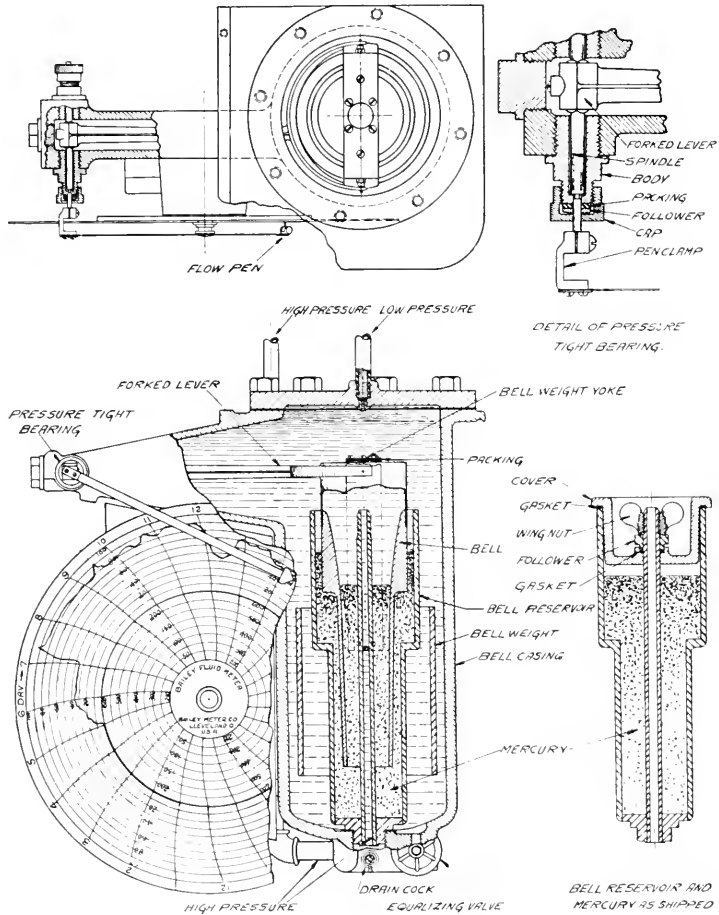

Fig. 5.

The flue gas mechanism is calibrated by sealing the seamless steel tubes with nitrogen at a definite pressure, adjusting the cross section of the U-tube and the amount of mercury to be used.

The air flow mechanism is not calibrated in the shop, as this is done on the field by adjusting the small weights on the bar.

The integrating device is calibrated by adjusting the train of links connected to the counter arm

every Cadet was placed on for a short time, the remainder of the time was usually spent in assembling the meters or machining the casings. It was only a matter of time before each Cadet became so familiar with the meter that he could have built one if the parts were thrown at his feet.

If Dia met her, would Jennie ratchet?  
No, but Balsa wood.

# A 100,000 Pound Hydraulic Testing Machine

By BRUCE W. BENEDICT  
*Manager Shop Laboratories*

With the application of science on a larger scale to the problems of industry, materials of construction are rapidly taking on higher standards of quality and the articles in which they are used are becoming more efficient and useful. In general, the facilities employed in carrying on the work of the world tend to become lighter in weight per unit, but stronger in construction and more resistant to deterioration and wear. Development on these lines is the result of improvements made in the quality of materials and in the application of methods for maintaining definite standards of quality in these materials.

The wide variety of high grade materials available for manufactured products has contributed largely to the remarkable growth and extent of the modern system of specialized manufacturing. This great branch of industry would immediately languish if its basic materials, in respect to quantity required and to exact specifications, were not always available. The manufacturer must therefore develop plans to insure a constant supply of materials of definite quality and prevent the use of materials that do not meet the required specifications.

Without an effective check on quality it is impossible to produce standardized products of character. That this fact is generally realized in industry is seen in the wide spread development of the plant testing laboratory and in the employment of Testing Engineers. Manufacturers of quality products no longer buy materials only—they buy certain grades of materials and insure delivery of these grades by applying definite tests.

For determining the physical characteristics of materials the so called "testing machine" is in general use. These machines are of many styles and types according to the nature and size of the work they are called upon to perform. Testing, as the term is usually employed, includes the determination of many factors such as hardness, tensile strength, resistance to impact, torsion, cross bending, etc. The machine most commonly used in this country for testing samples in tension, compression, and cross bending, is of the screw power type. In this machine, power is applied to the specimen through large screws by means of gearing driven direct by electric motors or by belting. The large 600,000 lb. machine in the Machine Testing Laboratory

is of this type. The hydraulic principle is also employed especially in large machines, although in Europe it is more frequently embodied in the design of machines for custom purposes.

Recently a hydraulic machine of 100,000 lbs. capacity was designed for use in the Forge Laboratory and is now under construction in the University Shop Laboratories. This machine is of some interest since it embodies a number of features of design which heretofore have not been incorporated in testing machines of this class. The design is the conception of H. F. Moore, Professor of Engineering Materials, who is also the designer of the large machine in the Materials Testing Laboratory referred to above, and it was at his suggestion that construction of the machine was undertaken for experimental purposes in the Forge Laboratory. The

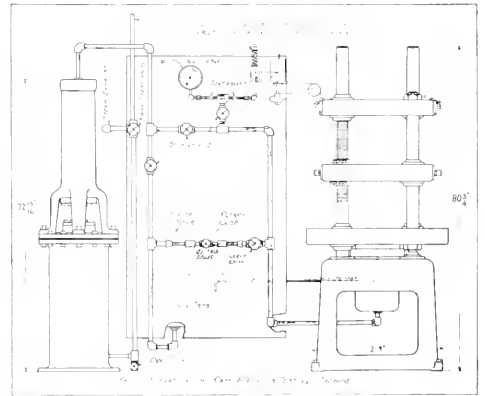

Fig. 1.

detailed designs were made by Mr. M. H. Cook, E.E. '21. Patterns, castings, and forgings, were made in the Pattern, Foundry, and Forge Laboratories respectively. The work of construction is being carried on by the Machine Laboratory Staff.

A general plan of the machine and attachments is shown in Fig. 1. Power is applied to the specimen by hydraulic pressure from a steam operated ram, control of which is effected by two valves. The machine and its general principle of operation is illustrated in Fig. 2. It consists of a base on which



is mounted a hydraulic cylinder 8" in diam. with the plunger very accurately lapped to fit; four columns 3" in diam. two of which are fastened on diagonal corners (A & A'), to the base; and two (B & B') are fastened to the lower platen; three platens, the upper one of which is permanently affixed to columns B & B' and the center one free but equipped with attachments for locking it to columns A & A'. The lower platen is fastened to column B & B' as previously mentioned.

The principle of operation is simple. Upon the admission of pressure to the hydraulic cylinder the lower platen is forced upwards and with it columns B & B' and the upper platen. The center platen and columns A & A' remain unmoved and fixed to the base. Thus an upward movement of the plunger increases the distance between the center and lower platens. A specimen held in the gripping devices of the middle and upper platens would be subjected to a tension stress during the upward movement of the plunger, and likewise to a compression stress if placed between the middle and lower platens. Cross bending tests are made between the middle and lower platens by suitable arrangement of supports in relation to point of load. Upon release of the pressure, gravity returns the upper and lower platens to their original positions.

To secure ease of operation the steam ram and the machine are placed about six feet apart with control board between them as illustrated in Fig. 1. Mounted on the control board are all valves, recording gauge, and indicator within easy reach of the operator. A six inch hydraulic gauge shows pressure in lbs. per sq. in. and tons on 8" ram. A Crosby high pressure indicator with drum actuated by cord from upper platen permits the taking of load diagrams of each test. By means of an enlarging motion, readily adjustable, diagrams up to 3" long are possible.

The capacity of the machine is secured with a pressure of 2000 lbs. per sq. in., but all parts in the hydraulic system have been designed to carry an overload of 25 per cent. or a maximum pressure of 2500 lbs. per sq. in. One stroke of the ram is sufficient to produce the required pressure and complete a test of ordinary character. In order to reduce the time of operation, an electric driven rotary pump with automatic by-pass has been connected to the high pressure line to quickly take up the "slack" in the machine and place the specimen under an initial load of 50 lbs. per sq. in. before the ram is thrown into action. At the latter pressure, discharge from the pump is by-passed into the oil storage tank. A high pressure check valve automatically protects pump and oil tank from pressures in excess of 50 lbs. per sq. in.

Hydraulic testing machines are generally more rapid than those of the screw power type and it is expected that this machine will not be an exception to the rule. The operation routine of making a test is as follows: Place specimen in machine; insert card on indicator drum; close switch on pump circuit; throw 3 way cock in steam line to "admission", then to "exhaust" positions; open switch on pump

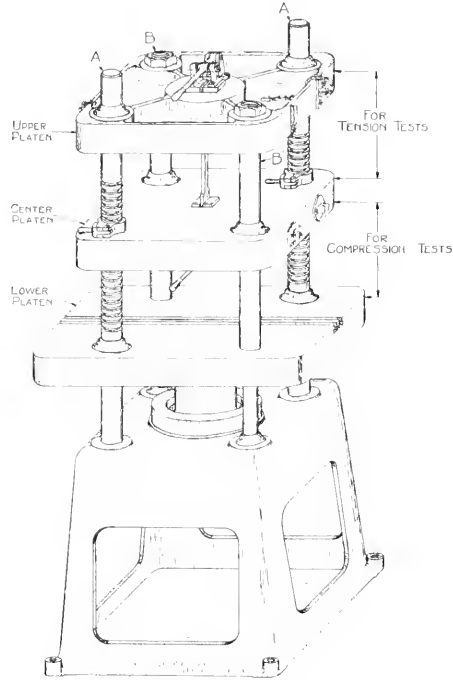

Fig. 2.

circuit; remove indicator card; remove specimen. On standard testing the total time for making one test should not exceed  $1\frac{1}{2}$  minutes.

The hydraulic ram as shown by the illustration (Fig. 3.) stands vertically with the steam cylinder below. The latter is 12 1/2" diam. with admission and exhaust opening in the bottom. Steam pressure is regulated at 150 lbs. pressure per sq. in. The hydraulic ram is a 3" piston with conventional piston head equipped with snap rings. As the piston moves upward, air in the cylinder is forced out the relief opening but with the closing of this opening by piston rings a compression chamber is formed in the upper part of the cylinder which prevents continued upward movement of the ram after the sudden drop in pressure in the hydraulic line following rupture of the specimen. Upon release of the steam pressure and opening of exhaust valve the ram re-

turns through the action of gravity to its original position. Speed of the return of the ram is governed by regulation of the exhaust opening. High pressure cup leather packing is used to prevent escape of fluid from hydraulic chamber.

The hydraulic cylinder and plunger in the machine and the oil chamber casting are made of a special gray iron mixture, sometimes called "semi-steel" having an estimated tensile strength of 25,000 lbs. per sq. in. On the basis of total load on the machine of 125,000 lbs., the oil chamber casting of the machine is designed with a factor of safety of about 4. The columns are made of mild steel having a tensile strength of 70,000 lbs. per sq. in. Under a load of 125,000 lbs., the maximum stress in column is 12750 lbs. per sq. in., giving the columns a factor of safety of about 5½. Cast parts other than those mentioned are made of cast iron or bronze according to requirements of service. Piping for hydraulic line is of "Extra Strong" wrought iron ¾" inside diameter made by the Crane Company. High pressure fittings and valves are from the Watson Stillman Company. This company also furnished the 6" hydraulic gauge and the cup leather packing. The machine is equipped with Crosby Steam Gauge and Valve Company's Standard Indicator for high pressures for recording graphically the hydraulic pressure during tests. A special drum on the indicator permits the taking of continuous diagrams.

The pump for producing initial pressure on the hydraulic plunger is of the rotary type, direct connected to ¼ h.p. electric motor. The capacity of pump is 3 gals. per min. at 300 r.p.m. through ¼" discharge opening. A reservoir of sufficient capacity to hold the entire quantity of fluid in the hydraulic system is mounted beneath the pump. No harm will result if the check valve at pump does not seat or the main stop valve is left open during action of the hydraulic ram as the fluid will be discharged into the reservoir at atmospheric pressure. The reservoir is of seamless steel and tested to 100 lbs. pressure per sq. in. Upon completion of tests the fluid in hydraulic line flows back to reservoir by action of gravity.

Gripping devices for specimen are of the usual wedge block type but special holders are provided for standard test specimens. The lower platen is constructed with two tee slats to allow adjustment of supports for specimens under cross bending tests. Adjusting the machine for specimens of various di-

mensions is accomplished by disengaging the center platen from columns A & A' and moving it to the required position by means of elevating chains attached to the upper platen. The exact adjustment

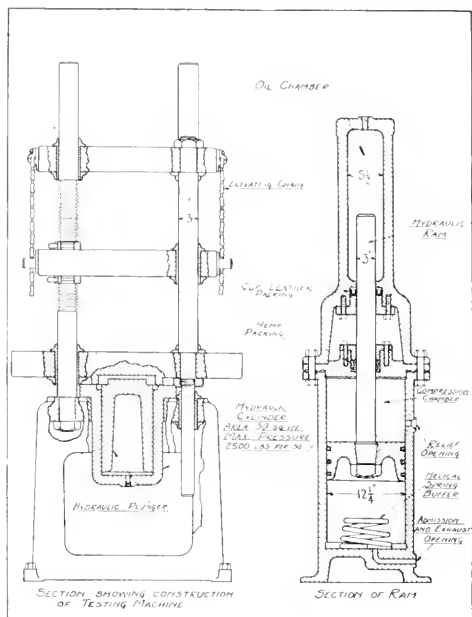

Fig. 3.

is secured by movement of the hydraulic plunger after which the locking nuts are placed in position on Columns B & B' and the lifting chains disengaged from the center platen.

Although the machine is not yet assembled it is not considered as an experiment since its prototype of 25,000 lbs. capacity was built in the Shop Laboratories in 1914, and considerable data regarding its design and performance are available. Although this machine was equipped with a hand operated hydraulic pump it is rapid in action and accurate as to results. The machine now under construction, while following the same general lines of the earlier machine, embraces a number of improvements which are designed to reduce the time of operation and the labor of testing. If these factors are realized in practise the machine will be much more rapid than machines of the screw power type.



# The Making of Clay Silo Blocks

J. T. HUTCHINSON, cer. '23

While it is true that almost every one is able to recognize the clay silo block, yet how few there are, who really know anything of the product, other than that it is a piece of burnt clay which is to be used in the construction of a silo. They know nothing of, nor give a thought to the process through which it has gone ere it becomes the finished product as they see it.

The block as completed we shall describe as being hollow, quadrilateral in form, open at the two ends, having two curved sides, the outer and the inner; and two straight parallel sides, the upper and lower. I have said that it is hollow and so it is, but it has separating walls which divide it into several apertures, two, four, or more.

The process in the manufacture of the clay silo block is divided into four main divisions, viz: (1) The grinding and the mixing of the clay. (2) The forming process. (3) The drying and the burning of the clay. (4) The distributing and sorting of the product.

Let us first consider the grinding and the mixing of the clay. This is one of the most important steps to be considered, for it matters not how well the other and succeeding steps in the process may be carried out, unless your clay is properly mixed the finished product cannot be good. The clay is first put through a machine called a dry pan, which is equipped with large heavy revolving rollers, that reduce it to a fine powder. The clay is either shoveled by hand, or is carried by an endless belt into the dry pan and is thoroughly ground and pulverized by the aforesaid revolving rollers. In the bottom of the dry pan are large perforated grates with small holes about one quarter of an inch in diameter, and as the clay is pulverized it falls through the many small holes into a bucket conveyor and is carried up to the screens, where it is screened and is divided into two parts. The large lumps which fail to be thoroughly pulverized are sent back to the dry pan by a gravity chute to be reground. The remainder is carried on a belt conveyor to what is known as a combining machine, that is a pug mill in which the clay is mixed with water to a desired temper.

The pug mill is a straight barrel machine consisting of a short steel box with a shaft equipped with a set of knives arranged in spiral order. As the shaft revolves it carries the clay forward, mixing it with water the while, until the mixture reaches the end, tempered and ready to be formed into

blocks. Then it drops into the auger machine. This is straight barrelled, with a system of augers on a shaft which forces the clay through a die, forming a horizontal column, in cross section a silo block.

The column of clay is run out from the machine upon a circular table corresponding to the curvature desired in the silo block. As the clay is very soft when it comes from the machine it is easily shaped into curved blocks. The blocks are cut three at a time by fine steel wires, as fast as the clay comes upon the tables. As the blocks are very wet and soft they cannot be lifted from the cutting table with bare hands, so they are lifted by means of wooden paddles which are covered with corduroy or other coarse material which prevents the block from slipping and breaking as it is being handled. The blocks are lifted from the cutting table to cars upon which they are conveyed to the drying tunnels.

The drying and burning of these blocks is perhaps the most important item to be considered. After the cars are filled at the cutting table with blocks, they are transferred to the drying tunnels. These tunnels are nothing more than long rooms heated with steam, for the purpose of drying the ware before it is put in the kiln for burning. Through these long tunnels run a series of steam pipes, which extend from one end to the other. These pipes carry the exhaust steam from the engine in the day time, and live steam directly from the boilers at night. At night about eighty five pounds of steam is carried to insure the drying of the ware by the next morning, when morning, the ware being sufficiently dry, it is taken from the tunnels and transferred to the kiln by means of cars on portable tracks.

The kiln is of the round down-draft type and is about thirty feet in diameter. The floor is perforated, to insure a uniform burn. Equally distant around the kiln are eight fire boxes, so situated as to insure the same amount of heat to all parts of the kiln. Under the kiln floor is a system of tunnels which are used as drafts and which lead to the smoke stack. In the kilns are situated two doors, one opposite the others and in the top are four small holes and one large one which are used to help cool the kiln after the burning is completed.

The blocks are set in the kiln in uniform order in "benches". The benches are composed of two rows of tile set seven high. On account of the curve in the blocks, it is necessary to reverse every other

(Concluded on Page 31)

# Colonel Warren R. Roberts

M. E. JANSSON, c. e. '23

Away back in the dark days of the Civil War there was born on a farm, down near Sadorus, Illinois, an embryo engineer. This statement is made seriously, not humorously, as at a very early age, and long before he knew what was really meant by the term "engineer", this lad decided that he was going to be a civil engineer. This decision was never changed, but instead the desire increased with his years, and there has never been any time since, that he regretted the early decision, or thought he had not followed the natural instinct of his character. This lad was Warren R. Roberts.

As a boy, he was fortunate in having access to a few books, which were of the best quality and happened to be on subjects which especially cultivated any natural bent toward engineering.

On entering the University in 1881, and taking up the work in the school of Civil Engineering, this young man was again most fortunate in making the early acquaintance of Lincoln Bush, another civil engineering student, who was a young man possessing not only an exceptionally fine character, but an ambition which made him a "horse" for work, and which required the greatest efforts to equal.

This pair went thru college so inseparately that that they were known as Bush and Roberts, and many people including some of the professors, did not know the individual identity of the pair, out of which grew some very humorous, and occasionally serious situations.

The latter was a most conscientious student, living up to all the regulations of the college life, including constant attendance in elocution and oratory, to which requirements the rebellious spirit of his team-mate objected, and consequently did not attend. However, at the end of the term, owing to the mistaken identity of the individual, Roberts got a "One" and Bush was "flunked". Roberts thought this was a great joke, and Bush was sufficient of a sport to accept it. But, as the same marks were given in the second term, Bush thought it had ceased to be humorous (with which Roberts agreed) and notified the Professor of his mistake, whereupon the Professor agreed that he would give Bush the "Ones" to which he was entitled for the two terms, and let Roberts keep the "Ones" to which he was not entitled provided he would agree to attend his classes in the future, and which contract was solemnly agreed to.

In those days a very much larger percentage

of students earned the whole, or part, of their expenses necessary to maintain them in college. The subject of this sketch was commissary of one of the very best clubs at that time. This assistance, together with whatever work he could secure, enabled him to go through the University on very much less than the average student today spends per year.



which was necessary if he was to have an education at all. In addition to his regular work, this student was active throughout his college term in literary work, as a member of the Philomathean Literary Society; also helped to organize and maintain the old Civil Engineers' Club, which we believe has grown into a very prosperous engineering society.

On April, 1888, having completed all his college work, including writing thesis, etc., he obtained leave from the University and came to Chicago to secure employment.

This new life in the great city was started with

a \$20.00 gold piece presented by his mother. The trip to Chicago was made in the night in a day coach, and on arriving a policeman gave directions how to reach the Lassig Bridge Works, which was located in the far northwest quarter of the city, and which was reached by a long and tedious trip in an old street car drawn by horses with tinkling bells. A "job" was readily found at the magnificent salary of \$10.00 per, and when this aspiring engineer asked Mr. August Ziesing—then Chief Engineer of this bridge company, if he could live on \$10.00 per month, Mr. Ziesing replied that it was a great plenty, if he had more he might go to the bad in a city like Chicago. He learned from experience during the next few months that if he had received less he would have been an object of charity.

In this first position in the Engineering Department of this Bridge Company, under the direct influence of so able an engineer and capable a business man as Mr. Ziesing (U. of I. Class of '78) it was evident that the good fortune which has pursued the subject of our sketch thus far in life, was still with him. In fact, he has always maintained that when he was born his star was in its zenith.

There is nothing of particular interest to record in the next few years in the life of this engineer, excepting to note that he still maintained that success came finally to an engineer only by the most constant and diligent effort. Also that from time to time, as he changed positions, such change was not made with the sole object of an increase in salary, but more consideration was given to selecting a new position which would supplement the experience gained on previous work, and thereby finally round out an experience which would fit him for his life's work.

Mention is made of this fact for the reason that we have been often impressed with the mistake that young engineers make in striving to secure paying positions instead of giving to fitting themselves finally for a larger and better place in the profession.

After some seven years of this preparation, meanwhile having held several positions of responsibility and trust, he was invited by a young engineering and contracting firm to join them in this business, which he did by taking one-third interest in the company and becoming President and General Manager of it. In the course of a couple of years their success had been such—and circumstance arising which seemed to make it desirable—he bought out his associates and changed the name of the firm and continued the business himself.

In passing it might be of interest to students at the University to learn that during this initial period of his career as a contractor, he built the

Library Building on our campus, as is indicated by the name plate in the entrance to this building. Immediately following the completion of this work, he built the main University Hall for the University of Iowa; the Modern Woodmen head office building at Rock Island, and some other rather notable structures.

This class of work, acting as general contractor, did not bring into use the experience and ability gained as an engineer, and for this reason he gradually changed his line of work to engineering and industrial structures, giving the opportunity to *Design and Build*. The wisdom of this change seems justified as it resulted in building up an organization and a business based on a special service for a large and growing industry in this country.

The Roberts and Schaefer Company of Chicago, Engineers and Contractors, specializing in the designing and building of Coal Mining Plants, Coal Washeries, and all types of coal storage and coal handling plants, is the outgrowth of a business along these lines developed some twenty years ago by this engineer through the gradual evolution as outlined above.

The Roberts and Schaefer Company furnished their full quota for this service, including their President and some twenty-nine other members and employes. Their President, being the subject of this sketch, is the only one whose service will be outlined briefly in this article. He was called by the War Department in October, 1917, thru Brig. Gen. L. W. Littell, Chief of the Cantonment Division of the Quartermaster Corps, the organization then in charge of building the thirty-two large cantonments for the housing of the new army then being organized. During this month the Secretary of War had passed a general order transferring all construction work within the United States and all possessions for all corps and divisions of the War Department to the Cantonment Division. This order made it necessary to greatly enlarge this division and reorganize it to handle a great variety of engineering and construction work, as from this date on extensive plants for the Ordnance Corps, Engineer Corps, Hospitals for the Medical Corps, and special plants for the new Aviation Corps and Chemical Warfare must be designed and built with the greatest possible speed by this division. This was a great responsibility and required a large and efficient engineering and construction organization. This engineer was selected because of his experience as an organizer, and assigned to the duty of developing this new Engineering and Construction Organization. His first duty was to prepare a paper organization and then immediately secure from the Engi-



# EDITORIAL

## THE TECHNOGRAPH STAFF

ARTHUR J. INGOLD, JR., '22 . . . . . Editor  
 WALTER A. MUELLER, '22 . . . . . Business Manager

D. A. MONRO, '22 . . . . .	<i>Associate Editor</i>	W. J. KLINGBERG, '22 . . . . .	<i>Circulation Manager</i>
E. E. VALENTINE, '22 . . . . .	<i>Art Editor</i>	W. B. MATHEWS, '22 . . . . .	<i>National Advertising</i>
M. E. JANSSON, '23 . . . . .	<i>Assistant Editor</i>	H. C. HARMELING, '22 . . . . .	<i>Local Advertising</i>
J. W. HARRIMAN, '23 . . . . .	<i>Assistant Editor</i>	W. R. ENYART, '23 . . . . .	<i>Asst. Business Manager</i>
D. C. MURPHY, '23 . . . . .	<i>Assistant Editor</i>	P. J. BERGER, '23 . . . . .	<i>Asst. Business Manager</i>

### Assistants

P. T. DEDMAN, '22	A. B. DURHAM, '22	E. L. GOBLE, '23	C. BOWEN, '23
C. H. DODGE, '21	J. B. CLAUSEN, '24	W. F. GERDES, '24	S. E. MILLER, '24
I. L. VENDIG, '25	J. L. DICUS, '25	L. R. LUDWIG, '25	

### Departmental Representatives

C. C. COUNCELL . . . . .	<i>Architecture</i>	D. B. COLLINGS . . . . .	<i>Electrical</i>
H. S. COSS . . . . .	<i>Ceramics</i>	G. REED . . . . .	<i>Mechanical</i>
W. A. GERTLER . . . . .	<i>Civil</i>	R. A. MERZ . . . . .	<i>Mining</i>
S. M. ELLEMAN . . . . .			<i>Railway</i>

*Published quarterly by the Illini Publishing Company. Entered as second-class matter October 30, 1921, at the postoffice at Urbana, Illinois. Office 213 Engineering Hall, Urbana, Illinois. Subscriptions \$1.50 per year. Single copies 40 cents.*

## “Volume Thirty Four”

Since 1885 the TECHNOGRAPH has been published by the students in Engineering at the University of Illinois and has served in an important capacity in the College as well as in the University as a whole. In starting in this year it seems well to outline briefly several of the policies of the publication and your relation as a student to it.

The TECHNOGRAPH is primarily a student publication, and therefore solicits student articles and publishes such articles as will be of vital interests and value to the Engineers who read it. It is, of course, no easy undertaking to satisfy the demands of all departments, but every effort is made to make the TECHNOGRAPH of value to all.

Since the TECHNOGRAPH is a student product and since you are a student, you are the one who should start *now* to write an article for us. If you think that we have slighted some field of the profession tell us about it or better yet sit down and write about it. If you know of some engineering feat or of any other feature of possible value don't fail to do your part by calling to our attention such material.

Realizing the prevailing evasive light in which engineers are inclined to view the art of writing and the successful manner in which so many avoid writing, THE TECHNOGRAPH has perhaps, as its leading purpose the cultivation of the literary side of the engineers. Each day brings a new realization of the importance of being able to express ones ideas, in a clear

and forcible manner. Any institution which will cultivate this usually latent power is invaluable.

Now is the time for you to start your article and derive the many benefits connected with having it published. Now is the time Seniors. No time is better than the present. Underclassmen.

---

## Getting Connected—Class of '25

New men in the University cannot realize for some time, possibly not till their Junior or Senior year, the importance of becoming identified with some project in their department.

The Departmental Societies provide one of the best means for such a connection. The contact you will get in your society with the professors and the live students in your department will prove invaluable all through your college course. Any active part you may take in such organization will net you returns which will vary with the amount of spirit you put into the work and the amount you do. At first you may feel that you are a small part in a large machine and that your work is not noticed, but in a short time the fellows who are ready to work and who display more than the interest of a casual observer become known and are well repaid for their efforts.

The first few years of the engineering courses are quite apart from the actual work you are interested in, although they, of course, are a necessary basis for it all. The meetings of your Society should serve as a bond between you and the actual work of your department for the first year or two. The topics of discussion, the subjects of addresses, and the business of the meetings should serve to get you better acquainted with the field you are enlisted in.

Become connected with the Society in your department now.

---

## Inspection Trips

At work again after their inspection trips, the Seniors realize more fully the extent, the magnitude, the opportunities, and the important place engineering holds in the world. The immensity, perfection, and importance of the undertakings inspected could not help but impress upon the future engineers the great accomplishments due to the engineering mind.

Many men who embarked on this trip without knowing the field in which they expected to go upon graduation formed their opinions as to what they would do at the end of the year. The business depression as evidenced in many of the places inspected could not pass unobserved.

Credit is due the Inspection Trip Committee which made arrangements for visiting the various plants, buildings, and undertakings. In the present period it was not an easy undertaking to plan the trips so as to find plants in operation. The Committee beyond a doubt planned a trip which was valuable from beginning to end. The only regret is that the trip comes but once during our college career. This does not mean that you can only go on one inspection for there are many chances during the year when, if you will but take the time, you can go on inspections of your own. Possibly the Trip served a purpose in arousing in you a desire to continue such inspections.

---

The TECHNOGRAPH again has had the pleasure of awarding an Engineer's Handbook for the best article written by a student on his summer work. Mr. H. D. Rosendale, '22 was awarded the first prize for his article on "The Power Plant Meter". This technical subject was treated in a manner such that the article is of interest to all.

The second and third prizes were awarded to Schaeffer, Jr. and H. C. Martin. Mr. Martin's article appears in this issue of the TECHNOGRAPH and Mr. Schaeffer's will appear in the next issue.

# The Manufacture of Portland Cement

H. C. MARTIN

*Placed Third in Summer Article Contest*

The enormous increase in the use of concrete for buildings, roads, bridges, dams, retaining walls, and many purposes has resulted in a vast production of cement. Portland cement has become by far the most important cementing material used in modern engineering construction.

In the United States this industry grew steadily from its beginning in 1866 until 1908, and since that date its growth has been phenomenal. Few industries can record such a wonderful development as is indicated by an increase in production from approximately 3,500,000 barrels in 1898 to 92,000,000 barrels in 1913.

In order to understand the process of manufacturing, a definition of Portland cement would be of value. Portland cement is the product obtained by finely pulverizing clinker produced by calcining to incipient fusion an intimate and properly proportioned mixture of argillaceous and calcareous materials, with no addition subsequent to calcination excepting water and gypsum.

The composition of Portland is approximately 60 to 70 percent lime, 20 to 25 percent silica and 5 to 12 percent alumina and iron oxide. The essential elements are therefore calcium, silicon, aluminum and iron, each of which is found in nature usually combined in some way with oxygen. As these are the five main elements of the earth's crust, it is evident that raw materials for cement manufacture are abundant and may be combined in innumerable ways to give the desired ratio.

Although the raw materials for making cement are abundant and widely distributed, the necessity for maintaining a low manufacturing cost eliminates many sources of supply. The chemical composition must be such that a proper mixture may be procured and maintained. The physical characteristics must be such that quarrying, crushing, and pulverizing may be done at a low cost, and the fusion points must be sufficiently low that clinker may be made without using an excessive amount of fuel.

In a few localities cement rock is found that contains alumina and iron oxide, alumina and lime in nearly the correct proportions. As a rule, however, a mixture of calcareous and argillaceous materials is necessary. Arranged according to the relative importance of the materials used in the United States, they are as follows: cement rock and shale,

chalky limestone and clay, and blast-furnace slag and limestone.

The raw materials for the manufacture of cement are excavated by three different methods, quarrying, mining, and dredging. Since about eighty-five percent of the raw materials used in the manufacture of cement are quarried, this method will be the only one described.

The plan of quarrying that will give the best results depends upon the depth of the stripping, the thickness of the beds and the uniformity of the chemical composition of successive beds. Where the over-burden is thin and a great thickness of rock is available, the depth to which quarrying may be worked is a matter of choice. Thirty feet or more is usually more cheaply quarried than a depth less than thirty feet. Where the over-burden is thick and the underlying bed of rock has a great depth, deep quarrying is carried on, thus obtaining the maximum quantity of rock for a minimum of stripping.

After the space-burden is removed, which is generally done by means of a steam shovel where it is of any thickness, holes are drilled in the undisturbed bed rock in order that the rock may be broken up by means of heavy charges of explosives. Generally the primary shot does not break up all the rock into sizes that can be handled by the steam shovel. It is then necessary to break the large masses by subsequent shots. This is called secondary blasting.

The rock having been stripped, drilled and blasted, it is now ready to be transported to the crusher. Two methods of loading in common use are hand loading and steam shovel loading, the latter being used wherever wages are high and labor scarce.

Various systems are in use by which the rock is transported from the quarry face to the cement plant. However at most plants, the rock is hauled in cars by a donkey locomotive to the incline and by means of a cable and drum equipment the cars are taken up or down the incline as the case may be. The highest efficiency is obtained by having a simple system of haulage, an ample supply of strong cars, and utilizing the force of gravity wherever possible.

In the process of manufacturing Portland cement the proportioning of the mixture of the raw materials is of utmost importance. On proper mixing depends to a great extent the quality of the



cement and consequently the success of any cement manufacturing enterprise. Variations within certain limits are allowable, but every cement company finds that a certain definite ratio of the principle constituents gives a superior cement.

The method of mixing the materials in preparation for their introduction into the kilns has led to a classification of processes, the dry process and the wet process. The wet process is used almost exclusively in the manufacturing of marl, the material being excavated wet and kept until the moisture is driven off in the kilns. The dry method is most common for mixing the raw materials obtained from quarries.

In both the wet and dry process the calcareous and argillaceous materials are weighed and a mixture that is approximately correct made. In the dry process, the storage bin is probably the biggest factor in obtaining a uniform and desirable mixture of the raw materials. This is accomplished by distributing the materials in the bin and by removing them in such a way that further mixing takes place. Bins of shale and of rock high in calcium carbonate are drawn from whenever the composition of the mix is to be changed. In the wet process the mixture is pulverized wet and stored in large tanks. The composition of each tank is determined by analysis and with this data, the operator obtains a mixture of the desired composition from two or more tanks.

The chief advantage of the wet process is the ease with which the variable raw materials may be mixed together and also the low cost of pulverizing the raw materials. On the other hand longer kilns are necessary in order to drive out the moisture and the fuel cost to burn a wet mixture is greater.

After the materials have been properly mixed, they are ground to a fineness such that ninety percent will pass through a screen having one hundred meshes to the inch. The grinding is accomplished by passing the material, after it has been crushed, through tube mills. A tube mill consists of a long horizontal cylinder filled about half full of flint pebbles. The cement is ground by rolling around with the pebbles. It is then thrown by centrifugal force against the screen, which regulates the fineness. The fine grinding of the raw materials before burning is one of the secrets of successful manufacture.

The type of rotary kiln used for calcining the materials consists of an inclined tube varying from sixty to one hundred and twenty feet in length and the diameter is usually seven or nine feet. The lining of the kiln is fire brick, so shaped that each brick wedges in against the other forming a smooth uniform circle. The low end of the kiln is closed by a brick wall built into a framework, which may be rolled away from the front of the kiln when any

repairs are to be made. Through the center of this wall passes a pipe which feeds the fuel into the kiln. If coal is used as a fuel, it must be ground very fine and must also be dry before being blown into the kiln.

In the dry process the ground stone is fed into the upper end of the kiln by means of a spiral conveyor, while in the wet process the slurry is pumped into the kiln. The degree of calcination is governed by the supply of raw material, speed of rotation of the kiln, which rests on rollers geared to a speed changing device, and the quantity of fuel. The proper temperature, which is from 2700 to 3000 F., is determined by the appearance of the burning stone. The material becomes vitrified when about fifteen feet from the lower end and forms clinker, which rolls around and finally falls out red hot at the lower end.

The clinker, after being cooled, is now ready for fine grinding, or it may be stored either outdoors or inside until needed. It is a curious fact that wetting the clinker does not injure it, provided it is dry when it enters the fine grinders.

Gypsum is added to the cement as a regulator of its setting, the amount varying from one to three percent. The gypsum must be added after the calcination and before the final grinding in order to secure the proper result.

The fine grinding is generally accomplished by passing the clinker through the ball mills and then through the tube mills, which are similar to the ones used in grinding the raw materials before they enter the kiln. The ball mill consists of a cylindrical drum lined with castings of hard steel, and containing forged steel balls eight or ten inches in diameter. Rotation of the drum grinds the stone or clinker between the balls and the plates, and the fine powder passes through the screens into the hopper below.

The cement having been ground to a fineness such that 75% to 80% will pass a 200 mesh sieve, is taken to the storage bins. Two general types of storage bins are in common use. One is the long rectangular building with an archway through the center where the cement is taken to the sacking machine. Due to the fact that the cement has an angle of repose that varies from almost zero to ninety degrees, the stresses in this type of structure are very difficult to determine. The other type of storage bin is the silo type. The advantages of the round bin are that it cleans itself easily, that all the stresses are taken care of by the steel reinforcing, thus reducing the danger of the structure failing to a minimum, and the large capacity for the material used.

# The Development of a Peat Bog

R. M. BAER

*Professor of Geology, Lawrence College*

About one year ago the writer examined the peat deposit of Center Swamp, five miles northwest of Appleton, Wisconsin with reference to its utilization for fuel. Borings were taken in sections along all drainage ditches and where the Wisconsin & Northern railroad crosses this bog by means of ship auger welded to galvanized gas pipe. This pipe was cut into three foot lengths and coupled so tightly on one end that they would not unthread while the sampling was done over the entire area in places down to 22 feet below the six foot drainage ditch. Glass canning jars were used as containers, these being sealed with rubber gaskets in the field.

Sampling this bog revealed the following interesting Geologic history of the region: The glacial ice advance must have deepened and gouged a depression into a basin nearly five miles in length and a mile wide though the present peat deposit and swamp area is less than this size to-day. The depression was egg shaped and deepened on the west end and its oval eastern margin began to fill with sand bars and sheets of sand from a foot to six feet thick. This sand bed plays out in about one half mile from its eastern extension and is entirely replaced by a unique clay deposit of great thickness and extent. We were unable to find its base at 22 feet below the drainage ditch in one place and drilled through it at 18 feet 1000 feet east of this point. Clay was slowly deposited in undisturbed waters, perhaps from melting ice sheets west and north, it is homogeneous, highly plastic, and of a rich chocolate brown color. All but one per cent of this clay passes through 100 mesh screen and all but two per cent will go through a 200 mesh sieve so that it is of very fine particles and not a river clay in any respect.

After this Glacial lake had filled with the 20 foot clay bed the waters became shallow enough to allow the formation of a bluish green elastic marl from one to three feet in thickness crowded with two types of gastropods, (snails, etc.) characteristic of fresh water deposits.

The snail shells underlying the peat bog are all small and appear to be stunted. It is uncertain whether this dwarfed condition was due to the cold temperatures or to lack of food supply but probably both factors played some part in effecting this development.

The basin was shallow enough for growth of

peat bog mosses. There were several characteristic peat bog genera but the earliest were *Carex*, *Iris*, and later typical mosses *Hypnum* and *Sphagnum*. *Sphagnum* greatly predominates in the upper three feet of peat while the triangular white stemmed flag types are abundant near the base.

The peat bed over five feet thick occupies a



Fig. II.

square mile in this swamp and its inner zone will average eight feet. Its tonnage was estimated by both Canadian and U.S. methods and found to be

Elements	Peat Received	Moisture Free	Alfred Bog Canada
Moisture	7.78 %	----	----
Volatile matter	54.97	59.60	66.13
Fixed Carbon	18.76	20.39	26.56
Ash	18.49	20.05	5.31
Sulphur	.95	1.05	?
B. T. U.	7015	7606	8730

at least 300,000 tons of dried peat available as a commercial by-product.

Analysis of this peat together with other records we give below shows the relative heat value of this immense bog.

The Alfred bog of Canada was reported to have produced 20,000 tons of peat annually, but this we cannot verify. Reports from this London, Ontario

proposition however appear to be very favorable and as near as any modern peat development in America.

Through the efforts of Mr. C. C. Nelson, Auditor of the Wisconsin & Northwestern railroad which crosses this swamp along its eastern portion, a company was organized to exploit this peat for fuel. Mr. Nelson has made a thorough study of peat and is doing intensive work on the problems connected with its utilization.

The results of his work are shown in a spur from the railroad into the center of the swamp and the erection of a small but modern fuel plant for the drying and preparation of this peat bed for fuel and also for fertilizer.

Figure 1 shows the excavation of peat and methods of handling the material. The present workings extend back only a few hundred feet and the base of the peat is not yet reached in these workings.

#### *Reduction Process and Method of Treatment*

The Center Swamp peat plant equipped for peat fuel and fertilizer products has 10,528 feet of floor space and is modern in every particular. The drainage ditches extending through this swamp were excavated for farm improvement long before the present peat project was thought of. The main ditch however is now used to pump by centrifugal pump the waters collecting in the peat excavation work. This pump is sunk in a 6 by 6 ft. well, 16 feet deep, and connected with an 8 inch sewer tile to 2 channels spaced about 12 feet apart, six feet deep, and in which are placed two portable tracks with a switch at the far end of a long inclined elevated tramway, the upper end being some 10 feet high for carrying the peat into the storage bin runway.

The storage bin room into which side dump cars carry the peat hauled by cable and hoist method is about 20 feet wide and 80 feet long. From this large bin when ready for use the peat is shovelled onto an endless belt 16 inches wide extending under the tramway the full length of the storage bin and carried on the belt into the disintegrator and water extractor. The disintegrating machine removes some of the free water and in its macerated condition the peat then passes into a 12 foot pug mill from which it is fed into the compound grinder where it is ground fine. The operators claim that this fine grinding removes a very large amount of the contained moisture which furnishes the worst problem of peat fuel production.

From the fine grinder the material is fed into a horizontal auger press which rotates, forcing the disintegrated peat into three cylindrical tubes each 16 inches long and tapered from 4 inches to 3 inches, thus adding to the peat compression. These peat cylinders or briquettes are of equal length and it

seems that they should be cut smooth and true so as to pack more closely on the drying trays but now they are broken off automatically into pieces from 4 to 8 inches in length and from the press these peat fragments drop into pallets built of slats 12 inches wide and 3 feet long, each one holding about 50 pounds of peat ready for final drying. These pallets run onto an endless 12 inch belt out into the drying sheds, the main one being 102 feet long, 38 feet wide, and containing 50 drying racks each holding 80 pallets. This dry shed has 7 foot high side walls with two rows of doors on each side and hinged at the top so that they can be easily raised or lowered for ventilation and also for protection of the peat during wet weather. This shed is further provided with an elevated center with a row of windows on each side which can also be opened or closed like the side wall shutters. On each side of the dry shed endless belt are two tracks and side dump cars into which the dried fuel is dumped and conveyed to a 12 foot room at the far end of the shed. These cars are dumped into an elevator which carries the fuel to the storage bin.

The main working plant is a two story structure 24 feet by 60 into which has been placed an improved rotary disc dryer. This is used chiefly for the fertilizer product where lime and other fertilizer ingredients can be added.

The dryer has double drums 3 feet in diameter and 12 feet long, placed one above the other with a conveyor between them which returns the upper drum product to the end of the lower. Both drums are heated with an O.K. dryer furnace and a No. 3 American Blower which forces the heat through the peat as it pours over the wire covered inclined disc. The peat is first run through the disintegrator and carried to the first drum and as it pours from the second drum it is elevated to the smooth roll grinder which completes the process of making mull.

This plant has turned out many tons of both peat fuel and fertilizer during the past summer and the products appear to be satisfactory. The peat fuel sold for \$10.00 a ton and the fertilizer for \$30.00 a ton in the surrounding communities and farms.

The present tonnage of peat fuel has however been limited as the drying sheds are not nearly large enough for peat fuel production on a large scale. The plant will perhaps have to be improved and cost production be lowered with the further installation of money-saving devices if it is to succeed for peat fuel manufacture, but the fertilizer development should prove a success. Peat manufacture on proper scale into attractive and easily handled briquettes does not seem yet to be attained in the United States, but the Center Swamp plant has many advantages over any plant known. In the

first place it is drained by great drainage ditches originally planned for agricultural purposes and costing many thousand dollars to complete. Secondly, it has a good railroad traversing the swamp and with a spur a mile long directly into the bog operation where the products can be loaded direct into cars for shipment. Thirdly, it is near a local market, and finally, it has good power and electric equipment facilities as well as good roads into the plant area.

If this modern plant cannot be placed on a paying basis with some improved devices I fail to see how any peat bog in the country can be utilized. The offer of a big fertilizer company to purchase 20,000 tons of mill for fertilizer base for a period

of five years shows the possibilities of this bog product aside from fuel manufacture. We still believe that peat to compete with high grade bituminous coal must be treated by some inexpensive but efficient additions so that it will weigh more, (that is be less bulky) and burn longer with a little higher B.T.U. The drying of peat can be brought about but the time element for this does not yet appear to be wholly solved. The ready market here for this experimental peat fuel seems to pave the way for more extensive exploitation. The clay bed under this peat bog offers very great potential value for brick manufacture and perhaps the combination of both products can be brought to a successful conclusion.

---

## Manufacture of Portland Cement

(Continued from Page 24)

From the storage bin the cement is drawn off and conveyed to the sacking machines. These machines are not owned by the cement companies, but are installed and kept up by the company which receives a fraction of a cent for each sack that is filled. The cement is fanned through a spout over which the lower end of the sack is pushed. The opening through which the spout enters the sack operates like a valve. Filling the sacks in this way enables the sack to be tied before the cement is put in. When the sack contains ninety-nine pounds of cement the fan is automatically stopped and the operator trips off the sack, which falls to a felt conveyor below and is carried out to the box car ready for shipment to the consumer. The machine fills three sacks at a time and has a capacity of 1000 sacks for eight hours.

One of the newest developments in the cement industry is the installation of large boilers to develop power from the gases from the kilns. Although waste heat boilers are not new in the cement industry, it was not until recently that the high price of fuel and labor necessitated cutting down the cost of production that the industry in general began to consider this matter seriously. The general plan of the present day waste heat installations that utilize the gases from the kilns is as follows: a number of water tube boilers sufficient to utilize all the heat from the waste gases are placed in the rear of the kilns. Back of each boiler is an economizer and back of each economizer is a fan which furnishes draft sufficient to draw the gases through the en-

tire system and still maintain a draft of about seven tenths of an inch at the end of the kiln.

The temperature of the gases leaving the kiln 1600 F. Since this is lower than that obtained in direct fired boilers, in order to obtain a heat transfer rate at all comparable with that found in ordinary boiler practice, the lack of temperature must be offset by an increased velocity of the gases in their passage over the heating surfaces. Each boiler has a number of passes, generally between four and eight, over which the gases must pass before entering the economizers. In order that the hottest gases may strike the superheater tubes first, they are placed either at the top or bottom of the first pass.

Engineers designing waste heat installations for cement mills have not yet found a way of getting rid of the cement dust, which tends to clog up the whole system. At present the boilers are provided with air tight doors placed at various points through which pipes are inserted and the dust blown out by means of compressed air. The kilns are connected to the boilers by passages where a large amount of dust settles before reaching the boilers. The passages have doors at the end and sides where the cement dust is cleaned out every twenty-four hours.

By passes for the gases are provided to enable the boiler to be shut down for cleaning and repairing without interfering with the operation of the kiln.

While the design of waste heat installations for the cement industry may be changed, the fundamental principles are right and in the future the cement mill not equipped with waste heat installation will probably be forced out of the game.

# Modern Street Lighting

PROF. E. H. WALDO

The "White Way" has become "popular" and by very many, is considered the most desirable method of street lighting. Even if costing more for installation and power it is certainly far superior to the old unshielded arc lamp in vogue for so many years, not only in appearance, but also in effectiveness of street illumination. The present style of post with a single globe and lamp is decidedly more economical in first cost and power than the "cluster lights" frequently used.

The object of a street lighting system is primarily to light the street surface for the safety of traffic at night, and this should be done by furnishing sufficient light, properly distributed and without glare. This may be done cheaply or at large expense depending on the taste of the community and the ability of the municipality to pay. And we have now come to demand not only a lighted street, but an ornamentally lighted street as well.

The old arc lamp was an intensely brilliant illuminant taking considerable electrical energy, and the lamps were therefore generally hung, often enclosed only in a clear glass globe, at infrequent intervals along the street. This gave a very bright spot near each lamp and generally the lights were far enough apart so that midway between them they gave practically no illumination at all.

Passing along a street thus lighted, when approaching a lamp the eye was first blinded by the intense light and after passing the lamp the comparative darkness now ahead was impenetrable to the eye blinded by the previous glare. Such lighting may easily be worse than useless as one may see much less readily than in a more uniform but much more dimly lighted street.

An opal shade or globe placed around the arc prevented much of this trouble by doing away with the excessive glare.

By using less powerful units, for example the incandescent lamp which has now largely superseded the arc, placed nearer together, the above difficulties may be still further reduced.

As the illumination in any direction from a light decreases as the square of the distance from the source, it is evident that to get a fairly uniform lighting of the street the lamps must be quite close together. Though in this case each light source need not and, in fact, should not, be very large, yet the cost of installing so many posts and fixtures becomes considerable. This however is what is gener-

ally done in the "White Way" lighting systems. A large diffusing globe is placed over each lamp preventing glare, as the whole surface of the rather dense glass becomes itself the source of light, radiating light in all directions. In this way the street may be not only uniformly illuminated but as brightly lighted as may be desired by using more or larger lamps.

To save the expense of using so many lamp-posts along the street and still keep the lighting reasonably uniform various "reflectors" and "re-

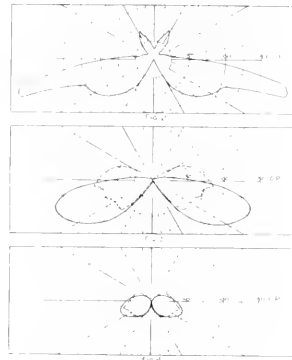

fractors" have been proposed and used. The effect of these is to collect the light rays which would otherwise be wasted in lighting the trees and sky, and in giving a more than necessary illumination in the immediate neighborhood of the lamp, and to send them out just below the horizontal. In this way the greatest intensity of light may be directed where it will reach the street surface midway between posts, securing a greater range of lighting for the lamp.

The statement that such a distribution of light could be obtained with enclosing globes had been questioned, so it seemed desirable to test the matter and the writer accordingly decided to make the test. The General Electric Company very kindly loaned us last year a street lighting fixture and two globes of the acorn shape. The shape of the globe has comparatively little to do with the light distribution and is a matter of taste.

One of the globes sent was of "Light Carrara", a glass practically the same as that used on our campus lights. The other was clear glass but "stippled" to prevent undue glare. This stippled glass

absorbs but about 1% more light than a plain clear glass.

A prismatic refractor was also furnished, and tests were made with the two globes, with and without the refractor.

The lamp used in the tests was the ordinary 100 candle power street lamp, which alone would have a fairly uniform light distribution in all directions except in the direction of the base. When this lamp is surrounded by the refractor however, a distribution curve of the shape shown in Fig. 2 is obtained.

The curves given are drawn from the data secured in the photometer tests made in the Electrical Engineering Department. No effort was made to secure great accuracy, and the lamp and globes received a cleaning only such as the ordinary lamp cleaner would give, as we were interested only in showing about what can be done practically with these units. The curves are "polar candle power curves" showing the distribution of the light intensity in a vertical plane through the lamp. The length of the line from the center, where the lamp is supposed to be, in any direction to the curve indicates the candle power of the light source in that particular direction.

It is quite apparent from this curve that a 100 candle power lamp with the refractor gives a maximum intensity of nearly 200 candle power in one direction. With the ordinary lamp post the light rays in this direction would meet the street surface about 75 feet away from the post. This increase of intensity in this direction is of course accomplished at the expense of light before thrown out in other less useful directions. The intensity of the light decreases as the lamp post is approached. This tends to give a street illumination that is more uniform since the more intense light rays are sent out to the greatest distance.

With the stippled globe around the refractor a similar shaped curve was obtained, shown by the solid curve of Fig. 3. Some of the light of course is absorbed by the globe. With the globe, but without the refractor, a distribution shown by the broken line curve of the same figure is obtained.

Using the Carrara globe, the type most generally employed in "White Way" lighting, the curves of Fig. 4 were obtained. A glance at the two curves in this figure makes it very plain that the glass of this type of globe absorbs so much of the light and so thoroughly diffuses it that it makes very little difference whether a refractor is used or not.

It will be seen that these tests indicate that about three times more light is given off in a useful direction when the stippled globe with a refractor is used than when the translucent diffusing globe

is employed. This quite substantiates the claims of the manufacturers that the same lighting may be had with many less lights by the use of the refractor.

It is questionable whether the stippled globe would be as pleasing to the eye of most as is the more thoroughly diffusing globe. It is also questionable whether a given street is beautified by doubling the number of lamp posts along its length. It depends on the type of street and perhaps on one's taste, whether lamp posts should be ornate and showy or as inconspicuous as possible—as for example our own campus light posts, which one may pass a dozen times in the daytime without noticing.

It is well to know however that when we want the effect of the ordinary "White Way" we will get it at the cost of twice the number of lights and twice the yearly power bill.

## Colonel Warren R. Roberts

(Continued from Page 21)

neering and Contracting talent of this country, able men to fill all of the responsible positions in this new organization. Among able men whom he secured was Lincoln Bush, his old college associate and life long friend.

Mr. Roberts was commissioned as a Major and made Executive Officer to Gen. Marshall in charge of organization. He served in this capacity until July 1918 when, on request of Gen. Goethals, Asst. Chief of Staff, was transferred to the Purchase, Storage and Traffic Division which had recently been established with Gen. Goethals as Director. He served from this date on to the close of the war as Chief of the Engineering and Standardization Branch of this new supply division of the army. It may be of interest to the readers of this article to learn that in building up this new branch of the service, he secured such able business men to serve with him as Robert F. Carr, then President of the Board of Trustees of our University.

Col. Roberts remained in the service until the spring of 1919 to complete this work, and until a physical breakdown made it necessary for him to ask for his discharge. A few months after his honorable discharge he was recommissioned as Colonel of the Quartermaster Section, of the Officers' Reserve Corps and is still in this reserve subject to call in an emergency.

Col. Roberts is a member of The American Society of Civil Engineers, The Western Society of Engineers, The American Mining Congress, The Chicago Engineers Club, as well as several army organizations. He also, soon after his discharge from the army joined the American Legion and organized Hiram J. Slifer Post of Chicago, of which he was the first Commander, and in which he is still active.

## Factors Necessary for Engineering Success

(Continued from Page 10)

and speaking; and unless he uses clear and forceful language, others are likely to assume that he is an ignorant man, and consequently his professional standing suffers and his influence as a citizen is weakened.

Usually the engineering student is considerably weaker in his use of language than most other college students, because the engineering student's work is largely drawing, mathematics, and design, and there is but little opportunity for cultivating the use of language in such work; while in most other courses, the subject matter dealt with, and the manner in dealing with it, strengthens the capacity of the student in the use of his mother tongue. Further, the designing room and the drafting room and the technical lecture consumes so much of the student's time that he has much less opportunity than his fellow students to do assigned reading and therefore loses this educative influence.

What then can the engineering student do to prepare himself in this important phase of engineering education? In the first place, it is unfortunate that some engineering instructors set bad examples to engineering students in the use of language. The instructor often has for his chief aim the presenta-

tion of technical facts, and pays little or no attention to the language or to the intellectual development of those under his charge. Because this is so, and because of the nature of the college work in engineering, the student is left mostly to his own resources in cultivating this important phase of his education. But if he does not develop the ability to speak felicitously, fluently, and forcefully, before he leaves college, he is doomed to mediocre success. Therefore, he should watch his language in oral recitation, in written quizzes, and in examinations; and he should be exceedingly careful that he does not develop habits of looseness and confusion in his language. He should use his letters home as a means of cultivating one of the most important elements in the education of an engineer. Further, he should regard it as a real privilege to present carefully prepared papers before the technical society. Again, he should attend the meetings of the society and participate in the discussions of the papers in order that he may acquire facility in oral expression.

Let me repeat: I am very sure that one of the most serious weaknesses in the education of most engineering students is their inability to use their mother tongue reasonably well. I will go one step farther: I firmly believe that some engineers by

## Making of Clay Silo Bricks

(Continued from Page 19)

block thus making the row straight. Each row is tied to the next one, every third tile overlapping; that is, half of the tile on each row, which insures a strong bench and prevents the tile from falling. Between each row and bench is left a two inch space, so as to insure the tile a good chance to glaze during the process of burning. Upon each row near the door is left a space for placing the cones and trial pieces, which are used to test the heat in the kiln and also the texture of the ware. These are placed in after the blocks are all set and the doors ready to be closed.

After the kiln is full and everything is in readiness, the doors are closed by bricks or tile and covered with a mixture of clay, salt and sand; thus insuring a good strong door which will keep the cold air out and the hot air within. A small fire is then started in all fire boxes.

The firing of a kiln of ware is divided into three stages, viz., water smoking, oxidizing and vitrifying, and finishing. In water smoking the fires are started slowly and gradually increased until all of the water is driven out of the ware. The time required to water smoke the block depends upon the

type and condition of the ware when it is set in the kiln. The oxidizing stage is the stage in which all the impurities, such as iron and carbon, are driven out. If the impurities are not all driven out, they will discolor the ware. The oxidizing is accomplished by good, clean fires and plenty of air which insures good combustion. At all times the temperature of the kiln is increasing to the point of vitrification. Next comes the vitrifying stage which is accomplished at a temperature at about 2200° Fahrenheit in the low refractory clay. About 96 hours are consumed to reach the above temperature, at which time the glaze is put on the ware, by applying salt at each fire pocket. To insure a sufficient glaze, eight applications of salt are used.

After this the kiln is allowed to cool gradually. This usually takes about 96 hours, or about the same time as it takes to complete the burning. Great precaution has to be taken in cooling the kiln, so as not to allow too much of the cold air to strike the hot ware, which would cause it to air check. The last process is distributing and sorting of the finished blocks. When the kiln is sufficiently cool the blocks are sorted into two colors, dark and light, and taken upon wheelbarrows to the yard or

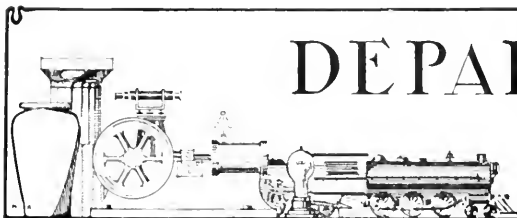

# DEPARTMENTAL NOTES

## Mechanical Engineering News

Classes in Machine Design, Thermodynamics, and Kinematics, have been moved into the new Mechanical Engineering quarters in the Transportation Building addition. Original plans for the Transportation Building specified that the north end of the structure should be left in an unfinished condition in order that the enlargement of the building might be effected by adding a north wing, when conditions became too crowded in the Engineering Hall.

Prof. C. W. Ham has resumed his work as head of the Kinematics department after a summer with the Gleason Gear Works, Rochester, N. Y. During the summer, Professor Ham had charge of the standardization work in establishing a new set of limits and tolerance for the bevel gear cutting machinery, which the Gleason Gear works specialize in.

The Mechanical Engineering Department has secured the services of E. J. Crane as assistant to Professor Ham in the department of Kinematics. Mr. Crane received his B.S. degree from Rutgers in 1915, and since that time has spent a year instructing in M. E. classes in the University of Porto Rico followed by two years of service with a field artillery division of the regular army. Mr. Crane received his M. E. degree at Rutgers June, 1921.

W. H. Foxwell is now assisting Prof. Leutwiler in his machine design classes. Mr. Foxwell spent nine months with the J. I. Case Company in Racine, designing tractors, prior to which he was associated with the Harding, Zook and Bahl Company, in the capacity of designer in the Aeronautical Department. Mr. Foxwell comes to Illinois direct from the University of Nebraska, where he completed his M. E. work last June.

L. C. Nichols, who has been engaged as instructor in the M. E. power laboratory, graduated from Lehigh University in 1919, and was for a time associated with the Ingersoll Rand Co. at Phillipsburg, N. J. in the testing department. Mr. Nichols then went with the Bethlehem Steel Co. at Sparrows Point, Md. where he remained as a construction

foreman until an injury temporarily incapacitated him. He comes to us direct from Lehigh where he has been instructing the past year.

The Mechanical Engineering Department has secured the services of Mr. P. E. Henwood, as instructor in Machine Design and Steam Engineering. Mr. Henwood received his B.S. from Armour Institute in 1910 and since then has been associated with the Worthington Pump Co., Holyoke, Mass. Mr. Henwood's work with this company has mostly been the design of high pressure hydraulic pumps to be used in connection with long distance oil lines, and heavy duty forging presses.

After an absence of two years Prof. W. H. Severns has been reengaged to instruct in the Steam Engineering laboratory. Prof. Severns was with the New Jersey Zinc Co., for a period of nine months as assistant Field Engineer. During this period he designed a waste gas boiler to be used in conjunction with a two-drum Stirling unit, the object being to utilize the heat in the waste gases from which the zinc oxide has been collected. During the past year he has served in the capacity of assistant Professor of Steam Engineering at the University of Wisconsin.

The latest addition to the equipment of the M. E. power laboratory is a 35 H. P. Hild Oil Engine. The specifications describe the unit as a 10 5/8" x 18" horizontal, four cycle engine, having a rated R. P. M. of 250, and 35 H. P. At present the machine is set to use kerosene as a fuel, but adjustments may be made to utilize "any fuel that flows".

The engine, which is manufactured by the Mid-West Company, is started by compressed air from a storage tank. The compressed air, however, works as a starter only, and is shut off when the motor starts running. The main difference between this type of oil engine, and the Deisel type is that the Hild unit does not have a compressor to compress the gas prior to the explosion, the regular Otto gas cycle being followed.



## Civil Engineering News

The first meeting of the student chapter of the American Society of Civil Engineers was a credit to both the officers and members of the organization. Mr. Sanders, '22, our newly elected President, opened the meeting by welcoming the freshmen C. E.'s and explaining to them the objects and merits of the organization. Mr. Sanders is well fitted for the position, for, besides being a very apt speaker, he has also quite a varied practical experience which will enable him to be especially useful to the undergraduate.

Prof. A. N. Talbot gave a short but interesting talk explaining the aims of the national organization of the A.S.C.E., its degree of membership, and its relation to the student chapters.

Prof. I. O. Baker also favored those present with a pointed address on the advantages of a student's affiliation with a student engineering society.

Among the "old timers" present was W. P. Pense '86, of the interstate commerce commission, who gave an informal talk on the old "Civil Engineers' Club" of 1883. Prof. Cross next pointed out the imperative need of the engineer being able to express himself in clear and concise language. This concluded the talks for the evening and the eighty members present indulged themselves in conversation and refreshments, which consisted of sandwiches, cake and milk.

The new student chapter of the American Society of Civil Engineers has sprung out of the oldest organization on the campus, the former C. E. Club. By affiliation the student has many advantages, such as being able to procure copies of the proceedings of the Society, accompanying inspection trips conducted for the members of the Society, buying any literature published at cost price, and also upon graduation saving a \$10.00 initiation fee when transferring to a Junior grade member. Besides having all the advantages of the A.S.C.E. the student chapter itself has many things to offer, such as interesting speakers and inspection trips to various industrial and commercial plants near here. It also is very helpful for the students to get together and exchange ideas.

We want to get a 100% freshman C. E. membership so come out to our next meeting.

The Civil Engineering Department has lost a very good man when Prof. Ellis decided to except the Vice-Presidency of the Strauss Bascule Bridge Co. of Chicago. Prof. Hardy Cross has come to us to fill this vacancy left by Prof. Ellis.

Prof. Cross attended Hampden-Sydney College

where he obtained his A. B. in '02 and his B. S. in '03. In '08 he obtained a C. E. degree at Mass. Inst. of Technology and his A. M. at Harvard University in '11. After leaving school he worked as a bridge engineer with the Missouri Pacific R. R. From 1912-1918 Prof. of Civil Engineering at Brown University Providence R. I. From 1918-1921 in private practice in Boston. Prof. Cross is an associate member of the A. S. C. E.

We are also fortunate to have Prof. C. B. Pyle added to our civil engineering faculty. Prof. Pyle obtained his B. S. in civil engineering at the University of Pennsylvania '22, and his C. E. in '17 at the same place. For two years after graduation he taught "Mechanics of materials and structures", at the University of Pennsylvania '11-'13. He then entered the employ of the McClinton Marshall Bridge Company, of Pittsburg, for eight years. The last three years with this company he had charge of the erecting department. His most noted work was the erection of the Sciotoville bridge over the Ohio River. This bridge has a record riveted span of 776 feet. He is also a member of the A. S. C. E.

---

## Architectural News

The Architectural Society held its first meeting recently in Ricker Library and formulated plans for a big year. Short talks were given by Professor Provine on the department and its work, by Professor Newcomb on his summers experience in Europe, by Professor Palmer on Arch Fete and department spirit, and by Mr. Hubbel on the Year Book. Later a general assembly or smoker will be given to help the students of the department and the faculty to become better acquainted.

The Arch Fete, the only thing of its kind during the year, promises to be even more inviting than the Egyptian and Futuristic fetes of the last two years.

The Architectural Year Book, the principal publication of the department, is under the direction of Mr. Hubbel, who is Editor in Chief. The Year Book was revived last year after wartime interruption. It contains the best and most representative work of the students and serves as an excellent record of the work of the department.

The Department of Architecture, with the finest working library in the country, and an excellent staff of instructors in architectural history, design and construction, has placed itself among the front rank of architectural schools.

Karnak Temple of Scarab Fraternity held its first meeting of the year on September 29th at the Phi Gamma Delta house. Much interest was manifested in the reading of two "Round-Robin" letters

circulated by the members during the summer. Last year Karnak Temple of Scarab Fraternity contributed a sum of fifty dollars to the Beaux Arts Institute of Architectural Design to be offered for the best solution of the Fifth Class "B" Esquisse Esquisse of the season. Several similar competitions are planned by Scarab for the coming year in addition to a number of social functions.

Several additions have been made to the Faculty of the Department of Architecture as follows:

William C. Titeomb as Assistant Professor of Architectural Design. He graduated from Harvard University in 1901 with the degree of Bachelor of Architecture, and received the degree of Bachelor of Science from the same institution in 1907. He was at the University of Illinois from 1913 to 1917, resigning to go into war work, with which he has been connected until the present time.

Prentice van Walbeek Dnell as Instructor in architectural history. He graduated from the University of California in 1916 with the degree of Bachelor of Architecture, and received the degree of Master of Arts from the University of Arizona in 1917. He is the author of two books, one entitled "Mission Architecture", the other, "Old Mission in and around Tucson".

Willard J. Perkins as Assistant in Architecture. Graduated from Carnegie Institute of Technology in 1921 with the degree of Bachelor of Architecture.

---

## Electrical Engineering News

The Electrical Engineering Society met on Friday, September 23rd, for the purpose of becoming better acquainted with the Freshmen and Sophomore electrical engineers. The large number that attended the meeting was very gratifying and spoke well for the interest in the Society. The President stated that this was the year for the electrical engineering show, and all were heartily in favor of having one. Professor Paine, head of the Electrical Engineering Department, several other members of the faculty, and Professor Knipp of the Physics Department were called upon for short impromptu talks.

There have been several additions to the Electrical Engineering Department. Among these are the following:

Cornelius S. Bullions, Instructor in Electrical Engineering. He graduated from Rensselaer Polytechnic Institute in 1916 with the degree of Electrical Engineer. Since graduation he has been employed by the General Electric Company where

he has had experience in the Testing and Turbine Construction Departments.

Charles A. Keener, Instructor in Electrical Engineering. He graduated from the University of Kansas in 1919 with the degree of B.S. in E.E., and received his Masters degree from the Massachusetts Institute of Technology in 1920. He attended the Test courses of the General Electric and Westinghouse Companies during the summers of 1918 and 1919. He is a member of Tau Beta Pi, Sigma Tau, and Sigma Xi.

Trice M. Bell, assistant in Electrical Engineering, graduated from the University of Kansas with the degree of B.S. in E.E. in 1919. Since that time he has been employed by the General Electric Co., Schenectady, N. Y., serving one year in the testing department, and one year as designing engineer.

Edward E. Perkins, assistant, graduated from the John Hopkins University in 1917 with the degree of B.S. in E.E.

Edward P. Price, assistant, graduated from the University of Texas in June, 1921 with the degree of B.S. in E.E.

Joseph T. Tykociner, Research Assistant Professor of Electrical Engineering for the Engineering Experiment Station. He graduated from the High Technical Institute at Cothen, Germany, in 1901 with the degree of Electrical Engineer. He was connected with the Russian Siemens and Halske Company of Petrograd for several years, and since September, 1920 he has been employed in the Westinghouse Research Laboratory, Pittsburg, Pennsylvania. He is the author of several articles on electricity, and is a member of the Institute of Radio Engineers.

---

## Ceramic News

Attendance in the Ceramic Department has been increased to about seventy-five. Mr. G. R. Shelton, graduate student in Ceramic Chemistry, and holder of the Fellowship for the National Research Council supported by the Corning Glass Works, is doing research on the viscosity of soda lime glass at high temperatures. Dr. Washburn and Dr. Bunting are preparing a bulletin on various methods of determining porosity of ceramic bodies for the Ceramic Engineering Experiment Station. Mr. Footit and Mr. Sladek have been former assistants in this work.

The Seniors go to St. Louis and Alton on this years inspection trip.

Mr. Libman has been made instructor in the course on Cements, previously instructed by Profes-

sor Hirsch. He will also give the instruction in the new course in Pyrometry to be given next semester. Details of this course are given elsewhere. Professor Hursh has been advanced from Assistant Professor to Associate Professor.

The Juniors and Seniors are finding life an uncertain proposition, they cannot be responsible for dates made more than a month in advance. There are two kilns or more to be fired every weekend, and an eight hour shift at heaving coal is as likely to come during a football game as during a house dance.

Professor R. K. Hursh, J. R. Green '22, and R. E. Lawrence '22, spent part of the summer with the Coates Manufacturing Co., at their hollow tile and building brick plant in Lawrence, Kansas. They made a survey of the clay resources and the manufacturing problems of the plant.

The new kiln machinery that was scheduled to be erected this year will not be available because of the State Legislature's cut in the University appropriation.

Professor Parmelee has been invited to serve as a member of the Advisory Committee on Molding Sand Research, of the Division of Engineering of the National Research Council. This committee also has to do with refractories as well as molding sands.

A new course of general interest to all engineering students has been added to the Ceramic curriculum to be given next summer. The course is as follows:

Ceramic Pyrometry.—Types of pyrometry, calibration, care, repair and use. Theory of temperature measurement. H (1)

Mr. Libman

Prerequisite: Physics 3b, 8b, or 10b, Inorganic Chemistry.

Seeger cones, firing disks and bars. The chemistry of the Seeger cone. Thermocouples, their operation, manufacture, repair and use. Types of protection tubes; fire clay, porcelain, alundum, carborundum and fused silica. Action of the protection tube, porosity and permeability, chemical and physical changes at high temperatures. The radiation and optical pyrometers; theory and use. Indicators, recorders and automatic regulators for kilns and furnaces. The pyrometer as an indicator of chemical and physical changes in ceramic bodies. Interpretation of pyrometric data. Influences of furnace gases and charges on different types of pyrometers. The placing of pyrometers in the furnace or kiln. Special pyrometric problems.

## Mining Engineering Notes

The first get-together of the Mining Engineers was held in the Main Lecture Room of the Commerce Building Friday evening, September 30th, as the Mining Society has outgrown its former quarters in the Mining Building. Professor Harry Stock told the miners of the history of the American Institute of Mining and Metallurgical Engineers and gave a complete analysis of the great organization and its importance as a means of contact between practicing engineers and those more versed in the theories of mining. Assistant Professor A. E. Drucker interested the men in the personal side of the Mining Society, illustrating the far reaching effects of friendships formed in such college societies with some of his own experiences while engaged in foreign projects.

The Society has planned a program of several smokers for the semester, the first of which was held Friday evening, October 14th. At the semi-monthly meetings the members will be shown motion pictures of *The Story of Coal*, and of *Metal Mining*; probably showing pictures of *Inspiration*, the largest copper mine in the World. Professor Drucker will be called upon for stories of his work and travels that have taken him twice around the world through the majority of the great mining centers.

The enrollment in the Mining Department has increased more than thirty percent over last year, which is the largest increase of any department of the College of Engineering.

Arthur J. Hoskins has been secured as Research Assistant Professor of Mining Engineering. He graduated from the University of Wisconsin in 1890 with the degree of Bachelor of Science, and received the degree of Mechanical Engineer in 1895. He was Chief for the Leydon Coal Company 1903-05, at the same time doing consulting work for the Moffet Coal Company. He has had extended experience as a professional Engineer, practicing throughout the United States in mining fields. He is author of "The Business of Mining", published by the Lippincott Book Company.

Cloyde M. Smith as Assistant in Mining Engineering; graduated from the University of Illinois in 1920 with the degree of B.S. in Mining Engineering. He was awarded Both Preliminary and Final Honors, and is a member of Tau Beta Pi. Since graduation he has been Chief Clerk in the Mining Department of the Integrity Mutual Casualty Company, Chicago.

My idea of activity is being a cheer-leader at a Deaf and Dumb Institution.

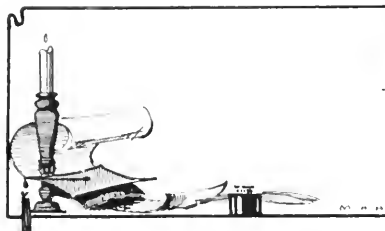

# A L U M N I N O T E S

## Frank Thomas Sheets

On September 20th, Frank T. Sheets, m. & s. e., '11, was appointed by Gov. Len Small to the position of Superintendent of Highways of the state of Illinois. Thus at the age of only thirty-one years, Mr. Sheets becomes the administrative head of a state highway organization, an organization which has already constructed more than 1200 miles of first class roads and is finishing its connected system of state roads with a bond issue program of \$60,000,000 to be carried out.

Mr. Sheets completed his course in municipal and sanitary engineering in 1911. His college work was truly remarkable. Among other things, he made preliminary honors, final honors, special honors, Tau Beta Pi, and Sigma Tau. Upon graduation he was appointed Assistant Engineer in the Illinois State Highway Department. He had previously been employed by this department in several minor capacities.

Mr. Sheets rose steadily through the ranks from the position of an engineering clerk in 1907, to that of engineer of design in the State Highway Department in 1919. In this latter capacity he supervised the work of the offices of road engineers, bridge engineers, and nine district engineers of the highway division on location, surveys, plans, estimates, and construction for work amounting to about \$35,000,000.

*V. L. Stroed*, m. & s. e., '19, who has been assistant village manager of Winnetka, Ill., has recently been made village manager of Kenilworth, Ill.

*Curtis C. Hubbard*, c. e., '09, min., '15, is in Gillespie, Ill., in charge of the structural work for the Superior Coal Co.

*Harry M. Wilton*, min., '21, who graduated with last year's class, is at the Union Mines of Upper Katanga, Belgian Congo, Africa. This place is located 2300 miles north of Cape Town, from which town all their supplies are gotten.

*Tiaph Witsen Tu*, ry. e. e., '09, is technical expert of the Chinese representation on the Inter-Allied Technical Board in China.

*Yin Hsiang Nin*, ry. e. e., '16, has also been appointed a member of the Inter-Allied Technical Board in the capacity of Chief Mechanical inspector. He was previously General Superintendent of Motive Power of the Chinese Eastern Railway, which road is now under the control of the Inter-Allied Board.

*Harlan C. Harbicht*, min., '18, is now located in Phoenix, Arizona.

*Ralph P. Brown*, c. e., '17, is doing research work in concrete for the United States Bureau of Standards. He visited the University on Sept. 17 while on his way to Washington on his honeymoon.

*Donald C. Johns*, min., '17, is with the Mission Mining Company in Ohio.

*H. A. Gallely*, m. e., '21, is connected with the Oklahoma Power Company at Tulsa, Okla.

*W. E. Billings*, m. e., '09, is Chief Engineer of the

W. J. Westaway Co., Ltd., at Hamilton, Ontario. *Prof. W. D. Pease*, c. e., '86, visited the University last month. He was formerly professor of theoretical and applied mechanics here, but is now valuation engineer of the interstate commerce commission in charge of valuation of railroads in the middle Mississippi valley.

*H. B. Dutton*, m. e., '17, is with the Armstrong Cork Company in Chicago. He was married the fifth of last month and is now living in Oak Park, Ill.

*W. E. Clelland*, m. e., '21, is teaching mechanical drawing and electrical mathematics, and also assists in coaching the football team at the Arsenal Technical High School in Indianapolis, Ind.

*P. F. Ling*, m. e., '21, is taking work along the line of naval architecture at the University of Michigan this year.

*R. S. Wiley*, arch., '00, who has been smelting engineer for the United Verde Copper Co. at Clarkdale, Ariz., has now moved to Bakersfield, Calif.

*H. G. Henares*, m. e., '21, is taking a special course in sugar engineering at the University of Louisiana.

*A. R. Beach*, m. e., '06, is Chief Engineer of the Tay-

lor-Wharton Steel Co., Highbridge, N. J.

*Ivan Lyons*, m. e., '18, is also connected with the engineering organization of the Taylor-Wharton Steel Co.

*H. P. Diescrud*, m. e., '18, was married recently and is living in Washington, D. C. He is Assistant Patent Examiner in the U. S. Patent Office.

*Charles Guthrie Boone*, m. e., '06, has been promoted to Assistant Manager of the DuPont Company at Philadelphia.

*E. G. Cadabal*, m. e., '21, has given up his plans of attending Boston Tech. and is home at Durang, Mexico.

*Harry H. Chapman*, m. e., '19, is still in the sales organization of the Westinghouse Electric Manufacturing Co. in Chicago.

*Canuto O. Borronco*, m. e., '15, is a member of the firm of the Philippine Engineering Co. at Cebu, P. I.

*I. W. Fiske*, e. e., '09, former assistant Professor in the E.E. department and later with J. Wheeler consulting engineer, is now with the Commission of Public Property in Springfield, Illinois, helping to organize a municipal electric plant.

*J. A. Golf*, m. e., '21, is back at the University of Illinois as assistant to Prof. Goodenough.

*R. L. Sandberg*, e. e., '14, is connected with the Chicago Union Station as a Designing Engineer.

*R. E. Shank*, arch., '22, is now located with a prominent architect in Indianapolis, Indiana.

*Henry Krüssinger*, m. e., '09, is in charge of extensive tests on the use of powdered fuel at the new Lakeside Power Station, Milwaukee, Wis.

*Francis J. Plym*, arch., '07, donor of the "Plym Fellowship" was a delegate at the International Rotary Club Convention in Edinburg, Scotland. He spent the remainder of the summer traveling through France and Italy.

*C. N. Williams*, e. e., '20, began work with the Westinghouse Company of East Pittsburg but was forced to leave on account of sickness. He returned to his home in California the latter part of August but expects to resume work soon.

*Archie Buyers*, m. e., '08, a former instructor, is now a Major in the Coast Artillery taking special work this winter at the Mass. Inst. of Technology.

*Dr. N. C. Ricker*, arch., '72, former head of the department of architecture and Dean of the College for 28 years, has just completed translating a book on "Graphic Statics", by Müller and Breslan. The typewritten translation will be added to the files of the Ricker Library.

*Robert S. Reese*, e. e., '12, who for several years has been interested in electrical utilities in Kentucky, is now living in Chicago where he is connected with the Western Electric Co. He also is in charge of the electrical classes in the Nicholas Semm High School of Chicago.

*E. E. Newcomb*, arch., '21, has been with Sousa's band during the summer but he is now visiting at the University.

*Ross S. Mason*, m. e., '16, is power engineer for the Wichita Falls Electric Co. of Wichita Falls, Texas.

*E. B. Baker*, cer., '21, is now working for the United States Bureau of mines at Columbus, Ohio.

*H. A. Huiskin*, cer., '20, is with the Vitrefax Company at Los Angeles, Cal. This company is producing superior refractories from fused magnesite and is also experimenting with the commercial production of sillimanite brick.

*C. H. Toruquist*, e. e., '07, now construction engineer for the Phoenix Utility Company, is in charge of the erection of the fourth power unit of their electric generating plant at Olmstead, Utah. The unit, when completed, will be the third largest of twenty-four plants in the system and will develop 7,700 horse power. It will serve a territory about 500 miles long.

## Modern Electric Locomotives

(Continued from Page 2)

necessary to maintain a higher pressure in a water pipe. To obtain this increased voltage, the current must be increased in the field, and this must be done by some outside source. In the early machines, a separate motor generator set was used, but in these new types of electric locomotives, a different system was employed. The disadvantage of the separate motor generator system occurs when the trolley loses contact with the wire. In this case, the voltage of the main motors rises and this causes the field excitation to be raised and the generated voltage rises even higher. This cumulative effect acts very quickly, and if it is not checked by an over-voltage relay, it is almost sure to cause some of the apparatus to flash.

In order to overcome this disadvantage, the Westinghouse Company has used an axle generator system; that is, the main motors are separately excited from an axle-driven generator whose fields are excited from a storage battery. The General Electric Company has connected the motors in such a manner that in regeneration the current from four of the main driving motors is used to furnish exciting current to the other eight driving motors.



### Can You Answer These ?

1. State Hoyles law.
2. Who wrote Taj Mahal?
3. Who found the "Lost Cord"?
4. What is the speed of rumor?
5. How many pigs in a litter of cast iron?
6. Explain Goldstein's theory of continuity.
7. What relation is Cy Ents to Miss Management?
8. Who was the fourteenth wife of Brigham Young?
9. What is Jamaica and in what proportions is it used?
10. What is the current flowing in the Orphom circuit?
11. Where are the "liquid assets" of the University located?
12. Determine the "probability factor" of board reductions this month?
13. If a 500 H.P. Illinois Central engine running at 50 mi. per hr. and having a net draw-bar pull of 39 tons and on a 1.23% grade passes a trolley car moving East, what is the name of the engineer's fifth child.

"Have you ever seen a three-seasoned watch, Hobson", queried the suit as he adjusted his tie.

"Never heard of such a thing, what do you mean", he replied.

"No spring in it", glibly retorted the s. m. as he flicked a speck of dust off his spats.

"Yes", returned the man from Arkansas, "it takes me quite a while to shave. I have to change blades in my safety-razor so often".

"Walled in, by gosh", said the drunken one after feeling around the lamp-post.

"They tell me that they have a drink in France made from prunes. They call it Prunell".

"That's nothing we have a drink over here made from rainens. We call it Raisenell".

Heard at the Auto Races at the Fair Grounds in Urbana.

"I saw you talking with Chevrolet, what did he have to say?"

"He told me to get off the track".

Tau Beta Cake announces the pledging of the senior who registered in seven hours and had a conflict.

Speaking of optimists—The bartender who still pays his dues to the Bartender's Union is a good example.

There's no excuse for anyone being a failure these days when you can get a book free that will tell you all about how to be a success.

"Did you see May?"

"May, May who".

"Mayonnaise".

"No, she was dressing".

Student to clerk in bookstore. "Let's see the last word in dictionaries. Clerk. "Here it is, Zythum".

"Did I tell you that Prof. Aigivees flunked me?"

"G'wan, you're fooling".

"That's what he said".

"Do you know the Alkchall sisters, Ethyl and Methyl?"

"No, but I know their brothers, Wood and Grain".

# 1921 greets 1925



“**F**EEELING blue?” asked the grad of four months’ standing. “Everything’s new and strange, isn’t it? I myself know how that feels. At my job in the electrical works I’m a freshman over agan—like you, a little frog in a big puddle.

“Not so easy, getting on to the ropes. Makes a fellow impatient for the time to pass. You’re anxious to get the upper hand over your work, you want to make the team, you want to clean up in general.

“Well, it can’t be done all at once. But getting off to a good start is half the game. Just pick out what you want the most and go after it hard.

“Tackle your obstacles—pretty tough now but after you’ve downed these you’ll find the going easier. Look on each week as a yard line you are crossing.

“See how every gain, every problem you get the best of, is important—not for itself but because it is a necessary part of the bigger drive that gets you down the field. Just keep plugging, with your heart in the game, and you’ll make your touchdown.

“Pretty good advice, isn’t it? Guess I’ll take it myself!”

*Published in  
the interest of Elec-  
trical Development by  
an Institution that will  
be helped by what-  
ever helps the  
Industry.*

## *Western Electric Company*

*Many of the men who started with this Company as “freshmen” are now, as its “seniors,” filling important executive positions in America, in Europe and throughout the whole world.*

# The Hudson River Vehicular Tunnel

(Continued from Page 7)

velocity in ft. per second depends on the amount (375,000 cu. ft. per min.) of air required for this section, and may run as high as 85 ft. per second or 5,900 ft. per minute. At this velocity take  $f = 0.00365$ . The value (f) depends on (V) and is obtained from the experimental data which is shown in Fig. 7 as the curve for coefficient of friction. All dimensions are readily obtained from the actual tunnel drawings. The value (d) = 0.975 lb. per cu. ft. for air at 70° F. and 29.92 inch barometer. The value (k) = 62.5 lb. per cu. ft. for water at 70° F.

(2) The elbow losses occur at (e<sub>1</sub>, e<sub>2</sub> and e<sub>3</sub>), and can be expressed as the equivalent feet. (X) of straight duct found in the experimental work for each of these types of elbows.  $X = X_1 + X_2 + X_3$ . This elbow loss head is indicated as (h<sub>4</sub>). If desired, (L) as used in obtaining (h<sub>1</sub>) may be taken as the measured length of (a, b and c) plus (X), in which case it includes (h<sub>4</sub>).

(3) The friction losses (h<sub>1</sub>) occurring in the lower duct (d) are overcome by the velocity pressure at entrance to this duct plus whatever additional static pressure may be found necessary for a duct of these proportions as determined from the experimental work. It is first necessary to calculate the total pressure for such a duct with all the air going all the way. By use of the proper experimental ratio already discussed, it is possible to reduce this head to conform with the actual tunnel duct conditions. In the long under river sections the ratio is about 1.5. The second method by direct computation for total head may also be used.

(4) Finally, it is necessary to allow for a suitable "tail pressure" (h<sub>5</sub>) at the bulkhead, which has also been experimentally determined, so that the minimum static pressure in the duct is not less than 0.25" at any section. See Fig. 5, Case II, and note that the minimum static pressure is *not* at the bulkhead, and in some cases may even be at the entrance end of the lower duct. This was one of the most important factors discovered in the experimental work. A minimum of 0.25" was found necessary to get the air out of the ports and into the roadway.

By adding all of the four heads just described together, the total pressure (inches of water) required of the fan is obtained. It is important to note that as the velocity head is all transformed in the lower duct for overcoming friction in that duct it has been accounted for in section (3) above.

The air horsepower is then,

$$\frac{(h_1 + h_2 + h_3 + h_4) \times Q \times 62.5}{33,000 \times 12}$$

Q = cu. ft. of air flowing per minute.

The fan horsepower will depend on the fan efficiency which may be taken at 70% for large units. The method of connecting fans to motors is not yet settled so a safe drive efficiency of 95% may be used, and a motor efficiency of at least 90% should be allowed.

The power input for ventilation, if based on the above efficiencies, is:—

$$\frac{\text{Air horsepower}}{0.70 \times 0.95 \times 0.90}$$

The experimental work done at the University of Illinois was for the sole purpose of securing accurate data for the computation of the heads (h<sub>1</sub>, h<sub>2</sub>, h<sub>3</sub> and h<sub>4</sub>) which represent the various frictional resistances to be overcome in the ventilating system.

I see where Professor Goodenough's steam tables have been installed in the campus restaurants.

## Green Tea Pot

*Green Street*

<p><b>LUNCH</b> From 11:30 to 1:30</p> <p><b>AFTERNOON LUNCH</b> From 3 to 5</p> <p><b>DINNER</b> 5:30 to 7</p>		<p><b>SUNDAY DINNER</b> 12:30 to 2:00</p> <p><b>EVENINGS</b> From 5:30 to 7:30</p>
---	---	--

Variety in Everything Except Quality

We Cater to Those Who Care



## Immediate Delivery

We are now able to ship promptly on receipt of order, a full line of:

Drawing Instruments  
 Drawing Boards  
 Triangles and Tee Squares  
 Surveying Instruments  
 Tapes and Chains  
 Cross Section Papers  
 Tracing Cloth and Papers  
 Scales, Etc.

These goods are all in stock. Quotations gladly given. Write for illustrated catalogue and for literature and very attractive prices on various grades of drawing instrument sets.

**New York Blue Print Co.**

102 Reade Street New York City



## Engineering Service

Allis-Chalmers engineering service is of the utmost value to a user in the selection of equipment suited to his particular conditions and in its economical operation for maximum plant efficiency.

Allis-Chalmers power equipment includes prime movers of all types with complete electrical equipment "from prime mover to switchboard", power and distributing transformers, motor generators, rotary converters, motors for all classes of service, air compressors, pumping equipment, etc.

Let us help you solve your power problems.

Our engineers are always pleased to be consulted.

### ALLIS-CHALMERS PRODUCTS



Air Brakes	Metallurgical Machinery
Air Compressors	Mining Machinery
Cement Machinery	Oil Engines
Condensers	Perforated Metals
Crushing Machinery	Pumping Machinery
Electrical Machinery	Reciprocating Pumps
Electric Hoists	Saw Mill Machinery
Farm Tractors	Steam Engines
Flour Mill Machinery	Steam Hoists
Forgings	Steam Turbines
Gas Engines	Timber Treating and
Hydraulic Turbines	Preserving Machinery

**ALLIS-CHALMERS**  
 MILWAUKEE, WIS. U. S. A.



The "Economic"

## The Erie City Iron Works

Erie, Penn., U. S. A.



Vertical Water Tube

Manufacturers of

**Steam Engines, Steam Boilers, Tanks,  
 Steel Plate Construction**

**"The Big Four"  
 of Boilerdom**



Return Tubular Stationary

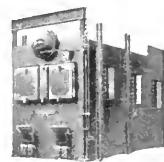

Horizontal Water Tube

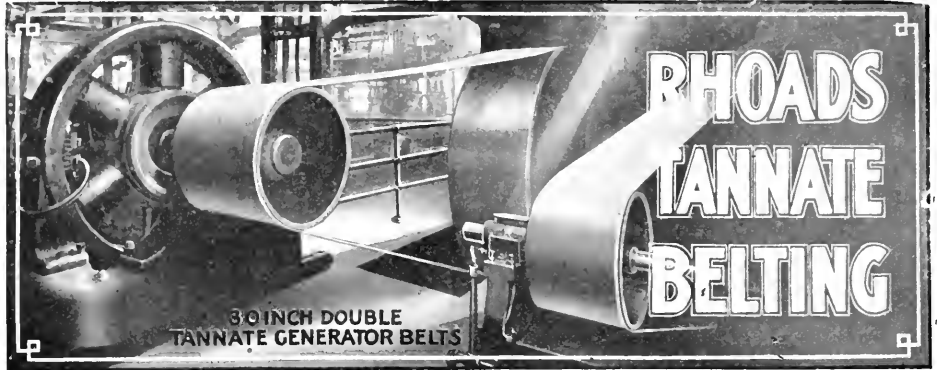

## Service That Means Economy

CONTINUOUS output requires continuous operation of machines. Time spent in repairs and power lost by slippage may be reduced to a minimum by the right leather belting.

On the drives shown above Rhoads Tannate Belts are proving their economy in service. For nineteen years the company using these has been buying Rhoads Belts. Of recent years they are using more and more Rhoads Tannate and Rhoads Watershed Tannate Belting. The latter they find particularly economical and satisfactory.

Shop and factory managers find that Rhoads Belts mean economy of power. It is not the first cost of a belt, but the service you get that counts. Rhoads Belts have a grip that stops the slip. They cost less per year, because they give so little trouble and last so long.

### *Rhoads Leather Belt Preserver*

*To keep belts tough and flexible, use Rhoads Leather Belt Preserver on your Watershed and all other leather belts. It keeps them in best condition and increases power transmission.*

## J. E. RHOADS & SONS

PHILADELPHIA  
14 N. Third Street

NEW YORK  
144 Beekman Street

CHICAGO  
314 W. Randolph Street

FACTORY AND TANNERY: WILMINGTON, DEL.

## ROTH'S HARDWARE

THE WINCHESTER STORE

Hardware  
Cutlery  
Tools  
Rope  
Ammunition  
Sporting Goods  
Household Hardware

28 Main St.

Champaign

## Corona-Royal Typewriter Agency

*We Sell Them on Terms to Suit You*

Typewriters for Rent

**R. C. WHITE & CO.**

Main 922

612 E. Green St.

# THE PLAYMOR BILLIARD PARLOR

*Cigars, Candies and Sodas*

11 BRUNSWICK TABLES

Race St., Urbana



PHOTO-ENGRAVINGS  
ETCHINGS  
COLOR PLATES  
Indispensable to  
the successful  
publication

**G. R. GRUBB & CO.**  
ENGRAVERS  
CHAMPAIGN ILLINOIS

# Students!

Have you tried the Laundry  
Depot System on your  
Laundry and  
cleaning?

IT PLEASES

White Line Laundry

Main 406



ENGINEERING, Architectural and Art equipment and materials constitute a considerable permanent investment for every student in those courses. Such investments should be made carefully. True economy dictates the purchase of only the best, well-established makes. It is of such makes that our stock consists. We will be glad to show them.

*WE invite Engineers, Architects and Art Students to inspect our stock and our prices; we know that no better instruments, materials, and supplies can be found than we handle. We offer the expert advice of experienced salesmen; and we are glad to have our prices compared with those of any dealers offering the highest quality.*

WIRELESS OUTFITS

## U. of I. Supply Store

Green and Wright

ON THE SQUARE

Champaign

# Champaign's

## Greatest Store For Men and Young Men

THIS IS A STORE THAT HAS SERVED THE STUDENTS AND FACULTY MEMBERS FOR FORTY YEARS . . . .

A VISIT HERE WILL DEMONSTRATE HOW THIS STORE HAS GAINED IT'S LEADERSHIP AS CHAMPAIGN'S GREATEST STORE FOR MEN.

**J.M. KAUFMAN**  
**AND COMPANY**  
UNINCORPORATED

Central Illinois' Largest, Livest Store, Specializing  
in Mens', Womens' and Boys' Wearing Apparel

# Chicago Steel Tape Company

6231 Cottage Grove Ave., Chicago, Ill.



Manufacturers—Surveying Implements, Tapes, Leveling Rods, Self-Computing Rods, Stadia Rods, Rod Ribbons, Targets, Marking Pins, Lining Poles, Eureka Tape Repairers, Etc., Etc.,

## Individual and Distinctive Gifts

From

*Strauch's*

Art Pottery and Bronze, Cordova Hand Tooled Leather, Art Metal and College Jewelry, Framed and Unframed Pictures, Wallace Nutting Prints, Carved Portrait Frames, Art Lamps, Electric Gift Utensils.

Crane's Stationery in Gift Boxes, Large Prints from Your Kodak Film, Gold Mounted Fountain Pens and Gold Pencils, Artistic Greeting Cards, Greeting Cards with Illino's Seal, Photo and College Memory Books.

*Visit Strauch Photo Craft House when selecting your Holiday Gifts*

Just Two Places  
to Eat—  
At Home and

### Gehrig's Cafeteria

20-22 Main St.

### Lillard-Getman-Hughes Furniture Company

44-46 Main Street  
CHAMPAIGN

Complete Home Outfitted

Cash or Credit

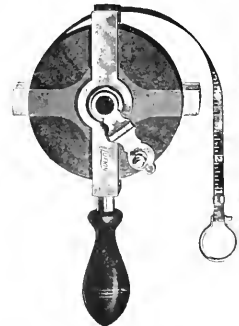
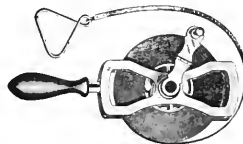
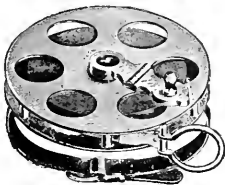

## LUFKIN TAPES

ALL STYLES

Longest, Most Satisfactory Service

Send for Catalogue **THE LUFKIN RULE CO.** Saginaw, Mich.  
New York, London, Eng. Windsor, Ont.

# Kansas for KOEHRING

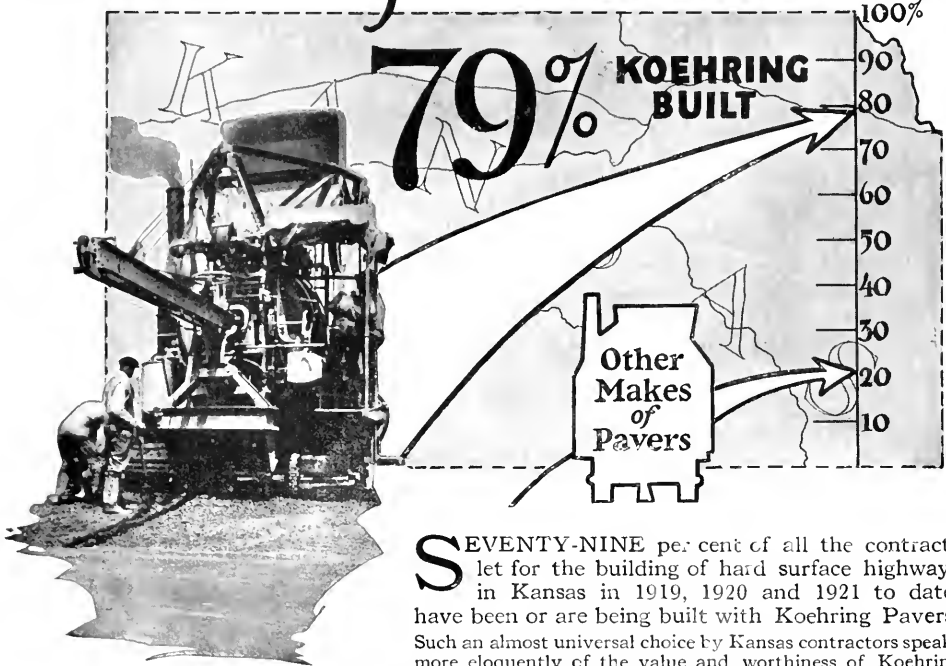

**S** EVENTY-NINE per cent of all the contracts let for the building of hard surface highways in Kansas in 1919, 1920 and 1921 to date, have been or are being built with Koehring Pavers. Such an almost universal choice by Kansas contractors speaks more eloquently of the value and worthiness of Koehring Pavers than pages of advertising could possibly do.

Here are the statistics:

Total number miles of concrete road let to date in Kansas.....	181,349
Total number miles of brick road let to date in Kansas.....	60,043
Total mileage of hard surfaced roads let.....	241,392
Mileage paved or being paved with Koehring machines.....	191,309
Mileage paved or being paved with all other machines.....	50,083
Percentage of Koehring paved roads.....	79.249
Percentage of roads paved with all other machines.....	20.752

Of the 181,349 miles of concrete roads let, 137,224 miles, or 75.668% are Koehring built roads. And of the 60,043 miles of brick roads let, 54,085 miles, or 90.077% are constructed with Koehring pavers.

The customer is the final judge of worth. And 79% of the state hard road builders of Kansas back their judgment that the Koehring Heavy Duty paver is the paver of absolute dependability.

Koehring re-mixed concrete is **DOMINANT** strength concrete.

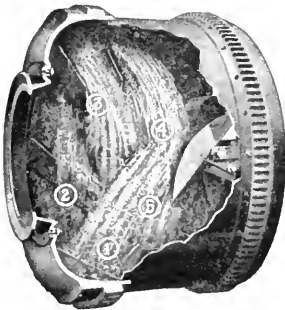

**KOEHRING COMPANY**  
MILWAUKEE, WISCONSIN

# KOEHRING

## BRINGING MORE DAYLIGHT INTO INDUSTRIAL BUILDINGS.

Dr. George M. Price, writing on "The Importance of Light in Factories," in "The Modern Factory," states: "Light is an essential working condition in all industrial establishments, and is also of paramount influence in the preservation of the health of the workers. There is no condition within industrial establishments to which so little attention is given as proper lighting and illumination. Especially is this the case in many of the factories in the United States. A prominent investigator, who had extensive opportunities to make observations of industrial establishments in Europe as well as in America, states: "I have seen so many mills and other works miserably lighted, that bad light is the most conspicuous and general defect of American factory premises."

"My own investigations for the New York State Factory Commission support this view. In these investigations it was found that 36.7% of the laundries inspected, 49.2% of the candy factories, 48.4% of the printing places, 50% of the chemical establishments, were inadequately lighted. There was hardly a trade investigated without finding a large number of inadequately lighted establishments."

Inadequate and defective lighting of industrial buildings is not confined to the establishments in New York State alone. The same conditions prevail in most sections of the country.

Such conditions as mentioned above are entirely opposed to the laws of health, sanitation and efficiency. Wherever poor lighting conditions prevail, there must be a corresponding loss of efficiency and output both in quality and in quantity. American industry is not using nearly enough daylight and sunlight in its buildings. Every endeavor should be made to use as much as possible of daylight for lighting purposes. To obtain this it is of course necessary that the rays of daylight and sunlight are permitted to enter the interior of the buildings as freely as possible, with the important modification that the direct rays of the sun must be properly diffused to prevent glare and eyestrain. A glass especially made for this purpose is known as Factrolite, and is recommended for the windows of industrial plants. Windows should be kept clean if the maximum amount of daylight is to pass through the glass, but the effort will be well repaid by the benefits secured.

In the presence of poor lighting, we cannot expect men to work with the same enthusiasm as when a well lighted working place has been provided. The physical surroundings have a deep effect upon the sentiments of the employes, and where bad working conditions are allowed to prevail, there is invariably a lessening of morale and satisfaction created thereby. Neglecting to utilize what nature has so bounteously provided, daylight, and which is so essential toward industrial efficiency, we have an instance of wastefulness, but now that the importance of good lighting is becoming recognized, undoubtedly more attention will be given by progressive industrial employers to furnishing the means which are essential for their workers to secure and maintain the efficiency, which counts for so much in the success of any industrial concern in this competitive age.

If you are interested in the distribution of light through Factrolite, we will send you a copy of Laboratory Report—"Factrolitied."

MISSISSIPPI WIRE GLASS CO.,

220 Fifth Avenue,

St. Louis.

New York.

Chicago.

No. 3.

## WESTERN BRICK COMPANY

Manufacturers of  
Artistic Facing Brick  
Hollow Building Tile  
and Common Brick

DANVILLE, ILLINOIS



## You Can Benefit

by our policy of reasonable prices, service and satisfaction. Many have profited by it, and are using our

**Drawing Materials  
Surveying Instruments  
Measuring Tapes**

Buy the DIETZGEN product and obtain the quality and merit which has caused our goods to be accepted as the STANDARD.

*Catalog on Request*

### EUGENE DIETZGEN CO.

*Branches:*

Chicago    New Orleans    New York    San Francisco  
Pittsburgh

*Sales Offices:*

Philadelphia    Washington



## What Type of Bearing Shall I Use?

In selecting the type of bearing to be used in any installation the nature and size of the load and the conditions of operation must be considered.

If the load is entirely radial a radial bearing of the proper size will do the work. Such a bearing will also handle a slight thrust load.

In most installation with both a thrust and radial load it is better to use an angular contact bearing or both a radial and a thrust bearing. For ordinary use Strom radial bearings of the 200, 300 and 400 series

made to an international standard are most desirable. Angular contact bearings interchangeable with the above sizes can be obtained. Thrust bearings for single or double acting duty are made in all sizes, with or without the self-aligning features.

Detailed information on bearing design and installation is contained in our pamphlets: Lubrication of Ball Bearings; Limits and Allowances on Shafts and Housings; Calculating Bearing Loads; Interchangeable Sizes of Strom Bearings.

Write for them.

**THE U. S. BALL BEARING MFG. CO.**

(Conrad Patent Licensee)

4559 Palmer Street, Chicago, Illinois

**Strom**  
**BEARINGS**





*The man whose courage and foresight gave alternating current to America, and founded the Westinghouse industries.*

---

---

## George Westinghouse

Thirty years ago the alternating current system was but an infant, for whose life those who believed in it were fighting daily and nightly battles; today this same system is a giant of almost inconceivable size, so capable of defending itself that no one seeks to attack it. For 95% of the electricity that is generated and transmitted today is alternating current.

The story of the development of alternating current is a story of courage and vision and faith; of misunderstanding and misrepresentation; of engineering failures and triumphs; of commercial ability and organization. It reads like a classic romance. In its chapters are credit and honor for all who have deserved it, but the central figure, the man whose motives and acts furnished the basis of the plot, was George Westinghouse, the founder of the Westinghouse Industries.

When, in 1886, he brought over from Europe the crude Gaulard and Gibbs system, even he, great as was his foresight, did not dream of the coming magnitude of the idea which he was fostering. The development work undertaken by the strong engineers whom he put to work led at first into many serious differences with those who favored direct current. Legislatures were even impor-

tuned to prevent the use of the "deadly Westinghouse Current," as many extremists described it.

That the little 50 horsepower generators of those days have grown to sizes two thousand times as large; that stations of a few horsepower have been succeeded by stations with a capacity of hundreds of thousands of horsepower, while at the same time, distribution voltages have grown from 1,000 to 220,000, is due largely to the vision and the courage of George Westinghouse, and to the qualities of the engineers whom he called, characteristically, to help him. By no means the least of the achievements of this man was his ability to organize the greatest aggregation of engineering intelligence ever known, men of analytical ability, consummate mathematicians, great inventors; and to promote in this great group the most harmonious and intelligent co-operation.

The same energy and courage and purpose that forced the acceptance of the air brake, the modern systems for the economic and safe distribution of natural gas, and later of the steam turbine, led and won the fight for alternating current, which has grown to be one of the world's greatest and most necessary commodities.

---

---

# Westinghouse

---

---



—“WHAT OTHER ENGINEERS  
ARE DOING”

E

SPECIALLY for Hydro-Electric projects the engineers of the country are “tightening up” considerably on their interpretation of “quality”. Their specifications are becoming more and more rigid. Their demands for more dependable materials bespeak of a strong determination to acquire a smooth and efficiently operating System when the work is completed. These Engineers are combing the market for the best equipment that money will buy. Not necessarily the highest in price, mind you, for economy can only be preserved with efficiency.

And right there is the secret of the increasing demand for **Thomas LINK-TYPE Insulators**. Engineers who have investigated have learned that there IS a way to efficiently and economically insulate their lines and that by using the **Thomas LINK-TYPE** they CAN maintain a smoothly operated System.

Those sturdily designed, free-porcelain and cementless **LINK-TYPES** can also do wonders on your lines. *Have you investigated?*

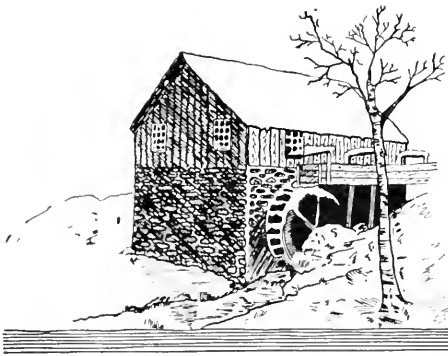

The R. Thomas & Sons Company  
East Liverpool, Ohio  
U. S. A.

NEW YORK      BOSTON      CHICAGO      LONDON

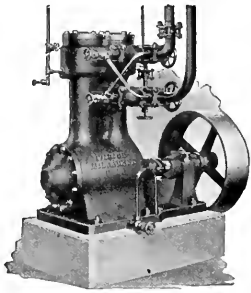

Established 1867

# The Vilter Manufacturing Co.

1020 Clinton St., Milwaukee, Wis.

Ice Making and Refrigerating Machinery  
Corliss and Poppet Valve Engines

Branch offices in all principal cities

*If interested write for bulletins*

Steel Cased Setting  
Increase Efficiency

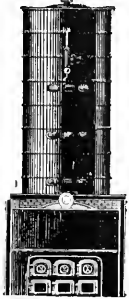

## Wickes Vertical Water Tube Boiler

Have you seen the STEEL CASED SETTING for enclosing this boiler?  
Air infiltration losses are overcome.  
The highest possible thermal efficiency results.

Ask for bulletin—Magnitude and Prevention of Air Infiltration  
Losses—sent free.

Ever cleaned a boiler, lamed your back, bruised your knees and skinned  
your elbows doing it?

Two men can open, wash, close and fill the WICKES in five hours. Tur-  
bin in ten hours.

Ask for Bulletin—Reducing Costs on the Boiler Room—sent free

## The Wickes Boiler Company

SAGINAW, MICHIGAN

SALES OFFICES

New York City, 1716 West St., Bldg.  
Chicago, 76 West Monroe St.  
Boston, 201 Devonshire St.

Pittsburg, 1218 Empire Bldg.  
Detroit, 1116 Fenrose Bldg.  
Seattle, 736 Henry Bldg.

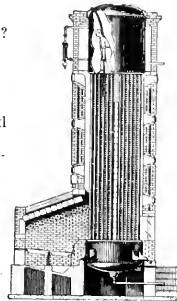

Man Stands erect (Cleaning)

## Index to Advertisers

Allis Chalmers Mfg. Co. . . . .	V	New York Blue Print Co. . . . .	V
Chicago Steel Tape Co. . . . .	IX	Otis Elevator Co. . . . .	XVI
CO-OP Store . . . . .	VIII	Pease Co., C. F. . . . .	II
Engineers' Co-operative Store . . . . .	II	Rhoads, J. E. & Sons . . . . .	VI
Eugene Dietzen Co. . . . .	XI	Roth's Hardware Co. . . . .	VII
Erie City Iron Works . . . . .	V	Sampson Spot Sash Cordage . . . . .	XV
Gelvin Clothes Shop . . . . .	I	Stockham Pipe & Fittings Co. . . . .	Inside Front Cover
General Electric Co. . . . .	Back Cover	Student Supply Store . . . . .	I
Green Tea Pot . . . . .	IV	Strauch Art Shop . . . . .	IX
Grubb, G. R. & Co. . . . .	VII	R. Thomas & Sons Co. . . . .	XIV
Hercules Powder Co. . . . .	Inside Back Cover	U. S. Ball Bearing Co. . . . .	XII
Kaufman, J. M. & Co. . . . .	VIII	Vilter Mfg. Co. . . . .	XV
Koehring Machine Co. . . . .	X	Western Brick Co. . . . .	XI
Lillard Getman & Co. . . . .	IX	Westinghouse Electric & Mfg. Co. . . . .	XIII
Lufkin Rule Co. . . . .	IX	Western Electric Co. . . . .	III
Maguire Studio . . . . .	I	White Line Laundry . . . . .	VII
Mississippi Wire Glass Co. . . . .	XI	White, R. C. & Co. . . . .	VII
Mouyious Brothers . . . . .	VII	Wickes Boiler Co. . . . .	XV

## SAMSON SPOT SASH CORD



SAMSON CORDAGE WORKS, BOSTON, MASS.

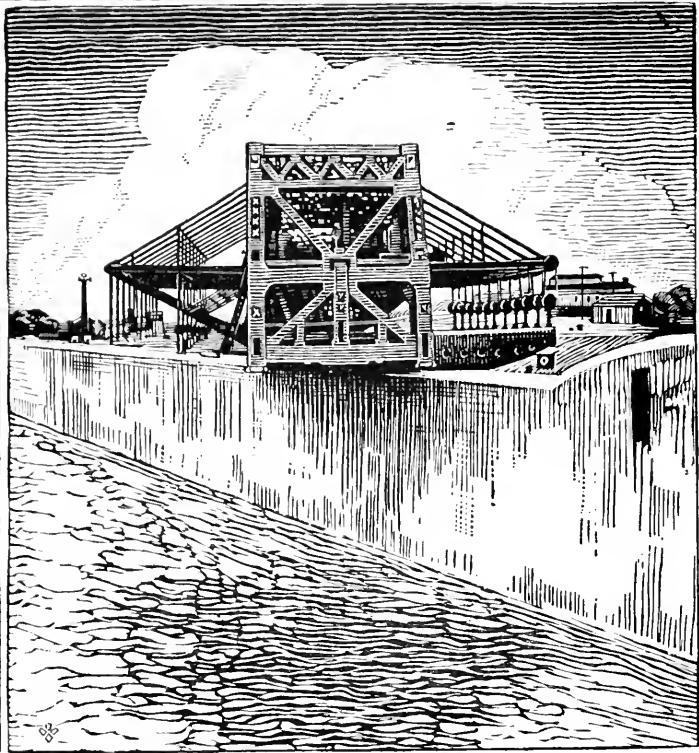

The WORLD'S WORD for  
ELEVATOR SAFETY



The WORLD'S WORD for  
ELEVATOR SAFETY

## PANAMA CANAL EMERGENCY DAMS

**G**ATUN LAKE, eighty-five feet above sea level, is the reservoir holding the water to feed the Gatun Locks (which lead to the Atlantic) and the Miraflores and Pedro Miguel locks on the Pacific end of the canal.

Every ship going through the canal in either direction uses the water from Gatun Lake to lift it from the one ocean and lower it into the other. Should some accident destroy a lock, the weight of the water released might force down the others and cause tremendous damage and, by lowering the level of the lake, make the canal inoperative until rain had refilled the lake.

Therefore these big emergency dams were constructed. Normally they are not used. In emergencies they would be swung over the locks, the gates would drop into position and effectually dam the opening.

Otis engineers designed, constructed and installed the machinery for operating six of these gigantic dams. It is a feat typical of the world-wide scope of Otis activities in engineering and the vertical transportation of men and materials.

*Most of the famous buildings of the world  
are equipped with Otis Elevators.*

**OTIS ELEVATOR COMPANY**

Offices in all Principal Cities of the World

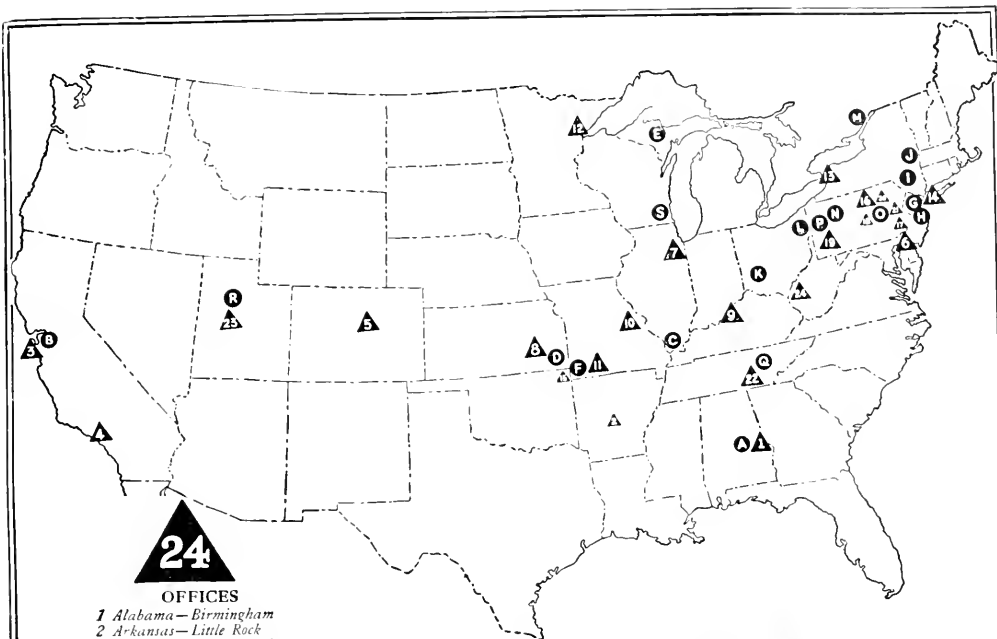

**24**

**OFFICES**

- 1 Alabama—Birmingham
- 2 Arkansas—Little Rock
- 3 California—San Francisco
- 4 California—Los Angeles
- 5 Colorado—Denver
- 6 Delaware—Wilmington
- 7 Illinois—Chicago
- 8 Kansas—Pittsburg
- 9 Kentucky—Louisville
- 10 Missouri—St. Louis
- 11 Missouri—Joplin
- 12 Minnesota—Duluth
- 13 New York—Buffalo
- 14 New York—New York City
- 15 Oklahoma—Commerce
- 16 Pennsylvania—Hazleton
- 17 Pennsylvania—Norristown
- 18 Pennsylvania—Pottsville
- 19 Pennsylvania—Pittsburgh
- 20 Pennsylvania—Wilkes-Barre
- 21 Pennsylvania—Allentown
- 22 Tennessee—Chattanooga
- 23 Utah—Salt Lake City
- 24 West Virginia—Huntington

## Hercules Service Strengthened

The acquisition of the business and properties of the Aetna Explosives Co., Inc., by the Hercules Powder Co., adds additional significance to the words *Hercules Service*.

There are now 19 plants manufacturing Hercules Explosives and Blasting Supplies, and 188 Hercules-owned main distributing magazines in addition to many dealers situated in all sections of the country, who own magazines and carry stocks of Hercules Products. The 24 Hercules Sales Offices are shown on the map above.

If you are interested in the elimination of waste in industry, put the Hercules Service Division to work on your blasting problems. It will cost you nothing and is apt to save you money.

By acquiring the business of the Aetna Company, we have assumed increased service obligations to the users of explosives all over the country and shall welcome any opportunity to demonstrate our readiness and ability to meet them.

Book describing Hercules Products furnished on request.

**19**

**PLANTS**

- A Alabama—Birmingham
- B California—Hercules
- C Illinois—Eayville
- D Kansas—Turck
- E Michigan—Ishpeming
- F Missouri—Joplin
- G New Jersey—Kenil
- H New Jersey—Parlin
- I New York—Port Exwen
- J New York—Schaghticoke
- K Ohio—Goes
- L Ohio—Youngstown
- M Ontario—Prescott
- N Pennsylvania—Emporium
- O Pennsylvania—Ferndale
- P Pennsylvania—Sinnamahoning
- Q Tennessee—Marlow
- R Utah—Bacchus
- S Wisconsin—Pleasant Prairie



**HERCULES POWDER CO.**

945 King Street

Wilmington

Delaware





## Why Is Iron Magnetic?

A horse-shoe magnet attracts a steel needle. But why? We don't know exactly. We do know that electricity and magnetism are related.

In dynamos and motors we apply electro-magnetic effects. All our power-stations, lighting systems, electric traction and motor drives, even the ignition systems of our automobiles, depend upon these magnetic effects which we use and do not understand.

Perhaps if we understood them we could utilize them much more efficiently. Perhaps we could discover combinations of metals more magnetic than iron.

The Research Laboratories of the General Electric Company investigate magnetism by trying to find out more about electrons and their arrangement in atoms.

X-rays have shown that each iron atom consists of electrons grouped around a central nucleus—like planets around an infinitesimal sun. X-rays enable us to some extent to see into the atom and may at last reveal to us what makes for magnetism.

This is research in pure science, and nothing else. Only thus can real progress be made.

Studies of this kind are constantly resulting in minor improvements. But some day a discovery may be made which will enable a metallurgist to work out the formula for a magnetic alloy which has not yet been cast, but which will surely have the properties required. Such a result would be an achievement with tremendous possibilities. It would improve all electric generators, motors, and magnetic devices.

In the meantime the continual improvement in electrical machinery proceeds, in lesser steps. These summed up, constitute the phenomenal progress experienced in the electrical art during the past twenty-five years.

**General Electric**  
General Office  **Company** Schenectady, N. Y.

95-45911

# THE TECHNOGRAPH

PUBLISHED QUARTERLY BY THE STUDENTS OF THE  
COLLEGE OF ENGINEERING UNIVERSITY OF ILLINOIS



JANUARY

1922

FOUNDED · EIGHTEEN · HUNDRED · AND · EIGHTY · FIVE  
VOL. XXXIV · PRICE · 40 · CENTS · NUMBER 11



EQUALLY SERVICEABLE FOR STEAM, WATER, GAS OR AIR

**S**  
**FITTINGS**

WITH CHAMFERED FACES  
GO ON EASY

▼

CATALOG  
UPON REQUEST

STOCKHAM PIPE & FITTINGS CO., BIRMINGHAM







**W. Lewis & Co.**  
CHAMPAIGN

T  
I  
T  
E  
WAD'S

Lunch Room

Good Eats That  
Hit the Spot

Mathews Avenue  
URBANA



ENGINEERING, Architectural and Art equipment and materials constitute a considerable permanent investment for every student in those courses. Such investments should be made carefully. True economy dictates the purchase of only the best, well-established makes. It is of such makes that our stock consists. We will be glad to show them.

We invite Engineers, Architects and Art Students to inspect our stock and our prices; we know that no better instruments, materials, and supplies can be found than we handle. We offer the expert advice of experienced salesmen; and we are glad to have our prices compared with those of any dealers offering the highest quality.

WIRELESS OUTFITS

**U. of I. Supply Store**

Green and Wright

ON THE SQUARE

Champaign

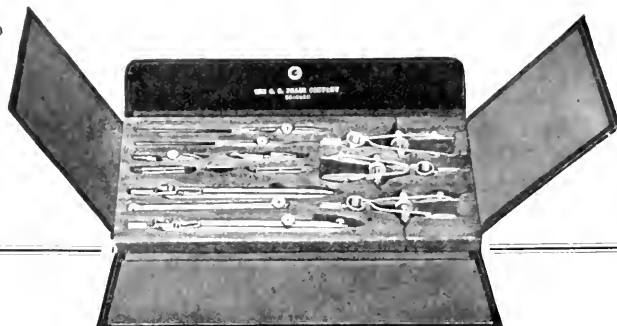

## American Made Drawing Instruments

Manufactured By

THE C. F. PEASE COMPANY, Chicago, Illinois

Are unexcelled in accuracy, quality, workmanship and finish. They contain that degree of precision and proper balance only obtained in high grade drawing instruments.

### ENGINEERS!

Buy Better Quality for Less at Your  
Own Store

---

*Fountain Pens, Slide Rules, "T" Squares  
Triangles, General Supplies*

---

### Specials!

*Spring Back Notebooks*

*Autopoint Pencils*

---

## Engineers' Co-Operative Society

Boneyard and Mathews

J. R. Lindley, Manager

# The TECHNOGRAPH

UNIVERSITY OF ILLINOIS

VOLUME XXXIV

NUMBER II

## *Contents for January*

DE PONTIUS . . . . .	41
<i>Rejford Newcomb</i>	
THE OCEAN WORK OF THE CARNEGIE INSTITUTE . . . . .	47
<i>R. R. Mills</i>	
THE PHYSICAL BASIS OF THE THEORY OF RELATIVITY . . . . .	49
<i>Jakob Kunz</i>	
THE FLOW OF AIR IN TUNNELS . . . . .	51
<i>G. A. Goodenough</i>	
THE STUDENT COUNCIL . . . . .	53
<i>R. A. Malcomson</i>	
THE CHICAGO, MILWAUKEE AND ST. PAUL ELECTRIFICATION . . . . .	54
<i>V. Beggs</i>	
MODERN TENDENCIES IN STREET RAILWAY OPERATION . . . . .	56
<i>P. J. Boesch</i>	
THE SCARAB COMPETITION . . . . .	59
<i>1920-1921</i>	
BOOKS BY ENGINEERING PROFESSORS . . . . .	59
THE NEW AKRON VIADUCT . . . . .	60
<i>E. A. Nelson</i>	
GEOLOGICAL SURVEYING . . . . .	63
<i>T. T. Quirke</i>	
MUNICIPAL AND SANITARY ENGINEERING . . . . .	65
<i>H. E. Babbitt</i>	
WATERPROOFING THE CITY OF NASHVILLE RESERVOIR . . . . .	66
<i>J. V. Schaefer, Jr.</i>	
EDITORIALS . . . . .	72
APPLICATION AND MAINTENANCE OF ELECTRIC DRILLS . . . . .	74
<i>E. L. Council</i>	
DEPARTMENTAL NOTES . . . . .	76
ALUMNI NOTES . . . . .	81
ONCE OVERS . . . . .	87

*Published quarterly by the Illini Publishing Company. Entered as second-class matter October 30, 1921, at the post office at Urbana, Illinois. Office 213 Engineering Hall, Urbana, Illinois. Subscriptions \$1.50 per year. Single copies 40 cents.*

Fig 7



Fig 16

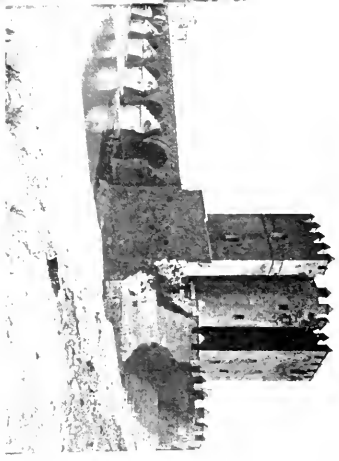
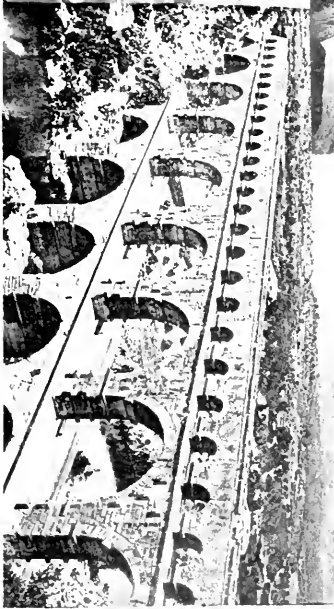

Fig 14



Fig 6



# De Pontibus

BY REAFORD NEWCOMB  
*Professor of Architectural History*

## THE SONG OF THE ROMAN ARCH

*It comes with the arc of the blue day's light,  
It comes with the spring of the rainbow bright,  
And with the wedding ring's circle of power,  
And it bridges the streams and it struts o'er the plain;  
In its arms is the river it sets down again  
For the fevered metropolis' doer.*

Durward's Building of the Church.

Among the many, many interesting things that attract the attention of the traveler in Europe should be mentioned the highways and bridges. In almost every country of western Europe one is impressed with the permanency of the roads that extend, web-like, in every direction and the strength and beauty of the bridges that span the innumerable streams these roads encounter. There is, after all, a beautiful symbolism connected with the bridge that, rainbow-like, gracefully and triumphantly spans the distance between the here and there and bears one safely over the broad, swiftly moving stream or across the deep, rocky chasm as the case may be. And when one is hurried by a rapidly moving express train from the black depths of some mountain tunnel out upon the slender arched-span of some Alpine bridge that carries him safely over the rushing mountain flood below, he can't help feeling that man has triumphed, and triumphed gloriously, over his environment. It was with awe and admiration that the writer had considered some of the great and historic bridges of the Old World and he resolved, on a recent trip, to keep notes and impressions of some of the beautiful and interesting bridges that he should see or pass over.

Several of those that he visited are among the modern bridge-builder's greatest triumphs in steel; others, no less interesting and much more beautiful, are among the oldest existing structures of their kind. Great or small each is lovely in its symbolism, many charming in form and color and most of them historic in that they have borne the traffic of centuries upon their shoulders; have, perhaps, been the objectives of great army maneuvers; have been ruined and rebuilt again and again and have silently watched man come and go along the great highways of the earth. From a collection of memories, sketches, and photographs the writer has selected a few of the more interesting bridges for illustration and description, not with the idea that the technical information conveyed will be of any great value to the reader but with a view to awakening an artistic

interest in this most fascinating branch of the work of the architect and engineer—bridge-building.

In going down the Saint Lawrence River bound for Liverpool our good ship passed under the great Quebec Bridge, the longest of the world's cantilever bridges, with a span of 1800 feet at a distance of 150 feet above the water, which guarantees clearance to any vessel that may pass that way. The Quebec Bridge is interesting not only because of its great span, exceeding as it does by 100 feet the span of the great Firth of Forth Bridge near Edinburgh, but also because of the fact that it is the first important structure in which what has come to be known as the "K" system of web-bracing was employed. This tremendous structure was first conceived in 1899, but was delayed by the great disaster of 1907 when the south anchor and cantilever arms failed, killing some eighty workmen, and was only completed about four years ago. It carries double railway tracks and is used by the Canadian Government Railways.

It seemed rather appropriate to the writer that he should, after viewing one of America's greatest bridges visit in the course of the next two weeks the second of the world's great bridges, the Forth Bridge. As one speeds toward Edinburgh upon that most excellent Scottish railway, the Caledonian, the massive steel humps of the bridge loom up far across the country. A fine view of the structure and what it means to Edinburg and Leith is perhaps best obtained by a view from Calton Hill from the crown of which one commands a fine panorama of the cities, the Firth of Forth and the land beyond. This tremendous steel cantilever railroad bridge is 8,098 feet long, has a maximum span of 1700 feet and cost \$17,795,000, a tremendous sum in its day. It was designed by Fowler and Baker, was begun in 1883, and completed in 1890.

A trip to the ancient town of Stirling served to acquaint the writer with two of the oldest and most picturesque bridges in all Scotland. One was the "auld Brig o' Allan" in the little village of the same name some three miles from Stirling and the other was the old Bridge of Stirling itself. The Bridge of Stirling (Fig. 1) is perhaps the most interesting in Scotland due to its age, historical associations and beauty. From documentary evidence it is established that the present "old bridge" dates from about 1109 although it was antedated by an old Roman structure which crossed the River Forth

at this point. Stirling Bridge was in the old days the "key to the Highlands" because all roads met here to cross the Forth at its narrowest place. The Battle of Stirling Bridge, one of the most brilliant Scottish victories over the English took place near here September 11, 1297. The structure is of the grey stone of the vicinity and has four semi-circular arches. It has a slight inclination from the ends up toward the center, a feature almost universally noted in masonry bridges in Europe. The praises of this staunch and sturdy old Scottish structure have often been sung by Scottish bards and it figures not only in authentic history but also in many legends that cluster about the names of Scottish heroes.

The 'auld Brig o' Allan' (Fig. 2) beneath the great arch of which the writer had the pleasure of a quiet lunch after a delightful three-mile ramble in the countryside is quite as beautiful as the Stirling Bridge and bears unmistakable evidence of having been widened due to the growing demands of traffic. The piers are founded directly upon solid rock and the ancient structure seems to bear the weight of the heavy modern motor-lorries quite as competently as it bore the one-horsed carts of a by-gone day. Old Scottish bridges, though interesting in an artistic and historical way, are scarcely ever large or of distinguished design, but in a land as broken as is Scotland the bridge is always an important landmark and the Scot not only prizes his bridges but is proud of them and wants the visitor to see them.

Larger and often more beautiful, though less renowned historically, are the delightful English bridges that span the pleasant streams that water old Britain. In selecting one for illustration the writer could think of none more satisfying than the lovely old Prebend's Bridge (Fig. 3) over the River Wear at Durham. The Wear makes almost an island of the great promontory upon which stands the castle (now the university) and the Cathedral of Durham. The promontory is connected with the remainder of the city by three bridges, the Framwell gate Bridge, the Elvet Bridge and Prebend's Bridge. All three are old bridges, the Framwell gate dating from the 14th Century, but the most beautiful is Prebend's. It is a most distinguished bridge, beautifully proportioned and graceful in all its parts. Its cutwaters carry lookouts that provide places safely outside the traffic way for contemplation of the scenery in either direction and situated as it is amid well wooded and beautifully parked banks and spanning the river above the weirs, its graceful arches and refined piers are usually charmingly reflected in the glassy still waters. It is a favorite walk for the citizens of Durham most likely because some of the

finest views of the castle and cathedral can be obtained from its lookouts.

One of the most curious bridges in history is to be found at Crowland not far from Peterborough. The site had an ancient wooden bridge built before 943 at which date it is referred to in a charter. The present bridge was undoubtedly built by the abbots, as it betrays in every line its affinity with Gothic church architecture. It is a triangular bridge built at a point where the Welland River divided into two channels known as the Catwater and the Xyne. The bridge consists of three pointed arches that have their abutments at the angles of an equilateral triangle and meet at the center, thus forming three roadways and three waterways. The profiles of the Gothic mouldings of the arches give a certain index as to the date of the bridge which cannot have been earlier than the beginning of the 14th Century.

London has had and has today many interesting bridges. "Old London" Bridge which has figured in all sorts of poetic lore from the nursery rhyme up, is perhaps known to people more generally than any other one bridge of history and the lore regarding this famous structure, if gathered together, would fill volumes. It was a most interesting old structure built partly as a bridge, or rather a street of houses and shops over the river, and partly as a dam to raise the water level of the Thames upon the eastern side and thereby aid shipping. There is supposed to have been a bridge over the Thames at London as early as 978 but authentic records are not available for a period before 1014. A fire of 1136 partly destroyed the first structure so that in 1176 Peter of Colechurch began "Old London Bridge" and worked as its architect and builder until his death in 1205. The bridge was completed in 1209 by a monk imported from France for the purpose. A chapel dedicated to Saint Thomas was constructed upon the bridge and this chapel was the resting place of Peter of Colechurch. In this respect "Old London" was like the Bridge of Saint Bénézet at Avignon which still stands. "Old London Bridge" was, after many partial destructions by fires that ravaged the timber houses which it carried, finally demolished and replaced in 1824 by New London Bridge. Up until the completion of Westminster Bridge in 1750 the "Old London" was the only structure across the Thames at London and consequently was a very important structure.

New London Bridge was designed by George Rennie and erected by his brother Sir John Rennie, who completed the work in seven years, a great contrast in the matter of time when compared with the thirty years that it took Peter of Colechurch and his successor to complete the "Old Bridge." The New Bridge was an excellent structure in its day but was conceived, like most London bridges, upon

a small scale. Few London bridges accord with one's idea of what the bridges of a great city like London should be. New Bridge not only is not distinguished in scale but has proved too small for traffic and consequently had to be widened in 1902-1904 from 56 to 65 feet.

Perhaps the most unique and picturesque of modern bridges anywhere is the Tower Bridge. (Fig. A). This bridge gets its name not from its towers but from the fact that it is near the Tower of London. It is a suspension bridge with a second-

exaggeration to say that Paris has more interesting and beautiful bridges than any other European city. A mere catalog of the more famous Parisian bridges would make a formidable list and the merest fragmentary remarks regarding the important bridges of the city would carry the present paper far beyond the space allotted to it. Hence the writer will have to content himself with remarks regarding one or two of the most important and interesting.

From the Parisian's point of view the Pont Neuf (Fig. 5) is the most interesting and best loved,

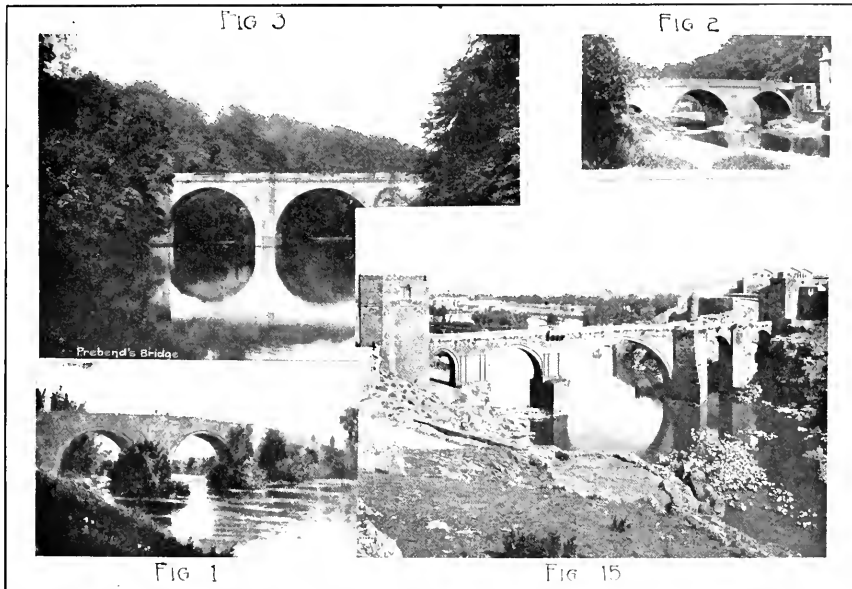

ary bascule bridge in the centre span to permit the passage of river traffic. Two great arched towers in the river and two towers on the shore abutments carry the suspension chains. The opening bridge between the two great towers consisting of two bascules, pivoted near the face of the piers, which rotating in a vertical plane permit, when the leaves are raised, a clear span of 200 ft. and a clearance above high water of 141 ft. Londoners are very dependent upon and very proud of Tower Bridge but the writer must confess that, although he admired the engineering prowess that make possible such a structure he was not "thrilled" by the attempted "architecture." In fact he considered the structure rather absurd and ridiculous in the strategic position that it occupies and couldn't help wondering how useless so defenseless a bridge would prove should it by any chance be subjected to anything like a shelling.

But if London is dependent upon her bridges and proud of them, Paris is more so and it is no

This famous old Renaissance structure, crossing as it does the western end of Ile de la Cité which divides it into two sections, was begun in 1578 and completed in 1606. The bridge is more or less architectural in its conception, the cutwaters carrying corbelled, semi-circular lookouts or sidewalk retreats which are provided with stone seats. The solid stone balustrade is carried along the bridge and out and around the lookouts by means of brackets, each adorned with a mask, while heavy bronze lamp posts standing over the piers flank the roadways. On the island the two sections stands a handsome bronze statue of Henry IV with balustrades and seats of stone conveniently near, making a most interesting and delightful place to rest. Situated as it is Pont Neuf always figures largely in Parisian celebrations and on Bastille Day last, the writer standing upon Pont des Arts witnessed one of the finest displays, of fireworks that it has ever been his pleasure to see, each and every star and sparkler was doubly

enhanced by its reflection in the quiet waters of the Seine. Pont Neuf is one of the masterpieces of the Renaissance architect Jacques Androuet du Cerceau, but has been much altered since the days of the Renaissance.

One might expand upon the history and lore that surround such bridges as Pont Louis Philippe, Pont San Michel, Pont Marie, Pont au Change or the more modern Pont Saint Louis and Pont due Carrousel. Each is beautiful, interesting or historic in its own way.

One of the finest bridges in Paris, and the widest one (131 ft.), is Pont Alexander III. (Fig. 6) This modern structure, constructed of cast steel, was built at the Exposition Grounds of 1900 to connect

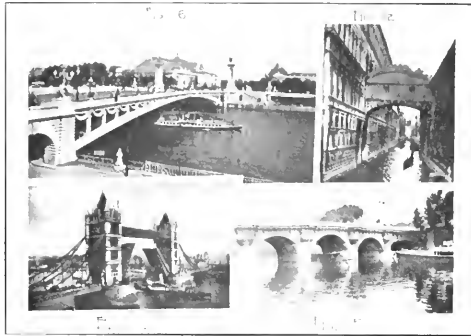

the champs des Elysees and the Esplanade des Invalides. The bridge is remarkable for its single span of 353 ft., and its shallow rise of only 20 ft. At either end are gigantic ornamental pylons 75 ft. high and justly celebrated as among the handsomest bridge pylons in existence. The Alexander III is further adorned by beautiful bronze electroliers and statue groups making it one of the most ornamental bridges of the world.

Outside of Paris there are many fine bridges. Nearly every French city or village situated upon a stream has an ancient masonry bridge with either a distinguished history or many interesting legends clinging about it. The writer was especially interested in the old Pont Saint Bénézet (Fig. 7) across the Rhone at the historic town of Avignon. There are many legends about this venerable bridge which seems to date from 1177 and was built by Saint Bénézet who is said to have been a member of the Freres Pontifices or Bridge-building Brotherhood which arose in the south of France during the latter part of the 12th Century and maintained hospices at the fords of principal streams, besides building bridges and looking after ferries.

The bridge at Avignon is far from intact at the present time but in spite of wars, floods, and explo-

sions, four of the original twenty-one graceful, elliptical arches and the chapel on the third pier remain. The bridge was originally 2,000 feet long, had a clear width of 13 feet between parapets and was bowed slightly up stream in order to better resist the force of the current. The old structure with its chapel to Saint Nicholas, the patron saint of those who travel by the river make an interesting and picturesque ruin when viewed from the ramparts of the old fortified Palace of the Popes.

Not far from Avignon and on the road from this ancient Papal city to Nimes is one of the world's greatest ancient bridge structures, the old Roman aqueduct, Pont du Gard. (Fig. 8). The aqueduct was built during the reign of Augustus to provide a water supply for the Roman city of Nimes and consists of three stories of arcades, the lower of six arches, the second of eleven arches and the waterway carried upon thirty-six small arches. The lower tier was originally 20 ft. 9 inches wide, the second tier 15 ft., and the upper 11 ft. 9 inches. In 1713, comprehensive repairs were effected and the lower tier of arches was widened to make a roadway on one side. The lower arches are not uniform in span, the largest over the Gardon River being of 80 ft. 5 inch span, while the others vary from 51 ft. to 63 ft. The original structure was peculiarly built; the lower tier of arches consisting of four separate arch-rings set side by side without any lateral bonding whatever. The second tier was similar with three arch-rings while the waterway was built of cut stones clamped together with iron and without the use of cement except for lining the water channel. Pont du Gard is built of a yellowish oolitic stone of the section. In full sunshine and against a deep blue sky the aqueduct makes a distinguished appearance and inspires in one a fine admiration for Roman engineering genius.

The south of France too has many excellent examples of Roman work. Let us now consider some of the bridges of sunny Italy. In Italy, as in France, it is difficult to choose between the great number of bridges which, because of one virtue or another demand attention. Rome with her many bridges, some of them coming down, in part at least, from old Roman days, Florence with her Ponte Vecchio and Trinité, Pavia with her curious old covered bridge over the Ticino, Verona with her Ponte Romano and Ponte Scaligero, Pisa with Ponte di Mezzo and others and lastly Venice with her matchless Rialto and Bridge of Sighs, to say nothing of the charming little bridges one finds scattered all through rural Italy, would seem to demand space even in the most abridged discussion of Italian bridges. The writer found the Roman, Venetian and Florentine bridges by all odds the most engrossing



from all points of view and hence will devote his space to them.

Rome has no fewer than fifteen bridges spanning the muddy Tiber and of these some five are relics of ancient days. The earliest vaulted bridge of the Romans is said to have been the Pons Salarinus erected some 600 B.C. but since this structure was completely destroyed in 1867 its interest is now purely historic. One of the interesting old fragments at Rome is the Ponte Rotto (Broken Bridge) called in Roman days the Pons Aemilius. This structure dates from 178 B. C. and has considerable claim to our attention as a distinguished piece of architectural composition as well as an efficient bit of engineering. Only one complete arch with parts of two others stands today, but one can easily reconstruct a picture of how this noble structure must have looked when in good repair. It was built just below the island in the Tiber and at a point that made it open to heavy currents hence it has suffered much in flood times and has been partially swept away at least four times. The Ponte Rotto is generally considered to be the perpetuation of the ancient Pons Aemilius.

Just above the Ponte Rotto and connecting the island with the mainland on the north is the Ponte Quattro Capi (Fig. 9) so called because at either side of the roadway at the north end of the bridge stand pedestals bearing four sculptured heads. The structure dates from 62 B.C. and consists of two great arches of 80 foot span carried by a central arched pier in the middle of the river. The structure is 250 feet long and the arch-rings are 6 feet deep. This bridge is said to have been longer at one time, and legends of other arches buried in the embankment are current. This bridge called in Roman days Pons Fabricius, is the only one of purely ancient Roman construction remaining in use at the present time. The writer noted this inscription on the western face over the south arch:

“L. FABRICIUS C. F. CURIAM FACTURUM  
COERAVIT”

On the opposite side of the island a continuation of the street that passes over the Ponte Quattro Capi also passes over the Ponte San Bartolomeo (anciently Pons Cestius) which originated in 46 B.C. but has been rebuilt many times, the last time during the years 1886-1889. San Bartolomeo is a single-arched bridge with a span of 76 feet. According to Piranesi, the great Renaissance draftsman and architect, both this bridge and Pons Fabricius were supported on reversed arches built under the water. Whether or not this is true has never, in modern times at least, been established.

Another Roman bridge of ancient foundation is that of San Angelo (Fig. 10) which in altered

state still serves as one of the Eternal City's principal bridges. It was built by Hadrian in 135 A.D. to give access from the Campus Martius to the great mausoleum that he was constructing for himself on the opposite bank of the Tiber. This bridge was the ancient Pons Aelius and is said to have been a covered bridge being sheltered by a canopy of bronze plates carried upon forty columns. Various of the popes made changes and repairs and when the Mausoleum of Hadrian was turned into a fortification of the Papal States and its name changed to Castle San Angelo, the bridge was decorated with ten marble statues of angels. Pope Clement VII erected the bronze statues of St. Peter and St. Paul at the ends. Aside from the parapets and statues the masonry portion of the bridge is of practically the

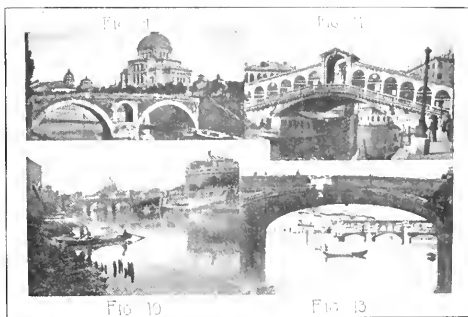

same form in which it appeared in old Roman days.

Going northward by way of the Via Flaminia from the Piazza del Popolo one arrives in the course of a mile and a half at the old Pons Milius often called the Ponte Molle. This ancient bridge was constructed to carry the Flaminian Way over the Tiber and is said to date from about the year 109 B.C. although, since the Flaminian Way was built about 220 B.C., it is possible that this bridge was antedated by earlier structures upon the site. The present bridge, some 413 feet long and nearly 29 feet wide, is one of the longest bridges of Rome. The four central arches of the total of seven are known to have reached to our time in an unchanged condition. The triumphal arch at the north end of the bridge dates only from the restoration of 1805. It was over this bridge that the Catiline conspirators fled when leaving Rome. Rome has a number of modern bridges the most interesting of which are the Ponte Margherita and the Ponte Victor Emmanuel.

One of the most famous bridges in the world is the pretty but diminutive Rialto Bridge of Venice, (Fig. 14) a bridge well known to all English speaking people through the works of Shakespeare who makes it the scene of episodes in his Merchant of

Venice. With the exception of two insignificant modern bridges, the Rialto is the only bridge over the Grand Canal. The Rialto like "Old London Bridge," and the Ponte Vecchio of Florence is a bridge of shops. In medieval days when bridges were few, a shop upon a bridge was a desirable possession because of the continuous traffic that passed its doors. A situation on London Bridge or the Rialto was as good as a fortune. In Venice the earliest bridges were of wood and the first Rialto Bridge was carried upon boats. Eventually, even in so marshy a situation as Venice, stone for bridge-building came into use. The early pontoon bridge of Rialto was built in 1178 by Nicolo Barattieri and this was replaced in the middle of the next century by a wooden bridge carried upon piles with provis for raising the central portion for the passage of boats. The present bridge of white Istrian marble was designed by Antonio da Ponte who came off best in competition with the architect Palladio for the design of the structure. It is of the single arch, stepped type with a 91 foot span and a width of 72 feet. The total length of the bridge is 158 feet and its height 11 feet 6 inches which barely admits of the passage of the modern omnibus ferries that serve as common carriers along the Grand Canal. The bridge carries two rows of shops and three roadways, one either side of the shops next to the balustrades and one between the shops. Even at very early hours of the morning the writer has found the bridge thronged with pedestrian traffic.

Venice has some 378 stepped, stone bridges that connect the innumerable islands that go to make up this maritime city, but since there is no heavy traffic, no horses being allowed, there is little demand for the large and massive bridges that are usually seen elsewhere. Moreover, all Venetian bridges must be high arched to permit the passage of boats and gondolas and hence most of them have to be crossed by means of flights of steps or be high enough to give clearance. The Rialto is of the first class, the famous Bridge of Sighs, (Fig. 12) designed and built by the same architect, is of the second. This well-known bridge which connects the Ducal Palace with the prisons was built in 1597. It crosses the Rio della Paglia which is one of the handsomer small canals of the city at a height of 32 feet above the water. This structure, like the Rialto is of white marble and thus harmonizes with the adjacent architecture. A central partition divides it into two passages each of which, although lighted and ventilated by the handsome marble grilles that look down upon the canal, are rather dark. One passage was for criminal prisoners, the other for political prisoners, and if the stories that connect themselves with this bridge are true, the way of the political prisoner

was far harder than that of the house-breaker or murderer.

Florence has a number of interesting bridges but none compare with Ponte Santa Trinita for grace and beauty or with the Ponte Vecchio for historic interest and human associations. Nor does Ponte Vecchio suffer in comparison with its more pretentious and more modern neighbor, a comparison of the arch curves of the two being gained from Fig. 13. Ponte Vecchio's three graceful arches, its beaked piers and its central arcade of three arches, affording a fine view up or down stream, all combine to make a most interesting composition. Its roof line, to be sure, is a bit uninteresting, far less interesting for instance than that of the Rialto, but this is its only defect. Ponte Vecchio carries shops on either side of its roadway and these shops have from early times been devoted to the sale of jewelry and silversmithing. The Florentine jewelry industry centers at the Ponte Vecchio. Just under the roof is an upper passage which connects galleries on either side of the river. These lead on one hand to the Pitti Palace on the other to the Uffizi Palace. There was a bridge at this site as early as 117 and it is said by some that there was an earlier Roman bridge at the same place. The present bridge dates from 1345 and is generally attributed to the architect Taddeo Gaddi. Ponte Santa Trinita, a gem of graceful masonry construction dates from 1567-70 and was designed by Ammanati.

Of the interesting bridges of Spain there is indeed much to be said. Spanish bridges often find their chronology falling under the following regimes: Roman, Moorish and Spanish, the latter dividing itself into the Romanesque, Gothic, Renaissance and modern periods. Spain became in time one of the most Roman of all the Roman provinces and many fine examples of Roman engineering prowess still survive the events of centuries in this interesting land. The great bridge over the Guadiana River at Merida with its sixty-four arches and its length of nearly 4000 feet is said to have its beginnings in the time of Trajan. There are other well preserved structures at Martorell, Orense, Almazar, Alcántara, and Salamanca to say nothing of such massive structures as the aqueducts of Segovia and Tarragona. Interesting as are these Roman structures from either the technical or the artistic point of view, the writer will have to omit further discussion of them here. He wants, however, to call the attention of the reader to two very interesting bridges in the ancient Spanish city of Toledo. Toledo came to its zenith under the Moors and after the breaking down of the Moorish power became the seat of the proud Kings of Castile, growing to a population of some 200,000

(Continued on Page 85)

# The Ocean Magnetic Work of the Carnegie Institution of Washington

By ROBERT R. MILLS, C.E., '23  
*Observer on the "Carnegie"*

The Carnegie Institution of Washington was founded by Andrew Carnegie expressly for scientific work. One of its activities is the work of the Department of Terrestrial Magnetism, whose problem is advancing our knowledge of the magnetic state of the Earth. This, in itself, covers various types of endeavor:—Compiling data already obtained, investigation and research, and observations. The ocean work is of the latter type.

The value of magnetic observations at sea has long been recognized, the first attempt being that of the famous astronomer, Edmund Halley, 1698-1700. At intervals since that time no less than ten vessels have done similar work. The first work of the Department of Terrestrial Magnetism was carried out on the chartered brigantine "Galilee," during 1905 to 1908. Thus a definite understanding of the problems to be obtained, as a result of which the "Carnegie" was constructed and launched in 1909.

The "Carnegie" is primarily a sailing vessel, the nature of her work requiring that she be practically free from all iron and thus limiting her auxiliary power to a small engine constructed of non-magnetic materials. The rigging is hemp, and all tackle and gear are made of copper, brass, or phosphor bronze. For example, she carries three large anchors, of brass, weighing nearly a ton each, the anchor "chains" being a special twelve-inch cable of Manila hemp. Her length over all is 150 feet. Two glass-covered domes have been provided near the waist of the ship in which observations are made and the instruments thus protected from the weather.

Since 1909 the total travel of the "Carnegie" is

about 250,000 miles, embracing all the oceans. The highest northern latitude is 80° and the highest southern latitude was reached during a circumnavigation cruise along the sixtieth parallel, from New Zealand eastward and back to New Zealand.

The work for which the vessel is operated is carried on by a staff of six men. Their duties include the magnetic and electric observations, astronomical observations for navigation, complete computation and checking of the results, and compiling them into form for immediate publication.

Observations to define the Earth's magnetic field at any point require the determination of the direction and strength of the field at that point.

The inclination, or dip, then must be determined to find the direction of the lines of force with respect to the horizontal. This is done with a dip circle. A magnetic needle is suspended free to rotate in a vertical plane and by orienting this plane with respect to the magnetic north the dip is read directly. An elaborate program is carried out to eliminate as far as possible errors due to the motions of the ship. In addition,

all instruments are mounted on gimbals and hence remain level.

The same element is measured by an earth inductor. This instrument is based upon the principle that when a coil of wire is rotated in a magnetic field, one position of the axis of rotation will not give an electric current through the wires of the coil, this



The "Carnegie" Under Full Sail\*

\*All illustrations are taken from Vol. III *Research of the Department of Terrestrial Magnetism, published by the Carnegie Institution of Washington.*

position being when the axis is parallel to the lines of force. Thus by orienting the instrument with respect to the north-south direction the dip is quickly obtained, the position of the axis which gives no current on rotation of the coil being the dip.

The horizontal intensity, or component of the Earth's magnetic force in a horizontal direction, is the usual method of expressing the strength of the field. The two instruments used here are the dip circle and the deflector. The dip circle is set up as for inclination observations, then the needle is deflected from its usual position by a magnet of known strength and distance from the suspended needle. The needle then is in equilibrium due to the magnetic force of the Earth being balanced by the magnetic force of the deflecting magnet. Hence the strength in the direction of the lines of force is obtained, which can be readily changed and expressed by its horizontal component.

The deflector is a compass card which is deflected by a magnet whose constants are known. The deflection this time is in a horizontal direction and is obtained by comparison with an undeflected compass. Thus the horizontal intensity is obtained directly.

In both of these instruments it is apparent that as the strength of the deflecting magnet remains constant, the strength of the Earth's field affects the angle of deflection, the two magnets used in each of the types of instrument being at right angles when a reading is obtained. These observations are carried out according to a program that requires an hour and a half or more to complete, on account of the large number of readings obtained and the various settings of the instruments and magnets. The two instruments are used simultaneously, one in each of the domes.

The observations for the magnetic declination determine the direction of the Earth's field in the horizontal direction. The declination, or variation of the compass, is expressed in degree of arc east or west of true north. This knowledge is made use of constantly by navigators and hence is of immediate practical value.

The standard instrument for this work is termed the marine collimating compass and it is perhaps the most interesting one on board. Here the problem is to determine as accurately as possible the

direction of the Sun or any astronomical body with reference to the compass. The true direction or azimuth of the Sun can readily be obtained for the same instant and position from tables, and the difference between the observed compass azimuth of the Sun and the true azimuth, on the "Carnegie," gives the magnetic variation.

The compass of the instrument has been altered by cutting away the usual compass card and in its place putting very small arcs at the north, south, east, and west points of the compass. These sections are graduated into degrees on the side towards the center of the compass, the image of the graduations being seen by reflection in a parabolic mirror through a collimating lens. The length of each arc is nine divisions of one degree each, the center line being longer and looking into the instrument is, say, the compass north (in this case also magnetic north). By means of a sextant the angle, in an oblique plane, between the north-south or east-west line of the compass and the Sun is measured. The altitude is determined at the same time. Now the sextant angle can be reduced to the horizontal by computation and this reduced angle is the azimuth of the Sun with respect to the compass.

The Sun is changing continually in azimuth, however. The sextant setting is fixed, so that any changes in azimuth with time are shown by different readings of the position of the Sun's image on the scale. Readings are taken at regular intervals of two or three seconds, and arranged in groups of ten and the average time and reading for the ten readings is used. Twenty sets of ten each are taken. These observations are made on heavenly bodies of low altitude, 35 being about the maximum altitude, as the reading is more definite the more nearly the image of the Sun or other body can be made to travel perpendicular to the scale by rotation of the sextant about the line of sight. When the Sun is overhead the movement would be parallel to the horizontal scale and the magnetic declination cannot be determined. This instrument was devised to answer the needs of the work on the "Carnegie" and was constructed in the workshop of the Department at Washington. It is the only one of its kind.

The view of the observations on the *Carnegie* shows the after-observing dome in which the de-

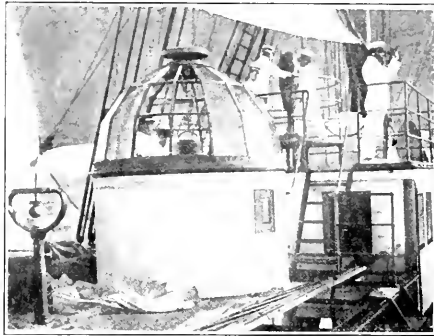

Observations on the "Carnegie"

(Continued on Page 88)

# The Physical Basis of the Theory of Relativity

BY JACOB KUNZ  
*Assistant Professor of Physics*

Most of the optical phenomena can be accounted for by the assumption of wave motions in a medium, called ether, which fills the space of the universe and penetrates between the atoms of matter. So we can explain the phenomena of reflection, refraction, double refraction, polarization, rotary dispersion, interference, diffraction, and standing waves. If we try to construct a physical picture of the mechanical properties of ether, it appears to have very surprising properties. It must be exceedingly dilute, in order to penetrate through all substances and in order that the earth and the planets suffer no resistance through this substance on their voyages round the sun.

Moreover, polarization of light shows, contrary to the case of sound waves, that waves of light in the ether are transversal. But a gas or even a liquid is unable to give rise to transversal oscillations, which are only possible in solid substances. The ether should therefore behave like a solid substance, and if we attribute to such a substance the density of steel, then the rigidity of the ether must be over 3,000,000,000 times that of steel in order that the velocity of light should be equal to 300,000 km. per second. But still greater difficulties we find in the conception of this optical medium when we consider the phenomena of aberration, the effect of Airy, of Fizeau and of Michelson-Morley's experiment. From aberration of light it follows that the space of the universe is filled with ether at rest and that the earth travels through this ocean with the same velocity with which it revolves around the sun. In other words, there is relative motion between the ether and the earth, just as between a moving ship and the ocean or between a train and the embankment and the quiet air. Now, if we stand on an open car in a fast moving train, we feel a strong wind or air drift. In the same way we should find in optical experiments an effect of an ether drift. No experiment, undertaken to discover such an ether drift, gave a positive result. In an indirect way this ether drift was disproved by the experiment of Michelson-Morley. These men tried indirectly to measure the velocity of light in the direction of the ether drift and in a perpendicular direction. But they found no difference in the

In this article Jacob Kunz, assistant professor of physics, who has spent the past year in study in Germany, presents an easily conceived notion of the physical basis of Einstein's theory of Relativity.

velocity of light. There is no relative motion between the earth and the ether according to this famous experiment. Aberration and the experiment of Michelson-Morley lead therefore on the basis of the ether to contradictory results. This contradiction disappears if we renounce the ether altogether and accept the theory of relativity. Moreover, it

has been found that the electrons which are given out by radioactive substances with a velocity approaching that of light, have a greater mass than electrons which move with smaller velocity. The increase of the mass of an electron with increasing velocity has been measured with great accuracy and has been found to be in accord

with the formula given by the theory of relativity.

This theory of relativity consists of two very distinct parts, the special theory and the general theory of relativity, both of which are due to Einstein, Professor of Physics in the University of Berlin. The special theory of relativity is based upon two postulates:

1. It is impossible to detect and measure an absolute uniform motion, i.e., a motion with constant velocity in a straight line.
2. The velocity of light in the vacuum is always the same, independent of the motion of the source of light or of the observer.

From these two assumptions very surprising conclusions can be drawn. Of two clocks which are constructed in the same way, the one which is in uniform motion seems to go slower when judged by an observer at rest with his clock. In a similar way a measure stick which is in uniform motion seems to contract in its own length. A perfectly rigid body is impossible. Moreover, two events which are simultaneous to one observer, are not necessarily simultaneous to another observer. The whereabouts depends upon the whereabouts and the whereabouts depends upon their whereabouts, not only, but each depends also on the velocity of an observer. Space and time become relative conceptions. This theory coordinates the apparently contradictory phenomena of aberration and of Michelson-Morley. Two constant velocities can not be compounded by the parallelogram method. A velocity plus the velocity gives again the velocity of light. A very im-

portant conclusion follows from this theory with respect to the relation between matter and energy. Every form of energy contains mass of inertia, so that energy is equal to mass times the square of the velocity of light. Newton's definition of force is slightly changed, enough to show that the mass of an electron depends upon its velocity.

When an electron describes an ellipse around a nucleus of an atom, we see from this variation of the mass at once that the ellipse can not stand still in space but that it rotates around the nucleus. This phenomenon is exactly analogous to the rotation of the perihelion of the planet Mercury around the sun, a rotation of about 41 arc seconds per 1000 years, which has not yet been completely explained by celestial mechanics based upon Newton's law of gravitation. This leads us into the general theory of relativity, which is a theory of gravitation. It is based upon the assumption that every motion, accelerated or not accelerated, is a relative motion and that therefore the fundamental laws of nature must be independent on any system of coordinates.

That the fall of a stone in the field of gravity is judged in different ways by different observers is evident at once. For instance, if a man drops a stone in a moving car of a train, he will see the same straight downward fall with constant acceleration which he would observe if the train were standing still. He would also find the same result if he were to drop the stone outside the window. In this case, however, an observer on the embankment would say that the stone fell in a parabola. Now let us build in thought a high elevator, about 100 times the radius of the earth, so that in the neighborhood of the top the field of gravity vanishes. The elevator car can move up and down by means of pulleys and ropes. Let us make an experiment first in the lower end of the elevator. A man in the car drops a stone and finds that it does not fall at all. Looking through the window he finds that the car itself is falling downward with the acceleration of gravity. If the body of reference, the car, falls with this acceleration, then a stone, let go, does not fall. Now we will consider the car on the top of the elevator outside the field of attraction of the earth. The observer in the car drops a stone and expects it not to fall, because he knows there is no more force of attraction. To his surprise he finds that the stone falls in the same way as on the surface of the earth. Looking through the window he finds that the car is accelerated upwards with the acceleration of gravity. He concludes from this experiment that a field of acceleration is equivalent to a field of gravitation. From this principle of equivalence, which presupposes equality of gravitational and inertial mass, we draw two further conclusions: If the observer in the elevator car outside the field

of gravity throws a stone in a straight line, he finds that it describes a parabola, when the car is accelerated upwards. A beam of light however has energy and therefore mass of inertia; a beam of light moving horizontally in the car at rest on the top of the elevator will therefore also describe a parabola, when the car is accelerated. From the principle of equivalence it follows that a beam of light will also be bent in a field of gravitation. While this should happen in every field of gravitation, it can only be observed in a very strong field. So, when a beam of light from a fixed star passes near the edge of the sun, it will be bent, as in refraction. This phenomenon has really been observed by English astronomers in May, 1919, in the total solar eclipse, which they observed in South America. It is a very small effect, amounting to a deviation 1.75" at the edge of the sun. This is the first time that gravitation has produced an effect on light.

The observer in the car outside the field of gravitation has also with him a source of light, for instance, a sodium flame and a spectroscope. He observes the line in the spectroscope, when the source of light and the spectroscope are in a horizontal plane. When the source of light, however, is on the bottom of the car and the spectroscope on the top, then the observer finds a displacement of the lines towards the red end of the spectrum, just as if the source had been moving away from the observer. Looking through the window, the observer finds that the car was moving upward with constant acceleration, so that during the interval of time in which the beam moved from the floor to the ceiling of the car, the velocity of the observer was increased relative to the velocity of the source of light. From the principles of equivalence it follows that the frequency of a source of light depends on the field of gravity. Under a high gravitation potential, the frequency is smaller than under a weaker potential. The effect is exceedingly small, amounting for a source of light on the sun to about a thousandth's of an Angstrom unit, or about  $10^{-11}$  cm. This effect is sought by the spectroscopists in astronomy. The results, so far obtained, are conflicting. If the prediction of the theory is verified, and no other explanation can be found, then the theory of relativity will take a predominant place in the physical sciences. And if this critical effect is not found, relativity will be dismissed.

In our intuitive knowledge we distinguish sharply between space and time. Of the four dimensional non Euclidean space-time continuum we have no intuitive knowledge. Space and time of our sense experience may be infinite while the physical reality, that space-time continuum may be finite.

In order to understand the general theory of

(Concluded on page 71)

# The Flow of Air in Tunnels

By G. A. GOODENOUGH  
*Professor of Thermodynamics*

*In this article Professor Goodenough discusses a hitherto uninvestigated subject, "The Flow of Gases in Tunnels." The validity of the equations derived was established by the tests run during the past year on the model Hudson River Vehicular Tunnel here at the University. The problem discussed is the third one dealt with as described in the preceding issue of the Technograph.*

The experiments on the model tunnel conducted under the direction of Professor Willard brought out some interesting phenomena that have not been observed heretofore.

In the tunnel as ordinarily constructed all the air that enters the tunnel at one end leaves at the other. The laws governing a flow of this character are well known and the equation for determining the drop of pressure may be found in any text book on the subject. In the model tunnel, however, air leaves the tunnel through ports spaced at regular intervals so that when the end of the tunnel is reached all of the air has disappeared. For this case a new theory is required and the fundamental equation of flow must be modified. It is the purpose of this paper to show what changes are necessary and how such changes affect the pressure required to force the air through the tunnel.

The fundamental differential equation that applies to the usual case, in which all the air traverses the tunnel, is

$$v \, dp + \frac{w \, dw}{g} + f \frac{w^2}{2g} \frac{1}{m} \, dx, \quad (1)$$

in which

- $v$  = volume in cu. ft. of 1 lb. of air.
- $p$  = pressure of air in lb. per sq. ft.
- $w$  = velocity of air in ft. per sec.
- $m$  = ratio of area of section to perimeter.
- $f$  = coefficient of friction.
- $x$  = distance from entrance in ft.

The reader who is interested will find a derivation of the equation in the Principles of Thermodynamics, Art. 104. In this derivation it is assumed that a lamina of width  $dx$  at the distance  $x$  from the entrance moves with a velocity,  $w$ . The force that moves the lamina comes from the difference of pressure on the two faces; and the work of the force is equal to the increase of kinetic energy of the lamina and the work required for overcoming frictional resistances. In equation (1) the first term arises from the work of the pressure, the second

term from the increase of the kinetic energy of the lamina, and the third, from the work done in overcoming friction. Since the change of pressure is small the volume  $v$  and velocity may be considered constant throughout the tunnel, and integration of equation (1) gives the well known formula

$$p_1 - p_2 = \frac{f}{mv} \frac{w^2}{2g} L \quad (2)$$

for the drop of pressure.  $L$  denotes the length of the tunnel.

When the air escapes through ports the specific volume  $v$  still remains nearly constant, but the velocity  $w$  must decrease as the successive ports are passed. If the values of  $w$  are plotted with the length of the tunnel as the axis, the curve is a series of steps. It may be assumed, however, as a close approximation, that the discharge is continuous along the length of the tunnel and that the curve for  $w$  is a straight line starting at the value  $w_1$  at entrance and reducing to zero at the exit end. The velocity  $w$  at a distance  $x$  from the entrance is therefore

$$w = w_1 \frac{L - x}{L} \quad (3)$$

It is interesting to note that in this case an exact calculation requires the summation of a large number of finite terms and the integration process that is used gives an approximation.

It would seem at first glance that the introduction in equation (1) of the expression for  $w$  given by equation (3) would solve the problem. The substitution gives the equation

$$v \, dp + \frac{w \, dw}{g} + f \frac{w^2}{m \, 2g}$$

times the integral from 0 to  $L$  of

$$(L - x)^2 dx = 0 \quad (4)$$

whence

$$v_1 (p_1 - p_2) = \frac{v_1^2}{2g} \frac{1}{3} + f \frac{w_1^2}{m \, 2g} L \quad (5)$$

Now  $v_1$  is the static head at entrance expressed in

feet of air and  $\frac{w_1^2}{2g}$  is the corresponding velocity

head. The sum of  $vp$  and  $\frac{w^2}{2g}$  is the total head at the

entrance, and therefore the first member of equation (5) is the decrease of total head through the tunnel. Comparing equations (2) and (5) the decrease of total head in the second case is *apparently* exactly one-third of the corresponding decrease in the first case. The result is the same if an exhaust system is employed.

The preceding solution does not, however, take into account all the modifying conditions. Referring to Fig. 1, the lamina at the distance  $x$  from the entrance is assumed to have the width  $dx$ . When all the air traverses the full length of the tunnel, the mass of air in the lamina remains unchanged, but when the air is discharged uniformly, the

lamina evidently loses the fraction  $\frac{dx}{L-x}$  of its

mass for each foot of travel from its present position to the end of the tunnel. The effect of this diminution of the mass is a corresponding decrease in the kinetic energy of the lamina. Now in equation (1) the

term  $\frac{wdw}{g}$  takes account of the increase of energy

of the lamina. Without going into details concerning the investigation, it is found that with uniform escape of air this term is decreased to

$$\frac{wdw}{g} = \frac{w^2}{2g} \frac{dx}{L-x}$$

In the exhaust system, on the other hand, the mass of the lamina is increased by entrance of air through the ports and the term becomes

$$\frac{wdw}{g} = \frac{w^2}{2g} \frac{dx}{L+x}$$

Hence the general equation for flow in a tunnel with ports is

$$vdp + \frac{w^2 dx}{2g(L-x)} + \frac{f w^2}{m} dx = 0 \quad (6)$$

in which the negative sign is applicable to the blowing system and the positive sign to the exhaust system.

The additional term  $\frac{w^2 dx}{2g(L-x)}$  contributes to

the change of pressure the amount given by the integral from 0 to  $L$  of

$$\frac{w^2 dx}{2g(L-x)}$$

Putting  $w = w_1 \frac{L-x}{L}$

the integral is  $\frac{1}{2} \frac{w_1^2}{2g}$ . Hence for the blowing case

the change of total pressure is

$$\frac{1}{3} \frac{f}{m} \frac{w_1^2}{2g} L - \frac{1}{2} \frac{w_1^2}{2g} = \frac{w_1^2}{2g} \left( \frac{1}{3} \frac{fL}{m} - \frac{1}{2} \right),$$

while for the exhaust system, it is

$$\frac{w_1^2}{2g} \left( \frac{1}{3} \frac{fL}{m} + \frac{1}{2} \right)$$

From these results it appears that considerably more power is required to exhaust a given volume from a tunnel with ports than to blow the same amount of air throughout the tunnel. The difference is even greater than indicated by the two expressions for the change in pressure. In the blowing system there is some loss of head due to friction and turbulence as the air passes out through the ports but the main stream remains practically undisturbed; but in the exhaust system the air entering the ports mixes with the main stream and the loss due to turbulence is much greater. To make the equations represent accurately the experimental results empirical coefficients must be introduced to account for the effects of turbulence. A discussion of such factors is beyond the scope of this article. It may be stated, however, that the experimental results completely confirmed the theory outlined in the preceding paragraphs.

## Factors Necessary for Engineering Success

*(Editor's Note: In Professor Baker's article under this title, published in the October issue of the Technograph, a story was inadvertently omitted. The story and the conclusion of the article follow.)*

A young man who had been graduated six or eight years from the civil engineering course of the

University of Illinois, on the day he landed in New York on his return from military service in the World War, applied for engineering employment to a firm of bankers in New York City. He had no credentials, and no letter of introduction; but he

(Concluded on Page 86)



# The Student Council

By R. J. MALCOLMSON, P.E., '22  
*Chairman of the Student Council*

What the Student Council of the University of Illinois is and who it consists of and what its functions are is not thoroughly known throughout the Engineering school. In order to get a clear meaning without much explanation it might be compared to the Council of Administration of the University. The Student Council is the governing council of the Student Body and is the connecting link between the Student Body and the University.

The Student Council is composed wholly of students, and each school and major activity is represented on this council by a representative chosen from the school or activity. The members of the Council represent the following activities: President, Vice President and Secretary of the Illinois Union, President of Men's Pan Hellenic, Editor of the Daily Illini, President of the Y.M.C.A., Colonel of the University Brigade, President of the Law Club, President of the Senior, Junior, and Sophomore Classes, Chairman of Men's Honor Commission and a representative of each of the following: Ag. school, Commerce school, Engineering school, L.A.S. school, Athletic Board of Control, Board of Oratory, and Debate. The Student Council this year has also the major women's Activities represented by the President and Vice President Woman's League, President Y.W.C.A., President W.A.A., Woman's Editor Illini, Chairman Woman's Honor Commission, and President Woman's Pan Hellenic. This represents the major activities of the campus and is as representative a council as could be gathered together.

The organization of the Council is such that the least possible time is lost in discussion and arguments. There are standing committees of the council to which all matters are referred for their investigation. Then the committees report their findings to the council at large for acceptance or rejection. The Engineering school is represented through the Engineering Council. One man is elected at the beginning of each year and serves for one year on the Student Council. Clarence Conrad '22 is the representative of the Engineering school this year and all cases coming from the Engineering school should come through the Engineering school representative.

The purpose of the Student Council is to take care of all matters of interest relating to the student body. As the constitution reads, "the purpose of the Student Council shall be to provide a student body which is in close contact through its members with

every branch of student enterprise and which can truly represent the student body." The student council represents the students in all matters concerning the general welfare of the student body, elects the Varsity cheer leader in the spring of each year, and appoints the members of the Honor Commissions. It also appoints such representatives as may be needed to co-operate with the Council of Administration in questions affecting the student welfare. The authority of the Council extends to the consideration and investigation of all matters affecting the student body as a whole, the arbitration and settlement of all disputes or controversies properly referred to it, the determination of the traditions of the student body and the formulation of plans and regulations for class elections. All rules as to eligibility of candidates and rules for campaigning are made by the council.

Another function of the Council is the supervision of all college mixers and dances. A budget of expenses is submitted together with the number of tickets printed. All tickets are sold under the supervision of the council, thereby guaranteeing that the ticket sales are fair and square. Every ticket is countersigned by a representative of the Council. If any Engineer believes that any ticket sale is not fair or that a smoker or mixer is not just what it ought to be, he should report it to the Engineering Council for their representative to bring before the Student Council.

The Student Council functions largely as an advisory organization and leaves its recommendations and findings to be enforced by existing agencies, but where it is deemed necessary the Chairman, Secretary, and one other member of the Council shall constitute an executive committee for the purpose of enforcing or assisting in the enforcement of its recommendations and findings. The Council is organized immediately after the fall registration each year by the Vice Presidents of the Illinois Union and Woman's League. There is no doubt but that the Council is an essential organization of the student body. Self government is a thing that promotes good will between students and faculty. The Council cannot function efficiently and shoulder the responsibilities and be the factor in student life that it should be without the co-operation and support of the student body. The more that the council can handle and handle wisely and justly the more willing the University will be to trust bigger questions

(Continued on Page 74)

# The Chicago, Milwaukee & St. Paul Electrification

By N. BIGGS, *et al.* '22

While many local, tunnel, and terminal electrification installations have been made to eliminate the smoke nuisance and to facilitate train movements near terminals, the Chicago, Milwaukee, and St. Paul Railroad was among the first to undertake the task of electrifying a part of its line to effect, primarily, the economy of operation. The portion of the line which the officials decided upon for electrification presented no smoke problems and practically no problems due to traffic congestion. Consequently, a splendid opportunity presented itself to study the economy of yard and line operation, and

to the extreme western end of the electrification. Both of these power stations are protected against a shortage of water during the late summer and the winter months, when the supply of water is at a minimum, by large reservoirs. With this arrangement of the conservation of water flow, the power plants, and also the railway, are safeguarded against the interruption of service. The railroad has also provided an added protection by connecting both the Great Falls and the Thompson Falls plants to each substation.

A 100,000-volt alternating current is produced

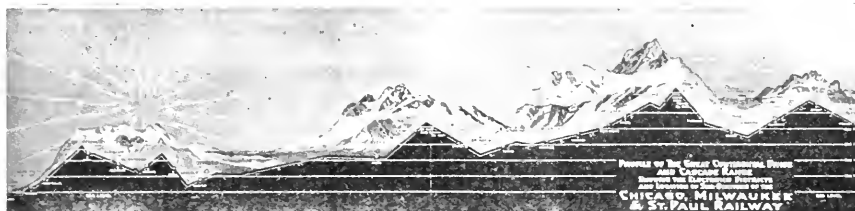

Profile of the Electrification over the Continental Divide

the working out of methods of electrical operation on a much larger scale than had previously been possible.

In September, 1914, the initial order for equipment was placed with the General Electric Company and from that time until the electrification between Harlowton, Montana and Avery, Idaho was completed, the construction was most actively carried on. On December 5, 1915, the St. Paul's crack transcontinental train, the Olympian, was taken from Butte, Montana to Piedmont, a distance of 38 miles, by the first electric locomotive to go over that line. During the next year, work on the electrification progressed and in January, 1917, all the steam locomotives had been removed between Harlowton and Avery and the great electric engines now pulled the trains over the continental divide.

The electric power employed to operate the entire 110 miles of electrified line is almost entirely obtained from the hydroelectric plant of the Montana Power company, whose principal plant is located at Great Falls. The power is delivered to the railroad at 14 substations located along the right of way. The road, roughly speaking, lies in the arc of a circle with a radius of approximately 100 miles, the power plant at Great Falls being at the center of curvature. At Thompson Falls is, also located a large hydroelectric plant which furnishes current

at each falls and sent over high-tension transmission lines to several points along the route. At each of the 14 substations the current is "stepped-down" to 3000 volts and changed to direct current. The electrical energy, in this form is carried by the rails and trolley to the electric motor of the locomotive where it is changed into the mechanical energy that pulls the train.

In appearance the electric locomotive is as modest as it is mighty. Its trim lines, however, suggest its latent power. The total length over all is 112 feet, the body being divided into two separate units in the center to provide greater flexibility in handling. There are eight 430 horsepower motors, thus giving a total of 3,440 horsepower to each locomotive. The total weight of 284 tons is six tons heavier than the Mallet compound steam engine, one of the most modern types now in use. Twelve pairs of wheels distribute this weight quite evenly and, because of this fact, the electric locomotive has a greater tractive resistance than the steam.

The question of the hauling capacity of the electric locomotive is, perhaps, not as thoroughly understood as it might be. The object of the steam engine operator is to keep the steam locomotive hot and to make steam, while the man who operates the electric locomotive must see that the motors are kept cool. The electric motor should not operate at

a much greater temperature than 325 degrees Fahrenheit above the surrounding atmosphere because greater heat destroys the insulation of the copper conductors. From this reasoning it can be stated that the electric locomotive will haul a greater tonnage in cold weather than it will during the summer months. Winter, above all, demonstrates the efficiency of the electric locomotive. While the steam engine experiences most of its difficulties in cold weather through slow fires, loss of heat by radiation and frozen pipes, the electric locomotive is at its best under these conditions.

The engineers responsible for the electrification knew that it was possible to handle an electric locomotive in such a way that a portion of the electrical energy used in climbing could be regenerated by means of gravity, while descending the down grade, and returned to the line. Thus, the electric locomotive, on a downward slope, when the motors are reversed has a two-fold function: to return into the system a portion of the electrical energy used in climbing, and to provide a perfect braking system which is entirely separate from the air brakes. From 25 to 52 percent of the electrical energy originally used is returned to the trolley to assist other trains and to reduce the amount of purchased current. The braking system provides maximum safety and eliminates track, brake shoe and car-wheel overheating and wear.

Energy is supplied to locomotives through the track and through the twin conductor trolley, two hard drawn copper wires. In order to avoid any likelihood of the wires breaking a strong steel cable called a "catenary" runs just above the trolley wires and parallel to them. From it hangers which carry the trolley wires are suspended at short intervals. These hangers vary somewhat in length so that the wires, themselves, will be as nearly as possible parallel to the track. This system was installed after a careful series of investigations had been carried out because it presented a double contact of

the pantagraph trolley with the wires and practically assured a sparkless collection of the current at all times and under all speeds.

Some of the advantages of the electric locomotive over the steam locomotive are that it does away with fuel trains and coaling stations, it has no tender to carry as a dead load, and it requires neither coal nor water for its operation. The electric power is always ready and one engine operates over several steam railway divisions. It has the power to send it through the heaviest snow drifts and is thoroughly dependable in all temperatures. Smokeless, noiseless, dirtless, and "jerkless" traveling is afforded by electric transportation.

Mr. D. A. Goodnow, Assistant to the President of the St. Paul in charge of electrification, is reported in an interview as saying that the mileage of the electric trains for 24 hours is about 200 against 114 by steam locomotives. The St. Paul, at the present time, handles more traffic in less time and at a reduced cost than it did when the road was operated entirely by steam. The entire cost of electrification, \$12,000,000 is considered a good investment.

The dawn of the electrical era in railroading is at hand. No very definite conclusions can be deduced, as yet, from electric railway operations because it has only been in the last few years that any road has attempted such a stupendous task, but what results we have obtained at the present time all point toward the electrification of the steam roads.

To produce enormous power from mountain waterfalls instead of from coal, to transmit this power in the form of electrical energy over great distances with but a small loss in transmission, and to apply it so as to promote the efficient and economical operation of the railroad is an achievement of the Chicago, Milwaukee, and St. Paul Railway which has marked a new epoch in the railroad transportation of the world.



# Modern Tendencies in Street Railway Operation

By PETER J. BOSEN '20

In a village of a few hundred there is no need for local transportation. Even in a city of five thousand, nearly every one is within walking distance of the local community centers, the churches, and the schools, but as a city gets much larger and extensive the need for some cheap means of local transportation becomes apparent. Usually the best solution of such a problem is to build a street railway. Once a street railway is in operation it becomes a permanent institution in that city. As the population increases, the city will expand, and with it the street railway by building more lines and giving better service on the existing lines as the traffic builds up. With the more frequent service, people will ride not only from necessity, but also out of convenience. It is interesting to note this increase in riding with the growth of a city. Where a person in a smaller city will use a car one hundred times or less in a year the number of rides per capita per annum may be three hundred and fifty or more in cities of several million. In one of the largest cities, with an increase in the population of only 25 percent, there was an actual increase in the per capita riding of 35 percent.

With the riding increasing at much faster rate than the city's growth, certain trunk lines will carry more than their share of the load with a subsequent congregation of all traffic along the routes. Also, as the size of the city increases the distances traversed from the residential sections to the central business or manufacturing districts becomes too great for rapid surface transportation and there arises a need for some means of rapid transit such as elevated lines and subways. But the economical use of rapid transit systems is quite limited, even where the cities have experienced unusual growth. In American cities of over 100 square miles area, the surface lines care for over 80 percent of the business. This is no doubt due to the more complete network of surface lines giving access to all parts of the city.

With the expansion of the business of the street railways, the problem arises of how to handle the increasing volume of traffic in an economical manner and yet prevent the congestion of city streets. In the last six years the street railways have been hit especially hard by the increasing costs in operation. The cost of wages and equipment is practically double that of six years ago while the rates have been advanced from 5 cents to only 6, 7, or 8 cents. The immediate effect of a rate increase has always been a decrease in business which requires some

time to recover again. In some cases, the drop in business has been so great as to offset the entire effect of the fare increase. Added to this the present industrial depression has caused quite a noticeable decrease in revenue on lines which feed industrial sections. Yet the street railways must provide themselves with equipment to meet the maximum possible demand which can occur at any one time.

To operate well in the face of these conditions requires extreme care in the selection of equipment and the method of operation. The transportation industry is peculiar, because it deals so closely with the human element that, in providing transportation, it must not only be frequent, fast, safe, and clean, but must also give the outward appearance of these characteristics and, above all, make the rider content by giving him what he wants. Even though the first cost may be higher, these efforts will be rewarded by increasing business.

On lines where the traffic demands are so light that it has been found uneconomical to give frequent service with the large capacity two man cars, the safety or one man car has been a real help. At first there was much opposition to the one man car, but so many interlocking safety devices have been brought out that the ordinary dangers from the lack of supervision of two train men have been entirely eliminated. The most outstanding of these safety features is the "dead man control," which automatically sands the rails and applies the brakes the instant the motorman leaves his control, and the interlocking, which prevents opening the door until the car comes to a full stop and also prevents starting the car until the door is closed.

The original safety car had a seating capacity of 32 passengers, but some of the newer models have been made slightly larger. Since the expense of trainmen's wages is cut practically in half, much better service can be given for the same amount of money. These cars have shown especially good results in places where a more frequent headway was made necessary to meet jitney competition, and places where a more frequent headway will stimulate business by encouraging short haul riding. Some operators claim good results even on lines with a headway as short as four minutes.

On the heavier lines, no doubt the two man car is still the better means of handling a large volume of traffic. The tendency in recent years has been to build larger and larger cars. Although the 40 and 45 seat cars are not uncommon at the present time, with cars of such a large capacity, arrangements

must be made to handle with ease the crowds they carry. Special attention must be paid to the manner of loading and collecting fares. To secure quick loading, a low step and a large platform capacity are essential whether the entrance is at the front, rear, or center of the car.

It may be said that the front entrance, or near side car, was designed primarily for the near side stop. Since the entrance is at the front passengers may board or leave directly from the sidewalk crossing, but since entrance and exit are both at the same end there is a tendency to overcrowd the car at the front. This type of car is well adapted however to lines where there is no excessive loading at any point. In addition to the convenience in boarding and alighting from the sidewalk crossing, there is a tendency toward safer operation since the motorman is in position to see all loading and unloading and therefore does not start until the steps are clear. Neither is he held back by the usual delay incident to the conductor's signal to go ahead.

The center entrance car is well adapted, by its construction, to a low step. The conductor, being in the middle of the car, can control the loading by directing the passengers to the end which is loaded the lightest.

As regards fare collection, practically every system now operates on either the pay-enter or pay-leave plan. The pay as you enter plan is desirable where the load is scattered and the unloading concentrated. The pay-leave plan gives better satisfaction when the loading is concentrated and the unloading scattered. The use of these two plans on the same system is objectionable because of the attendant confusion. The Peter Witt car is one of the newer types that combines the advantages of both systems. This car provides for an entrance at the front, controlled by the motorman, and a center exit. The conductor being stationed at the center collects fares as a person passes to the rear of the car or gets off. Patrons soon learn the saving in time effected by paying and stepping to the rear of the car just before reaching their destination, moreover this system of payment tends to distribute the passengers evenly over the car. The chief objection to its use is the time consumed by patrons who neglect to pay until ready to leave.

The choice of a car depends to a considerable degree on the character of traffic, but the great problem on a number of trunk lines in the larger cities has been to provide enough cars. In a number of instances where cars have been added to meet the traffic demands, the additional equipment is practically useless, because it has merely added to street congestion and slowed down the system as a whole. On lines where the saturation point for single cars

has been reached, train operation, either with multiple units or with trailers becomes imperative. Most of the time consumed by cars in congested business districts is taken up in waiting for the cross traffic at street intersections. Time studies have shown that it takes about 20 percent longer for a motor car and trailer to cross a street intersection than it does for a motor car to pass alone. Ten cars could pass in two car trains in the time required for six single cars to pass. Trailer cars are also desirable on heavy traffic, short headway lines, because of the low operating cost due to operating two cars with three men instead of four men as in the case of single cars. The newer trailers have elaborate provisions for safety, such as signalling devices and closed door operation. They do not permit passing from one car to another, which was an unsafe feature in the older trailers.

After giving due consideration to the matter of purchasing new equipment, many operating companies fail to get full use of it or of their old equipment. One of the most common faults in the use of equipment is in the overservicing of some lines and underservicing of others. Proper distribution of equipment can be made only after taking careful traffic surveys. Many of the older cars can have their usefulness increased by remodeling to give greater capacity and comfort, and by repainting in bright and cheerful colors which will make them conspicuous even on dark days.

One feature of operation that will work wonders in giving better service is a higher schedule speed. By operating at high schedule speed, the space between cars will be kept much better, while on the other hand a slow schedule speed encourages slow running and results in power waste. At first it might seem that higher speeds increase accidents. It has actually been observed that on lines where the schedules were made faster accidents decreased due to the watchfulness of the motorman, who always remained alert because of the greater demand made on his faculties. With parallel lines equally accessible it is common to *note* that the slower one is always avoided by patrons.

Men stationed at points of heavy loading to assist in loading the cars may prove a big factor in speeding up service. These men, called street collectors, collect fares and issue transfers to people who are then allowed to enter at the front end of rear entrance pay enter cars. This method practically cuts the time of loading in half by splitting the traffic into two streams. Loading from both ends also tends to distribute the load in the cars and increase its useful capacity.

At places where there is considerable vehicle

(Continued on Page IV, Adv. Sec.)

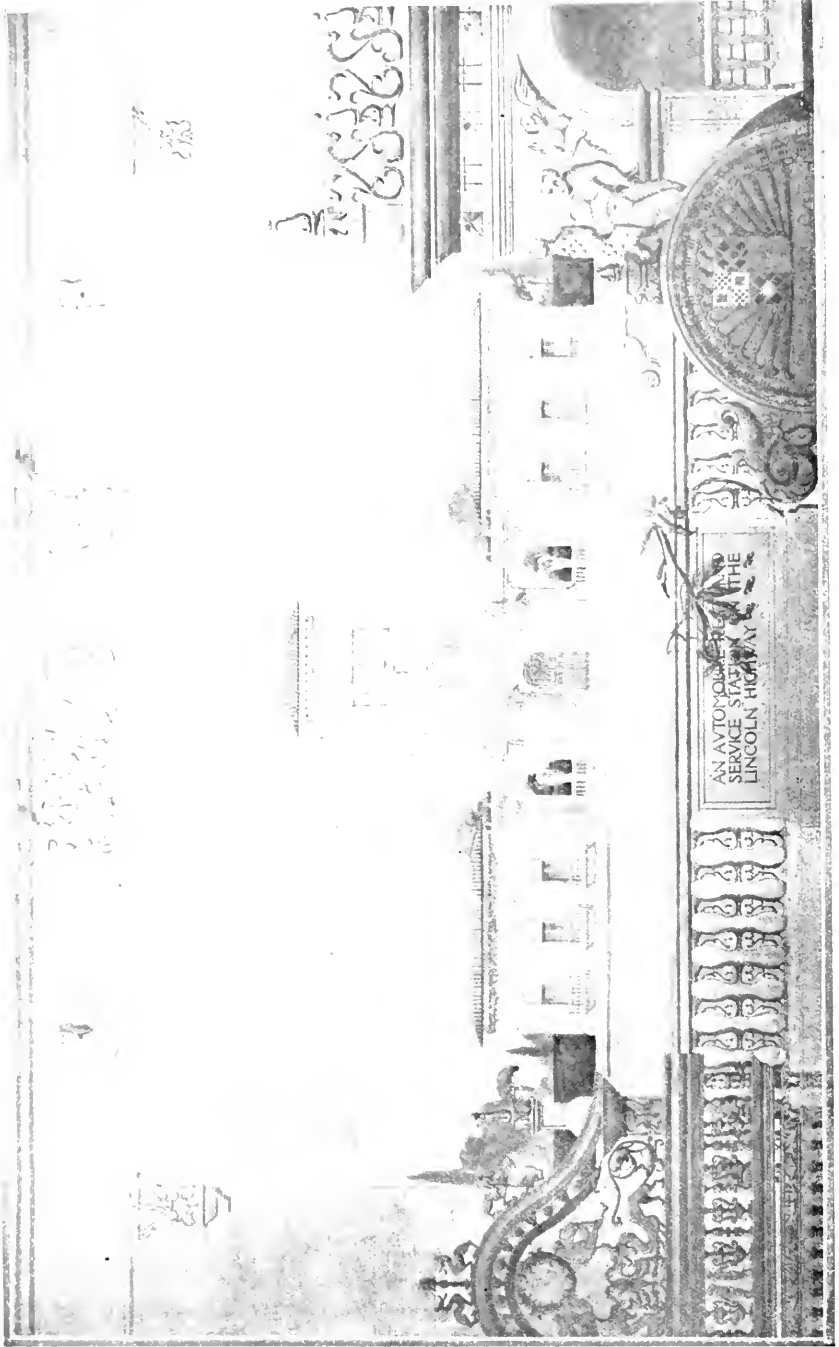

First Prize—Scarab Contest

J. A. Fordyce

# The Scarab Competition of 1920-21

During the second semester of each year, the Scarab Competition is conducted by the Department of Architecture and is open to the sophomore and junior classes. A preliminary sketch problem is the vehicle of elimination, in that this is open to all students of the two classes, and the five highest competitors are selected to execute the final problem.

The participants in this year's competition, formed a group of three sophomores and two juniors, who executed very excellent work, each one presenting their solution in the form of a frontispiece composition, in which detailed pieces were drawn and rendered. The program afforded an excellent opportunity for the students to get the best out of it, in expressing the purpose of the structure in their design which, after all, is the true intent of architectural design.

## Awards

The Medal—A. G. Fordyce, sophomore.  
Second Place—H. R. Russel, sophomore.  
First Mention (H.C.)—O. E. Brunkow, junior.  
Second Mention (H.C.)—X. B. Hazen, junior.  
Third Mention (H.C.)—Margaretha Spurgin, sophomore.

## An Automobile Service Station for the Lincoln Highway

Where the Lincoln Highway crosses a state boundary line at right angles, it is proposed to erect

a service station for automobile tourists. It is assumed that the location will be used by tourists and not by local traffic. The station will consist of the following units which may be either separate or under one roof:

1. A central unit located on the state line, to have the double purpose of serving as the entrance motive of the group, as an accent marking the state line. Ground area not over 300 square feet.

2. Two waiting rooms. These should open from the central unit either directly or through colonnades, arcades or some form of covered passage. Each waiting room unit should contain a general waiting room, small rest rooms, and small toilets. The total area of each waiting room unit shall not exceed 850 square feet.

3. The service room. This room will contain the automobile accessories, and have the gasoline and oil pumps in close proximity. Provision must be made so the cars can drive under cover while they are being supplied with gasoline and oil. This entire unit should be back from the main road and reached by turnout drives.

The spirit of the design should not be too commercial. A home-like and restful atmosphere should prevail so the tourists will stop by invitation of the group's appearance.

The two states have joined to contribute to the erection of this station, and have set aside the plot of ground which is unlimited in size.

## Books by Engineering Professors

A number of Illinois' engineering professors are authors of various books which they have produced for use as texts in branches of engineering. Since 1912 the number has totaled twenty. All of them may be found on the main desk in the engineering library. Professor I. O. Baker is in the lead, having completed five texts on phases of civil engineering. The following is a list of the authors, titles and dates of publication.

E. W. Washburn—Principles of Physical Chemistry, 1921.  
O. A. Lentwiler—Machine Design, 1917.  
W. F. Schulz—Physics Laboratory Manual, 1918  
H. W. Miller—Descriptive Geometry, 1918.  
H. W. Miller—Mechanical Drafting, 1919.  
Townsend and Goodenough—Essentials of Calculus, 1910.  
Peckles and Wiley—Railroad Surveying, 1914.

Seely and Ensign—Analytical Mechanics for Engineers, 1921.

G. A. Goodenough—Principles of Thermodynamics, 1911.

G. A. Goodenough—Properties of Steam and Ammonia, 1917.

H. J. Macintire—Mechanical Refrigeration, 1913

I. O. Baker—Principles du Nivellement Géodésique, 1912.

I. O. Baker—Leveling, 1918.

I. O. Baker—Engineer's Surveying Instruments, 1915.

I. O. Baker—Treatise on Masonry Construction, 1920.

Harding and Willard—Mechanical Equipment of Buildings, 1918.

N. C. Ricker—Design and Construction of Roofs, 1912.

# The New Viaduct at Akron

By E. A. NELSON, C.E., '23

*Field checker for James O. Heyworth on this construction work*

Akron, Ohio, is a city with a population of 200,000 and is built on three hills. The business district is on the hill and the two main residential districts are on the other, or the West Hill and North Hill. Between the hill, on which the business district is located, and North Hill is a valley about one half mile wide and one hundred fifty feet deep. Not only the traffic between these two parts of town, but also

borne jointly by Summit County, Ohio, the city of Akron, and the Northern Ohio Traction System.

The general design of the viaduct, as shown in Fig. 1, consisted of a series of sixteen spans built in pairs. They were parabolic in shape and ranged from one hundred sixteen feet to one hundred ninety-one feet in span, with a maximum height of one hundred twenty-five feet. There were to be two ap-

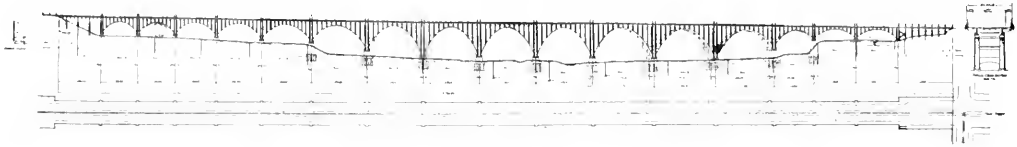

Fig. 1.

that between Akron and Cleveland must go through this valley. The grades on both sides of the valley are so steep, that even the street cars have difficulty in negotiating them.

Early in 1919, a contract was let to James O. Heyworth, Engineer and General Contractor, of Chicago, to span the valley with a reinforced concrete viaduct. The designs were drawn by Harrington, Howard & Ash, of Kansas city. The work was estimated to take two years and the expense was to be

proaches each one hundred feet wide and one, one hundred seventy-one feet long and the other one hundred thirty-six feet in length, and these were to be of beam and slab construction.

The roadway, or deck of the bridge, was to be seventy-two feet in width, and to consist of two tracks for heavy interurban freight and passenger service and the city street car traffic, two double width roadways, and two ten-foot sidewalks.

The first actual work consisted of laying a tem-

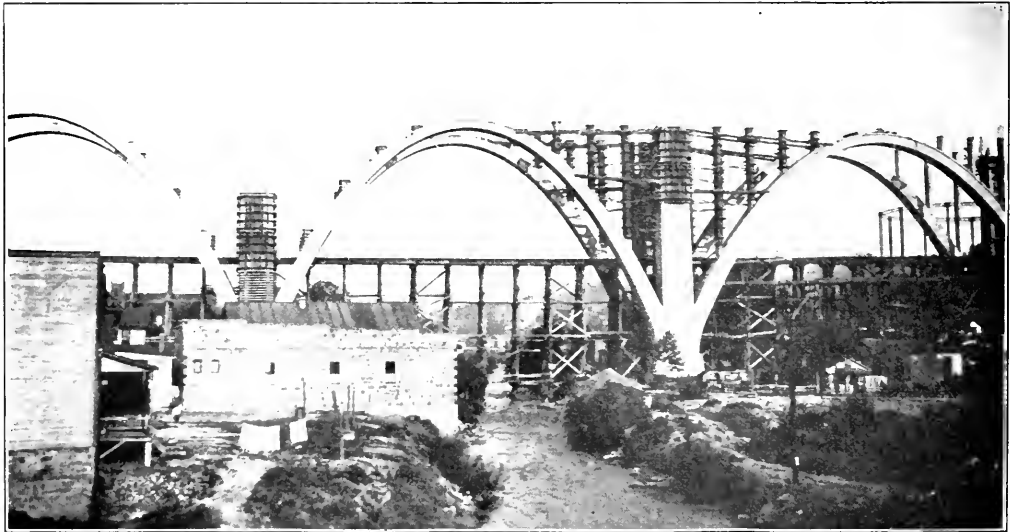

Fig. 2



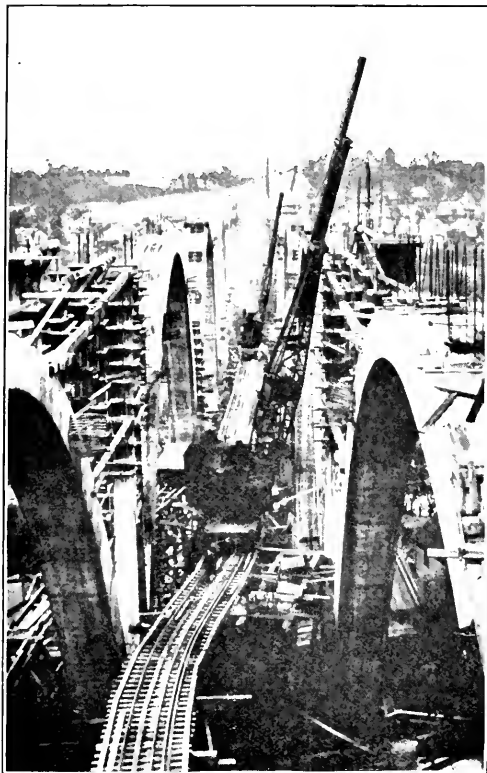

Fig. 3.

porary track down the center line of the bridge, and between the places where the foundations of the piers were to be built. This track was subsequently removed, after the foundations and column footings had been constructed. The foundations were built by driving thirty foot concrete piles through the fill, gravel, sand and brown silt down to the fine water bearing sand. These piles were capped with concrete, upon which the column footings were constructed.

With this much in place, a sixty-five foot trestle was built between the column footings and connected with a spur of the Baltimore and Ohio Railroad. This trestle carried a standard gauge track to carry the steam locomotive cranes (Fig. 3) as well as a thirty inch gauge track for the one-yard bottom-dump cars (Fig. 5) and their gasoline locomotives.

The mixing plant was situated at the end of the trestle near the spur track. Material was dumped directly into hoppers from the railway gondola cars. Slag from the steel mills was used instead of gravel

because of its comparative lightness and the strong bond which it gives. The cement was mixed in a one-and-one-half-yard electric driven mixer and was lifted up to the trestle by a 90 H. P. electric motor and dumped into the one yard dump cars. These were pushed across the trestle to the point where the pouring was being done.

The column foundations and the abutments were the first things to be completed. Then the steel centerings, which was to support the arch forms, was set in place by the use of guyline derricks and an "A" frame. This steel centering was built up of six sections of steel frame bolted together and averaging fifteen tons each. A templet of two-by-six's, cut to fit the intrados of the arches, was fastened to the frame and the floor of the arch was built up to the templet. The sides of the form were then put on, and the reinforcing of one and three-fourths inch bars was put in place. Much time and labor was saved by cutting the reinforcing with oxy-acetylene torches. The forms for an arch, in place and supported on its centering, is shown in Figure 4.

The first two spans and the first two sections

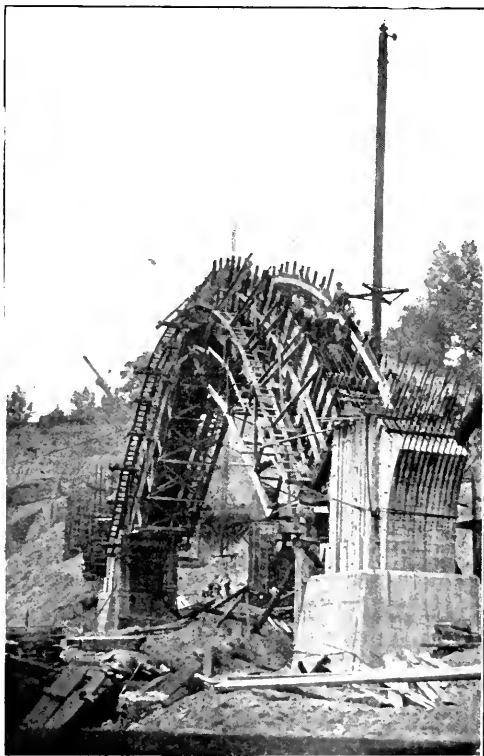

Fig. 4.

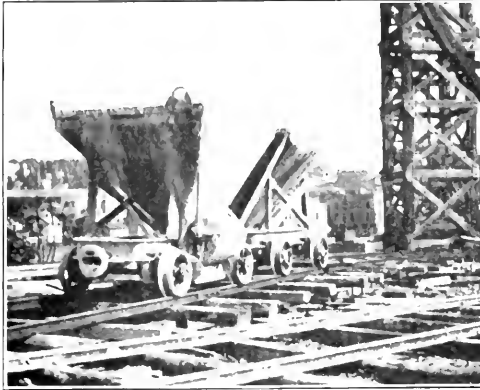

Fig. 5.

of deck were poured by the tower and chute method. But this method later proved unsatisfactory because of the great distances through which the concrete had to be poured. All subsequent pouring was done by lifting concrete buckets, by means of steam cranes, to the top of the form and dumping them. The lower half of the arch was poured and allowed to set for two days before the upper half was poured. When the whole arch had been poured, it was allowed to set for five days before the forms were removed. In removing the centering it was fastened to the arch and taken down in sections, as shown in Fig. 6.

When the arches were in place, the hollow piers at their junction were built up. These were poured in twenty-foot sections inside of collapsible wood and steel forms. The deck, between the tops of the arches and the piers, is supported by solid columns that rest on the arches. These were also poured in twenty-foot sections. Figure 2 gives a good idea of how the hollow and the solid piers were built up.

The deck of the bridge was of slab and beam

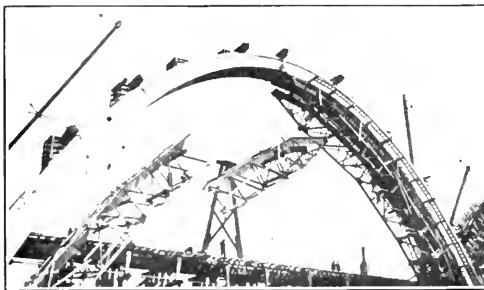

Fig. 6.

construction. Forms for its construction were ingeniously supported by a system of brackets that were fastened to the arches. The forms were moved from one place to another on a traveler which ran on a track supported by the brackets. This whole system obviated the necessity of falsework. The deck was poured from bucket cars in much the same manner that the remainder of the bridge was poured. About four hundred cubic yards or an equivalent of sixty seven linear feet of deck were poured at one time.

The bridge, when completed, will have given employment to an average of two hundred five men for nearly two and one-half years under the supervision of Mr. O. E. Strehlow '96, Chief Engineer. The employment of parabolic arches in the design of the bridge instead of the conventional circular type, was a digression with special consideration for the aesthetic and when the structure is completed, it will be one of the most beautiful and inspiring examples of engineering.

The Technograph is indebted to Successful Methods for the cuts used in this article. Mr. Nelson took the photographs from which the halftones were prepared.

## Globeless Type of Street Lamp

The principal problems which a city has to consider in lighting its residential districts is how to provide a lighting system that will be both attractive and efficient. There are two possible solutions, the installation of lamps of larger candle power with long spaces between them, or smaller lamps at short intervals.

The city of Rochester, N. Y., has installed a new type of globeless light standards which combine attractiveness and efficiency with lower maintenance cost. By eliminating the globe, not only is the absorption of light which renders the globe lamp somewhat inefficient done away with, but the maintenance cost of globes, due to the breakage in handling or other causes ceases.

This type does away with the globe entirely. It consists of a piece of porcelain which combines the duties of insulator, reflector, and socket holder. This porcelain is flared at the lower end, and is white inside. Glare is eliminated by so placing the frosted lamp that it is always seen against the white reflector. The reflector is so designed that all the light is projected downward, thus increasing the light on the pavement and sidewalk a hundred per cent as compared with the old globe type where at least half the light was in the upper hemisphere of the globe.

Rochester has already installed 200 of these lamps and ultimately expects to install about 5000 throughout its residential districts and the parks.

# Geological Surveying

By T. T. QUIRKE\*  
*Professor of Engineering Geology*

Geological surveys vary greatly, depending on the purposes for which they are made. In some cases the geologist is required to make a report upon the probable persistence and extent of a gravel deposit. In other cases, he is called upon to examine, and, as far as possible, determine the commercial value of an alleged ore deposit, which may be a vein with very little showing at the surface, or it may be a part of a developed mine with a great deal of underground development, or again it may be a disseminated type of ore deposit of which little can be seen, the value of the report depending largely upon the geologist's general knowledge of his subject. In other cases a geologist is required to make a complete geological survey of an area. The purpose of this work is to put upon a map the distribution of the individual rock formations in such a way that their relative ages and positions may be set forth. Primarily the geologist's business has to do only with the rocks and mineral deposits and the surface features, but incidentally to that he is commonly required to make a geographical map of the area as a base on which to lay his geological data.

Geological maps have the following general uses: (1) They afford the base of soil survey, in as much as the soil is derived from the rock, it being fairly clear that different kinds of soil depend for their existence upon the different kinds of rock and differences of geological processes; (2) Geological maps show the distribution of mineral deposits so far as current exploitation is concerned; (3) to the prospector, they show the distribution of the rocks which are worth exploration and detailed study, and by showing the structure or the relative position of one rock formation to another, they provide the means for determining where the rocks which appear locally at the surface are likely to be beneath the surface, although not visible. In other words, a geological map shows not only the distribution of rocks in one plane, that is on the surface, but it provides the means by which the solid geometry of the earth's crust may be made available. The economic value of this sort of thing is obvious, for although, as it is often said, a geologist can not see through a foot of rock any further than anybody else, in locating deposits of economic value he can make accurate estimates through thousands of feet of rock. The surface mapping is of considerable service in planning many types of engineering enterprises; for example, dam and bridge foundations, irrigation schemes, drainage systems, or for locating

sources of fuel supply, cement or road materials, and in railroad and highway routing.

The particular use to which the map is to be put governs the degree of accuracy required in preparing it, and that in turn governs the methods. In any case, one must start with some base for his survey. Wherever possible the geologist uses the available base map. In some cases he has to change the scale of the map and replot the geographical data, in other cases the geographical data is almost lacking, and he has to make both geographical and geological maps. The instruments of surveying for cases requiring the greatest accuracy are the chain and transit, with determination of latitude and longitude when necessary. Also by use of the plane table, working by triangulation methods from a measured base; accurate mapping may be done. Then come reconnaissance methods of all kinds, the pacing and compass method for dry land and the micrometer for work on water, with variations brought about by local conditions such as the use of the dip needle and dial compass in exploration for iron ores. Whatever his problems and however difficult his field work the geologist never uses any of the numerous fakes, such as willow wands, neurotic spring balances, or any other variety of the so-called "doodle bug."

The commonest surveying instruments used by well trained geological engineers are the plane table and telescopic alidade. This type of equipment has been used by the United States Geological Survey especially for many years, and some of the most useful improvements and attachments have been contributed by members of the geological staff. However, the simplest instruments are the most widely used. They consist of the familiar pair of calipers, known as the biped man, and a compass.

The geologist is not supposed to be a land surveyor, and he is justified in tying his surveys, whenever possible, to the monument of a land surveyor. The geologist ordinarily does not use instruments of extreme accuracy. The degree of precision to be obtained is not required to exceed the limits of accuracy possible in plotting and printing the results. Thus the geologists regards any monuments on a chain and transit line as exact. When starting a plane table survey, the base line of course is

\*Dr. Quirke has done work of the nature described in this article for the Canadian Geological Survey for the past two years.

chained, from the ends of which points are located by triangulation, and levels are run and bench marks established. Thereafter the contour lines are drawn, and the geographical base is ready for geology. In some cases the geographical map is made simultaneously with the geological mapping, both phases of the work being done by the same party. However, this is an inadvisable method for the reason that good geographical mapping is worth the time of an expert surveyor of that type, and for the other reason that a geologist's business is geological and not geographical mapping, and it is a waste of his technical training to be kept at surveying which could be done satisfactorily by some one else. In the ideal case, the base map being provided, the geologist places points on his map by pacing and compass traverses. This method is generally held in ridicule by transit and chain men, but their ridicule is a product either of inexperience with the method or of their own carelessness during their experience. A good assistant with no experience as a surveyor can be trained within a month to run surveys which have a degree of error not exceeding two per cent, that is about two chains per mile on a five mile traverse, a day's work in a rough and timbered country. These daily surveys should not be out more than ten chains; plotted on a scale of forty chains to an inch, a very common scale in geological surveying, the error is a distance of one-quarter inch which would show on the published map of eighty chains to the inch as only one-eighth inch. After a judicious distribution this error is negligible. On the other hand many experienced geologists run traverses of over five miles in rough and heavily timbered country and check out within a chain. Few can be so successful at this every day and under every circumstance of work, and occasionally the errors are considerably greater.

In general for open country, the plane table is far the best surveying instrument ever devised for geological work. Naturally, however, its use depending entirely upon direct observation on the stadia, the method is almost useless in a forested area, and in an area of lakes and winding rivers it is too awkward and expensive to use satisfactorily. The most satisfactory instrument for measuring directions is the prismatic compass, although the Brunton compass, sometimes called the pocket transit, is almost as good and preferred by many experienced workers. In the exploration of areas which are underlain by deposits of magnetite, any magnetic compass is unreliable, and the geologist then uses that utter abomination, the dial compass. This is a device for measuring directions by means of the position of the sun. In order to use such a device, one must calibrate his tables every so often because with the seasonal changes the direction of

the sun's rays varies at definite hours from day to day, which makes necessary an observation on *Polaris* by night in order to check up. With that line established as the north, one measures the inclination of a shadow with that line, taking readings every fifteen minutes throughout the day. Then, during the day one notes the time by his watch, finds out from his table what angle a shadow makes with the north, places his dial compass in such a way that the north line makes this angle with the shadow line, and thus determines his bearings. One feature of this work delights geological assistants, and that is the utter impossibility of doing any work on days when the sun is hidden, thus the average number of days spent in camp with nothing to do runs very high, but the areas in which a magnetic compass can not be used are relatively small, although in the iron regions of Minnesota, Wisconsin, Michigan, and Ontario we have very important exceptions. For measuring distances in surveying rivers or lakes the micrometer is used. This is an instrument having a nickel prism inside of a telescope. A real and an imaginary image are formed and when these are brought into coincidence by means of a thumbscrew, a factor of the distance can be read off on a scale. As an instrument of accuracy, it is not in the same class as a chain and transit, unless the surveyor uses very short shots and very large targets. In the surveying of the wilderness of the north, where travel is in winter time by dog sleighs and snow shoes, and in the summer time by canoe, where observation is greatly restricted by the trees, the micrometer is the geologist's most convenient instrument, just as in the plain country of the south and west the plane table is by far the best instrument.

Any one of these instruments, of course, whether it be transit and chain, plane table and stadia, micrometer and target, compass of any type, the much cursed aneroid barometer, and the human caliber, may be rendered utterly unreliable by careless use.

The geological surveyor must learn early to perceive the significance and the possible presence of small cumulative errors, and to appraise justly errors which are of no consequence so far as the work at hand is concerned. One experienced geologist hand leveled over all the portages on a river survey, but failed to take account of the change of level when his party ran the canoes down the rapids instead of carrying the outfit around them. His omission entirely vitiated the value of the levels he included. It seems trite to warn against such inconsistencies, but the very fact that good men are from time to time guilty of such mistakes, shows that these warnings are not made often enough. The

(Continued on Page 83)

# Municipal and Sanitary Engineering

By H. E. BAUBERT

*Assistant Professor of Municipal and Sanitary Engineering*

High class plumbing is what it used to be called in its early days. "Sewer Rats" is the sobriquet sometimes applied to its devotees today. The professional name is ponderous and frightening to the uninitiated. The word municipal smacks of politics and uncertain jobs; the word sanitary conveys the idea of some recent fad, or it may be considered a misnomer meaning something decidedly insanitary, such as "sanitary" sewage, which is far from sanitary.

Civil engineering developed from military engineering, but the work involved in the early days of the two professions was not dissimilar, in that both were principally devoted to surveying and mapping. As the complexity of modern life increased and more material things were demanded, the civil engineer was called upon for a more diverse knowledge. As a result mechanical engineering, mining engineering, electrical engineering, municipal and sanitary engineering and many others were developed as branches of civil engineering. Municipal and sanitary engineering is being developed as the result of the crowding of the population into cities, and by the increasing popular appreciation of the necessity for sanitation and the pleasure and comfort to be derived from public utilities.

Mr. G. S. Webster, in his presidential address on "Municipal Engineering," delivered to the American Society of Civil Engineers at Houston, Texas, April 27, 1921, defines municipal engineering as:

"... that branch of civil engineering especially related to the problems of municipal corporations, and includes the planning, construction, and operation of public improvements and utilities required for city growth and development, for furnishing the citizens and industries with certain commodities needed for health, commerce, and prosperity, and for removing and disposing of the wastes which are detrimental to the health and to the well being of the people."

Mr. W. P. Gerhard, in his book, "The Water Supply, Sewerage, and Plumbing of Modern City Buildings," says:

"A Sanitary Engineer is an engineer who carries out those works of civil engineering which have for their object:

- (a) The promotion of the public and individual health.
- (b) The remedying of unsanitary conditions.
- (c) The prevention of epidemic diseases.

A well educated sanitary engineer should have a thorough knowledge of general civil engineering, of architecture, and of sanitary science. The practice of the sanitary engineer embraces water supply,

sewerage, and sewage and garbage disposal for cities and for single buildings, the prevention of river pollution, the improvement of polluted water supplies; street paving and street cleaning, municipal sanitation, city improvement plans, the laying-out of cities, the preparation of sanitary surveys, the regulation of noxious trades, disinfection, cremation, and the sanitation of buildings."

It is evident from these two definitions that the education of the municipal and sanitary engineer must necessarily be broad, and with such an education his opportunities should be many.

Municipal and sanitary engineering offers a better opportunity for service of benefit to mankind than any other branch of engineering or any other profession. One city engineer can directly increase the comfort of the entire population of a large city, and can indirectly prolong the lives of the population thereof. What other professions or branches of engineering can show such results? A striking instance of the direct and indirect benefits of the practice of sanitary science is the construction of the Panama Canal which was made possible only after health conditions on the Isthmus had been so improved that the white man was able to live there in safety.

The greatest need of a modern city is its water supply. Without it city life would be impossible. The next most important need is the removal of waste matters, particularly wastes containing human excreta of the germs of disease. To exist without street lights, pavements, street cars, telephones, etc., might be possible, although uncomfortable. To exist in a large city without either a public water supply or a sewerage system would be dangerous if not impossible. The service rendered by the engineer to the large city is indispensable. In addition to the services necessary to the maintenance of life in large cities, the sanitary engineer serves the smaller cities, rural communities, isolated institutions, and private estates, with conveniences which make possible comfortable existence in them, and which are frequently considered of paramount necessity.

The opportunity for a livelihood through municipal and sanitary engineering is among the best in any branch of engineering. There are 717 cities in the United States with a population over 10,000 and 68 with a population of more than 100,000. The smallest of these cities probably employs at least

(Concluded on Page 82)

# Waterproofing the City of Nashville Reservoir

By J. V. SCHAFER, JR., M. & S. E., '23

The City of Nashville, Tenn., gets its water supply from the Cumberland River, and in order to have a place where the water could be purified and kept in such quantity as to supply the city, a reservoir was built in 1889 on what is called Kirkpatrick Hill. This reservoir has a capacity of 51,000,000 gallons, which is enough for two days supply of water. The height of the reservoir, being 308 feet above low water in the Cumberland River, is such

where the distribution and control of the water is effected. The purpose of the divided wall is to allow one basin to be used as a settling basin in which the alum, which is added to the water to coagulate the impurities, is allowed to take complete action. As the water flows over a weir at South end of dividing wall from one basin to the other, chlorine is added, and while the water is in the second basin, the chlorine has time to take full effect.

The reservoir constantly continued to give trouble until in 1920, the Board of City Commissioners decided that the whole water works needed careful attention. J. X. Chester, of Pittsburg, was called in as consulting engineer. It will interest the readers of the *Technograph* to know that Mr. Chester is an Illinois graduate. He has been President of the Alumni Association and has always been active in the alumni activities. Mr. Chester drew up the plans and specifications and bids were called for in June, 1921. Mr. W. S. Rae, of Pittsburg, got the contract for the waterproofing of the reservoir. Mr. Rae then gave the work over to sub-contractors who were specially experienced in their respective lines.

The plan was to make the whole reservoir absolutely water tight so that no water could get under the foundations. In order to do this it was proposed to lay over the entire floor of each basin, a layer of membrane waterproofing, over which was to be laid a concrete floor. A layer of gunite was to be shot on the walls followed by a layer of membrane. Over this membrane was to be shot a second coat of gunite. In other words, the membrane was to cover the whole basin floor and walls so that it was

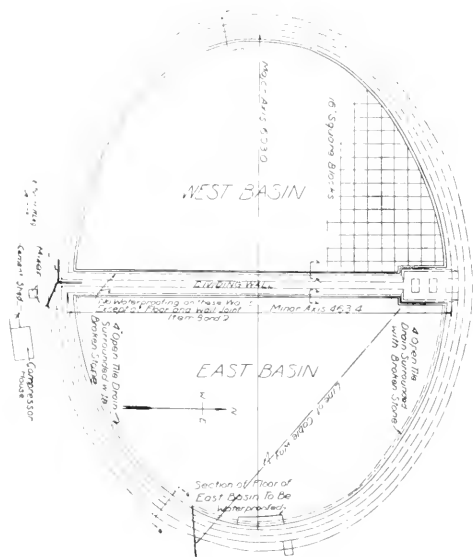

Fig. 1. Plan of Entire Reservoir

that practically the whole city is supplied with water by gravity.

From the beginning the reservoir leaked. The water got into the rock strata under the foundations and softened them into such a condition that in November, 1912 a large section of the wall of the East Basin suddenly slipped out, and 25,000,000 gallons rushed down the hillside doing considerable damage, but fortunately no lives were lost.

Fig. 1 gives the general plan of the reservoir, and Fig. 2 shows sections through the wall and floor. It will be noted that the reservoir is elliptical in shape with a major axis of 603 feet and a minor axis of 163 feet. A dividing wall runs the length of the minor axis, dividing the reservoir into two equal parts, the East Basin and the West Basin. At the north end of this dividing wall is the gatehouse

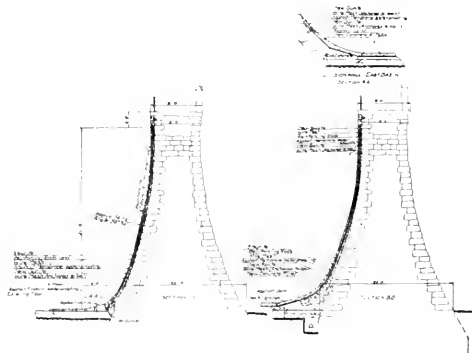

Fig. 2. Sections through walls showing details of waterproofing

made into one large water tight cup which was then to be protected with concrete on floors and gunite on walls.

There were three sub-contractors. The Barber Asphalt Co. represented locally by the Ryan Sales Co., who had the contract to lay the membrane waterproofing, the Gould Contracting Co., of Nashville, who placed the concrete floor, and the Cement-Gun Construction Co., of Chicago, Ill., who did the gunite work. Waterproofing was started July 1st, 1921.

The East Basin had been empty for some time

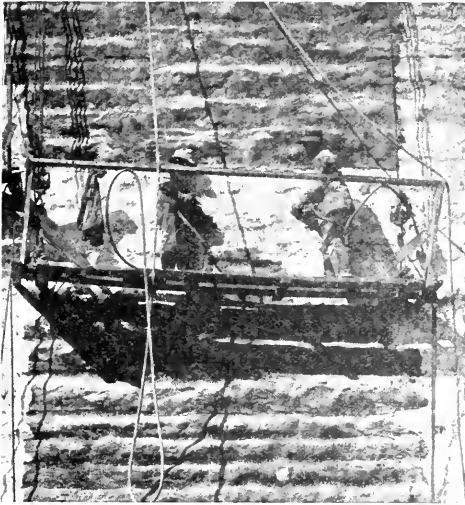

Fig. 3. Part of Basin Wall showing method of removing asphalt coating

due to bad leaks and therefore work was started on this basin while the West Basin was being used to supply the city with water. The first thing that had to be done in preparing the walls for the gunite was to strip off the asphalt that covered the entire wall of the East Basin, about 1/8" thick. It was removed in strips with putty knives, leaving a black stain. This stain had to be removed in order to furnish a good bond for the gunite that was to follow. It was thought at first that the best way to remove this stain was by sandblast, but it was found more advisable to use pneumatic air chipping hammers. These hammers using chisels 1-1/2" wide, operating with an air pressure of 60 pounds per square inch, chipped off a layer of 1/4" to 1" of surface at an average rate of 20 square feet per hour per man leaving a rough wall that gave a good bond for the gunite coating. Fig. 3 shows how this was done and the appearance of the wall before and after cleaning.

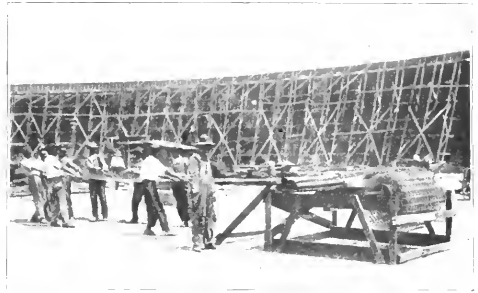

Fig. 4. Wire Fabric used for reinforcing on walls showing how it was straightened

Since the walls of the reservoir were made up of rough stone the surface was very irregular. In order to bring the surface to a more uniform plane, men had to knock off these stones which projected beyond the average plane, with sledge hammers and heavy chisels. Swinging scaffolds were used in these last two steps for it was not practical to put up a permanent scaffold, due to the laying of the floor and to the speed with which the cleaning was done. As soon as the scaffold got a good start and the men who were knocking off the projecting rocks had gone far enough ahead, the placing of the reinforcement began.

Three horizontal rows of holes three feet apart were drilled using an Ingersoll Rand jackhammer "BAR 33" which drilled a 1 1/4" hole 6" deep in 2 minutes. One row was about a foot under the coping stone that covered the top of the wall, another row was placed half way down the wall and the last row was placed near the bottom of the wall.

Into these holes railroad spikes were grouted which were allowed to project about 3 1/2". To these were fastened half inch reinforcing rods running horizontally around the basin. National Steel Fabric wire mesh size .068 was then fastened to these rods. This wire mesh consisted of No. 7 gauge galvanized steel wires four inches apart in both directions and welded together at the intersections, made up into sheets 54 inches wide and about 150 feet to the roll. The reason for using this kind of wire was to take care of the stresses due to changes of temperature. The wire mesh was hung in vertical sheets beginning with the first row of spikes at the top and ending at the bottom, as shown in section B-B Fig. 2, each sheet extending from top to bottom and sheets overlapping 4" at sides welded together with No. 14 gauge wire. Fig. 4 shows a roll of this wire mesh being put through the straightening rolls before being cut into lengths. Through this wire mesh, gunite was shot to an average thickness of three

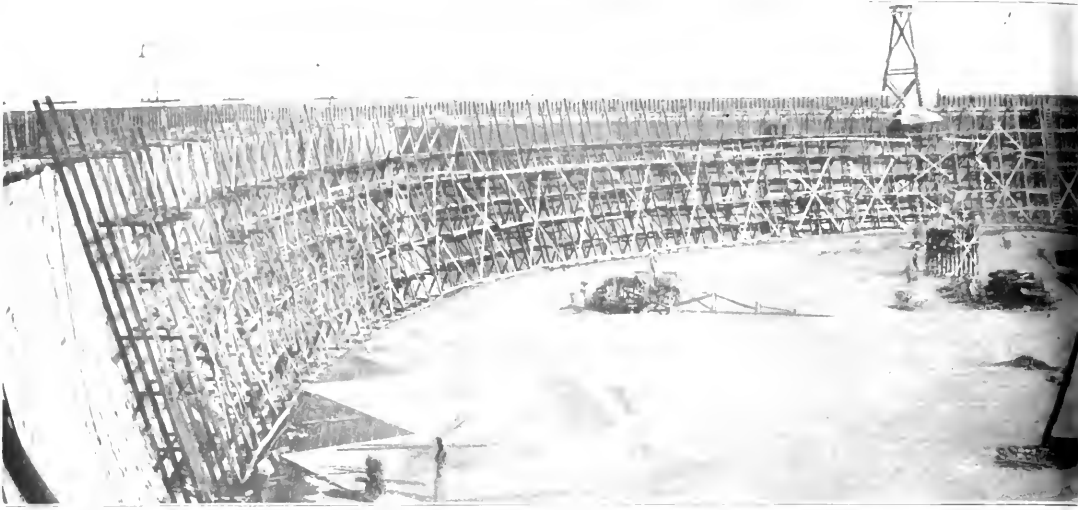

Fig. 5. Panorama of East Basin during construction, showing

inches, giving an even surface from top to bottom.

Gunitite is a mixture of one part of Portland cement to three parts of cleaned, washed sand, mixed dry and shot with cement guns through a hose by means of compressed air at about 60 pounds per square inch, hydration taking place in the nozzle. It will be interesting in this connection to note that the walls of the University of Illinois Armory are hollow tile walls "shot" with gunitite in the same manner. In this case, however, a pebble dash effect was given while at Nashville the surface was left quite smooth.

In order to supply the air for the pneumatic chisels, drills and cement guns, three electrically driven compressors were used. One was a 13 1/2 x 12 Duplex compressor with 125 H.P. motor, one was a 12 x 12 single compressor with 10 H.P. motor and one was a 12 x 10 single compressor with 10 H.P. motor. All these compressors furnished the air at the required pressure of 60 pounds. These compressors were housed in the compressor house shown at the left in Fig. 1. Water was supplied to the compressors and the cement gun nozzles by means of a pump which drew water from the reservoir and delivered it at 80 pounds pressure.

In order to facilitate the mixing of the sand and cement before it was put into the guns, a Kent Continuous Mixer with a 7 1/2 H.P. motor was used. This mixed the sand and cement and conveyed it to an elevator from which it was discharged into a small bin. The mix was taken from this bin by a 20 cubic foot bucket which was hoisted over the wall with a 7 x 10 double drum steam hoisting engine. All the mixing was done on the outside at the south

end of the dividing wall. The mixer is shown at the bottom of Fig. 1, standing outside the reservoir on the south. By means of a Sasgen stiff leg derrick standing on the top of the dividing wall at the south end where it joins the main wall, the mix was dumped into a chute on top of the wall from whence it went down into a hopper inside. This hopper and chute will be noticed on the extreme right in the panorama Fig. 5. From the hopper the mix was put into wheelbarrows and wheeled to the guns.

Fig. 6 shows the Cement Gun contractor's plant outside the wall. At the right are the hoisting engine, cement shed, and compressor house. In the center the mixer is shown in operation with a charge of mix being hoisted over the wall by means of the hoist and stiff leg derrick.

As the first coat of gunitite was finished, the waterproofing man with his membrane followed up. First asphalt was painted over the wall and this was followed by asphalted burlap. This burlap was put on in sheets overlapping each other so that the entire wall was covered with three thicknesses. The burlap reached from 12 inches below the coping stone down to the floor where it was joined to the membrane on the floor. The membrane was then given a final coating of asphalt.

Following this membrane, holes were drilled just under the coping stone, six inches deep and three feet apart pointing downward. Into these holes were grouted half inch rods hooked at the upper end and hung vertically reaching all the way down to the floor as shown in top section B-B Fig. 2. No other holes were drilled as the engineers did not want to puncture the membrane. Through this





Every stage of the work of waterproofing floor and walls

second layer of wire, the second coat of gunite was applied. This layer, which also averaged three inches, extended up to the coping stone and went down further than the first, covering the old wedge block as noticed in section B-B Fig. 2.

It will be interesting at this point to tell of a test that was made to determine how much the adhesion of the second coat of gunite could be depended on to hold this gunite in place in addition to the support given by the hooked rods. On a vertical concrete wall a regular coat of membrane about one square foot, as used on the walls, was put on. Over this a wooden frame was placed one foot square and three inches high. This frame was filled with gunite. At the end of about two weeks a weight of 550 pounds was suspended from it. The weight was put on it about 10 A.M. At 3 P.M. the sample had pulled down about 3 1/4 inches. A rain storm came up and it was not possible to watch the experiment, but on the next morning the sample was found down on the ground. The gunite had been pulled off the membrane and the membrane hung from the wall in a bagged effect. A subsequent test on another sample showed that at 200 pounds per square foot there would be no movement of gunite on the asphalt wall. Fig. 7 shows this test.

Scaffold had to be erected about three-quarters the way around so as to insure continuous operation. This scaffold was used for all operations such as drilling, putting on wire, shooting and placing the membrane. When the last coat of gunite had been put on, the scaffold was taken down and re-erected so as to make the operation continuous from one end around to the other.

Before the floor could be laid it was specified that the upper wedge block should be removed. This wedge block was above the lower wedge block as seen under "old concrete" at the bottom of section B-B Fig. 2. When this wedge block was removed concrete was poured in this ditch so that it came within four inches of the top of the lower wedge block and was piled as high as possible along the wall. This "new concrete fill" is shown in section B-B Fig. 2. This left a notch 4 inches deep above the upper end of the lower wedge block. Into this notch the lower end of the first coat of gunite rested. In this way the surface of the first coat of gunite came flush with the top of the lower wedge block and so a smooth curved surface was provided. This permitted the waterproofing contractor to lay his membrane continuously without break over the wall and floor making of the membrane a perfect cup without break or seam.

A four inch concrete floor was then poured over the floor membrane. This floor was divided into 16 foot blocks with the open 1 inch joints filled with hot asphalt and this floor joined up smoothly with the surface of the final coat of gunite. The contractor who had the laying of the floor erected a large four post tower 55 feet high, which was placed about 50 feet outside the wall at the east end of the reservoir. Over the tower he placed a 1-1/2" cable one end of which was anchored to a "deadman" on the side of the hill and the other end was connected to a large cast iron pipe on the floor under the gate house. The location of the cable way will be seen in Fig. 1. He prepared his concrete with a Koehring one-half yard mixer. This was out-

side next to the tower. From the mixer the concrete was put into a hopper located directly under the cable. The hoisting was done with a steam hoisting engine. From this hopper the concrete was distributed by concrete buggies over the floor as needed.

Fig. 5 shows the panorama of the reservoir as



Fig. 6. Cement Gun Contractors Plant

taken August 18, from the opposite end of the dividing wall by the gate house. This is an interesting panorama for it shows the progress made in about 11 days of actual work and shows the various stages of the work in progress.

At the extreme right is the dividing wall. Next to it in the corner will be seen the chute and hopper used by the cement gun contractor. Further along the side wall is a stretch of the finished wall. Beginning with the scaffold, the reinforcing for the second coat of gunite will be seen through four sections of the scaffold. From there on to where the dark color stops on the left side of the picture will be seen the membrane waterproofing. From where the color stops, for a few feet, can be seen the burlap that covers the first coat. This burlap is kept in damp condition for 24 hours. This was to prevent the wall from drying too rapidly. The first coat ends a few feet further on with the reinforcing wire for the first coat a few feet ahead.

Beginning at the right end of the panorama will be seen two groups of men working. The group nearest the dividing wall is placing the membrane on the floor. The second group is laying the concrete floor. Near the center will be seen the stoves where the asphalt is heated to 500 degrees. Behind these a little to the left will be seen a platform. This platform shown in detail in Fig. 8 is about 8 feet square and is built just high enough so that when the mixture of sand and cement is wheeled upon it, the mixture can be drawn with mortar hoes directly into the top of the guns. The cable wire will be seen in the distance, with the hopper directly underneath the cable and a bucket discharging into

the hopper. Further on to the left will be seen the second cement gun platform. At the end of the scaffold will be seen carpenters at work erecting more scaffold.

It took contractors about 30 days to get equipment on the job, to bring 225 HP of electric current about 1 mile at 2300 volts and transform it down to 220 volts, and erect equipment in running order. Actual work started July 28 and got into full swing by August 1. August 31 at 10:30 A.M. the wall of the East Basin was finished and floor all but a few patches. No work was done on Sunday or Saturday afternoons.

Some years ago when the East Basin was given a waterproofing after the wall had washed out, the dividing wall was given a coat of gunite from top to bottom. It was found that for a space of ten feet up from the floor the water seeped out so badly that it washed away the gunite as fast as it was put on. In order to get the gunite on the wall a layer of tarred felt was placed and gunite shot over it thus forming a hollow curtain wall that kept the water from entering the dividing wall from the East Basin.

When repair work was first done on the East

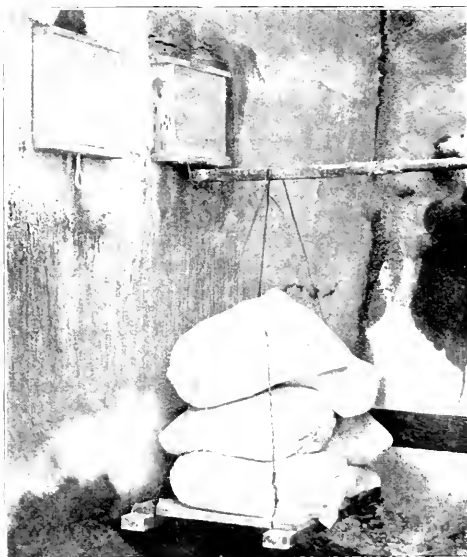

Fig. 7. Showing test to determine adhesion of gunite to asphalt membrane

Basin, in order to give the water as pumped from the river time to settle, a flume was built on top of the dividing wall through which the water flowed into the West Basin at a point farthest away from the outlet. This flume consisted of sheet iron sides

bolted down to the coping stone on top of the dividing wall. The water soaked through the joints of the coping stone into the wall and trickled down behind the curtain of gunite so that it went into the foundations and did the very thing which they were trying to prevent. In making the new repairs this hollow curtain wall described above was knocked off.

Fresh gunite was shot in the notch between the top of the wedge block and the wall as seen in section A-A Fig. 2. This was done in order to give a smooth joint between the floor and wall. Over this was laid a coat of membrane waterproofing part way up and this was covered with a final coating of gunite.

In shooting, water seeping out from the wall

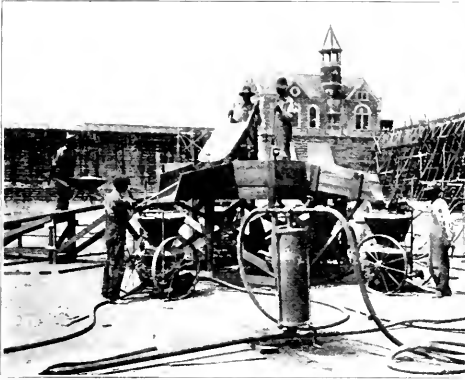

Fig. 8. Three gun feeding hopper

washed away the gunite in places. Different methods were used to stop these leaks. In the morning when the sun shone full upon the wall some of these leaks dried up and were subsequently stopped with Gunite. If these leaks did not dry up they were stopped with a mortar consisting of cement and washing soda. This mixture hardens very rapidly so that with the aid of rubber gloves a man could trowel in the mortar and while holding it there it would harden and stop the leak. Where the water came through so bad that it could not be stopped by the foregoing means, bleeders were used.

At the time this article was written the East Basin was finished, but water had not yet been put in. As soon as this basin is filled and the West Basin is emptied, work will be started on the West Basin. The method of waterproofing the West Basin will be the same as that of the East Basin except for a few minor details. Section C-C Fig. 2 shows the method of waterproofing this Basin.

The writer is indebted to Capt. George Royer,

Supt. of Water Works, of the City of Nashville, for the historical data herein contained, and is indebted to the Cement-Gun Construction Co., of Chicago, Ill., for the photographs.

## Theory of Relativity

(Continued from Page 50)

relativity, it is necessary to study first differential geometry, especially the theory of curvature of surfaces by Gauss and then the non-Euclidean geometry of 4 or  $n$  dimensions by Riemann.

## The Student Council

(Continued from Page 53)

to it. It's a student's Council and it needs the student backing. There is a great prospect of increased student government if you students will take an interest and an active interest in how student affairs are going to be run and in bringing out your complaints and suggestions if things aren't run to your satisfaction. The Engineering school is well represented on the Council, for besides their representative, three other members of the council are Engineers. Engineers, the Council looks to you to support it and get behind it. It's there to help you and you are here to help it.

The room is deserted except for one hunched-over creature in the corner. The green study lamp on the desk, the only light in the room, suggests an atmosphere of quietude. On the desk there is a stack of books smothered together by two crude cut bookends. Before him are the papers and text books ready for an evening's toil, but his mind is far away—and too it is Sunday evening. His mind wanders—three weeks—train home—some sleep—mother's cooking—Helen—more sleep—semester vacation—etc. ad infinitum . . . At this point the chimes in the Library tower bring him back to earth. "Oh, Hell bells, I can't integrate that."

High grades do not a hero make,  
Nor flashy clothes the star;  
Football fans and fannettes take  
Dim not as such by far;  
But the half-back who makes the down,  
Gets the cake and the talk of the town.

There was a young lad from Kankakee,  
Whose grades were somewhat below D;  
He cried out in despair  
When he heard the Dean say,  
"It's best that you take the I.C."



# EDITORIAL

## THE TECHNOGRAPH STAFF

Arthur J. Ingold, Jr. '22	Editor	Walter A. Mueller '22	Business Manager
D. A. Monto '21	Associate Editor	W. J. Klingberg '22	Circulation Manager
E. F. Valentine '22	Art Editor	W. B. Matthews '22	National Advertising
M. F. Jansson '23	Assistant Editor	H. C. Harmsling '22	Local Advertising
J. W. Harriman '23	Assistant Editor	W. R. Unhart '23	Assistant Business Manager
D. C. Murphy '22	Assistant Editor	C. Bowen '23	Assistant Business Manager
P. T. Dedman '22	A. B. Durham '22	H. T. Barrett '23	E. L. Golde '23
C. H. Dodge '23	F. B. Clausen '24	W. F. Gerdes '24	S. E. Miller '24
J. L. Vendig '23	C. T. Parker '24	L. R. Lindberg '25	L. L. Dieus '25
J. V. Schaefer, Jr. '23			D. P. Buchanan '24

## DEPARTMENTAL REPRESENTATIVES

C. C. Cunnell '22	Architecture	G. Reed '22	Mechanical
H. S. Goss '22	Ceramics	R. A. Meyer '22	Mining
W. A. Guttler '22	Civil	S. M. Ellman '22	Railway
D. B. Collins '22	Electrical		

## NEW PRIZE FOR ENGINEERING STUDENTS

In order to promote proficiency, on the part of engineering students, in the powers of accurate observation, in the art of logical thinking, and in the ability to express themselves in good English, Mr. J. V. Schaefer, '89, will annually give a cash prize of \$30.00 for the best paper written by a student of the University of Illinois under certain conditions.

The writer must be a student in the University of Illinois, beyond his Freshman year, in one of the engineering courses offered in the College of Engineering.

The essay is to describe some engineering construction with which the writer has been personally identified in some capacity during some vacation period, and it must be accompanied by photographs and freehand sketches made by the writer. Three copies of the paper must be present before January 7, 1922.

The judges of this contest are to be appointed by the Dean of the Engineering College.

Every engineer is urged to enter this competition. The benefits derived from the work done in preparation of a paper such as this will repay the participant even though he does not win the prize. The winning essay and those of merit will be published in the following issues of the Technograph. Men wishing more information on the contest are urged to see the editor or to leave their names at the Technograph office.

## OPEN HOUSE REVIVED

The engineers again entertained the whole University at the first Open House held in the last two years. From the time the doors opened at 1:00 until the last souvenir was given away at 11:00 an appreciative throng of old and young enjoyed what was conceded to be the best open house yet staged. The cooperation of the departments made the displays equally interesting.

The value of such an event cannot be questioned and every possible effort should be made to make it a permanent and growing institution.

## APPRECIATE YOUR TECHNOGRAPH

This magazine is your magazine. Wherever it may be read, it is accepted as representative of the standards of the students of engineering at the University of Illinois. You cannot afford not to be actively interested in its quality, in the articles published, and in the policies of its Staff. Your friends in similar institutions have access to The Technograph on the exchange files of their own magazine, and their respect for Illinois and for the engineering ability you are developing will be influenced by the quality of your publication. We have the journals of the leading engineering schools in this country on our exchange files, and we invite you to compare them to The Technograph. We want you to know whether or not The Technograph is the best engineering students' publication in the country; for there is no reason why you should accept anything short of the best.

Part of the articles published in The Technograph are written by students. When an article, written by a member of the faculty, would be of great value to engineering students, the Staff considers it a mistake not to place the article before the student body. Also, we consider ourselves fortunate to be the first to secure articles upon engineering projects of national interest by professors of national authority when such articles will establish prestige for The Technograph among engineering journals. We believe it is a compliment to The Technograph to have been quoted on several occasions by the U. S. Bureau of Mines, and to find the leading, British, engineering publication, "The Engineer," desirous of maintaining exchange relations with The Technograph. Articles by faculty members should never discourage a student from submitting one; rather, the desire to place his article next to one by an older man of greater knowledge and experience should be an additional incentive to a prospective contributor. Articles written by students will always be in demand, and it is very unlikely that any good student article submitted will not be published.

---

## DAD'S DAY

Whoever was responsible for the suggestion that Illinois incorporate an official Dad's Day could not have conceived the good that was to come from that suggestion. These Dads are mostly business men with responsibilities and cares that we cannot fully appreciate, and some are reluctant to take the time from their business to visit the University. Of course, they all want to just "see the boys;" but, generally, they come in the interest of our welfare, not at all with the prospect of having a decidedly good time themselves; often with never a thought of Saturday's game.

When they first come in you cannot fail to notice the reserved, business-like faces—typical business men who have brought the office with them. But by Friday evening, after the Pep Meeting, Dad's nothing-can-disturb-me attitude has begun to crack under the strain; he is forgetting those D's and E's and dollars and cents, and occasionally indulges in a good laugh. Then comes Saturday and the game, and Dad's reformation is complete. They are up on their feet yelling with the rest of us. Faces are red, and cigars are neglected. If we win, they will share in the glory; and if we lose, they will have the same sickness.

Sunday's stroll out to the Armory and through the south campus brings conditions back to normal. Dad has had a great time and lost some ten odd years, the University has secured another enthusiastic booster, and several thousand financial crises have been temporarily alleviated. Dad's visit has been a complete success.



# The Application and Maintenance of the Portable Electric Drill

E. L. CONNELL, C.E. '12

*Chief Engineer of The Van Dorn Electric Tool Co., Cleveland, Ohio*

The portable electric drill is essentially an electric motor and should be given all the protection and consideration usually required for such apparatus. The small sizes in common use are equipped with a universal motor and drive the chuck through a train of gears which reduce the speed from 5 to 25 times. The power is supplied through a flexible cable with lamp socket connection and is controlled by a switch conveniently located on the handle of the drill. A typical machine of medium size is illustrated in Figure 1. This drill weighs 10½ lbs. and is capable of drilling 5/16" holes as fast as the operator can force it through the work.

The capacity of electric drills is based on the power and speed requirements of a carbon steel drill drilling in .20 to .30 carbon steel. It is evident that the capacity of such a machine will vary with the material, also that the speed for maximum production will change with conditions, but by standardizing on the above method of rating the manufacturers have done much to aid the prospective purchaser in comparing and selecting the tool. The maker can readily recommend the proper tool for special applications such as wood boring where the capacity of the tool may vary widely from its rated capacity in steel according to the material, depth of hole, etc.

The speed appearing on the name plate is the free running speed and bears no definite ratio to the speed under load. The speed will drop from 25 to 50 percent or more under load. It is not generally appreciated that this characteristic automatically adjusts the speed of the machine to correspond with the size of drill being used and the hardness of the material. An operator who has become acquainted with the tool will have no use for a two speed machine with gear shifting mechanism. The greater simplicity and ruggedness of the single speed tool would even justify some sacrifice if a compromise were necessary. The important factor in obtaining the best performance from an electric drill is the feed pressure. The feed pressure required for drilling in steel to the full capacity of the tool is greater than can be exerted by hand for all except the smallest size. A pressure of 500 pounds is seldom too much for a 1½" machine drilling in steel. A feed screw is therefore usually supplied with the larger sizes.

The minimum drilling performances of a universal drill with carbon steel drills in .20 to .30 carbon steel should be as indicated in the following table. The operating speed represents a cutting speed of 50 feet per minute.

## MINIMUM DRILLING PERFORMANCE OF UNIVERSAL PORTABLE ELECTRIC DRILLS

Carbon steel drills in .20 to .30 carbon steel.

SIZE	R.P.M.	FEED	H.P.
1 1"	800	1 1/2"	.08
5/16"	650	1 3/8"	.10
3/8"	525	1 1/4"	.13
1/2"	375	1"	.19
5/8"	300	3/4"	.23

The free running speed will be about twice the speed given in the above table except where the tool is designed for a lower cutting speed.

The capacity of the motor should appear on the name plate in amperes and the motor should be capable of carrying this load for 30 minutes without over heating. In so far as the motor is concerned, the temperature reached in this time may be 50 degrees Centigrade (90 degrees Fahrenheit) above the room temperature. The high armature speed gives an excellent opportunity to make use of forced ventilation and with a well designed fan the cooling system is very efficient. The nature of the work is such that full capacity of the motor is never required for 30 minutes without relief so if the tool will stand this test, there will be no objectionable heating.

The ampere capacity is not always given, in which case a test by competent engineers is the only method of checking the power and heating characteristics. The efficiency will vary between 40 and 60%, according to size and design, at a load which reduces the speed to about the figure given in the table above. An approximate check may be made on this basis.

In checking the performance of a universal motor, the test should always be made on 60 cycles alternating current. A motor of this type is similar to the direct current series motor in its characteristics but its construction is altered to permit operation on alternating current. These structural

differences include lamination of the field magnetic circuit, often a slotted field design with the winding distributed in slots, a high ratio of armature to field turns, and a large displacement of the brushes from neutral position. These special features are all used to reduce the reaction of the windings and maintain the power on alternating current. The power on alternating current will always be less than that obtained with the same direct current input. Manufacturers of this type of motor usually do not recommend them for use on frequencies over 60 cycles because the efficiency drops very rapidly with increasing frequency. The lower the frequency, the more nearly do the characteristics on alternating and direct current coincide. It will be found that when the machine is operated on high frequency circuits the power will be deficient and the heating excessive.

The brushes used on such motors are chosen after exhaustive tests on the part of the maker to obtain the best performance and the longest life. It is therefore imperative that only such brushes be used as are furnished by the maker for the particular machine. A brush made from any material at hand may ruin the motor. Some of the effects possible are overheating from friction, sparking, or high resistance. If the material is too hard, the friction and wear on the commutator is excessive, and if too soft, the mica may wear high and bring on chattering and destructive sparking. If the resistance of the brush is too low, excessive short circuit current will cause sparking and overheating of the commutator and armature coils; and if the resistance is too high, the normal current may overheat the brush. The life of the brushes cannot be stated in ordinary terms because of the very great variation in the use of the tool. However, it is best to examine the brushes before the expiration of 200 hours actual running time, and it will be a help to clean the commutator with fine sand paper several times during the life of the brush. The tension on the brushes should be uniform and just sufficient to prevent arcing on a smooth commutator. A tension of at least 4 pounds per square inch of brush contact is usually necessary. Should the commutator become rough, the armature should be removed and the commutator refinished by taking a very light cut on a lathe.

All reputable tools of this type have enough power to prevent absolute stalling except under accidental circumstances. When this does happen through bending a drill or other accident the power should be cut off as soon as possible. Momentary stalling of this kind will not injure a well designed machine. The part most apt to fail under these circumstances is the switch, which must then act like

a circuit breaker. Quick break and generous contact area are very important requirements. Some tools are equipped with fuses for such emergencies, but as the operator usually replaces them with copper wire because a fuse is not immediately available, their practical value is rather doubtful.

Sometimes when drilling sheet metal, the lip of the drill will catch as it breaks through, stalling the machine. This trouble can be prevented by grinding the drill especially for this work. The angle of the point should be reduced to give a longer point, 59 degrees is the standard angle, and the sharp angle at the cutting edge should be ground off slightly to

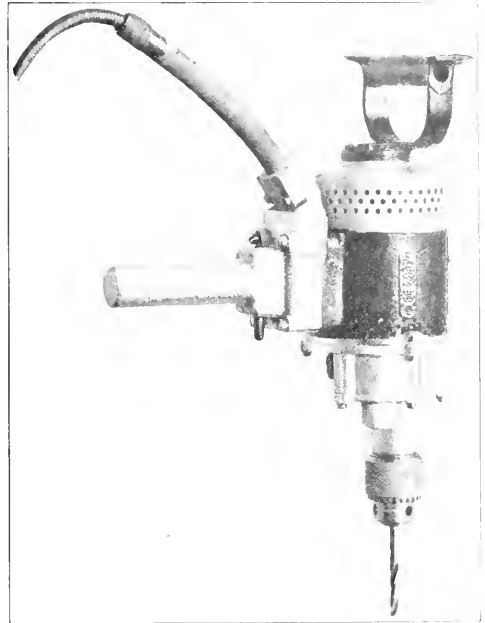

give the same result, as a smaller procedure alone may also help to prevent "grabbing" in soft material and will allow high feed pressures without chipping the cutting edges in very hard material. For drilling in wood the type of drill will depend upon the condition and kind of wood and the depth of the hole. Very deep holes require the ship auger. When drilling green wood the hole should be cleared several times if the depth of the hole is many times the diameter. In soft, dry wood, the speed and size of hole which can be drilled with these little machines is amazing. This matter of choosing and conditioning the drill is a very important one and can best be solved by the mechanic on the job.

The better class of tools are grease lubricated.

(Concluded on Page 84)

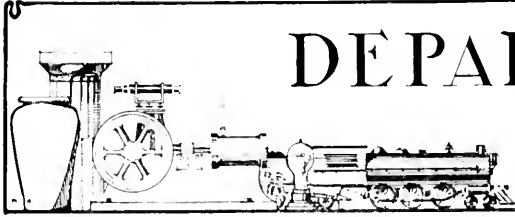

# DEPARTMENTAL NOTES

## Architectural Notes

The second meeting of the Architectural Society, October 26, was featured by Mr. E. J. Hogue's illustrated lecture, "Logging and Lumber Manufacture in the Douglas Fir Forest Region." With the aid of beautifully colored slides, and with the spirit of the true traveler, Mr. Hogue conducted his audience through that scenic wonder land of America, the Pacific Northwest Region. Particular interest was shown in the modern methods of logging peculiar to the Douglas Fir Region, such as the use of the spar-mast for removing logs from the cut area. In describing the organization and efficiency of the range service, from the lone lookout on a low peak to the aeroplane observer who scans the inaccessible areas, Mr. Hogue made bold to say that one could not knock out his pipe in a twenty mile area without having the fire squad turned out. This lecture was the first of a series to be given throughout the year before the Architectural Society.

To acquaint the new students with the society and the men of the department, a smoker was given November 16, at the Union Building. Prof. W. C. Titcomb, N. I. Crandall, J. E. Burgess and C. R. McAnlis entertained with good stories and incidents of life in architectural departments of the eastern schools. An impromptu orchestra, and an Egyptian dance by R. A. Watson, '21, injected pep into the meeting. The membership campaign now being conducted by the Society will not stop until the department is represented 100 per cent.

"Mission Architecture," a new book by Prentice Duell of the Department of Architecture, has been presented to the Ricker Library by the author. The book is a study of the Spanish Priests' building methods in general, especially as represented in the Mission of San Xavier Del Bac. It contains many photographs and drawings by the author, taken while on several exploring trips.

War posters of America, France and Germany are being exhibited by the Department on the fourth floor of Engineering Hall. The German posters, miniature battle scenes in dull color and of post card size, are in great contrast to the bold line and vivid color of the French and American posters.

Scarab Fraternity met November 17, at the Hus house. Prof. J. M. White, supervising architect for the University, gave a very interesting talk on the "Housing Situation," as influenced by building costs, rentals, wage scales, etc. Charts, plotted from index numbers, depicted graphically the trend of prices, and indicated the relative advantage, or disadvantage, of building during any particular period. Prof. White concluded his talk with a history of the development and planning schemes of the University from its founding to the present day. Plans for the future were outlined, including the development of the south campus, the Stadium, and the building of men's dormitories in the University district.

Gargoyle Society met November 10, at Sigma Alpha Epsilon house. Mr. O. E. Brunkow presented a very interesting paper upon "The Development of the Community House as a War Memorial."

## A. A. E. News

The American Association of Engineers has held its regular bi weekly meetings and great interest has been shown in the speakers on each occasion. On Saturday, October 22, the Association held its first smoker of the year in the Gym Annex. Mr. W. G. Harris, Managing Editor of the "Highway Engineer and Contractor," and formerly Chief Engineer of the Portland Cement Association spoke on the value and far reaching effects of a student's activity in an engineering society. Mr. Harris presented his subject in an interesting and pleasing manner, and his audience was sorry to see him leave the floor. Prof. Wiley, of the Civil Engineering Department, favored the gathering with some interesting stories, which everyone present proclaimed the best ever. Mr. Radebaugh, of the Shop Laboratories, also gave several reasons why the young engineer should take active part in one or more engineering societies. Fred Scheineman, '22, gave a short resumé of his associations with the local chapter of A. A. E. and the prospects of the organization in the future.

On Wednesday evening, November 9th, Dr. Gordon Watkins, of the Department of Economics, gave a talk on "Human Engineering in Industry."



Dr. Watkins' talk was timely, and opened a new field of thought for the future engineers who were present. A large attendance was proof that the student engineer is seeking more than just technical knowledge.

A. A. E. is endeavoring to bring to the student engineer a knowledge of what professional men in other lines of endeavor are doing, and to teach him how to make his hard earned technical knowledge worth more to himself and to the people as a whole.

Nationally, A. A. E. is giving special attention to helping the young engineer when he is becoming established, which is the difficult period of his life. The young graduate has been so engrossed in becoming well grounded in technical lines that he is likely to be lacking in the grasp of life that comes from an understanding of the laws of business economics. The banker, the business man, and the public in general have confidence in the ability of the engineer to solve most any physical, or technical problem, but they are likely to avoid his council in administrative problems. Not only is A. A. E. finding positions for the young man to which his training and talents adapt him, but the Association endeavors to continue his training with special attention to his social and business needs.

## Electrical Engineering News

On Friday, October 7, a joint meeting of the Urbana branch of the American Institute of Electrical Engineering Society was called to order at 7:15 P. M. by Prof. Waldo. A large number of members were present and the lecture room was well filled. Prof. J. T. Tykociner, who was formerly a European Radio Engineer with extensive experience, and is now connected with the E. E. Department doing research work, was introduced by Prof. Waldo. Prof. Tykociner read an interesting paper on the development of radio work in Europe and the United States, and gave an illustrated lecture on "European High Power Radio Stations." This lecture gave the history of radio from its beginning up to to-day. Several pictures of the latest apparatus used in radio work were shown and explained. After the lecture a short business meeting was called by the President. The joint meeting was considered a success and a committee was appointed to act in conjunction with a committee of the A. I. E. E. in arranging for joint programs during the year. Elaborate plans for the E. E. Show, to be given April 20, 21, and 22, were discussed. Many new ideas are being developed by the Live Wire Club, and the Show promises to be one of the best that has ever been presented.

On November 4, 1921, another good meeting of

the E. E. Society was held. E. W. A. Taylor gave an interesting, instructive, and amusing description of the Engineering inspection trip taken by the Seniors. Mr. H. E. Barden, '15, who is now Protecting Engineer of the Southern California Edison Company, told of some of his experiences on submarines. He was on both German and U. S. submarines, and gave some very interesting details of their construction. Mr. Barden spoke to the Seniors in the morning, telling them of a new project in California. This engineering work will be the construction of several dams across the Colorado River, which will furnish power for all California and will be a great step towards the electrification of the railroads.

## Ceramic News

After a preliminary meeting, the members of the student branch of the American Ceramic Society decided to hold a general smoker and mixer for all the students enrolled in Ceramic Engineering, this being considered the best means of getting acquainted and of obtaining new members.

Accordingly, at seven o'clock on November 8, a meeting was held in the Union building, with plenty of smoke, cider and doughnuts provided to put some pep in the gathering. It was a success in every respect. After the would-be Ceramists had gathered, self-introductions were in order until each man had announced his name, his class, and his practical experience, in Ceramics, if any. Some didn't even know what the word meant, while others had been "born and raised in a brickyard." Members of the faculty talked on the field of Ceramics, its opportunities, Engineering Open House, and the past, present and future of the local branch of the Society.

After the talks and the eats, practically all the new men signed up for membership in the organization, and a short business meeting was held. Committees were appointed for Open House, and the new constitution for the Engineering Council was accepted.

H. Tsutsumi, of Waseda University, Tokio, Japan, is working in the Ceramic Department investigating the mechanical and electrical strains in electrical porcelain, and the conductivity and disintegration of the body and the glaze under working conditions. He has made up some interesting pieces of ware during the process of his experiments.

In the basement of the Ceramic building a new laboratory is being fitted up for the use of the classes in plaster work and casting. These classes outgrew their former laboratory. The class in plaster mould work is coming along well with plate models, bowls and vases.

Porcelain tubes, crucibles, and other equipment

for the Chemistry Department are now being made. For some time the department has been supplying porous filter plates.

A machine for making various sized, thermo-couple protecting tubes used in pyrometry has been set up on the north wall of the kiln house.

G. Swinerton, '25, who has had practical experience in the modeling and mould making departments of potteries, has been engaged by the department to get out some special fire clay shapes to be used in frill furnaces.

Dr. E. W. Washburn, head of the Ceramic Department, University of Illinois, gave a recent address to the Central Ohio Section and the Ohio State Student Branch of the American Ceramic Society on "A New Method of Measuring the Porosity of Ceramic Bodies."

## Civil Engineering News

The meeting of the student chapter of the American Society of Civil Engineers on October 21, although poorly attended, was very interesting and profitable to those that attended. The speaker of the evening, Mr. E. A. Nelson, gave a detailed account of his summer work in a clear, concise manner. He explained very accurately, with the aid of some fifty photographs, the construction of the North Hill Viaduct at Akron, Ohio. For those members who were not present at the meeting or for anyone who wishes to know more of the details of the viaduct, Mr. Nelson has written an article which is published in another section of this magazine. Look it up for it is well worth your while.

The latest meeting of the A. S. C. E. on November 10, was a record breaker for attendance, for almost every seat in the old engineering lecture room was occupied. Prof. C. B. Pyle spoke on the erection of the Sciotoville bridge. This steel structure has a total length of 3,435 ft., consisting of two main channel spans of 775 ft. each, a south (Kentucky) approach of 1,062 ft., and a north (Ohio) approach of 882 ft. The river spans are continuous over the center pier and constitute the first large bridge of continuous type as well as the longest and heaviest fully riveted trusses in America. The large river spans were built for a double track. The approach viaducts, each consisting of one 152 ft. deck truss and 68 to 110 ft. plate girder spans, were built, for the present, with steelwork for only one track, while the masonry was built to accommodate a future second track. The erection of the steel was the main topic, for Prof. Pyle was actively engaged in this phase of the work as the engineer for the McClintic-Marshall Construction Company. The erection was carried on by means of a gantry trav-

eler on falsework on the Ohio side and to a point 125 ft. beyond the center on the Kentucky side. From this point the Kentucky span was erected as a cantilever by means of an overhead creeper to the Kentucky shore. However, heavy steel bents were used to support the trusses at two panel points in order to reduce the otherwise excessive stresses in the trusses.

The meeting lasted until ten o'clock. Prof. Pyle's knowledge of the subject plus his genuine humor kept the listener intensely interested until the very last.

The Research Department of Structural Engineering, in charge of Prof. W. M. Wilson, has been carrying on several important tests. The one that has aroused the curiosity of the student body is that of the Concrete Arch Test, which was conducted in back of the Shop Laboratories on Springfield Avenue. This test was run to determine how near the actual stresses approximate the theoretical stresses as derived from the elastic curve theory of a three-hinged arch.

The Department also intends to make an experimental study of the Warping of Concrete Road Slabs. The purpose of the experiment will be to determine: (1) The magnitude of daily seasonal changes in the shape of a concrete road slab. (2) Temperature changes in the slab. (3) Internal stresses due to the warping of the slab. (4) Influences which cause a road to warp. (5) The effect of the warping of a road slab upon the soil pressure beneath the slab. (6) The effect of the warping of a road slab upon the bending stresses due to a load on the slab. It is planned to build the slab on the lot which the University owns east of the store room and facing the street car tracks. The concrete was poured about December 1st. Observation will begin as soon as the slab is poured and will continue throughout the school year until cold weather sets in for the winter of 1922-23.

## Mechanical Engineering News

At the first regular meeting of the student branch of the American Society of Mechanical Engineers Prof. A. C. Willard forcibly put forth his views of the Society and the advantages to be derived as a member thereof.

If a man would become a leader in his profession he must choose a branch of that profession in which to specialize and then center his attention upon it. It is true that while at the University very few of us choose a particular branch of mechanical engineering in which to specialize, but we all contemplate entering some branch of the profession and we should therefore make some systematic effort to

keep in touch with the entire, ever-changing mechanical engineering field.

The best means to accomplish this end is to obtain regularly some authentic publication such as the A. S. M. E. Monthly Journal, a periodical devoted exclusively to the furtherance of the profession. Text books do not attempt to present the latest development in a subject. They are designed merely to emphasize fundamental theory and they have well served their purpose if they succeed in this. Text books are obsolete at the time of publication insofar as viewed from a standpoint of recent design and application. The A. S. M. E. Journal lists among its contributors the most prominent engineers in the country and contains information of unquestioned authenticity on well chosen subjects.

The subject of power plant design and equipment serves as a typical instance of changed engineering ideas. A few years ago it was generally thought that power plant equipment had reached a stage of stability. At the present time, however, questions such as the use of powdered fuel, the adoption of greater pressure limits, the correct method of feeding fuel, and the application of economizers, superheaters and condensers beset the power plant engineer.

The discussion of improved design and new application in the various branches of the engineering profession are out of place in the classroom. The classroom is properly the home of abstract theory and the more involved the engineering profession becomes, the more remote is the chance of discussing engineering practice in the classroom with our present four year curriculum.

Mr. L. Dantzig, scientific investigator for the SKF industries, gave a talk on the subject of "Ball Bearings" before the A. S. M. E. on November 1, 1921. The lecture was accompanied by slides, which traced the manufacture of ball bearings from the Swedish steel, of which they are made, to the final grinding to .0001 in. limits.

J. P. Mullen has been engaged as Research Assistant to Prof. H. J. Macintire. Mr. Mullen came here direct from England where he has been engaged in refrigeration work. After obtaining his B. S. degree in Refrigeration at the University of Liverpool, Mr. Mullen entered the Royal Naval Service where he served during the war. He comes to us after having attained his M. S. degree with honors, and will be engaged in research on the newly equipped ammonia compressor machine in the power laboratory.

Tests are now being run in the M. E. power laboratory on the new 35 h. p. Hvid oil engine, which was purchased this semester. Students in M. E. 65 are running the engine to determine the effi-

ciency under various loads, capacities and fuel consumptions.

At a regular meeting of the A. S. M. E., November 8, motion pictures depicting the manufacture of steel in the plants of the American Rolling Mill Co., at Youngstown, Ohio, were shown. The manufacturing process was traced from the dumping of the raw materials into the blast furnace, to the pouring of the steel into ingot moulds, including the purifying in the open hearth furnaces. After being reheated in the soaking pits, the steel ingots are run through rollers, and later given a zinc coating to produce the final galvanized sheet.

A feature of this film was the photography involved in taking pictures of molten steel in the open hearth furnace. This was rendered possible by using a water cooled camera, which prevented the intense heat of the furnace from burning the film.

Mr. J. W. Northrup, of the Stone and Webster Co., gave a very instructive talk before the A. S. M. E., on November 24, on the development of a hydroelectric power plant of 60,000 h. p. to supply the city of Los Angeles. Mr. Northrup traced the water supply of the plant from glacial sources to the mountain stream that was tapped, and through the elaborate piping system to the penstocks, which delivered the water at a head of over 1000 ft. to the water wheels.

The building of the plant presented many unprecedented problems. Railroad lines had to be laid through the wilderness to a site 10,000 ft. in elevation, in order to transport the necessary machinery and building materials. The power is sent at a high voltage 186 miles across country to Los Angeles, where it now competes with power generated in the heart of the city.

## Municipal and Sanitary Engineering Notes

A complete plumbing outfit for a five story building has been installed in the power house tower. It is used to determine, experimentally, the proper size of soil stacks. This work is under the supervision of Prof. H. E. Babbitt. A paper on this experiment will be read before the Illinois Master Plumbers Association at their next meeting in January.

"Sewerage and Sewage Treatment," by Prof. H. E. Babbitt, will be released by the printers, John Wiley & Sons, this month. This book will be used as a text book for courses 3 and 6a in M. & S. Engineering. The book contains 500 pages, 180 illustrations, and 120 tables.

Plans are being contemplated for the erection of a sewage testing plant on the campus. This work will be done jointly by the Illinois State Water Sur-

vey, the Department of Municipal and Sanitary Engineering, and the Department of Farm Mechanics.

The Department of M. & S. Engineering placed two exhibits in the Hydraulics Laboratory for the Engineering Open House. One showed, in miniature, a modern water purifying plant with coagulating basin, mixing chamber, and a rapid sand filter, which is washed with air and water. The other was a miniature sewage treatment plant complete with Inhoff tank, sprinkling filter, automatic dosing plant and sand filter.

## Railway Engineering News

The third meeting of the Railway Club was held November 10, 1921, in room 206 E. E. Laboratory. Mr. Charles Gordon gave a very interesting talk on the design of B.S. street cars. Mr. Gordon received his degree of B.S. in E.E. from this University in 1912 and since then has been connected with the Chicago Surface Lines. He now holds the position of Engineer of Equipment, and is a recognized authority on street car design.

Mr. Gordon said that the design of a street car was limited by two factors: the habits of the riding public, and the method of fare collection. "It takes years of hard work and patience to get the public accustomed to any change so that it is easier and cheaper to design a car to suit the public than to train the public for the new design. Forty per cent of the people using the street cars in Chicago get on and off the cars while they are in motion. This has enabled the company to run cars on faster schedules without an increase in the number of accidents, because most of the people in Chicago know how to get on and off cars while they are in motion. The 'pay as you enter' idea as used on most of the street cars in Chicago was patented when originally adopted, and the Chicago lines and all other lines using this system of fare collection had to pay royalties to the patentee. This patent was later made invalid."

All the old cars on the Chicago surface lines are of the so-called "Pullman" type. They weigh 53,000 lb. and have a capacity of from 40 to 45 passengers. The cost of operating these cars is five cents per pound per year. The new cars have an arched roof, are 48 ft. 5 in. long, weigh 35,000 lb., and seat 53 passengers. The "Safety Car," designed and built by the Surface Lines' engineers, is 46 ft. long, weighs 26,000 lb., and has a capacity of 60 passengers. Among many other facts Mr. Gordon stated that it requires 250 lb. of paint to paint one car. An article "Modern Tendencies in Street Railway Operation" which is in this issue will interest those concerned with surface car problems.

## Mining Engineering News

The Miners held their second smoker of the year at the Illini Cafeteria with an attendance of nearly three-fourths of the Mining Engineering enrollment, and the majority of the Faculty. President Allison, in bringing together the undergraduates and the department staff, has succeeded in establishing a better understanding between the two and has proven the old theory that professors are really human. Professors Stock, Drucker, and Arms were called upon to relate some of the comic events that they had experienced, while Dr. Rutledge and Mr. Stewart told of their work in connection with the U. S. Bureau of Mines Stations here and in other parts of the country. At the Annual Election of Officers, E. H. Allison was elected President, J. F. Machamer Vice President, and A. B. Stevens Secretary-Treasurer.

Mr. Yancey, who is connected with the U. S. Bureau of Mines Station here as a chemist, gave a very enlightening talk on radium at the first semi-monthly meeting of the Mining Society. He was directly connected with the work of mining the carnotite ore in Colorado and Nevada, and was able to give a first-hand explanation of the process by which a very small bit of the Uranium is obtained from many tons of the ore.

At the meeting of the Illinois Mining Institute held in Springfield on November 19th Professor Harry W. Stock, head of the Department of Mining Engineering, was elected president for the coming year. One of the speakers at the meeting was Dr. James Rutledge of the Engineering Experiment Station, who talked in an interesting manner on some of the scientific and practical problems of coal mining.

Dr. Rutledge also addressed the Mining Society on December 6th. His talk was based upon the results of his years of observation both as a student and as a practical mining engineer, and was what he was pleased to call "fatherly advice" to the mining students. He emphasized the necessity for a thorough knowledge of mathematics and the sciences, the keeping of scientific notes, and above all the faculty of "observing the little things."

The Department of Mining Engineering has been very fortunate in its Staff selections of the past year and exceedingly so in securing the services of Prof. A. E. Drucker, B.Sc., M.I.M.M. (London). Prof. Drucker spent the last two decades in numerous mining projects, and last year as Ass't Prof. of Mining Engineering at the Wisconsin State School of Mines. He became Associate Prof. of Mining Engineering at the University of Illinois in February 1920.

(Continued on Page 82)

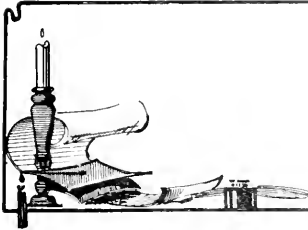

# A L U M N I N O T E S

*T. Kruger*, m.e., '20, is with the Locomotive Pulverizing Fuel Co. at the new Lakeside Power Plant, Milwaukee, Wis. He is doing special research work with Henry Kriesinger, m.e., '04.

*G. S. Kenedy*, cer., '20, visited the department during Homecoming. He is with the Chicago Fire Brick Co.

*C. R. Vetzg*, c.e., '16, is working with a consulting engineer on a Dam construction job in Decatur. *Martin Frisch*, m.e., '21, is instructor in Mechanics at the University of Wisconsin.

*E. B. Baker*, cer., '21, with the U. S. Bureau of Mines, is a member of the party investigating the burning of kilns in plants located throughout the country. They expect to be in Danville soon.

*L. B. Breddore*, m.e., '14, is a post-graduate student in Mechanical Engineering at the University of Illinois.

*Howard R. Rolrock*, c.e., '16, is District Engineer for the Barrett Waterproofing Company with headquarters in Danville.

*N. A. Ragland*, cer., '21, went to California this summer and is now working for the Alberhill Coal & Clay Co. at Los Angeles. He has been engaged in developing bodies and glazes suitable for art pottery.

*D. L. Henry*, c.e., '09, is in the engineering division of the Illinois Commerce Commission in Springfield.

*R. B. Christopher*, cer., '17, was also a Homecomer this fall. He is with the Evans & Howard Fire Brick Company at St. Louis.

*R. F. Doepf*, m.e., '21, is taking training as salesman for the Chase Mfg. Company of Mattoon, Illinois.

*A. L. Perry*, m.e., '05, has been appointed manager for the Western Electric Company at Omaha. During the past sixteen years with this company he has been all over the circuit familiarizing himself with the business. He learned the method of office management in the first five years, later the intricacies of the inspection department at New York and Hawthorne and the management of stores at St. Louis. In 1918 he was appointed Credit Manager for the Government Department and twelve months later he reverted to the distri-

buting organization as assistant Credit Manager at New York.

*F. B. Dunlap*, arch., '16, is employed by Lamboungouise as an architect in Chicago. He is designing the Bahai Temple, which is being erected at Wilmette, Ill.

*Paul M. Farmer*, c.e., '09, is now district sales agent for the Klaxon Horn Company at New York. He was formerly Chief Engineer for that company.

*Walter H. Seabers*, a.e., '11, is now senior partner in the architectural and engineering firm of Batchelder & Seabers, Indianapolis, Ind.

*O. S. Buckner*, cer., '16, returned to the United States from Japan some time ago after a three year's stay in the interests of the Norton Company of Worcester, Mass., manufacturers of abrasives. He expects to return to Japan in the spring for another three year period.

*Robert S. Arthur*, c.e., '08, is Associate Editor of *Successful Methods*, a magazine devoted to construction service.

*W. G. Hancock*, m.e., '19, is now Maintenance Engineer for the Smith Steel Casting Company.

*John Fucik*, c.e., '10, is connected with the department of Roads and Sewers of the city of Chicago.

*P. P. Glick*, m.e., '21, is in the engineering department of the Moon Motors Company.

*J. Shapiro*, m.e., '20, is Mechanical Engineer for the Universal Stamping & Mfg. Co. of Chicago.

*F. H. Clark*, m.e., '30, has gone to Peking, China, where he is holding a position with the Chinese Government Railways.

*Alfred L. Kuchn*, c.e., '00, has recently been made president of the American Creosoting Company of Louisville, Kentucky. He has been connected with this company for the past seven years in the capacity of general superintendent and later as vice president.

*R. H. Kuss*, m.e., '03, is with the Malcolmson Engineering and Machine Corp., Chicago, and is working on heat problems arising in design and operation of fuel briquetting, peat harvesting, low temperature distillation, etc.

*I. V. Hansen*, arch., '19, is in business for himself in Memphis, Tenn. He reports plenty of work.

*Leo W. Fisk*, c.e., '09, is now manager of an electric

light and power plant of Springfield.

*John A. Scuttrille, c.e.*, '19, has just recently been appointed a lieutenant, junior grade, in the civil engineering corps of the U. S. Navy. He is now stationed at Mare Island navy yards where he has active charge of the design of several concrete and steel structures.

*Francis J. Plym, arch.*, '37, donor of the Plym Fellowship, is located in Niles, Michigan. He is manufacturing corner store fronts.

*R. Stockenberg, m.e.*, '19, is in Chicago acting in the capacity of sales engineer for the Johnson Service Company of Milwaukee, Wis.

*Loren J. Schmidt, arch.*, '13, visited the University last week and called upon some old friends. He is now in business for himself at Wichita Falls, Kan.

*R. G. Olson, m.e.*, '18, is in the designing department of the American Blower Company of Milwaukee.

*A. K. Bose, m.e.*, '11, is in the employe of Swift and Company of Chicago. He left for India about the middle of November.

*W. E. Hallauer, a.e.*, '21, is assisting in architectural engineering at the University.

*William M. Young, c.e.*, '21, is helping Professor Knipp in the Physics Department as a part time assistant.

*H. G. Butler, c.e.*, has resigned his position as State Power Administrator of California, and has gone into consulting engineering work with offices in San Francisco.

*Chas. H. Torunquist, c.e.*, is Construction Engineer in the erection of a new power plant at Olmstead Utah, for the Phoenix Utility Co.

*Gilbert E. Ryder, c.e.*, '09, former editor of Railway Review, has been elected Vice-President of the Locomotive Superheater Co., New York.

*Hugh A. Brown, c.e.*, '11, of the electrical engineering staff at the University, was in charge of the wireless station which was used in broadcasting football news.

*F. B. Ingersoll, c.e.*, '03, is now in the contracting business at Marshall, Iowa.

*A. C. Chakravarty, m.e.*, '18, is now in engineering practice in Calcutta, India.

*I. M. Houser, m.e.*, '21, is in the mechanical engineering department of the Crane company of Chicago.

*I. H. Charles, c.e.*, '20, was one of the homecomers this fall. He is located with the Benjamin Electric Co. at Desplaines, Illinois.

*M. J. Hammers, m.e.*, '08, is a Mechanical Engineer for the Nokol Corporation of Chicago.

*"Pat" Meyer, c.e.*, '19, is now Assistant Engineer of Construction of the Illinois State Highway Department.

## Mining News

(Continued from Page 80)

Prof. Drucker graduated from the California School of Mechanical Arts in 1897, and the College of Mines, Univ. of California, in 1902. The same year he was elected to Honorary Membership in Sigma Xi, and in 1912 became a member of the Institute of Mining and Metallurgical Engineers of London. He is also a member of the Mining and Metallurgy Society of America, and the American Institute of Mining and Metallurgical Engineers.

Always following the profession of Mining Engineering, Prof. Drucker has served as an Assayer, Surveyor, Mill Foreman, and Superintendent of Metal Mining Companies in California, Mexico, Korea, and in 1910, as a member of the Metallurgical Examination Commission, toured the World's Mines, observing and studying the mining practices in Japan, Phillipines, Malay States, Australia, New Zealand, So. Africa, and England, as well as the United States.

He has been a Consulting Metallurgist with offices in London, South America, and New York, having designed, erected, and operated over 11 mills and reduction plants. During this time Prof. Drucker has originated and developed two distinct processes for the recovery of Gold and Silver which are in use throughout the world. He has also invented a number of universally used machines, such as a Continuous Vacuum Filter, and Wet-Crushing Ball Mill.

During the past 15 years he has contributed to numerous Text and Hand Books, Journals, and Mining Magazines, and at present has undertaken the writing of several Text Books for Metal Mining. This first hand information will be of great value to the men pursuing the study of Mining Engineering.

## Municipal and Sanitary Engineering

(Continued from Page 65)

one full time engineer, and the largest has on the staffs of its many engineering bureaus literally thousands of employees. There are 419 incorporated places in the United States with a population of less than 10,000. From time to time each of these places requires the talents of the engineer. Much of this work is being done by civil engineers who have gained the necessary special knowledge after graduation, as a result of the scarcity of graduate municipal engineers. The National Government and a large percentage of the states maintain departments of health, one subdivision of which is the sanitary engineering section, which offers employment to many engineers. More men trained as sanitary en-

gineers are employed, proportionately, by these departments of health than in other branches of engineering, yet because of the scarcity of specially trained men, civil engineers predominate in these departments, and one leading sanitary engineering section is directed by a ceramic engineer.

The demand for municipal and sanitary engineers is not only large, but it is growing. Present day conceptions of sanitation are based on the scientific discoveries which have resulted in the increased comfort and safety of human life during the past century, in the increase of our material possessions, and in the extent of our knowledge. The danger to health in the accumulation of filth, spreading of disease by various agents, the germ theory of disease, and other important principles of sanitation can be counted among the more recent scientific discoveries and pronouncements. Experience has shown, and continues to show, that the increase of population may be inhibited by the accumulation of wastes in populous districts. The removal of these is therefore essential to the existence of our modern cities.

Sources of pure water are constantly becoming less available, and polluted water supplies must be purified. John M. Goodel states in the *Journal of the American Waterworks Association* (Vol. 7, p. 272):

"The governmental-cost payments for expenses of public service enterprises in 1918 amounted to a total of \$55,174,480 in the 227 census cities, of which amount \$39,699,280 was spent on water works operation and maintenance, \$4,050,679 on the operation of electric light and power plants, \$1,115,947 on the gas supply systems, \$735,981 on markets and public scales, \$2,713,738 on docks, wharves, and landings, \$1,232,971 on cemeteries and crematories, \$362,203 on public halls, \$11,733 on subways, and \$1,249,845 on all other enterprises, the largest item in the group being \$1,476,288 for the operation of the municipal railway of San Francisco.

The property owned by the water works of the 227 cities in 1918 was valued at \$1,205,377,311 . . . "

The increasing population served by sewerage works during the past decade is shown in the table below.

POPULATION TRIBUTARY TO SEWERAGE SYSTEMS

	1905	1915	1920
Population discharging raw sewage into the sea or tidal estuaries	6,500,000	8,500,000	
Population discharging raw sewage into inland stream or lakes	20,400,000	26,400,000	
Population connected to systems where sewerage is treated in some way	1,100,000	6,500,000	
Population connected with sewerage systems	28,000,000	41,800,000	46,500,000

The outlook for the future from the engineering standpoint is good. More than half of our population is located in cities, not all of which are served by a satisfactory water supply and fewer of which are satisfactorily seweraged, and existing public water supplies and sewerage works must be maintained.

The opportunity for the young man is bright in municipal work as the stages through the subordinate positions can be made short for a capable man in the right place because of the large demand for engineers trained or experienced in municipal work. Politics may sometimes affect the permanency of the city or state engineer's position, but he is no less secure than the engineer employed by corporations and other private interests which have their own political problems, and which are affected by periods of industrial depression or failure from which the municipal or state employee is independent. This situation is particularly appreciated during the present industrial depression.

## Geological Surveying

(Continued from Page 64)

geologist must first decide the requisite degree of accuracy, choose the most economical method for the job, and then continually use discretion in using his instruments.

Of recent years a certain amount of geological exploration has been done with the aid of airplanes. For instance Professor Bailey Willis recently traced an earthquake rift in California from an airplane, and members of the Geological Survey of Canada were transported to their field work at Fort Norman, far north of Edmonton, Alberta, by airplane. It is pretty safe to say that no very extensive use will be made of airplanes for real geological work, for the rather simple reason that it is generally unwise to attempt to name a rock without first breaking a piece from it with a hammer, a simple process to which airplanes are not readily adaptable. Automobiles are used very extensively, and gasoline or steam launches on the bigger bodies of water. Canoes are used all throughout the north country. In the mountains, pack trains, burros, and mules are the most dependable means of transportation, but in the mountains the difficulty of moving camp is more or less offset by the excellence of the rock exposures and the fine atmospheric conditions of visibility.

One peculiarity of geological work is the almost universal camp life. A man must be near his work in order to do it, and the best way to do it is to live right with it. In some cases a geologist goes into the field in June to spend three months with four or five other men, whom he has never seen and

of whom he has never heard, but whether he likes those men or not, he is there for three months or perhaps a great deal longer. If there is anything he doesn't like about these men, he has to learn to "lump it." He has to share his tent with some one else; he has to share a canoe or automobile with some one else; he has to carry a load with some one else; or he runs traverses with another individual. After a man has put in several seasons of this sort of experience, he learns to carry his own end. He learns to be tidy with his belongings, to put each thing in the particular place which he has learned to set for it. And although he may be camping every night

in a different spot, he will not under any circumstance forget to take his bed, or his jack knife, compass, watch, match safe, or his note book when he leaves in the morning, nor will he habitually try to pick out all of the light loads and let the other fellow carry the heavy ones. He will learn that it is not wise to insist on smoking in the camp a pipe which has long outgrown the limits of hygiene. All these things are good for a man. He learns to live contentedly for several months at a time with people he may not particularly like, to give and to take, to do his own work, and a bit of the other fellow's when necessary without growling.

## The Application and Maintenance of the Portable Electric Drill

(Continued from Page 75)

which means maximum cleanliness and minimum attention. It is good practice to replenish the grease supply as often as the tool is cleaned or inspected, which on account of the brush wear should not exceed 200 hours of service.

All reliable machines have ball bearing armatures. These armatures operate without load at from 10,000 to 18,000 RPM, and a poor bearing would mean destructive vibration. On the slow speed members, the compound gear shaft and chuck spindle and plain bronze bearings of ample size have given perfect service, but there is a tendency toward the use of ball bearings on these members as well. The danger in this move is in overloading through lack of room to use bearings of sufficient capacity. The thrust is an important item which must be taken up in a ball bearing of the direct thrust type or of the angular contact type capable of carrying both thrust and radial loads.

The armature is the delicate part of any motor of this type, and it is the first part to examine should the machine show signs of distress. Very often a motor is completely burned out through neglect of symptoms of trouble developing. If severe sparking appears at the armature the machine should be taken out of service at once and sent to a competent electrician for inspection. These motors are subject to the ordinary diseases of electric motors which may be detected in the usual way. Grounds may be detected with the magneto ringer, and if no ground is detected in the armature, the field switch and cable connections should be tested. An open circuit in the armature will be shown by burning between the commutator bars to which the open coil is connected. A short within a coil will burn out the shorted turns, and a short between commutator bars will overheat the bars so shorted. A case of short

between bars may sometimes be repaired if discovered before the coil is burned, by removing the foreign substance between the bars, but an open or shorted coil requires a re-wind. If the armature is built with open slots and form wound coils, the repair can often be made economically by the average repair man if he purchases the repair coil from the maker. If the armature is built with semi-closed slots it will probably be best to return it to the maker for a re-wind. The maker's guarantee of correct re-wind is quite valuable, hence it is strongly recommended that the maker be asked to make repairs.

The fields are not apt to fail, but occasionally they are burned out by operating the tool after the armature has failed. A shorted coil will cause over speed or flashing when the switch is closed. Re-winding the field coils is simple providing the coil is kept within the dimensions of the original and properly fastened into position. The best tools have windings treated with an impregnating varnish by an elaborate process, which is a very good reason why a re-wind by the maker is preferable. This feature is perhaps more important in the armature than in the field.

The gearing of the best machines seldom give trouble, but they are wearing parts and should be renewable with the least trouble and expense. The removable armature pinion is a very valuable feature since it permits renewal of this part without the cost of a new shaft and re-wind which is the case when the pinion is integral with the shaft. This objection is still worse when the commutator is built upon the shaft.

The cable connection is very often abused by using it to drag the tool around, running trucks over it, etc. Some cable is better than others but all of it requires reasonable consideration, and where the



tool is used in one position on production work it is recommended that the tool and cable be suspended from above with a counter weight. The machine is then always accessible and free from cable abuse. Some tools are provided with terminal screws at which a new cable can be attached without the aid of a soldering iron.

The weight of a portable electric drill is an important consideration, but the lightest tool may prove expensive to maintain. Weight is reduced by increasing the armature speed, by the use of aluminum housings, and by the use of the best steels properly treated. A radical armature speed will shorten the life of the tool, and the only assurance of proper design and material in the gear train is the reputation of the maker. It should also be borne in mind that the aluminum housings may be crushed by pounding or dropping the tool. To the reader such caution may be unnecessary but it is appalling what abuse some tools receive in this manner.

The portable electric drill as manufactured by the recognized leaders in the industry should not be classed with the vacuum cleaner and other domestic appliances. They are built to machine tool accuracy of the finest materials and distributed in a manner that gives the purchaser much more for his money than is possible in the aforesaid lines. They are built by mechanics for the use of mechanics; they are a practical, rugged machine that will save many hours in miscellaneous drilling operations and are indispensable in production where the drill must be taken to the work.

## De Pontibus

(Continued from Page 46)

souls. The situation of the city is most wild and picturesque. Perched upon a rocky promontory the city is bounded on three sides by the Tagus River in much the same fashion that the River Wear bounds the city of Durham. Toledo's promontory is of course far larger than that of Durham, the banks far more rocky and precipitous and the hill-sides almost treeless. The writer thinks the site of Toledo to be one of the most striking and unique that he has ever seen. The city is approached by only two bridges, the Puente Alcántara and the Puente San Martín. Both are Moorish structures said, to be sure, to have been built upon Roman foundations but each is unique and typical of Moorish bridge-building in general.

El Puente de Alcántara (derived from the Moorish *Al Kantara*-bridge) stands at the northeast corner of the city and it is across this bridge that one entering the city by railroad must pass. The railway station is on the side of the Tagus opposite

the town and the usual conveyance from the station to the hotel is a car drawn by four mules, sharp-shod, which climb the steep, narrow streets of Toledo with almost the agility of mountain goats. The streets are so narrow, hilly and crooked that nothing in the way of electric trains can possibly operate. The structure of the Alcántara is of Moorish origin and design, and although the present fabric seems to have been rebuilt in the time of Alfonso the learned (1258) with later repairs by Archbishop Ferdo Tenorio (1389), it preserves fairly truthfully the lines of the original Moorish bridge. It consists of one large semi-circular arch and a smaller one of the same character. A well designed pier on the town side provides look-outs and on the same end is a great Moeresque tower giving the bridge much of the military aspect that certainly characterized it in medieval days. Viewed almost any position this bridge makes a picture and it is not all strange that painters as well as pontists have praised it highly.

To the writer, however, the other bridge, El Puente de San Martín, is more beautiful and interesting. San Martín is far more robust in its proportions and if one were assigning genders, one would certainly call Alcántara feminine and San Martín masculine. San Martín has five pointed arches, one large one flanked by two smaller ones. One heavy pier on the town side carries look-outs while other look-outs, over the corresponding opposite pier, are suspended upon corbels. The bridge is protected at either end by embattled towers guarded to this day by officials who make it their business to inspect all comers and goers. The writer was allowed to photograph and measure freely, however, and came away enriched by his observation. The bridge dates from 1212, but in 1386 the great arch was destroyed. It was rebuilt in 1380 but the architect, according to a story told by George Edmund Street, was a careless man and perceiving that his work was unsound and would fall when the centering was removed, confided in his wife who forthwith set fire to the centering, the flames of which did their part in destroying the faulty work with the result that her husband had a chance to do the work over again. This time profiting by his experience, he built so well that the structure comes down to our day unimpaired. We should never have known the story had she not confessed to her priest. The bishop, it is said, did not put in a claim for fraud against the architect but on the contrary, having had much experience with human nature, congratulated the architect for possessing so brilliant a wife.

The bridges over the Tagus at Toledo should be thought of as military works, fortified bridges. They are rather refined to carry a full conviction as to their military power but their strategic positions

rather permit a more daring type of construction than would such a site as that occupied by the bridge over the Guadalquivir at Cordova. In this long, low-lying structure with its heavy merloned towers we have a bridge of military character. What a contrast between the bridge of Cordova and the Tower Bridge of London! The bridge is 730 feet long and has sixteen semi-circular arches carried on heavy piers. The bridge undoubtedly stands upon Roman foundations but is itself more Moorish than Roman. It was thoroughly renovated and repaired a few years ago, hence it presents a rather new appearance. The road to Seville begins at the tower end of the bridge and the bridge-way is constantly in use by burro pack-trains and cattle drivers bringing sheep, goats, and cattle into the city. The writer spent the larger part of a morning one hot August day this summer dodging the donkeys and goats while he prosecuted his studies in the fog of dust that the beasts kicked up.

The fragmentary, foregoing remarks, then, are merely some of the impressions and data gained by a pontist upon a summer's holiday. There is freedom out on the highway and one senses the joy of the explorer in following the open road. If that road lead eventually to an interesting old bridge what a repayment for one's exertion! The search for historic and beautiful bridges is as pleasant a pastime as stargazing or fishing and from the writer's point of view a deal more profitable. The Roman arch and the bridge hold a significance and symbolism that should supply one of philosophic turn of mind all he needs in the way of material for speculation and, to the writer, part of the joy in the contemplation of a successful bridge lies in the way it triumphs over nature. Like beautiful buildings, the more one studies beautiful bridges, the more he loves them. There is a pot o' gold at the base of the Roman arch!

---

## Factors Necessary for Engineering Success

(Continued from Page 52)

secured employment on the spot. He was employed to make a canoe trip of 1500 miles on a Canadian river in company with a British engineer, to investigate the possibilities of hydro-electric power and industrial development. He made the trip and submitted a report which was liked so well that it was sent to London without dotting an i or crossing a t; and what is more, the firm liked the report and the man so well that it immediately put him in charge of all of its interests in one of the great states of the Middle-West—electric railways, elec-

tric-light plants, gas works, water works and what not.

Shortly after getting the second appointment the young man wrote to me and said, "Unquestionably the report got me this position; and I feel that I owe the report to the drubbings you gave me about my English. Any way, I wrote a report that was liked, and now I ride in Pullmans, stop at the best hotels, and am in a position to tell a good many engineers what to do."

The young man gave all the credit to his report, but let us see. Evidently in the first place he had breadth of knowledge for he knew to whom to apply for a job, and unquestionably he selected the best firm in New York City for the object he had in mind. In the second place, he certainly had a pleasing personality, good manners, and good English, qualities which must be cultivated and which can not be assumed when needed. He had not pursued electrical engineering, nor had he had any experience in hydro-electric power development, and he had no acquaintance with Canadian rivers or Canadian industrial conditions; but some how he was selected for the job. Doubtless during the interview he convinced the banker that he was a man of initiative, self-reliance, energy, and breadth of view. The report which he wrote evidently showed the bankers that the young man had the ability to observe closely, analyze correctly and state clearly. Further, the banker doubtless thought the qualities the young man showed in the interview and in the report would make him a useful employee in his present position. Clearly he was employed in both positions because of his intellectual ability and personal qualities rather than because of any technical facts he had in his note book or on the tip of his tongue. In short, he was employed because during his college course while studying engineering he had developed his intellectual powers and acquired at least some of the main non-technical factors necessary for the largest engineering success; and I doubt not that the greatest of these factors was his ability to use clear, forceful English in common conversation and in a formal written report. But finally let me remind you that this ability can not be acquired except by the development of one's intellectual powers to a high degree. In other words, the language one uses is a sure index of the quality of his education.

In conclusion then, I beg each of you to take an inventory of the methods you have been using, and of the ideals you have been pursuing; and if you find they do not conform to the newer ideals of the engineering profession, I beg that you read-just them, and intelligently and earnestly do your part to prepare yourself for the largest engineering success.



### Character Sketches

The Teahound—"I had a stirring time yesterday."

The Juryman—"It surely has been a trying day."

The Cigar-counter Girl—"I know the ropes, kid."

The artificial arm—"I feel you, son."

The Postal Clerk returning to work after his vacation—"Back to the old stamping ground again."

The Cannibal, carving.—"Here's where I get the best of him."

"There is a divinity that shapes our ends rough-hewn them though she may," said the stude to the manicurist.

"My sweetie," said Heloise the snappy waitress in the Rapid Fire restaurant as she fondly patted the sugar bowl on the head.

"Tee-hounds," said the tramp as he gazed at the golfers.

Question number 258. How is mineral wool taken from a hydraulic ram?

While visiting a plant on the recent inspection trip, one of the seniors approached a rather attractive workress and became interested in her or her work. Well anyway, "Get away kid, the boss might come," was her reply.

Taking aspirin pills won't get you through the course.

"Father, tell me a story before I go to bed, wont you?"

"Well son, the scene is in the catacombs of Paris. Imagine the picture if you can. The corpses are dancing lightly from tomb to tomb—"

I waited patiently and expectantly. My pulses were beating like tiny trip hammers. Surely she would not refuse me. My line had been working fine before this. It could not fail me this time. I could not see her yet I knew that she must be there. Fifteen minutes of silence.— Would she never—at last— "Number please."

"This cuts me dreadfully," said the stude as he overslept three classes.

"Do you know Poe's Raven?"

"No, is he?"

Biblical student to co-ed, "What are you doing about this new missionary movement?"

Coed, "I don't care for them new ideas in dancing, too much activity I calls it."

Extract from Hloye's cardoflynamics:

"Upon the passing of openers by all gamblers there should be N plus one chips on the green. As a general rule the following formula might be deduced.

$$C_x = P(n + 1)$$

where C denotes the number of chips at value x and P the number of times openers have been passed up. The proof is left to the student."

### Books Worth Reading

"Mastering English," by Balk Lyne, or "Billiards, the Science and Pastime."

"The Ride of Paul Beware," or "From Boxcar to Jail," by Urban E. Koppe.

"Danny's Inferno," written by himself. The story of a lads struggle against the demon Calculus.

"Green Street," by Loney Teykarre. A lovely romance woven in with the descriptions of the quaint old folk who frequented this historic old street.

## The Ocean Magnetic Work of the Carnegie Institute

(Continued from Page 48)

Deflector is being used for determining the magnetic declination. Simultaneously observations are being made on the marine collimator located on the navigation bridge.

The second instrument for these declination observations is the deflector compass used as the ordinary azimuth device. Here the direction of the Sun is read directly with reference to the compass. However, the observations are not as reliable as those made with the collimating compass. Also a bright Sun is required with the deflector, so that observations are often obtained on only the collimating compass.

The navigational work on the "Carnegie" is also of importance, as it is necessary to know the position to which the magnetic observations apply as accurately as is consistent with the accuracy of the magnetic observations, and also the position is required in computing the magnetic declination observations. In this work, again care is taken to avoid constant personal instrumental errors by duplicate observations for altitudes of heavenly bodies. Time for the determination of longitude, is carried on six chronometers, the time adopted being the mean of all. In even the longest trips at sea, time is carried within the limits of error allowable.

Work in atmospheric electricity is also being regularly performed, especial attention being paid to the diurnal variation in the potential gradient and conductivity of the atmosphere by continuous observations during a period of 24 hours once a week. In addition, a daily program is carried out to determine these values, as also the radioactive content of the atmosphere, the ionic content, and the penetrating radiation.

The potential gradient is a measure of the change in potential vertically. The ionic content apparatus determines the number of positive or negative ions in the air, per cubic centimeter, for example. The radioactivity apparatus measures the amount of radioactive substances in the air. These electric phenomena are connected closely with the magnetic phenomena of the Earth and are necessary for an exhaustive investigation such as is being carried out by the Carnegie Institution of Washington on this subject.

Thus the large amount of data collected by improved methods for ocean magnetic work greatly increases the accuracy of our knowledge of the distribution of the Earth's field. Also these data give an extensive basis for investigational work, especially since at the same time experimental work is

being carried out in a specially constructed magnetic laboratory.

The observations obtained on the "Carnegie" are furnished promptly to the various governments of the world for use as a basis for the magnetic data on their navigational charts and also for the specially prepared magnetic charts, one set of which shows the horizontal intensity, another set the dip, and a third set gives the variation of the compass, as the magnetic declination is usually termed by mariners, for all the ocean areas.

The work to date of the "Carnegie" gives a very comprehensive general survey of the ocean areas. Also a great deal of attention is given to obtaining the change of the magnetic elements over a period of years by securing frequent intersections with tracks of previous cruises of the "Carnegie."

---

### Character Sketches

My heart leaps up when I behold  
A coed on the street;  
So 'twas when I first here came,  
But now I am a senior, cold, discreet.  
I understand their little game  
They want to dance, hunch and see the show.  
I see it all, I'm not so slow.

When I'm broke and low on coin  
And haven't had much of the old sirloin,  
I laugh from aloof, when I see a poor goof  
Trotting fair lady to dine.  
But when I am flush  
And got lots of cush—  
Well, I guess I have to admit  
That even a senior sometimes gets hit.

I can not write my reports,  
My looks frown out in despair  
I simply loaf around the place—  
I hardly seem to care.  
Do you wonder that I roam?  
My roomie's gone to the Orph  
And left me all alone.

---

### Once-Overs

(Ag One). "Have you heard the stock yards anthem?"

(Ag Two). "Can't say that I have."

(Ag One). "The words aren't much but the air—  
—Oh boy!"

	MON.	TUES.	WED.	THURS.	FRI.
7 P.M.		DINNER	K.I.T.		JOE'S
8 P.M.	DANCE (R.O.)	SHOW		STAG	
9 P.M.			SMOKER		
10 P.M.					
11 P.M.		JOE'S			

## Does your P. M. schedule read like this?

If your burning ambition is to excel as an all-around society man, you couldn't have planned your evenings better. Such persistence will win out over the indolence of the rank and file, for as the poet says,

"The heights by great men reached and kept  
Were not attained by sudden flight,  
But they while their companions slept  
Were toiling upward in the night."

But if you intend to make your mark in engineering or business, don't expect that supremacy on the waxed floor will help when you start hunting a job.

Not that you need swing to the other extreme as a "grind" or a hermit. Let's concede it is all right to minor in sociabilities—but certainly it is only common sense to major in the math and sciences and English that will mean bread and butter to you later on.

Remember this—the harder you work right now in getting a grip on fundamentals, the easier things will come to you when you must solve still bigger problems. And if you take it easy now—well, look out for the law of compensation.

It's up to you. While you've got the chance, seize it, dig in, plug hard. It will pay—in cold cash.

*Published in  
the interest of Elec-  
trical Development by  
an Institution that will  
be helped by what-  
ever helps the  
Industry.*

## *Western Electric Company*

*Maybe it's against all campus tradition, but some men who stood in the upper third in their class and who entered this Company years ago have since become its executives.*

## Modern Street Railway Operation

(Continued from Page 57)

traffic, raised platforms will provide a safe approach to street cars. These platforms, which are from 6 to 8 inches high, two car lengths long, and about 4 feet wide, provide a safe place to stand while waiting for a car and speed up the loading, because of the short step to the car platform.

In congested districts much time is consumed by interference from other cars at street intersections. The practice of turning cars back in the business district by looping them increases the interference because of the large number of turns then necessary. The aim, generally, should be to reduce as far as possible the amount of interference by rerouting and by using, wherever possible, the relatively faster right hand turn. The movement of cars in both directions on any one street should be about equal, in order that full use can be made of the elapsed time between the traffic signals. Re-routing should also be carried out with a view to serving the people. In this connection it might be said that the cooperation of city authorities by limiting parking areas for automobiles will help, generally, in relieving congestion.

## *It Takes Manufacturing Experience*

to judge material, workmanship  
and

### Construction

The Riders have been

### Penmakers

for two

### Generations

and sell only the best in

### Pens, Pencils

and accessories

The latest in folding, portable  
typewriters

## Rider's Pen Shop

MOVED TO 612 EAST GREEN ST.

*"Rider for Pens"*



## Typewriters For Rent

ANY MAKE MACHINE

\$3.00 Per Month

\$8.00 for 3 Months

Rent will apply on purchase price  
if you wish to buy

**R. C. White & Company**

612 E. Green - Main 922

*"Royal-Corona Agency"*

Furnishings and Tailored Clothes

of the Latest Sort at

## MARSHALL'S SHOP

FOR MEN

BRADLEY ARCADE



## You Have Protection

Even if the roof leaks or the wheel pit is flooded, Watershed Tannate is ready to go right on with its work. And it will save repairs also under ordinary conditions, because Tannate leather is so tough and the waterproofing keeps it in such good condition.

It can also save take-ups because it is so well stretched and because its flexibility

and grip permit a looser drive. This in turn saves strain on the belts and bearings and requires less oil and oiling.

And by using Tannate lace, where belts are not made endless, you will have a genuine long service combination. For Tannate Lace leather often outlasts rawhide from three to five times.

### Belt Users' Book Free

*Our little "Belt Users' Book" is made to help you get the most from your belts. Let us send you a copy gratis. Many Technical School students find it helpful.*

## J. E. RHOADS & SONS

PHILADELPHIA  
14 N. Third St.

NEW YORK  
144 Beekman St.

CHICAGO  
314 W. Randolph St.

Factory and Tannery: WILMINGTON, DEL.

## Our Toasted Sandwiches—

THEY SATISFY

An individual jar of Richelieu Jam and Toast. Just the thing for breakfast.

### Prehn and Henningsen

Home of Crane's Chocolates

## Inventory Clean-up

NOW IS AN EXCELLENT TIME TO BUY NEW STATIONERY. WE HAVE AN EXCELLENT LINE FOR YOU TO CHOOSE FROM.

How About An Illinois Memory Book?

**Strauch's**  
Art and Gift Shop

## EVERSHARP

*The name is on the pencil*



The pencil with the rifled tip. Lead is held firmly by the tip and is finely grooved as it passes through.

*The grip of the tip will not slip.*

Get your EVERSHARP from our complete stock today. Made in many styles and sizes. *Your* EVERSHARP is here.

A price for every purse.  
50c to \$65.00.

Sold by

**STUDENT SUPPLY STORE**  
Service — Savings — Satisfaction

606 E. Green St.

Chuck Bailey—Managers—Shelby Himes

## INMAN HOTEL

G. W. Byers and August Danielson  
Proprietors

FIREPROOF  
MODERN



A Home for Students and Their  
Friends when in Champaign

WHOLESALE CONFECTIONS

UNIVERSITY CANDY  
COMPANY

117 North Market Street

Eat at

## DUSTY'S PLACE

We make our own pastries

806 S. Fourth St.



# Jos. Kuhn & Co.

Hart Schaffner & Marx Clothes for Men Who Dress With Care

Champaign, Illinois

## The Name Johns-Manville and What It Stands For

A college is always proud of its name because it stands for honorable traditions, achievements, and ideals.

Johns-Manville too is proud of its name and what it stands for.

Johns-Manville symbolizes the highest ideals in the manufacture and scientific application of asbestos products.

Johns-Manville stands for progress and improvement in service to industry and the individual through asbestos packings that reduce friction—asbes os insulations that save heat—through asbestos roofings that check conflagrations and reduce fire losses—a service that is consecrated to making life safer and more complete; to greater production with less waste through the remarkable durability and fire resistance of asbestos.

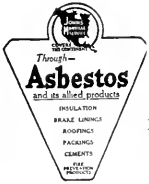

## Johns-Manville

INCORPORATED

Executive Offices—New York  
Michigan Avenue and 18th Street  
Chicago, Ill.

Branches in 60 large cities



## You Can Benefit

by our policy of reasonable prices, service and satisfaction. Many have profited by it, and are using our

**Drawing Materials  
Surveying Instruments  
Measuring Tapes**

Buy the DIETZGEN product and obtain the quality and merit which has caused our goods to be accepted as the STANDARD.

Catalog on Request

## EUGENE DIETZGEN CO.

Chicago      New Orleans      Philadelphia  
 Branches:      New York      San Francisco  
 Sales Offices:      Pittsburgh      Washington

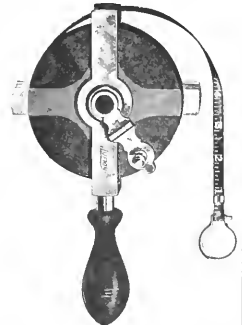
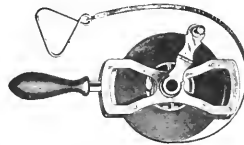
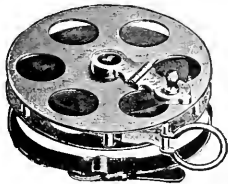

## LUFKIN TAPES

ALL STYLES

Longest, Most Satisfactory Service

Send for Catalogue **THE LUFKIN RULE CO.** Saginaw, Mich.  
New York, London, Eng. Windsor, Ont.

**THE FACT**

*that a K & E is the Slide Rule or Drawing Instrument selected by those who, through their knowledge, may justly be termed experts, is but added evidence of K & E superiority.*

*Drawing Instruments  
Surveying Instruments  
Measuring Tapes*

**Keuffel & Esser Co. of N. Y.**  
520 South Dearborn Street  
CHICAGO

**Equipment for the Power Plant**

Allis-Chalmers engineering corporation has more than sixty years devoted to the design and building of heavy machinery for many varied engineering and power purposes.

For the power plant, complete equipment "from prime mover to switchboard" is built by the Allis-Chalmers organization. This includes all types of prime movers—steam turbines, hydraulic turbines, steam, gas and oil engines together with complete electrical equipment. Condensers of all types, pumps, air compressors and many other auxiliaries are also supplied. Allis-Chalmers equipment is used in plants of all sizes, and includes some of the largest power units ever built.

With the complete equipment built by one organization under a single supervision, the many details, complications and delays incident to divided responsibility are avoided.

Consult Allis-Chalmers engineers regarding individual apparatus or complete equipment.

**ALLIS CHALMERS PRODUCTS**



- |                      |                        |
|----------------------|------------------------|
| Air Brakes           | Metallogical Machinery |
| Air Compressors      | Mining Machinery       |
| Cement Machinery     | Oil Engines            |
| Condensers           | Perforated Metals      |
| Crushing Machinery   | Pumping Machinery      |
| Electrical Machinery | Reciprocating Pumps    |
| Electric Hoists      | Saw Mill Machinery     |
| Farm Tractors        | Steam Engines          |
| Flour Mill Machinery | Steam Hoists           |
| Forgings             | Steam Turbines         |
| Gas Engines          | Timber Treating and    |
| Hydraulic Turbines   | Preserving Machinery   |

**ALLIS-CHALMERS**  
MILWAUKEE, WIS. U. S. A.

**Horton Tanks For Every Purpose**



- Acid Tanks
- Ash Tanks
- Gas Holders
- Steel Bins
- Penstocks
- Surge Tanks
- Agitators
- Oil Storage Tanks
- Pulp Tanks
- Locomotive Storage Tanks
- Stills
- Chill Tanks
- Molasses Storage Tanks
- Stacks
- Breechings

**Chicago Bridge and Iron Works**

Founded by Horace E. Horton in 1867  
Chicago, New York, Atlanta, Dallas, San Francisco  
In Canada, Horton Steel Works Ltd.

**Chicago Steel Tape Company**

6231 Cottage Grove Ave., Chicago, Ill.



Manufacturers—Surveying Implements, Tapes, Leveling Rods, Self-Computing Rods, Stadia Rods, Rod Ribbons, Targets, Marking Pins, Lining Poles, Eureka Tape Repairers, Etc., Etc.,

**INDUSTRIAL BUILDINGS SHOULD BE WELL  
LIGHTED.**

From the employer's viewpoint, the big difference between men who work out of doors and those who perform tasks inside the building, is the factor of light. Daylight furnishes sufficient illumination outside during the daytime working hours for men to pursue their tasks efficiently and safely. But the proposition of getting enough daylight into the interior of industrial buildings, requires some thought.

It is not a difficult problem by any means, and any employer can take advantage of daylight and utilize it for lighting his building during the daytime, if he desires. It is an excellent light, especially suitable for the eyes, reducing eye strain and eye weariness to a minimum, and has the great economic advantage of costing nothing.

To utilize daylight to the utmost, we must first provide means for allowing daylight rays to enter the interior of buildings in sufficient quantity—namely, proper and adequate windows and skylights. Many excellent instances of buildings designed with a due regard to the importance of daylight lighting can now be seen in many of our industrial cities. Such buildings present the appearance of being practically all windows—"window walled," as they are termed—and this type of daylight construction is coming rapidly into favor, because it constitutes a more healthy building for large numbers of employes, both from the lighting and ventilation standpoints.

Among those who have constructed this type of modern industrial building may be mentioned: The Shredded Wheat Co., Gillette Safety Razor Co., Lyon & Healy Piano Co., H. J. Heinz Co., Corona Typewriter Co., Skinners Macaroni Co., Grape Juice Co., Dodge Bros., Nelson Valve Co., Piston Ring Co., Remington Arms Co., and a great many others.

The Larkin Co., Philadelphia, has erected a building almost entirely glass, 85% being windows, and the Loomis Breaker, operated by the D. L. & W. R. R. Co., Nanticoke, Pa., is literally a glass house, being 93.5% of glass. The new buildings of the Winchester Repeating Arms Co. have an average glass area of 58%.

An investigation covering 18 buildings constructed by the Aberthaw Const. Co., Boston, shows that the average window area is 57.5%.

These figures indicate how important the subject of lighting is now considered by employers of industrial labor, and how well the idea has been carried out by the architects and engineers, in order that all parts of a building may receive sufficient daylight. But, in addition to providing ample window space, there is another factor which is equally important, and that is, equipping the windows with the proper glass.

The bright direct rays of the sun should not be permitted to strike the eye, and we must provide a means for reducing the glare to rays which will not be too bright. This is accomplished by glass especially manufactured for industrial windows, known as Factrolite. This glass possesses the property of breaking up the intense rays of the sun and diffusing the light into the interior of the building in proper portions, solving the problem of sun glare.

If you are interested in the distribution of light through Factrolite, we will send you a copy of Laboratory Report—"Factrolited."

**MISSISSIPPI WIRE GLASS CO.,**

220 Fifth Avenue,

St. Louis.

New York.

Chicago.

No. 4.

# VENUS PENCILS

*The largest selling quality  
pencil in the world.*

**Engineers everywhere use the perfect  
VENUS knowing that none other gives  
the same supreme service and satisfaction**

With VENUS the fine, clean lines of working drawings are put in with ease and accuracy; the shadows and high lights of sketches take form with amazing results.

The exactness and uniformity of VENUS grading is your safeguard; it insures pencil efficiency and pencil comfort.

## 17 Black Degrees—3 Copying

For bold heavy lines - 6B-5B-4B-3B  
For writing & sketching - 2B-B-1B-F-11  
For clean fine lines - 2H-3H-4H-5H-6H  
For delicate thin lines - 7H-8H-9H

Plain ends, per doz. \$1.00  
Rubber ends, per doz. 1.20

*At stationers and stores  
throughout the world*

**American Lead  
Pencil Co.**  
218 Fifth Ave.  
New York  
Dept. M 62



*The world's most  
famous pencil*

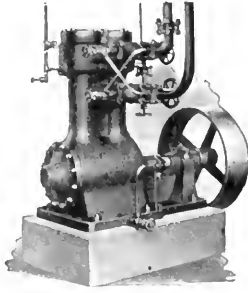

Established 1867

# The Vilter Manufacturing Co.

1029 Clinton St., Milwaukee, Wis.

Ice Making and Refrigerating Machinery  
Corliss and Poppet Valve Engines

Branch offices in all principal cities

*If interested write for bulletins*

## Immediate Delivery

We are now able to ship promptly on receipt of order, a full line of:

- Drawing Instruments
- Drawing Boards
- Triangles and Tee Squares
- Surveying Instruments
- Tapes and Chains
- Cross Section Papers
- Tracing Cloth and Papers
- Scales, Etc.

These goods are all in stock. Quotations gladly given. Write for illustrated catalogue, literature and very attractive prices on various grades of drawing instrument sets.

**New York Blue Print Paper Co.**

102 Reade Street New York City



## WESTERN BRICK COMPANY

Manufacturers of  
Artistic Facing Brick  
Hollow Building Tile  
and Common Brick

DANVILLE, ILLINOIS

Steel Cased Setting  
Increase Efficiency

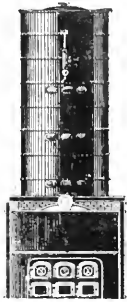

## Wickes Vertical Water Tube Boiler

Have you seen the STEEL CASED SETTING for enclosing this boiler? Air infiltration losses are overcome. The highest possible thermal efficiency results.

Ask for bulletin—Magnitude and Prevention of Air Infiltration Losses—sent free.

Ever cleaned a boiler, lamed your back, bruised your knees and skinned your elbows doing it? Two men can open, wash, close and fill the WICKES in five hours. Turbin in ten hours

Ask for Bulletin—Reducing Costs on the Boiler Room—sent free

**The Wickes Boiler Company**  
SAGINAW, MICHIGAN

SALES OFFICES

New York City, 1216 West St., Bldg.  
Chicago, 76 West Monroe St.  
Boston, 201 Devonshire St.

Pittsburg, 1218 Empire Bldg.  
Detroit, 1116 Penrose Bldg.  
Seattle, 736 Henry Bldg.

Man Stands erect Cleaning

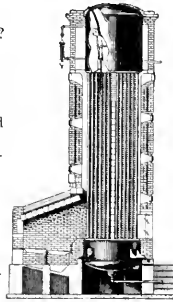

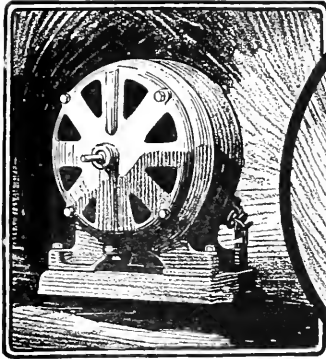

1888

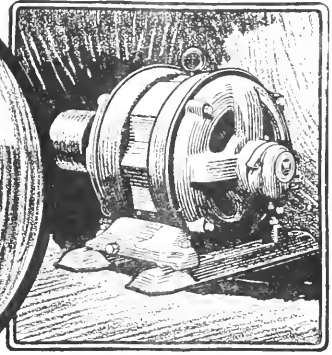
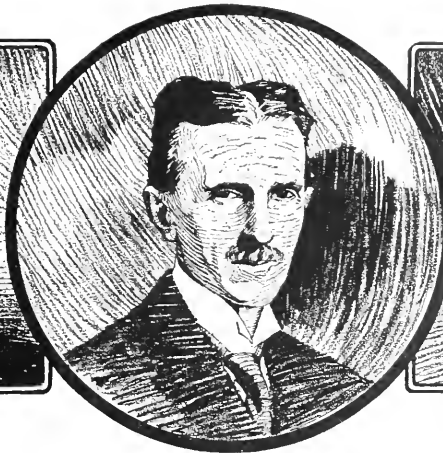

1921

## Nikola Tesla

**T**HE NAME of Nikola Tesla will always be associated with the invention and earlier developments of the induction motor. In fact, at one time this type of apparatus was known almost exclusively as the "Tesla" motor.

Tesla devised this motor back near the beginnings of the electrical business, when practically everything was built by "cut and try" methods, and none of the accurate analytical processes of later days had been developed. It may be said broadly that Tesla knew two fundamental facts—first, that if a magnet were moved across a sheet of conducting metal, it would tend to drag this metal along; and,—second, that the effects of such a moving magnet could be produced by suitably disposed polyphase currents acting on a *stationary* magnetic structure.

Perhaps others, at that time, also knew these two facts, but if so, apparently they knew them only as two isolated facts. Tesla considered them *in combination* and the result was the Tesla motor, or what is now known broadly as the "induction motor." These two facts, in combination, represent a fundamental conception, and all of the many millions of horsepower of induction motors in use today throughout the world, are based upon these two fundamentals.

Naturally, Westinghouse, having fought single handed to advance the alternating current system, was supremely interested in the new type of motor. What if the new motor did require

polyphase circuits, while all existing circuits were single phase? What if it did require lower frequency than any existing commercial circuits? These were merely details of the future universal alternating system. The important thing was to obtain an ideally simple type of alternating current motor, which Tesla's invention offered. Tesla furnished the fundamental idea.

He and his associates, working for Mr. Westinghouse, proved that thoroughly operative induction motors could be built, provided suitable frequencies and phases were available. What matter if they did not produce an operative commercial system at the time? What matter if it needed the powerful analytical engineers of later date to bring the system to a truly practicable stage—men with intimate constructive knowledge of magnetic circuits—men on intimate terms with reactive coefficients and other magnetic attributes totally unknown to Tesla and his co-workers? In time the motor was made commercial, and it has been a tremendous factor in revolutionizing the electrical industry.

Probably no one electrical device has had more high-power analytical and mathematical ability expended upon it than the induction motor. The practical result has been one of the simplest and most effective types of power machinery in use today. Thus Tesla's fundamental ideas and Westinghouse's foresight have led to an enormous advance in the world's development.

---

# Westinghouse

---



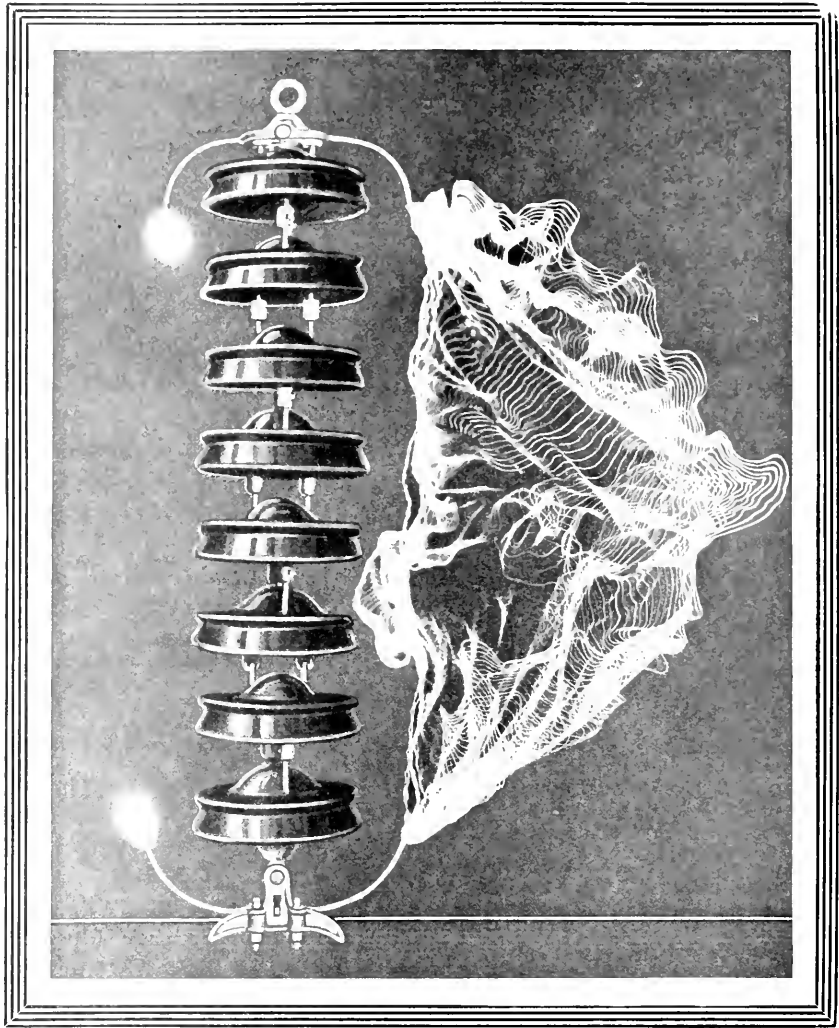

— enduring the Power Arc

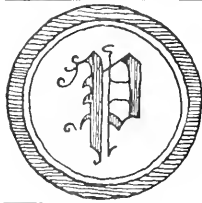

PERHAPS THE MOST TALKED OF AND PHENOMENAL FEATURE OF THE Thomas LINK-TYPE Insulator IS THE **CLEAN FLASH-OVER**. ENGINEERS REALIZE THE NECESSITY FOR KEEPING THE ARC "clear of the string" AND ARE RAPIDLY FOCUSING THEIR ATTENTION ON THIS ONE UNIT which furnishes all the principles of their Insulator Ideals

THE R. THOMAS & SONS COMPANY  
EAST LIVERPOOL, OHIO

Thomas Link Type Insulators

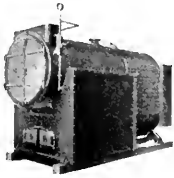

The "Economic"

# The Erie City Iron Works

Erie, Penn., U. S. A.



Vertical Water Tube

Manufacturers of

## Steam Engines, Steam Boilers, Tanks, Steel Plate Construction

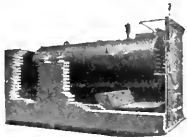

Return Tubular Stationary

## "The Big Four" of Boilerdom

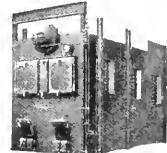

Horizontal Water Tube

### INDEX TO ADVERTISERS

Allis-Chalmers Mfg. Co. ....	VIII	Mississippi Wire Glass Co. ....	IX
American Lead Pencil Co. ....	IX	New York Blue Print Paper Co. ....	X
Chicago Bridge & Iron Works ....	VIII	Otis Elevator Co. ....	Inside Back Cover
Chicago Steel Tape Co. ....	VIII	Prehn & Henningsen ....	VI
Dusty's Restaurant ....	VI	Rhodes, J. E. & Sons ....	V
Engineers' Co-operative Store ....	II	Rider Pen Shop ....	IV
Erie City Iron Works ....	XIII	Stockham Pipe & Fittings Co. ....	Inside Front Cover
Eugene Dietzgen Co. ....	VII	Student Supply Store ....	VI
General Electric Co. ....	Outside Back Cover	Strauch's Art Shop ....	VI
Grubb, G. R., & Co. ....	IV	R. Thomas & Sons Co. ....	XII
Inman Hotel ....	VI	Tite Wad's Restaurant ....	I
Johns-Manville, H. W., & Co. ....	VII	Vilter Mfg. Co. ....	X
Keuffel & Esser Co. ....	VIII	Western Brick Co. ....	X
Koehring Machine Co. ....	XIV	Western Electric & Mfg. Co. ....	III
Kuhn, Jos., & Co. ....	VII	Westinghouse Electric Co. ....	XI
Lewis, W., & Co. ....	I	White R. C. ....	IV
Lufkin Rule Co. ....	VII	Wickes Boiler Co. ....	X
Marshall, Fred ....	IV	University Candy Co. ....	VI
		U of I Supply Store ....	I



**I**N the construction of modern highways, time-saving machinery has taken the place of the huge armies of artisans which, by brute strength accomplished the road-building of the Egyptians and Romans.

The nerve center from which modern highway building radiates is the concrete mixer. Without it, the present wonderfully developed system of paved roads would be only a chimerical dream.

The concrete mixer has made possible the economical building of culverts, the rapid construction of bridges and approaches, the placing of concrete foundation for brick and other two-course pavements, and—probably its greatest achievement of all—the construction of the thousands of miles of smooth, hard and enduring concrete roads reaching across all sections of the land.

There is a particular type of concrete mixer for each of these phases of road engineering.

Culvert construction demands very much different equipment from paving construction. An average culvert requires the mixing of only a few cubic yards of concrete. Wherever, along the road to be paved, a cross ditch or sharp hollow happens to lie, there a culvert must be built.

To meet these conditions the Koehring Dandy Light Mixer is used. It is sturdy and substantial, yet light in weight and easily portable from culvert to culvert in quick time by truck or team.

The Dandy's quick mobility arises in part from its small size; its capacity of 4 and 7 cubic feet of mixed concrete are just right for the well planned culvert project.

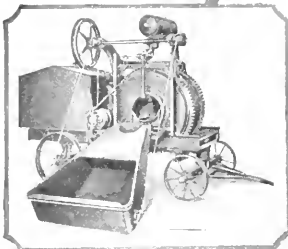

## KOEHRING COMPANY

*Manufacturers of Concrete Mixers and Locomotive Cranes*

MILWAUKEE, WISCONSIN

# KOEHRING





The WORLD'S WORD for  
ELEVATOR SAFETY



The WORLD'S WORD for  
ELEVATOR SAFETY

## THE KREMLIN, MOSCOW

*Most of the famous buildings of the world  
are equipped with Otis Elevators*

**T**HE KREMLIN is the citadel of Moscow. The walls of the triangular enclosure were built in the year that Columbus discovered America. Much of the history of Russia—a dark tale of intrigue, mystery and bloodshed—was enacted in the Kremlin buildings. The present Great Palace dates back only to Napoleon's day, for his soldiers burned the old palace. There are two Otis Automatic Push Button Elevators in the Great Palace. There is another Otis Elevator in the Nicholas Palace.

This is significant of the world-wide scope of Otis activities. From the first crude hydraulic elevators to the modern miracle of automatic vertical transportation, Otis has led the way and even now is continually developing new and better methods and machinery.

OTIS ELEVATOR COMPANY  
Offices in all Principal Cities of the World



*Hittord or Crookes Tube*

## How Were X-Rays Discovered?

SIR James Mackenzie Davidson visited Professor Roentgen to find out how he discovered the X rays.

Roentgen had covered a vacuum tube, called a Hittord or Crookes tube, with black paper so as to cut off all its light. About four yards away was a piece of cardboard coated with a fluorescent compound. He turned on the current in the tube. The cardboard glowed brightly.

Sir James asked him: "What did you think?"

"I didn't think, I investigated," said Roentgen. He wanted to know what made the cardboard glow. Only planned experiments could give the answer. We all know the practical result. Thousands of lives are saved by surgeons who use the X-rays.

Later on, one of the scientists in the Research Laboratory of the General Electric Company became interested in a certain phenomenon sometimes observed in incandescent lamps. Others had observed it, but he, like Roentgen, investigated. The result was the discovery of new laws governing electrical conduction in high vacuum.

Another scientist in the same laboratory saw that on the basis of those new laws he could build a new tube for producing X-rays more effectively. This was the Coolidge X-ray tube which marked the greatest advance in the X-ray art since the original discovery by Roentgen.

Thus, scientific investigation of a strange phenomenon led to the discovery of a new art, and scientific investigation of another strange phenomenon led to the greatest improvement in that art.

It is for such reasons that the Research Laboratories of the General Electric Company are continually investigating, continually exploring the unknown. It is new knowledge that is sought. But practical results follow in an endless stream, and in many unexpected ways.

**General Electric**  
General Office **Company** Schenectady, N. Y.

# THE TECHNOGRAPH

PUBLISHED QUARTERLY BY THE STUDENTS OF THE  
COLLEGE OF ENGINEERING UNIVERSITY OF ILLINOIS



FEBRUARY

1922

FOUNDED EIGHTEEN HUNDRED AND EIGHTY FIVE  
VOL XXXIV                      PRICE 40 CENTS                      NUMBER III

**S**  
FITTINGS

—for Steam, Water,  
Gas or Air Piping



**STANDARD and EXTRA HEAVY SCREWED FITTINGS**

Meet all essential requirements for strength,  
accuracy and finish

.....  
Engineering Students are Welcome to a Copy of Our Catalog  
.....

**STOCKHAM PIPE & FITTINGS Co.**

GENERAL OFFICE AND FACTORY BIRMINGHAM

Bush Terminal, New York

Distributing Warehouses

36th and Iron Streets, Chicago



CAFETERIA

610 E. Green St.

### All Makes of Typewriters For Rent

\$3.00 Per Month

\$8.00 for 3 Months. Rental Allowed on  
Purchase Price if You Wish to Buy

**R. C. WHITE & CO.**

612 E. Green St. Main 922

*"Royal-Corona Agency"*

## U. of I. SUPPLY STORE—On the Square

The manufacturers have reduced their prices on some items, and in accordance with our usual policy, we pass the saving along at once to our customers.

### Important Revision of Prices on Instruments and Slide Rules

We carry the largest line of instruments, materials, and supplies for Engineers, Architects, and Artists in the State outside of Chicago. Our salesmen are experienced and all our knowledge and experience is at your service, whether you want an eraser or a set of instruments or a wireless outfit.

## U. of I. Supply Store

ON THE SQUARE

### RELIABLE FURNITURE CO.

101 E. University Avenue  
CHAMPAIGN, ILL.

### Wright Sweet Shop

The House for Quality

THE MALTEDS AND  
BOSTONS ARE  
EXCELLENT

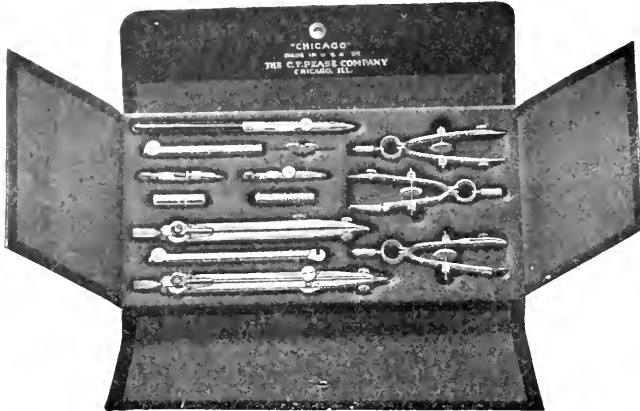

## Pease American Made Drawing Instruments are Perfectly Balanced

They are manufactured with that careful degree of skill so necessary in high grade drawing instruments. Pease instruments are unsurpassed by any other line of drawing instruments, either foreign or domestic, in accuracy, quality, workmanship and finish.

### Parts Interchangeable

Pease Chicago Drawing Instruments are so manufactured, their standards so maintained, that any part of any instrument is interchangeable with the like part of any similar instrument. Months or years may intervene between the time of manufacture, but each part will be an exact duplicate of every other part like it.

# Engineers ----

Buy Better Quality for Less  
at Your Own Store

Come in and look over our complete line of Typewriting Papers, Crane's Stationery, and Illinois Seal Stationery.

**ENGINEERS' CO-OPERATIVE SOCIETY**

J. R. LINDLEY, Mgr.

Boneyard and Mathews

Urbana, Illinois

# The TECHNOGRAPH

UNIVERSITY OF ILLINOIS

*Member of Engineering College Magazines Associated*

## *Contents for February*

ARTHUR J. INGOLD, JR. . . . .	Frontispiece
THE ELECTRIC PROPULSION OF SHIPS . . . . . W. J. Behrens	93
ALONG THE OLD SPANISH TRAIL . . . . . Prentice Duell	98
A RECENT BOILER DEVELOPMENT . . . . . K. C. Brown	101
THE SHORT COURSE IN HIGHWAY ENGINEERING . . . . .	103
THE ENGINEERING COUNCIL . . . . . H. D. Rosendale	104
TOLERANCE SYSTEMS IN INTERCHANGEABLE MANUFACTURE . . . . . C. W. Ham	106
THE PLYM COMPETITION . . . . .	109
USE AND ABUSE OF REFRACTORY BRICK . . . . . G. W. Reed	110
COLONEL LINCOLN BUSH . . . . . D. C. Murphy	112
CONSTRUCTION OF A CONCRETE ROAD . . . . . A. A. Strane	114
POTTERY AND HOW IT IS MADE . . . . . R. F. Bopp	116
ARTICLES WORTH READING . . . . .	119
SYNCHRONOUS CONVERTERS . . . . . R. C. Groeger	119
EDITORIALS . . . . .	120
DEPARTMENTAL NOTES . . . . .	122
ALUMNI NOTES . . . . .	129
ONCE OVERS . . . . .	132

Published quarterly by the Illini Publishing Company, Incorporated, 524 E. Lincoln St., Urbana, Ill., at the post-office at Urbana, Illinois. Office of Engineering II, U. of I., Urbana, Ill.  
Subscriptions: \$1.50 per year. Single copies: 50 cents.



In Memoriam  
Arthur J. Ingold Jr.  
1900-1922



# The Electric Propulsion of Ships

W. J. BEHRENS, *etc.*, '22

One of the latest applications to which electric power has been put on a large scale is that of the propulsion of ships. This is only another forward stride in the development of man's oldest means of travel. Historians tell us that vessels were used as far back as 6000 B. C. and these were probably propelled both by oar and sail. As larger ships were built, oars became impossible and sails alone were used.

For centuries the sailing ship had no competition; but after the invention of the steam engine, the replacement of sails by engines was begun. Steam navigation had its real beginning in 1807, when Robert Fulton put his steamboat "Clermont" into service on the Hudson River. It was not until 1838, however, that a steamship crossed the Atlantic Ocean without the help of sails. From then on, the marine steam engine was steadily developed. As the size and speed of ships were increased, the use of reciprocating engines became prohibitive because of their great weight, space requirements, and, compared to the steam turbine, their low economy. The turbine, therefore, was next introduced as a means of propulsion; it was directly connected to the propeller shaft and resulted in a saving of space, weight, and, in the case of large ships, fuel. However, the turbine is essentially a high speed machine, while the screw propeller has its maximum efficiency at a comparatively low speed. Obviously under these conditions the highest over all efficiency could not be obtained. The next step, therefore, was to place a reduction gear between the turbine and the propeller shaft, thereby making it possible to operate both the turbine and the propeller at speeds of maximum efficiency. This step resulted in increased economy.

But even with the high efficiency of the geared turbine, propulsion machinery was not all that could be desired; the reasons for this follow. First of all, turbine driven ships must be provided with separate turbines for reversing, since this type of engine can be run in one direction only. This means greater weight and space, and higher first cost and maintenance. These objections are strengthened by the necessity of the reduction gear, which, in addition, decreases the reliability of the equipment, and causes noises that would be objectionable aboard passenger ships. Since electrical machinery can be designed to operate efficiently at almost any speed, it would seem logical to drive a generator with a steam turbine operating at a speed of maximum effi-

ciency, and with the current thus generated, drive electric motors on the propeller shafts, these motors to be so designed as to have maximum efficiency at the speed at which the propellers have maximum efficiency. This was the plan advocated about 1909 by William Le Roy Emmet, a consulting engineer of the General Electric Company. Mr. Emmet was awarded the Edison medal in 1919, and has probably done more than any one man in bringing about the adoption of electric drive for battleships. His plan was tried on the naval collier "Jupiter" about 1913; it proved so successful that the Navy Department decided to try the scheme on the U. S. S. New Mexico. This was a big step, as the "Jupiter" had only a 6500 h.p. installation, consisting of one 3-phase alternator and two induction motors; the ship did not need the maneuvering ability that would be necessary in a battleship. The "New Mexico" is a 32,000 ton ship, and develops 33,000 h.p. at her maximum speed of 21½ knots. Her operation has been successful, and all future capital ships of the U. S. Navy will be equipped with electric propulsion machinery. The new battle-cruisers of the "Ranger" class will displace 43,500 tons and to make their speed of 33.6 knots will have electric plants of 180,000 h.p. capacity.

The adoption of the electric drive is significant inasmuch as it shows the great confidence which is placed in electrical machinery. One naturally asks what great gains prompted this radical change in the method of propelling ships. The advantages of electric drive are numerous, but in this short article, they must be dealt with very briefly. It may be said, in short, that the electric propulsion machinery is more reliable and economical than any other, it may be more advantageously arranged in the ship, and is more easily controlled; it occupies less space; it weighs about half as much as the reciprocating engine drive, and compares about evenly with the turbine drive. At present, the greatest advantages of electric propulsion are gained by battleships, so this type of vessel will be dealt with first. Comparison will be made only with turbine drive, as any engineer will concede that for the high power requirements of a large and fast ship, reciprocating engines and Diesel engines are out of the question.

The electric drive is more reliable than the turbine drive for the following reasons. Nearly all large ships have four propellers; to each of these an electric motor would be directly connected in the

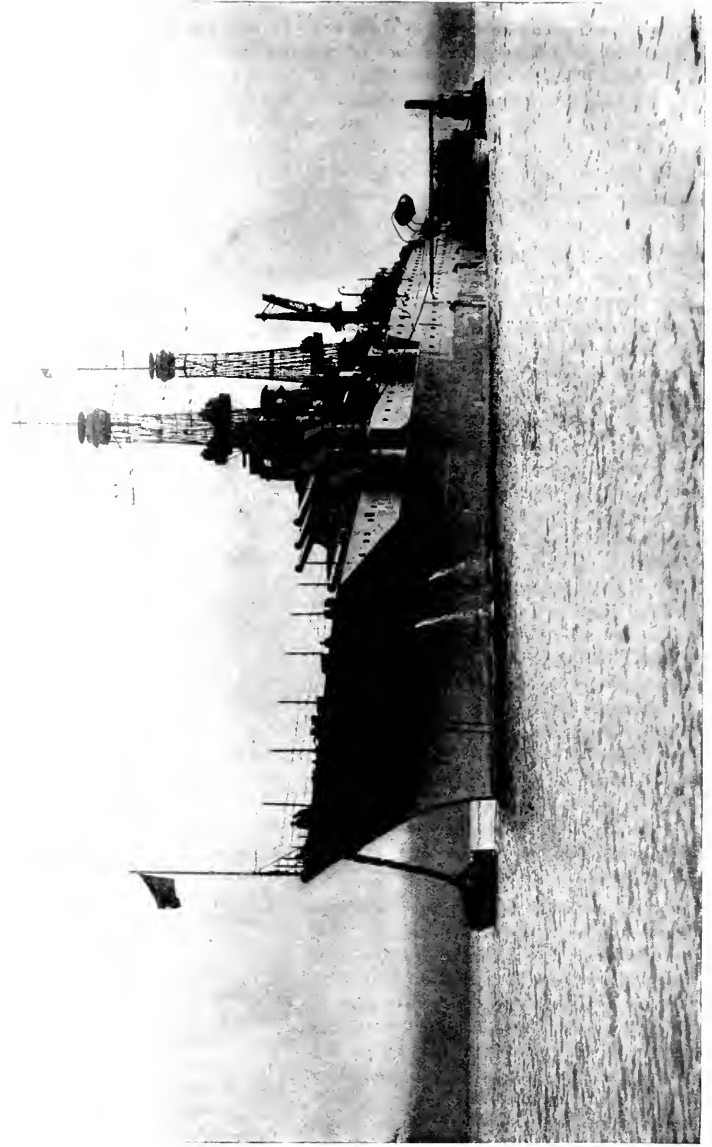

The U. S. S. New Mexico, the first battleship to be propelled by electric motors.

case of an electric ship, and current for the four motors, would be supplied by either or both of two generators. Damage to a turbine would, therefore, result only in a reduction of speed of approximately twenty per cent, because the power required to drive a ship varies about as the cube of the speed: the "New Mexico", for instance, develops 3200 h.p. at ten knots, while for twenty knots, 24,400 h.p. must be generated. But in the case of turbine driven ships, damage to one turbine would make it necessary to drag one or possibly two propellers. This would not only result in decreased speed, but would so lessen the maneuvering ability of the ship that her destruction would be almost certain in a modern naval engagement. Other causes contributing to the great reliability of the electric drive are the elimination of the reduction gear, the reduction in length of propeller shafts and the elimination of necessity for reversing any steam machinery.

four turbines at low speed; and at high speeds, because two turbines are operated at high speed rather than four turbines of lower speed ratings. The saving in fuel is very noticeable, as is evident from the following table; this compares the fuel consumption of the electrically driven battleship "New Mexico" with that of the "Idaho" and "Mississippi". These ships are exactly alike except for the propulsion machinery, the "Idaho" and "Mississippi" being fitted with direct connected and geared cruising turbines. The fuel consumption is taken as 100 per cent. on the "New Mexico."

SPEED Knots	APPROXIMATE FUEL CONSUMPTION PERCENTAGE	
	<i>New Mexico</i>	<i>Sisterships</i>
10	100	120
13	100	143
16	100	148
19	100	140
21.5	100	130



Fig. 1. General Arrangement of Machinery on U. S. S. Maryland

which is always more or less harmful. Elevator motors will operate equally well in either direction and reversal may be obtained by a simple switching operation.

Economy is another point in which the electric drive excels the turbine drive. The latter requires that all four turbines, in the case of a large ship, be in operation, even though the ship is running at low speed. This means that there will always be the losses from four turbines; and since these turbines are running at reduced speeds, the economy is considerably involved. But at reduced speed the same ship, if equipped with electric drive would only be using one turbine; and this one turbine would be operating only a little below its rated speed. Furthermore, it would be a high speed turbine. These reasons make evident the fact that the electric drive is much more economical than turbine drive, especially at reduced speeds. Now, a battleship must be capable of high speed in war time; but in peace times it must cruise only at about twelve knots, in order to keep down naval expenditures. High economy at both speeds was impossible with turbine drive; but it is possible with electric drive because by properly winding the motors, two different speed regulations may be obtained. Therefore, economy results at low speeds, because only one turbine is operated at a fairly high speed rather than

This point of fuel economy is more important aboard ship than ashore, because a ship must carry its fuel and sacrifice valuable space for it.

The most important advantage of the electric drive lies in its flexibility and the ease with which the machinery may be arranged so as to be best protected from torpedo attack and gunfire. The turbo-alternators may be placed on the center line of the ship very close to the bottom, where they are well protected. Each is placed in a water-tight compartment. The motors are also in water-tight compartments and may be placed far enough aft to materially shorten the propeller shafts. Electrical machinery can be more easily controlled from a remote point than can steam machinery, so electric drive has the further advantage of a centralized control. Figure 1 shows the general arrangement of the machinery of the U.S.S. Maryland, one of our latest superdreadnaughts. It can be easily seen that the prime movers are given greater protection than they could be given if they were lined up with the propellers, as they would have to be in a turbine driven ship. The centralized control makes the electric ship easy to manage, and since normal power reversing torque is always available, whereas the reversing turbines of a turbine driven ship have only

about half of full power, it is possible for an electric ship to maneuver better than any other.

As to weight, and space occupied, the turbine and electric drives must be placed on about the same status; the electric occupying less space, but probably weighing a little more. Whatever the difference may be, it is not very important. The first cost of the electric drive is a little higher than that of the geared turbine drive. This advantage of the turbine ship, however, is offset by the higher economy and lower maintenance costs of the electrically propelled vessel.

The U.S.S. *New Mexico* was the first super-dreadnaught in the world to be equipped with electric propulsion machinery. Since this is the only electric ship aboard which the writer has had any actual experience, it will be briefly described here as illustrative of the modern battleship propulsion equipment. Steam is supplied at 250 lb., 59 superheat, by nine 2500 h.p. boilers. There are three boiler rooms, each a water-tight compartment running across the ship. Oil is used as fuel. Figure 2 shows the general layout of the machinery. The turbo-alternators are located outboard in separate compartments; the outboard main motors are also in separate water-tight compartments. The control board, auxiliaries and inboard main motors are located in the center engine room. The turbines are of the Curtis type with ten stages; they are practically the same as those used ashore, except that they have a special governing device for variable speed operation. The generators are two-pole, two-phase machines for reasons to be given later; they are rated at 13,500 k.w., and maximum speed of 2100 r.p.m., giving 35 cycles as the maximum frequency. Each phase has two windings which may be so connected as to give either 3000 or 1210 volts; this is accomplished by parallel or square connection, respectively, made by closing the double-throw generator switch in one direction or the other. Interlocking devices make it impossible to parallel the generators. Parallel operation cannot be used, because it is necessary to run the motors on opposite sides of the ship in opposite directions during maneuvers, and all motor speed variation is accomplished by change of frequency.

The four propellers are driven by two-phase induction motors, rated at 6600 h.p., each. These motors are of interest inasmuch as they were especially designed for ship propulsion; they had never been used ashore. The stator has a winding which can be changed from 36 pole to 24 pole by the operation of a single switch; therefore, the speed reductions obtainable are respectively 18 to 1 and 42 to 1. Their winding was the cause of the adoption of two phase rather than three phase machinery, because with

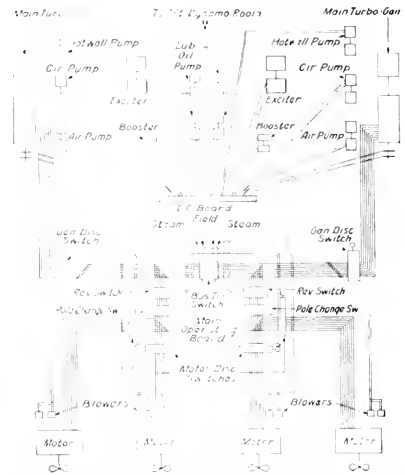

Fig. 2. Diagrammatic Arrangement of Apparatus and Main Cables for Propulsion Control Equipment

it the designers were able to work out a simpler method of control. The rotors of the motors are also quite different from those used ashore in that they have a double squirrel-cage winding. The outer cage has a high resistance and low reactance, and gives the motor the heavy torque required for starting and reversing; this eliminates the necessity of external resistances. The inner cage has a low resistance, which is desirable after the motor is up to speed, and a high reactance; this high reactance causes most of the current induced in the rotor during starting to flow in the low-reactance high resistance winding, producing, as aforesaid, the powerful starting torque. As the motor comes up to speed the frequency of the current in the rotor becomes very low and the reactance of the windings have little effect; therefore, practically all of the current flows through the low resistance winding. A portion of the rotor showing the double squirrel cage winding is shown in Figure 3. Trouble in any motor may be isolated from the rest of the system by opening the proper disconnecting switch shown in Figure 2.

Direct current for excitation and auxiliaries is supplied by two three-wire 125-250 volt, 300 k.w., turbine driven exciters. No rheostat is used in the generator field circuit; a booster set is used instead to buck or boost the exciter voltage. This makes possible the over-excitation of the generator during starting and reversing, thereby making possible the powerful starting torque of the motors. Therefore, excitation of the main generators is controlled by varying the excitation of the booster generator field. All auxiliaries are electrically driven except the feed pumps and the fire and bilge pumps.

For speeds up to seventeen knots the New Mexico uses only one turbine; using both turbines the ship can make 21½ knots. When both turbines are in use, each drives two motors; each side of the ship's power plant is then operated as a separate and independent system. Different speeds are obtained by changing the governor adjustment on the main turbines; this changes the speed of the turbine and therefore, the frequency of the electric system; since the speed of the induction motors depend on the frequency of the current supplied them, they will drive the propellers at a speed directly proportional to the turbine speed. The control of the ship has been made quite simple, and electrical and mechanical interlockers make improper operation almost impossible. The entire propulsion equipment of the ship was designed and constructed by the General Electric Company.

Although merchant ships do not derive as great benefits from the electric drive as do battleships, they are being fitted with such machinery for the following reasons, which are practically the same as those previously given in the discussion of battleships. First of all, the electric drive is the most economical, because it makes possible the use of the efficient high-speed steam turbine. Secondly, it saves space and makes possible shorter shaft alleys; this is an important item for a cargo ship. The maintenance cost for the electric drive is lower than for any other, and since electrical machinery is more reliable than any other, its use on merchant ships is desirable.

Electric merchant ships are at present using

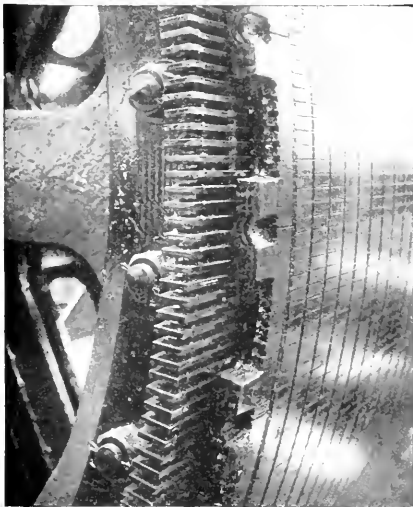

Fig. 3. A Portion of Rotor Showing Double Squirrel-Cage Winding

either turbines or Diesel engines as the prime movers. The turbine-electric installations are the same in principle as the battleship drives, but, of course, are simpler and much smaller. Both induction and synchronous motors are being used to drive the propellers. The synchronous motor must be provided with a squirrel cage winding to furnish the necessary starting torque. The advantage of the synchronous motor is that operation at unity power factor is possible. This means a slight saving in weight, space, and cost. The disadvantage is that of a more complicated control. All of the turbine-electric ships control speed in the same way, that is, by varying frequency through a change in turbine speed. Since an alternator is better adapted to turbine drive than is a direct current generator, alternating current is used on all turbine-electric installations.

Diesel engines are very economical of fuel, but in sizes large enough to drive a ship they often give trouble; they are subject to great temperature strains which often result in breaks. In smaller sizes, however, they are very reliable. Therefore, by using a number of relatively small Diesel engines to drive generators, and supplying the electric power thus generated to motors on the propeller shafts, the most economical means yet devised for driving ships is obtained. Since from four to eight generators may be used with this scheme, it is not practicable to use alternating current; parallel operation would be necessary, and would be unsafe because of the method of speed control by variation of the frequency. Therefore, at present only direct current is used, the generators being operated as shunt machines in series. The fields of the motors and the generators are separately excited. Connected in series with the generator excitation bus is a reversing rheostat which makes it possible to vary the voltage applied to the motor armature from zero to a maximum in either direction. Therefore, the ship may be brought from full speed ahead to full speed astern without any switching operations. The variable voltage method of speed control is economical, and the series operation here described is the most common in use at present with the Diesel electric drive. In addition to reliability, economy, simplicity of control, and low maintenance costs, the use of the Diesel engine results in a great saving of space, because no boilers or water tanks are necessary. Because of the number of generating sets used, the reserve power is great; damage to an engine would result in only a slight decrease in speed. This is a very economical type of drive for coastwise and river vessels, revenue cut

(Continued on page 134)

# Along the Old Spanish Trail

By PRENTICE DUELL.

*This article is taken in part from a previous one by the same author in the Los Angeles Times.*

What joy it is to the true vagabond to hit upon a new trail! a trail not worn into a public highway, by the tramp of indifferent thousands, nor become common through hackneyed praises sung in its favor. If a few romantic and picturesque places still remain, it is only because of their comparative newness and not being generally known, or because they are as inaccessible as Mount Sinai, which immediately disqualifies all but the esoteric of the vagabonds. Just as the tourist will follow the beaten path, so will the vagabond seek the untrodden way, finding the solitude sweet amid surroundings which he may call quite his own. To be sure, a jaunt down the Rhine in summer, listening to the legends and the Lorelei, and pondering upon the dead autocracy which the castles represent, is always interesting; and nothing, it seems, could be more enchanting than springtime in Touraine, tramping along the Loire, and visiting the chateaux in their regal culture of the past.

But, for him who seeks the new trails, be he scholar or idler, let him consider, above all, America; and turn his face to the great Southwest, the field of Spanish conquest, replete with history and romance against its mellow background of the Spanish Renaissance.

With El Camino Real an exception, the mission trails have scarcely been trod since the time of the padres. Lower California has a mission chain of which practically nothing is known; Texas has a chain of imposing Spanish architecture; while in New Mexico are the remains of a very old chain of missions, strongly characterized by Indian workmanship. Arizona has a few well-known missions, but they are the end of a great mission chain which beings far down in Mexico. Very little is known concerning these missions in Mexico, and up to a short time ago they existed, for the most part, only in legend.

Consequently, not being able to abide their enmity any longer, a group of architects, archaeologists and engineers assembled a short while ago and made the trip along this mission trail. It was far from traveling *de luce*, but the execrable roads, along with the radiators of the cars boiling by day and freezing by night, were forgotten and seemed of little consequence in this glorious realm of mission architecture.

It should be first understood that practically all of the missions in Mexico are Franciscan, either built upon the ruins of former Jesuit churches, or remodeled after the original church to more pretentious proportions. But the thing which makes these missions significant is that they were built by Father Kino, that remarkable old Jesuit, who was the harbinger of the great missionary movement which was to follow throughout the southwest. For many years he labored untiringly in that desert country a virile old man, who thought nothing of traversing this whole territory on foot, and after a few days rest beginning another trip of similar length. He kept a modest diary of his trips, mentioning in a simple way the great work he accomplished,—quite unlike the classic Aeneas, continually babbling "quorum magna pars fui". The diary of Father Kino was used as the guide-book for the trip. The names of the places seemed to have changed but little within the last two centuries, so it was an easy matter to follow his trail from the descriptions of his churches, and make an attempt at distinguishing between the old Jesuit work and the later Franciscan additions.

The missions follow no direct route as do those of California, but rather tend toward the north in three distinct groups, which we shall designate as the eastern, central, and western groups. It is the eastern which continues further than the other two and includes the missions which are now in Arizona.

The starting point of the trip was Nogales, Arizona, situated on the border and almost in line with the central group of missions. Of the missions comprising the eastern group on the Mexican side, only Cocosperra, near the border, remains. So, first taking in this mission, the party followed down the central group for nearly one hundred miles to the last mission in order, Santa Anna; then cut almost straight across the country to the first mission of the western group, Caborca, and proceeded up to the border again, arriving at the town San Fernando.

So much for the itinerary—now for the trip. The party, accordingly, crossed the border and after following a round-about way, entered Cocosperra Canyon. A small stream flowing through this canyon follows such a serpentine course that it was crossed forty-eight times. Upon reaching level country again and traveling a few miles further, Coco-

spera was seen, undoubtedly the most picturesque, yet sinister, of the mission ruins. Crowning the summit of a hill which rises abruptly from the plain, the remains of the two towers, jutting above the ruin, makes a fantastic and interesting silhouette against the sky. It is evident that the Franciscans remodeled the old Jesuit mission. The front wall or facade is nothing more than an ornamental brick veneer, standing before the original adobe wall, and now about to fall entirely away from it. As one views the nave, with the sunshine coming through the dilapidated roof, the vivid colors softened by

Both are beautiful in shape, and one of them reads: "San Antonio 1698", signifying that it hung in the church of the Jesuits.

In one of the mountains near Imuris is a cave, rather inaccessible, of which the people frequently speak. The walls are said to be covered with cartoons of the padres, as depicted by the unfriendly Indians. What a source of pleasure it would be to study these pictures—to try and grasp the mental pictures behind the strokes of the chalk, and, possibly, determine the picture of Padre Kino himself.

The night before leaving Imuris, the party



A MEXICAN BOULEVARD.



STREET SCENE.



ALONG THE HIGHWAY.



BELLS OF COCOSPERA.

time and blended by the weather stains, he fancies that he has before him a brilliant water-color and realizes that this was one of the most exquisite passages in Mission architecture.

The next mission was Imuris, represented by only a mound of earth and a few low walls. Evidently, the Franciscans did little, if any, restoration, so the remains were, probably, of Jesuit workmanship. It now serves as the community brick-yard, and anyone mustering enough ambition to build a house can have his bricks free, which are all the better for their age of two centuries. While the party was there, one of the Mexicans dug up a baptismal shell. A modern church has been erected beside the ruin, noteworthy only because of the two bells from Cocospera which hang at the entrance.

heard for the first time the legend of "Francisco Rit, The Phantom Padre", which is persistent throughout the Mexican mission-country. A gray-haired señor, much the worse for the revolutions, had brought as his offering a couple of onions, that he might toast his feet at the campfire and partake of a cup of coffee. During the story telling, he arose and recited the legend, acting the various parts with wild gesticulations. Many of the Mexicans of the past generation have spent much of their life digging for the gold left by the padres, and Francisco Rit is the "Phantom Padre" who guards the treasure by night and day. The old gentleman had often seen him looking silently over the mission fields, a large hat on his head and the cord at his waist, and one time, shovel in hand, he went up to

question the padre. But lo, where he was standing there was nothing but air, and strange, as it may seem, he again saw the padre standing a short distance away. The señor went so far as to give chase, but to no avail. The padre was never where he seemed to be, and as he always kept his face turned away, he could not be recognized. As a reward for his good story, the señor was given a strong cigar, which he graciously accepted, saying he would smoke it the next day in the plaza.

From Imuris, the party followed the trail down to the next mission, which was San Ignacio. This proved to be one of the finest missions of the chain, and is kept in excellent repair. Though Franciscan, the hand of the Indian is very apparent in the crude, grotesque decorations about the entrance and altars, yet anomalous as it may seem, the two front doors are beautifully carved after a Spanish pattern by some master craftsman. Realizing that his doors were to stand exposed to the elements, he carved his patterns deep, so that now, after a century, one may marvel at them and realize that they have no equal in mission architecture.

From within the church, a circular stairway winds up to the roof, making exit in a peculiar drum-like tower. The belfry, opposite, contains five very old bells and together they make a very agreeable chime, which is not always the case with bells brought promiscuously together. The builders of the

church covered the nave with a huge barrel-vault, and over the apse end of the nave erected a large dome. Then fearing less this superimposed weight should push out the walls, they descended to the ground and built two amazingly large buttresses to hold up the walls, a very commendable method at that, and one not far removed from the principle followed by the Gothic builders.

The next morning the party reached Santa Anna, the last mission of the central group. A new church, box-like and uninteresting, stands beside the ruin of the old one. Two of the bells, however, of the original church hang in the belfry of the new one, and the oldest, which is broken, dates 1774.

In order to reach Caborca, the first of the western group, it was necessary to travel fifty miles directly across the open desert. The road is so bad and bumpy that the Mexicans claim the distance is really one hundred miles—fifty up and fifty down. Caborca is a large Franciscan church, built near the location of an earlier one of the Jesuits. It was the prototype of the mission San Xavier del Bac, near Tucson, Arizona, both being built by the same workmen and apparently from the same plan, though the latter is infinitely more refined.

Some three years ago, the river changed its course, unfortunately, and washed away the apse and one transept of the church, leaving the great

(Concluded on page 142)



CABORCA.

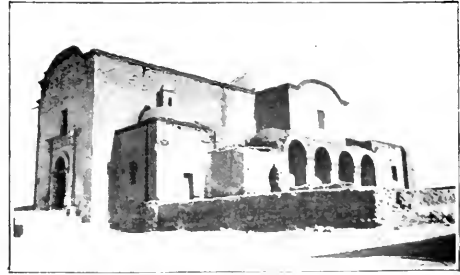

PITQUITO.



CUCUYDA.

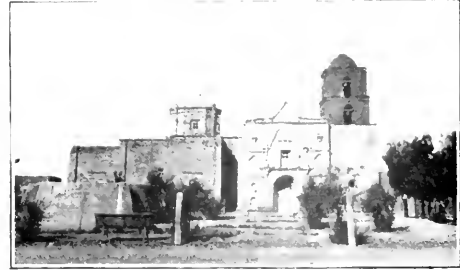

TUBUTAMA.



# A Recent Boiler Development

By K. C. Brown, m.e., '22

Engineering endeavor has always been directed toward economy of material, energy, time, and space, and any engineering development, to be successful, must embody an advance along one or more of these lines.

Some time ago Mr. W. H. Winslow, of Chicago, decided that the boiler with which his steam auto-

mobile was equipped was not as efficient, nor as reliable a boiler as could be designed for the same purpose. He considered certain improvements were possible, and set himself the task of designing a boiler embodying these improvements.

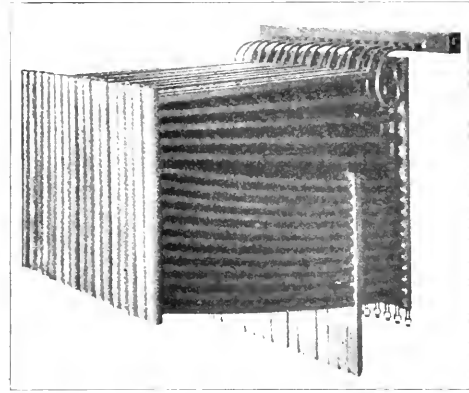

Fig. 1. Sectional Type of Boiler

mobile was equipped was not as efficient, nor as reliable a boiler as could be designed for the same purpose. He considered certain improvements were possible, and set himself the task of designing a boiler embodying these improvements.

The requirements which these improvements, had to fill, in this case, were as follows: (1) working steam pressures of around six hundred pounds per square inch must be carried with safety; (2) steam at medium pressure (about two to three hundred pounds per square inch), must be available from the cold boiler in the shortest possible time, that is to say, the boiler must be quick steaming; (3) the boiler must be able to function properly with water from any source of reasonable purity, such as the ordinary steam, or city water supply; (4) it must be easily and quickly repairable; (5) the water content per unit of volume occupied by the boiler must be as large as possible.

A study of the existing boiler types finally limited the design to the water tube type, but owing to the high pressure to be carried, the drum, which is common to the standard water tube boilers generally used, had to be eliminated. Further modification to obtain quick repair required that parts of the boiler be capable of being isolated and removed

with the shortest possible time of shut down for the boiler.

The result was the sectional type of boiler illustrated in Figure 1, which was constructed as follows. Each section consisted of two vertical seamless steel tubes, or headers, between which ran fifteen tubes of the same material, at slightly varying angles to the horizontal. The short headers were sealed at both ends. The long ones were sealed at the top, and at the bottom were provided with a collar and nut for attaching them to a horizontal tube, slightly larger in diameter than the headers, which was known as the mud drum. The steam outlet from each section consisted of a small pipe connecting the header to the collecting main.

All joints in the boiler, excepting the connection to the mud drum, are made by welding. Enough metal is added in the welding operation to insure a strong joint; the joint being stronger than the tubes, as has been shown by repeated tests of tubes and joints combined. In the boiler illustrated in Figure 1, the ends of the headers are also closed off by welding.

The above description and Figure 1 apply chiefly to the earlier boilers constructed by Mr. Winslow. The latest type concerning which the writer can give any information is shown in figure 2.

An endeavor has been made to gain a greater water content per unit of space occupied by ar-

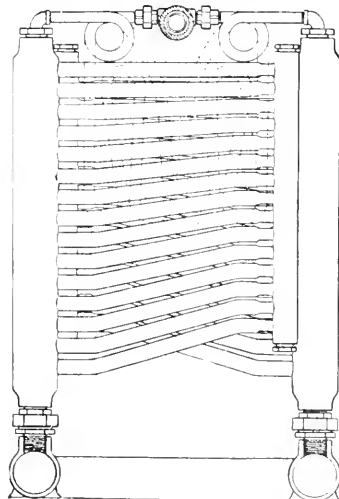

Fig. 2. Latest Type Winslow Boiler



# The Short Course in Highway Engineering

Illinois had for many years borne the unenviable reputation of being very backward in highway improvement, when, in 1913, the Legislature laid the foundation for putting the State in the very forefront of highway development by the passage of the so-called "Tice Law".

This law in addition to putting into better working order many existing provisions, established a State Highway Department with extensive powers, created a State Road Fund, provided for State aid to the counties in improved road building, and laid the foundation for the eradication of the ever-wasteful township method of highway control by creating a County Superintendent of Highways.

The immediate result was the focusing of attention on road building and in bringing into existence officials who must at once take charge of important affairs, and who had had little opportunity to fit themselves to perform their duties as well as would be required.

Realizing that an opportunity was needed for these men to get together and learn their duties, exchange ideas, get the best information, and lay plans for thorough coordination and cooperation in their work, Professor Ira O. Baker, Head of the Department of Civil Engineering, conceived the idea of holding a "Short Course" for this purpose. Supported by the cordial cooperation and assistance of Mr. A. N. Johnson, at that time Chief State Highway Engineer, the first Short Course in Highway Engineering was held during January 1914.

This first Short Course lasted for two weeks and was operated entirely on the "convention plan". Men of known or assumed ability presented certain topics following which was open discussion. The attendance was made up of a large number of the newly appointed county superintendents, candidates for the position, and many others with perhaps only a general interest in the matter, making a total of about 250.

The following year a second course was given along the same lines. With a year's experience, things were beginning to take shape, and there began to develop a demand for more specific information and for information on technical matters.

Plans were made for the third course, but owing to an unfortunate combination of circumstances, it was found necessary to call the meeting off, just a few days before it was scheduled to begin. This is the only instance where the Short Course was not held since the beginning of the plan in 1914. The Legislatures of 1915 and 1917 made few

changes in the road laws, and consequently, the Short Course proceeded on the plan of adding to the general and technical information of those who attended. For this purpose, the method of holding the meetings was modified so that the morning sessions were made in sections discussing specific titles; these sections were repeated if found necessary. Each man could, therefore, attend the parts he was interested in, and as each section contained but about thirty men, it was possible to hold closer discussion. The afternoon sessions were of the convention type as before, with evening sessions of a general or popular character.

The Legislature of 1917, however, failed to pass one law of importance; namely, the so-called "Sixty Million Dollar Bond Issue Law". This law created a state wide system of roads to be built at the entire expense of the State from funds derived from automobile licenses. It was provided, however, that the matter should be submitted to a referendum vote in the fall of 1918. Naturally, considerable attention was given this matter in the Short Course in 1918, as an aid to the campaign for the election.

From 1917 to 1920, the Short Course was carried on as outlined above. The attendance was variable and was affected by war conditions, and the time was cut to one week.

With the closing of the war, it began to look as if road building would boom. Large sums of Federal money were available, automobile fees had accumulated for the reason that during the war little work was done and state aid was greatly curtailed, and it began to seem possible to issue some of the bonds provided for. As the bulk of this work would be done under the jurisdiction of the State Highway Department which by the way had changed its name to the altogether cumbersome and unattractive one of "State of Illinois Department of Public Works and Buildings Division of Highways"—it was thought by that department that it would be highly desirable to emphasize the problems of the state department engineers especially as there had been little change in the status of the county work.

The Short Course in 1921 was, therefore, carried out with that in mind. The Division of Highways sent practically its entire force of 300 engineers, paying their expenses and continuing their salaries, thus spending considerable sums for the benefit of the men. County men and others came so that the total registration exceeded 600. Although the program had the appearance of being of the "convention" type, it was essentially a "class room"

(Concluded on page 131)

# The Engineering Council

H. D. ROSENDALE, M.E., '22

In the early part of 1919, just at the time when the Faculty was dealing with the greatest problem that ever confronted the University of Illinois, that of clearing away the debris of the S.A. T.C. and bringing back pre war conditions, an idea occurred to Dean Richards which he soon put into action. The idea was not exactly a new one, for a good many years before the Dean had expressed his desire to have in the College of Engineering a group or body of representative students with which he could confer on student matters, and through which he could communicate with the students of his college. Because of the acute conditions existing in the Spring of 1919, however, he felt the real need of such a group. So the occurrence, or re-occurrence, of the idea speedily resulted in a letter being sent to the presidents of the eight departmental societies.

This letter suggested that some association of the engineering societies be formed, consisting possibly of the presidents themselves. This association was to represent the larger interests of the engineering students and the College of Engineering, as distinct from the interests of the separate departments and their students. To quote from the letter, "Such an association should take leadership in certain general engineering activities, many of which will occur to you without my suggesting them."

The suggestion found a foothold immediately, and in a short time the eight presidents formed the Association of Engineering Societies of the University of Illinois, and the Engineering Council.

In brief, all undergraduate members of the engineering societies in good standing in their respective organizations are members of the Association. The Association in turn is governed by the Engineering Council which consists of the presidents of the eight engineering societies and the editor of the Technograph. The Association is more or less of a mythical organization as it practically never is called into session. The Council, on the other hand, meets every week to discuss its business, and is always ready to aid the Dean in any case that might arise. It is the group of representative students that the Dean desired. He can place his finger on it at any time, and there can be no squirming to "get out from under".

Inasmuch as nearly every engineering society elects a president each semester, a practically new Council goes into session every September and Feb-

ruary. The new men immediately elect one of their number to act as chairman of the Council, and the usual duties of a presiding officer fall upon this man. A secretary and treasurer are also elected.

At the end of the second semester of each school year, the Engineering Representative to the Illinois Union Student Council is elected. If this man is not already a member of the Engineering Council, he immediately becomes one.

The Council is very young, but it already has assumed very definite duties, and these are being added to every year. At the present time it appoints the committee to arrange for the Annual Engineering Dance. The appointment of this committee is made with the object of securing just as representative group as possible. The various engineering societies, and the honorary and professional engineering fraternities on the Campus are requested to suggest the name of one of their members to serve on this committee, and these men are invariably appointed. This assures a fair and broad selection of men.

The Council also appoints the committee to arrange the Annual Engineering Smoker which is held during the second semester of each year. The Chairman appoints three men from the Council to serve on the Open House Committee, while each man on the Council always takes it upon himself to aid his respective department head in arranging the exhibits.

In addition, the Chairman appoints three men at the start of the first semester of each year to serve with various members of the Faculty on the Engineering Lecture Committee. It is this group that is arranging the program for the March Engineer's Convocation.

That the Engineering Council deserves a place on the Campus is not to be doubted, for besides being the connecting link between the Dean's Office and the engineering students, it supervises the various social functions, meets deficits and distributes surpluses, and investigates new ideas for proposed events, and plans the approved ones. It is in the Engineering Council that a possibility of a "greater engineering student body" lies, and for this reason the various departmental societies should be very careful in the selection of their officers so that the work of the Council can be carried on by the ablest men available. This matter should be given serious thought, for at the present time, the societies are not receiving proper support.



L.J. WARGIN - TREAD.  
A.A.E.



H.D. ROSENDALE - CHAIR.  
A.S.M.E.



A.L.R. SANDERS - SEC'Y.  
A.S.C.E.



C.L. CONRAD  
E.E. SOCIETY



A.J. INGOLD, JR.  
EDITOR, TECHNOGRAPH.



J.J. BRESSE.  
ARCH. SOCIETY.



J.M. HALPERIN.  
R.W. SOCIETY.



E.H. ALLISON.  
MIN. SOCIETY.



J.R. GREEN.  
CERAMIC SOCIETY.

# Tolerance Systems in Interchangeable Manufacture

PROF. C. W. HAM

Interchangeable manufacture may be defined as the machining in quantity of component parts of a given mechanism within such limits that they may be assembled into the mechanism, replaced, or transferred from one mechanism to another, without re-fitting. In the early development of the machine trade, the assembly of parts into a mechanism required the fitting of each part to the component part with which it was to engage when in use. This was a slow process, involving much fitting, filing and chipping. This method is still used to a large

data and have established tolerances applying more or less imperfectly to their own product, but there are no generally recognized standards, nor is there a standard method of expressing limits and tolerance on drawings. More or less confusion exists also in regard to the terms used in connection with interchangeable manufacture. For example the terms "limits", "tolerance", and "allowance" are not synonymous, yet they are frequently so used. The following terms with their definitions conform to the best usage:

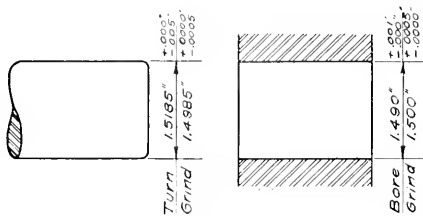

Fig. 1. Shaft and Hole 1 1/2 in. Nominal Diameter Dimensioned for Running Fit

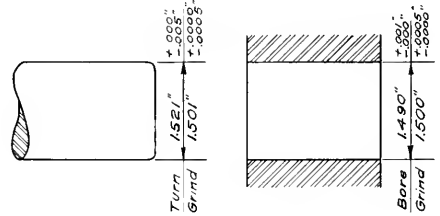

Fig. 2. Shaft and Hole 1 1/2 in. Nominal Diameter Dimensioned for Light Driving Fit

extent in repair work, but has been almost entirely superseded in manufacturing work, due to the tremendous improvements that have been made in machine tools. Grinding machines, in particular, have been brought to such a high state of perfection that they produce a finer quality of work on parts requiring finished surfaces, more rapidly and with greater accuracy than ever before. Quantity production with a high grade of precision has been made possible. With the closer tolerances demanded, developments in measuring devices and methods have necessarily followed. First, the one time all-round mechanic with his scale gave way to the highly specialized expert with micrometers and profectors. Still later, gages were devised which made it possible to so accurately determine the dimensions of individual parts, that after the parts were made, they could be assembled into the machine without further fitting.

With the introduction of interchangeable manufacture, it became imperative to specify dimensions in such a way as to provide for the various classes of fits required. Since imperfections in workmanship, and variations in measurement cannot be avoided, no two parts can be made exactly alike. Dimensions must, therefore, be provided with tolerances, thus establishing limits for the variations in size. Most manufacturing plants have accumulated

**Limits:** This term refers to the maximum and minimum dimensions within which a part must be held. These dimensions limit the variation in size of duplicate parts, due to unavoidable imperfections in workmanship and variations in measurement.

**Tolerance:** Tolerance is the amount of variation permitted in a dimension. The tolerance is equal to the difference between the maximum and minimum limits of any specified dimension.

**Allowance:** This term is properly used when referring to the amount of metal left for removal in the next operation.

**Clearance:** Clearance is the difference in dimensions of component parts to provide for running or sliding fits.

**Interference:** Interference (sometimes called metal interference) is the difference in dimensions of component parts to provide for driving, forcing, pressing, or shrinking fits.

**Basic Dimension:** The basic dimension is that dimension which defines the more vital of the two limits. The application of the tolerance to the basic dimension fixes the other limit. In general, the basic dimensions of a male surface is the maximum limit, and requires a minus tolerance. Similarly, the basic dimension of a female surface is the minimum limit, and requires a plus tolerance. (See Fig. 1 and Fig. 2).

**Selective Assembly:** Limits should be as wide as conditions permit, and such as can be readily maintained under normal manufacturing conditions. With practical manufacturing tolerances, companion parts made to the extreme limits may not always interchange. Some selecting may be necessary to attain the proper results. This is known as selective assembly.

Illustrative Examples:—

Fig. 1 and 2 show a shaft and hole,  $1\frac{1}{2}$ " nominal diameter, dimensioned for a running fit and a driving fit respectively. These illustrations are taken from actual practice. The data for such simple cases is fairly well standardized, in the sense that manufacturers are in close agreement. Referring to Fig. 1, it is specified that the minimum clearance between shaft and bearing to provide for lubrication shall be .0015". The basic dimension of the shaft is, therefore,  $1.5000'' - .0015'' = 1.4985''$ . The tolerance on the shaft is  $+.0000''$  plus  $-.0005''$  or a total of  $-.0005''$ . The limits on the shaft are 1.4985" and 1.4980". The maximum clearance is  $1.5005'' - 1.498'' = .0025''$ . The minimum clearance is  $1.5000'' - 1.4985'' = .0015''$ .

Referring to Fig. 2, it is specified that the interference of metal shall not exceed .001" for the light driving fit. The basic dimension on the shaft is, therefore,  $1.500'' + .001'' = 1.501''$ . The tolerance on the shaft is  $+.0000''$  plus  $-.0005''$  or a total of  $-.0005''$ . The limits on the shaft are 1.5010" and 1.5005". The maximum metal interference is  $1.501'' - 1.5005'' = .0005''$ . It can be observed here that if an attempt is made to assemble component parts made to the extreme limits, they are likely to fit too loosely, and some selecting may, therefore, be necessary.

The allowance on the shaft for grinding is specified as .020". The turning dimensions 1.5185" are obtained by adding .020" to the basic dimensions 1.4985" and 1.501", respectively. It should be noted that in each case, Fig. 1 and 2, the tolerances and limits are based on the diameter of the hole as the standard. That is, the nominal size is  $1\frac{1}{2}$ " for both shaft and hole, but 1.500" is taken as the basic dimensions of the hole.

In specifying limits and tolerances, the basic dimensions of a part to be machined should be such as to require the removal of the minimum amount of metal to bring the part to that dimension. The tolerance should provide for any additional amount of metal that may be removed through unavoidable variations in measurement and workmanship. Referring again to Figs. 1, and 2, the basic dimension of the shaft is the maximum limit with a minus tolerance, while the basic dimension of the hole is the minimum limit with a plus tolerance.

In general, dimensions requiring tolerances under .005" are expressed in decimals. Dimensions which do not require tolerance closer than .005" may be expressed in fractions and covered by a note printed on the drawing such as, for example, the following: "Fractional dimensions may vary  $\pm .005$  unless otherwise specified." Obviously, pattern dimensions do not require tolerances, and tolerances on dimensions made to jigs and gages are sometimes

omitted from the drawing since they would serve no useful purpose, when the jigs and gages are made under tool room conditions where such work is always made to conform to certain established standards of accuracy, well within manufacturing tolerances. While the foregoing may be considered as representative of best practice, other methods of expressing tolerances on drawings are in use. In most cases, however, the tolerances are based on the diameter of the hole as the standard.

The difficulties and delays encountered in the early period of the war in the manufacture of war material, and in the manufacture of tools and gages for the purpose, brought forcibly to our attention the lack of definite knowledge regarding necessary accuracy. Had this subject been more thoroughly understood at that time, a great deal of useless effort and expense could have been saved. While it must be recognized of course that many individual concerns had more or less satisfactory systems of tolerances applying to their product, the conditions in industry brought about by the war greatly accelerated the educational work concerning approved methods of expressing tolerances on drawings and in the standardization of all practice in this respect. It is the almost universal experience of those who have had to deal with the subject, that tolerances given on drawings have been too small; almost never too large. There are several reasons for this: one is that the designer usually errs on the side of safety, and another is the assumption on the part of some designers that tolerances can be obtained, which in reality, are impossible or impractical of attainment. And again, another cause is often the belief on the part of the designer that the tolerances expressed on his drawings have been maintained, when as a matter of fact both the workmen and the inspectors may have more or less ignored the tolerances because of their too exacting requirements, and yet obtained interchangeability because of their long experience with the particular product. In the latter case the system, rather than the designer or workman, may be at fault. It has been stated by a well-known authority on the subject "that tolerances are in most respects like laws. There are two classes of laws, one so severe and exacting in its nature that it cannot be enforced, soon falls into disrepute and is disregarded even though it remains in the statute books. The other is drawn up with a full understanding of existing conditions and its justice to all concerned is so evident that it is readily enforced. Similarly tolerances fall into two classes; those which represent the extreme conditions of accuracy obtainable, and therefore are impracticable of accomplishment; those which are liberal enough to be obtained under the existing shop conditions,

(Concluded on page 138)

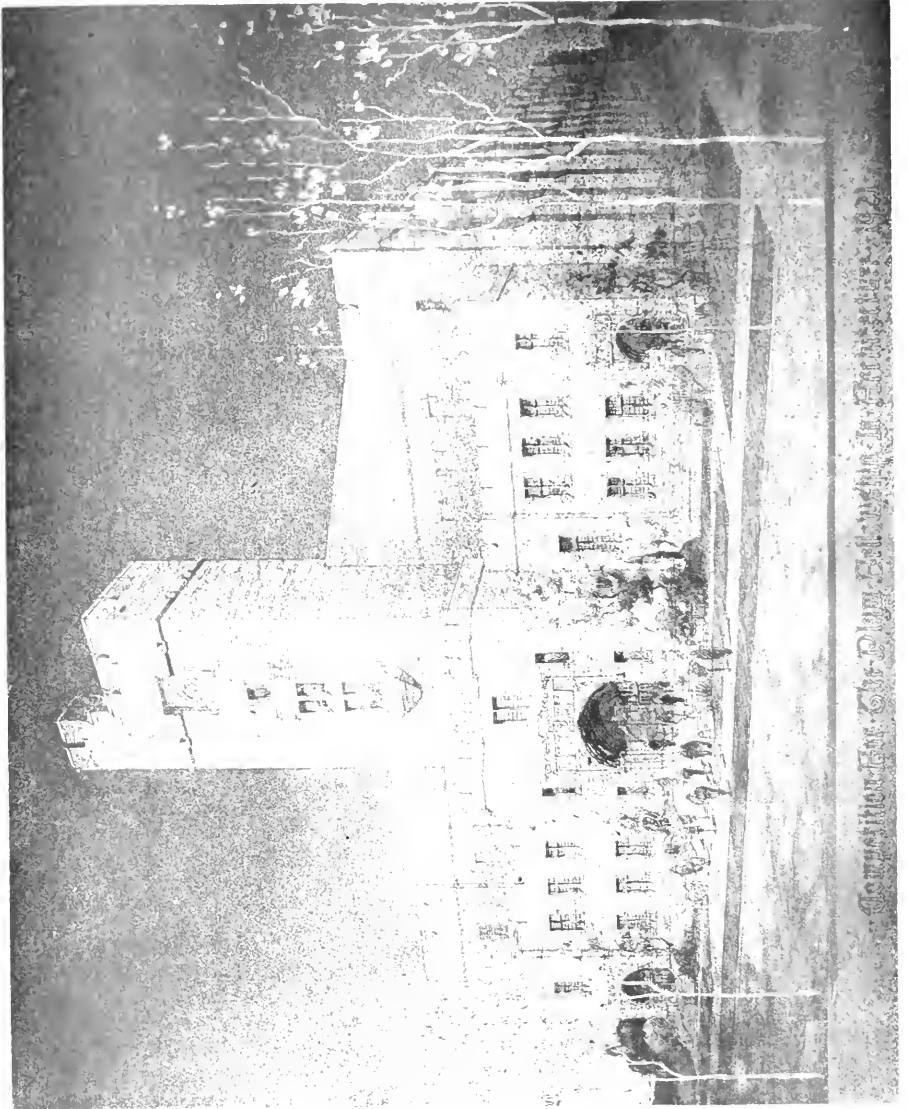

UNIVERSITY OF MICHIGAN LIBRARY



# The Plym Competition

The generosity of Francis J. Plym, graduate in Architecture from the University of Illinois in the Class of 1897, has made possible the annual opportunity for a graduate of the Department of Architecture to continue his studies abroad. The value of the Fellowship is one thousand dollars which must be used for one year of travel in Europe for the study of architecture. The award is made upon a competitive basis; the only requirements for eligibility are that the candidate be a graduate of the Department of Architecture of the University of Illinois and under thirty years of age.

The eighth competition was held during February, March, and April of 1921. Mr. Ernest Pickering of the Class of 1920 was the successful competitor; he is at the present time studying in Paris.

The competition consisted of a preliminary and final exercise in architectural design. The preliminary design was open to all who were eligible and had filed the required application; it consisted of a problem to be executed in a period of five days. The Fellowship Committee selected the four best designs submitted in this preliminary exercise, and the final exercise was limited to the authors of the designs thus selected.

The final exercise was a further development of the preliminary problem and was executed in a period of about five weeks. The competitors were permitted to do their work locally, but a statement was required to the effect that the designs submitted in both exercises were the competitor's own conception and that the drawings were the work of his own hand done independently of any school, atelier, or architect's office.

The Committee selected the best design submitted in the final exercise and recommended its author to the Trustees of the University for appointment to the fellowship; when the quality warrants further grading, First Mention and Second Mention are awarded. Had the winner found it impossible to accept the conditions at the proper time, the author of the design awarded First Mention would have been recommended. The Committee, however, reserves the right of making no award if in their judgment the design or quality of drawings submitted in any competition justifies such action.

Unless unforeseen conditions arise which warrant modification of the plan, the winner of the Fellowship must sail for Europe not later than October 1, must remain abroad and pursue the study of architecture, following a plan approved by the Committee for a full term of one year; he may not ac-

cept remunerative employment during the term of the Fellowship.

Holders of the Plym Fellowship, at their option, may also be registered in the Graduate School as candidates for the academic second degree of Master of Science in Architecture. A minimum of one full calendar year's work is required for the degree; eleven months shall be spent in Europe and the last month in residence at the University of Illinois. Of the eleven months abroad, at least eight months must be spent in some recognized atelier or school in Paris, or in the American Academy in Rome; the month in residence at the University of Illinois shall be used to complete the thesis, the material for which was collected during study abroad.

The particular problem of the eighth competition was the design of an assembly hall for a large university. There was already on the campus an auditorium for formal exercises; but the increasing popularity of basketball, the increase in recent years of attendance at conventions held on the campus, the need for a large dance floor, and a place to hold large banquets, and perhaps commencement exercises made such a building a necessity. It was assumed that the accommodation of 8,000 people at a basketball game would be large enough to serve the other purposes. The contestants were advised to remember that ample entrances and unobstructed exits must be provided, as the audience assembles only a few minutes before, and all desire to leave at the same minute after the event. One or more balconies were to be used to accommodate the people; balcony seats were to be fixed, but those on the main floor were to be movable. A part of the building was to be so arranged that it could be converted into a campus theatre seating 3,000. Locker space with showers and toilet accommodations for the teams was to be provided, also the kitchen and service rooms necessary when used as a banquet hall, and check rooms and toilet accommodations for the public. The drawings required were one plan, one elevation, and one section; any other drawings necessary to fully illustrate the author's scheme were submitted.

The solution submitted by Ernest Pickering is reproduced in elevation on the opposite page.

The drawings for the preliminary competition for the ninth fellowship have already been judged. Of the solutions submitted, three were selected and the authors invited to participate in the final exercise which will be held during March and April.

# Use and Abuse of Refractory Brick

G. W. REED, M. E., '22

It will be the object of this article to deal, not with the methods of production of fire brick, or to cover the entire scope of refractory brick uses, but to emphasize primarily the factors affecting the performance of fire brick in typical boiler units.

The conception is too prevalent that a refractory brick is merely one that will resist a high temperature. This is quite an erroneous belief, as experience proves that frequently the deciding factor is either strength to resist a crushing load, or resistance to destructive slagging, or the ability to withstand changes in volume without too great a reduction in refractoriness through subsequent cracking and spalling.

If heat resisting materials could be used in their purest form, troubles with refractories could be greatly mitigated. As in the case with most engineering specifications, the specifications of fire brick represent a compromise to meet conflicting demands. Specifications for an average fire brick demand that it resist the temperature of 3000 degrees Fahrenheit, withstand a crushing load of 1800 pounds per square inch, and have a linear expansion or contraction of less than one per cent.

In general, pure materials make bricks of the highest refractoriness, and the bonding materials which must be added to give strength to the brick lower the heat resisting qualities greatly. The compressive strength of the brick decreases rapidly as the temperature increases, and as the load on any brick shape increases, the temperature at which softening occurs decreases. Thus, the bricks that have successfully met specifications in the laboratory have softened at a comparatively low temperature

when subjected to a load of only ten to fifteen pounds per square inch. Failures from softening under pressures have frequently occurred in radial arches in which high stresses peculiar to this type of structure abound.

One of the most common errors made in the usage of a boiler unit is the attempt to overcome the shortcomings of a breaching, or stack, by the installation of a forced draft. The brickwork was not intended for this severe service, and sooner or later it fails. Due to excessive and incessant high temperatures, cracking and spalling of the brick work occurs and a costly shutdown for repairs or for an entirely new lining becomes necessary. Too often the man in the small plant who has undergone this experience fails to realize that where high overloads are constantly carried, and remarkable performances obtained, every condition conducive to such records had been secured. The factors essential to this performance are high settings, roomy furnaces, and well designed chimneys and breachings. It is fallacious to believe that the mere application of forced draft will overcome the obstacles of a small unit. The brickwork is certain to fail under these conditions.

Fig. 1 illustrates the result of slag action upon the walls along the clinker line. Every plant should select the lining for this part of the furnace with the utmost care. The brick at this point, while not subjected to particularly high temperatures, must withstand the severe slagging action of the fire. All high grade fire bricks are not adapted to this particular usage. A careful analysis of the fuel used should be made and the exact chemical nature of the slag predicted. The clinker in adhering to the brick is an active fluxing agent, and its action in this respect must be carefully predetermined. The chemical principle involved is that if the slag is basic, the lining should be of a basic substance; whereas, if the slag is acidic, the lining should be acidic brick, such as seventy to eighty-five per cent. silica.

Fig. 2 illustrates a condition with which fire brick men frequently contend. The portion of the wall in the center of the illustration has failed due to the fact that in laying the brick, which was a repair job, a grade of cement was used that was not suited to furnace conditions, or to the brick. The ordinary furnace temperature melted the cement, and caused it to flow over the face of the wall, cutting the brick with which it came in contact. The



Fig. 1.

tening occurs decreases. Thus, the bricks that have successfully met specifications in the laboratory have softened at a comparatively low temperature

cement used in lining should, if possible, be made from the same clay as that of the brick which it secures. It is evident from the photograph that furnace conditions were not severe, otherwise, the remainder of the wall, which was laid with the fire



Fig. 2.

clay mortar containing a high percentage of burnt material, would have failed in the same manner. The cement upon melting flows down the wall, and allows the flame to penetrate into the joints; thus the heat resistance of these bricks is lowered, and the result is failure.

An interesting case is shown in Fig. 3 which depicts the failure of the front wall above the tuyeres of an underfeed stoker installation. This action may be directly traced to an abundance of unused air at this point; the constant blast of excess air along with the scouring action of the hot gases has burnt this brickwork at a temperature of 2400 degrees Fahrenheit. In the absence of the excess air, this failure would not have occurred.

Water is another contributing cause of premature failure in firebrick and tile. There are very few plants today that exercise any precaution to prevent the water used during boiler washing periods from leaking down on the boiler setting below. The result is that water collects on the brickwork, and when the fire is started again, it causes softening of the walls.

All refractory brick deteriorate to a certain extent when subjected to sudden variations in temperature. When a boiler has been carrying a peak load with the brickwork subjected to an intense heat, and the load is then withdrawn and the fire banked, the most severe test to which the brick can be subjected is to allow a full chimney draft to pull cold air through the furnace. The brick undergoes a sudden change in volume with inevitable cracking and spalling.

Carelessly tended fires resulting in bare grates, and varying temperatures also have harmful effects upon the boiler setting. If the fire burns thin, the draft picks up the fine ash and coal particles and deposits them in a layer upon the walls. A few hours later when the peak load comes on, the fire is given careful attention, and of course, the temperature of burning reaches a high point. This high temperature burns the coal and ash is deposited upon the walls. As this slag slowly runs down the brick work, it is absorbed, thus lowering the vitality of the lining.

Silica brick are used to a great extent today for furnace linings. This is due to a combination of properties that seemed to outclass those of any other type of brick that may be economically manufactured. It is true that silica shapes cause trouble due to their tendency to change in volume. This is because cristoballite, the form of silica which is their chief constituent, is subject to sudden expansion when heated to 480 degrees Fahrenheit, and to contraction when cooled below that temperature. The change in volume tends to disintegrate the brick.

A good grade of silica brick will not melt until a temperature of about 3000 degrees Fahrenheit is reached; below their melting point, they will not soften, shrink, or lose their shape to any great extent. Owing to their high rate of conductivity, they may be used for furnace parts where one side of the brick is practically at its melting point. Of course, this side of the brick softens, but the cool side maintains its strength and rigidity, and the wall as a unit remains structurally serviceable. Because silica brick must have a high heat conductivity, free

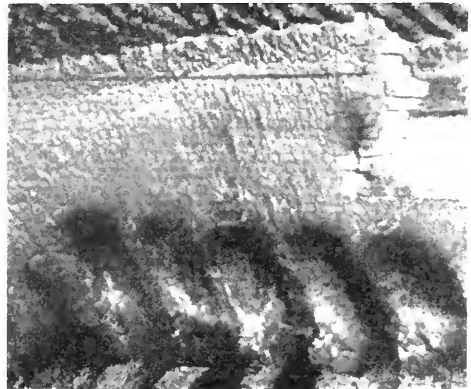

Fig. 3.

radiation must be provided, and they are, therefore, uneconomical from a standpoint of heat losses.  
(Concluded on page 142)

# Colonel Lincoln Bush

By D. C. MURPHY, M.E. '23

The moving on barges, and lowering ten and one-half feet by means of huge sand jacks of a thousand-ton draw bridge within a period of twelve hours in the year nineteen hundred and three, first brought into national prominence one of Illinois' most successful engineers, Doctor Lincoln Bush. This record was attained by a series of steady advancements. Born on a farm in Cook County, Bush received his early education in the country schools, and in the Cook County Normal School from which he was graduated in 1881. After three years of teaching he entered the University. His training in the normal school, and experience as a teacher brought him to the University better prepared than most freshmen. This, coupled with his natural engineering ability, and persistent hard work made him a leader in school. He was a frequent contributor to the *Technograph* which was then the publication of the Civil Engineers' Club. As a student he was never spectacular, but rather a hard worker who went after the fundamentals and mastered them. In conjunction with W. R. Roberts he prepared a thesis on the reliability of the various leading rational column formulas and reached the conclusion that a straight line formula more accurately represented experiments—a conclusion that has now been fully verified by elaborate investigations.

Mr. Bush left the University with the reputation of being able to accomplish results by his careful and thoughtful planning as well as by his natural talent and ability. This reputation has been strengthened by his life's work. The boldness and daring of his engineering feats has always been tempered with caution. He is a man who thinks out every part of his work, leaving nothing to chance, and then has the courage to go ahead and act, even though the task or method has no precedent in engineering accomplishments.

During the first two years out of college, Dr. Bush worked on location and maintenance of way work for the Union Pacific Railroad. Then for two years he was under Dr. E. L. Carthell of Morrison and Carthell, working on bridge design and shop inspection. His connection there, under so able an engineer as Dr. Carthell, showed Bush the broader aspects of engineering and construction, and emphasized the thing which he seemed to already appreciate—that true engineering is handling of affairs and men as much as it is the calculating and developing of the technical problems.

Mr. Bush left Dr. Carthell to become chief drafts-

man of the western office of the Pittsburgh Bridge Company, a position in which he obtained the most valuable experience in bridge design and construction. He then spent six months on masonry design for the bridges on the Chicago Drainage Canal, after which, in 1897, he became Assistant Bridge Engineer and Division Engineer for the Chicago & North Western Railroad.

In 1899, Mr. Bush went East as Bridge Engineer of the Delaware, Lackawanna, and Western Railroad. At that time this road was in such a state of dilapidation as to be almost the joke of the eastern railroads. When, as chief engineer, he left nine years later, the Lackawanna was one of the best built, best equipped, and best managed of railroads in the country. Here Lincoln Bush's natural ability, his university training, his varied early experi-



Col. Lincoln Bush

ences, and his hard constant work had found ample opportunity to assert themselves.

Until 1903 his work consisted of replacement of structures over the entire line, and of detail reconstruction. Here he distinguished himself in bridge designing, and particularly in bridge renewals under heavy traffic. The lowering and moving of the

draw bridge mentioned in the beginning of this article brought Mr. Bush deserved commendation from many sources, and finally resulted in his being officially honored by the University at Commencement in 1904. I will quote President Draper's address on that occasion: "Lincoln Bush:—Your University has asked you to come back, that she might give you a mark of her high commendation. In witness of the University sentiment concerning your substantial character, your steady professional advance, and your notable accomplishments in rail way engineering — accomplishments which have gained the attention of the whole country and won the admiration of engineers in all the world, you are admitted to the degree of Doctor of Engineering and declared to be entitled to the honors and privileges thereof."

The next striking engineering project of Dr. Bush's was the construction of the Hoboken terminal of the Lackawanna. The road enters New York by crossing the river on ferries from Hoboken, so the construction of this terminal presented peculiar difficulties, which were most successfully overcome by Dr. Bush. Reinforced concrete was used for the first time in this class of construction. Here, too, he introduced the "Bush Train Shed" which has now replaced the long high structures formerly employed. These sheds were constructed over a site on which twenty thousand passengers in one hundred trains moved twice a day.

Dr. Bush's greatest engineering feat while in the Lackawanna service was probably that of the location and construction of the "Cut-Off" on the line between Buffalo and New York. This connected the Delaware Water Gap and Lake Hopatcong by a direct line of twenty eight and one-half miles. It crosses semi-mountainous country, and shortens the distance between Buffalo and New York by eleven miles, reducing the train time by twenty minutes. The cost of the Cut-Off is said to have been \$330,000 per mile of double track, and it is conceded to be one of the most stupendous feats in railroad construction. Some of the salient features of the Cut-Off are: the "Pequest Fill", which is the largest railroad embankment in the world, being three miles long with an average height of one hundred ten feet; and two great concrete viaducts, one a magnificent structure across the Delaware, fourteen hundred fifty feet in length, the other over Paulin's Kill, having a length of eleven hundred feet, and a height of one hundred and fifteen feet. The construction of this line is a lasting memorial to Dr. Bush's genius as a railroad location engineer, and a tribute to the absolute confidence which the directors of the railroad must have had in his engineering ability when they authorized the construction of the Cut-Off.

In 1919, before the Cut-Off was finished, Dr. Bush resigned from the Lackawanna, and has since then, with the exception of the war period, been engaged in general consulting engineering practice in New York City. His record as a successful consulting and contracting engineer has been only a continuation of that made while with the railroads. He was president of the company which built the fourteen, ninety-foot span, arch bridge over the Delaware at Yardley, Pennsylvania, chief engineer of the company which built the Martin Creek viaduct, and vice-president and chief engineer of the company which built the noted Tunkhannock viaduct for the Lackawanna.

From January 1918, to March of the following year Dr. Bush was in the service as Associate Officer in Charge of the Engineering Division of the Construction Division of the Quartermaster Corps. This department had charge of five hundred and thirty-five building operations involving an aggregate cost of \$234,000,000. Brigadier General R. C. Marshall, Jr. said: "The record of Colonel Bush is characterized by profound technical attainments, a thorough knowledge of engineering, and the ability for practical application of his attainments to engineering problems of exceptional difficulty. . . . Colonel Bush was indefatigable in his application to duty, sound in his judgment, unrelenting in his zeal, and successful in the achievement of a task of almost unprecedented magnitude."

Perhaps we wonder what quality it is in a man that enables him to achieve such success. Those who know Dr. Bush say that along with his engineering attainments, he is personally very democratic. But something far deeper in his nature, and more necessary than this has probably molded the life of Lincoln Bush. This is brought out in a response which he made to the toast "Progress" at a banquet of the employees of the Hoboken Terminal of the Lackawanna in 1905, and which I quote as follows: "The laws of progress are but a compilation of the unwritten statutes of the Creator. Clearly discernable among these may be noticed the motives, the incentives, and the impelling forces prompting through all life and ages to beneficence.—True, there are dangerous, unblended elements in our national life. True, there are scenes at which the thoughtful man must grieve. But does not history warrant the assertion that there never will be permanent change save for the better? The time is, when infidelity shrivels as the light of modern investigation demonstrates the harmony between scripture and science." Dr. Bush continues, "Nor are we forgetting that divine precept, 'Love one another'. If we win success worthy of note, it will not only be because of a good measure around the

(Concluded on page 149)

# Construction of a Concrete Road

By A. A. STRANE, C.E., '22

The road under construction comprises two sections, aggregating approximately seven miles of level road between Edwardsville and Staunton on the East St. Louis, Springfield trail. The preliminary survey was made in the winter of 1919, and the plans and estimates were completed the following summer under the supervision of Mr. C. M. Slaymaker, District Engineer for the Illinois State Highway Department. Contracts were let in the late summer of 1919 to the H. H. Hall Construction Company of East St. Louis, but because of the shortage of materials and labor during the 1920 construction season, work was not begun until April, 1921.

The engineering features presented no problems of great difficulty. The alignment, with one exception, allowed long tangents and long easy curves. The grades were light, the ruling virtual grade for five hundred feet being 3.1 per cent, and a maximum grade of 1.1 per cent, for seventy-five feet. Two small bridges and several culverts were built. The pavement slab, according to 1919 Illinois State Highway Department Specifications, was built without expansion joints or reinforcement. It was eight inches thick at the center, and seven at the edges, and was laid on a flat subgrade.

The culverts and bridges, amounting to 144 cu. yds. were started during the winter. Because of the small size of the bridges very little equipment was necessary for this work. All of the culverts were completed by July 1, with the exception of the small entrance culverts which span the side ditches at necessary entrances. The latter were not built until after the slab had been put in place, thus making it much easier to transport the necessary materials and equipment. Another advantage to the contractor was that the ditches were more easily dug before the culverts were put in place. The grading work was not started until March 15, 1921 because it was composed of very light earthwork which did not require a great deal of time to settle. Thus traffic was not inconvenienced except during the actual construction period, and a month before and after this time. At the time the grading was begun a camp was established at Worden for the benefit of the laborers.

The earthwork on both sections amounted to 28,000 cu. yds. Most of the dirt was moved by wheelers, loaded by a Cleveland tractor, and pulled by horses. With five wheelers in operation, an average of 270 cu. yds. of earth was moved per day.

The construction of the camp and distributing station was begun March 1, but at first it was used only for a camp for the grading gang. So the actual work of setting up the distributing station was not begun until April 1, when preparations were made for the actual work of construction. The distributing station included machinery for unloading, storing, and reloading all material used in the construction of the road. For the type of equipment to be used, it was necessary to have a derrick for unloading materials, a tunnel for their storing and loading, and storehouses for the cement. Some difficulty was had in digging the tunnel due to the fact that there was scarcely enough fall from the bottom of the tunnel to the flow line of the nearest stream to secure proper drainage. By the fifteenth of May the entire plant was ready for operation, including equipment for unloading and storing materials, as well as for transporting them to the road. An industrial railway was used in transporting the materials from the yard to the road. At the beginning of the work two dinky engines were used on the industrial track.

The proposed plan was for handling the material from the railroad cars to the road was as follows. The aggregate, after being spotted up the private switch, was transferred to the stock pile above the tunnel by means of a sixty foot boom derrick of the stiff leg type. The material was kept moving by keeping the tunnel covered with the material at all times. The roof of the tunnel was provided with traps or chutes so placed that the gravel and sand fell into separate compartments in the batch boxes on the cars in the tunnel. The chutes were easily opened by hand and the material allowed to fall into the batch boxes. The cars were then drawn from the tunnel to the cement sheds by means of a cable on a two drum gasoline hoist. Cement was added by hand in a separate compartment and the boxes were ready to be drawn to the road by means of the small locomotives. At the end of the route was a four bag Kochring paver equipped with a power crane for unloading the boxes into the charging skip. The drawback to the system used in unloading the boxes was that it required four men to turn over a box. The concrete was discharged from the mixer drum and deposited upon the subgrade by means of an automatic dumping basket which ran on a 20 ft. boom. The consistency of the concrete was checked by a small tank upon the mixer which held just the correct amount of water for a four

bag batch of concrete. An automatic timing device warned the mixer operator of the exact second at which the concrete could be discharged from the drum. The concrete was spread by two men, and tamped into place and given a smooth surface by a Lakewood finisher.

The subgrade was brought to a true surface by means of a Lakewood subgrader, which was drawn along the steel forms by a gasoline tractor. The subgrader plowed down the road to the required depth and left the earth in windrows which were removed by a fresno. On this job the subgrade was checked to within 2 per cent., by measuring and computing the weight of aggregate required for the job, and comparing that figure with the actual amount used.

Actual construction was started on May 19th. The first few days were spent in systematizing the work, getting machinery into operation and teaching new men their duties, so that little progress was made. As a result the runs for the first eight days averaged only 255 feet per day. During the next fifteen days the average rose from 255 to 370 ft. per day, and the slab was completed up to the town of Hamel. The haul was growing shorter and the men were becoming more efficient. For the next month the work was carried on very efficiently due to the fact that the haul was short and that no time was lost except by a breakdown at the mixer and through bad weather. The manner in which the work progressed was very gratifying to those in charge. The handling of materials by an industrial railway, and the fact that the subgraders kept well ahead of the mixer, account for the minimum of time lost by muddy subgrade. The maximum record per hour for this period was 54 feet, while the average over the entire period was 43 feet per hour. The difficulties which came up during this period were foreseen far enough in advance to prevent their interference with the program. Several culverts and small bridges required trestles to be built on the outside of the head wall to permit the passage of the industrial track. The source of the water supply had to be changed to the railroad right of way. This change necessitated the use of two miles of surplus pipe. Some difficulty was later experienced because part of the new pipe line was composed of two inch pipe, which was inadequate to carry the amount of water for mixing and curing the concrete and watering the locomotives.

From station 448 to 531, a distance of practically one and one-half miles, an experiment was made with two daily shifts of workmen. At this time another dinky was added to the equipment, because it became impossible to keep the mixer supplied with material. The haul had grown again to

a distance of three miles with several grades which made it impossible to carry full loaded trains as before. To keep things running during the night, it was found necessary to hire additional engine drivers and mixer operators. The introduction of the new men caused such confusion that it soon became evident that the night work would not be a paying proposition. Neither was it conducive to the best results as far as the finish of the pavement was concerned. The lights, for the operation of the mixer during this period of night work, were furnished by a small Deleco plant which had previously been used for lighting the camp. No serious trouble was in evidence as to lighting. The only breakdown which caused the complete shutdown of the work for the twenty-four period occurred during this period of night operation. The average run for the 19 day period was 436 feet, per actual working day, but deducting the time that was lost per day for repairs, the average became nearly 570 feet per day.

After the discontinuance of the night shift, a great deal of attention was paid to methods for developing the highest possible efficiency from the dinkies. An effort was made to keep three dinkies on the road at all times, one train being loaded at the central plant and unloaded at the mixer. This worked so well that during the construction of the next mile an average run of 148 feet per day was made, this being 13 feet higher than the average for the night period, although the haul was one and one-half miles longer.

One half mile from the end of the contract, the road crosses the main line of the Big Four R. R. Because of the danger of collisions on the crossing, it was not deemed advisable by the superintendent to use the industrial railroads beyond this point. Accordingly plans were put into operation whereby the batch boxes were hauled by the industrial dinkies as far north as the Big Four tracks, where they were transferred to wagons by a small derrick. The mixer was moved to the north end of the road and worked south to close up the gap. Although the loaded batch boxes weighed three and one-half tons they were drawn by one team. The 3350 feet were poured in nine days with an average daily run of 372 feet per day.

The advantages of placing a concrete slab by the method just described are that: (1) the aggregate never comes in contact with the earth; (2) the aggregate and cement are easily and accurately proportioned; (3) the subgrade is kept even because it receives no traffic. The main disadvantage in this type of equipment is the inability of small locomotives to carry full loads over steep grades and the consequent loss of efficiency.

# Pottery and How It Is Made

H. F. Barr, cer., '23

Pottery probably originated in Egypt, in the form of fired bricks which have been found thirty feet below the surface of the Nile Valley. From the rate at which silt is being deposited, they must have been made ten thousand years before the Christian Era. Vases have been found which were made 6000 to 5000 B.C., and glazes were first used about 3000 to 1700 B.C. The East Indians very likely learned the art of pottery making from the Assyrians and Chaldeans. The Persians and Phoenicians, and later the Greeks made pottery and similar clay products, and they doubtless initiated the art among the Mediterranean nations, and those of Northern Europe. The Chinese appear to have discovered the principles of ceramics independently, for they made glazed or enamelled earthenware about 2650 B.C. On our own continent the industry was first practiced in Mexico and Central America, and specimens have been found which were made at least 1000 B.C. The manufacture of pottery is now principally a commercial enterprise. Even in the large factories however, it still has much of the fascination and interest of the ancient art.

Many of the raw materials used, such as kaolin, ball clays, whiting, silica, and feldspar are found in deposits in our southern states. Sometimes only one clay is used, but often many are mixed together to increase the color, strength, or working properties. Each type of ceramic product requires a different mix; a factory frequently using several receipts for the same class of work. Each pottery has its own secret receipts, and its products differ from those of any other.

When the clays have been mixed in the correct proportion, they are put through a crushing machine. There are several types of these machines; some consist simply of rollers arranged to pulverize the clay, but the more common machines have

movable steel jaws that are actuated by eccentric wheels.

The clay is then taken from the crushing machine to huge vats in which it is mixed with water. Agitators, which resemble huge ice cream freezers, constantly mix the clay and water until a homogeneous fluid results. This fluid passes through an outlet in the bottom of the vat and flows into a trough containing a powerful electromagnet which

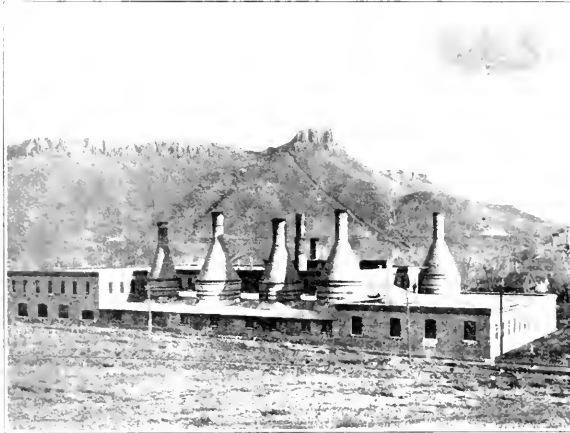

Pottery Kilns

serves to draw out the particles of iron that were originally in the clay or that were worn from the machinery. These particles must be removed if a pure, uniformly colored product is required. Iron in the mixture will usually cause the clay to become red when burned, due to the oxidation of iron to its ferric form. From the trough the liquid passes

through sieves of lawn or copper which have eighty to one hundred meshes to the inch. The fine clay slip strains through to a cistern from which it is pumped as needed to a filter press where practically all water is squeezed out. The capacity of these presses is often more than a ton of clapper charge. The clay is then taken to the pugging machines, which consist of an auger in a cylinder. As the clay is cut and mixed, the air is worked out of the mixture, making it more plastic. The charge is forced out of the machine in the form of a ribbon or roll which is usually eighteen inches in diameter, and is then cut into sticks about two feet long.

The long and tedious process described above is the same for all methods of manufacture, but from this point, the treatment of the clay is varied according to the type of pottery into which it is to be made. First, we shall consider the pottery that is made in moulds. The moulds are usually made of plaster of paris, although metal or other substances are sometimes used. The mould is made in sections, and is fitted together so that irregular pieces of





When the deposit has become of sufficient thickness, the remaining liquid slip in the center is poured out, the layer of clay remaining on the wall. The clay soon dries to the hardness of leather, and is then removed, trimmed and finished.

Some pieces are too complicated to make in one operation. The parts must be made separately and stuck together to form the whole. While the ware is still "green" or unburned, handles and spouts are glued on, the glue being simply some of the slip used in casting. "Sticking up" is delicate work, as the pieces must be equally hard and retain their shape, yet they must be sticky. The relative thickness of the parts must be considered, for in drying, a thin piece will shrink faster than a thick one, and unless special precaution is taken, cracking will result. If the workmanship is good, the junction, which is welded during the firing, will be as strong as any other portion of the piece.

Some pottery is made without moulds by being "thrown" on revolving horizontal disks. This is the oldest and most fascinating method of manufacture, but it is fast becoming a novelty. It lacks the speed of production of the moulding methods and requires a high degree of skill on the part of the operator. A lump of plastic clay is thrown upon the rotating disk, and the potter forms the piece with his hands and a few simple tools. He wets his hands and presses the clay into a mound in the center of the disk; then by raising his hands and delicately adjusting the pressure he can press out any shape from a round, flat bowl to a high, thin vase. This appears to be very easy, but it requires ability and practice to make even the most simple piece. After the shape is thrown, it also must be finished.

The ware is thoroughly dried after finishing and is then placed in saggars. These are merely refractory boxes of various sizes made of fire clay and grog, which is a mixture of burned fire clay and sand. The saggars, which are piled in the kiln, keep the weight off the ware in the bottom of the piles. Before it is burned, pottery cracks and crumbles very easily.

The kilns used for pottery burning are of the round updraft type. They measure about ten to twenty-five feet in diameter and are surrounded by fireboxes or ovens. The fireboxes open directly into the flames and gases. The saggars are piled one on top of the other and keep the dirty combustion gases from discoloring the ware. The fuel used is coal, gas, or oil. The ware is heated until it is white hot which occurs at a temperature of higher than 2000 degrees Fahrenheit. When the exact maturing temperature is reached, the fires are removed. If the kiln is coal fired, the "drawing fire" as it is called, is the most disagreeable job in the

plant. The men use iron rakes to pull the fires out of the pits when the kiln is at its highest temperature. The kiln is allowed to cool for several days, then the bricks used to seal the doorway are knocked out and the saggars removed and emptied.

In the next step of the process of manufacture glazes are applied of which there are many forms, such as: salt, resin, borax, and lead glazes. The salt glaze is applied by throwing salt into the firebox when the kiln is at its maximum temperature. The fumes of the salt serve to color and glaze the ware. The resin glaze was used principally by the Indians, and it was a composition made chiefly from the sap of certain trees which served to make the pottery watertight. If it were not for such a glaze, water would penetrate just as it does a flower pot.

Borax and lead glazes are now in greatest use, particularly for art pottery. The glaze is very similar to a colored or colorless glass burned on the pottery. It is composed chiefly of silica, lead, or borax, and coloring oxides ground finely together into a frit or a slip. The glaze at this stage looks much different than it does after the ware is completed; it is not the same color, and the surface is powdery and rough, resembling a thick coat of soft paint.

Probably the most important, and, perhaps, the most difficult work for the ceramicist in pottery, is the search for new colors and effects, and the making of a glaze to fit the body. The glaze must mature at a temperature suitable to the clay, must have the same coefficient of expansion, must not burn or run, and must give the desired color and tone. It is a difficult task to meet all of these requirements. Regarding the colors, cobalt compounds usually produce blue, copper, green or yellow, manganese, pink, uranium, yellow and chromium, green.

The glazes may be either painted on the ware, or the ware is dipped in the glaze and burned again. Some "one fire" ware is made, but this is used only in the cheaper grades. In this method, the glaze is put on the green ware and given only one firing; the glaze and ware being burned both at the same time. Most glazes are put on, however, after the ware has had one firing. The underglaze is dull and seldom pleasing. When a transparent glaze is then fired over the first, a beautiful product results. Much underglaze slip painting is done by placing the designs on the first raw glaze; the transparent glaze being applied afterward. This work requires a skilled painter, because the colors are not true before firing, and a mistake means a discarded piece.

The mottled and irregularly colored pottery so often seen is made by dipping or painting the ware evenly with a raw glaze and then when placed in

(Continued on page 144)

# Articles Worth Reading

As a means of stimulating the students in engineering to read more widely and more intelligently, and at the same time realizing the limited amount of time the student can devote to reading, The Technograph has instituted this column of "Articles Worth Reading".

The selection of the articles took place after careful study so as to get a well balanced list. Different engineering professors and Dean Littleton of the College of Commerce submitted lists of recommended articles, and after reading these, the editorial staff chose for publication the following list. We believe that any article in the list will be of real interest to any engineering student, and we know that, excepting two technical articles, the average student can understand them. The technical list is not quite as representative of the different departments as we would desire, as we experienced difficulty in getting articles which were interesting and yet not too technical for the average Junior. As the list stands we can recommend it for the reading of the underclassmen, and we point out to them that here is a means of finding out just what is the nature of their professional work.

## *Non Technical*

1. "The Ethics of the Financial World", in Stone and Webster Journal, Sept. 1921, in Main Library.
2. "The Engineers Relationship to the Executive", in Management Engineering, Nov. 1921.
3. "The Iron Man and the Mind", in Atlantic Monthly, Feb. 1922.
4. "Our Common Enterprise", in Atlantic Monthly, Feb. 1922.
5. "Science and Religion", by Charles P. Steinmetz, in Harpers Magazine, Feb. 1922.

6. "The Man Factor in Industry", in Industrial Management, Nov. 1921.
7. "What is Europe to Us—An Address by an Engineer", in Journal of Engineers Club of St. Louis, Apr. and May, 1921.
8. "Bosses I Have Met", in The Nations Business, Jan. 1922.
9. "How I Use the Business Cycle", in the Nations Business, Feb. 1922.
10. "If I Ran the Railroads—Henry Ford—and a Reply by a Railroad President", in the Nations Business, Nov. 1921.

## *Technical*

1. "The Rising Importance of The Oil Injection Type of Internal Combustion Engine", in Mechanical Engineering, Oct. 1921.
2. "Economic Aspect of Railway Electrification", in General Electric Review, May 1921.
3. "Lakeside Plant Pulverized Fuel Tests", in Mechanical Engineering, Oct. 1921.
4. "Super Power Report", in Engineering News Record, Nov. 10, 1921.
5. "Architectural Design by Use of a Module", in Architecture, Oct. 1921.
6. "Steam Condensing Plants", in Mechanical Engineering, Nov. 1921.
7. "The Land Question as Related to City Planning and Housing", in American Institute of Architects Journal, Oct. 1921.
8. "Foundation Work and Truss Design for the Bismark-Madan Bridge" in Engineering News Record, Feb. 2, 1922.
9. "Developments in Power Station Design", in The Engineer, Dec. 30, 1921.
10. "The Motor Truck Impact Tests of the Bureau of Public Roads", in Public Roads, Dec. 1921.

# Synchronous Converters

By R. C. GROEGER, e.e., '22

In the present day development of large central station power installations, it may safely be estimated that ninety per cent of the total output of power companies for commercial distribution is alternating current. Many classes of electrical apparatus such as motion picture arcs, storage batteries, cranes, elevators, and in general various types of variable speed machinery still require direct current for effective and efficient operation. In

all battery charging work it is necessary to have a supply of direct current, while in the motion picture projector, using the arc for illumination, direct current is very desirable, if not altogether essential. Consequently, many methods have been utilized to convert or rectify the alternating current supply to direct current.

Among the various methods of rectifying alter-

(Continued on page 134)



# EDITORIAL

## THE TECHNOGRAPH STAFF

Donald A. Monro '22

F. W. Hartman '23

M. E. Janson '23

D. C. Murphy '23

P. F. Witte '23

L. E. Valentine '22

P. T. Dehman '22

C. H. Dodge '23

I. L. Vendg '23

L. R. Ludwig '23

Editor

Walter A. Mueller '22

Assistant Editor

W. J. Klingberg '22

Assistant Editor

W. B. Mathews '22

Assistant Editor

H. C. Harmsling '22

Assistant Editor

W. R. Enyart '23

Art Editor

C. Bowen '23

Once Over Editor

E. V. Gauger '23

A. B. Durham '22

C. T. Parker '23

E. L. Goble '23

G. T. Dingley '23

W. E. Gerdes '23

J. L. Dieus '25

Business Manager

Circulation Manager

National Advertising

Local Advertising

Assistant Business Manager

Assistant Business Manager

H. L. Funk '23

R. E. Gould '23

R. L. Hedrich '23

J. B. Clausen '24

## DEPARTMENTAL REPRESENTATIVES

H. W. Butterbaugh

C. C. Connell

H. S. Goss

W. A. Gortler

A. A. E.

Architecture

Ceramics

Civil

D. B. Collins

G. Reed

D. P. Buchanan

J. V. Schaefer Jr.

S. M. Eblman

Railway

Electrical

Mechanical

Mining

Municipal and Sanitary

## ARTHUR J. INGOLD, JR.

It was with a profound sense of sorrow, that we learned of the death of Arthur J. Ingold Jr., a member of the senior class in mechanical engineering. In his death, Illinois lost one of her most promising students, and the Technograph was deprived of a worthy successor to the former editors. During his three and one half years of undergraduate life, he took an active part in campus activities, giving to them without reserve his time, strength, and energy. He was pledged to Pi Delta Epsilon, honorary journalistic fraternity, and was a member of A.A.E. and A.S.M.E., engineering societies, Pi Tau Sigma and Sigma Tau, honorary engineering fraternities, and the engineering council. In recognition of his ability as a leader, he was appointed to serve on the 1922 Homecoming Publicity committee, and to act as Out of State Chairman for the Stadium Plus Drive. The success which greeted his undertakings in these activities merited him honor and recognition from students and faculty alike.

He possessed those characteristics of ability, initiative, perseverance, and dependability which are found only in the best. Being gifted with a keen and active mind, clear judgment, and great ambition, his life after graduation could have brought only honor to his Alma Mater. To express in some degree the high regard in which he was held, we, therefore, suggest that it is most fitting that Illinois bestow upon him a posthumous degree of B.S. in Mechanical Engineering.

It is with a deep sense of personal loss that we write this expression of our respect and appreciation of one who was loyal to his University, and a genial and sympathetic friend. We unite with his large group of friends to extend our sympathy to his family in their bereavement.

## NEW COURSE FOR ENGINEERING CURRICULUM

Unless indications are all wrong, a course in engineering journalism would be appreciated by many students in the College of Engineering. To find a place for it in the already crowded engineering curriculum, the course could be most conveniently offered as a non-technical elective. It would embody practice in the writing of articles for engineering publications, drill in the preparation of engineering reports, and training in the handling of engineering correspondence. Doubtless this course would become popular, especially among those students who appreciate the value of training in the use of good

English. In the preparation of articles on widely varying subjects, the student should become acquainted with many phases of engineering activity which otherwise would remain closed to him. If properly administered the course has the opportunity of doing much in overcoming that frequently repeated criticism that engineers are of narrow mental scope and self-centered. The chief value of this course to the student would lie in the fact that it would broaden his perspective, and reveal to him the advantages afforded by each of the specialized fields of engineering endeavor. The course would be entirely justified should it accomplish no more than to broaden the education of men who aspire to leadership in the engineering and business world.

We propose this course with the hope that many of the articles which would be written could be published in the Technograph. The Technograph is published by the students of the College of Engineering, and should be a representative exhibition of the high standard of work which is maintained in the class room. Many employers and practicing engineers, who have never seen the University of Illinois, judge the College of Engineering by the Technograph. Therefore every effort should be exerted to improve the Technograph, and to place it more than ever before in the forefront of the publications of the technical schools of the country.

---

## DEAN RICHARDS

The recent unexpected announcement of Dean Richards' intention to terminate his administration as Dean of the College of Engineering, in which capacity he has served for the last five years, has been met on all sides by expressions of regret from faculty and students alike. Under his direction during this brief period the College of Engineering has attained a prominent position among the leading technical schools in the country; and the Engineering Experiment Station has shown even greater development. The extent and value of the research work done here in recent years has been exceeded by only the work of the Bureau of Standards maintained by the Government. This is a direct result of Dean Richards' promotion of cooperative research, which is investigation for which the expense is partly borne by the industry or concern that will benefit most by the conclusions that are reached. The present investigation of the fatigue of metals, which promises to become more extensive and complete than the famous experiments made by Wohler from 1859 to 1870, and the investigation of the ventilating problems of the Hudson River vehicular tunnel are two projects of more than national interest which Dean Richards has recently brought to the University.

But there are many, who, while feeling keenly the material loss to the College, experience the deeper emotion associated with the departure of a friend or esteemed acquaintance. These persons are not confined to members of the faculty, or to friends of long acquaintance, for Dean Richards' personality is immediately discerned. His friendliness, his willingness to listen to your story, his sympathy and his interest in your problems have gained him the respect and friendship of all the students that know him. It is very unfortunate that the duties of Dean and the responsibilities of the Experiment Station prevent many students from having the pleasure of knowing Dean Richards, and of observing the sterling qualities becoming an engineer and an executive.

---

## RATING INSTRUCTORS

Sigma Tau, an honorary engineering fraternity, has aroused considerable interest by the announcement of their intention of making up a rating of engineering instructors which is to be based on the opinions of members who have received instruction from these men. There comes from the lips of Dean Richards information to the effect that faculty ratings intended to be used as a measure of ability have been attempted several times in the past by men who have occupied prominent positions on the teaching staff of the University of Illinois, and in no instance were satisfactory results obtained. In one of these attempts, a letter was sent to the Dean of the College of Engineering at the University of Virginia asking for his idea how the rating could be successfully made. The reply stated that although he had spent nearly all of his teaching days looking for some satisfactory way of measuring the effectiveness of his teaching staff, he had not as yet found a usable one.

Just who are these Sigma Taus, that they should think that they can pass judgment upon men

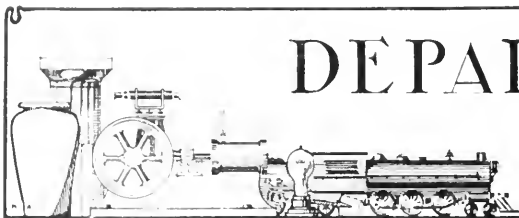

# DEPARTMENTAL NOTES

## A. A. E. News

On December 13, 1921, Professor Robinson of the Economics Department gave a talk on "Safe Investments". He pointed out that an engineer was often weak in the field of investments. The discussion which followed the talk was evidence that it was appreciated by those present.

On January 10, 1922, Dean H. C. Jones, of the College of Law, gave a talk in which he pointed out how closely engineering was related to law. To explain his point he discussed somewhat in detail the subject of Contracts. He showed how, in every line of engineering, the question of a contract would arise. It does not matter how unimportant the work, there is always some kind of a contract involved; it may be only a verbal contract, or it may be a written one. Dean Jones showed where, and why, a contract in writing was better. He closed by saying that many benefits could be derived by studying a few courses in law. A short discussion followed in which some of the minor points of contracts were set forth.

The national organization of A.A.E. is working upon the problem of employment for the men of the Association. Plans are well under way for organizing an employment bureau in each chapter. It will be a great help and benefit to the students at the University of Illinois who will be looking for work. It has been found that the bureau at the main offices cannot be wide enough in its scope to reach all the men that could be benefited by a such a bureau. Plans are well under way for such an advancement here and by the time the second semester is over it is expected to be able to help those students who wish employment for the summer months. Not only will the A.A.E. be better fitted to help the undergraduate when he needs employment, but it will also be in a position to aid the graduates in securing the kind of work that they are best fitted for.

The lectures that are given from time to time before A.A.E. point out some of the non-technical aspects of engineering. An engineer not only needs to know about investments and contracts, but he must be able to judge the people with whom he makes them. A student in a university may not be

so well equipped to do this, but he can at least start while at college. This sort of training comes from experience and contact with people. An undergraduate may, or may not, have had opportunities for this sort of training, but he may increase his knowledge through meeting with the professional men, who appear before A.A.E.

## Architectural News

The Architectural Society held its most interesting meeting of the first semester January 19th, in Ricker Library of Architecture. The officers of the Society were fortunate in obtaining Alfred H. Granger, famous Chicago architect and engineer, as the speaker. Mr. Granger, who conducted the seniors of the department through the Northwestern Railway Station on the inspection trip, has made a specialty of railway station design and his illustrated paper on that subject was indeed interesting. While discussing railway station design, Mr. Granger spoke very highly of Alfred Fellheimer '95, whom he considered the foremost station designer in America. Mr. Fellheimer, now located in New York, was trained in the office of Mr. Granger. The illustrated lecture was followed by an informal discussion. Mr. Granger spoke of the qualifications which the real architect expects to find in the college graduate. He listed a trained, intelligent mind, an appreciation of architecture as an art and a profession, and a willingness for self-sacrifice—these he said were the essentials demanded of a young designer, or draftsman entering an office. In the afternoon, members of the Society conducted the Chicago architect on an inspection tour about the University. A dinner party at the Green Tea Pot by faculty members and the seniors of the department in honor of Mr. Granger proved a very pleasant feature of the evening.

The December number of The Scarab Bulletin, official publication of Scarab Fraternity, came from the press just after the holidays, and is now in the hands of all active and alumni members. The different chapters of the Fraternity, in the order of their installation, are in charge of the publication

of the Bulletin for one year. The local Temple, Karnak, is now conducting the publication.

Professor William C. Titcomb in a very interesting article suggests the establishment of a Scarab Traveling Fellowship. The Scarab competitions have been so successful, and are now so well established as a feature of architectural undergraduate life, that the Fellowship idea seems very possible as a near future Scarab development.

The regular January meeting of Scarab was held Thursday evening the 19th, at the Triangle House. Professors C. E. Palmer and C. R. McAnlis, and George E. Wright '12 from the office of the Supervising Architect, were the speakers of the evening.

The first meeting of the second semester will be an open meeting in The Ricker Library of Architecture. Mr. Chance Hill, former head of the Department of Landscape Architecture at the University of Illinois, will give an illustrated lecture on "Landscape Gardening And Its Relation To Architecture".

Scarab is planning a traveling exhibition of work done at schools where there are Temples of Scarab. Representative work from the departments of each school will be collected and sent from school to school where it will be exhibited for a definite period of time. This will permit the student bodies in the different parts of the country to compare the work done at the various architectural schools.

The regular meeting of Gargoyle was held at the Delta Phi house, December 15th, following a dinner at six arranged by Mr. O. E. Brunkow. "Legal Problems of the Architect and Engineer", presented by Mr. A. Bruce Butler, A.E. '21, proved a very interesting paper. During the open discussion period following the paper, Professor N. I. Crandall and Professor C. E. Palmer cited many personal experiences and observed cases which illustrated the points of Mr. Butler's paper.

Mr. Prentice Duell, of the Department of Architecture, has written a series of articles, "Missions of Sonora", which have been appearing in "The Architect and Engineer", a Pacific coast magazine. The last of this series on the Arizona-Sonora chain of missions appeared in the December number of the magazine. Four important missions in northern Mexico are described and illustrated with photographs and drawings by the author.

A collection of student drawings from Carnegie Institute of Technology was received by the department of architecture and put on display January 28th, in the fourth floor corridor of Engineering Hall. The exhibition included 27 drawings in india ink, water color, and charcoal representing all

classes of work. A feature of the collection was the 1921 prize winning design for the Stewartson fellowship. The Stewartson fellowship, like the Plym fellowship, entitles the winner to a year of travel in Europe, but is open only to students in the state of Pennsylvania.

## Civil Engineering News

The last meeting of the A.S.C.E. Student Chapter was featured with an interesting talk by R. C. Cone, c.e. '22, who spoke on his experiences on road construction work in Wyoming. He took up in detail the construction of small bridges, and the execution of contracts. The topic for the evening, which was "Highway Bridge Construction in Wyoming", covered a great variety of problems that confront the engineer in the field. Generally, the civil engineering student has the idea that the average engineer steps right out of school into a well organized construction company where all that he has to do is to see that the right material is used, and that the specifications are conformed to, but in actual practice this is not the case. Mr. Cone pointed out some of the difficulties that the engineer must meet and conquer. An interesting example of one of these problems was clearly explained; that of setting abutments for a highway bridge upon a quicksand bottom. After many fruitless attempts to build cofferdams and to sink caissons, the foundations were finally set upon I-beams that had been driven through the quicksand. The solution for such practical problems as these cannot be found in text books, and consequently, the only way to gain experience is to get a job and keep both ears and eyes open. Following the discussion nominations of officers for the second semester were held.

The A.S.C.E. has completed a very successful semester with A. L. S. Sanders as presiding officer, who had the assistance and cooperation of the officers and members of the organization.

The Civil Engineering Department is carrying on an investigation in three lines, under the supervision of Professor Wilson. The reinforced concrete arch, which has been subjected to bending during the past year and a half, has been tested to destruction. The work of comparing measured stresses with computed stresses is well underway, and it is hoped that this part of the work will be completed during this semester. In conjunction with the investigation, measurements are being taken of two rocky gorges at Turkey Run, Indiana, to determine whether there are any seasonal changes that would effect the stresses in any arch, provided it were built across the gorge. The detailed work is being done

by E. E. Michaels, Research Fellow in Civil Engineering.

Investigation has been started on the eighteen by twenty four foot slab of concrete which was constructed to determine the magnitude and causes of the warping of concrete road slabs. It is a matter of observation that the surface of a concrete slab is constantly changing. A slab may bear upon an entire area part of the time, then at other times it is so warped as to be in contact with the earth only along its middle or its edges. Apparatus has been installed to indicate the temperatures and vertical movements of the slab at different points, and the soil pressures acting on the slab at various points. Data is now being collected for changes in climatic conditions, and, later, observations will be made when the slab is subjected to a load. The detail work is being done by Mr. K. Schapiro.

A mathematical investigation has been made to determine the stresses in statically indeterminate, rigid frames that are subjected to various loads. This is an extension of the work presented in Bulletin 108, by Professor M. Wilson, F. E. Richards, and Camillo Weiss. These results differ from those given in the bulletin, in that, in the latter the general equations were derived that are applicable to any systems of loading; whereas the present work gives the equations for the particular systems of loading. The work in Bulletin 108 is more of a basic character and is used in obtaining equations such as the designer wants. In the latter work, the equations have been presented ready for the use of the designer.

## Ceramic News

The meetings of the student branch of the American Ceramic Society, since the general smoker, have been confined mainly to informal discussions, routine business, and considerations of programs. As a result of the program committee's activities, an unusually good list of speakers has been secured for the remainder of the year. On February 9th, Professor Hursh gave an illustrated lecture on kilns. On February 23rd, Dr. K. Endell, instructor in the Technical High School of Berlin, Germany, will address the student branch. His talk will undoubtedly be interesting and a large audience is expected. On March 9th, Mr. Navias will talk on "Apparatus Used in the Determination of Specific Heat of Clays". The meeting of May 11th, will be devoted to a discussion of "Thesis Subjects and Results".

The entire Ceramic Engineering faculty will attend the Twenty Fourth Annual Convention of the American Ceramic Society. Doctor Washburn and

Prof. Parmelee will present papers at the convention which is to be held in St. Louis from February 27th to March 1th inclusive. Several seniors contemplate making the trip.

An addition to the department staff was made on January 1st, by engaging Mr. Robert Doyle, as assistant potter. Mr. Doyle comes here from Cambridge, Ohio, where he has specialized in the manufacture of high fire hotel china. He has had eight years of pottery experience, and for two years has been superintendent of an eleven-kiln pottery plant. R. E. Lawrence '22, has been engaged as part-time research assistant. He is engaged at the present time in studying methods of testing hardness of ceramic bodies as assistant to Dr. Washburn.

## Ceramic's Short Course

Probably never before has the actual practical value of the application of science to common clay working problems been so clearly demonstrated as at the last Short Course given by the Department of Ceramic Engineering. This was held in the Ceramic building from January 23rd to February 4th inclusive. The course was planned to meet the requirements of practical men, and the principles dealt with were those underlying the work of managers, superintendents, burners, foremen, and others who might be concerned with the manufacture of ceramic products. A common school education was a sufficient prerequisite for the work. No fees were required, only a contribution of one dollar towards the expense of printing leaflets, used in certain courses, was necessary. The instruction consisted, principally, of lectures, with some laboratory work, such as practice in kiln firing and testing of clay samples brought by the men. Supplementary to this were the discussions between the men and the personal advice and instruction given to all those who presented problems.

The number of men in attendance reached a total of seventy-two before the second week had begun. There were nineteen from Illinois, thirteen from Indiana, seven from the B. Wiffin Hood Co. in Georgia, six from Ohio, four from Iowa, four from Canada, two from California, and the remainder from thirteen other scattered states. Most of the men were from brick plants and potteries in Iowa, Ohio, Indiana, and Illinois.

The course was under the direction of Dr. E. W. Washburn, head of the Department, who gave the lectures on the Physics and Chemistry of Ceramic Materials and Processes. These lectures were presented in a remarkably clear manner, so no doubt could possibly be left in the minds of those in his audience as to the subject matter. This meth-



od was used by all of the lecturers, whenever possible, and as a result little trouble was encountered.

Prof. Parmelee gave several lectures on the origin and classification of clays, their prospecting and sampling, their properties and methods of testing, the processes used in shaping wares, such as the construction of molds, jiggering, turning, pressing and casting, and the different types of refractories and their applications. Prof. Hursh lectured on the winning of clays which deals with the mechanical equipment and the methods of excavation, dies, drying, and dryer control, pyrometers, burning methods, and the principles involved, and kilns and kiln construction. From outside the department, Dean Richards spoke on "Gas Producers", Professor Harker on "Business Law", Professor Drucker on "Explosives", Professor Stock on "Steam Shovel Methods", Professor Parr on "Coal", Professor Kratz on "Steam Engines and Boilers", Professor Budwell on "Boiler Water", Professor Paine on "Dynamos and Motors", Mr. Radebaugh on "Equipment Control", Mr. Benedict on "Maximum Production from Equipment", Professor Porter on "Readings from Drawings", Mr. Hostetter, Manager of the Steuben Division of the Corning Glass Works, on "Glass Technology", and Professor Binns, Director of the New York State School of Clay Working and Ceramics, on "Bodies and Glazes". Thus it can be seen that almost every phase of the Ceramic field was covered, and probably by the best authorities available today.

Several of the men brought clays with them, which they tested according to the laboratory specifications for fineness of grain, strength, burning conduct, fusibility, and soluble sulphates. This work occupied the greater part of the afternoons of the first week.

A very interesting feature was the number of informal gatherings and discussions between the men, who came from widely separated parts of the country, on their various problems. At times, the corridors of the building resembled the lobby of a convention. Advice was asked of the faculty on all kinds of problems and troubles, and free consultation service was maintained. The Department is to be congratulated upon the success of the undertaking.

## Electrical Engineering News

At the Electrical Engineering Society meeting of December 2nd, interesting talks were given by two of the members on commercial radio operation, and on freak connections in building wiring about the campus. J. E. Aiken described his summer's experiences as a radio operator on excursion steamers

on the Great Lakes, and Leo Shapiro explained certain novel methods employed by local electricians in wiring University buildings.

An election of officers for the ensuing semester was held at the last meeting of the Society, which resulted in the following men being elected: President, Vallier; Vice-President, Agnew; Treasurer, Howie; and Secretary, Crandall. Stunts were assigned for the coming Electrical Show, and plans were laid for a "feed" to be held the first Friday of the new semester.

Professor Waldo is in the midst of some experiments on transformers to determine the different effects that various kinds of paint have on radiation and heat losses. These paints are to be used in coating transformers, motors, and similar electric apparatus. Several students are running tests in wave analysis to determine the shape of magnetizing curves in transformers. Dr. C. T. Kuipp and Prof. H. H. Brown, during the past year, have been noting the influence of gases on vacuum tubes and are continuing these experiments this year. An abstract of this work was published in the January Physics Review. Prof. J. T. Tykociner has been engaged for the past six months in radio research at the University. He is working on the applications of high frequency currents to acoustical phenomena. The results have been satisfactory and the department expects to announce the success of his work in the near future.

A Universal wave meter, with range of eighty to twenty four thousand meters, power generator vacuum tubes, and Kenetron rectifier tubes have been recently installed in the radio laboratory. A two hundred volt, vacuum tube, radio phone is nearing completion, and when finished will be used to broadcast the University Band Concerts, beginning with the concert on March 3rd. At present there are two sets, one made at the University and one made by Westinghouse, for receiving these concerts; both have been in use during the past semester.

The Electrical Engineering Department is keyed up to high tension and many of its students and faculty members are putting in hours of overtime preparation for the second, bi-annual electric show which is to be held from April 20th to 22nd. Numerous and unique are the stunts, freaks, and mysteries being developed and the electrical geniuses of the department promise an even larger array of events than were presented in the past show.

The new Tesla Coil, being built for the present show, will give a spark almost nine feet long. The new coil is ten and one-half feet long and holds eighteen hundred turns of wire on the secondary winding. Eleven hundred volts will be impressed on the primary of the transformer, giving twenty

five thousand volts in the secondary, and by using a special glass condenser, the resulting spark will be caused by a potential drop of several million volts. The traveling sign on the elevated at Dearborn Street, Chicago, will be rivaled by one now being constructed; come and see your favorite professor in print. The latest design of Automatic telephones will be demonstrated and explained. Also the various systems of railroad block signals will be displayed in miniature. A model hydro-electric plant, complete even to its miniature mountain reservoir, will be there to interest the undergraduate financiers. Those who have doubts of their anatomic structure will be satisfied by the X ray machine which will be one of the many attractions. The oscillograph will also be there to denote the strength of the voice by picturing the wave lengths of the operator's voice. The ancient mystery of the "ever flowing bottle" will again await explanation, and for the more scientifically inclined, the perpetual motion machine, as well as the "ever spinning penny" will afford much subject matter for speculation. Included in the freak stunts are: the aurora borealis which will appear without source of power, the talking skull, found at Monk's Mound, the Oniji board for the more frivolous, the frying pan which fries eggs on ice, and the haunted violin, another modern mystery.

## Mechanical Engineering News

Mr. G. E. Moore of the Johns-Manville Co. delivered a very instructive lecture on the manufacture of asbestos before the A.S.M.E. December 8th. Mr. Moore's address, which was illustrated by motion pictures, presented a very comprehensive view of the production of asbestos. The sources of most this material on our continent are Arizona and Quebec, Canada. The grade of asbestos mined in Arizona is very high, but the deposits are small and hardly worth extensive exploitation, while the Quebec quarries, at present, produce 85 per cent of the world's output and seem to contain an inexhaustible supply.

The term "asbestos" means a group of minerals of fibrous crystalline structure. This substance is entirely different from other minerals due to the fine, silky, elastic fibre that may be carded, spun, and woven similar to wool or silk. Owing to this paradoxical property the mineral has been termed the "mineralogical vegetable". Asbestos, which is a hydrated silicate of magnesium, is divided into two general classes for usage; short fibre, and long fibre. Short fibres due to their non-conductive property are used for steam pipe packing, asbestos slate, and asbestos wood, which is a recent application for switch board and electric insulation work. The less

abundant long fibres are used in goods requiring spinning and weaving.

The A.S.M.E. held a special meeting January 16th for the election of officers for the ensuing year. The following men were elected to carry on the excellent work of retiring President Rosendale and his staff: President, E. J. Bohnen; Vice-President, P. F. Witte; Secretary, P. Moody; and Treasurer, W. Enyart.

Two eight hour tests have been recently run on the Heine water tube boiler in the Power Laboratory. Students in M.E.65 conducted the tests, and a very accurate analysis was made of all operating conditions. Data was taken on temperature of breeching and economizer gas, fuel gas analysis, weight of water evaporated, weight of coal fired, quality of steam, and feed water temperature to determine the efficiency of the economizer, and the boiler.

Mr. F. K. Sekely, formerly Chief Engineer of the Pierce Arrow Motor Company, gave a lecture on Automobile Engineering before a recent meeting of the A.S.M.E. After the talk, a very interesting discussion was held, in which Mr. Sekely discussed at length the points of the front drive automobile, and the steam automobile.

## Municipal and Sanitary Engineering News

At the meeting of the Illinois Master Plumbers Association held in Champaign in January, Prof. H. E. Babbitt gave a paper on the plumbing experiment that has been conducted in the power house tower. This experiment consists of a complete plumbing outfit for a five story building in which the proper size of soil stacks is determined experimentally. The Association voted to finance the continuation of this experiment. The Association also appointed a committee to arrange a short course in plumbing to be given at the University next year.

It has been decided to erect a model sewage treatment plant here on the campus. The site chosen is at Harry St. and the Boneyard. The State Water Survey in cooperation with Prof. H. E. Babbitt is designing the plant. It will probably be erected next spring.

The Mu San fraternity, professional fraternity for Municipal and Sanitary Engineers, has arranged a program of speakers for the second semester. On February 23, Mr. Holmes will speak on the construction of the dam now in process of erection at Decatur, Ill. of which he is Chief Engineer. Mr. Gurber of Clay Products Company, Chicago, Ill., will speak on "The Making of Sewer Pipe" on March 9. On April 20, moving pictures will be shown on the treatment of sewage in Chicago.

## Mining Engineering News

Although there was no meeting of the Mining Society last month because of examinations, the meetings of last semester were successful because the students are constantly taking more interest in the Society. The program of speakers during the semester was well balanced, and served as an inspiration to all the members of the Society.

Word has been received by Prof. Stock from R. L. Dimmick, superintendent of the Katherine gold mine at Kingman, Arizona, of the death of Leonard Whitney, '17. He was employed as assistant superintendent of the Katherine Mine and was, at the time of his death, superintending the installation of a 200 h.p. engine. The engine had been running for barely fifteen minutes and had not as yet been allowed to run at full speed when it suddenly left the frame. A fragment from the 18,000 pound flywheel struck Mr. Whitney in the head, killing him instantly.

Prof. Stock and Prof. Drucker have received interesting letters from Harry Wilten, '21, who is assistant mining engineer with the Union Miniere du Haut Katanga at La Panda, Belgian Congo, Africa. Wilten's trip to the Congo was as exciting as it was interesting. His ship took fire off the west coast of Africa, causing great excitement and anxiety among the passengers. On his way to the Congo he visited the Victoria falls in central Africa and the famous Kimberly diamond mines. He is at present carrying on research investigations dealing with the processes of copper extraction. The extensive copper mines where he is working are owned by Belgians, but are managed chiefly by American engineers. This is another of the many instances in which Europeans have recognized the superiority of Americans in engineering. There are some 5000 native workers at La Panda, the town in which Wilten is living, and 250 whites. Malaria and typhoid are prevalent, and the white people must of necessity take quinine quite regularly. Two suggestions in his letter are worthy of the attention of all mining students. "I noticed that I sadly lack in knowledge of the metallurgy of non-ferrous metals", the letter reads. "Such a course should certainly be required of all ore mining men. The ore dressing course came in very handy, as it gave me a chance to understand all mill machinery. This course should also be taken by all students in mining, since much of the machinery used in ore dressing is also used in coal washing." The first concentrator ever designed for carbonate ores has been built. Its cost was appalling, and in spite of the fact that it was the first ever designed it is a real success. The malachite ore concentrates readily, and it is now possible, instead of picking the mines for

their fifteen per cent ore, to concentrate average ore, and send a twenty three to twenty six per cent product to the smelter. According to Wilten, the smelter people do not want higher extraction because they have to haul too much limestone if the copper content is higher. The concentrate having twenty-three per cent of copper is self-fluxing. The electric installation at La Panda, using power from a waterfall in the Katanga, will be a work of the first magnitude, and the whole scheme will cost several million pounds.

The Post-Exam Jubilee which was such a marked success was, we are proud to say, largely due to the efforts of a mining engineer, J. E. Machamer, '22, manager, who was chosen from nine applicants for the position.

Prof. Stock has been reappointed chairman of the committee on coal storage of the International Railway Fuel Association. The purpose of this committee, of which Prof. Stock has been chairman for three consecutive years, is to keep in touch with the coal storage problem.

The department was visited on January 5th, by the Illinois Mining Board, which met at the Inman Hotel that morning. This board conducts examinations of applicants for positions as mine managers, mine examiners, and hoisting engineers.

The U. S. Bureau of Mines Experiment Station at the University is making an extended heat survey of the water gas plant, and waste heat boiler installation in the Joliet plant of the Coal Products Manufacturing Company. W. A. Dunkley and R. D. Leitch are undertaking the survey of this plant, which is now operating successfully with southern Illinois bituminous coal, and sufficient heat is recovered by means of waste heat boilers to practically operate the plant. The purpose of the survey is to work out heat balance which should be of special interest to the gas industries of the middle western states.

Francis S. Peabody, president of the Peabody Coal Company of Chicago, recently presented the department with nine etchings. These pictures, which are hung on the east wall of the hall on the second floor of the Transportation Building, were etched by Philip Sawler and represent a variety of scenes relating to the life of a miner. Three are scenes characteristic of a mining community and the other six are views of coal mine tipples.

The weekly mining seminar, which is composed of the mining faculty and members of the U. S. Bureau of Mines at the Illinois Experiment Station, had a very interesting program last semester. The purpose of the seminar is to discuss modern mining problems, the speakers being not only drawn from the department faculty, but from the whole Univer-

sity and the U. S. Bureau of Mines as well. The program for the last semester was as follows:

Oct. 11—Dr. T. E. Savage, Geology Dept., "Alaskan Experiences".

Oct. 25—Prof. A. J. Hoskin, U.S.B.M., "Oil Shales and Their Products".

Prof. H. H. Stock, "Report on Mining Congress Meeting".

Nov. 1—Prof. R. W. Arms, "Dry Preparation of Coal".

Nov. 8—Mr. H. F. Yancy, U.S.B.M., "Distribution of Sulfur in Coal".

Nov. 15—Dr. James Rutledge, U.S.B.M., "Suggestions for Improved Coal Mining Methods on Oklahoma Indian Lands".

Nov. 22—Mr. W. A. Dunkley, U.S.B.M., "Purification of City Gas".

Nov. 29—Dr. J. H. Hance, Asst. Director, State Geologic Survey, "A Few Aspects of Our Blue Sky Work in Illinois".

Dec. 6—Mr. Thos. Fraser, U.S.B.M., "Coal Washing in Alabama".

Dec. 13—Prof. H. H. Stock, "Discussion of Per Cent. Extraction of Coal".

Dec. 20—Dr. T. E. Layng, Chemistry Dept., "Relation of the Path of Travel of the Gases in Retorts to the Carbonization of Coal".

Jan. 10—Mr. O. G. Stewart, Grad. in Mining, "Review of the Situation in the West Virginia Coal Fields in Reference to Labor".

Jan. 17—Prof. S. W. Parr, Dept. of Chemistry, "Carbonization of Coal".

Two of the speakers at the recent Ceramics Short Course were Professors Stock and Drucker. On January 25th, Prof. Stock spoke on the history and development of the modern steam shovel and its uses in connection with the various products of the ceramic industries. On the following day, January 26th, Prof. Drucker lectured on "Explosives and Blasting as Applied to the Ceramic Industry" and exhibited specimens of the various types of explosives. Both lectures were illustrated.

Senior mining engineers who are looking for positions will do well to look at the list of openings on the bulletin board in the Transportation Building. Prof. A. E. Drucker is Secretary-Treasurer of the Wisconsin Section of the A.I.M.M.E., and as such is constantly receiving notices of vacancies with mining firms. He has also corresponded with Mr. Brown of the United Federated Engineering Societies.

## Railway Engineering News

The fourth meeting of the Railway Club, held in December, was featured by a talk by Professor Edward C. Schmidt on "Graduates of the Railway

School". The Railway School, which is divided into three departments, electrical, mechanical, and civil is the youngest in the College of Engineering, yet it boasts of one hundred and eighteen graduates. Eighty per cent. of these are engaged in actual engineering work. The following is a brief resume of the work of the men mentioned by Prof. Schmidt. Mr. C. T. Ripley, who graduated in 1909 from the Electrical Department, has now risen to the position of General Mechanical Inspector in the service of the Atchison, Topeka, and Santa Fe Railroad. As a Senior, he won the J. B. Brill Co. design contest, a competition in the design of a street railway car. Two other graduates of the Electrical Department mentioned were, Mr. B. B. Shaw, '11, who is now Division Engineer of Rock Island Lines at Little Rock, Arkansas, and Charles Gordon '12, who is Equipment Engineer of the Chicago Surface Lines. From the Civil Department Mr. Timph W. Tu, '09, was mentioned. For two years after graduation, Mr. Tu worked for the Chicago and Northwestern Railway, and the Kansas City Terminal Ry. Then in 1911, he returned to China and held responsible positions with the Kiuikiang Nachang Ry., and the Canton Hankow Ry., until 1917. At this time he was called to Pekin to serve on the Committee on Railway Technics of the Ministry of Communication. Mr. Tu was later selected as one of the Technical Experts to the Chinese Representative. When the new agreement between the Russo-Asiatic Bank and China became effective, he was appointed by the Chinese Government to be Assistant Chief of Maintenance of Way Department. Mr. Tu is now in this country as a member of the Chinese Delegation at the Disarmament Conference at Washington. As a graduate of the Mechanical Department, Mr. F. A. Lorenz, '09, was mentioned. He worked for the Chicago and Northwestern Ry. for about a year after graduation, but immediately after this joined the engineering staff of the Republic Iron and Steel Company, as operating engineer. Since 1911, he has been with the American Steel Foundry where he is manager of the wheel department. Mr. Faisson, '11, is another graduate of the Mechanical Department mentioned. He has been Superintendent of the Atlantic Steel Casting Co., at Chester, Pa., since 1915.

The test car which has been used by the Illinois Central since last July to establish tonnage rates has been returned to the department of railway civil engineering, and will be used for instruction work this semester.

At the last meeting of the Railway Club the following officers were elected: President, I. M. Halperin, '22; Vice-Pres., LeRoy Tucker, '23; Sec., T. C. Fitzgerald, '23; Treas., B. O. Bowers, '22.

# A L U M N I N O T E S

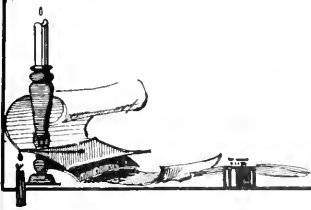

*E. S. Lee*, e.e., '13, has been engaged in the running of tests on the measuring of temperatures of copper conductors in 35,000 K.W. alternators for the Commonwealth Edison and the New York Edison Cos. He has also been running a water rate test on the U.S.S. Maryland, the third electrically operated battleship.

*H. H. Porter*, min., '17, is with the United States Oil Corporation, Eastland, Texas.

*C. C. Trashell*, cer., '16 is with the General Electric Co. at Schenectady, N. Y.

*G. H. Matoba*, min., '18, is chief chemist of the Patterson-Sargent Co., Cleveland, Ohio.

*Glen D. Bagley*, e.e., '12 moved to New York last spring to be in the research laboratory of the Union Carbide & Carbon Co., Long Island City.

*W. O. Andrews*, e.e., '13, is at Rice Institute, Houston, Texas.

*L. H. Whitney*, min., '17 was instantly killed recently as he was superintending the installation of a new engine at the Katherine Mine, Kingman, Arizona, where he was assistant superintendent.

*D. C. Johns*, min., '17, is with the Sherwood Coal Company, Dugger, Indiana.

*Mayne S. Mason*, e.e., '11, has, since graduation, been two years with the General Electric Co. at Schenectady and Pittsfield, two years as instructor at Rutgers College, one and one-half years at the University School of Aeronautics during the war, then researching at the Mellon Institute, and is now with the Westinghouse Electric Co. at their New York office.

*D. W. Fairchild*, min., '13, is engaged in mining engineering at Denver, Colo.

*C. C. Hubbard*, min., '15 is with the Superior Coal Co. at Gillespie, Ill.

*J. Liebson*, cer., '17, is near Shaughai, China, in the employment of the General Electric Co., equipping and starting operations in an electric porcelain plant.

*C. M. Smith*, min., '10, is an assistant in Mining Engineering at the University. Since his graduation he has been chief clerk in the mining department of the Mutual Casualty Company, Chicago.

*Frank S. Hutchinson*, a special student in Civil Engineering from 1897 to '99, visited the University lately for the first time since leaving here as a student. After leaving the University, he engaged in civil engineering for a short time, but soon took up mining engineering, and for eight years was a mining engineer for several great steel companies at Duluth, Minn. Recently he returned from China where he went to investigate the mining and steel making enterprises of the South Manchuria Ry. He is now the American representative of this railroad, which is owned and operated by a Japanese Company. He has been visiting the University to see about having samples of Manchuria coal purified by the washing process at the Coal Washing Laboratories of the Mining Department. He is preparing to open extensive coal stripping mines in Manchuria and to build a blast furnace and steel plant in the same country.

*P. J. Freeman*, m.e., '07, is Engineer of Tests for the Pittsburg Testing Laboratories at Pittsburg, Pennsylvania.

*W. J. Bublitz*, e.e., '11, is General Manager of the Finkhouser Equipment Co. of Kansas City, Mo.

*H. T. Brown*, e.e., '14, who is connected with a glass manufacturing company at Alton, Illinois, attended the recent Ceramics Short Course.

*J. R. Stebbins*, e.e., '21, *L. C. Herwig*, e.e., '22, and *A. B. Palmer* e.e., '22, sailed from New York January 14th, for Venezuela, where they will be employed by the Sun Oil Co., in developing their oil properties.

*Henry Bacon*, e.e., [89], designer of the Lincoln Memorial at Washington, D. C., was given a testimonial dinner recently in New York City. The University was represented by Professor I. O. Baker and Professor A. N. Talbot.

*H. A. Marbach*, e.e., '15, has recently been made Chief Engineer and Assistant Superintendent of Lincoln Park, Chicago.

*A. W. Hinds*, e.e., '21, has been working with the Chicago Bridge & Iron Works since graduation.

*P. B. Buckley*, min., '21, is on the engineering corps of a large mining company in Berwind, W. Va.

- Lieut. J. L. Davis*, c.e., '17, is with the coast artillery and is stationed at Fort Mills in the Philippines.
- Arthur D. Lutchhoff*, c.e., '18, now owns the Clinton Engineering Company of Clinton, Iowa.
- M. P. Benson*, c.e., '21, who is engaged in highway engineering work is connected with the county engineer's office.
- Charles H. Shoppard* c.e., '17, is the junior member of the firm of Schwaab and Sheppard, Engineers, located in Alton, Ill.
- O. J. Fleming*, c.e., '20, is now assistant production manager of the Special Machine Company of Chicago.
- W. M. Bonham*, c.e., '16, is the superintendent of highways for McDonough County of Illinois and is residing in Macomb, Ill.
- W. W. Means*, c.e., '19, is connected with the American Steel and Products Company at Columbus, Ohio.
- F. W. Panhorst*, c.e., '15, has been acting as resident engineer for the Washington State Highway Department.
- F. R. Hanschmann*, c.e., '19, is superintending construction for the Warden-Allen Company of Milwaukee.
- C. W. Cheworth*, v.e.e., '21, and *L. A. Drew*, e.e., '21, are connected with the "Electrical Retailing" magazine, as business manager and associate editor respectively. This is a new magazine devoted to the retail electrical trade.
- Lawrence P. Keith*, a.e., '13, is manager of the structural department of the West Coast Forest Products Bureau, which is the market extension machinery of the loggers and wholesalers of Douglas fir.
- Gustav Geo. Fornoff*, e.e., '13, lays out electrical and mechanical equipment for industrial plants with A. S. Alschuler, architect and industrial engineers, Chicago.
- M. J. Reed*, min., '17, is with the Ingersoll-Rand Company, Boston, Mass., manufacturers of rock drills.
- J. M. Silkman*, min., '15, is still in the army and is stationed at Hancock, N. J.
- H. J. Brown*, e.e., '14, is with the Illinois Glass Co. He attended the recent Ceramics short course at the University.
- Lloyd G. Smith*, m.e., '13, as engineer for the city of Whiting, Ind., has designed a \$150,000 sewer system to be installed soon. He is also general foreman of the pressure still department for the Standard Oil, at Whiting, Ind.
- Paul V. Collingham*, c.e., '21, was married last year and is now working for the State Highway Department at Danville, Illinois.
- A. H. Fessler*, cer., '21, is with the Bureau of Mines at Columbus, Ohio.
- P. W. Wood*, c.e., '21, has been transferred to the home office of the Kors Construction Company at Des Moines, Iowa.
- C. W. Campbell*, min., '17, is a mining engineer for the Old Ben Coal Corporation at West Frankfort, Illinois.
- J. L. Burnett*, min., ['23], is working in the anthracite coal fields, his present location being Plymouth, Pa. He intends to see something of iron, copper, or other ore mining before he returns to the University next September.
- C. W. Smith*, min., '13, is Chief Engineer of the Nason Coal Co. of Chicago, Ill.
- James H. Griftner*, min., '15, was married last year and is now with the Associated Company of Hartford, Conn. At present he has charge of the mid-west district of the company with headquarters in Champaign, Ill.
- W. C. Sadler*, ry.e.e., '13, is in Elgin with the United States Railway Administration working on claims made by the railroads against the United States government.
- G. Kline*, cer., '21, has taken a position as ceramic engineer with the Springfield Paving Brick Co. at Springfield, Ill.
- E. L. Halbauer*, min., '21, is studying for his M. S. degree at the Graduate School of Harvard University, Cambridge, Mass., and is specializing in metallurgical engineering and construction.
- J. S. Hausman*, min., '14, is with the Goodman Manufacturing Co. of Chicago, manufacturers of mine locomotives.
- Everett G. Young*, ry.m.e., '13, is professor of locomotive engineering at the Tangshan engineering College, Tangshan, North China.
- A. R. Brandner*, arch., '13, is with Kirchoff & Rose, architectural firm in Milwaukee.
- B. B. Seymour*, min., '21, has returned from a tour of the west after visiting some of the largest mines in that section of the country, and is now acting as assistant to his father, who is president of the Franklin County Coal Mining Company at Benton, Illinois.
- Willis Leriche*, min., '14, is president of the Traylor-Dewey Contracting Company, at Allentown, Pa. He was formerly with the Cement-Gum Company at Kansas City, Mo.
- J. E. McDonald*, min., '14, is with the Edward Valve and Manufacturing Company at East Chicago, Ind.
- H. H. Osborne*, c.e., '21, is in the engineering department of the New York Telephone Co., N. Y.
- P. H. VanScoick*, cer., '11, is at present with the Chicago Retort and Fire Clay Co. at Ottowa, Ill.

*W. G. Stromquist*, m.&s.e., '10, has been sanitary engineering for the city health department of Memphis, since September of 1920. He has done much in promoting and conducting anti-malarial campaigns in western Tennessee. Since 1917, his work has taken him to a variety of places. He has made sanitary surveys of mining towns of Wyoming, he has written reports in St. Louis, and he drove mosquitoes out of a 60 square-mile area at Muscle Shoals, Ala.

*W. L. Kenney*, e.e., '20, has a position as an electrical engineer with the Public Utilities Commission for the State of Illinois at Springfield.

*H. H. Sartwell*, cer., '18, with the U. S. Bureau of Standards, is presenting a paper at the next meeting of the American Ceramic Society.

*F. R. Kraft*, min., '18, is with the Graton & Knight Manufacturing Company, Worcester, Mass., tanners and belt makers.

*Albert S. Fry*, e.e., '13, is with the Morgan Engineering Co., at Memphis, Tenn.

*H. A. Wiersma*, a.e., '13, is also located in Memphis, Tenn.

*E. A. Teliciera*, min., '18, was married last year, and is now engaged in mining engineering in Passos, Minas, Brazil, South America.

*Stanley M. Wallace*, min., '20, is a chemist in the Research Department of the Metals Exploration Company of Denver, Colo.

*Leonard V. Newton*, min., '13, is superintendent of Motor Equipment and Transportation of the Texas Company at New York City.

*Thomas Fraser*, min., '17, is connected with the United States Bureau of Mines Experiment Station at the University.

*R. A. Strong*, min., '14, is Acting Chemical Engineer for the Lignite Utilization Board of Canada at Bienfait, Sask.

## The Highway Engineering Short Course

(Continued from page 193)

proposition where principles were expounded and questions answered and definite conclusions reached.

The Legislature of 1921 added a number of things to the road laws. Prominent among these is the so-called "Meents Law". This law adds greatly both to the powers and responsibilities of the counties in the matter of highway work. It charges them at once with the maintenance of the "state aid system of roads" until such time as such roads are formally taken over by the state department. This law is simply a further step in a county unit system of highway work, and is a step forward in developing a coordinated system of high class roads in the State.

The condition, therefore, existing in 1922 is similar to that in 1913. The counties are facing a new era in their work, and the state has corresponding problems. It is therefore both natural and logical that the program for the Short Course this year should be built around these new conditions.

The first day of the program was devoted to general topics of interest to county men, the state men, and the general public. The next two days were entirely devoted to county problems. The fourth day dealt more especially with problems of the state engineers, but still of general interest and of value to those county men who are having, or shortly expect to have, a county program of hard road work.

During the last three or four years, there has been an enormous increase in the amount of scien-

tific research work in connection with highway problems. In the past, "rule of thumb" methods have been the practice and unfortunately all too often, they are the only available methods. Changing traffic conditions, and the development of highway engineering as a distinct branch of the profession have brought about the necessity and the demand for more definite information. The Federal Government is doing much valuable work. Several engineering experiment stations have problems under way, commercial concerns are at work, and a number of state highway departments have experimental work started. Illinois leads in this. The Bates Experimental Road near Springfield is the biggest piece of investigational road work yet conceived, and is costing more than a quarter of a million of dollars.

With these conditions existing it is, therefore, highly desirable that this new information be made available, and consequently, practically the entire last day is to be spent on a discussion of highway research and the results secured to date.

The Division of Highways expects to send in their best engineers to the extent of perhaps one hundred. Many county superintendents will be on hand, and with the others the attendance should reach well toward 300. While this number is not as great as last year, it is believed that the Short Course will be the basis of the extension of more thorough road work in the state, give greater service to the people in understanding the new problems, and will prove a justifiable expenditure of funds.



"Young man, how old are you?" asked the elderly gentleman of a street urchin.

"I'm six years old", was the reply.

"Impossible, no person could get that dirty in six years," mused the elder one.

It takes nobleness of character to keep a diary, but he is a man, who can keep an expense account.

Bobbed Hair—"Why do the engineers need chains, dear?"

Corduroy—"To chain the wicked azimuths so that they can't escape us."



Turning Out Two Promising Engineers

Headline in Illini

"Rating of instructors to be made public."

It couldn't be done. I know that no editor would print the rating I heard a student give an instructor the other day.

Colored Recruit: Say, subjent, lucidate to me de significance ob dis heah number which pears on mah loommmu layleat.

Old Timer: Boy, listen to knowledge. Dat's yo heavenly billet nnumbah in case de ole bony gent wid de crooked razoo axdently unhitches yo' soul from yo' galluses.

Colored Recruit: Hot towel! Sho' hopes mah wings fits bettah dan dese cowhide badges, p'vidin' ah has to propel mahse'f to Nnumbah 3,250,884 Paradise Avenoo.

—American Legion Weekly.

Sanford McNutt  
Was an engineer  
The boiler blew up  
We planted him here.

"Say man, you're lazy."  
"How you misjudge me."  
"What's the matter with you then?"  
"Merely constitutional inertia, my friend."

A mighty roar, the rudders lift,  
The wind shoots through the spars  
A sudden swish, a little sigh,  
The Limited's off to Mars.

Chile: I hear Colgate and Williams had a swimming meet.

Bean: Yes; there was so much foam on the water they had to call it off.

—Brown Jug.

Did you ever stop to consider the moments of inertia of the doors at the entrance to Engineering Hall?



"I hear he drinks some thing awful."

"Yeah, I'll say; I tasted it."

"My room-mate sure is careless with his jewelry."

"So?"

"Yeah, he went out the other day and left a ring in the bathtub."

I've heard of  
Henry Ford, Plutarch,  
Paul Revere, Don Quixote,  
Kid Cicotte and a lot more of these guys  
That made history. I read  
About Dempsey, Clark (T. A.), Eckersall,  
Lloyd George, Warren G, and  
A host of other notorieties and they puzzle me  
Not at all.  
But  
Tell me who  
Is this guy  
Horace D. Combat?

There was a young man from the west,  
And he courted a girl with great zest;  
So hard did he press her to make her say "yessir"  
That he broke all the cigars in his vest.

Mary had a little lamb  
But now the lamb is dead  
She takes it to school each day  
Between two slices of bread.

### Have You One of These in Your Classes?

He always came in late.  
He watched the clock.  
He was always criticizing.  
He never took any notes.  
He made statements without backing them up.  
He was always getting somebody to do his work.  
He asked too many questions.  
He never went out with any of the fellows.  
He never had any dates.  
He was the Prof.

"I, too, am an engineer of a sort", said the com-  
merce student, "being as I am a surveyor".

"You're what?" asked the engineer incredulous-  
ly.

"Oh yes", he replied, "every time Blossom Sec-  
ly comes to the Orph I sit in the front row and sur-  
vey 'er".

### On the Range

Exasperated sergeant (to recruit who seems to  
be entirely ignorant of rifle sights): Say, did you  
ever see a fine sight before?

Rookie: Yes, sir.

Sergeant: What's the best sight you ever saw?

Rookie: A boatload of sergeants being sunk.

—Iowa Frivol.

Where there's smoke there must be smoking.  
But where there's hops there's only brewing.



## Synchronous Converters

(Continued from page 119)

nating current we find the mechanical rectifier used on single phase current, and the mercury arc rectifier also of limited service. Motor generator sets, on the other hand, have been used with success, necessitating two machines, however, which require additional attention.

The rotary converter built in relatively small sizes has been tried with varying degrees of success. It is to a special type of machine known as the Martin Converter built by the Northwestern Electric Company of Chicago that this discussion will be limited. This machine, built in various sizes from  $\frac{1}{2}$  to 100 k.w., differs from the regular converter chiefly in the design of the field structure which is a four pole shunt field wound in the same manner as a four pole shunt motor field. The pole pieces are cast integral with the steel frame, while the pole tips are machined in order to provide a force fit for the damper ring. This damper ring forms a continuous laminated magnetic circuit from pole to pole, and has alternate large slots for the series winding and small slots in which the squirrel cage bars are cast along the inside periphery. The casting of the squirrel cage bars and end rings into one continuous circuit by means of a special process, gives this improved converter the starting characteristics of an ordinary induction motor.

The series winding appears in four large slots between the shunt poles and is wound around the damper ring parallel to the axis of the armature. At first sight it appears that the shunt flux under no load conditions would be short circuited from pole to pole and therefore would not pass through the armature winding. This is prevented by notching the damper ring so as to reduce the cross section and thus increase the reluctance of the magnetic path. A small part of the shunt field flux is shunted through the air gap and the armature circuit. Thus this winding has been designed to prevent magnetic leakage from pole to pole when the rotary is under load and is also necessary to prevent high voltage in the shunt fields when starting. The armature reaction tends to weaken the trailing pole tip with respect to the voltage and thereby reduce the flux. This effect will cause the direct e.m.f. to decrease more rapidly. The effect of this, when the Martin Rotary Converter is used for supplying power to motion picture arcs, would be to cause a fluctuation and an unbalanced condition when more than one arc is used. The series field, however, tends to overcome the armature reaction at the trailing pole tip and therefore stabilizes conditions when the load is thus variable.

Because of the squirrel cage winding, the Martin Rotary Converter starts as an induction motor. When the armature comes to very nearly synchronous speed it is pulled into step by the shunt field. As stated before, the squirrel cage winding also practically prevents hunting and shunts the armature flux from the shunt field at the start so that there is no high e.m.f. in the shunt field as is the case in many machines. In this manner all danger of a breakdown of the insulation of the shunt field is avoided. Experimenters have found that a third and fifth harmonic are present in the voltage wave, but their presence is of minor importance in this particular machine.

The rotary converter is inherently a machine of fixed voltage ratio. In order then to have the converter deliver a given direct voltage a transformer must be employed to step up or step down the alternating current before entering the converter. The auto transformer is used extensively for low voltages, that is 110 to 220 volts, while the ratio transformer is employed for high alternating current voltages. For battery charging it is frequently desirable to charge at a lower rate or with a less number of cells and consequently a lower direct voltage is required. This is readily accomplished in this unit by shifting the transformer secondary contact lever to the desirable percentage tap. The contact levers as mentioned above are near the bottom of the switch panel. They then regulate the impressed A.C. converter voltage and simultaneously vary the D.C. supply. Reverse currents from the battery are prevented by a reverse current circuit breaker. Overloads are taken care of by a release solenoid and contact making ammeter on the panel. In a similar manner a predetermined minimum current value may also open both A.C. and D.C. circuits; thus requiring less attention when the battery charge becomes complete and the machine then shuts down automatically. The transformer is placed behind the switch panel and the converter is fastened to the bottom of the switch panel frame. Thus the entire outfit is incorporated on a rigid angle iron frame making it a compact charging unit.

A great per cent of the motion picture theaters in the A.C. districts today are using the Martin Rotary Converter to furnish direct current for the projectors. The motion picture converting unit consists of a switch panel, together with a transformer, grids, and the converter mounted on an angle iron frame. The switch panel layout is entirely different from the charging panel. It has mounted on the slate a voltmeter, an ammeter, a machine switch, a line switch and two pole double throw emergency switches, one for each lamp in the opera-

(Continued on page 138)



## How do they get that way?

ASK the man with the big income his "secret of success," and you will generally find that it is some copy-book maxim known to everybody.

"Be sure you are right, then go ahead."

"If anything is in your way, go over it."

"Learn something about everything and everything about something."

Trite! Anybody could give you as good advice. It simply means that success is not a problem of discovering some obscure short-cut. The path is plain enough, but only alertness, energy and self-discipline will push you along it.

All this holds a special force for you because what you do at college will influence what you do afterwards. If you start right, the chances are you will finish right.

You can begin now to earn your place in the high-salaried class. Each honest day's work in laboratory and lecture hall will bring you nearer. It will help you to master the fundamentals of your profession—so that later on you may handle problems more easily and make decisions more quickly and surely.

Then and only then, in proportion as you clear your mind of detail, can you give time and energy to those larger questions of policy in engineering, selling, management and finance, which fix the executive's market value.

*Published in  
the interest of Elec-  
trical Development by  
an Institution that will  
be helped by what-  
ever helps the  
Industry.*

## *Western Electric Company*

*An organization whose products and services  
apply to all fields where electricity is used—in  
the power plant, in the shop, on the farm and  
in the home.*

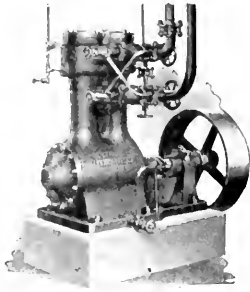

Established 1867

# The Vilter Manufacturing Co.

1020 Clinton St., Milwaukee, Wis.

Ice Making and Refrigerating Machinery  
Corliss and Poppet Valve Engines

Branch offices in all principal cities

*If interested write for bulletins*

## KODAKS

And Kodak Finishing

Our work is done in our own shops—  
Film in before 8:30 is ready at 4:00

## STRAUCH'S

*Photo-Craft House*

## THE UNITED SHOE REPAIR CO.

512 E. John Street

The Best Work at the  
Lowest Price

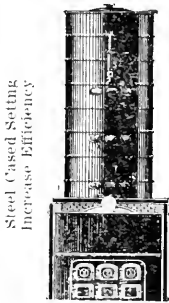

Steel Cased Setting  
Increase Efficiency

## Wickes Vertical Water Tube Boiler

Have you seen the STEEL CASED SETTING for enclosing this boiler?  
Air infiltration losses are overcome.  
The highest possible thermal efficiency results.

Ask for bulletin—Magnitude and Prevention of Air Infiltration  
Losses—sent free.

Ever cleaned a boiler, lamed your back, bruised your knees and skinned  
your elbows doing it?  
Two men can open, wash, close and fill the WICKES in five hours. Tur-  
bin in ten hours.

Ask for Bulletin—Reducing Costs on the Boiler Room—sent free

## The Wickes Boiler Company

SAGINAW, MICHIGAN

SALES OFFICES

New York City, 1716 West St., Bldg.  
Chicago, 76 West Monroe St.  
Boston, 201 Devonshire St.

Pittsburg, 1218 Empire Bldg.  
Detroit, 1116 Penrose Bldg.  
Seattle, 736 Henry Bldg.

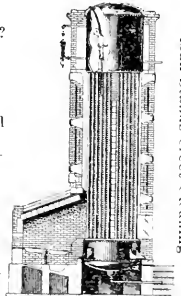

Man Stands erect Cleaning

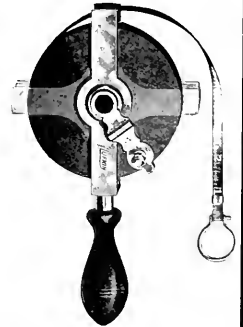
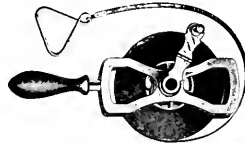
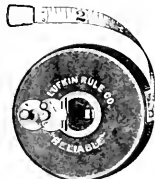
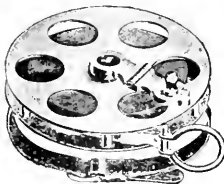

## LUFKIN TAPES

ALL STYLES

Longest, Most Satisfactory Service

Send for Catalogue **THE LUFKIN RULE CO.** Saginaw, Mich.  
New York, London, Eng. Windsor, Ont.

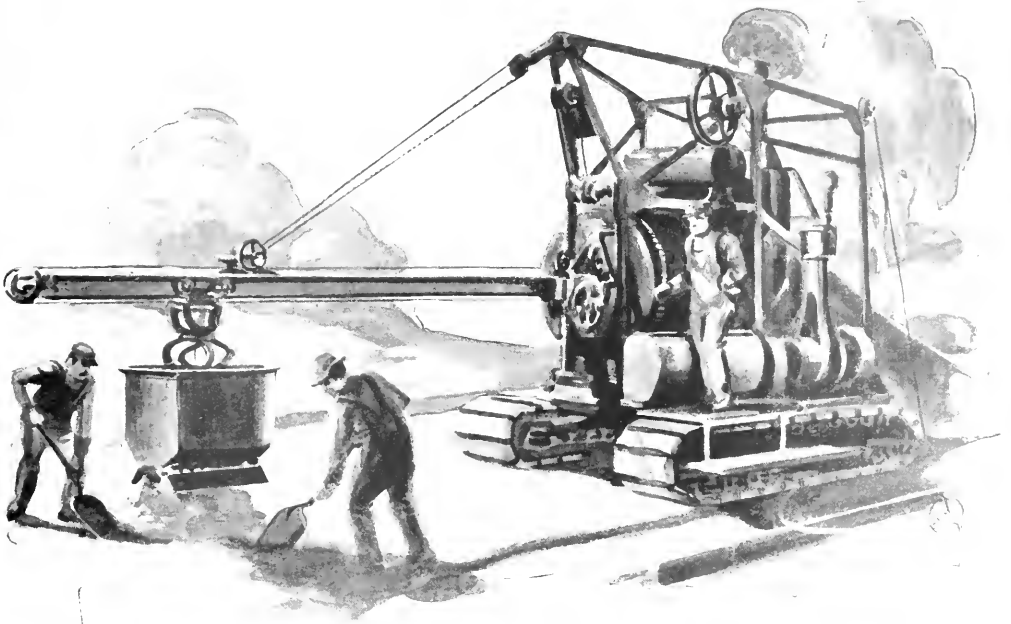

## Brick on Concrete Foundation

A brick pavement with concrete base forms a most satisfactory and enduring type of road. It has its firm adherents in various sections of the country.

As in all other fields of concrete construction work, the Koehring Company offers equipment especially adapted for mixing and placing the concrete base on this type of two course roadway.

The Koehring Paver comes equipped with either road wheels or multi-plane traction, the latter facilitating operation in muddy or soft ground. For moving the heavy machines over city streets, pavers have even been equipped with solid rubber tires.

The twenty foot long boom, with its automatic, self-spreading type bucket places the mixed concrete quickly and with a minimum of hand labor. And for working in restricted quarters, the compensating distributing spout operates to good advantage.

### KOEHRING COMPANY

*Manufacturers of Concrete Mixers and Locomotive Cranes*

MILWAUKEE, WISCONSIN

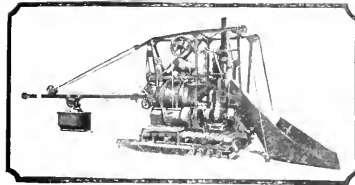

# KOEHRING

## Tolerance Systems in Manufacture

(Continued from page 107)

and yet close enough to satisfy all requirements."

The first principle that must be considered in establishing a system of tolerances is that they must not be determined with reference to what minimum tolerances are possible with modern equipment, but with reference to what are the maximum tolerances permissible in the mechanism without interfering with its proper functioning. Attempting to maintain greater accuracy than is necessary is highly undesirable from the point of view of economy in manufacture. It may frequently increase the cost of manufacture several hundred per cent and mean the difference between profit and loss on the article. The writer has had occasion to investigate cases where expert mechanics at high wages were spending hours working to unnecessarily close limits, filing and scraping parts to accurate fits, and has found that with slight changes in design and proper tolerances, nearly all the useless effort was eliminated and production correspondingly increased. It must not be assumed, however, that, given a system of tolerances, the draftsman or designer can completely and correctly specify all the tolerances necessary when working out the detail drawings of a new machine. He may specify limits or tolerances for such comparatively simple elements as threads, holes, shafts, etc., where it is evident how the work will be located when machined, and such other things that have been standardized. It is impossible, or impracticable for even the best and most experienced designers to go further than this. However, when the first detail drawings are made, if the machine or mechanism is at all complicated, for the reason that if the tool and gage designers followed the tolerances given without deviation, it might lead to complicated and impractical machining and tooling methods, resulting in an increased cost of manufacture beyond all reasonable limits. Experience has shown that in any machine that is at all complicated, limits and tolerances specified on the original design undergo many changes by the time the machine is ready for production, and it is significant that when tolerances are changed they are much more frequently made larger than smaller.

While it is to be understood that in many cases close tolerances are necessary, and under tool room conditions are easily obtainable, it should be a guiding principle in establishing a system of tolerances for interchangeable manufacture, that, presupposing the machines used are in good condition, the tolerances given should be such as can be obtained day after day, and month after month, with proper tooling equipment in the hands of men with a fair knowledge of its use.

## Electric Propulsion of Ships

(Continued from page 97)

ters, or any ships that must operate over a wide range of speed.

In conclusion, it may be said that the advantages of electrical machinery for ship propulsion insure continued development in the field of marine engineering. Electric ships are new, and it is safe to prophesy that in time to come the all-electric vessel will be as common as are steamships today.

*Editor's Note—The illustrations used in this article were kindly furnished by the General Electric Company.*

## Rating Instructors

(Continued from page 121)

who are many years their senior, and many of whom have spent the past years in gathering valuable information which they are now using as a basis for their teaching? Although young and inexperienced, they are all upper classmen who form their opinion rationally, and who take cognizance of what they think is good and what they think is bad. Because they are an honorary fraternity, they maintain no prejudices against their instructors from the standpoint of scholastic averages. They are not complaining against teaching methods; they are merely attempting to place before the dean of the Engineering College their opinions of the teaching ability of his staff. It is the purpose of their report to show whether the teaching methods used by the various instructors are expedient and whether the various instructors are actually accomplishing their purposes. But should the rating not accomplish the purpose for which it is intended, it will remain a sincere attempt on the part of the fraternity to aid in raising the standard of the College of Engineering of the University of Illinois.

## Synchronous Converters

(Continued from page 134)

tors booth. The emergency switches control both the A.C. and D.C. to the lamps. This feature has been provided in order to safeguard against any break downs which may occur when the show is in progress. If for any reason the outfit should fail, the operator has only to throw the lamp circuit switches to the A.C. supply side and continue the show until repairs can be made. With this feature, therefore, a show proprietor can always be confident that his converting apparatus will continue to function regardless of a break down at this point of the circuit.

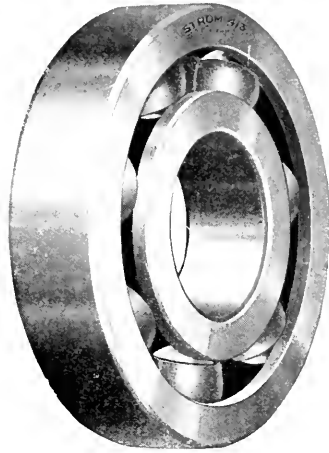

## What Type of Bearing Shall I Use?

In selecting the type of bearing to be used in any installation and nature and size of the load and the condition of operation must be considered.

If the load is entirely radial a radial bearing of the proper size will do the work. Such a bearing will also handle a slight thrust load.

In most installation with both a thrust and radial load it is better to use an angular contact bearing or both a radial and a thrust bearing. For ordinary use Strom radial bearings of the 200, 300 and 400 series

made to an international standard are most desirable. Angular contact bearings interchangeable with the above sizes can be obtained. Thrust bearings for single or double acting duty are made in all sizes, with or without the self-aligning features.

Detailed information on bearing design and installation is contained in our pamphlets: Lubrication of Ball Bearings; Limits and Allowances on Shafts and Housings; Calculating Bearings Loads; Interchangeable Sizes of Strom Bearings.

Write for them.

**THE U. S. BALL BEARING MFG. CO.**

(Conrad Patent Licensee)

4559 Palmer Street, Chicago, Illinois

**Strom**  
**BEARINGS**

## Machinery for Great Engineering Projects

The Allis-Chalmers engineering and highest technical equipment, Allis-Chalmers Mfg. Co. to build superior engineering projects of any magnitude.

Allis-Chalmers industrial installations include some of the most important practical power movers and electrical equipment in the world.

Specialty equipment for power and water, and handling sewage, and for great centers of population, building construction, power, gas, oil and steam engines of all kinds and sizes are some of many Allis-Chalmers achievements. All great shipments of modern machinery for newly complete plants, go forth to assist the engineers and contractors to meet the needs for greater equipment.

### ALLIS-CHALMERS PRODUCTS



Air Brakes	Metallurgical Machinery
Air Compressors	Mining Machinery
Cement Machinery	Oil Engines
Condensers	Perforated Metals
Crushing Machinery	Pumping Machinery
Electrical Machinery	Reciprocating Pumps
Electric Hoists	Saw Mill Machinery
Farm Tractors	Steam Engines
Flour Mill Machinery	Steam Hoists
Forgings	Steam Turbines
Gas Engines	Timber Treating and
Hydraulic Turbines	Preserving Machinery

**ALLIS-CHALMERS**  
MILWAUKEE, WIS. U. S. A.

## WESTERN BRICK COMPANY

Manufacturers of  
Artistic Facing Brick  
Hollow Building Tile  
and Common Brick

DANVILLE, ILLINOIS

## A Recent Boiler Development

(Continued from page 102)

section is therefore a complete boiler in its self. To effect repairs it is only necessary to remove a section, and either cap the mud drum, water supply, and steam outlet openings, or insert a section kept on hand as a spare.

The performance of the boiler is best illustrated by the results as given in Table 1.

In addition to data available from tests, the following points are noteworthy. The boiler does not scale readily, because of the extremely high rate at which the water circulates through the cross tubes, and because the downward circulation in the rear header is directly towards the opening into the mud drum. Since the mud drum is not exposed to the direct heat of the fire, a quiet zone is formed in which to deposit the sludge from the evaporating zones. To quote from a paper recently delivered before the S.A.E. at Minneapolis, by Mr. C. B. Page, member of the A. S. M. E., "Experience with the Winslow boilers built and used during the past ten years proves conclusively that they are self cleaning".

The boiler is also practically indestructible. The writer has personally seen the boiler, which was subsequently tested at Armour Institute—test quoted above, run dry nine times, with full fire on. On each occasion the boiler tubes became bright red hot, and on at least five occasions cold water was pumped into the boiler before the tubes had cooled enough to dull the bright red color. As indicated by the test quoted above, the boiler suffered no damage.

From data available, the Winslow boiler ranks certainly as an engineering development, since, through its indestructibility and efficiency, it is economical of material. Its compact design renders it also economical of space.

## Colonel Lincoln Bush

(Continued from page 113)

head, but because of a greater girth around the heart."

These sentiments are worthy of the man who since the time he uttered them has risen to so high a position. They explain why the directors of the Lackawanna had confidence in him, and why our University chose him from among her sons as one worthy of her honorary degree, that of Doctor of Engineering.

"There ain't no 'nice, sir, sir. "I can't make this motor run," said the E. E. stude to the Prof.





## *Mining for King Solomon's Temple*

Eighty thousand workmen with the quarrying tools of antiquity toiled in the subterranean quarries from which King Solomon obtained the pure white stone for his Temple—begun in 983 B. C.

Channels, to mark the dimensions of the blocks, were grooved in the rock wall with picks, crudely fashioned of bronze. The Egyptian method of breaking out the rock was used: into a niche cut in the stone, a dry wooden wedge was pounded and water poured in upon it. The swelling of the wood forced out the block.

The rough and smooth ashlar of which the temple was built was worked down to the desired size in these caverns. Seven

years were consumed in building the temple.

At a modern copper mine, 47,000 tons of ore have been produced in one day with the aid of Hercules Explosives. And more than 25 million pounds of Hercules dynamite have been used at this mine without a single accident due to the explosives.

King Solomon's craftsmen labored for many days to accomplish as much as one pound of Hercules dynamite will now do for you in a moment.

Write to our Advertising Department, 942 King Street, Wilmington, Delaware, for a book on Hercules Products.

# HERCULES

---

## POWDER COMPANY



Albany, N. Y.  
Birmingham, Ala.  
Buffalo, N. Y.  
Chattanooga, Tenn.

Chicago, Ill.  
Denver, Colo.  
Duluth, Minn.

Hazleton, Pa.  
Huntington, W. Va.  
Loplin, Mo.  
Los Angeles, Cal.

Louisville, Ky.  
New York City  
Norristown, Pa.  
Pittsburg, Kan.

Pittsburgh, Pa.  
Pottsville, Pa.  
St. Louis, Mo.

Salt Lake City, Utah  
San Francisco, Cal.  
Willsboro, Pa.  
Wilmington, Del.

## T. M. Bacon and Sons

Paints, Glass,  
Wall Paper

CHAMPAIGN

## INMAN HOTEL

G. W. Byers and August Danielsen  
Proprietors

FIREPROOF  
MODERN



A Home for Students and Their  
Friends when in Champaign

## Use and Abuse of Refractory Brick

(Continued from page 111)

However, if other refractories can be found that will permit the usage of insulating layers and at the same time give the service that is given by silica brick they will probably replace silica as a heat resisting metal.

The following points should, therefore, be kept in mind to insure long life to boiler settings and to avoid frequent shutdowns: (1) reduce excess air to a minimum; (2) minimize load on the setting by use of metal supporting members; (3) use a cement that will not fuse before the brickwork fuses; (4) keep fires at a constant thickness; (5) avoid sudden temperature changes; (6) carefully select brick for slag line; (7) protect lining against water.

## Along the Old Spanish Trail

(Continued from page 100)

dome practically hanging in the air. The little community made a heroic effort to raise funds to save its historic edifice, but with the revolutions the time was anything but propitious to church building.

Traveling up the chain, the next mission is Pitiquito, a most interesting structure, at once so massive and impressive that it has almost the feeling of Asiatic architecture about it. Among the missions it is quite unique and is, probably, the work of some master-builder of the Franciscan Order who had ideas of his own about church-building.

Continuing further, the city of Altar came into view, the white dome of the cathedral glistening through the palm trees. The city is significant in that it was the location of the presidio of Spanish soldiers for the protection of the missions.

The two missions following next in order are Oquitoa and Atil, both small but pleasing to the eye. At one time, Oquitoa might have been very beautiful, but now most of the decoration has fallen away. Behind the altar is a wooden reredos or screen, which is very interesting; made in several sections and hinged together, it can be folded and carried with little difficulty. Atil is a charming architectural composition and nothing more. All of the adjoining buildings are in ruins and only the church remains.

Following up a very bad road and entering the sand-dune country, the party finally reached Tubutama, the last mission of this group of missions. It is a truly great mission, historically and architecturally, and long famed for its chimes of nine bells. From all appearances it was remodeled several times under the direction of the Franciscans, though the Indians had a large share in the decoration. The Spanish note dominates however, and, in all, Tubutama is a treasure-house of old wood carvings, oil paintings, and bells—treasures which seem unappreciated by their present guardians. Not a few exquisitely carved book-racks made to hold the bulky tomes of mission days were scattered about the choir-loft to be trampled upon. The barrel-vaulted ceilings are a mass of intricate plaster decorations and though having suffered a coat of that perpetual whitewash, were undoubtedly covered with gold. Even the floor is laid with a special tile and after a certain pattern. All of the original bells ante-date 1800 and the earliest is 1712.

The night before the departure of the party from Mexico, the light of the camp-fire against the sky, drew people from miles around, some of them bringing their guitars with them. A farewell con-

(Concluded on page 144)

## FOR DAMP DRIVES

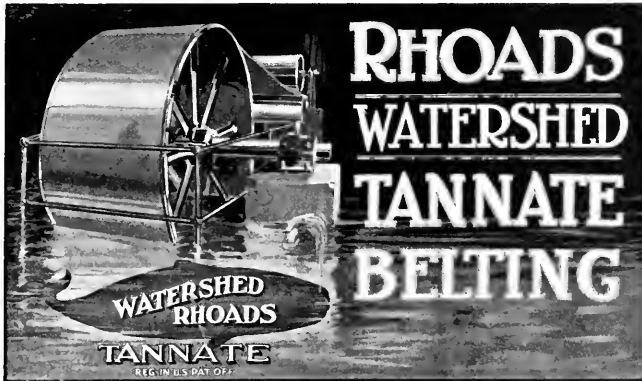

## STRONG GRIP—LONG LIFE

**A** LONG the Schuylkill River, near Philadelphia, are various mills that are flooded by Spring freshets. In one of these mills their Watershed driving belt has been twice submerged in the wheel pit without showing any signs of injury.

In the Erie flood a Rhoads Watershed belt was swept away and lay buried in the mud for weeks. When unearthed it was washed and is working as though nothing had happened.

The comparative non-stretch of Watershed saves slippage and trouble. This is true of both Watershed Oak and Watershed Tannate. On a swift vertical fan drive an 8-inch double Watershed Tannate was reported after five months as not yet taken up. Another Watershed Tannate on a vertical drive in a very hot place was not taken up in its first year of service.

*You can depend on Rhoads Leather Belts. They are flexible, tough and have a strong grip. They cost you less per year because they last so long.*

## J. E. RHOADS & SONS

PHILADELPHIA  
14 N. Third St.

NEW YORK  
144 Beekman St.

CHICAGO  
314 W. Randolph St.

FACTORY AND TANNERY—Wilmington, Delaware.



## Along the Old Spanish Trail

(Continued from page 142)

cert was held, the cook of the party upholding the American part of the program. Charlie, Chinese storekeeper, speaking several languages mixed together hoped that more Americans would come down to visit his missions.

The party had reached the end of the trail, their curiosity satisfied, and on the whole, feeling rather pleased with themselves for having paid their humble respects to this great, but neglected, chain of Spanish missions.

## Pottery and How It Is Made

(Continued from page 118)

the kiln the fires melt the glaze, allowing it to flow down the sides producing beautiful shades and streamers. With proper glaze combinations crystals may also be obtained.

During the glaze firing, much more care is necessary than is required for the first firing. Saggars are glazed on the inside of the piece, and to prevent the melted glaze from cementing the pieces to the bottom of the saggars, each piece is set individually on little stilts or pegs. The raw glaze is scraped off the bottom of the ware, and the ware is set on the flint or birstone which serves to separate it from the glaze of the sagger. Around the top of each sagger as it is placed in the kiln, wadding, which consists of fire clay, is placed. The next sagger is placed on this, or a cover is put on to form an air tight compartment. Smoke, flame or gases will not injure the pottery particularly during the biscuit or first fire, but with the glaze on, the walls must be protected. Sulphur is especially harmful, as it makes an otherwise glossy surface dull and dead.

During the fire, the approximate temperature progress of the burn is observed by the use of pyrometric cones. These are little pyramids of a composition that will melt and deform when a time-temperature relation is established that affects the particular cone. Cones can be made that will record all practical temperatures used in ceramics. Three of the cones are usually mounted together, and when the last cast has been deformed, the fires are drawn from the pits and the kiln allowed to cool.

After the kiln has cooled, and the saggars have been removed, the ware is taken from the saggars and sorted. The stilts are frequently cemented to the ware by the glaze, and must be clipped off and the nicks smoothed. These small holes can be seen on almost every piece of pottery. Finally, the pottery is inspected, and the ware wrapped in hay or excelsior and boxed for shipment.

# LEFAX

## For Highway Engineers

The good judgment of the engineer makes him a believer in LEFAX, for reasons that are obvious.

LEFAX with its many tables and careful information, makes it of use to unlimited numbers. Its qualities are recognized and employed by engineers, its natural association with the finest of building ideals, and its splendid traditions in representing the cream of the engineering world offers an appeal to the highway engineer that touches both his good judgment and business sense.

Sold by



606 E. Green St.

Chicago, Ill.      St. Louis, Mo.

What you see

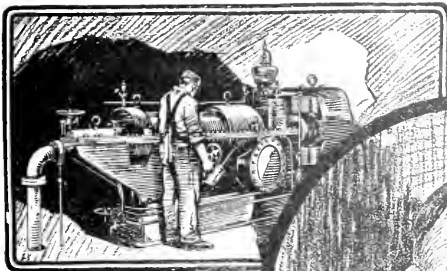

1898, 300 kv-a. Unit

Beginning with what would now be called the tiniest sort of a unit, a turbine which had a normal rating of 400 hp. at 3600 rpm., Westinghouse has developed turbine construction to a point where three cylinder, two stage, turbines are now in service developing 100,000 hp. And a most significant fact about this development is that practically every step in this progress has been a step forward.



1921, 70,000 kv-a. Unit

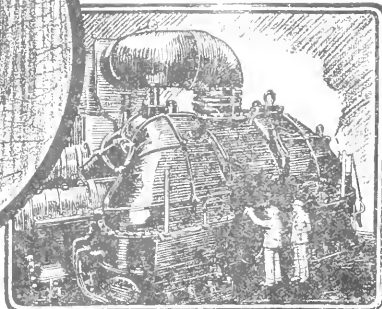

## Francis Hodgkinson

**D**URING the last twenty-five years power generation practice has been revolutionized. The steam turbine has definitely displaced the reciprocating engine as the standard prime mover in large generating equipments. And Francis Hodgkinson has had more to do with this achievement than any other one individual.

Mr. Hodgkinson came to this country along with the Westinghouse Licenses under the Parsons patents, in 1896, upon the recommendation of the inventor himself. Since that time practically every commercial steam turbine Westinghouse has built has been designed and built by him and his able associates.

In this quarter-century of steam-turbine development inventive genius has been paralleled throughout by practical level-headedness. There are few cases in engineering history where the record is writ as clearly and impressively as this. There can be nothing but credit for the engineer who puts his errors underfoot and rises upon them, and most of the world's greatest achievements have been so reached. The World also

honors progress that is surefooted and far-visioned, such as the development of steam turbines under Mr. Hodgkinson's direction.

Many inventions of tremendous value in steam turbine practice have been devised and perfected by him and his co-workers. Among the more important of these are the construction, in 1907, of the first low-pressure turbine to be built in America, and in 1911, of the first Bleeder type of turbine; the perfection, in company with H. E. Longwell, of the water-seal gland; a balancing machine for turbine rotors that is almost superhumanly sensitive; a trouble-proof method of supporting turbine cylinders; and a very superior process for affixing turbine blades to rotor and cylinder.

One of the fundamental Westinghouse policies is insistence upon the uttermost in engineering. The observance of this policy in form and in spirit has provided genuine opportunities for many men of remarkable engineering gifts, one of the most notable of whom is the man whose name appears as the title of this article, Francis Hodgkinson.

---

# Westinghouse

---



## The Name Johns-Manville and What It Stands For

A college is always proud of its name because it stands for honorable traditions, achievements, and ideals.

Johns-Manville too is proud of its name and what it stands for.

Johns-Manville symbolizes the highest ideals in the manufacture and scientific application of asbestos products.

Johns-Manville stands for progress and improvement in service to industry and the individual through asbestos packings that reduce friction, asbestos or insulations that save heat through asbestos roofings that check conflagrations and reduce fire losses—a service that is consecrated to making life safer and more complete; to greater production with less waste through the remarkable durability and fire resistance of asbestos.

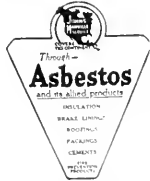

## Johns-Manville INCORPORATED

Executive Offices—New York  
Michigan Avenue and 18th Street  
Chicago, Ill.

*Branches in 60 large cities*

## DAYLIGHT ILLUMINATION.

The angle of refraction being equal to the angle of incident, it is a simple matter to determine the correct angles to use in manufacturing glass which will give good illumination. But for proper industrial plant illumination, there is more to be considered than mere deflection of light. The direct beam of light must be eliminated in order to prevent sun glare, which is objectionable on account of its causing heavy shadows and strong contrasts which decrease the efficiency of employees and necessitate the use of shades which in turn reduce the light to such an extent that daylight illumination any distance from the light source is not sufficient. Therefore, in order to produce a glass which when used in the windows of industrial plants will produce as near to ideal illumination as possible, we must first eliminate the direct rays of the sun by deflecting the light to the ceiling and side walls which re-deflect it back to a distance 25 to 50 feet from the window throughout the entire working area. To accomplish this we have scientifically designed a type of glass which is named "Factrolite."

Factrolite consists of 30 ribs to the inch, running at right angles, forming 900 pyramidal prisms or 3,600 light deflecting surfaces which completely disintegrate the direct beam of light from the sun. Furthermore, the depressions in the surface of Factrolite are so slight that the accumulation of dirt and dust is minimized and can be perfectly cleaned with an ordinary dry scrubbing brush. Incidentally, the cleaning of windows is most important for keeping up production and increasing the efficiency of any industrial plant and should be given more consideration in plant management.

If you are interested in the distribution of light through Factrolite, we will send you a copy of Laboratory Report—"Factrolited."



## You Can Benefit

by our policy of reasonable prices, service and satisfaction. Many have profited by it, and are using our

**Drawing Materials  
Surveying Instruments  
Measuring Tapes**

Buy the DIETZGEN product and obtain the quality and merit which has caused our goods to be accepted as the STANDARD.

*Catalog on Request*

## EUGENE DIETZGEN CO.

Chicago      New Orleans      Philadelphia  
 Branches:      New York      Pittsburgh      San Francisco  
 Sales Offices:      Washington

## MISSISSIPPI WIRE GLASS CO.

220 Fifth Avenue,  
 St. Louis,      New York,      Chicago

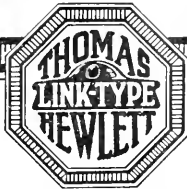
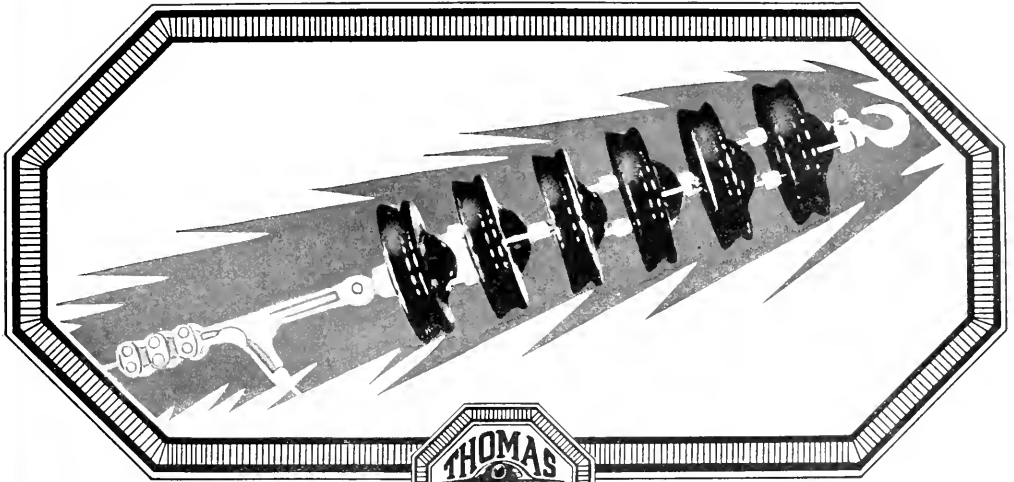

WHEN an Insulator operates efficiently for but five years, Engineers consider it as the average. If it continues to operate for two more years, it is then credited with being "a very good Insulator". When it has served ten years on the line it is then termed "an exceptional Unit". But after it has carried its burden in continuous service for twelve or fifteen years, Engineers are then unanimous in voting it "the Phenomenal Insulator."

¶ Such is the trade standing of the **THOMAS LINK-TYPE**, the All-Porcelain Insulator. A Unit assembled without the aid of cement, composition or alloy. A sturdy design and a capable unit electrically and mechanically. Engineers who investigate this "Wonder Unit" soon adopt it as their standard both for "replacements" and on new Line Construction.

¶ To keep your lines in operation and to guard against costly interruptions from Insulator failures, equip with

### THOMAS **LINK-TYPE** INSULATORS

THE R. THOMAS & SONS COMPANY  
EAST LIVERPOOL, OHIO

NEW YORK    BOSTON    CHICAGO    LONDON

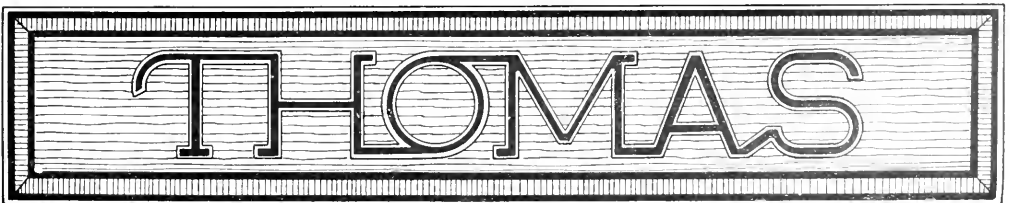

**THE FACT**

*that a K & E is the Slide Rule or Drawing Instrument selected by those who, through their knowledge, may justly be termed experts, is but added evidence of K & E superiority.*

*Drawing Instruments  
Surveying Instruments  
Measuring Tapes*

**Keuffel & Esser Co. of N. Y.**

520 South Dearborn Street

CHICAGO

New York St. Louis Montreal

San Francisco

General Office and Factories, Hoboken, N. J.

## Chicago Steel Tape Company

6231 Cottage Grove Ave., Chicago, Ill.



Manufacturers—Surveying Implements, Tapes, Leveling Rods, Self-Computing Rods, Stadia Rods, Rod Ribbons, Targets, Marking Pins, Lining Poles, Eureka Tape Repairers, Etc., Etc.,

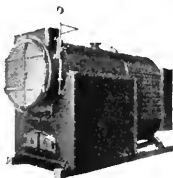

The "Economic"

## The Erie City Iron Works

Erie, Penn., U. S. A.

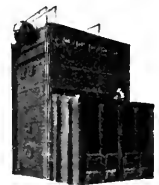

Vertical Water Tube

Manufacturers of

Steam Engines, Steam Boilers, Tanks,  
Steel Plate Construction



Return Tubular Stationary

"The Big Four"  
of Boilerdom

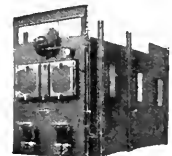

Horizontal Water Tube





The WORLD'S WORD for  
ELEVATOR SAFETY



The WORLD'S WORD for  
ELEVATOR SAFETY

JAPANESE TOWER, CHATEAU DE LOEKEN  
BRUSSELS, BELGIUM

*Equipped with Otis Elevators*

**T**HIS is part of the summer home of Leopold the Second, late King of the Belgians. It stands in the Royal Parc of the Chateau de Loeken, suburb of Brussels.

In the homes and palaces of kings; in the public buildings that peasants use; in the gigantic temples of commerce; in countries of eternal sunshine or those where nights are months long—everywhere the Otis organization stretches out its hand to provide vertical transportation.

A circle embracing Otis activities would circumscribe the earth, for world service is the aim of Otis.

*Most of the famous buildings of the world  
are equipped with Otis Elevators*

**OTIS ELEVATOR COMPANY**

Offices in all Principal Cities of the World



## From A Faint Blue Glow To Modern Miracles

EDISON saw it first—a mere shadow of blue light streaking across the terminals inside an imperfect electric lamp. This “leak” of electric current, an obstacle to lamp perfection, was soon banished by removing more air from the bulbs.

But the ghostly light, and its mysterious disappearance in a high vacuum remained unexplained for years.

Then J. J. Thomson established the electron theory on the transmission of electricity in a partial vacuum—and the blue light was understood. In a very high vacuum, however, the light and apparently the currents that caused it disappeared.

One day, however, a scientist in the Research Laboratories of the General Electric Company proved that a current could be made to pass through the highest possible vacuum, and could be varied according to fixed laws. But the phantom light had vanished.

Here was a new and definite phenomenon—a basis for further research.

Immediately, scientists began a series of experiments with far reaching practical results. A new type of X-ray tube, known as the Coolidge tube, soon gave a great impetus to the art of surgery. The Kenotron and Pliotron, followed in quick succession by the Dynatron and Magnetron, made possible long distance radio telephony and revolutionized radio telegraphy. And the usefulness of the “tron” family has only begun.

The troublesome little blue glow was banished nearly forty years ago. But for scientific research, it would have been forgotten. Yet there is hardly a man, woman or child in the country today whose life has not been benefited, directly or indirectly, by the results of the scientific investigations that followed.

Thus it is that persistent organized research gives man new tools, makes available forces that otherwise might remain unknown for centuries.

**General Electric**  
General Office  **Company** Schenectady, N. Y.  
95-47311D

# THE TECHNOGRAPH

PUBLISHED QUARTERLY BY THE STUDENTS OF THE  
COLLEGE OF ENGINEERING UNIVERSITY OF ILLINOIS

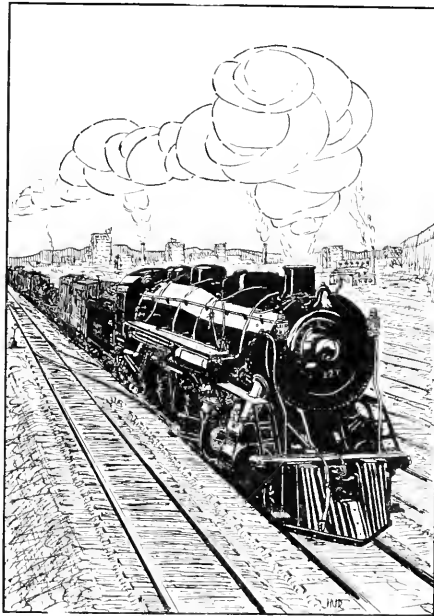

May

1922

FOUNDED EIGHTEEN HUNDRED AND EIGHTY FIVE  
VOL XXXIV PRICE 40 CENTS NUMBER IV



PLAIN



COATED



GALVANIZED

# S DRAINAGE FITTINGS

*The Line With a  
Perfect Recess*

Made to meet all the requirements  
of Cast Iron Fittings in Drainage  
Installations

If it were possible for you to visit our factory in Birmingham and see for yourself the care and skill exercised in the preparation for and manufacture of "S" Fittings, you would never have reason to doubt their fitness to be installed wherever Cast Iron Fittings are to be used.

Should your profession, at any time, bring you into contact with piping construction, our experience in the manufacture of fittings will enable us to always serve you, and your clients to the complete satisfaction of all concerned.

In addition to Drainage Fittings we manufacture Screwed and Flanged Fittings.

Catalog and other data yours for the asking.

## Stockham Pipe & Fittings Co.

GENERAL OFFICE AND FACTORY—BIRMINGHAM

Distributing Warehouses

Bush Terminal—Brooklyn

36th and Iron Streets—Chicago

### SKILLED ENGINEERING

is required to install a job of plumbing or heating so that it will be sanitary and satisfactory

Our Engineers Are Experts

We Are At Your Service

## JOHNSON BROS.

Sanitary and Heating Engineers  
Champaign, Illinois

## INMAN HOTEL

G. W. Byers and August Danielson  
Proprietors

FIREPROOF  
MODERN

I

A Home for Students and Their  
Friends when in Champaign.

# AT WORK *or* AT PLAY

You want the best tools that you can get.

For 25 years we have been studying the needs and desires of Illini students at their work and their play.

## ENGINEERING INSTRUMENTS and SUPPLIES

Have been a special interest with us. We know that business thoroughly. We can serve you to your advantage. The same is true of ATHLETIC SUPPLIES OF ALL KINDS — Baseball outfits, Golf outfits, Tennis rackets.

Large Stock — Prompt Service — Fair Prices

# U. of I. SUPPLY STORE—On the Square

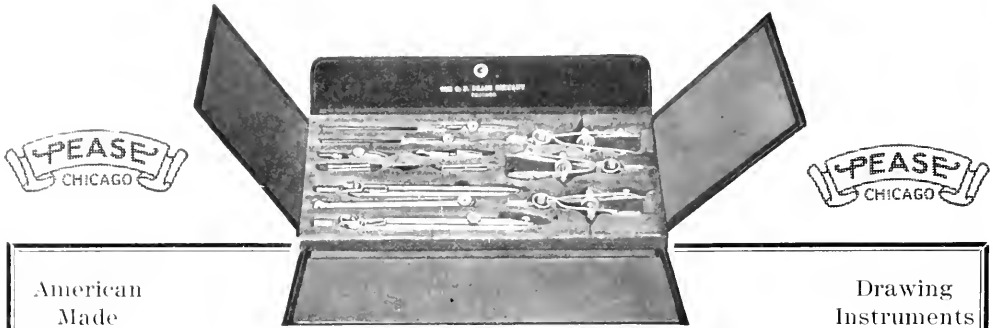

American  
Made

Drawing  
Instruments

## INTERCHANGEABLE - ACCURATE - DURABLE

Manufactured By The C. F. PEASE COMPANY, Chicago, Illinois

You will be proud to take a set of Pease Drawing Instruments into professional life. Unsurpassed in accuracy, quality, durability, workmanship and finish. Each part is interchangeable with the like part of any similar instrument. This makes any small repairs necessary in the years to come easy and economical.

## YOUR STORE

Can supply your needs for all kinds of Drawing  
Materials, General School Supplies  
and Crane's Stationery

## ENGINEER'S CO-OPERATIVE SOCIETY

Boneyard and Mathews

J. R. Lindley, Manager

Urbana, Illinois

# The TECHNOGRAPH

UNIVERSITY OF ILLINOIS

VOL. XXXIV

Member of Engineering College Magazines Associated

NO. IV

## CONTENTS FOR MAY

COVER	J. N. Rutledge	
A LETTER	C. R. Richards	153
DEAN C. R. RICHARDS	J. W. Hartman	154
VOGT WATER TUBE BOILER AND CONSTRUCTION	P. F. Witte	155
THE BOSTON-WASHINGTON SUPERPOWER SYSTEM	L. P. Breckenbridge	159
DR. IRA O. BAKER	R. G. Cone	161
FOUNDRY DESIGN FOR QUANTITY PRODUCTION	L. B. Breedlove	162
OUR ENGINEERING CURRICULUM	D. C. Murphy	166
CONCRETE RESEARCH	F. E. Richart	169
ENGINEERING AND BUSINESS	A. C. Littleton	171
INVESTIGATION OF STRESSES IN A GOTHIC VAULT	C. R. McAnlis	173
DEVELOPMENT OF A STUDENTS' COOPERATIVE STORE		174
JOHN V. SCHAEFER	M. E. Jansson	176
THE MILITARY NARROW GAUGE RAILWAY	F. R. Shoemaker	178
BEFORE AND AFTER GRADUATION	H. T. Coss	180
EDITORIALS		182
DEPARTMENT NOTES		184
ARTICLES WORTH READING		191
ALUMNI NOTES		192
ONCE OVERS		194
ELLIS M. BURR, DECEASED		214

### *Other Members of the Engineering College Magazines Associated*

The Transit	Minnesota Technic
Iowa Engineer	University of Virginia Journal of Engineering
Colorado Engineer	Wisconsin Engineer
Nebraska Blue Print	Tech Engineering News
Sibley Journal of Engineering	Cornell Civil Engineer
Rose Technic	Kansas State Engineer
Michigan Technic	Princeton E. A. News Letter

Published quarterly by the Illini Publishing Company. Entered as second-class matter October 30, 1921, at the postoffice at Urbana, Illinois. Office 213 Engineering Hall, Urbana, Illinois. Subscriptions \$1.00 per year. Single copies 30 cents.



DEAN C. R. RICHARDS



The College of Engineering of the University of Illinois is one of the great technical schools of the world. It is doubtful if it is excelled in personnel, equipment, and variety of instruction offered. Its achievements in teaching and in the development and dissemination of knowledge are noteworthy. Through its graduates and its contributions to the science and literature of engineering, it is known wherever engineering is practiced. With the continued support of the University authorities and the people of Illinois, it will be possible to still farther extend its activities in technical education and research so that its opportunities for service will be continually increased.

The realization of these conditions and opportunities and my appreciation of the cordial coöperation and good will of the faculty and student body rendered it very difficult for me to reach a decision to leave Illinois. While I am anticipating my new duties with interest and pleasure, the latter is tempered by regrets at the need to give up the delightful associations established during my eleven years here. I shall watch the development of the University and of the College, and rejoice with you in each of their new achievements.

(Signed) C. R. RICHARDS

May 5, 1922.

# Dean C. R. Richards

J. W. HARRISMAN, JR., C. E. '23

On February 1, 1922, at a meeting of the Board of Trustees of Lehigh University, Dr. Charles Russ Richards, at present Dean of the College of Engineering of the University of Illinois and Director of the Engineering Experiment Station, was elected President of Lehigh University. Thus terminated one and a half years of searching on the part of the Trustees and alumni of Lehigh University for a suitable man to direct the development of their Alma Mater. Such deliberation and thorough investigation but adds to the honor, for the Trustees Committee was determined "to find a man whose qualifications would be such as to satisfy the desire on the part of the faculty for an educator, on the part of the alumni for a proved administrator, plus the general desire on the part of everyone for a man combining vision with the sturdy common sense that can make a vision come true". Since the present standing of the College of Engineering must have been taken as a measure of Dean Richards' capabilities, his selection to become President of Lehigh University reflects creditably upon the College.

Dr. Charles Russ Richards was born at Clarks-ville, Indiana, March 23, 1871, son of Charles and Sarah Elizabeth (Watt) Richards. His ancestry on his mother's side is often mentioned in connection with his profession, for his grandfather was a grand nephew of the great engineer James Watt. His early life was spent in Indiana and in 1886, he entered the mechanical engineering course at Purdue University. He graduated from Purdue in 1890, with the degree of B. M. E., and received the degree of M. E. in 1891. Cornell in 1895, conferred on him the degree of M. M. E. In 1920, the University of Nebraska, conferred on him the honorary degree of Doctor of Science.

The greater part of Dr. Richards' life has been spent in educational institutions, though in addition to being Dean of the College of Engineering and Director of the Engineering Experiment Station, he is also a consulting engineer of prominence, being especially interested in power transmission and in the production and use of producer gas for power purposes. His first position after graduation was Instructor in Mechanical Engineering at the Colorado Agricultural College, in 1891. After one year, he transferred to the University of Nebraska, at Lincoln, as Adjunct Professor of Practical Mechanics. In 1893, he became Assistant Professor of Practical Mechanics and in 1898, Professor of Mechanical Engineering, which position he held until 1907, when he was made Dean of the College of En-

gineering, serving in that capacity until 1911, when he came to the University of Illinois as Professor of Mechanical Engineering. During this period of nineteen years at the University of Nebraska, he organized and developed the department of Mechanical Engineering, which did not exist previous to his coming. He was instrumental in securing the passage of beneficial legislation by the Nebraska Legislature, and one of his last acts before leaving Nebraska was the planning and supervision of the erection and equipment of the Mechanical Engineering Building, which is recognized as one of the most complete in the United States.

Dean Richards' qualities were recognized at Illinois soon after he assumed the chair of Professor of Mechanical Engineering and when Dean W. F. M. Goss was absent in charge of the smoke abatement studies in Chicago from July, 1913, to September, 1915, Dean Richards was the logical choice for Acting Dean of the College of Engineering. When Dean Goss resigned in 1917, to enter professional work, the faculty of the College of Engineering recommended to the President and Trustees of the University the appointment of Professor Richards as Dean, thus showing that they had appreciated fully his conduct of the office while acting Dean. At the same time he took up the duties of Director of the Engineering Experiment Station.

As Director of the Engineering Experiment Station, Dean Richards has developed the field of co-operative research, which is research for which the expense is partly borne by those industries that will benefit most by the conclusions that are reached. Several of these are: the study of the design of house heating furnaces in co-operation with the National Warm Air and Ventilating Association; the fatigue of metals in co-operation with the General Electric Company; the utilization of Illinois coals in the manufacture of gas, in co-operation with the Illinois Gas Association; and a study of the flow of air in tunnels in co-operation with the United States Bureau of Mines and the Vehicular Tunnel Commissions of the states of New York and New Jersey.

It was the development of such co-operative research projects as these that enabled the College of Engineering to continue its research work during the period of the war in spite of the shortage of funds. In fact, the outstanding feature of Dean Richards' regime is not so much the important constructive developments, but the manner in which he kept the College intact during those trying years.

(Continued on page 204)

# Vogt Water Tube Boiler Design and Construction

PAUL F. WITTE, III, C. E.

*This article was awarded first prize in the Schaefer Engineering Essay Contest.—EDITOR.*

The Vogt Water Tube Boiler is of the straight tube, horizontal type, and is constructed in units of 250 or more horse power. Fig. 1 is a side elevation of the boiler and illustrates the general design. The tubes are grouped in four banks; three of these are inclined from the horizontal while the fourth bank is practically vertical. Any tube may be removed and replaced without disturbing any other tube or

equalize pressure and water level. Each steam drum has two standard 11 by 15 inch manholes.

The tube headers, or cross drums, are cylindrical and four in number; two are of the "twin-drum" type and two are single drums. Cylindrical headers do not constrict the water circulation from one bank of tubes to another and require no staybolts. Flat surfaces must be stayed; staybolts are

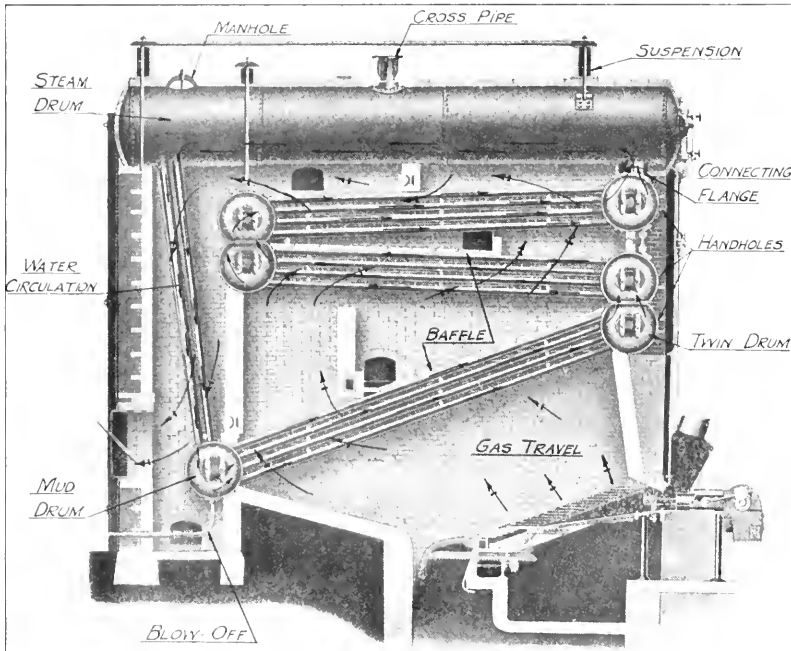

Fig. 1. Side Elevation With Under Feed Stoker.

the setting brickwork. All tubes are straight; straight tubes facilitate cleaning and replacement.

The steam drums are termed "longitudinal"; they are in a horizontal plane and extend in the same direction as the tubes. Units of 500 or more horse power have three steam drums; smaller units have only two. The steam and water storage spaces are unusually large to efficiently care for rapid and wide fluctuations in the load, and to produce steam of high quality. The two cross pipes which connect the steam and safety valve outlets of the individual drums, provide common outlets for the boilers, and

objectionable in boiler construction, and are the source of much difficulty. However, the connecting plate between the two elements of the twin-drum does not require staying because equal pressure is exerted on both sides. This connecting plate does not interfere with the circulation since the area of the openings it contains is greater than the combined sectional area of all tubes in a bank.

The tubes must enter the headers perpendicular to the plate surface to secure tight and lasting joints; entrance at an angle makes it practically impossible to roll and flange the tubes so they will

not leak. Perpendicular tube entrance is secured by pressing bosses in the header shells where the tubes enter. Large handholes are located in the front headers diametrically opposite the bosses to facilitate tube cleaning; one head of each drum is also provided with a standard manhole.

The feed water is discharged into the boiler in the steam drums above the bank of vertical circulating tubes. It passes down the vertical tubes into the lower header which serves also as a mud drum; this header is baffled to prevent precipitated impurities from being drawn into the lower bank of inclined tubes where ebullition begins. The complete circulation cycle is shown in Fig. 1. This circulation is not forced, but follows its natural path as the steam is constantly rising. This circulation is rapid and retards scale formation; scale greatly reduces the coefficient of heat transmission from gases to water.

The boiler is so baffled that the gas travel is long; the result is more complete combustion and efficient heat transmission. The tubes are staggered to mix the gases, yet the space between

them is sufficient to prevent throttling of gases or clogging with soot. The gas travel is counter-current to the water circulation; *i. e.*, the coolest gases come in contact with water of lowest temperature. The result is a very low flue-gas temperature, as the heat transmission is directly proportional to the temperature difference between the heat-liberating gases and heat-absorbing water.

The boiler is suspended from a structural steel framework by eye bolts and U bolts which support the steam drums. The headers are similarly supported from the steam drums. Expansion and contraction of the boiler is not transmitted to the brickwork because of this independent suspension, and consequently cracking of the setting is reduced to a minimum. Weakening stresses are avoided as all parts of the boiler are free to expand relative to each other.

The boiler front is made from rolled steel instead of cast iron, to secure greater durability;

the clean-out doors are "asbestos packed" to prevent cold air leakage into the setting. The water column, steam gauge, safety valves, and other fittings are of any standard make which the customer may desire. Stokers, soot blowers, superheaters, economizers and similar equipment are now usually purchased by the user directly from their manufacturers.

Every Vogt Water Tube Boiler is constructed in absolute conformity with the Boiler Code of the American Society of Mechanical Engineers. This code embodies the thought of the leading engineers regarding the qualities of materials, elements of design, and processes of manufacture which will produce a boiler that is fundamentally safe.

Space permits the description of only the more important operations in the production of the Vogt Water Tube Boiler; minor operations will be mentioned only as required for an understanding of the manufacturing process as a whole.

The engineering department has on file standard drawings, bills of material, and shop instructions for boilers

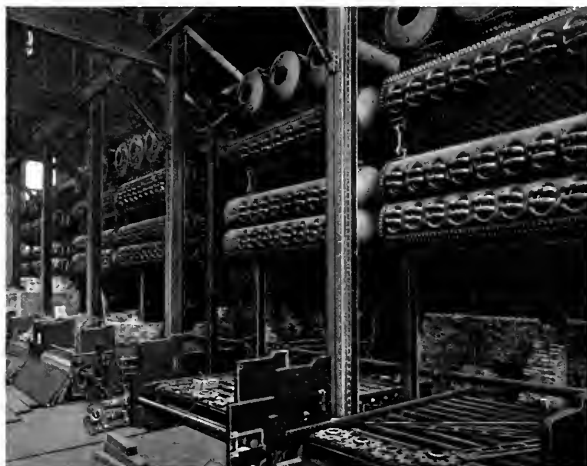

Fig. 2. Front Elevation of a Bank of Boilers in the Process of Erection.

of the sizes in greatest demand, also tables indicating changes necessary for variations from the standard. When an order is received, the bill of material which is prepared by the engineering department is checked by the stock clerk to indicate the material that must be purchased. His report then serves as a requisition on the purchasing department. The engineering department also sends simultaneously to each shop, the drawings and instructions necessary for the parts of the boiler it manufactures. A definite schedule governs the entire process of fabrication. All parts are completed at nearly the same time, and shipment will then not be delayed because some minor items have been overlooked.

The equipment of the boiler shops has been so arranged that the parts of the boiler require minimum handling and back-tracking during fabrication. It is difficult to appreciate the reduction in cost effected by intelligent routing and proper

machine location. Since the product is highly standardized, a very definite process of manufacture is easily determined; from the stock racks at the north end of the shops to the loading platforms at the south end, all machines and equipment are arranged in the order in which the operations are performed. Every part of the floor is accessible to the heavy duty electric cranes, and in addition to its standard 25-ton hoist, each crane is equipped with a 5-ton quick-acting hoist to reduce the handling time for small loads.

When the plates for the steam drums and head-

punched 1 1/4 inch under size and the handhole openings are blanked out. The punches are of heavy duty, quick-acting type and are equipped with spacing tubes.

The next operation on the shell plates and butt straps is planing the calking edges. A plate planing machine capable of a cut 25 feet long on a 1 1/2 inch plate at one setting, is used for this purpose. Some manufacturers chip the calking edges with a pneumatic tool after riveting has been completed, but this is inferior to planing because the uniform plate lap essential to correct joints is rarely secured.

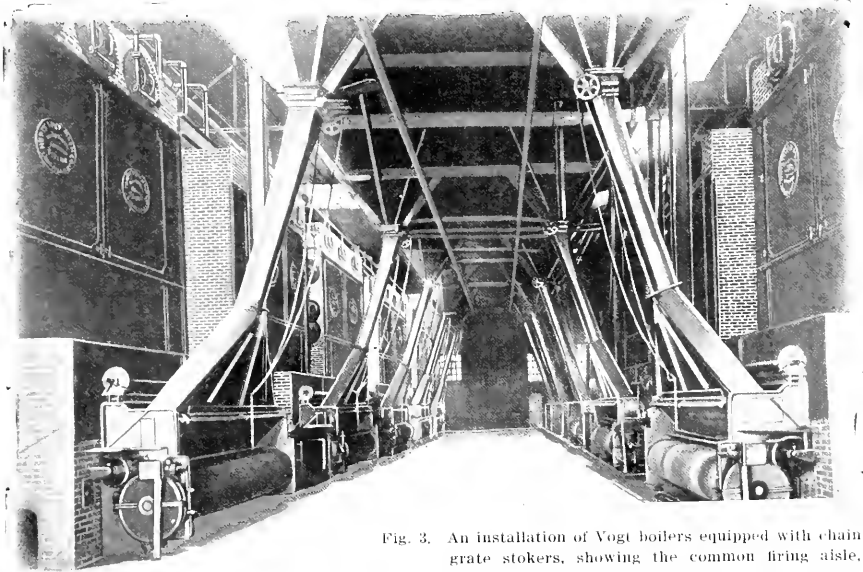

Fig. 3. An installation of Vogt boilers equipped with chain grate stokers, showing the common firing aisle, and the overhead coal storage bins.

ers are received from the rolling mill, their sizes are first verified by the layout department. Plates are ordered exactly to size as mill shearing is sufficiently accurate; but allowances must be made in thickness for pressing, and in width where planing of the edges is necessary. Rivet and tube hole centers, and outlines of manholes and similar openings are indicated by prick-punch marks circled with white lead paint and "spotted" from standard steel templates. There is also painted on each plate brief instructions for the fabricating operations; as "punch 7 1/6, ream 1 1/16, roll to 30 dia". The rivet holes for the head plates, connecting flanges, steam and safety-outlet flanges are not laid out until after flanging because a slight variation in pressing would throw them entirely out of line.

The shell plates and butt straps are sent to the battery of punch presses where all rivet holes are

The shell plates and butt straps are then rolled cold by regular and gradual increments to the exact radii required. Three pairs of "bending rolls"—the largest capable of rolling a plate 1 1/2 inches thick and 24 feet wide to a circle 30 inches or larger in diameter—make possible the production of shells in whatever quantity and size required. Shell plates which require no bosses and manhole openings, and the butt straps are delivered to the fitting up department; the remaining plates are moved to the flanging shop.

While the preceding operations are performed on the shell elements, the heads, connecting flanges, steam and safety outlet flanges are pressed in the flanging shop. The equipment of this department consists of a 1050-ton hydraulic press of the four-post type, a 250-ton hydraulic sectional press with one horizontal and two vertical rams, and oil burn

ing heating furnaces. The pressing dies are cast iron and so designed that when the ram is down the space between them is of the exact configuration required of the finished part. The circular head plate is first heated to a cherry red heat; it is then placed between the dies of the large press and pressure applied until the ram is completely down. All flanges are formed on the sectional press. All pressed parts are annealed by slow cooling to relieve the stresses induced by the flanging.

The heads and flanges are then returned to the layout department where the rivet holes are "spotted" and the flange edges are located. Standard steel templates minimize the time required for this operation. When the rivet holes have been punched, the manhole openings are machined on a vertical boring mill to afford true seats for the cover plates; the flange edges are similarly finished. The heads and flanges are now ready for the fitting up operation.

When the shell plates that require bosses and handhole openings reach the flanging shop, the heads and flanges have been completed and the dies are being changed. The 1050-ton press forms the bosses in any sheet by one stroke of the ram, and the sectional flanging machine makes the handhole openings. Because of the reduction in plate thickness occurring at the edge of a flanged opening, all manhole openings are provided with reinforcing plates. These reinforcing plates are riveted on the inside of the shell and head plates before pressing; the openings are then flanged with the reinforcing plates in position to secure the tight fit necessary to strengthen the flanges.

All parts of the drums are now ready for fitting up. The shell plates, butt straps, heads, and flanges are assembled with tack bolts; and when all parts are in their true relative position, the rivet holes are reamed to the required size, which is 1/16 inch larger than the rivet diameter. The severe shock to which the material immediately surrounding a punched hole is subjected produces large local stresses and occasional small cracks. To remove this weakened material and assure plate of full strength for rivet bearing, all rivet holes are punched small and reamed to size. All reaming is done with the plates in position to assure holes that are "fair" or in perfect alignment. If the holes do not coincide, the joint will be weak due to offsets in the rivets.

The drums are then taken apart and the burrs due to reaming removed by chamfering the holes. If the burrs are not removed, the plates cannot "lay up" properly; the result is a leaky joint.

When reassembling has been completed, the next operation is riveting. Four hydraulic riveting machines capable of exerting pressures varying

from 25 to 150 tons upon the rivet, and having gaps ranging from 6 feet to 20 feet 2 inches make possible tight rivets. The rivet is heated to a straw color in an electric rivet heater; it is inserted in the hole and the hydraulic pressure of the riveter is applied. This pressure is maintained until the rivet is black. A loose rivet will be the result if there is any tendency of the plates to spring apart and the pressure is removed before the rivet is sufficiently cooled or "set".

The second head of each drum cannot be riveted with a hydraulic machine because the die cannot reach the inside rivet head. After the plates have been closely "laid up" with a sledge, such rivets are driven with a pneumatic hammer operating at 80 pounds pressure. The "gun", or hammer, is held on each rivet until it is black and is maintained perpendicular to the plate; "rolling the gun" or giving it a rotary motion causes the rivet die to cut into the plate.

The headers are now taken to the battery of heavy-duty radial drills where the holes for the 4-inch tubes are drilled in the solid plate, about 1/16 inch on the diameter being allowed for clearance. The superiority of this practice to the usual one of punching the holes 1/2 inch small and reaming to size is evident.

All joints of the steam drums and headers are calked inside and outside, a round nosed tool being used in the pneumatic hammer to prevent cutting into the plate. Rivets driven by air are calked as an assurance of tightness, but those driven by hydraulic machines do not require calking.

All drums are now moved to the testing floor. The manhole and handhold cover plates are bolted in position, the tube holes are capped, and the drums filled with water. A pressure of one and one-half times the maximum allowed working pressure is applied; any rivets that "sweat" or seams that leak are carefully calked until tight. All pressure parts are inspected by a reputable insurance company, and a manufacturer's policy for a nominal amount is written to indicate that the boiler is acceptable for insurance. When the shop inspector has also placed his stamp of approval on the drums, they are thoroughly drained and removed to the loading platform.

Because it is impossible to ship these boilers with the tubes in position, the mill is instructed to cut the tubes accurately to length and ship them directly to the customer. Seamless or lap-welded steel tubes are furnished according to the purchasers requirements. Each tube is tested by the mill to an internal pressure of 1000 pounds per square inch.

Simultaneous with the construction of the

(Continued on page 204)

# The Boston-Washington Superpower System

L. P. BRECKENRIDGE, Edg. D., '10, U. of I.

*This article was published in the Yale Alumni Weekly March 10, 1922. Editor.*

Within the lifetime of the oldest living graduate of Illinois, the world in which we live has been made a new world. Previous to the invention of the steam engine, man's immediate environment determined his method of living; his food, his clothing, and his hut depended upon the individual effort of himself, supplemented by the efforts of his oxen, his horses, and his slaves.

The steam engine is now, and has been the great producer of *Power*. With it man has been able to do two things: (a) move materials, and (b) change the shape of materials. Because of available *Power*, we are no longer dependent upon our environment, our own effort, or the effort of our slaves. We may live anywhere in the world and have brought to us anything that the world produces.

At first, in order to use *Power* (water-power) it was necessary to take the work to the place where power could be made. Steam power was more flexible and it could be taken to the place where work was to be done. It could move boats and locomotives. Factories could be placed anywhere. Industrial cities grew. In the factories, there were numerous power units, some good, some poor, but all requiring fuel. The locomotive brought the fuel for the engine and the material to the factory, and took away the clocks, the cotton goods, the boots and shoes or the food products. It was so easy to distribute products that the factory grew, and with it the demand for more power and more fuel. In this way has been built up the great number of power-consuming industrial cities in which over one-half of our people now live, depending always on available *Power*.

Electricity reached its majority at the beginning of the 20th century. Electricity is a form of energy produced by water or steam power. It has wonderful characteristics; it may be transported (conducted) in large quantities over a group of wires; it may be transformed into light, heat, or power as may be desired. It is available in large or small quantities and it will do in the home what the steam engine did in the factory—lighten the burden of human labor.

In the United States the demand for power and more power has increased even more rapidly than either our industrial growth or our population. Our

installed power-generating capacity is about 12,000,000 horse power, of which 33,000,000 is steam, 8,000,000 is water and 1,000,000 is by internal combustion engines. This does not include either the locomotive or the motor truck.

It has been realized for some time by engineers that what has been done for our individual cities through the distribution of power by our electric power companies could very advantageously be extended over a much larger region or zone and that power could be produced at still lower rates if co-öperation could be secured by our cities, industries, and railroads as users, and our electric utilities as distributors of electric power.

The conditions imposed by the war brought about an increased demand for power; this was described by Secretary Lane in the following words: "The enormous development of war industries had created an almost insatiable demand for power, a demand that was overreaching the available supply with such rapidity that, had hostilities continued, it is certain that we should now be facing an extreme power shortage. Happily such a crisis was averted by the signing of the armistice, and the ensuing curtailment in the demand for war material has carried us past immediate danger of power famine in the industrial districts of the Northwest."

It was such a condition that induced Congress to make an appropriation of \$125,000 for a Power Survey as described in the following language: "For the survey of power production and distribution in the United States, including the study of methods for the further utilization of water power, and the special investigation of the possible economy of fuel, labor, and materials resulting from the use in the Boston-Washington industrial region of a comprehensive system for the generation and distribution of electricity to transportation lines and industries."

This survey was begun July 1, 1920, and the report (\*) was completed June 30, 1921, as contemplated. The survey and report were made by a group of engineers under the leadership of W. S. Murray. Representatives of the United States Geological Survey and the Bureau of Mines were members of the engineering staff. An advisory board was also appointed by Secretary Paine to represent the users of power.

It would be impossible to attempt here any adequate review of this important report, consisting

(Continued on page 291)

\*A Superpower System for the Region between Boston and Washington, by W. S. Murray. Professional Paper 123, Department of the Interior, United States Geological Survey, Washington, D. C.

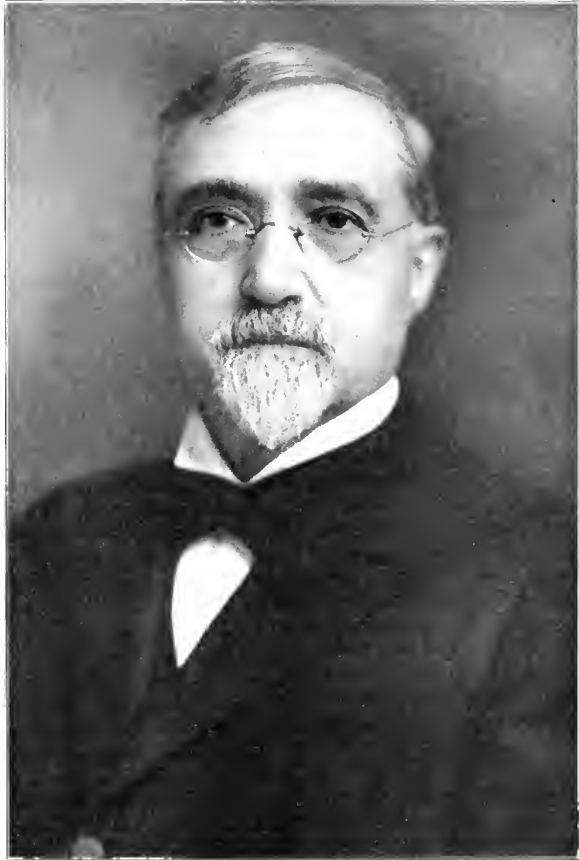

DR. IRA O. BAKER.



# I. O. Baker, B. S., C. E., DR. ENG.

R. G. CONE, e. e., '22

A most noticeable effect of the last great war on industry has been the entry into every branch of business of the technically trained man or the engineer. Men in the business world of today tell us that more than ever the engineer is taking prominent positions and even after astounding advances he is yet on the very threshold of his usefulness. These engineers are advancing to important positions and conquering new problems with a skill based on sound judgment backed by superior training. It is inconceivable that this class of men should have come suddenly to the fore without having been inspired and trained to adapt themselves to such problems by some system of education or by the guidance and instruction from some particular class of teachers. A survey of our modern institutions of learning discloses the secret of these engineers' successes. We find in such institutions a corps of professors who are real pioneers. They have by painstaking methods and prophetic vision instructed and trained men in a manner that has prepared them to meet the emergencies in the world of industry. These pioneers are the engineering educators of today. It is they who by their work of the past three decades have brought forth an education to meet modern requirements. Many of these men are still alive and still actively carrying on this work for civilization. Working behind the screen of their student accomplishments, the public does not know that they are in a large manner responsible for every engineering achievement. Their reward has been in knowing that the students are successful, and their interest, the training of more men to serve industry. It is very gratifying to find among our own professors at the University of Illinois men who are leaders in engineering education and we are very proud to have also some of the real pioneers in this line. We have men who have served the institution for almost half a century. These men have led the field for many years and are directly responsible for not only the training of many men who have risen to serve humanity and accomplish great tasks but also they have been the cause of the University's progress.

There is no better example of such a man than Professor Ira O. Baker, the head of the department of Civil Engineering. He has served the University for forty-eight years, and is still one of the most active and dynamic members of our faculty. He takes the heartiest interest in both his classroom work and in the welfare of his students outside. His sixty-nine years rest but lightly on his shoulders

as he conducts his daily classes and administers the affairs of the department.

Ira Osborne Baker was born in Linton, Indiana, on September 23, 1853. He received his preparatory education at Mattoon, Illinois, in the local high school. He entered the University of Illinois and was graduated with the class of 1874 in civil engineering. After graduation, he was appointed assistant in civil engineering and physics. After serving a few years in this capacity, he was promoted to Assistant Professor, and in 1880, to Professor of Civil Engineering, which position he has held continuously since that time.

Those who read the early history of the institution will realize the versatility that was required of an instructor in those days. During the early days, Dr. Baker taught many subjects, including general engineering drawing, surveying, railroad engineering, civil engineering, astronomy, tunneling, contracts and specifications, and roads and pavements. He also gave the course in analytical mechanics required of all engineering students, and taught astronomy and physics to students in the other colleges of the University.

In those days, it was not only necessary to teach the subjects required, but also in many cases to prepare suitable textbooks. Dr. Baker issued many sets of notes and textbooks written by himself to his classes. They covered such subjects as geodesy, railroad engineering, and the use of surveying instruments. The demand for these books was so pressing that he wrote some of them in longhand on tracing paper and had them blueprinted for his classes.

His first book issued in printed form was "Engineer's Surveying Instruments". It was followed by his "Treatise on Masonry Construction" which brought him international fame and attracted the attention of the whole engineering world. This book has been revised from time to time and is so well written that it is still the best textbook on the subject. This book was very well received in foreign countries, and the London Building said: "Professor Baker's book is unquestionably the most complete and useful work which has ever been published". It is interesting to note that this book was introduced into the technical schools of many countries and is still the authority. Another book that created a very favorable impression was his "Roads and Pavements". Dr. Baker has written

(Continued on page 202)

# Foundry Design For Quantity Production

L. B. BRENDLOVE, Graduate Student.

Great progress has been made in the last twenty years in the design of foundries for quantity production of iron castings. The adoption of modern quantity production methods for all of the manufacturing operations within the foundry presents a larger number of problems than is experienced in other factory systems, and for that reason a complete commercially successful system for large scale production has only been evolved within the last three years. This system, which represents the experience and intensive work over a period of ten years, embraces decided departures from previous practice. The conveyor methods are highly perfected, and have been developed independently of other conveyor systems. Foundries of this type are, of course, principal integral parts of plants producing established designs of metal products, for which the metal analysis and the mechanical design of the casting are nearly uniform or conform to a narrow range of variations. However, this system may be readily adapted for the production of castings varying in size from medium to small. If the expected volume of orders for castings of this range of sizes justifies the heavy outlay of capital, this scheme of operations will give comparatively the lowest production costs. This method requires low grade employees, of whom less than 3.5 per cent. are skilled. The number of men required for large units is between 3 to 4 per ton of production per day, and the production of clean castings, varying in weight from 275 lb. to 5 lb., will average daily from 540 lb. to 380 lb. per man per day.

It is the purpose of this article to discuss briefly some of the features for the design of foundries for large scale production. Some of the most striking examples of these are, perhaps, the methods and equipment of the new Ford plant at River Rouge. The equipment is probably the most elaborate yet installed, and is housed in the largest building in the world, which covers approximately 18.5 acres. The design, as developed, represents the work of several engineers, and is based upon facts which were determined as a result of research. The writer was

connected with this work in the capacity of engineer assigned to power, heating, and conveyor work.

One of the greatest improvements was that of the adoption of the practice of pouring molds with the metal as it comes from the blast furnaces. Making castings direct from the furnace has been practiced more or less since the discovery of reducing iron from the ore, but never to any great extent. Foundrymen have, in general, maintained that a

direct process could not be successful except on very coarse and very low strength castings, because of the range of variations in the composition of the furnace iron. This variation can be traced to several things throughout the process. In the design mentioned above it was decided to attempt to remove the impurities, to reduce the range of variations in the furnace product, and to adopt the use

of direct castings on a basis of 50 per cent. direct metal to 50 per cent. cupola metal. The coke plant was specially designed for the production of a coke of unusual uniformity. The coke sent to the furnaces was very carefully screened to sizes ranging from one and one-half inches to three inches in diameter. This resulted in the rejection of a considerable amount of coke, which in the ordinary plant would be very serious. The rejected coke, however, was used in the pulverized coal system for power generation where it proved to be more satisfactory than coal.

The ore and limestone consigned to the furnace were carefully chosen and conditioned, while the operation of the furnace was maintained very nearly uniform by the numerous recording pyrometers and other instruments. This was the first time that an attempt was made to use such instruments in connection with a blast furnace. The uniformity of composition taken over a period of several months, and the small range of variation in each cast has exceeded by a wide margin any results on record.

These furnaces made six world's records the first three months of operation and have since broken them again. The very close uniformity in composition of the foundry iron that was produced probably

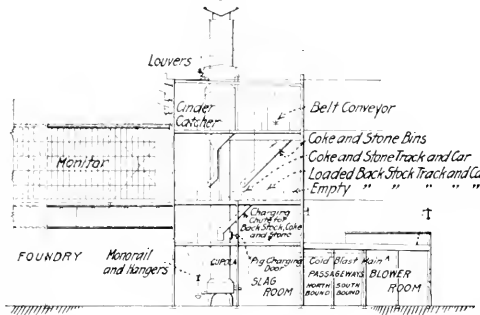

Fig. 1. Section Looking South, Showing Arrangement of Cupolas, Bins, Conveyors, Traffic Passageways, etc.

gives a reliable indication of future results which can be realized in furnace operation.

Experience has proved that the present range of furnace product does not justify casting with 100 per cent. direct metal. Cupolas having a capacity for melting pig, scrap, and back stock, equal to one-half of the foundry output, must be provided.

At present the amount of direct metal used with the cupola product varies with the particular casting to be made, and no general rule can be established. The operations must be so arranged that the variations in the composition of the particular cast from the furnaces may be cared for by varying the cupola mixture correspondingly. For the heavier castings such as cylinder blocks, the ratio is practically forty per cent. direct metal to sixty per cent. cupola mixture. The medium types, such as housings and cylinder heads contain a fifty to fifty per cent. mixture, while in the small types a sixty to forty per cent. mixture is used. In large heavy castings a mixture of eighty per cent. direct to twenty per cent. cupola metal has been used. Laboratory and field tests of castings having the above proportions have demonstrated that they possess equal if not better physical properties than similar castings of one hundred per cent. so called cupola metal. It seems quite probable that within a few years direct casting may be realized. Even in that case, however, cupolas must be provided to care for back stock from the previous castings, and scrap from the main manufacturing processes.

The operation of the plant has shown that the influence of silicon in imparting fluidity to the iron is greater than past experiments have indicated, and that the relation of the temperature to fluidity is probably of less importance than former practice has shown. The temperature of the mixture is lower at the time of casting, hence sand burning has been lessened considerably, and at the same time castings produced have clear and smooth surfaces. At this lower temperature

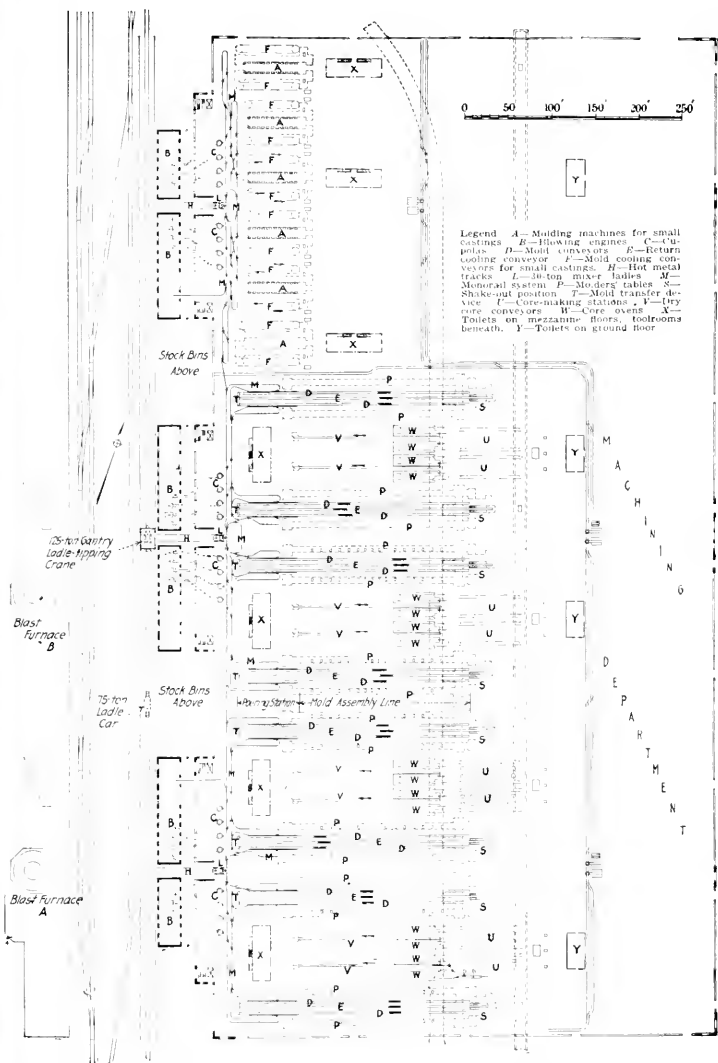

Fig. 2. Plan of the New Foundry Plant, Showing Relation to Existing Blast Furnaces, from Which Direct Metal Will Be Taken, and Indicating How the Transfer of This Metal is Accomplished, from the Hot Metal Car to the Ladle Car, and Thence to the Foundry Pouring Laddles. Arrangements of Monorail System, of Mold and Core Conveyors, of Blowing Systems, Etc., are made clear.

the influence of silicon in producing desirable qualities in the castings is apparently slightly increased.

In order to cheapen construction costs it is desirable that the buildings be divided into two groups, namely, cupola buildings and casting buildings. This also provides other advantages. Each cupola building houses a battery of cupolas, as shown in Fig. 2, and is attached to one end of the casting building. The cupola buildings are of the steel frame type having three floor levels above the main floor, as shown in Fig. 1, usually designated as conveyor, main charging, and back stock floors. This is probably the best type of design and provides excellent facilities for operation at a lower cost than any other type. The casting or main foundry building should be of the steel frame type with wide bays, probably about sixty feet. Extreme care must be taken to provide sunlight and good ventilation in the building. All equipment should be supported from the floor line; no cranes being necessary as all repairs are handled by a portable hoisting rig. The bays should run as nearly east and west as possible, and each should be equipped with a monitor, preferably of the A type. This type of building is of standard design, and can be erected in place at the lowest possible cost and the greatest speed. The number of interior columns in this type of building is materially reduced and this is a very desirable feature. The approximate floor space required is given in the following table. Very often it is necessary to get the building under way before all the details of the casting equipment are settled, and these figures will serve for that purpose. All figures are based upon a fifty per cent. of direct and fifty per cent. of cupola metal, and the floor space requirements are rated in cupola capacity in tons per hour.

FLOOR SPACE REQUIREMENTS

Cupola Rating For One Ton per Hour	Floor Space Required Sq. ft.	Lengths Feet
Cupola Building.....	50	1 1/4
Foundry Building—		
Large Castings (under 400 lb.) .....	700-850	400-500
Medium Castings (under 75 lb.) .....	500-700	250-400
Small Castings (under 50 lb.) .....	300-500	125-250

The cupolas are usually grouped close together in batteries. One battery to each cupola house in each building will give the lowest costs. As indicated in Fig. 1, the shafts of the cupolas should pass

up through the charging and back stock floors and enter a brick lined breeching located on the conveyor floor. The discharge stack from this breeching is placed centrally, and should have a discharge top. The cupola shafts extend some three or four feet into this breeching and the bottom of the breeching should be formed in such a manner that the cinder and dust particles thrown down by the change of direction and velocity of the gases will be conducted to bins suspended under the floors. Experience has shown that with this system a negligible amount of cinders and dust is discharged into the air, overcoming one of the main objections of property owners adjacent to large foundries. Approximately 0.60 cu. ft. of cinders and dust per ton capacity

per hour per cupola will be deposited in these bins. The discharge from a stack of this design has proven very satisfactory, and is not in its characteristics offensive to neighboring inhabitants. This design also prevents the flame-shooting stack so

common a sight at night time. Local governments have in the past been quick to pass adverse legislation because of some of the factors which are averted in this type of design.

The bins for each cupola which contain limestone and coke should be suspended from the conveyor or top floors of the cupola building. These bins as in Fig. 1 are usually supplied with a belt conveyor which runs through all cupola buildings and is supported between them by a cheap covered gallery. The conveyor floor serves to support the stone and coke conveyor and the cupola bins and at the same time prevents the spread of dust. These bins should discharge into side dumping industrial cars running parallel to the cupola or the main charging floors. These cars, after being weighed on special track scales, are discharged into charging chutes feeding the cupolas. These charging chutes cause the materials to enter the cupola shaft by gravity near the level of the pig charging floor. The back stock, which is found beyond the knockout platforms of the foundry, should be elevated into side dumping cars and transported by an electric pusher along tracks in a gallery located on the foundry roof between the monitors. This gallery should be on the level of the main charging floors of the cupola houses. The storage bins for scrap, which are served by a small locomotive crane, should be placed at the level of the pig charging floor. The blower rooms may be placed directly underneath these storage bins. The blowers, usually

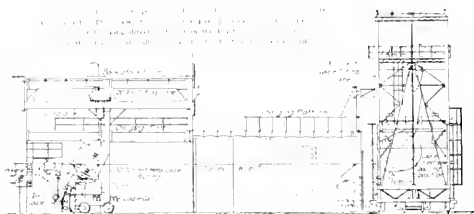

of the high pressure, rotary type, should be driven by direct current motors. The blast piping should be arranged so that each blower is individually connected to one cupola and collectively to any cupola in the battery group.

The hot metal will usually be brought from the furnaces in large ladle cars, as shown in Fig. 3, on a track parallel to the cupola buildings. Spanning this track should be a gantry ladle tipping crane, common to all cupola buildings. The hot metal should be discharged into a mixing ladle mounted on a track at right angles to the former track. Transfer arrangements must be provided for. The mixer type ladle car should be electrically driven and controlled by an operator in the balcony in full view of all operations. The mixing ladle is discharged by an overhead tipping crane into the foundry ladles which usually have a capacity of one ton. The foundry ladles are supported by overhead monorail tracks, and liberal trackage and cross-overs must be provided. At all points where foundry ladles are loaded, large dial automatic scales must be provided.

The casting units for medium and large size castings consist of three special platform conveyors arranged in parallel, shown in Fig. 2. The two outside conveyors are called the mold conveyors, and the inside conveyor is known as the return cooling conveyor. The molds are assembled on the forward end of the outside conveyors, each operation being done by a different workman. The part of the run nearest the cupola line is occupied by the pouring station, the ladles moving along parallel and at the same rate of speed as the mold conveyors. The length of run for pouring will vary from 50 to 70 feet, and for assembling, from 170 to 250 feet, depending on the casting. Speeds for mold conveyors should be about ten feet per minute, and for cooling conveyors about 24 feet per minute. The conveyors are usually made of special steel-top platform sections mounted on four wheeled ball-bearing trucks and fully protected from dust. The smaller molds made up in molding machines are usually of the double tray, double spring pendulum type, the same circuit being used for assembling, pouring, and cooling. All conveyor drives must be protected by several braking pins and overload relays. Special gear reductions as well as drive heads must be developed, as the commercial type will not stand up. Moulds are usually transferred to the cooling conveyor by a compressed air skidding arrangement. The return cooling conveyor must be covered for its entire length, forming a smoke tunnel from which the smoke must be carried to the roof by a fan. This conveyor delivers the molds onto a grating, where the clamps and flasks are taken apart by means of hooks, the

sand passing through the grating, and the hot castings being placed on a flight conveyor by means of special long clamps attached to a monorail carriage. The hot castings are usually carried to an overhead cooling balcony.

A strong draft must be maintained on this knock-down grating. The blast of air must be carried through a settling chamber to recover the sand and then exhausted above the roof. An elaborate system of baffling must be provided to keep bits of charred or burning paper from going out the stack. This is particularly hard to do. The sand is elevated to the equipment which is overhead, to save room, where it is crushed and screened about four times. The iron is removed from it by magnets. From here it must be returned by a flight conveyor to bins above the molders' tables, which are located along the assembly line. The openings in the bins above the molders' tables should have specially designed quick acting gates, operated by compressed air, and controlled by foot levers. Molds are rammed by compressed air apparatus. A small grating in front of the molders' tables must be provided for the overflow to be returned to the system. Experience has shown that this grating should be about two feet wide, to minimize the shovelling necessary in case the bin gates are not operated wisely. This cutting down of the size of the grating will save nearly three quarters of the load on this recovery conveyor system. Sand make up will be about ten to fifteen per cent.

Sand recovery and delivery to core making positions should be similar to the method of handling molding cores. Cores will usually be made by hand in the metal core boxes away from the heat of the ovens at stations marked F in Fig. 2. The completed cores should be carried to the sprays and ovens on overhead power-driven spring mounted pendulum type conveyors. A revolving stall, having four gradient shields, has been developed for spraying. This is the only piece of all the equipment for which power drive was not a success. The cores should be removed by hand for spraying, and later placed by hand on oven trays. The spraying solution can be prepared automatically by an apparatus similar to continuous lime slacking and mixing equipment. The core oven trays should be of the cabinet type, having shelves of various heights and mounted on overhead carriages running on tracks through long ovens at a speed of about two feet per minute. These ovens should be about sixty feet long, the length depending on the cores and gas used. Most designs have fallen down because of the variations of temperature that resulted in the operation. Plain pipe burners should be used in

(Continued on page 208)

# Our Engineering Curriculum

*A Series of Interviews with Faculty Men.*

D. C. MURPHY, M. E., '23

Because there has been some criticism of the curriculums of the College from time to time, both from graduates and from the undergraduates, especially first and second year men, the Technograph has interviewed five prominent faculty men and asked them to state what they believe to be the aims and objects of the Engineering curriculums at Illinois, and to point out briefly the functions of the different courses included in the curriculums. It is the purpose of this article to present these statements; to discuss them fully, pointing out where there is agreement, and where conflicting views (if any) are held; to discuss possible changes in our curriculums which would fit them to effect more satisfactorily the purposes for which they have been designed; and, of most importance, to show the undergraduates, who, through eagerness to begin professional work have become impatient or discouraged, the necessity of two years training in general fundamental subjects before taking up professional work.

It is difficult to present and discuss in any logical order the ideas of five different men. I have chosen to arrange the articles in the order of the manner in which the different professors have treated their subject. Professor Provine, head of the Department of Architecture, and Professor Paine, head of the Department of Electrical Engineering, have given the most general discussion of our curriculums as they now exist, so I will present their statements first. Professor Willard, head of the Department of Mechanical Engineering, has chosen to show just how the curriculum is built up, and what the purposes of the different courses included in it are. I will present his statement next and follow with the specific discussion of an individual course given by Professor Eger, of the Department of Theoretical and Applied Mechanics. Last of all I will place Dean Richards' statement in which he lays particular stress on the increasing importance of non technical courses in the engineering curriculums.

## STATEMENT OF PROF. E. B. PAINE

"I believe that one should come to the University with the idea of developing his physical, intellectual and spiritual ability to the end that he may lead a more useful and happy life as a citizen. The courses in his curriculum should be those which will train him to correct methods of thought and at the same time give him an opportunity to learn the funda-

mental principles of the arts and sciences used in his intended profession.

"A good engineer must have knowledge of both theory and practice. Since practical experience may be more readily acquired after graduation and since the opportunities for becoming familiar with fundamental principles are greater in the class room, it would seem more desirable that the student should devote his time as an undergraduate to the study of principles, rather than to the study of the details involved in the application of those principles. Too complete specialization is undesirable for the reason that no student can ever tell beforehand exactly where his future opportunities will lie. He should, therefore, devote his time to those things which will help him afterwards, whatever line of work he may wish to follow.

"The engineering student at Illinois finds curriculums in each of the several lines of engineering work. He should choose the one leading towards the work which he believes will be most congenial to him. There are bright opportunities in every branch of engineering for those who are willing to work sufficiently hard to win success. If one finds his work interesting, hard work is a joy. When one has found useful work which affords him true joy, he is well started on the road to success."

## STATEMENT OF PROF. L. H. PROVINE

### THE COLLEGE CURRICULUM

"After four years of work in college, the usual graduate expects to assume immediate positions of responsibility in the business world. It seldom occurs to the student that additional education or training is necessary. This view is also held by a certain class of employers who assume that once a college degree has been conferred, the graduate should be able to do anything; if this product of the colleges falls down on the first problem, then this class of employer is ready to condemn the educational institutions and their methods.

"The education of a successful college graduate is divided into two general divisions: the four years of academic work and a more or less extended period of apprenticeship, before or after graduation, in the business world. Not until the employer, as well as the college student, realizes this will the colleges of this country perform their greatest service.

"The usual engineering curriculum has three general divisions, the preparatory work, the technical work, and the cultural subjects.

"The need of a thorough grounding in fundamentals such as mathematics and similar subjects is the first requirement and needs no comment. Without this background the student is handicapped for the intensive work and the specialization which follows. Each course or curriculum varies as to the point where the specialization begins. Many courses start such work in the second year, a few begin in the first year, but the most logical time would require this concentration along particular lines in the third year after two years of training in the fundamentals. It has been felt for some time by the industries that the tendencies of the colleges today is too early specialization, that the student has not had sufficient background to enable him to see his college course with a broad vision, and that he is therefore handicapped by not being able to appreciate the many related factors which compose his particular course.

"It seems strange to have to justify the time devoted in a curriculum to cultural subjects, yet many superficial thinkers feel that the time is wasted, that the student should concentrate from the time he enters college until graduation in his course. Fortunately for the student those individuals who have given serious thought to the college courses and subjects which should be given to make the college student of the greatest value to the world at large not only suggest but in some cases demand that a certain amount of cultural work be given. One national society has specified that a certain amount of cultural work must appear in the curriculum before the department will be recognized or become one of the approved schools in their classification. One great manufacturing concern has said that they do not look with favor upon the reduction of the cultural studies in an engineering curriculum in order to specialize more intensively on technical subjects.

"The greatest responsibility of the colleges today is to train men who will take their places in the life of the community, the state and the nation; not only trained specialists but men of vision who are willing to make the world a better place in which to live."

These two men have very clearly stated what they believe to be the objects of our curriculums—of our university education, and it is important to note that both Professor Paine and Professor Provine believe this to be to train us to take our places in the life of the community not only as trained specialists, but also as "men of vision who are willing to make the world a better place in which to live". Professor Paine adds that the courses in the curriculum should be those that train one to correct methods of thought, and at the same time provide

the opportunity to learn the fundamental principles of one's profession. Inasmuch as a thorough classical background is of vital concern in architectural design, we would naturally expect Professor Provine to urge, as he does, the importance of fundamental and cultural subjects, and to caution against too early specialization, but it is significant to note that although few courses are considered so specialized as electrical engineering, Professor Paine dwells particularly upon the importance of general training, and advocates the study of principles with little specialization while in school. He points out, as does Dean Richards, that few students can accurately forecast the nature of the work they will be called upon to do, and the necessity therefore of training in the fundamentals of science.

In these two statements the broad general divisions of the curriculums have been indicated. Professor Willard in his statement explains just how a curriculum is built up, using as an illustration the Mechanical Engineering curriculum. The curriculums of the other departments are nearly exact parallels to this, there being really but an interchange of professional groups.

#### STATEMENT OF PROF. A. C. WILLARD

##### THE IDEAL MECHANICAL ENGINEERING GRADUATE.

"The principal product of the Department of Mechanical Engineering at the University of Illinois may be described as men trained to function in a special field of engineering. The specifications governing the development of this product in the various stages from freshman to senior are definite and may be briefly summarized as follows:

(1) The mechanical engineering graduate must possess the fundamental knowledge underlying as many of the subjects in his field as possible.

(2) He must possess the ability to use and apply the knowledge he has acquired for the specific purposes of industry; that is, he must be able to think constructively.

(3) He must possess the ability to deal with men, who may be either his superiors or inferiors, without friction, and at the same time carry forward the enterprise upon which he is engaged.

(4) The time available is limited to four school years of 36 weeks each. In this four year period, the student must acquire 112 credit hours of University work, comprising the curriculum in Mechanical Engineering, most of which is prescribed.

"Since the progress from raw material (the high school graduate) to finished product (the University graduate) must be rapid, great importance attaches

to the selection of the proper general fundamental subjects of the freshman and sophomore years. Upon these, the professional fundamental subjects of the junior and senior years and the later success of the graduate must depend.

"The selection of the general fundamental subjects for the future mechanical engineer is a surprisingly simple process, and the list is brief.

"The general list is: 1. Natural Sciences—Physics and Chemistry; 2. Mathematics through the Calculus; 3. Language—English certainly and one foreign language if possible; 4. Drawing, including Descriptive Geometry; 5. Non-engineering subjects dealing with human relations, such as History, Law, and Commerce.

"The selection of the professional fundamental subjects is not so simple, but a few may be safely indicated, keeping in mind the fact that such subjects must be a sort of highest common factor of the graduates, possible future field of activities.

The professional list:

1. Power and its generation from coal, oil and gas, and hydraulic sources.
  - (a) Thermodynamics.
  - (b) Mechanics.
  - (c) Machine Design.
2. Power and its application.
  - (a) To the subdivision under (1) add Shop and Factory Operation and Management.

"The ideal mechanical engineering graduate must also acquire the ability to deal with men and secure a working knowledge of business discipline as well. This can only be done by actual contact with industry at various vacation periods during his four year course. Unfortunately, no provision is made for registration in these important subjects at the time the student's yearly program is made up.

"In conclusion, it may be well to emphasize again the importance of the general fundamental subjects, which include the Natural Sciences, Mathematics, and Language; for without a sound knowledge of these subjects no mechanical engineering graduate can ever hope to master fully his professional subjects and then do constructive work in his chosen profession."

Professor Enger was asked to write on the importance of mathematics in engineering. His statement expands and supplements one of the most important phases of Professor Willard's discussion.

#### STATEMENT OF PROF. M. L. ENGER

##### MATHEMATICS AND THE ENGINEER.

"Mathematics is the backbone of the curriculums in engineering, because without mathematics only a superficial knowledge of engineering science

is possible. As engineering develops it becomes more and more a mathematical science. Without the aid of mathematical analysis it is impossible to proportion a machine, or structure, so that each part is capable of performing its function in the most economical manner.

"Engineers in all parts of the world are experimenting, analyzing experiments and reviewing their experiences in an effort to improve their work. The results of this work is finally expressed in mathematical form, and thus made available for engineers everywhere.

"Recent developments in the proportioning of Portland cement concrete is an illustration. Until recently most of the attention was devoted to the amount of cement in the mixture. In recent years thousands of experiments have been made to determine the effect of the amount of water, the character and grading of the aggregate, as well as the effect of the amount of cement. A mere tabulation of the results of all such experiments would be of little value to the practicing engineer. It is only when the experiments have been analyzed and reduced into mathematical form that they become useful. As a result of the experiments and the analyses it may now be said that concrete mixtures can be "designed".

"The history of the development of the water turbine is a good illustration of the value of mathematics. A century ago water power was perhaps relatively more important than now, because the steam power plant was then in its infancy. The industrial development of the period did not call for large concentrations of power. The turbine of that time was a small, crude, inefficient machine, but many of them were manufactured for the use of the numerous mills which were being built on every available stream. It was natural that persistent attempts should be made to improve them. It was a "cut-and-try" process, resulting occasionally in improvements. As recently as twenty years ago, the water turbines for important plants were selected by a study of the tests of turbines on the market, and using the one which most nearly satisfied the conditions. In the last twenty years the improvement of the water turbine has been very great. It is now possible to design turbines of enormous power to operate at a predetermined speed under a given head of water, and at the same time the efficiency of the machine has been increased so that there are plants in operation with water turbine efficiencies more than 90 per cent. This development has been possible because of the application of mathematics to the design.

"It is sometimes thought that only engineers

(Continued on page 195)



# Some Recent Developments in Concrete Research

By F. E. RICHART,

*Research Assistant Professor in T. & A. M.*

The art of concrete making is still a comparatively new one, notwithstanding the fact that the ancient Romans were skilled workers in the material and that their structures have stood the test of centuries of use and exposure to various disintegrating agencies. The concrete of the Romans, however, was made with a natural cementing material of volcanic origin and was limited in quantity. The concrete with which everyone is more or less familiar today is a distinctly different product, in which the binding material, Portland cement, is a manufactured article, produced in enormous quantities, but with very careful control of quality. Historically speaking, Portland cement concrete is a fairly new material, but its suitability for many uses together with the abundance of raw materials for its manufacture have, in a short time made it one of our most important building materials.

With the beginning of the present century, the development of knowledge and construction methods of reinforcing concrete with steel bars gave a great impetus to the use of this very adaptable material as well as to research in its properties. Along with the construction of reinforced concrete bridges and buildings there have been made innumerable laboratory tests, and a rather large number of tests of full sized structures; so that the behavior of reinforced structures is probably better understood than that of any other sort.

A second and undoubtedly most important period in the use of concrete is now just beginning with the nation-wide program of hard road construction. In the next few years several hundred millions of dollars will be spent in building concrete highways in the United States. The building of concrete roads has already brought up many new problems and has served to some extent in directing attention from the study of the action of reinforced concrete structures back to a searching investigation of the fundamental relations which govern the

properties of plain concrete. Subjects which are now receiving the attention of investigators include the strength in compression, in bending and under impact, wearing resistance, permeability, stiffness, expansion and contraction due to heat and moisture, the effect of age and of curing conditions, and many others.

For most uses the strength of concrete is of first importance. It has been generally accepted that the strength of concrete varies with the proportion of cement used, a mix which is rich, or high in cement content, being strong, and vice versa. In 1897, a French engineer, Feret, pointed out in tests of mortars that the strength depends not only upon

the cement content, but also upon the voids, or pore spaces in the mixture. In a combination of gravel, sand and cement, it is easy to imagine that the sand particles fill the interstices between the larger pebbles and that the cement fills in between sand grains, and that certain sizes and amounts

of each size would result in the minimum of voids, or in other words the greatest density of the mixture. While such an ideal arrangement of particles usually does not exist, mixtures of maximum density can be determined by trial.

Since about 1916, several new theories regarding the strength of concrete have been advanced which attack the question from decidedly different view points. Professor D. A. Abrams of Lewis Institute, Chicago, has evolved a theory based on the results of a large number of laboratory tests. The outstanding features of this theory are the "fineness modulus" of the sand and gravel or other aggregates used in the concrete and the "water-cement ratio" of the mixture. The fineness modulus is found by screening the aggregate through a series of sieves; it is the sum of the percentages of the sample retained on the different sieves, and hence is a number which indicates to some extent the gradation in the size of the particles of aggregate.

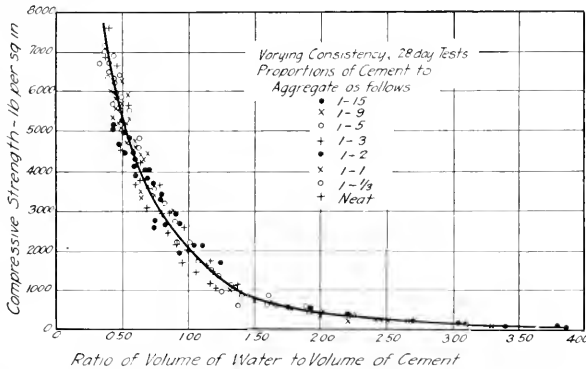

The water-cement ratio is the ratio of the volume of water to the volume of cement used in the concrete mixture, or it may be considered as the number of cubic feet of mixing water used in a batch of concrete containing one bag of cement. In Fig. 1, taken from Bulletin 1, Lewis Institute, Prof. Abrams shows that for the ordinary mixtures of concrete, the strength is closely related to the water-cement ratio. Furthermore, the water-cement ratio usable depends upon the gradation of the aggregates, as indicated by the fineness modulus. A fine sand will have a lower fineness modulus than a coarser, well graded sand, and will require a higher water-cement ratio to produce a desired fluidity or workability in a concrete mixture. Reasons for this will be noted later in the discussion of other theories. It may be said, in passing on, that through the information of Fig. 1 and similar diagrams published by Prof. Abrams, the engineering profession has been brought to realize the very harmful effect of excess water in concrete, unless a corresponding excess of cement is used. In such a case the wet mixture will prove quite expensive.

Prof. Abrams also has devised a scheme of rating the wetness or degree of consistency of a concrete mixture in connection with what is known as the "slump" test. In the "slump" test, which was developed by Mr. C. N. Chapman, a cylindrical or conical mold, placed on a level surface, is filled with concrete and the mold is carefully raised. The settlement in inches of the top surface of the concrete below its initial position is termed the slump. A mixture which slumps  $\frac{1}{2}$  to 1 inch in the standard 12 inch height is said to be of normal consistency and is used as a standard of comparison with other wetter mixtures. The normal consistency will generally result in the maximum possible strength of a mixture.

Another theory regarding concrete which has been developed by L. N. Edwards and R. B. Young, is based upon the area of the surface of the particles of aggregate. If two particles are of similar shape, but one has twice the diameter of the other it can be shown that the smaller particle has twice as much surface as the larger one per unit of weight. Hence the surface area per pound of a fine sand is

much greater than that of a coarse sand, and many times that of a gravel. The surface area of the aggregate is thus used as a measure of the gradation of aggregate somewhat similar to the way in which the fineness modulus has been used.

Researches which have been conducted for several years past by Prof. A. N. Talbot at the University of Illinois have done much to reconcile the theories of what may be termed the "old school" and the "new", to coordinate apparently divergent ideas and to develop underlying principles. The correctness of the fundamental points of Feret's hypothesis has been verified by hundreds of tests, and the significance of the water-cement ratio and the surface area of aggregates has been studied.

Fig. 2, which is taken from a paper by Prof. Talbot in Proc., A. S. T. M., 1921, shows the results of a series of compression tests of concrete in which the strength is plotted against the ratio of the voids to the absolute volume, or volume of solid particles,

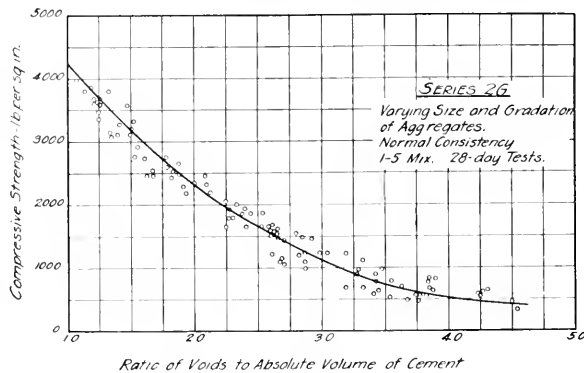

of cement. Freshly mixed concrete may be considered as composed of solid particles of cement and fine and coarse aggregate, together with minute void spaces which are filled with water and air. Obviously the voids represent the portion of the material which has no structural strength, while the cement content represents the concentration of the active binding material. This would seem to give a logical explanation of the relation shown in Fig. 2 and to some extent of that in Fig. 1. The similarity in the two curves is due to the fact that the voids in a freshly mixed concrete are largely water, the proportion being 60 to 70 per cent. in a dry mix to 100 per cent. in a wet one.

Along with the study of the voids-cement ratio there has been developed a way of predetermining the value of this ratio for any given mixture. This method is based on the theory that concrete consists of mortar diluted or filled in with strong solid particles of coarse aggregate; that the strength and other properties of concrete thus depend upon the properties of the mixture of sand, cement and water contained in it. With a given sand the voids-cement ratio of all probable mortar mixes may be determined in three or four hours by simple laboratory tests.

(Continued on page 197)

# Engineering and Business

A. C. LITTLETON, Asst. Dean, College of Commerce.

Business is immeasurably indebted to engineering. Look behind any great physical achievement and you will find the engineer mastering nature's forces for our benefit. Perhaps it is a Panama Canal or a marvelously efficient steam turbine; it may be a gigantic irrigation project extending the area of farm lands or a hydro-electric development radiating power for hundreds of miles; it may be quantity production of automobiles, light bulbs, or common pins. Whatever it is, it results in a benefit to society; whatever it is, it forms the basis of some subsequent business or contributes materially to it.

But observe that the engineer's resourcefulness is directed primarily against natural forces. The foundation of his training is physics—light and heat, mechanics and gases, electricity. Most of his time in college is devoted to building an expanding structure of knowledge upon this foundation and to acquiring skill in such "thought-tools" of his profession as drawing and mathematics. Most of his time after college, if he follows his profession, is given to overcoming difficult problems which in their essentials may be traced back to some point in his physics.

So it is that the engineer deals primarily with the first of the two great contending forces—nature and man. The business executive, on the other hand, finds his problems primarily in man. That is not saying the engineer has no human contacts or problems, nor that the business enterpriser meets no difficulties resting upon science. The active life of each is a complex of natural forces and man, but the emphasis for each is in a different place.

In order to trace this thought a little further, let us analyze business. Broadly speaking, business consists in the management of materials, men, and money so as to render a service to society which society will pay for. Only one of these three (materials) is definitely enough related to natural science to bring it before the engineer as such. But in the conduct of a business, men and money take far more of the enterpriser's attention than materials—largely, of course, because the engineer has solved most of the problems of equipment and product beforehand. The business man begins where the engineer has finished.

It is hard to tell when one has stepped over the line from engineering into business, but sooner or later the realization comes to one who has made the change that he is no longer practicing engineering. If he were to stop to analyze the difference he would soon see that the emphasis of his thought and action

had shifted from nature to man. Note how it works out.

Perhaps a shop committee waits upon him with a grievance. This is no problem in calculus; there are no formulae to suit it; no laws of physics are of any service. The problem is man, with his unpredictable moods and unaccountable tastes, his prejudices and weaknesses. The next day it may be persuasive salesman glibly unfolding the astonishing merits of this product and that equipment, and using all the wiles of a trained psychologist to impose their will upon him. There is an alarming slump in sales. How shall customers be influenced more strongly to favor the company's product? Why do they not use the same quantities as before? What price will coax them to buy briskly again? Assuredly the problem is man.

The problems of finance are in a large measure also "man-problems." To get additional funds, investors must be persuaded to invest and there are times when that is no small task. To secure short time loans from the banker, necessitates convincing the banker of a seemingly great number of things. To manage the funds effectively when obtained, is largely a problem of training a smooth working organization of men who will not waste time and money. To keep the corporation's directors and stockholders satisfied with the dividends and still keep the concern financially sound, requires a knowledge of men and their motives as well as a knowledge of the experience tested practices of good finance.

These are some of the problems of the business executive. They are problems of men and money; they must be met and solved. To solve them well we must know how men think and how they are likely to react to a given proposition. We must know how men have reacted in the past under similar circumstances. We must know the machinery of doing business, of buying and selling, of finding employees and cash loans, of shipping goods and collecting debts.

These problems of business rest upon the foundation of economics just as the problems of engineering rest upon physics. In economics one studies the activities of man in the pursuit of satisfactions. Why does man spend money like a drunken sailor at times on silk shirts and eighteen dollar shoes? Why should shoes have been priced at eighteen dollars anyway? And why are they not now? Why are coal producing companies now trying to reduce

(Continued on page 198)

INVESTIGATION OF A GOTHIC VAULT

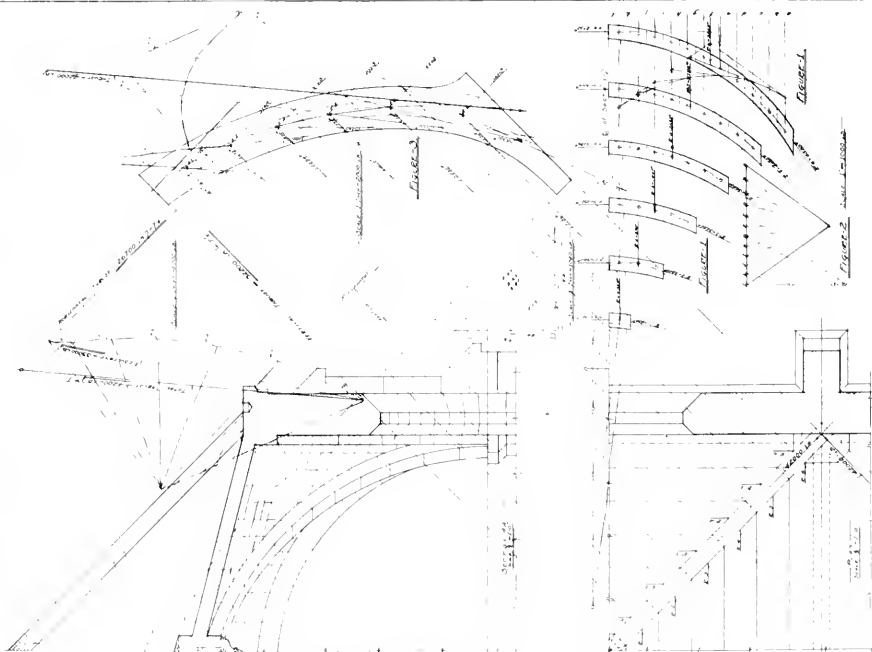

SHEET ONE

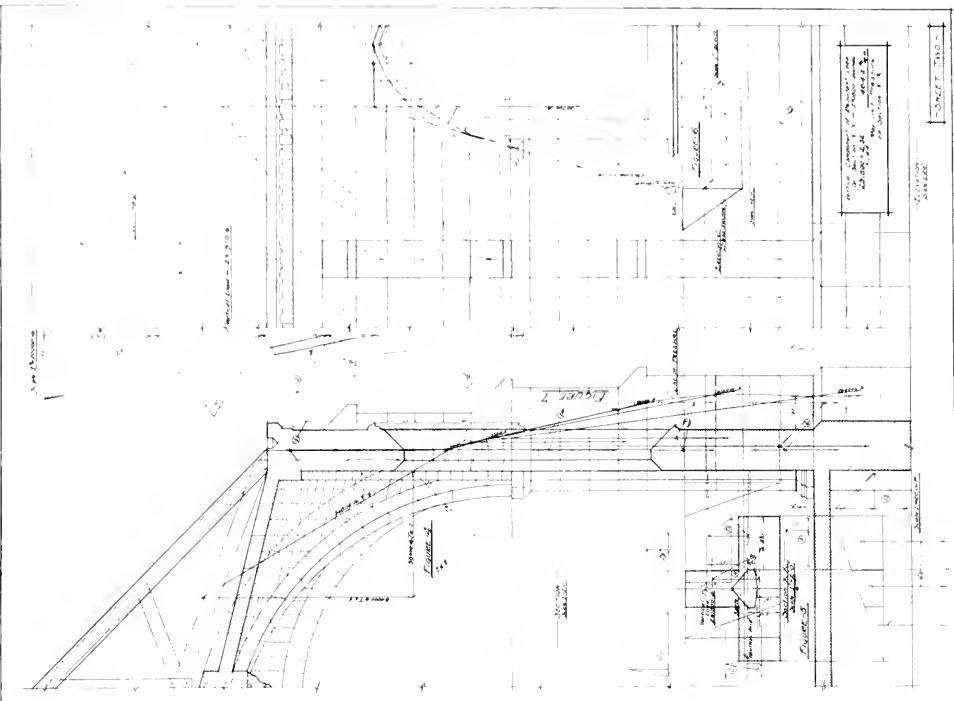

THE UNIVERSITY OF CHICAGO  
DIVISION OF THE PHYSICAL SCIENCES  
DEPARTMENT OF ARCHITECTURE  
1155 EAST 58TH STREET, CHICAGO, ILL.

SHEET TWO



# Development of a Student's Co-Operative Store

The establishment of a cooperative store at the University of Illinois has been made possible through the organization and cooperation of the Engineering Societies. The idea of a real cooperative store was first presented to the Electrical Engineering Society by J. R. Lindley in September, 1920. Frank J. Jirka, who was president of the Electrical Engineering Society at that time, thought the idea a very good one, and began making plans

lege of Engineering at that time and this meant that approximately 41 per cent. of the men of that college were heartily in favor of a new store to secure the necessary school supplies at reasonable prices.

As has been stated before the seven hundred dollars secured from membership fees was the only capital the store was able to procure. This would pay for a very small portion of the stock actually needed to supply the demands of the Engineering

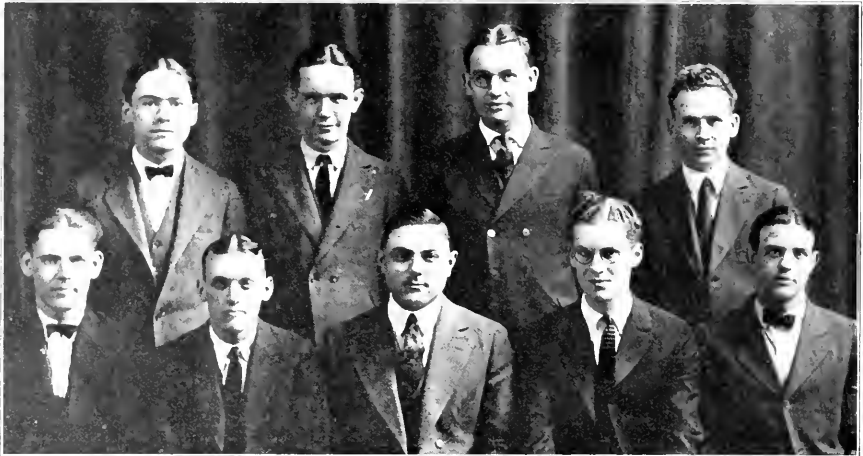

BOARD OF DIRECTORS

Top row—P. F. Witte, K. L. Smith, L. D. Zeek, G. H. Bohn.

Bottom row—H. C. Harmeling, J. A. Nelson, J. R. Lindley, J. P. Thompson, R. A. Merz.

for development through the Engineering Societies.

The constitution and by laws of organizations of a similar nature were secured from various parts of the United States. A constitution for the new organization was drawn up to meet the conditions at the University of Illinois. The constitution was very similar to that of the University of California, although many ideas were used from the cooperative plans of Harvard and Cornell Universities.

The principal feature of the constitution as drawn up was the method of financing the new corporation. The capital for a new store was to be secured by the sale of memberships of \$1.00 each, which were to be refunded when the student graduated or withdrew from school, and in case of a faculty member upon severance from the University. Acting upon this plan a campaign for membership was made in April, 1921. At this time 700 members were secured. There were approximately 1600 students in the col-

lege. With this fact confronting the new organization, and the fact that no rating could be made in Dunn's and Bradstreet's Mercantile Agencies, the big problem was to get goods on credit. The method used in securing this credit was, by the manager of the new store making a personal call upon the general manager of large companies from which the stock of goods must be secured. This stock consisted primarily of engineering supplies and secondarily of general school supplies.

It might be well at this time to give an outline of the inside working of the organization. The plan as set forth in the constitution provides for one man selected from each Engineering Society each year who is to serve on the board of directors for two years and must be a sophomore at the time of his selection. When the organization was started it was necessary to appoint one junior from each society to hold office for one year. The board of direc-

tors as selected to complete the temporary organization were as follows: Civil Engineering Society—R. A. Orput and J. P. Thompson; Electrical Engineering Society—J. R. Lindley and C. L. Conrad; American Society of Mechanical Engineers—G. H. Bohn and P. F. Witte; American Association of Engineers—L. K. Whitcomb and A. E. Nelson; Architectural Society—Joe Nelson and Wm. Erickson; Ceramic Society—N. H. Ragland; Mining Engineering Society—No men selected; Railway Club—C. Harmeling and L. D. Borders.

After the temporary organization was completed A. E. Nelson, who was the junior member from the American Association of Engineers, withdrew

years and Prof. W. W. Wilson to hold office for one year.

The development of the store has been very rapid. It has had the whole hearted support of the Engineering students and has been patronized by a large number of students other than engineers. It is true that the Engineers control the store but every student in the University is entitled to its benefits. In fact the organization has grown until it can accommodate practically all colleges in general supplies. Even though the store is well established, stockholders should continue their support, and students who are not members should feel a personal responsibility, and buy membership.



Interior of Students Co-op Store at University of Illinois

from school and was succeeded by R. E. Naylor. The election of officers was held when all plans were completed and R. E. Naylor was elected President, C. L. Conrad Vice-President, R. A. Orput Secretary, J. R. Lindley Manager, and Mr. E. A. Reid of the faculty board was selected as treasurer. The present officers are J. P. Thompson President, J. A. Nelson Vice-President, and other officers same as in the temporary organization.

The faculty board of advisors consists of three members, one of whom is to be selected from the Engineering faculty by the Engineering council in May to take his seat in September following. The men selected for this board were Dean H. H. Jordan to hold office for three years, Mr. E. A. Reid for two

years and Prof. W. W. Wilson to hold office for one year. The division of the profits of the store is made to members only. The amount each member receives will depend upon the amount of his purchases at the store for the previous year. The man who buys fifty dollars worth of goods will receive five times as much refund as the man who buys ten dollars worth of goods. Each member of the organization receives a receipt from the cash register for the purchase. The member making the purchase writes his name on the large portion of the slip received and drops it in the box at the door. The small portion of the slip is retained for the members personal record of his purchases. At the end of each month, the purchases of each member are recorded

(Continued on page 204)

# John V. Schaefer

M. E. JANSSON, *c. c.*, '23.

That the size of a town is no criterion of what may come out of it has been shown by Granville, Illinois. This little town has to its credit at least two things which are of interest to the students of the University of Illinois. Out of this village grew the Buel Institute which started the movement resulting in the land grant schools of which the University of Illinois is one; and then in 1865, it produced John V. Schaefer, the subject of this article, and the donor of the annual Schaefer Prize for an engineering essay written by an undergraduate engineering student at the University of Illinois.

In the days of Mr. Schaefer's youth, Granville was a village of about 300 inhabitants, and was located eight miles from the nearest railroad. It had a good school, however, and the intellectual tone and moral fiber was that of a prosperous New England farming community. Saloons were not tolerated there; everyone attended church on Sunday, and most of the young people went away to college.

Mr. Schaefer's parents were Germans who had left their native country between 1850 and 1860 when the intolerable political conditions drove from Germany some of her best people. In referring to his early environment, Mr. Schaefer has said that while every part of his physical being was of pure German extraction, every part of his intellectual, moral and spiritual being was of the purest New England culture.

For whatever success in life he has had, Mr. Schaefer gives credit in large measure to his environment and to the associates of boyhood days. From one of his boyhood friends, who has since become a great bridge engineer, having had a large part in the successful completion of the Quebec bridge, he secured his ambition to become an engineer. From another, who has since become a famous biologist, he got the steadiness of habit and persistency of purpose that held him true to his aim through years of discouragement; while from his parents he inherited a capacity for work that knows no limit.

When he had finished his course of study at the village school, Mr. Schaefer had to buckle down to earn the money needed to secure a college education, while his more fortunate companions all went away to college.

At sixteen he began teaching school. In three years of teaching during the winter and working on farms in the summer, he saved \$100; and, in the fall of 1881, he entered the freshman class in mechanical engineering at the University of Illinois.

At the end of the freshman year "J. V.", as he was commonly known on the campus, had one hundred dollars left. During that year he learned a lesson which Dean Clark has so ably presented in his book, "Discipline and the Delinquent", viz., that it does not pay to "work your way through college." To replenish his rapidly disappearing funds, he worked one Saturday piling lumber. At the end of the day he found he had blistered hands, torn clothes and eighty cents. He immediately resolved that while he was in school he would be a student with all his might, and that while he was earning his college money he would give it his undivided attention, and never again would he spoil both efforts by trying to mix study with manual labor. So, at the end of his freshman year, he went back to farm work and teaching.

In the fall of 1886, he returned to Champaign with another \$400. This time he finished his course without interruption. He returned to the university a week early in order to organize a students' boarding club; this club furnished his board with little effort on his part. The money earned by one summer's work in the Robinson & Burr Machine Shop and another in Chicago, contributed toward relieving his financial difficulties. During his senior year he more than made his expenses by serving the university as assistant to Professor Talbot. When he graduated in the spring of '89, "J. V." still had \$150 of the \$400 with which he started his sophomore year.

His student activities tended towards the intellectual, rather than the athletic. He was the first president of the class of 1888; and during his sophomore year, he was president of the class of 1889. He was associate editor of the "Sophograph", an annual which for many years was published by the sophomore class. He was very active in the Philomathean Literary Society. In the spring of 1887, he won the inter-society oratorical contest; this made him the university representative in the Illinois Inter-collegiate Oratorical Contest, held in Jacksonville, Illinois, in the fall of 1887. Here again he was victorious, winning the first prize of \$75 in a competition which embraced the nine principal colleges and universities in Illinois. Together with Mr. VantGundy, he originated the old "I-p-si-di-yi-ki" yell, which, as a predecessor of "Oski-wow-wow", was for many years the old standby.

After remaining one year after graduation as



instructor in the machine shop, Mr. Schaefer moved to Chicago, where he took a position as chief draughtsman with the Link Belt Company. At that time, college men were not very much in favor in machinery manufacturing establishments. However, "J. V." made good and remained with the Link Belt Company until 1904.

The present-day methods of screening, sizing, and washing coal are, to a great extent, results of his work during the last few years of his connection with this company. He was first to recognize the possibilities, from the manufacturing standpoint, of more accurate and economical preparation of coal. When he took hold of the work in 1895, there were two places in the United States where shaking screens were in use at coal mines. All other mines used bars or "grizzlies", and coal washing was just beginning to be practiced. Largely as a result of Mr. Schaefer's activities, by 1904, shaking screens were generally accepted at coal mines, and coal washing for both coking and for fuel, was coming into general use in the United States, Canada and Mexico. As a result of original work done along this line, the University of Illinois, at the time of the inauguration of Pres. James, conferred upon Mr. Schaefer the degree of Mechanical Engineer. At the same time he was elected to membership in Tau Beta Pi on the basis of his scholastic record.

In the spring of 1904, Mr. W. R. Roberts, '88, had established a small business in the construction of structural steel buildings for coal mines. Mr. Schaefer joined him, and the Roberts and Schaefer Company was formed. The intimate knowledge of machinery detail and design, the methods, and the organization which Mr. Schaefer brought into the company, caused it to spring at once to the front; and within a very short time the Roberts and Schaefer Company became the acknowledged leader on this continent, in the design and construction of

coal mining plants, coal washers, and locomotive coaling stations.

In 1911, the cement gun began to be much discussed in engineering circles. Recognizing the possibilities of cement gun work from an engineering and contracting standpoint, Mr. Schaefer sold out his interest in the Roberts and Schaefer Company, and organized the Cement Gun Construction Company, of which he is the principal owner. The business has prospered. One of the early jobs done by

the company was that of the walls of the Armory, at the University. The company now has offices in Pittsburg in addition to the home office in Chicago.

Mr. Schaefer, being himself a forceful speaker and writer, has felt keenly the all too common deficiency of engineering graduates in the art of logical, concise and forceful expression. Much of an engineer's usefulness, both to himself and to the public, is lost if he cannot adequately express his ideas in speaking and writing. Engineering students commonly make the mistake of thinking that their success will be measured by the quantity of facts and formulas with which they can cram their minds. They overlook the fact that a jumble of



John V. Schaefer.

formulas does not constitute the solution of any engineering problem. It takes clear thinking, a logical use of facts and formulas to solve a problem; clear, concise, logical language is required to display engineering ability that people will employ and pay for.

Mr. Schaefer, as one of our loyal alumni, desires to see every engineering graduate of the University of Illinois become a successful engineer. He is endeavoring to encourage Illinois' engineering students to take a greater interest in their profession, and to cultivate the art of expressing themselves effectively and in good English. In furthering this, he has set aside a sum of money, the income from which he will give annually as the cash prize of an essay contest on summer engineering work.

# The Military Narrow Gauge Railway

F. R. SHOEMAKER, III, C., '23.

*This article was selected from the papers required by Pi Tau Sigma of its pledges. — EDITOR.*

The "army mule", traditional symbol of supply transportation in military organizations, is extinct. Modern armies, of unprecedented size, can no longer be dependent on the limited capacity, sluggish movement, and uncertain temperament of the mule as motive power for transport. The development of new machinery and methods of warfare, and the growth in importance, number of pieces, and types of artillery equipment used, have caused the adaptation of purely mechanical means of transport to military use, as a means of satisfying new requirements in tonnage and rapidity of movement.

The requirements to be considered—capacity, speed, and flexibility as to routes, leave a choice to be made between two means of transport: namely, the motor truck with its comparative freedom of movement, and the light railway, with its greater capacity and more restricted choice of route. The experience of the late war recommends the use of both means under a centralized control, but this discussion will be confined to a consideration of the construction, maintenance, and operation of light railways, as identified with combat operations of American troops in France.

Before the war, American experience in light railway operation had been largely confined to limited mileage in mountainous districts, and to such industrial railways as are used in large manufacturing plants, mines, building, and excavating enterprises. In contrast to this, France and Germany had long been using narrow gauge lines for service corresponding to our "local" and branch line service, and as a part of their military preparation, had covered their frontier districts with a network of sixty centimeter (gauge) lines. French engineers had even gone so far as to build a considerable number of "petite" locomotives with twin complete boilers, apparently headed in opposite directions, on the same running gear, with the purpose of confusing enemy observers as to the direction the engine was travelling.

Because of the lack of experience in military light railways, it was necessary to establish a new branch of service in the American army. Two regiments were added to the regular army for this branch of service, and the personnel recruited among railroad men in all parts of the United States. These regiments were sent abroad among the first contingents of American troops, and assigned to operation and extension of existing French lines.

The elements of a system of narrow gauge rail-

ways as applied to the European trench system of warfare are, first, a rail head or transfer depot; second, a system of track leading from the rail head to the points of consumption of supplies. The railhead is located as close as practicable to the trench lines, usually at a distance of from six to twelve miles from the line of combat. This distance is necessary to protect the relatively costly standard railway lines from enemy artillery fire. Supplies are brought to the railhead by the standard lines, unloaded and transferred to the narrow gauge lines which distribute them to the points of combat. The railhead is usually equipped with a warehouse, storage yard, and fully equipped repair shops for rolling stock.

An ideal system of narrow gauge railways, as quoted by Lt. C. S. Hemming, 21st U. S. Engineers, (L. R.) consists of the following elements:

- (a) Trunk lines from transfer depots to as near the fighting front as safety from observation and shell fire will permit.
- (b) Cross lines connecting transfer depots.
- (c) Cross lines connecting trunk lines at a distance of five miles back of the first line trenches.
- (d) Cross lines as close as possible to principal artillery positions.
- (e) Feeders and spurs to points of consumption of material.

This system allows approach to any point by several routes, thus preventing congestion of traffic or delay from damage to one or two lines by the enemy. Congestion and delay is further reduced by sidings at principal unloading points, and control of traffic obtained by a block system, with telephone operators stationed at all junction points and unloading points.

This scheme was not carried out completely in American operations in the Toul and Argonne sectors, because of the desirability of using the French lines already in existence, but American construction was carried out with a view of completing the system to conform as far as possible to this ideal.

The track used varies with the severity of traffic conditions. Near the transfer depots, along permanent lines, twenty five pound rail with wood ties has been found most satisfactory, while along lines more exposed to shell fire and subject to lighter traffic demands, sectional track formed by rivetting steel ties to twenty pound rail serves the purpose. The latter type of track is assembled in twelve to sixteen foot

lengths of eight to twelve ties, and can be laid and leveled with considerable speed when occasion demands. Experience shows that at least four inches of ballast should be used with the sectional track, and eight inches or more with wood ties and twenty five pound rail.

The lines toward the rear should be carefully graded, and for American equipment should have a maximum grade of about 1.5 per cent., with curves of not less than 170 foot radius. Careful attention should be given to drainage, especially through such cuts as are found necessary. Advanced lines may have a maximum grade of 3 per cent. with a curvature of not less than 100 foot radius. In planning routes advantage should be taken of the natural contour of the terrain to provide protection from enemy artillery fire, and where lines are exposed for considerable distances camouflage screens should be erected.

Experience during the late war has made possible fairly definite conclusions about routes, road beds, and track specifications, but seem to leave unsolved a number of problems in regard to motive power. Tractors for 60 cm. railways, as used by the principal combatant forces, fall into two grand classes, the steam locomotive and the gasoline or kerosene tractor. Both types were in use until the armistice, and each type presents its particular advantages and disadvantages. The steam locomotive, built along the general lines of its larger brothers of the standard railroad, has advantages in power and reliability, but leaves much to be desired in other respects. Fuel for this type is relatively bulky and difficult to handle, and a supply of water suitable for boiler use may not easily be obtained in all localities. Skilled engineers and firemen are necessary for steam operation, and some training is needed to fit even standard gauge operators for narrow gauge work. The limited size of boiler and firebox necessitates constant and careful observance to prevent rapid fluctuation of steam pressure and water level, and the intensity of draft generated at high steaming rates shows a troublesome tendency to draw the fire out through the stack.

Moreover, the high center of gravity of the steam engine induces a lateral motion of the water, and numerous turnovers and derailments, especially on poorly graded advanced lines. This trouble has been further aggravated by the attempt to use the saddle tank type of locomotive. When such tanks are only partly full, the inevitable swaying movement of the engine induces alateral motion of the water, and this shifting of weight from side to side is held responsible for numerous upsets which have occurred without other apparent cause. The American saddle tank engine gave additional trouble due to exces-

sive heating of feed water, which rendered injectors useless unless the water supply was frequently renewed.

The necessity for constant firing renders the steam engine dangerous on advanced lines at night, because the glare created by an open fire door makes a conspicuous target for artillery fire. The same statement is true of smoke columns in daylight.

From the standpoint of maintenance, the small size of the unit makes repairs on the boiler and firebox difficult of accomplishment. Some steam engines of French design have received favorable comment from American operators, but the chief difference in design to be noted between American and French practice is the tendency of French designers to use compound engines, and to build freak types in the hope of puzzling enemy observers. The compound engine is what would naturally be expected as a result of a limited coal supply in France, but the added complication of construction incident either to compounding or to freak design, such as the double end engine previously mentioned, is questionable from the standpoint of reliability, and economy of maintenance.

The gasoline or kerosene tractor has been built in various designs for light railway motive power, but the very variety of designs in use during the last war indicates that a satisfactory standard of design has not yet been recognized. The American type of tractor was built to resemble the steam locomotive in general appearance, inasmuch as the four cylinder motor was set under a large hood, the muffler set upright at the front end, like a stack, the operator's cab placed in the rear, and the drive communicated from the main drivers to the rear pair by the side rods usually identified with steam locomotives. This design presented little or no advantage over steam power in regard to the objectionable high center of gravity, and other objectionable features of design lead to the conclusion that American tractor design was not carefully worked out. For example, to remove the lower half of the crank case for main bearing adjustment or repair, it was necessary to remove the entire engine from its setting in the frame; the two speed forward and reverse gearbox furnished was not well adapted to the power requirements, the ratios being, on the whole, too high to get maximum draw bar pull at low train speed; no pony nor trailer trucks were provided to supplement the two pairs of drivers, and the uneven track often encountered imparted a longitudinal rocking motion which caused frequent derailments.

Several designs of captured German tractors were found to correspond in general type to the American equipment, except that the German power

(Continued on page 200)

# Before and After Graduation

H. T. Coss, cer., '22.

When the average young man, fresh from high school, arrives at the University and enrolls in one of the various courses offered in the Engineering college here, he has only the very barest of conceptions of the field he intends to make his life work. If he survives and masters a strenuous engineering curriculum till he has merited his sheepskin, he undoubtedly has gained a broad, fundamental knowledge of his chosen field. But even then he is lacking in a proper appreciation of the relative values of the courses he has taken in respect to his profession, and he is usually either under a misapprehension as to what will be his reception and what will be required of him in the practical world, or is totally ignorant of both.

Assume for example, the case of the average electrical engineering senior. Although he may have spent his summers at an R. O. T. C. camp, or on a Great Lakes vessel as a wireless operator, or at Schenectady, he has not had an opportunity to determine which of his courses is the most valuable, or what he should place particular emphasis on while in school. Of course he knows what he is most interested in, and what he enjoys most, but the qualifications for success, the opportunities in the respective technical and business sides, and the opportunities to advance to executive positions, along with what he will ultimately regard as his most important courses, he does not know.

The Illinois Student Branch of the American Ceramic Society, realizing the prevailing conditions, determined to ameliorate or remedy them as far as possible. In an attempt to do this, it sent out to a selected list of fifty-five University of Illinois ceramic engineering graduates, a questionnaire, the answering of which involved answering several of the points raised above, as well as some others. The letter which accompanied the questionnaire read in part as follows:

"You are a graduate in Ceramic Engineering. We, who are still in school, are attempting to get, through you, who have preceded us, a survey of the conditions we will eventually meet.

"We wish to get your impression of the situation and would, therefore, appreciate your frank opinion of the prospects for the ceramic graduate in technical or executive capacity and the financial possibilities ahead of him. Your opinion and suggestions may help us to better fit ourselves for the work ahead of us."

Most of the graduates have answered the questionnaires. As these graduates represent men from the classes of 1908 to 1921, inclusive, and are

engaged in different capacities in all sorts of ceramic or allied work, varying all the way from ceramic chemists or kiln foremen on brickyards to the editor of a large technical journal and superintendents and managers of large plants, the consensus of their opinion should be as accurate a criterion of conditions as can be obtained.

Since the application of scientific and engineering principles to ceramics is comparatively recent, the answers to the questionnaires have a peculiar value to ceramic students. An indication as to the reason for this may be observed in the following quotation from one of the letters. The alumnus is the editor of a large trade paper:

"I believe there is a very good prospect for advancement for the Ceramic graduate if he can deliver the goods. I might say, however, that in my contact with many ceramic engineers employed on plants throughout the country, I find that there is a bit of prejudice and antagonism against him, which, unless he is tactful and diplomatic, he will find hard to overcome and it will be difficult for him to make headway. In some plants it has been the experience of ceramic engineers that the employees endeavored at every opportunity to upset their program. In this respect the technical man in the ceramic industry has greater obstacles to overcome than technical men in other engineering lines."

Some of the questions pertained particularly to Ceramics, but several were asked and answered in such a general way that the results will probably be of interest and value to all engineering students. Briefly, the results of the questions pertaining to Ceramics may be summarized as follows: All but one of the graduates are engaged in ceramic work, and he is with a consulting engineering firm. The work is entirely satisfactory to all but one, and he has made no material progress since graduation. Approximately half are in the brick and allied businesses, and half are in work of highly specialized character. A large majority have positions of both technical and administrative nature. Salaries are judged to be better in Ceramics than in other engineering lines, at least at the start. The consensus of opinion is that there is very good prospect for advancement for the ceramic graduate. One says:

"There certainly is good prospect for advancement for the ceramic graduate, especially if he has educated himself to be thorough, and learns how to analyze himself as to his relative importance to the successful conductance of the business of his company."

The next question, of general interest, was as follows: "Are the openings best in the technical or

business side of manufacturing?" Most of the alumni consider that openings are best in the business side of manufacturing when opportunity for advancement and higher salaries are considered. However, they also think that the openings in business usually come through technical work. A singular view taken by one man who declares that:

"The best opportunities from a money standpoint appears to me to lie in going into business for oneself shortly after one leaves school. There are many lines in which it is possible to go into business on a very small capital."

Another says:

" . . . . . opportunities are endless. The compensation for services rendered depends upon the individual. However my advice to the young man would be to seek out a means of self expression rather than a maximum of compensation. He will find, if he takes an interest in his work, the question of salary will take care of itself."

A vast majority are favourably inclined towards the opportunity for the technical man to advance to an executive position. To quote from a letter:

"There is a good opportunity for the technical man to advance to an executive position provided he can readjust himself and forget some of the things he learned in school which tend to make him too dependent upon the theoretical and natural laws which make one look for certain definite results from respective causes. The trouble with a man with technical training is that in all his training he has dealt with concrete facts, and when he comes out in the world where he must deal with such great variables as human nature and business conditions he is lost. A knowledge of psychology and economics would be of great value to him in this regard."

Several emphasize the value of summer work in the technical line being taken, and think it should be added as a regular part of the four year curriculum. In addition one says:

"Without referring in detail to the courses in the curriculum, I would say that all of them are important, and worth while. It is my opinion that not enough of the scientific and engineering courses can be covered in the four years course to fit oneself as well as one should be to measure up to the bigger jobs later in the business or administrative end. I would advise that as much chemistry and mechanical engineering as you can possibly get be taken, and that all the plant visitations, inspection trips, lectures, etc., for other engineering courses, as well as those provided for your own ceramic courses be taken advantage of. There is as much, if not more, to be learned in this way as in your classwork and readings, and what one sees and hears on such trips usually makes a lasting impression on the mind, and is bound to be of some direct or indirect value later on. Knowledge gained on these inspection trips supplies an abundance of information with respect to many problems, and it is often of special importance to have noted what methods, systems, or policies with respect to its phases of technical or ad-

ministrative work did not work out well, as well as what did. In other words, attempt to learn as much from the experiences of others, for if everything must be learned through your own experience only, you cannot advance your standing nearly so rapidly.

"If it could be added to the curriculum, students should be obliged to employ themselves during the vacation periods in the various branches of the industry, and I would lay special stress on the value of interspersing your education with a full year or two of work in the various branches of the industry, taking if necessary five or six years before the course of study is completed, and in this way you will be helped in finding yourself, so to speak, where you would become the best success."

The natural question to follow such a one as, "What, if anything, should be added to the curriculum?" was, of course, "What could it replace, if anything?" A majority of the graduates were in favor of such business courses replacing advanced mathematics and foreign languages, and in some cases, advanced chemistry. One man, who by the way, was Tau Beta Pi and Sigma Tau while in school advanced the following rather singular view:

"Algebra, Trigonometry, French, and German, are valuable but should be required for entrance, not taught as college course. I would eliminate Descriptive Geometry entirely and reduce greatly the time spent on Analytical Geometry, Calculus, and Quantitative Chemistry."

The last question asked was very general, and the alumni responded to it with all sorts of advice. It read "What single factor do you think is most essential to success in Ceramics?" Although Ceramics was specified, the answers are so evidently applicable to most engineering lines that they should be instructive, if only as the expressions of opinion of men who have passed through the years directly after graduation. To quote:

"I should say that a thorough understanding of chemistry and the mechanics of engineering is absolutely necessary. Having acquired this, one should have the ability to analyze unmistakably his problems of the minute, to know and understand his superiors and employers. Then, think clearly, plan methodically, and work hard systematically, and if you have been an intelligent student, you will possess the fundamental knowledge required in all engineering industries, which, together with practical experience as you gain it, will guide you safely and fill you with confidence in your ability to solve all your problems and make good. The importance of common sense cannot be too greatly emphasized. Deliberate sufficiently over your problems before attempting to draw conclusions, and keep a balanced mind. Please be mindful of the fact that what work is prescribed for you is only a small part of what really should be done. For the most part you must help yourself; that is, you must read, investigate, and gain your experience in a small way here

(Continued on page 199)



# EDITORIAL

## THE TECHNOGRAPH STAFF

Donald A. Monro '22	Editor	Walter A. Mueller '22	Business Manager
J. W. Harriman '23	Assistant Editor	W. J. Klingberg '22	Circulation Manager
M. F. Jansson '24	Assistant Editor	W. B. Mathews '22	National Advertising
D. C. Murphy '23	Assistant Editor	W. R. Enyart '23	Local Advertising
P. F. Witte '23	Assistant Editor	H. L. Funk '23	Asst. Circulation Mgr.
C. A. Cahill '22	Art Editor	C. Bowen '23	Assistant Business Manager
		R. L. Hedrich '23	Asst. Business Mgr.
		R. E. Gould '23	Asst. Business Mgr.

## ASSISTANTS

P. T. Dedman '22	R. B. Taylor '25	J. B. Clausen '24	A. B. Durham '22
D. P. Buchanan '24	L. R. Ludwig '25	Stanley Fey '25	W. F. Gerdes '24
F. M. Rich '24	I. L. Vendig '25		
G. T. Dingley '25	R. G. Raymond '25		

## DEPARTMENTAL REPRESENTATIVES

H. W. Butterbaugh	A. A. E.	J. M. Agnew	Electrical
C. C. Council	Architecture	G. W. Reed	Mechanical
H. S. Coss	Ceramics	C. H. Dodge	Mining
W. A. Gaudier	Civil	S. M. Ellman	Railway

## A SERIES OF CONVOCATIONS

The Ricker Convocation not only afforded us an opportunity to do homage to a man who labored long in the interest of Illinois, but it also was a source of personal inspiration. The engineers' parade to the auditorium, the assembly into one great body of all engineering students and faculty—comrades in our chosen profession—was a most invigorating experience.

Because we believe these feelings were common to the entire audience, we suggest that a series of semi-annual convocations be founded at which all members of the College of Engineering can assemble. The program shall consist of an address by a man of national prominence—a man occupying a "big"

position in the field of engineering. The convocations not only would inspire the students, but they also would interest the speakers, and the firms they represent, in the University of Illinois.

To perpetuate in our minds the memory of a man whom we admire and respect—a man whose life has been spent in developing our College—nothing can be more appropriate than to name the lectures after Professor Ira O. Baker.

The task of inaugurating such a series of lectures is peculiarly fitted for the energies of an honorary engineering fraternity. Is there one that will undertake it? We have presented the idea to you, if it is feasible, make it an actuality.

## ENGINEERING ESSAY CONTEST

With the publication of this issue, summer and its opportunities for engineering work are only a few weeks distant. To merely engage in engineering work during the summer is of little value; to benefit thereby, one must observe closely, investigate, and record the interesting and unusual features of the job. To stimulate these practices, Mr. John V. Schaefer will again give a first prize of \$25 and a second prize of \$15 for the two best papers on summer engineering experiences submitted by students in the College of Engineering. A statement of the other conditions of the contest may be obtained from the editor. Because photographs and sketches made by the author shall accompany the paper, we advise

you to begin the preparation of your article while you are on the job; the subject matter for the illustrations will then be available, and the details clearly in mind.

Many benefits will accrue to the writer of an article submitted in this contest, and we urge every engineer to seriously consider the preparation of such a paper. Efforts made to become proficient in the art expression are well repaid, for as Dean Richards has stated, "there is no question that engineers as a class would be accorded a higher place in the estimation of the world, if they were better able to express themselves clearly and forcibly."

## FINAL HONORS

The University has again rewarded the men who have attained high scholastic standing during their Junior and Senior years. Upon the recommendation of the faculty of our College, twenty three seniors have been accorded final honors by the Council of Administration. It is in this way that Alma Mater has chosen to commend at graduation those sons who have merited such distinction, and to say to them, "Well done."

The man who receives Final Honors has excelled in the most important part of his university work. Therefore, it behooves us who have been outdistanced in the race to congratulate him either by way of conversation or in the seriousness of friendship.

To you men who have received Final Honors, we offer our congratulations. We regard you with respect.

## STUDY FACILITIES

During the day from eight until five, the facilities for study in the College of Engineering fall far short of adequacy. The engineering library is no longer sufficiently large to accommodate the students, and the few departmental reading rooms offer little relief. The engineer can not go to the libraries of other colleges as they also are overcrowded, and if he is forced to leave the Campus to study between classes, he will lose much valuable time.

The capacity of the engineering library can be materially increased by providing racks for hats and coats which now by necessity occupy a large part of the tables and chairs. However, if addi-

tional study rooms in the group of engineering buildings were available, much of the congestion would be relieved. If because of the classroom shortage, it is impossible to assign rooms for that purpose exclusively, a schedule should be prepared indicating the times the various rooms are available for study. We have frequently found it necessary to search out an empty classroom in order to study; with no guide, it involves the loss of valuable time.

The point is that additional facilities for study are needed; the means toward the end are merely incidental.

## WHY WORK DURING THE SUMMER

The statement that three months of practical work in a shop is a very valuable supplement to the nine months of theory received in college in one year is evidently true. While some institutions have adopted a more radical division of the year into two six months periods, one being spent in the shop and the other in the classroom, it would seem to be better to limit the shop work to three months out of the year provided the student can meet the expenses of nine months in college. However, the present curriculum does not require that an engineering student devote any time to the shop or field, but leaves the matter entirely to the individual; and therefore, unless the student really needs the money he can earn, the anticipation of the pleasures of a summer vacation will blind him to the need of practical work to supplement his theory. Three months of practice will point out the impracticability of part of his book learning. It will give him the proper perspective from which to ascertain the correct value of college training, and will teach him that, after all, the successful man is the one who can do the job a little better than the other fellow; whether he has a degree or whether he left school before the eighth grade makes little difference. All this, however, is very trite and has

been repeated time and again, and, while most everyone admits the truth of such statements, human nature takes the easiest path unless the individual is impelled by real ambition and determination.

But there is more to this argument. The outstanding benefit from field and shop work, which can be obtained in no other way, and without which no measure of intelligence can make a complete education, is contact with human beings. We spend the four so-called most impressionable years of our life in a highly isolated community. As a group, college students represent less than one per cent. of society. Yet, for the most part, the only persons we know are all of this same group. Considered as a type in society we are alike as peas in a pod. We think the same things, and talk on the same topics. We dress differently from other classes of men. Stiff collars are viewed with scorn, and one is led to believe that a man's merits are judged by the length of neck displayed and the prominence of his Adam's apple. However, that we still retain a spark of our normal initiative is shown in some of the desperate attempts to be different, which has resulted, for instance, in some of the ridiculous

(Continued on page 210)

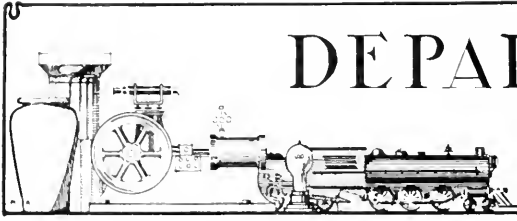

# DEPARTMENTAL NOTES

## FINAL HONORS; COLLEGE OF ENGINEERING CLASS OF 1922

BOWEN, WILLIAM V.  
BRANDHAM, IVAN B.  
BREYFOGEL, ALBERT W.  
DEYOBE, JACK JOSEPH  
DUSENBERRY, PAUL B.  
GLUSKOPFER, SAMUEL P.

HARRIS, DONALD A.  
HORNBACK, ROBERT H.  
HOWIE, JOHN L.  
KERCHNER, RUSSEL M.  
LANDHLY, IRWIN T.  
MASON, DAVID H.

MATHEWS, W. B.  
MEWES, FREDERIC T.  
MONRO, DONALD A.  
NAVYOR, RALPH E.  
O'CONNOR, ROGER R.  
RODGERS, WILLIAM H.

SANDERS, AZEL L. R.  
SELLIG, LESTER  
SUNDEN, ALFRED D.  
STEIN, HERMAN W.  
TEGTMAYER, LAUREN E.

## ARCHITECTURAL NEWS

### THE ARCH FETE.

As the date of April 7th swept from the vague future into the pulsating present, all interest and energy in the Department of Architecture centered on the annual Arch Fete. Athens, the cultural center of the ancient world, the Athens of Alexander, was to live again on the fourth floor of Engineering Hall.

Alexander had been absent from Athens for several years, fighting in Asia Minor and Egypt. The people were anxious for word of their monarch as they gathered before the oracle. The high priest requested the oracle to speak, and word was returned that Alexander had conquered the entire known world and was even then returning victorious to Athens. A blare of trumpets announced the triumphal entry of Alexander into his capital.

The seniors of the department, as the cream of Athenian citizenry, the scholars, poets, philosophers, statesmen, logicians, mathematicians, architects, sculptors, musicians, etc., gave to Athens its cultural atmosphere. The juniors as the subjugated peoples from Persia, Egypt, Assyria, and Babylonia lent a cosmopolitan aspect to the setting. The Sophomores were the soldiers of Alexander, while the scene was not complete without the slaves, beggars, camp followers, etc., from the ranks of the freshmen.

The decorations for the Fete were determined by special sketch problems issued to the various classes in design. The senior competition for the

decoration of the fourth floor hall was won by E. C. Berendes, who had charge of that section of the decoration. C. L. Martin won the junior competition for the decoration of Ricker Library. The sophomore class competed for the decoration of the stairways leading from the third to the fourth floors.

This year's Fete was one of the finest ever given by the department. Much credit for the success of the Fete is due the members of the faculty and the Fete Committee under J. P. Turner. It is planned to take a different period of architectural development for each year's Fete. Two years ago the Fete was Egyptian; this year it was Grecian. Succeeding years will carry the scheme through to modern times.

### ARCHITECTURAL SOCIETY.

The Architectural Society held another of its successful smokers at the Union Building, March 7th. New officers elected were: C. G. McTaggart, president; Fay Harris, vice-president; K. L. Smith, secretary and treasurer; P. V. Duell, faculty representative. Speeches were made by Professors L. H. Provine, R. Newcomb, P. V. Duell, C. E. Palmer, and J. E. Burgess.

The Society has been very fortunate in securing architects of national prominence as speakers. On February 22nd, John V. VanPelt, New York architect, addressed the society on the subject "Composition in Architectural Design". The seniors of the department gave a dinner in honor of Mr. VanPelt before the meeting.



#### SCARAB ACTIVITIES.

The Annual Scarab Medal Competition, established by Scarab Fraternity is now being conducted. Survivors of the preliminary contest are: W. E. Armantrout '24, J. A. Drielsma '23, E. C. Gauger '23, O. Stepan '24, and C. G. McTaggart '23. The subject of the competition is a municipal monument and reviewing stand. The final drawings were due Wednesday, April 12th.

Scarab Fraternity held a smoker, March 9th, at the Beta Theta Pi House for the men of the department. Short speeches were made by Professors W. C. Titcomb, R. Newcomb, L. C. Dillenbach, N. T. Crandall, K. B. Lohman, and E. Langford. J. M. Skinner entertained with some excellent white magic and succeeded in baffling his audience.

The following men have recently pledged to Scarab: Prof. O. G. Schaffer, J. L. Berner, C. O. Hoopes, M. James, F. W. Lang, H. E. Machamer, C. L. Martin, C. J. Matthys, G. W. Mattson, E. H. Mittlebush, R. W. Naef, L. A. Siber, K. L. Smith, and H. W. Wolaver.

A meeting of the Gargoyle Society was held at the Alpha Tau Omega House, March 2nd. N. B. Hazen presented a paper on "The Influence of Thomas Jefferson Upon American Architecture."

The following men have been pledged to Gargoyle: M. A. Abbitt '22, E. E. Lundeen '23, C. L. Martin '23, E. V. Gauger '23, H. R. Russell '23, C. B. Uthus '23, R. W. Naef '23, T. C. Epps '23, and C. E. Bell '23.

### A. A. E. NOTES

Professor Wiley, of the Civil Engineering Department, gave an interesting lecture before the Student Branch of the American Association of Engineers on January 14, 1922. His talk was on "The Road Building Policy of Illinois". Professor Wiley's specialty is highways, and in his talk he pointed out some of the good features of the policies of the highway committees. "The reason," he said, "that so many people think the methods are poor is because they do not realize the scope of the problem." The State's plan has been to build the roads that would be of use to the greatest number of people. He showed the great progress that Illinois has made under the existing conditions. The lecture was followed by a discussion which proved that it had interested all those present.

Professor Drueker, of the Mining Department, spoke on March 8, 1922, to a large audience on "The Opportunities of a Young Engineer in Foreign Fields." During the first part of this talk Professor Drueker related some of his experiences as an engineer. He told of the many difficulties he encountered

while in the Southwest, and how he overcame some of them. Later in his career he went to Korea, China, and other foreign countries. He mentioned some of his interesting experiences with the people of these countries and concluded by pointing out the opportunities for a young engineer who is willing to undergo the hardships of South America.

On March 27, 1922, Professor Moore of the Department of Theoretical and Applied Mechanics talked on the subject of "Materials Engineering." He told how this branch of engineering had separated itself from the other branches because of its increased importance. It used to be that no particular thought was given to the materials used in construction other than to make them strong enough, and this anyone could do. In comparatively recent times, however, engineers have come to realize the importance of the other properties of materials, and out of this has grown the Materials Engineer. All projects use material of some sort, and their progress is in proportion to the quality of material used. To a large extent people base their judgment of engineering on its spectacular results. "The Materials Engineer", he said, "is remembered for his failures and not for his successes. If a structure stands they will not ask why, but will be satisfied that it is successful."

### CIVIL ENGINEERING NOTES

A. S. C. E. NEWS.

The A. S. C. E. Society conducted its annual inspection trip on April 23. The party, consisting of about thirty members, visited engineering projects of interest in and about Decatur. The itinerary included a visit to the following places: the Decatur Bridge Company, where the fabrication of several steel bridges was in progress; the Staley pumping plant with a capacity of seven million gallons of water per day; the new impounding dam across the Sangamon River; and the Macon County coal mine through which a trip of several miles was made.

The members of the society received the most cordial treatment everywhere and were delightfully entertained at luncheon by the Decatur Hlmi Club.

By Professor Ira O. Baker's resignation, the society is losing one of its oldest and most loyal friends. Professor Baker was one of the founders of the society (the old Civil Engineer's Club) in 1883, and has helped to foster its ideals ever since that time. A banquet was given in his honor by the society on May 3, as an expression of the appreciation of his services to the society. A plan is at present on foot to establish some form of permanent memorial dedicated to Professor Baker.

## CERAMIC DEPARTMENT NOTES

### CERAMIC SOCIETY ACTIVITIES.

The first meeting of the Student Branch of the American Ceramic Society for the second semester took place in the Union Building on February 8th. The officers of the preceding semester were re-elected. John R. Green '22 was retained as Chairman, R. E. Lawrence '22 as Vice-Chairman, and I. B. Branham '22, as Secretary and Treasurer. R. E. Arnold '22, was appointed to represent the Society on the Engineering Dance Committee. After the business of the meeting was concluded, entertainment, apples, and smokes were provided.

On February 24th, at 119 Physics Building, the second meeting was held. Dr. K. H. Endell, Professor of Ceramics at Charlottenburg Institute of Technology, Charlottenburg, Germany, although handicapped somewhat by his unfamiliarity with the English tongue, gave a very instructive illustrated lecture on various phases of the refractories industry in Germany. He showed and explained a large number of slides which gave the Society an idea of the progress that has been made in Germany in scientific investigation on glass pot manufacture and the allied industries during and since the war.

On March 9th, the Society met again in the Union Building. Following the regular business of the meeting, Mr. G. H. Radebaugh, superintendent of the machine laboratories, gave a talk on Product Routing and Time Studies. Mr. Navais, of the Ceramic Department, explained the method he is using for determining specific heats at high temperatures. He employs a large water cooled calorimeter, heats the clay by means of a resistance coil, and then drops it into a vacuum in the calorimeter. Special factors enter in to make the determination very complex. As there is no authoritative data available on the subject, his work has a peculiar significance.

At 7:15 P. M. on March 15th, in 221 Engineering Hall, a motion picture on "The Manufacture of Electrical Porcelain" was shown to the Society. The film traced the manufacture from the raw state to the finished product, and was as interesting as it was instructive.

### DEPARTMENT NEWS.

The Freshman class in ceramic engineering will have the opportunity of seeing instructive motion pictures during their ceramic lecture periods at 1 o'clock in 218 Ceramics, of the dates indicated below. Anyone interested is welcome to attend these pictures, which will undoubtedly be worth while.

March 31st, "The Story of Asbestos", U. S. Bureau of Mines,

March 31st, "The Story of Asbestos", U. S.

April 8th, "Face Brick".

April 21st, "Manufacture of Zinc Oxide".

April 28th, "The Manufacture of Pyrex Glass".

May 5th, "Cement".

May 12th, "The Manufacture of Mazda Lamps".

All of the seniors are doing thesis work this semester. R. E. Arnold is working on "The Use of Phosphates in Developing a Bristol Glaze". D. B. Atwell's subject is "The Development of a Yellow Terra Cotta Glaze". I. B. Branham is continuing his last semester's work on "The Specific Heat of Quartz". H. T. Coss is working on "The Development of a Colored Belleek Body". J. R. Green is engaged in a study of "Some Dental Cements". J. S. Lathrop is working on "Adventurine Glazes", and R. E. Lawrence on "Translucency Determinations by Means of the Photo-Electric Cell".

Dr. Washburn and Dr. Bunting have completed their work on the determination of porosity by the method of gas expansion, and have written up their method in the Journal of the American Ceramic Society for January and February. The gas expansion method is a distinct innovation for determining porosities. Whereas the old method of immersing a ceramic body in a liquid was tedious and inaccurate, the new method is rapid, clean, and highly accurate.

The entire Ceramic faculty attended the Annual Convention of the American Ceramic Society in St. Louis from February 28th to March 2nd, inclusive. Prof. Hursh was re-elected treasurer of the society. Dr. Washburn, Professor Parmelee, Dr. Bunting, and Mr. Navais presented papers. Prof. Parmelee proposed a new classification of clays arranged according to their burning behavior. He also presented a paper on "Fire Clay in Illinois". Dr. Washburn and Dr. Bunting presented a paper on "A New Method For Measuring the Porosity of Brick", and Dr. Washburn and Mr. Navias presented a paper on "The Products of the Calcination of Flint and Chalcedony". Dr. Bunting also gave a "Note on the effect of Manganese in Glass Melting at Reduced Pressure". J. R. Green, '22, also attended the convention.

### KERAMOS.

Keramos, the honorary Ceramic fraternity, recently pledged the following men: Sherman Lee '23, R. Gabreath '23, H. T. Levern '23, H. F. Bopp '23, R. F. Larson '23, S. O. Neiswanger '23, H. L. Cook '23, R. H. Cook '23, D. H. James '24, R. J. Louden '24.

## ELECTRICAL ENGINEERING NOTES

### SOCIETY ACTIVITIES.

The first meeting of the E. E. Society in the second semester was held in the E. E. Lab, Friday evening, Feb. 10. As is the custom, the first meeting was devoted to speeches by the faculty members and this year by Electrical Show officers as well. The speaking was followed by the customary "feed". Prof. E. B. Paine spoke on the show, its scope, its purpose and some of the benefits derived by everyone who takes part in the work of putting on the show. He said it was the largest project of its kind in the country and would have to have the coöperation of all students in the department to make it successful. He emphasized the valuable training which working on the show gives to prospective engineers in giving them specific duties to perform, and a definite goal toward which they all may strive together, working in coöperation and with an interest in accomplishing the tasks assigned to them. Prof. A. R. Knight added a few words, further stressing the advantages gained by actual engineering problems which arise constantly in a small way throughout the preparations for the show.

The speech, to hear which all ears were cocked throughout the evening, was then made by President Vallier. Although the shortest one on the program it met with the quickest and most willing response; "Line up for cats". No one could be blamed if, after his first serving of milk, cream puffs, and apples, he found his way into the line a second or even a third time.

At a meeting on February 17, a discussion of programs resulted in a decision to follow three definite lines: one of which, the practice of having members relate summer work experiences, has been used before successfully. Another suggestion was to have men from other colleges talk before the society, for example, inviting a representative of the College of Commerce to talk on the business side of engineering. A third plan is to bring practicing engineers here to acquaint undergraduates with a few of the difficulties which confront them after graduation. This has been done to some extent in the past by the A. I. E. E. and the coöperation of the E. E. Society. This is especially of interest to upperclassmen but those just beginning their engineering courses would also be benefitted.

#### A HISTORY OF THE E. E. SHOW

C. L. CONRAD

In the spring of 1907 a nation-wide campaign was launched for a John Fritts Memorial. The Students in Electrical Engineering at this University were asked to contribute their share towards

this memorial, and the question was "how were they going to raise the money?" They conceived the idea of presenting a small electrical exhibit and charging a small admission price. The show was such a success that they were able to forward \$250 to the memorial fund, this being far in excess of any other contribution. The first show was on such a small scale, similar to the demonstration at open house, that it was prepared in a week's time with practically no expense. The '08, '10 and '12 shows, each being a little more elaborate than the preceding, were increasing in popularity until it was found impossible to handle the crowds in the E. E. Laboratory, and it was necessary either to abandon the show or find more room.

In 1915, the new armory was completed and with the removal of the army equipment from the old armory (now the gym annex), it was decided to use the E. E. Laboratory and the gym annex and to run the show for three days to care for the crowd. This plan was followed for the '17, '20, '21, and '22 shows. The 1907 show was presented by 200 students at practically no expense; this year's show was presented by 450 students at a cost of about \$4,000. So much for the history of the show. The Electrical Show has become an established exhibition, and the people in the different parts of the country, as well as in our own vicinity, look forward to it.

The purpose of the show is twofold. In the first place, it helps the students by bringing them in contact with the actual practice of the theories they have been studying, by developing their ingenuity in working out different applications and uses of electrical machines, and by working out theoretical principles; secondly, it demonstrates to the public the many new uses of electricity.

The show is presented by the Electrical Engineering Society with the support and coöperation of the Department. The actual work of the show is divided among a staff, headed by a General Manager, with the following departments: engineering, business, finance, advertising display, and radio. Each department head has several assistants, and the staff is selected by the General Manager from the students in Electrical Engineering.

The engineering department of this year's show, headed by E. K. Krause, '22, has developed many new and instructive freak exhibits, most of which have never been presented before. A large number of students have been quietly developing these exhibits since last October. The industrial field is represented by the exhibits of several large companies.

Through the efforts of the publicity and advertising department, headed by E. W. Taylor, '22, this year's show has received the attention of many peo-

ple throughout the country, inquiries being received daily on some particular exhibit or phase of the show. The show has been a very successful means of presenting the University of Illinois and especially the Electrical Engineering Department to the public and to the leading engineers of the country. The success of the show is the success of the University, the publicity of the show is the publicity of the University.

## MECHANICAL ENGINEERING NEWS

A. S. M. E.

An illustrated lecture dealing with Heating and Ventilation Installations was given by O. K. Dyer, assistant sales manager of the Buffalo Forge Company, at the first A. S. M. E. meeting of the second semester. E. Jay Bolmen, newly elected president of the organization, presented Prof. Willard, who made a few introductory remarks concerning the speaker.

Mr. Dyer brought out the point that most heating and ventilating problems are without precedent and that careful investigation with consequent analysis form the only means of solving the majority of these installation problems. The dye industry was mentioned as an instance in which unique questions invariably arise.

### 100,000 POUND HYDRAULIC TESTING MACHINE.

The 100,000 pound hydraulic testing machine, which was recently made in the mechanical engineering shops, and which is now assembled in the forge laboratory, is being tested by a series of experiments to determine its properties prior to the installation of the unit as a supplement to the equipment of the shops.

During the preliminary tests which have been made upon the machine, using an auxiliary hand oil pump as a source of power until the steam line has been connected, its performance has fully come up to expectations.

The advantages claimed for this type of testing machine are: perfect self alignment of the test specimen, which avoids eccentric loading, prevalent in all geared machines, a more accurate measurement of the load by means of a pressure gauge, together with an autographic record, and the possibility of greater speed of application of load. One disadvantage of the hydraulic machine, however, is that the force of friction is not applied to the load, but is measured and hence must be corrected for various readings. It is planned to use the machine in conjunction with heat treatment work carried on in the forge shop on various materials.

### A NEW TREATMENT FURNACE IN THE FORGE LABORATORY.

A unique heat treatment furnace has been made in the forge laboratory during the past few months, and at present is ready for future tests to determine its utility.

The furnace is city gas fired and is 12 inches by 18 inches by 22 inches in size with a 2 inch annular space surrounding the combustion chamber. Outside of this annular space is a one-half inch covering of insulating asbestos board. The gas enters the furnace through eight ports, three in each side and two in the bottom, then passes into the annular space described above. It is believed this arrangement will materially lengthen the life of the lining by decreasing the strains due to the vastly unequal temperatures on each side of the setting, and will also serve as a means of holding the temperature very nearly constant, a great advantage in heat treatment work.

### M. E. SENIORS' DINNER.

The mechanical engineering seniors gathered at the Green Tea Pot, March 25, for the first of a series of informal dinners which this year's graduating class is holding in order to organize the men leaving this June. Faculty members of the department addressed the class upon various phases of their profession, and Professor Leutwiler strongly urged the class to adopt some form of organization whereby they would remain in touch with one another in future years.

The members, acting upon Professor Leutwiler's suggestion, agreed upon the plan whereby each member of the class would write the secretary at least once a year. Mimeographed copies of each letter to be made and sent to the remainder of the class.

The dinner was most successfully conducted by the toastmaster, K. C. Brown, and terminated with arrangements for another meeting.

### THE COURSE IN AERONAUTICS.

The mechanical engineering course at present includes among the technical electives offered to seniors a full year of study of the principles of aeronautics. Prof. Riddell, who has charge of the course, a parallel of which is given in very few American universities, graduated as a Structural and Mechanical engineer from the University of Toronto, and is thus exceptionally well qualified to lecture on this subject, which is essentially a structural as well as a mechanical engineer's problem.

When Canada entered the late war, Professor Riddell accepted the position of Designing Engineer with the Canadian Curtis Company, and in that capacity aided in designing the modifications of the Curtis JN4 plane, which, when assembled, was commonly known as the Canadian Curtis.

The course as given acquaints the mechanical engineer with many fundamental phases of engineering work to which he would ordinarily give very little thought. The numerous forms of graphical truss analysis in common usage as well as the fundamental aspects of the flow of fluids applied to air streams, stream line bodies, and their action in reducing head resistance are dwelt upon.

The performance of a plane, or speed, rate of climb, and angle of climb as affected by the inherent properties of drag, lift, power of engine and thrust of propeller are thoroughly emphasized in a problem involving these factors. The question of structure and design, to meet the conflicting set of specifications always represented in engineer requirements, is considered from the standpoint of the three moment theorem as practiced in actual design.

The course provides a fine combination of fundamental engineering concepts applied and presented in a most intelligent manner to a youthful enterprise whose future utility depends entirely upon the scientific exploitation of it during the coming years to render it of appreciable commercial value.

---

#### PI TAU SIGMA.

On March 23, 1922, Pi Tau Sigma, honorary Mechanical Engineering Society, entertained a number of the junior Mechanical Engineers at a smoker given at the Phi Sigma Kappa house. The entertainment was furnished by an orchestra, a sleight-of-hand performance, and plenty of smokes, together with short addresses by Professors Willard, Goodenough, and Macintyre.

---

The following students in the Mechanical Engineering Department have been pledged to Pi Tau Sigma: Prof. C. W. Ham, C. Bowen '23, J. L. Cavins, '23, G. G. Dyer '23, R. E. Gould '23, R. L. Hedrich '23, F. R. Shoemaker '22, J. F. Tobin '23, R. E. Vogel '23, G. F. Yackey '23, H. H. Yackey '23.

## MINING DEPARTMENT NOTES

### MINING SOCIETY ACTIVITIES.

At the semi-monthly meeting of the Mining Society, March 7th, Prof. H. H. Stock gave a comprehensive outline of the annual meeting of the A. I. M. E., which was held in New York. Prof. Stock said that the four or five hundred delegates were well

entertained and acquired valuable information on the latest mining methods. During the ensuing year a symposium of mining methods is to be assembled from questionnaires sent to all mining communities, which promises the most valuable statistics yet collected on this subject. Mine operating costs were revealed in the papers presented, which portends less secrecy in the future and makes possible greater research in mining economics. The usual inspection trips to nearby industrial centers were enjoyed by many. To date there are 10,205 members of the A. I. M. E. One bit of information which should be well received is that the 175,000 volumes in the Engineering Library at New York can be drawn on by all A. I. M. E. members through mailed application.

The miners had their first smoker of the semester at the Illinois Union, Thursday evening, March 23rd. The members present were well repaid for their attendance by the entertainment provided by President Heinrichs and Chairman Allison. Prof. Drucker spoke and advised all to join the A. I. M. E., as it is one of the best channels through which influential friends are made. He said that it is most essential to become a good mixer and so be able to hold one's own in the presence of other engineers and men of the business world. Mr. Sanford, father of one of the members present, gave a very impressive impromptu talk warning the fellows to adhere to their ideals and stand the tests that come after graduation in order to secure their deserved places among engineers. He gave an interesting aspect of the impending coal strike, stating that in his opinion it could not succeed because of the greater possible output by nonunion mines. He gave the men to understand that the weeding out process in mining engineering is much surer and more relentless than in most other forms of service. Prof. R. W. Arms entertained with vocal solos and was assisted by H. C. Eckart, '22. E. C. Johnson, '23, got off his usual assortment of dinner jokes. Plans were announced for the annual banquet to be held at the Hotel Beardley.

---

### DEPARTMENT NEWS.

Prof. Drucker spoke at a recent meeting of the Foreign Trade Club on "American Goods and Machinery in Foreign Countries". He stated that foreign made machinery, especially German made, was outstripping our own because of its superior workmanship and better metal composition. Foreign machines are distributed more rapidly and with greater ease than our own because of standard sections that can be quickly and easily dismantled and transported. America must put more emphasis on quality as well as quantity.

Prof. Arms has been conducting an investigation in ventilation with the purpose of improving the methods used in determining the power required for the ventilation of metal and coal mines. The work has been confined to experiments on laboratory models. The theories thus developed will be applied to actual mining operations in order to learn the conditions that will require the maximum power for ventilation. The old theory that turbulence offers a greater resistance to a flow of air than the friction of rubbing surfaces is again striking quite a few snags. L. Huber, '21, is helping Prof. Arms. A general survey of mines, several of which are to be thoroughly investigated, is to be undertaken this summer.

A Bulletin on Ignition Temperature of Coal is to be published by the Department. Prof. Arms is to be in charge of this work at the Engineering Experiment Station. The original theory followed, was that the ignition temperature has much to do with gob and storage fires. The theory held is that the ignition point is that point at which combustion actually takes place, but the difficulty with coal is that it is always carrying on combustion. It was found that the temperature at which coal glows is an established point, and a very convenient one to use for ignition temperature. The glow points for different coals under various conditions were determined, which further substantiated this theory of determination of the effects of weather and absorbed oxygen on the glow point.

The U. S. Bureau of Mines, represented here by the Central District Experiment Station, the State Geological Survey, and the Mining Department are working together under a coöperative agreement for the furtherance of mining efficiency. All three agencies furnish the services of engineers, chemists, and geologists stationed here at the University, and the latter furnishes the quarters and laboratories of the Mining Department.

At present, the Geological Survey is compiling a record of the mineral resources of the State. An investigation of the coal resources of Western Illinois lying in the belt between Rock Island and Alton is being undertaken by the Survey. A report on the Peoria-Springfield region with coal analyses, from thirty mines, which were sampled this summer, is soon to be published.

The Bureau of Mines Station has compiled a report on "Surface Subsidence in Illinois Because of Coal Mining", which is to be published about July 1st. An outline of this investigation was presented at the annual meeting of the A. I. M. E. last February, in New York. Mr. Thomas Fraser, '17, and Mr. H. C. Yanci, both connected with this station, are in the east visiting the Pennsylvania anthracite

fields. From there they will go to the adjacent bituminous fields to investigate the washing, screening, and other methods of coal preparation. Mr. R. D. Leitch and Mr. W. A. Dunkley are conducting experiments and investigations upon gas at the local station.

Prof. A. J. Hoskins, under a coöperative agreement, is about to undertake a study of the costs production and distribution of power for Illinois coal mines. A bulletin of Mine Haulage, which has been in preparation for the past two years, is nearly ready for publication. This bulletin represents a vast amount of research by the exhaustive data given on costs for main line and gathering haulage, hoisting, and the tonnage hauled per locomotive as well as the costs relative to accidents.

Next fall the Department will offer a new course in Gas Engineering which was recently authorized by the Board of Trustees.

---

#### DELTA MU EPSILON.

The following men were recently pledged to Delta Mu Epsilon, the honorary mining fraternity: J. A. Comstock '23, R. R. Lacy '23, R. S. Sanford '23, E. H. Allison '22, G. Buchanan, Jr. '22, R. A. Merz '22, A. B. Stevens '23, H. Gjessing '23, E. F. Carpenter '23, O. G. Stewart, grad.

---

## RAILWAY ENGINEERING NOTES

On March 3rd, at one of the regular meetings of the Railway Club, Mr. James Woods, assistant superintendent of the Urbana and Champaign Street Railway, gave an interesting talk on some of the problems of an assistant superintendent.

On March 23rd, Mr. Hays, assistant engineer of maintenance of the Illinois Central Railway, told the Club some of his experiences in connection with ties and rails. He concluded his talk by saying that the Railway Engineering graduates had a very good chance to get ahead in their profession as there will be a great demand for more engineers in the near future.

---

#### DEPARTMENT NEWS.

One of the problems which the senior Railway Electrical Engineers are working on at present in E. E. 56 is the design of an interurban road from Paxton to Kankakee. It was the original plan of the K. C. T., which now operates between Urbana and Paxton, to build the line as far as Kankakee, but because of money shortage it was necessary to stop at Paxton. It is hoped that the line will ultimately be continued as far as Kankakee, thus making it possible to go direct from Urbana to Chicago by connecting with the present line from Chicago to

Kankakee. Perhaps some day the K. U. T. officials will employ one of the present seniors to complete this line, but at present the largest premium that the seniors seek is an "A" in E. E. 56.

Mr. F. R. Mitchell, the Research Assistant of the Department, has been working on the dynamometer car for the last month and now has it ready to be taken out on a test. He will be in charge of the tonnage-rating test which will be made on all Illinois Central freight locomotives by students of the mechanical and electrical departments. The dynamometer car will be connected immediately in the rear of the locomotive on test and will measure its draw-bar pull, acceleration of the train, and wind and air resistances.

The electrical test car is now in working order. Prof. Tutthill will be in charge of the bond test which will be run on the Illinois Traction System by juniors and seniors of the Electrical Engineering

Department. Most of the testing was done during the Easter vacation. It is suggested that all meters and pressure gauges on the test car be calibrated to read in dollars and cents so that it will be an easy matter to determine the cost of running the car a certain distance. One of the experiments run in connection with this suggestion had shown that it costs 0.45 of a cent to blow one of the whistles on the test car for  $2\frac{1}{2}$  seconds.

#### THETA TAU

Theta Tau, professional engineering fraternity, initiated the following men on April 16, 1922, at the Chi Phi House: R. Sorter '23, H. Robinson '23, E. R. Smith '23, J. Casler '23, R. Cleary '23, A. B. Stevens '23, W. E. Ryan '23, R. Comstock '23.

The fraternity has a dinner and meeting every other Thursday. Several smokers are planned for the Juniors this spring and next year.

## Articles Worth Reading

### NON-TECHNICAL.

"The Inevitable Antagonism Between Employers and Employees," in *Management Engineering*, March, 1922.

"A Modern Automobile Plant," in *Management Engineering*, March, 1922.

"What Is Ahead of American Industry?" in *Management Engineering*, March, 1922.

"Stabilizing Profits Through Proper Purchasing Policies," in *Industrial Management*, March, 1922.

"The Manager and the Plant Engineer," in *Industrial Management*, March, 1922.

"Is it Profitable to Sell at a Loss?" in *Factory*, March, 1922.

"International Industrial Digest," in *Factory*, March, 1922.

"The Trend of Business," in *System*, April, 1922.

"Do Business Friendships Pay?" in *System*, April, 1922.

"The Public and the Right to Strike," in *System*, April, 1922.

"The Unrest in India," in *World's Work*, March, 1922.

"The Joy of Art in Russia," in *Art and Archaeology*, February, 1922.

"Proposed Great Lakes-Atlantic Canal," in *The Engineer*, March 10, 1922.

"The White Revolution," by Charles P. Steinmetz, in *The Survey*, March 25, 1922.

"Coal Mines, Miners, and the Public," in *The Survey*, March 25, 1922.

"The Iron Man and the Job," in *the Atlantic Monthly*, March.

"The Dollar in Wonderland," in *the Atlantic Monthly*, March.

"The Human Side of Business Administration," in *the Atlantic Monthly*, April.

"The Portent of Stimes," in *the Atlantic Monthly*, April.

"The Russia of Tomorrow," in *Harper's*, April.

### TECHNICAL.

"The Condition of Modern Architecture," in *Architecture*, February, 1922.

"The Guilds—Old and New," in *the Journal of the American Institute of Architects*, February, 1922.

"Water Supply Sanitation in New York," in *Engineering News-Record*, January 20, 1922.

"The Vertical Triple-Expansion Pumping Engine," in *Mechanical Engineering*, March, 1922.

"Calcium Chloride in Concrete Highway Construction," in *Engineering News-Record*, March 9, 1922.

"Bates Experimental Road of Illinois," in *Engineering and Contracting*, March 1, 1922.

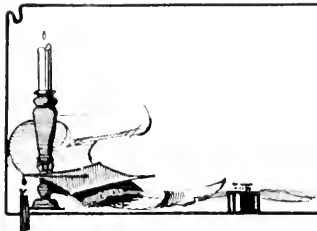

# ALUMNI NOTES

- M. B. Case*, c. e., '06, is the principal construction engineer on the new Delaware bridge which will be the longest suspension bridge in the world. This bridge will connect two cities and two states, extending from a point just below Franklin Square in Philadelphia to the heart of Camden, N. J. The main span will be 1,750 feet long and will cost in the neighborhood of 29 million dollars.
- Bill Ingram*, arch., '12, is a superintendent of construction for Anderson, Graham, Probst and White architects of Chicago. He has had active charge, in the last two years, of the erection of a modern, fire proof, twenty-story building for Butler Bros., of Chicago. At the present time he is in charge of the erection of the new Federal Reserve bank building, a structure about nineteen stories high.
- L. K. Bundy*, m. e., '19, is now connected with the Leader Iron Works of Decatur in the capacity of sales engineer. His work consists mainly of making quotations and estimates, and of selling all kinds of oil storage equipment, water storage tanks, pressure systems, air tanks, and, in fact anything that can be made from plate steel.
- Ernest Pickering*, arch., '20, the eighth Plym fellow, writes from Paris that he expects to remain there for the next three or four months. He has completed his first drawings, and expects to send them to the Department of Architecture in a short time.
- L. V. Fisher*, c. e., '12, is a partner in the construction firm of Cope & Company, of Decatur. Fisher is in charge of the erection of the Decatur dam. He visited the University last month, and gave an interesting account of his work in constructing the dam.
- H. H. Chapman*, m. e., '19, is working in the service department of the Westinghouse Company as a service salesman. His work is of a missionary nature, that is, to bring the fact, that the Westinghouse company has a good repair department, vividly before the users of electrical apparatus. He is also in charge of the wireless programs that are sent out every evening from the station on the top of the Edison Building.
- B. B. Shaw*, ry. e., '11, was for two years the assistant engineer of the St. Paul and Kansas Short line. Since then he has been Division Engineer for the Rock Island Lines, first at McAllister, Oklahoma, and later at Little Rock, Arkansas.
- J. G. Harrington*, c. e., '21, is in the District office of the state department at Paris, Illinois.
- Carl Hauber*, arch., '15, is now a member of the firm of Ronneberg, Pierce, and Hauber, architects, of Chicago, Ill. He visited the University lately, and stated that his prospects for the coming year are indeed good. This firm is at present constructing a large apartment building on Sheridan Road, Chicago.
- S. C. Hadden*, c. e., '05, who has been the editor of the Municipal and County Engineer Magazine, with offices in Chicago, has moved his office to Indianapolis, Ind.
- C. T. Ripley*, ry. e. e., '09, has had another advancement. This latest boost places him in the position of Chief Mechanical Engineer for the Santa Fe Railway, with his office in Chicago, Illinois.
- C. S. Cherpeck*, m. e., '19, has been acting as General Manager for the Chakravarty Company, manufacturers of refrigerating machines. Due to a misunderstanding between the packers and the company, Cherpeck was forced to seek employment elsewhere. At present he is an instructor at the Morgan Park Military Academy at Chicago.
- Lloyd Schieartz*, c. e., '11, reappeared on the campus during the Highway Short Course and had quite a bit to say about the rapid growth of the University. At present he is the District Engineer for the state highway department at Carbondale.
- Edmund M. Finn*, arch., '17, who is located in Minneapolis, is the sales manager for a concern which manufactures construction implements. He reports that business seems to be increasing, and that the outlook for next year is indeed very promising.
- H. E. Surman*, c. e., '10, has been promoted to the position of Engineer of Design of the State Department at Springfield. Mr. Surman was also a member of the party that attended the Highway Short Course.
- R. R. Danielson*, cer., '15, is now the head of the department of enameled steels and enameled cast irons at the Bureau of Standards at Washington, D. C. He is perhaps the best known authority on



- this work in the country. He is at present conducting extensive research work, and has already written several bulletins for the department.
- George T. Felbeck*, m. e., '19, has finished his graduate work at the University of Illinois, and is now employed by the department of Theoretical and Applied Mechanics, doing full time research work. He has recently been elected to Sigma Xi, honorary scientific fraternity.
- Rodney L. Bell*, e. e., '09, was connected with the state highway department for some time, but he has resigned to become the chief engineer of the Allen and Parris contracting company of Paris, Illinois.
- E. J. McDonald*, arch., '21, is in the engineering department of Hollabird and Roache, architects of Chicago. Since this firm has charge of the erection of our new stadium, it is possible that at least one of our number may aid in the making the plans, or in supervising its construction.
- Bill Hanawalt*, m. e., '19, is at the present time with the George H. Smith Steel Casting Company of Milwaukee, Wisconsin. He is employed in layout and maintenance work.
- W. C. Voss*, arch., '12, is a professor at the Massachusetts Institute of Technology, Boston, Mass. He has spent a considerable part of his time in research work in connection with concrete construction, and lately, with the aid of Prof. Hatt, has written a treatise on the subject. The title of the book is, "Concrete Construction", by Hatt and Voss.
- C. P. Ernst*, e. e., '16, until recently was the Assistant Chief Engineer of the highway department of Cook County. He has resigned this position to become a member of the firm of Ernest Company, road contractors. His uncle is retiring and Ernest is now assuming the responsibilities.
- Irring Anderson*, m. and s. e., '15, is engineer of the Moline division of the Santa Fe Ry. His headquarters are at Marceline, Mo.
- I. Raffin*, arch., '12, is a partner in the firm of North and Raffin, contractors of Terre Haute, Ind.
- Harold B. Hemp*, m. e., '19, is now the assistant general foreman of the machinery department of the Liquid Carbonic Company, located at Wilmette, Illinois.
- U. S. Lattner*, m. e., '19, is with the Linograph Company of Rock Island preparing routings and operation instructions for a branch factory which is being established in Austria. He says that business is very slack, but thinks that there will be a marked increase in production by summer.
- E. T. Blier*, arch., '20, is now with the Decatur Bridge Company in charge of their steel and lumber department.
- C. H. Bartlett*, e. e., '21, is now located in Mansfield, New Haven, Connecticut, doing graduate work in the civil engineering department of the Sheffield Scientific School at Yale.
- Russell E. Newcomb*, m. e., '19, is in a somewhat unique position for a mechanical engineer. For the past year he has been connected with the Mutual Life Insurance Company, of Newark, New Jersey, as an agent in Denver, Colorado.
- R. P. Brown*, e. e., '17, is acting superintendent of construction for the National Lime Association at Washington, D. C.
- A. J. Lundgren*, e. e., '20, is an assistant engineer with the County Superintendent of Highways at Rockford, Illinois.
- George S. Oberne*, m. e., '19, is now in the real estate business, and is at the present time planning on building a six story apartment building in Rogers Park on the north side of Chicago.
- J. D. Colb*, e. e., '19, is the head of the commercial department of the Montgomery-Ward Company of Chicago.
- J. B. Feinley*, a. e., '20, is superintendent of architects on the erection of a large school building in Joliet, Illinois.
- C. Z. Rosecrans*, m. e., '19, is still here at the University doing full-time research work under Prof. Goodenough. He has been devoting his entire time to a study of explosions of gaseous mixtures, and has just lately completed writing up a report of this work. At the present time, he and Felbeck are working on a rather complicated gas engine set up in the M. E. Lab., trying to get some experimental data for Prof. Goodenough's thermodynamic theory of the internal combustion engine. We might also add that since the publication of the last issue of the Technograph, Rosecrans has also been elected as a full member of Sigma Xi, honorary scientific fraternity.
- H. F. Wagner*, e. e., '12, is now engineer in charge of the construction department of the Illinois Traction System at Peoria, Illinois.
- J. E. Huber*, e. e., '12, who took his masters work at the University of Illinois in 1913, and who later was employed by the State Highway Department as District Engineer at Ottawa, Illinois, is now sales engineer with the Western Wheel Scraper Company of Aurora, Illinois. His duties call him to all parts of the country as he has charge of the negotiations with all the large road contracting concerns.
- Earl J. Walsh*, arch., '21, has just lately gone into business as a member of the firm of Keith and Walsh, architects of Huron, South Dakota.
- A. K. Sanderson*, m. e., '19, reports that he is still



Proud Mother—"Harold wrote that he got a beautiful lamp for boxing."

Sister—"Isn't that fine, and what kind of a shade has he got on it?"

To Pianist—"Can you play anything?"

Pianist—"Anything."

"Then play checkers while I finish this problem."



SPRING AND SUMMER STYLES  
FOR ENGINEERS.

Pants will be worn longer.  
There will be little change in the pockets.

"I used to play on the piano."

"Well, why did you stop?"

"Mother was afraid I'd fall and hurt myself."

"What is the Order of the Bath?"

"Seniors first and Freshmen last."

"She's a cute girl—she has lots of poise."

"Yes, avoirdupois."

"She has a pretty face."

"Even a barn looks good when it's painted."

Agent—"I've got a device for getting energy from the sun."

Father—"Here—give me one for mine."—*Tiger.*

"I've tried every bank in town and can't cash this check."

"Did you try any of the boneyard banks?"

"Did you pick up any Spanish while you were down there?"

"No, they're not what they're cracked up to be."

"There goes a fine girl."

"Yeh—not a flapper?"

"Naw—why boy, she's so innocent she thinks Scott Fitzgerald's 'Beautiful and Damned' is a picture of a river."

"He made the best after-dinner speech I've ever heard."

"What did he say?"

"Waiter, give me the check."—*Jester.*

Student—"I worked on this problem nearly all night."

Professor—"And didn't you get it?"

Student—"Well, this morning it began to dawn on me."

## Engineering Curriculum

(Continued from page 168)

who design need mathematics. This is not true, however, because to construct, or to operate properly, it is necessary to understand the underlying principles. Also, technical men who are salesmen for the large companies are chosen for their ability to analyze the engineering problems of prospective buyers and give correct advice.

"Engineering curriculums are highly mathematical, and they will become more so. In the not distant future it will be necessary to add another year to the engineering course in order to make room for courses which are mathematical. It is a sign of the times, and a humiliating one for Americans, that the technical organizations of many large corporations are filled with men who have had the intensive mathematical training of European universities."

A careful study of Professor Willard's statement will prove of value. He has discussed fully and clearly the curriculum as it now exists, first stating what the requirements of a good engineering curriculum are, and then pointing out where our curriculum satisfies these requirements and one place in which it falls short. He includes in his "General List" non-engineering subjects dealing with human relations. Actually the curriculum in Mechanical Engineering allows but six hours of electives in non-engineering subjects, and the other curriculums allow but six or nine. Professor Willard says that the ideal graduate must acquire the ability to deal with men, and also secure working knowledge of business discipline. Professor Provine sounded a similar vein. Professor Willard adds, "Unfortunately no provision is made for registration in these important subjects at the time the student's yearly program is made up."

It is indeed a handicap for the student engineer, and for the engineering profession, that provision is not made in the curriculum for giving the student a broader knowledge of business structures, of men, and of men's relations in industry. The problem of correcting this defect merits the careful attention of both faculty and students. Personally I know that Professor Willard has given it considerable study as have other members of the faculty. Dean Richards dwells particularly on this subject, so before going further I will present his statement.

### STATEMENT OF DEAN RICHARDS

"Many graduates of the technical schools of the country are prone to criticize the curriculums which they pursued because of the inclusion of some material which has been of no practical value to them, or because of the exclusion of subjects which seem

to them to be of great moment. To any one who is at all conversant with the difficulties in formulating satisfactory curriculums for the preparation of students for professional life, it is perfectly clear that in no four-year course is it possible to include specific instruction in every subject which the graduate may have occasion to use. With the rapid development of industry and of science, there is an ever increasing demand for the inclusion of new highly specialized courses in the college curriculum, designed to prepare men to take up at once the practice of a particular specialty. Unfortunately, perhaps, few students pursuing technical curriculums are able to forecast with certainty the nature of the professional work which they will be called upon to perform; and consequently, those young men who have pursued highly specialized curriculums may find that in the process they have failed to familiarize themselves with certain of the fundamentals of engineering which are applicable to almost every branch of the subject. There is a growing belief that the engineering curriculum should contain the fundamentals of science and their broad applications to engineering, with only a sufficient amount of specialization to maintain the interest and enthusiasm of the students.

"In a recent formulated definition, engineering was defined as "the art of organizing and directing men and controlling the forces and materials of nature for the benefit of the human race". This definition recognizes the fact that the successful engineer is one who is not only competent to do expert designing of engineering structures or machines, but is also capable of working with men, for it is only by men's work that great engineering projects can be successfully completed. Because of this fact, the training of an engineer should include the study of men as well as the study of things.

"To organize men, one must be proficient in the art of expression, and to handle men, one must understand them. There is little doubt, therefore, that an engineering student may profitably spend much more time in the study of English composition and public speaking than he now gives to these subjects. In addition, he can with great profit to himself devote some of his attention to the study of psychology, sociology, economics, and the applications of these subjects to the affairs of life. Incidentally, of course, many of the most successful leaders of industry have to deal largely with business details, and they must become familiar with the methods of organizing and directing business enterprises. While it is true that one may by reading and private study acquire familiarity with many of these important subjects which are normally included in the technical curriculums, it is probable that the

time will come when the importance of these subjects will be so generally recognized that they will find a place in the technical curriculum, which will some day be lengthened to five or preferably six years."

In one sentence Dean Richards sums up the ideas, at least in a general way, of Professors Paine, Willard and Provine concerning the technical part of the curriculum when he says, "There is a growing belief that the engineering curriculum should contain the fundamentals of science and their broad applications to engineering with only a sufficient amount of specialization to maintain the interest and enthusiasm of the students".

Then Dean Richards goes further than any of the other men in stressing the importance of non-engineering subjects. He says, "The training of an engineer should include the study of men as well as the study of things". He urges that the engineering student may profitably spend more time in the study of English composition and Public Speaking than he now devotes to these subjects, and goes on to point out the value of some knowledge of such subjects as Economics and Sociology, and the necessity of becoming familiar with the methods of organizing and directing business enterprises. Dean Richards seems to feel that these subjects are of such importance that in time they will be included in our engineering curriculum, which must be lengthened to five or six years. Coming, as this does, from the Dean of our College and one of the foremost of engineering educators it commands our most careful consideration. If these subjects are as essential as the different professors seem to think, courses should be included in curriculum which will give up instruction in the fundamentals of some of them.

An examination of Professor Willard's outline shows that but few courses could be eliminated from the present curriculum to make room for the non-engineering subjects. Some of the more highly specialized courses in the different curriculums could be dispensed with, but there are very few such courses, and the student needs some of them to keep up his enthusiasm. However, a rearrangement of the present curriculum with the placing of different laboratory courses in the summer months would provide time for a number of non-engineering courses. For example, if the shop courses of the Mechanical and Electrical Engineering curriculums were given in one combined course during the summer between the Freshman and Sophomore years, nine or twelve hours of non-engineering subjects could be added to these curriculums. Surveying courses in Civil and Mining Engineering could be given in a similar manner. Michigan, Cornell, and Massachusetts Institute of Technology give their surveying courses

in summer camps and experience little difficulty in getting the students to attend.

The language requirement of the Sophomore year in the present curriculum gives an opportunity for future training in English as in most departments English I and II satisfies the requirement. In a measure this gives the student, beside a better knowledge of composition, some idea of the different phases of modern philosophies. For the student who is not planning on practicing in some foreign country it seems most desirable to take English for this language requirement.

In conjunction with the Engineering Lectures we suggest that a prescribed course of summer reading be required which would extend through either two or three summer vacations. Massachusetts Institute of Technology requires such reading in all of its undergraduate courses. A circular on Summer Reading is issued each year containing a list of the required readings and an additional recommended list. A statement of the books read during the summer is required at the beginning of the school year. The purposes of the courses as outlined in the Institute's Bulletin are "To increase the acquaintance of the student with literature, history, and general science, to develop in him a taste for such reading, and to impress him with the importance of general culture, not only as a source of individual enjoyment, but as a practical aid to professional men in their social and business relations."

All of the above suggestions have concerned themselves primarily with the present four year curriculum. The Technograph believes that there are students who would appreciate a five year course such as Dean Richards has suggested, and that it would be well for the College to investigate and find out whether enough students are interested to justify the establishment of five year curriculum in some of the larger departments. However, that is a matter which would require very careful consideration and is beyond the range of this discussion.

In conclusion, I wish to point out that I have merely given suggestions as to possible ways in which the non-engineering subjects which the different men interviewed deem desirable could be included in our curriculum without extending them over four years length; and to say that nothing in the article is intended as criticism of the College in any but a friendly and constructive manner. The Technograph Staff has studied the statements of the different professors carefully and appreciates the difficulty of satisfying all the requirements of an ideal curriculum. Also we wish to here thank the professors who have cooperated with us in these interviews.

## Concrete Research

(Continued from page 170)

Tests with a variety of sands show that as sand and cement are mixed together with increasing amounts of water, the voids decrease until a point of maximum density of the mortar is reached; more water then increases the voids by the simple mechanical separation of the solid particles. The water in the mortar of maximum density has been termed the basic content and may be used as a standard of comparison in describing the wetness of mixtures or as a definite consistency at which mortars may be compared. By determining the voids in mortars of several degrees of richness, curves may be drawn indicating the void-cement ratio and probable strength of any concrete mixture using the given sand and cement. In general it is found that fine sands produce mortar having high voids, coarse, well-graded sands result in lower voids, and rich mortars have much higher voids than leaner ones. Hence, with the same amount of cement and like consistency, concrete made with a fine sand will be inferior in strength to that made from a sand in which the size particle varies uniformly from fine to coarse. The method thus provides a means not only for estimating the strength of concrete but also for studying the desirability of sands for use in concrete or mortar. The requirements for size and gradation of coarse aggregate appear to be of much less importance than for fine aggregates, provided that strength, cleanness and durability are obtained. Obviously, as much coarse aggregate as possible will be used in concrete to reduce the cost, but on the other hand a sufficient proportion of mortar must be used to surround the particles of coarse aggregate and to make the mixture workable.

Apparently all of the theories regarding the strength of concrete have their limitations. None of them apply well to extremely dry mixtures or those containing an excessive amount of coarse aggregate which fortunately are not commonly used, or to very wet, "sloppy" mixtures which are uneconomical and should not be used. Furthermore, concrete is sensitive to a number of conditions which affect its strength; these cannot be included in any general law of behavior.

Warmth and moisture are very beneficial to concrete during its early hardening period. Moisture in particular has been found to produce a gradual increase in strength for a number of years, while concrete which has been allowed to dry out shows little increase in strength with age. Concrete roads thus have an advantage over most other structures in that they receive moisture from the surface and particularly from the subgrade; besides this they are usually protected against drying

out for a period of about a month after they are laid. Samples cut with a core drill from concrete pavements and roads have shown in comparison with the strength at the age of a month an excess strength of about 50 per cent. at the age of a year and nearly 100 per cent. at the age of six years. The tests of cores also showed that concrete as tamped into place and cured in a pavement was somewhat stronger than concrete taken from the same batch, placed in test cylinder molds and stored with the pavement. This is probably due to greater compactness and a more uniform supply of moisture in the pavement.

Two apparently anomalous effects of water upon concrete have been mentioned, namely, that excess mixing water is detrimental to the strength and that a certain amount of moisture is necessary for the increase in strength with age. Compression tests have shown that there is still another effect, since concrete saturated with water is found to be weaker than dry concrete and even a small amount of moisture produces a measurable effect. It is likely that in a structure this phenomenon partly neutralizes the increase in strength made possible by the presence of moisture. In the tests noted above, test pieces stored 25 days in damp storage and then dried 3 days in air were from 5 to 30% stronger than test pieces of identical material kept in damp storage for 28 days and tested damp. The importance of a standard practice in storing specimens at a testing laboratory is apparent.

Another problem with which designing engineers are concerned is the deformation of concrete structures due to changes in temperature and to moisture content. Concrete expands when it is heated or when it absorbs moisture and contracts when it is cooled or dries out. The two phenomena which may cause a deformation are similar in importance so that it may be difficult to distinguish which produces a given result. In general, temperature changes occur more frequently and more rapidly than moisture changes. Shrinkage cracks in large structures appear to be due mainly to the loss of moisture in the setting and drying of the concrete. Bridges, pavements, grandstands, viaducts and similar large exposed structures call for a great deal of ingenuity in providing expansion joints and in using reinforcement to minimize the development of cracks. A serious temperature effect in road slabs is the warping of the edges of the roadway with the daily variations in temperature, so that the slab does not bear uniformly upon the subgrade and severe bending stress is produced under traffic. The matter of expansion and contraction is seen to have a direct bearing upon the durability of concrete structures.

Although very little in the way of quantitative information has been given here, some of the every-day problems of the concrete user have been indicated. While much of the pioneer investigational work has been done, there are still many questions to be answered and a great amount of work to be done in unifying and extending our present fund of information.

## Engineering and Business

(Continued from page 171)

wages, or better, why do they have to reduce wages? Why can consumers on the Atlantic Coast buy coal shipped from England over 3,000 miles of ocean? One could go on for pages propounding questions in current business activities which could be answered from economics.

Just as physics is expanded into separate subjects such as electricity, steam, mechanics, machine design, so is economics expanded into corporation finance, labor problems, taxation, banking and credit, administrative organization, marketing. And just as mathematics is an instrument of precision to engineering so is accounting to management. In the pages of its ledger is recorded the financial aspect of every occurrence in the business. From analytical summaries of those facts, it is possible to trace the results of good and bad policies, and it is by judging the results that the executives can judge the worth of policies.

Some one has said that if one desires to study man, he should study history. That applies to the present case when we consider that the principles of economics were evolved from analytical studies of certain aspects of history—not the rise and fall of kings, but the rise and fall of prices; not the knightings of lords, but the passing of laws.

When the engineer studies economics or engages in business, he must be conscious of a shifted point of view. No longer are the elements measurable by galvanometer or micrometer, or soluble in hydrochloric acid. The important element is Man. What a given individual will do under given circumstances can not be predicted, but what ten million will do can be forecast in some measure by reference to history, yet even then, not with the accuracy that one can calculate the water pressure upon a dam.

Economics is likely at first to seem vague and speculative, and business to be conducted largely "hit or miss." Economics must be philosophical in the approach to its problems rather than mathematically analytical. Its conclusions must remain debatable since tomorrow men may think differently. The conclusions of physics are based upon

immutable laws; they can be expressed in formulae; the conclusions of economics can not.

Business must be conducted with a larger margin for the error than engineering construction. But it is not "hit or miss" because of that. When the policies of an enterprise and the current condition of business in general are known, the success or failure is predictable—so long as neither conditions nor policies are altered. But the former change day by day, and the latter, if the enterpriser be wise, keep step. One must, therefore, change or at least review his prediction periodically and be governed accordingly. In engineering when one predicts that a given beam will bear a load of 600 pounds per square inch he does not have to change the next day because a pound is heavier or because the beam has shrunk twenty per cent. But safe prediction in business is possible within limits; if it were not, few enterprises would last out the year.

No engineer need feel that success in business is beyond him because he chose a college of engineering rather than a college of commerce. There are many men trained as engineers who are very successful business executives and there are many business men who would have larger successes if they had some engineering training.

The engineer should take into consideration the fact that he has had excellent training in careful mental habits, in checking his observations, in reaching conclusions cautiously and in looking facts squarely in the face. These are valuable factors in success in any activity and they will help him to get along in business. But they will have to be supplemented; even the engineering training has to be supplemented for the successful practice of engineering as such.

It is not difficult to superimpose a knowledge of business upon a training in engineering. However, it cannot be done over night, or by absorption through the pores. One cannot expose himself to a look on finance and expect it to take any more than calculus under like circumstances. But (confidentially) one is easier to learn alone by good hard study than the other.

---

What is your size?

The man who thinks he is too big for his job is generally too small for any other job. Stop admiring yourself, get acquainted with your work, and find out what wonderful opportunities there are in that work to master.—*Bill Osborne*.

---

Three-fourths of the mistakes a man makes are made because he does not really know the things he knows.—*James Bryce*.

## Stresses in Gothic Vaults

(Continued from page 173)

considered one-half an arch span and can be solved as a composite masonry arch. The loading consists of the weight of the rib itself and the thrust of the vault shell coming on the rib from each side. It should be noted that these thrusts of the vault shell are symmetrical but come onto the diagonal rib at right angles to each other. They should, therefore, be combined into one force. The vertical component of this force is the sum of the two vertical components of the vault thrusts, and the horizontal component is the hypotenuse of a right-angled triangle whose sides are the horizontal components of these thrusts. The combination for all six laminations is shown in Figure 2. The true size of the diagonal rib can be found by revolving the rib about its springing line from a vertical to a horizontal position. The loading is applied at the centroid of the portion under consideration, and a funicular polygon can be drawn of the forces resulting from these loads, from which the line of resistance and thrust can then be determined. This is shown in Figure 3. The unit stress for any cross-section can also be determined.

The two diagonal rib thrusts are combined in exactly the same manner as the thrusts from the vaulting to this rib are combined. The total thrust from the two ribs on the wall is a force whose vertical component is the sum of the vertical components of the rib thrust and whose horizontal component is a hypotenuse of a right-angled triangle whose sides are the horizontal components of the rib thrusts. Figure 4 shows this combination.

The roof reaction is equal to the combined weight of the wall and the pilaster to the point where the rib thrust enters the wall, and can easily be determined. The rib thrust can then be combined with this vertical load, and the resultant loading can then be carried down the wall and the pilaster, care being taken to combine the thrust from the window arch at the proper point. The line of resistance can be drawn for the shaft and the unit stress found for any point on the shaft.

In this problem the unit stress was found at a point on a level with the floor. It should be noted that the line of resistance begins to curve towards the building after a certain level has been reached. The engineer should therefore bear in mind that the maximum unit stress may come at a point above the floor line even though the vertical load is less than that at a lower point. This is due to the eccentricity of the resultant force.

The kern of the cross-section where the unit stress is found is located in Figure 5 and the unit stress is determined graphically in Figure 6.

Accompanying the solution of this problem is a photograph of one of the problems as handed in by a member of the Junior class. As stated before, the thrusts from the vault laminations are found at Figure 1, and the thrust from the diagonal rib is found at Figure 3. In each case the middle third and the line of resistance are drawn, and it would be an easy matter to obtain the unit fiber stress at any point on the vaulting or the diagonal rib. In Figure 4 is shown the combination of the two diagonal rib thrusts. The loads from the roof and shaft are combined in Figure 7, and the line of resistance for the shaft is drawn there.

## Before and After Graduation

(Continued from page 181)

and there as rapidly as you can. Your class work is only supplying you with fundamentals."

A man who has been in his present administrative work for eleven years says:

"My advice to the young man would be: first, of all, interest himself in his work. If he learns to love and enjoy his work, his success is assured providing in turn he has a well trained logical mind. Success is dependent upon a sound engineering and technical training, and I am firmly of the opinion that more attention should be paid to the fundamental laws of matter and less to the historical application of same. In addition to these factors, however, an understanding of the individual is essential. To be successful a man must understand men for he is dependent upon man for the application of his technique and unless he can interest them, it will be impossible to put into execution beneficial measures. This is of importance today as never before. The day is past when man can be driven, but must be, on the contrary, led and inspired."

Another man, in technical work, writes:

"In thinking of my technical training it has struck me very forcibly that I never learned properly to analyze and if I can get this thought over to you it ought to be of some benefit to you. Don't just record the things your instructor tells you. Find out the things you don't know, and go after them. If this is practiced you will get a little deeper insight into the things you will get into after you get out."

Finally, the following words may be appropriate:

"I think that, in the second year, a man should be in a position to know which line of work he intends to follow. The field is so broad one cannot cover it all. If he decides his line, then the course should be specialized to cover that field. I have learned from experience and observation that the average graduate in common with other professional lines, has a hard row to hoe for several years. When he gets out of school he has not experience which will allow him to demand anything, and he must prove himself and fight for what he gets. The first few years are full of so many disappointments and much discouragement, and in answer

to your last question I would say that the factors which are most essential to success are a reasonable amount of self-confidence, coupled with a dogged determination to hang on. I have found that my most agreeable surprise has come following a time when I felt that I was making no progress, and was about ready to throw it all overboard."

The knowledge that can be derived from such answers as these, goes a long way in helping us to solve the questions raised at the start of this article. Though the graduates who wrote the answers to the questionnaires may not be fully qualified to offer advices that may not be challenged, they have given us material insight into what we should appreciate most and prepare for while in school, and what we may expect when we graduate. We feel deeply indebted and truly grateful to these men for the trouble they have taken to help us out. As to the graduates, the following quotations express aptly the bulk of their sentiments:

"When in the University I sought advices and wanted to ask questions such as you have asked, and know how much I would have appreciated having them answered and receiving good advice, and I therefore took great interest in doing my little bit for you now."

"If the above viewpoints which I have given you on the points raised in your questionnaire are of any help or interest to you, it is indeed a pleasure for me to cooperate with you in the memory of my Alma Mater."

## Military Narrow Gauge Railway

(Continued from page 179)

units were usually well armored. English ideas, however, differed rather radically from American practice. A characteristic British tractor, nicknamed the "Turtle", comprised a six-cylinder motor and three speed gearbox, with chain drive to the two live axles, mounted quite low, and covered completely by an armored shell of shape similar to a soldier's helmet. The overall height of this unit was such that the operator had to stoop to crawl under the armored top and take his operating position. While performance records of this type of tractor are not available to the writer, it seems reasonable to expect that future designs will follow to some extent this example in lowering the center of weight.

The usual train load for steam locomotives numbers from four to eight cars, according to the density of the freight; the load for gasoline tractors (American equipment) is slightly over half the load for the steam engines. This difference in hauling capacity hardly warrants the exclusive use of steam power, because of the danger of operating steam engines close to the enemy. The accepted practice is to haul by steam to within four or five miles of the fighting lines, and relay from there to points of consumption with the gasoline tractors. This

method causes little if any loss of capacity, because individual consignments to any one point rarely exceed two or three cars.

General practice in Europe, as well as America, seems to favor a car capacity of about ten or eleven tons for gondolas, boxcars, and flat cars. These cars are in most cases built along the same lines as the familiar standard gauge cars, with four wheel trucks and hand brakes. An example of French variation of design is a flat car whose frame is dropped to within six inches of the track between the trucks, in order to facilitate the loading and unloading of heavy shells. In handling ballast on short hauls in construction work, the well known dump car of one-fourth to one ton capacity is generally used. Closed rectangular tank cars on the flat car chassis complete the usual cargo carrying equipment.

The necessity for frequent inspection and prompt repair of track makes the speeder an almost indispensable part of the maintenance equipment. American equipment of this kind includes a single cylinder type capable of carrying eight men (a repair squad) at a speed above thirty miles per hour, and a two-cylinder type built for two persons, capable of fifty miles per hour. The latter type is used for inspection, dispatch carrying, and emergency repair delivery.

The possible train speed on the 60 centimeter roads is quite low in comparison with that of standard gauge lines with well kept roadbeds. On advanced lines a speed of twenty-five miles per hour, while often necessary to make grades, is considered unsafe, and average speeds of fifteen miles per hour are difficult to maintain. Under adverse conditions, such as night operation in shell swept territory, or where the track is undergoing the abnormal traffic due to a military "drive", eight miles per hour is the maximum safe speed.

However, in spite of the numerous and serious difficulties of operation, narrow gauge railways have earned a place of prominence in transportation facilities for battle front transportation. A study of records of tonnage handled, according to the Chief Engineer, A. E. F., shows that up to February 1, 1919, American operated light railways had handled 860,652 tons of freight. During the months of September, October, and November, immediately following the San Mihiel and Argonne offensives, narrow gauge lines were operated through from two to three times their normal hauling distance. During this period much of the hauling had to be accomplished over new, hastily constructed lines and over badly damaged German track. Assuming a capacity of three tons for motor trucks, the light railways kept a total of 286,884 motor trucks off the already crowded highways. (More-



over, these figures do not include a large number of trains of which no records were kept, nor trains used for transporting troops).

It is by no means true, however, that light railways are equally well adapted to wars of position and wars of movement. The difficulty of laying new track and extending operations to keep pace with the shifting positions of open warfare precludes any possibility of attempting to use railway transportation alone. Open warfare transportation is the province of the motor truck and tractor, but in siege operations and trench fighting, the available figures show that as a means of ration and ammunition transport, the narrow gauge railway is far from despicable.

\* \* \*

The writer wishes to make acknowledgment to Capt. M. E. Pumphrey, C. S. Elliott, and Lt. C. S. Henning, in the Regimental Biography of the 21st Engineers, for statistics quoted in the above article.

## Superpower System

(Continued from page 159)

of 260 pages with many maps, charts and tabulated statistics. It describes a large engineering project which could not be completed before, say, 1930. It would cost nearly a billion dollars. Would it pay? It most certainly would. It would pay both the investors and the public. It would be a wonderful step in coal conservation. It would change energy distribution from a coal car to a wire. It would make possible the development of a maximum amount of our water power resources.

The zone itself is that great industrial finishing shop between Boston and Washington. It includes nearly all of New England, all of New Jersey, and the eastern parts of New York and Pennsylvania. Within this zone live 22 per cent. of the population, and here is made 44 per cent. of our manufactured product, although it includes but 2 per cent. of the area of the United States.

Very briefly, the essential features of a Super-Power System constructed and operated in this zone are as follows:

- (a) The generation of power in steam-electric plants of large capacity and of the highest economy.
- (b) The location of these steam-electric plants advantageously with relation to the coal mines, condensing water, load centers, and coal distribution.
- (c) The extensive development of the hydro-electric resources both within the area and adjacent thereto.
- (d) Construction of trunk transmission lines for the interconnection of the generating stations,

both steam and hydro, with the principle load centers of the zone.

(e) By the interconnected electric system, the industries and the heavy traction railways will have available to them a reliable, adequate, and cheap power supply.

(f) A unified system of control in charge of a power dispatcher.

(g) The delivery of the primary power to the electric utilities within the zone.

(h) The local distribution, as at present, of all energy by the electric utilities.

If this system is built, it must be financed and constructed by private capital and not as a government undertaking. There are no visible engineering difficulties that cannot be overcome. It is evidently the next natural step in power generation and distribution. If the step is taken, it will make of this zone the greatest manufacturing area of the world. (Please, Mr. President, may we have a Merchant Marine?)

Should this system be completed by 1930, the most important results to be expected because of its operation are:

- (a) A large increase in the use of electrical power, accompanied by a reduction in its price.
- (b) An annual saving of 50,000,000 tons of coal.
- (c) An annual saving of \$210,000,000.
- (d) A considerable transfer of coal from land freight to water freight.
- (e) Increased flexibility in power distribution.
- (f) A maximum water power development and utilization.
- (g) The elimination of industrial smoke and its attendant waste.
- (h) Opportunity for coal storage, which tends to stabilize production.
- (i) The establishment of chemical, metallurgical, and other special industries.

Superpower systems are already in operation on the Pacific Coast and in the Middle west, but because of our very density of states, variety of laws, fixed habits of doing things, the Superpower plan looks large and difficult within this Eastern zone.

But the real significance of a Superpower System is not the less cost of power but it is the influence, direct and indirect, which the extending use of power has in promoting social and industrial progress and thus advancing civilization. The continued substitution of power for human labor creates possibilities for higher standards of living, and for higher types of human life than we have yet realized.

## Dr. Ira O. Baker

(Continued from page 161)

a great number of works that are too numerous to mention. They are found in the leading technical journals and the proceedings of the engineering societies.

Although Professor Baker has always been associated with the University a great deal of his work has been done along other than academic lines. He has carried the name of Illinois into many other lines of business by his association with engineers and his untiring activity in the different engineering societies. His outside work has shown him to be intensely practical and his knowledge of the business world has aided him to improve class room instruction. He became a member of the American Society of Civil Engineers in 1893, and has twice served on its nominating committee, once traveling to Mexico City that he might be present and fulfill his duties on that important committee. He has been a member of the Western Society of Civil Engineers since 1886, and has twice been elected to office in that society. Professor Baker takes great pride in his membership in the Illinois Society of Engineers, an organization which was conceived and founded by himself in 1880, and which has played an active part in the development of engineering throughout the state.

Dr. Baker has always considered that engineering education was a very important part of the profession and when the Engineering Congress for the World's Columbian Exposition was first considered, he urged that a division of engineering education be included in it. He was named chairman of a committee which had charge of the division, secured papers and speakers for a very successful program, and organized the convention and presided at the meetings. The proceedings of this meeting were published as Volume I of the Proceedings of the Society for the Promotion of Engineering Education. Thus we see that Dr. Baker is very properly called the founder of this society.

After forty years of service, Dr. Baker retired from his administrative duties as head of the department. On the occasion of his retirement, he was honored in many ways and among them was a banquet in Chicago, at which many of the leading engineers of the world were present. This banquet was one of the supreme moments of Dr. Baker's life, and the honors that were given him at that time showed that the engineering profession held him in high esteem. It was a time when all these busy and important men left their own work to do homage to a real pioneer, a veteran engineer and educator.

Dr. Baker's retirement was to be short lived,

however, for after two years had elapsed he was again called to take charge of the department of Civil Engineering. It was at a time when younger men were needed in our country's service, and the department needed a strong hand to guide it. Dr. Baker filled that need and did it well. He is now retiring again at the end of the school year to take care of his farm. It has been quite a sacrifice for him to come back and take up the administrative duties again, and the University and the students appreciate his efforts very deeply. It will be hard for the civil engineering graduates to imagine the department without Dr. Baker. He has always been very interested in the activities of his students. He organized the Civil Engineer's Club in the early days, and it has continued to the present time a very important factor in the life of civil engineering students. The Technograph owes him a very great debt, for he is responsible for its existence. There are so many things that were started here by him that it is difficult to list them all. Among other things the Cement Testing Laboratory and the Road Materials Laboratory of the Department of Civil Engineering owe their existence to his efforts. They are pioneer laboratories in these lines and have been models for many colleges in this country.

Professor Baker has in his forty-eight years of service been very loyal to the interests of his alma mater declining more than once very tempting offers that would take him away from the institution. The University owes him a debt of gratitude for his allegiance. Professor Baker was given his master's degree of Civil Engineering in 1878, and in 1903, the University conferred on him the honorary degree of Doctor of Engineering. The students, both young and old, view his retirement with regret, but wish him happiness that comes from knowing that his life work has been a great success, and that he has collected a host of staunch friends and admirers.

---

Oil shale development will soon be needed, said Dr. Ralph McKee of Columbia, in a recent address. He pointed out that it seems evident that the productivity of our country's oil wells has reached its peak, and also that, up to the present, no very successful or efficient process has been discovered for the utilization of oil shale. There are large shale deposits in Nevada, California, Kentucky, Indiana, Ohio, Colorado, Utah, and Wyoming. The last three states have deposits rich enough to supply sixty billion barrels of petroleum or approximately five times the total production of the world during the past sixty years. Most of the shale yields from twenty to sixty gallons of oil per ton of rock.—Tech. Engineering News.

'24 '23  
'25 '26

## Which will next year's captain wear?

**I**T DOESN'T need much wisdom to predict that next year's nine will be captained by a '23 man or maybe a '24 man.

This is no affront to underclassmen. Years of steady plugging must go before you can handle the man-sized responsibility of running a team.

That this is just, seniors will be the first to assert. They have seen how well it works for team and college. Then let the seniors keep this point of view, for soon they will find how closely the principle applies to themselves in the business world.

Captains of industry are not made overnight. Don't expect to step into a managership right away. Before you can lead, you've got to serve in the ranks awhile.

This is best for your organization and best for you. The time and energy you put in working up from the bottom, taking the bitter with the sweet, getting the upperhand over your job, will stand you in good stead when you have won through to executive position.

When you have learned how to handle detail work, you can begin intelligently to direct other men to do it, and thus free yourself for creative planning.

You who intend to be captains, have patience. Your year will come and so will your chance.

*Published in  
the interest of Elec-  
trical Development by  
an Institution that will  
be helped by what-  
ever helps the  
Industry.*

# *Western Electric Company*

*Since 1869 makers and distributors of electrical equipment*

## Vogt Boiler Designs

(Continued from page 158)

drums, the suspension apparatus and the fronts are built in the fire front department; and the feed line, blow off, and other pipe work is prepared in the pipe shop. The doors and frames for the fronts and other setting fittings as clean out doors, damper frames, and soot blower castings are made in the Vogt foundry from the best grades of grey iron; the manhole and handhole cover plates are drop forged steel and the arches are pressed from boiler plate. The baffle tile furnished is made from a high grade refractory material prepared by a local fire brick company. The steam gages, safety valves, water columns, and similar fittings are purchased from manufacturers who specialize in this equipment. All these parts required for the order are taken from stock; they are standard equipment and are produced or purchased in large quantities to reduce the individual cost and avoid delays.

A careful comparison of the order list with the boiler elements assembled on the loading platforms indicates that all parts have been completed. Cars are therefore ordered and shipment is made. When notification is received from the customer that the boilers have arrived, a competent erecting engineer is sent to supervise their installation.

## Dean Richards

(Continued from page 154)

Dean Richards was married in 1891, to Miss Alida Russell Beardsley, of Lafayette, Indiana. They have two children, a daughter, Lenore Richards, who graduated from the University of Illinois and is now Assistant Professor of Institutional Management in the Department of Household Economics, University of Minnesota, and a son, Robert Watt Richards, who is a senior in the Medill School of Journalism, Chicago, Illinois.

Dean Richards is a member of the American Society of Mechanical Engineers (Manager 1918-1921) and is Chairman of the Sub Committee on Fuels of the Power Test Code Committee of this Society. He is also a member of the Western Society of Engineers, Society for the Promotion of Engineering Education, Sigma Xi, Tau Beta Pi, Sigma Chi, Sigma Tau, and Pi Tau Sigma.

## Students Co-operative Store

(Continued from page 175)

from these slips. Each member has a separate card with spaces for his monthly purchases for the four years he is in school. The refund is made in September of each year. This allows the management to take care of making out checks during the

summer months. The employees of the store are all students, who are interested in the enterprise and who are doing their very best work to help make it successful from the service viewpoint as well as from the financial.

The management wishes to express its appreciation of the support of the student body and hopes that the support will increase, because an increase will mean that you are benefiting your friends as well as yourself. It is *YOUR STORE*, so get behind the management and increase the service to all your fellow students.

The glory of a workman, still more of a master workman, that he does his work well, ought to be his most precious possession.—*Thomas Carlyle*.

When a nation gives birth to a man who is able to produce a great thought, another is born who is able to understand and admire it.—*Joubert*.

Few men are to be more shunned than those who have time but know not how to improve it, and so spend it wasting the time of their neighbors, talking forever though they have nothing to say.—*Tyron Edwards*.



## Your New Suit?

ZOM'S clothing is honestly made — and it's full of grace and character. University men are delighted with what they find here. And the prices are reasonable.

## Roger Zombro

Apparel for University men  
Green street—of course

# SATISFACTION

Is a Big Word

BUT WE GUARANTEE IT IN ALL  
PENS AND REPAIRS

## Rider's Pen Shop

612 E. Green St.

# All Makes of Typewriters For Rent

\$3.00 Per Month

\$8.00 for 3 Months. Rental Allowed on  
Purchase Price if You Wish to Buy.

## R. C. WHITE & CO.

612 E. Green St.

Main 922

"Royal-Corona Agency"

"The wealth of the land  
Comes from the forge and the smithy and mine,  
From hammer and chisel, and wheel and band,  
And the thinking brain and the skilful hand."

—DR. WALTER SMITH.

H. F. Duncan, Photographer, has paid for this space

# The APOLLO Confectionery

Home of High Grade Candies and Delicious Drinks

Try one of our famous fresh Lime Freezes  
or Fresh Strawberry Sundae

The APOLLO Confectionery

MOUYIOS BROS. . . Urbana

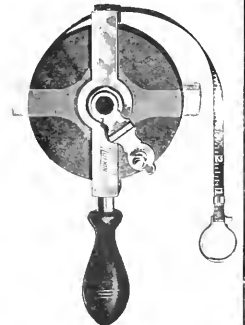
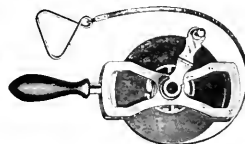
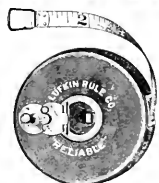
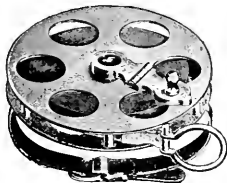

# LUFKIN TAPES

ALL STYLES

Longest, Most Satisfactory Service

Send for Catalogue **THE LUFKIN RULE Co.** Saginaw, Mich.  
New York, London, Eng. Windsor, Ont.



Designs  
Etchings  
Colorplates  
Photo-Engravings  
*for*  
*Advertising*  
*Purposes*  
G.R. GRUBB & CO.  
Champaign, Illinois

## T. M. Bacon and Sons

Paints, Glass,  
Wall Paper

CHAMPAIGN

*For Photos for Your*

## *Thesis*

Let Strauch Photo-Craft House  
Make Them

WE CAN HELP YOU SOLVE YOUR  
PHOTO PROBLEMS

# ILLINI PUBLISHING COMPANY

PRINTERS AND PUBLISHERS

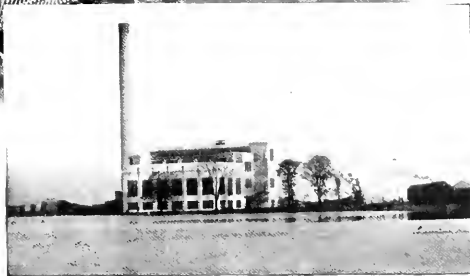

# Vogt Water Tube Boilers

The illustration shows the Vogt Water Tube Boilers in the Schoper, Illinois Plant, Standard Oil of Indiana. A graphic account, both from the engineering standpoint as well as the efficiency of the boilers of this installation, was given in one of the August issues of Power Magazine. Reprinted copies of the illustrated article will be mailed to the engineering students upon request.

## HENRY VOGT MACHINE CO.

Incorporated  
LOUISVILLE, KY.



### BRANCH OFFICES

New York — Chicago — Tulsa — Dallas

Manufacturers of Water Tube & Horizontal Return Tubular Boilers — Drop Forged Steel Valves & Fittings — Ice Making & Refrigerating Machinery — Oil Refinery Equipment

JOS. KUHN & CO.

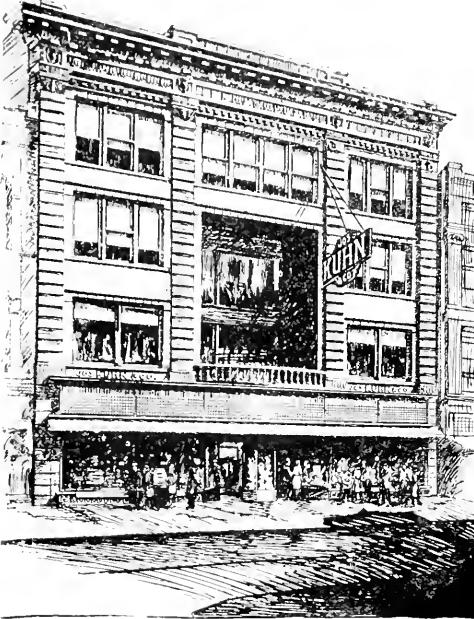

## Modern Foundry Design

(Continued from page 165)

conjunction with a displacement apparatus which will maintain a constant ratio of air and gas and a uniform pressure. The speed and displacement ratio of this apparatus is varied by hand to suit the variation in the heating value of the gas. The gases of combustion must be carried away by a fan.

The cooled castings should be brought from the cooling balcony by a flight of conveyors to the cleanout gratings where the cores are removed by hand. The recovery of this sand is by a similar method to that described above. This method will recover in practice about ninety per cent. of the sand. Air hammers should be used in chipping, and portable emery wheels for grinding of bins and grates. The chipping and rattling should be done in compartments having walls deadened against sound. Electric jar molding machines for the small castings are to be preferred. The number of molding machines will depend on the expected production from each machine. This figure must be determined very carefully after a study of results under good working conditions, for it has been shown that workmanship can produce a variation of about sixty per cent. Conveyor speeds will vary from eight to twenty feet per minute, the latter figure being maximum. All tumbler equipment for this work must be developed and should be of the horizontal, back geared, belt driven type. Commercial tumbler equipment for this continuous duty has proved extremely inadequate despite claims to the contrary. However, a type was developed and patented which has stood exceptional service.

The utilization of the waste heat in heating the building is of particular interest. The heating and ventilation system should be of the hot blast type. The galvanized iron ducts should be placed over the lower chord of the trusses. The duct outlets should be brought down to approximately head level. The system should be designed for fans in each bay, the preferred location for the fans being in pent houses above the roof. The heat losses in these buildings is enormous. In the building illustrated, the air change and direct heat loss per hour was about 222,000,000 B. t. u. Tests conducted by the writer show that very little heat was lost up the stack in the cupolas, while in the core ovens nearly 40 per cent. was lost. The air for some of the fans may be conducted around the discharge canopies of the core ovens. The cooling balcony for the hot castings may also be arranged with double canopies to assist in heating the air for other fans. This method on actual test showed a saving of nearly 36 per cent.

For  
Your  
Clothes

Where can you  
match this store

Central Illinois' Greatest Store for Men

Jos. Kuhn & Co.

33 35-37 Main St.

Champaign





## Climax of Two Centuries

**F**OR 219 years, seven generations, the Rhoadeses have been leather makers. And makers of good leather all those years.

But their pride today is Rhoads Tannate leathers, from which are made Tannate Flat Belts, Tannate Round Belting and Tannate Lace Leather.

The usual toughness, pliability and grip of Tannate make it an especially economical leather for many drives. And engineers do well to include it in their study of equipment.

We will gladly send you our little "Belt User's Book", gratis. It contains many helpful suggestions.

## J. E. RHOADS & SONS

PHILADELPHIA  
14 N. Third St.

NEW YORK  
144 Beekman St.

CHICAGO  
314 W. Randolph St.

Factory and Tannery: WILMINGTON, DELAWARE

*Schuler's*  
**BROS.**  
CONFECTIONERY

No. 9 Main St.

Champaign

Telephone Main 916

## Eat at Tite Wad's

"The Established  
Campus Eating  
place"

URBANA

# THE CORT

*The Ideal Place for Gentlemen*

LUNCH ROOM **18** SODA FOUNTAIN  
TABLES

Finest Equipped Billiard Parlor in  
Central Illinois

The Home of Many Champions

213-215-217 N. 6th St.  
CHAMPAIGN, ILLINOIS

## Why Work During the Summer

(Continued from page 183)

shapes of hat crowns now seen on the campus. He who can first impose one of these weird deformations upon the defenseless crown of his hat at once becomes the center of attention and envy of his companions; but this social distinction is generally short-lived, for some brother soon devises a form more absurd than his own. Even in shaking hands it is a mark of inferiority to simply extend the hand in a natural manner, for the etiquette of the "ultra" dictates that the hand should be first raised to a position well to the right and above the head, and then brought down with a pretentious swoop; and who would not be indebted to the man who would find a substitute for that shallow and odious, but universal phrase, "Glad I've met cha."

But enough of this exaggeration, which, though probably you have already guessed it, is mostly bunk. The basic idea is true; we need the broadening influence of intimate association with people of all classes, and the experience of competing against men at their own job.

Therefore, get a job this summer. Get a job because it will do you good. If you really object to earning money, don't let that stop you, for you won't make such an enormous amount anyway.

—J. H.

"The Prof's feeling fine—must have had a good game of golf."

"Yeh, he found four balls, got a couple of them before they stopped rolling."

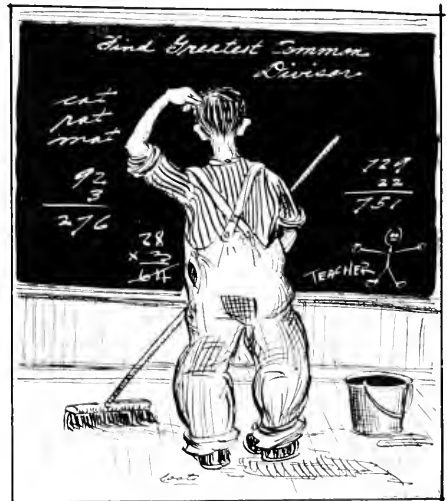

Is that darn thing lost again?

# KOEHRING

The  
Heavy Duty  
Mixer

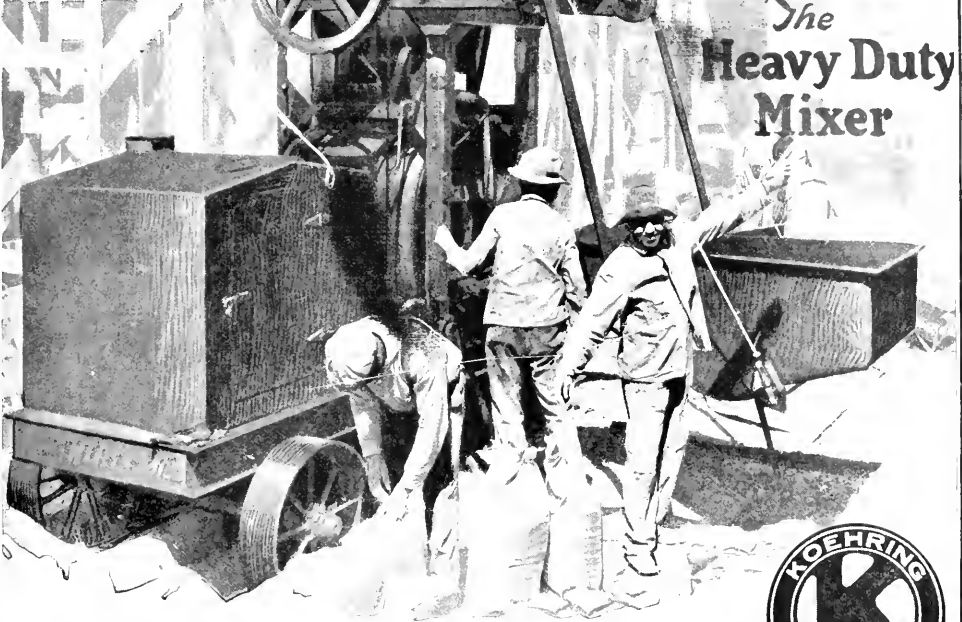

## Remixes Concrete

When materials have passed through mixing process once, and come to discharging side of the drum, the reversed discharge chute sprays them back to the charging side for repeated trips through the 5-action, remixing process. This spraying-showering action, at the same time prevents separation of aggregate according to size. To the last shovelful of every batch, Koehring-mixed concrete is uniform, re-mixed concrete—*dominant strength concrete*—and to every last casting and bearing, the Koehring is the heavy duty mixer of trouble-proof, long service life.

### Capacities

**Construction Mixers:** 10, 14, 21, 28 cu. ft. mixed concrete. Write for Catalog C 22

**Pavers:** 7, 10, 14, 21, 32 cu. ft. mixed concrete. Write for Catalog P 22

**Dandies:** Light mixer, 4 and 7 cu. ft. mixed concrete; power charging skip, or low charging platform. Light duty hoist. Write for Catalog D 22

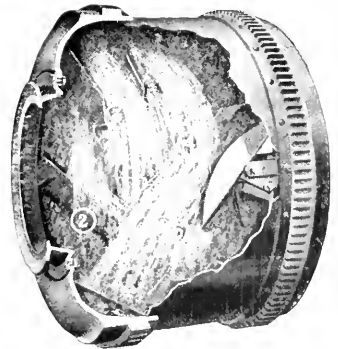

(1) Blade cuts through materials with churning action. (2) Blade carries materials up, spilling down again against motion of drum. (3) Materials hurled across diameter of drum. (4) Materials elevated to drum top and cascaded down to reversed discharge chute which (5), with scattering, spraying action, showers materials back to charging side for repeated trips through mixing process.

**KOEHRING COMPANY**  
MILWAUKEE WISCONSIN

## WESTERN BRICK COMPANY

Manufacturers of  
Artistic Facing Brick  
Hollow Building Tile  
and Common Brick

DANVILLE, ILLINOIS

## An Engineer Couldn't Do Much With a Crippled Hand

And to have a crippled slide rule is just about as bad.  
We not only sell slide rules but we keep them in repair, after you buy them.

### WE SELL:

K & E 10" Polyphase slide  
rules in leather case...\$6.00

K & E 10" Polyphase Duplex  
slide rules in leather case  
.....\$8.00

K & E Log-Log slide rules

Eugene Dietzgen 10" slide  
rules in leather cases

**STUDENT SUPPLY STORE**  
Service Saving Satisfaction

"Chuck" Bailey

"Shelby" Himes

## Alumni Notes

(Continued from page 193)

with the firm of Love Brothers of Aurora, Illinois. Things have been slack during the last year, he says, but that conditions seem to be improving now.

*Chas. Gordon*, ry. e. e., '12, after graduation obtained employment with the Chicago Surface Lines as a testing engineer. He has recently been promoted to the position of chief engineer of design and repair shops of the same company.

*Chester J. Scanlan*, m. e., '19, is at present time in charge of the engineering department of the Moline Heat Company, Moline, Illinois. This company sells engineering service as well as equipment, and Scanlan's most important problem has been that of making plans and specifications. He is also in charge of a newly created department of standardization, in connection with which he is carrying on some extensive research tests on the Univent.

*R. Stockenberg*, m. e., '19, is employed by the Johnson Service Company of Chicago, in the capacity of Sales Engineer.

*E. G. Young*, ry. m. e., '13, after receiving his Masters degree in '16, worked on the construction of the Rock Island Station at Kansas City. After the completion of the station, he became Chief Calculator of Weights for the American Locomotive Works at Schenectady, N. Y. Since 1918, he has been teaching mechanical engineering at Tangshang College, North China, and has recently been transferred to Nanyung College, Shanghai.

*H. H. Edwards*, c. e., '17, is the city engineer at Danville, Illinois. He has done a good deal of work on the public improvements of that city. One of the latest has been that of the Gilbert Memorial Bridge which is now nearing completion.

*C. E. Hayer* a. e., '18, is Chief Structural Engineer for Bradley and Good Manufacturing Company of Chicago, Illinois.

## Green Tea Pot

Tea Room and Restaurant

*Our large patronage speaks for itself*



Single-row, maximum type, radial bearing.



Double-row, maximum type, radial bearing.



Single-row, deep-groove Conrad type, radial bearing.



Double-row, deep-groove Conrad type, radial bearing.



Angular contact bearing—combination radial and thrust.

## —a Wide Variety of Types and Sizes

Whatever your ball bearing requirement—there is a type and size of Strom Bearing to meet it.

They are correctly designed, made of the highest grade materials and heat-treated by the most modern and approved methods.

# Strom BEARINGS

Skilled workmen and careful inspection are employed in every step of their manufacture.

“Wherever a shaft turns” you can thus be sure that Strom Bearings will give maximum service under the most exacting conditions.

Strom engineers will be glad to work with you on any bearing problems you may have. You will find their specialized experience to be highly valuable in determining the type and size of bearing which will give the best results.

**U. S. BALL BEARING MFG. CO.**

(Conrad Patent Licensee)

4500 Palmer Street  
CHICAGO, ILLINOIS



Double-acting, self-aligning thrust bearing with leveling washers. 2100-U Series.



Double-acting, self-aligning thrust bearing. 2100 Series.



Single-acting, self-aligning thrust bearing, leveling washer. 110-U Series.



Single-acting thrust bearing with flat seats (grooved races). 1100-F Series.



Double-acting thrust bearing, flat seats. 2100-F Series.



Single-acting, self-aligning thrust bearing. 1100 Series.

(188)



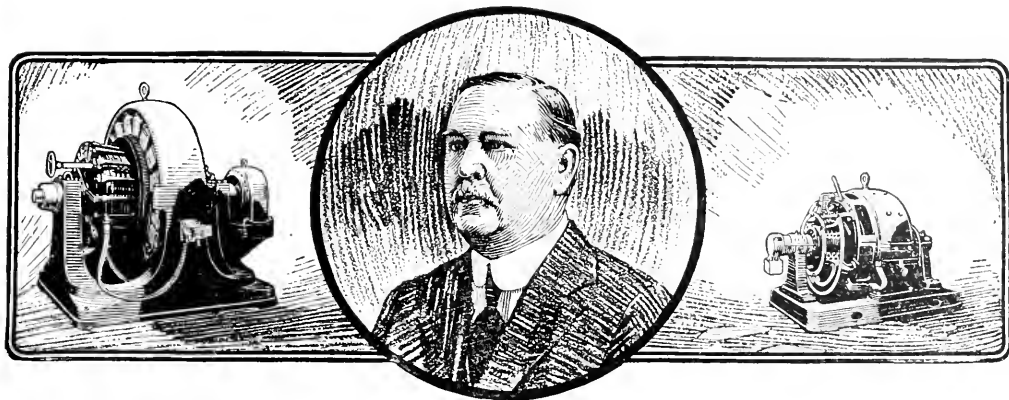

## Benjamin G. Lamme

**V**ISITORS at the Chicago World's Fair, in 1893, saw the first extensive use of alternating current ever undertaken, when Westinghouse lighted the entire grounds with this type of current. This achievement marked the beginning of the commercial development of alternating current for power purposes, and brought the induction motor into a prominence which it has never since relinquished. Great and rapid have been the developments since that day, but the most impressive aspect of this progress is not to be found in the spectacular evidences that are visible to everyone, but rather, in the vision and fundamental soundness and determination that have been quietly at work blazing and clearing the trails which the electrical art has followed.

There is, for instance, the synchronous converter. This machine is the most efficient and economical means for changing alternating to direct current, which the operation of most street railway systems and many other processes require. Without it, the development of alternating current to its present universal usefulness would have been tremendously retarded.

The synchronous converter, in its present perfection, is but one of the great contributions to electrical progress that have been made by Benjamin G. Lamme, Chief Engineer of the Westinghouse Electric & Manufacturing Company. Mr. Lamme, in 1891 when he was Chief Designer, conceived and developed the converter, which, first used commercially in connection with the

great Niagara power plan, has since come to be indispensable to large producers of power.

When a man has played so vital a part in electrical progress that his knowledge and vision have contributed to practically every forward engineering step, it is perhaps misleading to attempt to identify him particularly with any one development. His work on the induction motor, the turbo generator, the single-phase railway motor, and the synchronous converter is but typical of the constructive ability which Mr. Lamme has brought to bear on practically every phase of electrical development.

A man of foresight, visioning the alternatives in a problem as well as its hoped-for results. A man whose mind combines great power of analysis with the gift of imagination. A prolific technical writer, whose style is unequalled in clearness and simplicity of expression. Few engineers so thoroughly predetermine the results they actually achieve. Few men capitalize their experiences so completely. And few indeed have at once his thorough technical equipment, his commercial understanding, and his broad human interests.

An institution which has builded its success largely on engineering achievement pays Benjamin G. Lamme affectionate loyalty and respect. The young engineer on his first job, as well as the most seasoned co-worker, finds in him understanding, sympathy, wise counsel, and a conscience; to all of which his associates, in preparing this article, are proud to bear witness.

---

---

# Westinghouse

---

---



### BETTER LIGHTING NEEDED IN INDUSTRIAL PLANTS.

In a paper read before the Illuminating Engineering Society, February, 1920, entitled, "A Survey of Industrial Lighting in Fifteen States," R. O. Eastman submitted some very interesting data regarding the lighting conditions in industrial institutions. The survey comprises some 416 institutions, in which lighting was considered by 55.1% as being vitally important, and by 31.6% as being moderately important, and by 13% as being of little importance. Practically 58% considered that lighting was as important as power in the operation of the plant, and a small proportion would give more attention to lighting than to anything else.

In considering the present condition of lighting as found in the various plants, only 9% ranked as excellent, about 7% ranked as good, 29% fair, 18.8% poor, 3.5% very poor, and 7.8% partly good and partly poor. It was found that the lighting in the offices was far superior to that in the shops; 19% being excellent, 36% good, 31% fair, and only 13% poor and none very poor.

On consulting the executives regarding what factors were most important in considering lighting, the following facts were revealed: Increase of production 79.4%, decrease of spoilage 71.1%, prevention of accidents 59.5%, improvement of good discipline 51.2%, and improvement of hygienic conditions 41.4%. Manufacturers who have good lighting appreciated its value largely from the standpoint of its stimulating effect upon output.

There is no question that any intelligent man who carefully considers the necessity for good lighting in an industrial plant, will agree that it is impossible for a person to do as good work, either in quality or quantity, in poor light as in good light, but yet the result of a careful analysis discloses the fact that only about 40% of industrial plants are furnishing good light to their workers and 60% are operating under poor lighting. It is hard to understand why such a proportion of concerns can be satisfied with a condition which is universally admitted to be a curtailer of efficiency and a prolific causer of accidents. The principal cause of this condition is that those in charge of such establishments have not given the attention to lighting that it demands. They do not know what constitutes good lighting, and in their absorbing interest of other factors of production have overlooked a vital one.

Every safety official should deeply interest himself in the lighting of his plant and insist upon good lighting as much as good goggles, good guards and other necessary accident prevention equipment. Every production manager should insist upon good lighting because the efficiency of the working force is increased by the condition of the lighting furnished. The plant physician should examine the lighting, for eye strain and eye fatigue are directly affected by poor lighting, as is the hygienic condition. Well lighted plants are invariably cleaner than poor lighted places. Plants equipped with Factrolite Glass in all windows are well lighted.

If you are interested in the distribution of light through Factrolite, we will send you a copy of Laboratory Report—"Factrolited."

MISSISSIPPI WIRE GLASS CO.,

220 Fifth Avenue,

St. Louis,

New York.

Chicago.

the high quality of his products, and for expedition in the execution of his work.

He took a great interest in public affairs; and had been a member of the state militia, an alderman, a township supervisor, and county treasurer. He was a member of several commercial and social clubs, and in each took a prominent part. He was a member of Tau Beta Pi and of the American Society of Mechanical Engineers. He was held in high esteem by all for his integrity, firmness of character, good judgment, and kindly disposition.

IRA O. BAKER.

The title "engineer" does not carry with it the prestige that should be accorded a member of a profession that has been of such great service to mankind as has the engineering profession. The reason for this is that the great body of engineers have not displayed the proper respect and esteem for their profession. We say displayed because we know that actually engineers have held their profession in high regard, and that the seeming absence of professional pride has in reality been their indifference to the regard in which other men hold them and their profession. In a large measure this is still the situation. It is for you young men to change it, and to demand for your profession the prestige that it justly deserves. You must live and work among other men. Their estimate of you and of your profession is based on their estimate of you as professional men. If in your bearing, your speech, your writing—if in your daily life—you show your pride in, and your respect for the dignity and good of the engineering profession, then, and only then, will the world accord it the high position which it should occupy.

Student—"Has fortune ever knocked at your door?"

Beggar—"No, he always sent his daughter, Miss Fortune."—*Beauport*.

Patron—"Bring me the sugar, please."

Waitress—"Plug or fine cut?"

Patron—"Oh, just as you chews."—*Hedley*.

Wise—"Are you the lady who took my order?"

Waitress—"Yes sir."

Wise—"You're still looking well. How are your grandchildren?"

"Little Joe is some wrestler."

"Zat so?"

"Seldom thrown."—*Widow*.

He—"I could dance with you like this forever."

She—"Impossible—you're bound to improve."



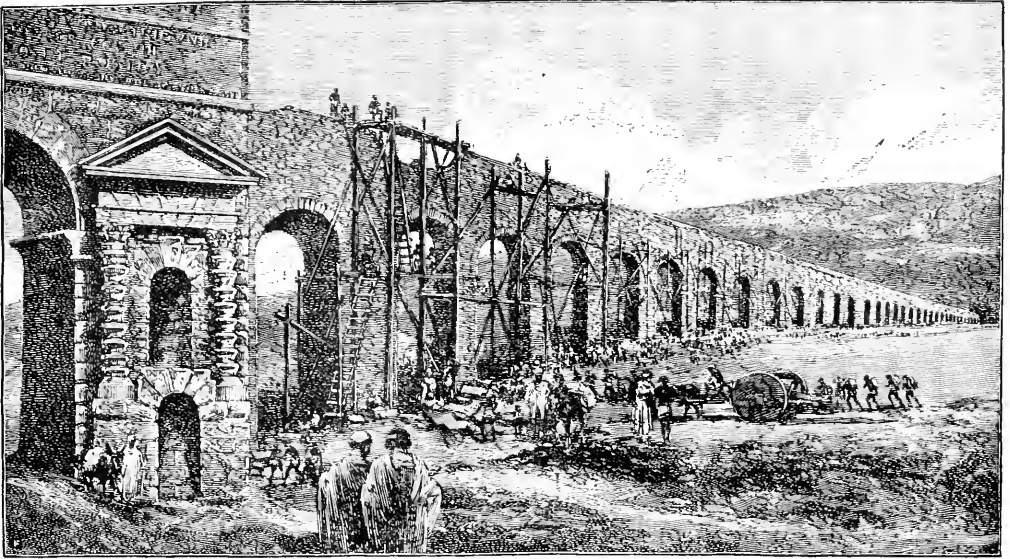

## The Aqueduct of Emperor Claudius

Prisoners of the Roman victories—slaves of the Emperor Claudius—were set to the task of bringing a water supply over 45 miles of hill and valley to Rome.

They labored long and in great numbers. Energy was measured then by hands and by backs to bend to the task; explosives were unknown.

Tools of metals were used to chip the rock and cut large grooves around the blocks to be excavated, wooden wedges swelled by water were used to break out the large pieces, fire was used to heat the rock which was then cooled and shattered by water. But men grew old at the task. The tunnel under Monte Salviano, 3½ miles long, ten

feet by six, took eleven years to complete with thirty thousand laborers at work.

Today, with the aid of Hercules Explosives, San Francisco is building the Hetch Hetchy aqueduct which will include 69 miles of tunnels. An advance of 776 feet in thirty-one days was made in one heading of the Priest tunnel on this project.

At this rate, Claudius' tunnel could be driven by a few men with Hercules Explosives in less than a year.

A lesson on explosives economy is contained in our booklet, "Volume vs. Weight". Write for a copy to our Advertising Department, 942 King St., Wilmington, Del.

# HERCULES

POWDER

COMPANY



Allentown, Pa.  
Birmingham, Ala.  
Buffalo, N. Y.  
Chattanooga, Tenn.

Chicago, Ill.  
Denver, Colo.  
Duluth, Minn.

Hazleton, Pa.  
Huntington, W. Va.  
Joplin, Mo.  
Los Angeles, Cal.

Louisville, Ky.  
New York City  
Norristown, Pa.  
Pittsburg, Kan.

Pittsburgh, Pa.  
Pottsville, Pa.  
St. Louis, Mo.

Salt Lake City, Utah  
San Francisco, Cal.  
Wilkesbarre, Pa.  
Wilmington, Del.

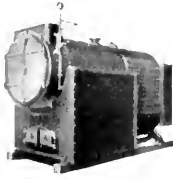

The "Economic"

# The Erie City Iron Works

Erie, Penn., U. S. A.

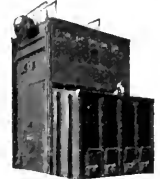

Vertical Water Tube

Manufacturers of

Steam Engines, Steam Boilers, Tanks,  
Steel Plate Construction



Return Tubular Stationary

"The Big Four"  
of Boilerdom



Horizontal Water Tube

## THE FACT

*that a K & E is the Slide Rule or Drawing Instrument selected by those who, through their knowledge, may justly be termed experts, is but added evidence of K & E superiority.*

*Drawing Instruments  
Surveying Instruments  
Measuring Tapes*

Keuffel & Esser Co. of N. Y.

520 South Dearborn Street  
CHICAGO

New York St. Louis Montreal  
San Francisco

General Office and Factories, Hoboken, N. J.

## Chicago Steel Tape Company

6231 Cottage Grove Ave., Chicago, Ill.



Manufacturers—Surveying Implements, Tapes, Leveling Rods, Self-Computing Rods, Stadia Rods, Rod Ribbons, Targets, Marking Pins, Lining Poles, Eureka Tape Repairers, Etc., Etc.,



## THE LIFE OF THE LINE

**T**HE TRANSMISSION LINE of today must be calculated in units of COST, PERFORMANCE AND LIFE.

It has often been said that "THERE IS ALSO A COST OF DOING WITHOUT".

The *Price* for the best may be higher, but is the final *Cost* as great?

The 20th Century Engineer is quite apt in keeping his lines in operation even under most adverse circumstances. But he also realizes that the use of best grade materials releases his effort from Maintenance to Development.

The Life of the Line is mainly dependent upon the materials used.

The INSULATOR of proven Strength, Ability and Life should be most desirable.

The UNIT having a certified record for 100% Efficiency, taken over a period of fifteen years, should be selected.

Now is the time to investigate the merits and many advantages found in the *Thomas LINK-TYPE Hewlett Insulator*.

Today, you should write for the new and interesting Booklet on this Insulator, "The Ultimate Unit."

**The R. Thomas & Sons Co.**

East Liverpool, Ohio

SALES OFFICES

NEW YORK    BOSTON    CHICAGO    LONDON

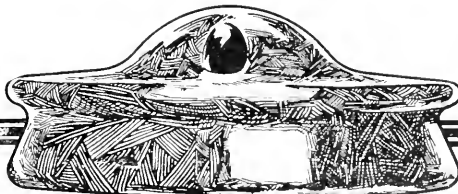

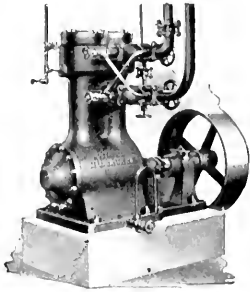

Established 1867

# The Vilter Manufacturing Co.

1020 Clinton St., Milwaukee, Wis.

Ice Making and Refrigerating Machinery  
Corliss and Poppet Valve Engines

Branch offices in all principal cities

*If interested write for bulletins*

## Engineering Experience

Allis-Chalmers' engineering experience covering more than sixty years devoted to the design and building of heavy machinery for many varied engineering and power purposes, includes prime movers of all types among which are some of the largest units ever built, electrical apparatus and many complete lines of industrial machinery.

By reason of this experience the Allis-Chalmers Organization is able to propose and furnish equipment best suited to meet the particular requirements of its customers. With the complete equipment built by our organization, under a single supervision, the many details, complications and delays incident to divided responsibility are avoided.

Let us figure on your requirements.

### ALLIS-CHALMERS PRODUCTS



- |                      |                         |
|----------------------|-------------------------|
| Air Brakes           | Metallurgical Machinery |
| Air Compressors      | Mining Machinery        |
| Cement Machinery     | Oil Engines             |
| Condensers           | Perforated Metals       |
| Crushing Machinery   | Pumping Machinery       |
| Electrical Machinery | Reciprocating Pumps     |
| Electric Hoists      | Saw Mill Machinery      |
| Farm Tractors        | Steam Engines           |
| Flour Mill Machinery | Steam Hoists            |
| Forgings             | Steam Turbines          |
| Gas Engines          | Timber Treating and     |
| Hydraulic Turbines   | Preserving Machinery    |

# ALLIS-CHALMERS

MILWAUKEE, WIS., U. S. A.

## Horton Tanks for Every Purpose



- Acid Tanks
- Ash Tanks
- Gas Holders
- Steel Bins
- Penstocks
- Surge Tanks
- Agitators
- Oil Storage Tanks
- Pulp Tanks
- Locomotive Storage Tanks
- Stills
- Chip Tanks
- Molasses Storage Tanks
- Stacks
- Breechings

### Chicago Bridge and Iron Works

Founded by HORACE E. HORTON 1865  
Chicago, New York, Atlanta, Dallas, San Francisco  
*In Canada, Horton Steel Works Ltd.*

29

## Wickes Vertical Water Tube Boiler

Have you seen the STEEL CASED SETTING for enclosing this boiler? Air infiltration losses are overcome. The highest possible thermal efficiency results.

Ask for Bulletin—Magnitude and Prevention of Air Infiltration Losses—sent free.

Ever cleaned a boiler, lamed your back, bruised your knees and skinned your elbows doing it? Two men can open, wash, close and fill the WICKES in five hours. Turbin in ten hours.

Ask for Bulletin—Reducing Costs on the Boiler Room—sent free

### The Wickes Boiler Company

SAGINAW, MICHIGAN

SALES OFFICES

New York City, 1746 West St., Bldg.  
Chicago, 76 West Monroe St.  
Boston, 201 Devonshire St.

Pittsburg, 1218 Empire Bldg.  
Detroit, 1116 Penrose Bldg.  
Seattle, 736 Henry Bldg.

Steel Cased Setting  
Increase Efficiency

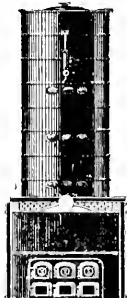

Man Stands erect Cleaning

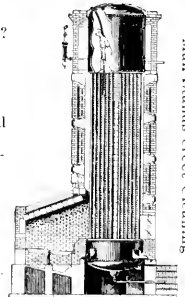

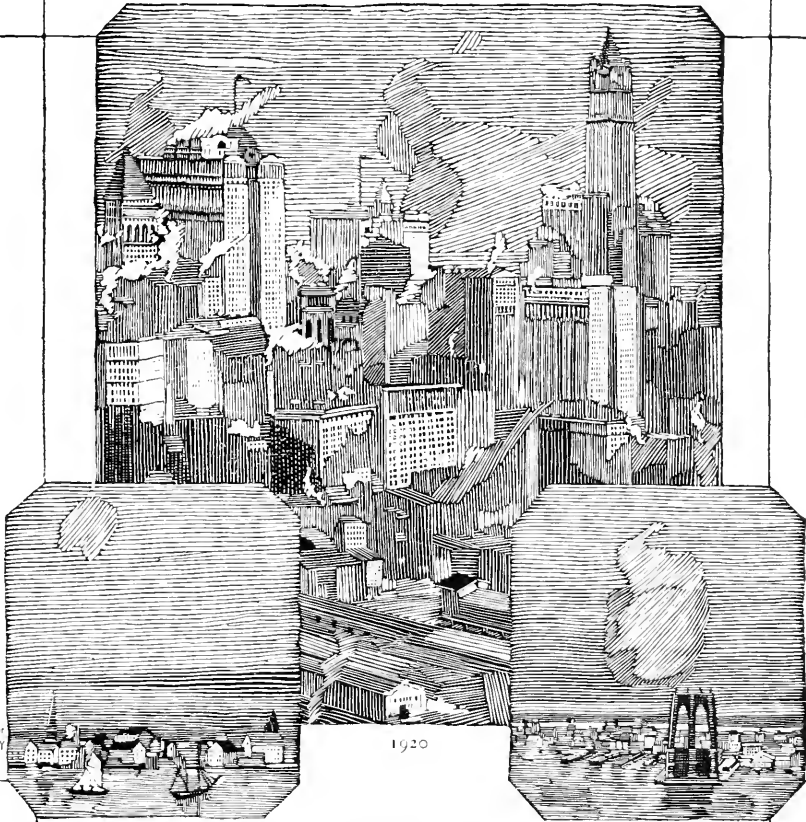

  
 The WORLD'S WORD for  
 ELEVATOR SAFETY

  
 The WORLD'S WORD for  
 ELEVATOR SAFETY

1790

1920

1870

## NEW YORK

*Most of the famous buildings of the world  
are equipped with Otis Elevators*

**THE WOOLWORTH TOWER**—the tallest office building; the Equitable—the largest; the Singer Building—in fact most of the buildings that make up the best known sky line in the world, are equipped with Otis Elevators.

Few people realize the amount of wealth of Manhattan Island that is due to the creation and development of modern vertical transportation by the Otis Elevator Company. New York City could not grow wider hemmed in as it was by the two rivers and the bay. It *had* to grow skyward.

And now, the Otis Elevators in New York City carry daily more than twice the number of passengers carried by all the traction lines of New York—subway, surface, elevated and railroads.

Nothing short of a book would adequately tell the story of Otis in New York alone.

**OTIS ELEVATOR COMPANY**

Offices in all Principal Cities of the World

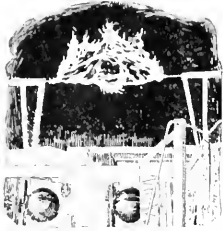

## Man-Made Lightning

**F**RANKLIN removed some of the mystery. But only recently has science really explained the electrical phenomena of the thunderstorm.

Dr. C. P. Steinmetz expounds this theory. Raindrops retain on their surfaces electrical charges, given off by the sun and other incandescent bodies. In falling, raindrops combine, but their surfaces do not increase in proportion. Hence, the electrical pressure grows rapidly. Finally it reaches the limit the air can stand and the lightning flash results.

And now we have artificial lightning. One million volts of electricity—approximately one fiftieth of the voltage in a lightning flash—have been sent successfully over a transmission line in the General Engineering Laboratory of the General Electric Company. This is nearly five times the voltage ever before placed on a transmission line.

Much valuable knowledge of high voltage phenomena—essential for extending long distance transmission—was acquired from these tests. Engineers now see the potential power in remote mountain streams serving in industries hundreds of miles away.

Man-made lightning was the result of ungrudging and patient experimentation by the same engineers who first sent 15,000 volts over a long distance thirty years ago.

“Keeping everlastingly at it brings success.” It is difficult to forecast what the results of the next thirty years may be.

**General Electric**  
General Office  **Company** Schenectady, N. Y.  
95-45HD

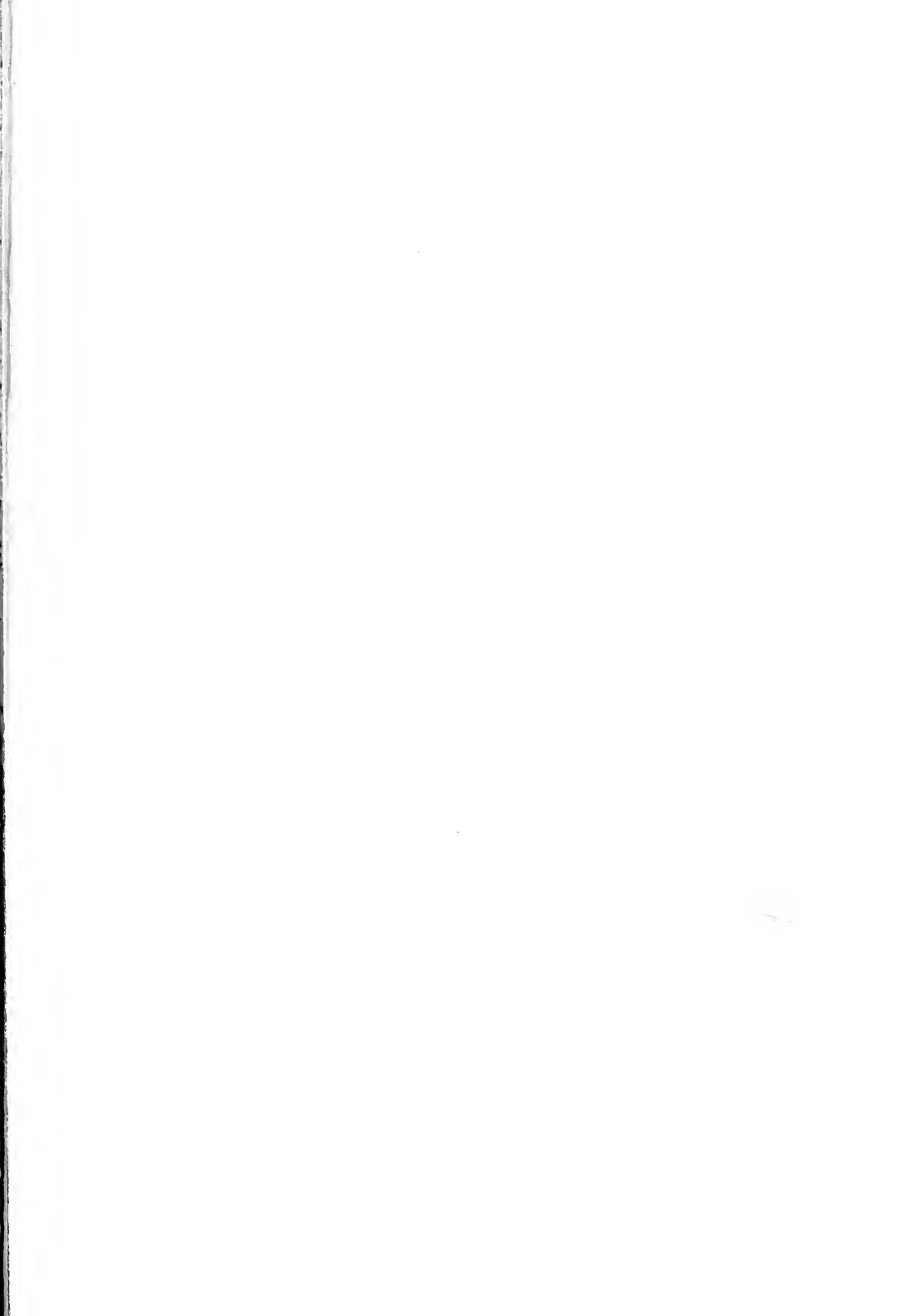











UNIVERSITY OF ILLINOIS URBANA



3 0112 061160880