

EX LIBRIS

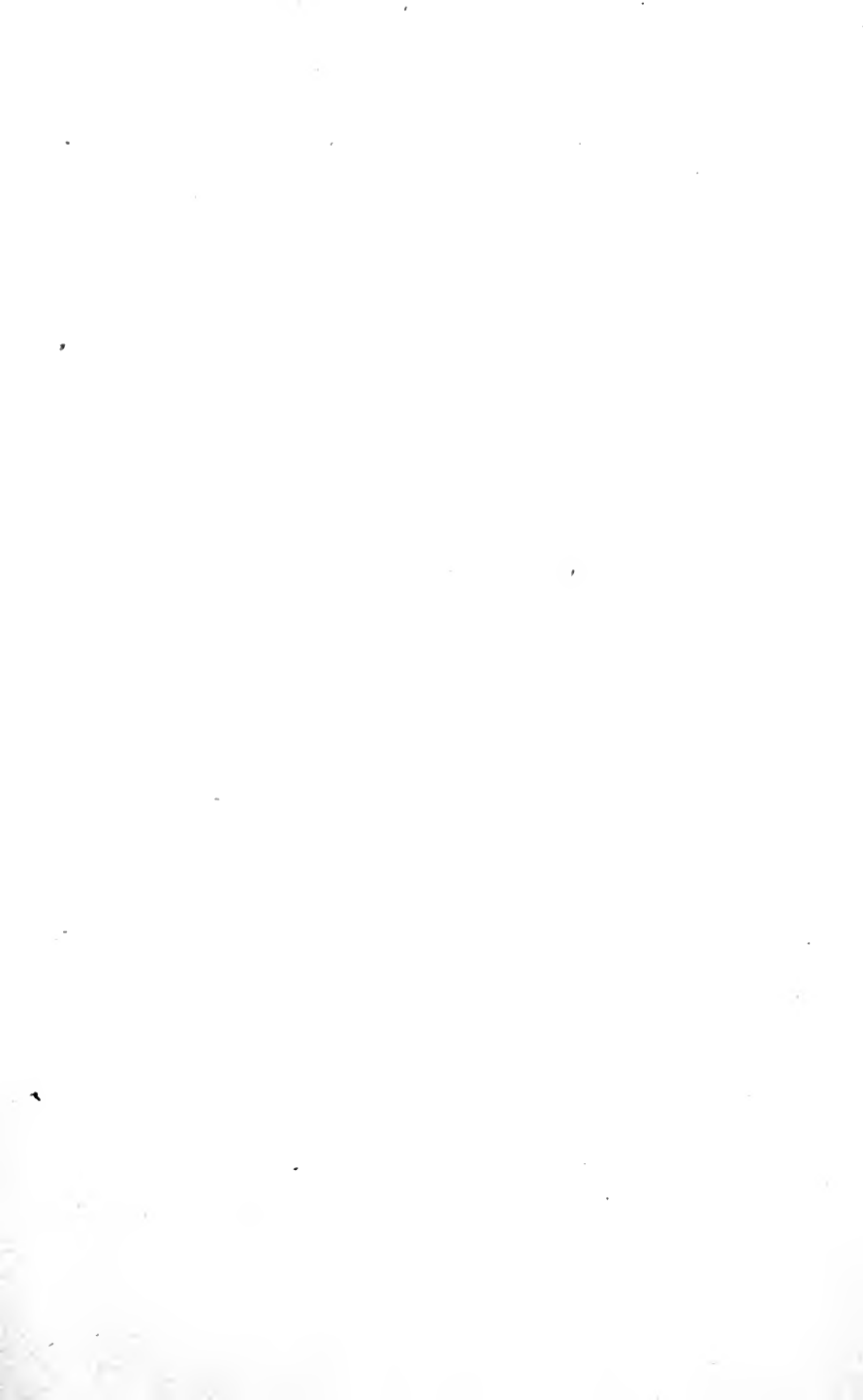







Other works by same author  
in collaboration with  
PROF. SAMUEL SHELDON

---

**DYNAMO ELECTRIC MACHINERY;** its  
Construction, Design and Operation  
VOL. I. DIRECT CURRENT MACHINES  
*Eighth Edition completely re-written,*  
5½x7¾ Cloth 338 Pages, Illustrated Net \$2.50

VOL. II. ALTERNATING CURRENT  
MACHINES, *Tenth Edition revised,*  
5½x7¾ Cloth 366 Pages, Illustrated Net \$2.50

---

**ELECTRIC TRACTION AND TRANSMIS-  
SION ENGINEERING**  
5½x7¾ Cloth 318 Pages, Illustrated Net \$2.50

# Telegraph Engineering

A MANUAL FOR PRACTICING TELEGRAPH  
ENGINEERS AND ENGINEERING  
STUDENTS

BY

ERICH HAUSMANN, E. E., Sc. D.

*Assistant Professor of Physics and Electrical Engineering  
at the Polytechnic Institute of Brooklyn, and  
Member of the American Institute  
of Electrical Engineers.*

---

**WITH 192 ILLUSTRATIONS**

---



NEW YORK  
D. VAN NOSTRAND COMPANY  
25 PARK PLACE  
1915

7-18-15  
11-2-15

COPYRIGHT, 1915,  
BY  
D. VAN NOSTRAND COMPANY

D. VAN NOSTRAND  
COMPANY

**Stanbope Press**  
F. H. GILSON COMPANY  
BOSTON, U.S.A.

DEDICATED TO

**Doctor Samuel Sheldon**

IN APPRECIATION OF HIS INSPIRING INFLUENCE



## P R E F A C E

---

THIS book is intended for electrical engineering students and as a reference book for practicing telegraph and telephone engineers and for others engaged in the arts of electrical communication. It presents in a logical manner the subject of modern overland and submarine telegraphy from an engineering viewpoint, its theoretical and practical aspects being correlated. No attempt is made to describe all telegraphic devices and to explain their operation, but rather to consider one or more representative types for the accomplishment of the various desired objects, thus permitting a presentation of the subject matter in proper perspective. The book is the outgrowth of the course in Telegraph Engineering given by the author for a number of years at the Polytechnic Institute of Brooklyn.

A knowledge of elementary electricity and magnetism is presupposed. For understanding the mathematical demonstrations a knowledge of algebra will in many cases suffice, but in other cases, appearing toward the latter part of the book, the calculus is a necessary adjunct, the study of which frequently precedes or accompanies the vocational studies of students and progressive telegraph workers. That the use of higher mathematics is important in the thorough pursuit of telegraph and telephone transmission studies is evident from an inspection of the writings of Lord Kelvin, Heaviside, Kennelly, Pupin, Campbell, Malcolm and others. Those not versed in mathematical

processes, however, may yet share in the value of the demonstrations by an analysis of their conclusions and an examination of the numerical illustrations based upon them. The solution of practical problems appended to each chapter will assist in a complete understanding of the principles presented.

The author expresses his appreciation and thanks to Mr. Herbert W. Drake, Apparatus Engineer of the Western Union Telegraph Company, for making helpful suggestions and for reading the page proofs of the first six chapters. He also gratefully acknowledges the inspiration and encouragement in the preparation of this work derived from his intimate association with Dr. Samuel Sheldon, Professor of Physics and Electrical Engineering at the Polytechnic Institute of Brooklyn.

E. H.

BROOKLYN, N. Y.

*January, 1915.*



# CONTENTS

## CHAPTER I.

### SIMPLEX TELEGRAPHY.

ART.	PAGE
1. Simplex Signalling . . . . .	I
2. The Use of Relays . . . . .	3
3. Closed- and Open-circuit Morse Systems . . . . .	5
4. Telegraph Instruments . . . . .	8
5. Best Winding for Receiving Instruments . . . . .	16
6. Sources of Current . . . . .	20
7. Telegraph Codes . . . . .	25
8. Telegraph Lines . . . . .	28
9. Speed of Signalling . . . . .	33
10. Simplex Repeaters . . . . .	35
Problems . . . . .	43

## CHAPTER II.

### DUPLEX TELEGRAPHY.

1. Duplex Telegraph Systems . . . . .	45
2. The Differential Duplex . . . . .	46
3. Artificial Lines . . . . .	51
4. Polarized Relays . . . . .	53
5. The Polar Duplex . . . . .	56
6. Improved Polar Duplex . . . . .	63
7. Short-line Duplex . . . . .	66
8. The Bridge Duplex . . . . .	67
9. Advantage of Double-current Duplex Systems . . . . .	74
10. Duplex Repeaters . . . . .	76
11. Half-set Repeaters . . . . .	80
Problems . . . . .	83

## CHAPTER III.

### QUADRUPLEX TELEGRAPHY.

1. Quadruplex Systems . . . . .	85
2. Operation of Quadruplex Systems . . . . .	87
3. Avoidance of Sounder-armature Release during Current Reversals in Neutral Relay . . . . .	94

ART.	PAGE
4. The Postal Quadruplex.....	96
5. The Western Union Quadruplex.....	98
6. Quadruplex Repeaters.....	100
7. Duplex-duplex Signalling.....	102
8. Phantoplex System.....	103
Problems.....	106

## CHAPTER IV.

## AUTOMATIC AND PRINTING TELEGRAPHY.

1. Wheatstone Automatic Telegraphy.....	108
2. Ticker Telegraphs.....	115
3. The Barclay Page-printing Telegraph System.....	121
4. Other Printing Telegraph Systems.....	133
Problems.....	134

## CHAPTER V.

## TELEGRAPH OFFICE EQUIPMENT AND TELEGRAPH TRAFFIC.

1. Protective Devices.....	135
2. Peg Switch Panels.....	136
3. Main and Loop Switchboards.....	138
4. Distributing Frames.....	143
5. Instrument Tables.....	145
6. Power Switchboards.....	146
<i>Traffic.</i>	
7. Types of Messages.....	150
8. Classes of Service and Tariffs.....	152
9. Handling of Traffic.....	154
10. The Telegraph in Railway Operation.....	157
11. Telegraph Statistics.....	159
Problems.....	161

## CHAPTER VI.

## MISCELLANEOUS TELEGRAPHS.

1. Multiplex Telegraph Systems.....	162
2. The Murray Multiplex Page-printing Telegraph.....	163
3. The Pollak-Virag Writing Telegraph.....	167
4. The Telautograph.....	170
5. Telephotography.....	175

## CONTENTS

xi

ART.	PAGE
6. Television.....	182
7. Military Induction Telegraphs.....	184
Problems.....	188

### CHAPTER VII.

#### MUNICIPAL TELEGRAPHS.

1. Fire-alarm Telegraphy.....	189
2. Fire-alarm Signal Boxes.....	192
3. Public Alarms.....	200
4. Fire-alarm Central Stations.....	202
5. Signalling Devices at Apparatus Houses.....	210
6. Operation and Routine of a Fire-alarm Telegraph System.....	212
7. Police Patrol Telegraphs.....	217
8. Statistics of Police and Fire Signalling Systems.....	221
Problems.....	223

### CHAPTER VIII.

#### RAILWAY SIGNAL SYSTEMS.

1. Classes of Railway Signalling.....	224
2. Types of Signals.....	225
3. Manual Block Signal Systems.....	231
4. Location of Automatic Block Signals.....	232
5. Automatic Block Signalling.....	237
6. Automatic Block Signals on Electric Railways.....	242
7. Interlocking Plant Signals.....	247
Problems.....	251

### CHAPTER IX.

#### TELEGRAPH LINES AND CABLES.

1. Aerial Open Lines.....	253
2. Wire Spans.....	261
3. Economical Span Length.....	266
4. Telegraph Cables.....	269
5. Underground Cable Installation.....	273
6. The Earth as a Return Path.....	279
7. Electrical Constants of Telegraph Conductors.....	282
8. Elimination of Inductive Interferences on Telegraph and Telephone Lines.....	288
9. Simultaneous Use of Lines for Telegraphy and Telephony.....	293
Problems.....	300

## CHAPTER X.

## THEORY OF CURRENT PROPAGATION IN LINE CONDUCTORS.

ART.	PAGE
1. The Transmission of Current Impulses along Telegraph Lines...	303
2. Propagation of Alternating Currents along Uniform Conductors of Infinite Length.....	306
3. Velocity of Wave Propagation over an Ideal Line.....	313
4. Wave Propagation along Conductors of Finite Length.....	314
5. Simplified Equations of Wave Propagation.....	321
6. Current and Voltage Distribution on Lines for any Terminal Condition.....	324
7. Effect of Impedance at Sending End.....	328
8. Illustration of Sine-wave Telegraphic Transmission.....	330
9. Current in Leaky Line Conductors.....	334
10. Illustration of Direct-current Signalling on a Leaky Telegraph Line.....	338
11. Simplex Signalling with Generators at Both Line Terminals.....	341
12. Duplex and Quadruplex Signalling.....	344
Problems.....	346

## CHAPTER XI.

## SUBMARINE TELEGRAPHY.

1. Theory of Cable Telegraphy.....	347
2. Illustration of Current Growth at the Receiving End of a Cable.....	354
3. Transmission of Telegraphic Signals.....	355
4. Speed of Signalling.....	363
5. Picard Method of Signalling.....	367
6. Gott Method of Signalling.....	369
7. Duplex Cable Telegraphy.....	372
8. Sine-wave Signalling.....	374
9. Design of Submarine Cables.....	375
10. Types of Cable Service and Tariffs.....	381
Problems.....	385

## APPENDIX.

## TABLES.

I. Trigonometric Functions.....	388
II. Exponential Functions.....	390
III. Logarithms.....	392
IV. Hyperbolic Functions.....	394

# TELEGRAPH ENGINEERING

## CHAPTER I

### SIMPLEX TELEGRAPHY

1. **Simplex Signalling.** — The transmission of intelligence between two points by means of electricity was accomplished in 1837 by Professor Samuel F. B. Morse of New York University.\* Seven years later he constructed the first telegraph line in this country (Baltimore to Washington). The modernized system comprises a conveniently-operated switch called a *key*, for opening and closing the circuit at one place, a source of electric current, an electromagnetic receiving device capable of producing an audible effect, called a *sounder*, at another place, and a *line wire* connecting the two places or stations. Signals are transmitted over such a circuit by opening and closing the circuit by means of the key for long and short intervals in accordance with a prearranged code, and are interpreted at the other station by the sounds produced by the movements of a pivoted spring-controlled lever actuated by an electromagnet which is traversed by the current pulses established by the key. In order to transmit messages in either direction, the apparatus mentioned is duplicated and connected with the single line wire as shown in Fig. 1.

The earth is generally utilized as the return path for the

\* Earlier electric telegraphs are described in J. J. Fahie's "A History of Electric Telegraphy to 1837."

current, thereby saving the expense of another line wire and also avoiding the additional resistance introduced thereby. The resistance of the ground-return path  $GG$  is negligible in comparison with the resistance of the line wire, for in nearly all cases it is less than one ohm. This low resistance is due to the enormous cross-sectional area of the earth path, although the conductivity of the earth's crust is poor. Recent experiments, made by Löwy, indicate that the specific resistance of a variety of rocks is greater than  $10^5$  ohms per centimeter cube, depending upon the amount of moisture in them. To attain low earth resistances it is

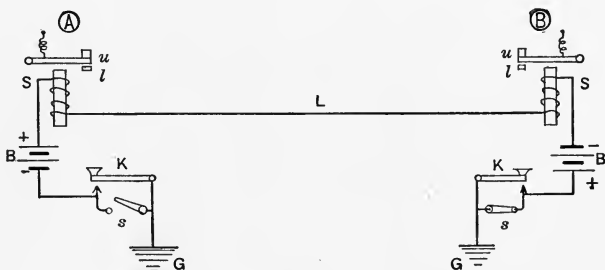

Fig. 1.

essential that good connections be made between the line wire and earth, by iron pipes driven in damp ground or more usually by attachment to municipal water pipes.

When the line is idle the circuit of Fig. 1 is kept closed by means of the circuit-closing switches  $s, s$  in parallel with the keys  $K, K$ , causing a current to flow continually from ground  $G$  at station  $A$  through switch  $s$ , battery (or generator)  $B$ , sounder  $S$ , line  $L$ , sounder  $S$ , battery (or generator)  $B$ , and switch  $s$  to ground  $G$  at station  $B$ . When the operator at station  $A$  wishes to send messages, he interrupts the current by opening his circuit-closer  $s$  (as

shown in Fig. 1) and then establishes current pulses by depressing his key for long or short intervals producing respectively so-called *dashes* and *dots*, various combinations of which constitute the letters and numbers of a code. These current pulses flow through the windings of both sounders, causing the armatures on the levers to be attracted and released repeatedly and causing the other ends of these levers to strike against lower and upper stops, *l* and *u*. The long and short intervals between the two different sounds produced by striking the lower and upper stops are translated by ear as dashes and dots by both operators. The sending operator therefore hears his own message and is enabled to detect possible errors; it also serves as an indication that the line is not open-circuited. When the operator is through sending signals, he again completes the circuit by means of the circuit-closer, thereby enabling the other operator to answer.

The system described permits of signalling in only one direction at a time, and is therefore called a *single Morse*, or conveniently, a *simplex* telegraph system. It is still in use at present for short distances, and with more sensitive receiving instruments may be used for longer distances.

**2. The Use of Relays.** — The lever of a sounder must have a certain mass so as to produce loud and distinct sounds when striking the stops. A definite magnetizing force is required to move the lever with positiveness in opposition to its adjustable retractile spring. This magnetizing force is measured by the product of the number of turns of wire on the sounder winding and the current traversing it. Sounders of the usual construction require from 150 to 500 ampere-turns for proper operation.

On long lines having high resistance the current is necessarily small for practicable voltages, and it would not be feasible to use ordinary sounders wound with a great many turns of fine wire to secure a proper magnetizing force because of the additional resistance introduced. Instead, more sensitive instruments, called *relays*, are used, which have light armatures with contact points that open and close *local circuits* containing sounders and local batteries. Such relays for simplex signalling require a magnetizing force of from 70 to 300 ampere-turns.

For a given impressed voltage  $E$  on a perfectly insulated ground-return line of length  $l$  miles, having a resistance of  $R$  ohms per mile, with two receiving instruments each of  $R_r$  ohms resistance, the steady current in the circuit is

$$I = \frac{E}{lR + 2R_r} \text{ amperes.}$$

If  $I_{\min}$  be the minimum current which will actuate the receiver, the limit of transmission for a given voltage  $E$  is

$$l_{\max} = \frac{1}{R} \left( \frac{E}{I_{\min}} - 2R_r \right). \quad (1)$$

If the electromotive force  $E$  be developed by  $N_b$  series-connected primary batteries, each of voltage  $e$  and internal resistance  $R_b$ , then replace  $E$  in the foregoing equations by  $N_b(e - I_{\min}R_b)$ .

Thus, if two 20-ohm sounders requiring a current of  $\frac{1}{5}$  ampere be the receiving instruments on a 12.4-ohm-per-mile ground-return line, the maximum length of line operated on 140 volts would be

$$l_{\max} = \frac{1}{12.4} \left( \frac{140}{0.20} - 2 \times 20 \right) = 52 \text{ miles;}$$



whereas if 150-ohm relays requiring a current of 0.04 ampere be the receiving instruments, the distance of transmission over this line would be

$$l_{\max} = \frac{1}{12.4} \left( \frac{140}{0.04} - 2 \times 150 \right) = 258 \text{ miles,}$$

a distance five times as great as before. By the use of lines of lower resistance per unit length, the distance of transmission can be increased in both cases.

The voltage necessary for telegraphic transmission over a given distance can also be found from equation (1). Voltages over 200 are rarely employed in simplex signalling.

The windings of relays and sounders are generally designated by their resistance although the number of turns is the important consideration; this is done because of the ease in measuring the resistance of a finished instrument.

**3. Closed- and Open-circuit Morse Systems.** — The simple Morse circuit of Fig. 1 is normally closed, that is, it carries a current when no messages are transmitted, and is therefore called a *closed-circuit system*. The connections

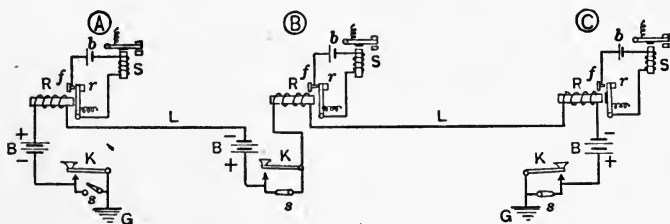

Fig. 2.

of a closed-circuit system employing relays and local circuits at the stations are shown in Fig. 2, which also includes an intermediate station. When the operator at station A

depresses his key the three relays  $R$  will be actuated and their armatures will be drawn from the rear stops  $r$  and strike the front contact screws  $f$ , thereby completing the three local circuits and permitting the local batteries  $b$  to operate the sounders. As many as thirty or forty intermediate stations may be connected in series on a single line, but only one operator can send at one time; all operators, however, may receive the message whether intended for them or not. If another operator wishes to send he must wait until the line is idle, or else, if the urgency of his message warrants, he may interrupt traffic by opening the circuit at his station with the switch  $s$ , and then transmit. Such interruption also takes place when one operator wishes to verify a portion of a message transmitted by another.

The closed-circuit telegraph system is used throughout the United States. It is important that the relays on a circuit be of the same type, or, more specifically, that they have the same number of turns on their windings for the same core construction, so that the common current in the circuit will occasion the same magnetizing force in each relay and insure proper functioning of the armature.

If primary or secondary cells are used as the source of current, they may be grouped together forming one battery at one station, may be divided into two batteries located at the terminal stations, or may be apportioned among the various stations forming a number of separate batteries, care being exercised not to have some batteries connected in opposition to others. A single battery in a circuit conduces to uniform care of all cells and to economy of maintenance. On the other hand, should a circuit with a single battery at a terminal station become grounded, all

stations beyond the ground would be rendered inoperative and unable to communicate with each other. A ground on a circuit with two terminal batteries prevents through operation, but the stations on each side of the ground can temporarily maintain local communication.

Another simplex telegraph system is used extensively in Europe, namely the so-called *open-circuit system*, in which the main-line circuit is really normally closed but does not include a source of current when no messages are being transmitted. The system derives its name from the fact that all batteries are normally open-circuited. The connections of two terminal stations and one intermediate station using the open-circuit system are shown in Fig. 3,

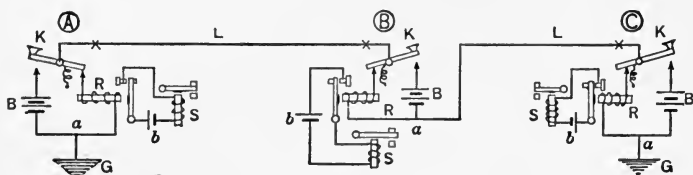

Fig. 3.

the letters having the same significance as before. The depression of a key at a station introduces the source of current at that station into the circuit and causes the operation of the relays at all the other stations. These in turn operate the sounders through the local batteries, as before.

In the open-circuit system the voltage of the batteries or generators at the various stations should be the same and sufficient individually to operate the entire circuit, whereas in the closed-circuit system the current sources may be subdivided arbitrarily so long as the aggregate voltage is sufficient to operate the entire circuit. Since

current flows when no messages are sent in the closed-circuit system, a greater amount of electrical energy is required for the operation of this system than the open-circuit system. When the connections of Fig. 3 are employed, the sending operator does not hear the signals that he sends out on the line, but this disadvantage can be avoided by shifting the relays from their present position to the points on the line marked *x* and connecting the back key contacts directly with the points *a*.

In the foregoing figures relays and sounders were represented as having a single core, while in reality they have two cores connected at the rear with a soft iron yoke. The windings on the two cores are usually connected in series. This method of graphic representation will be retained for the sake of clearness.

**4. Telegraph Instruments. — Keys.** A key extensively used on closed-circuit systems is the Bunnell key illustrated in Fig. 4. It consists of a steel lever carrying a flat hard-

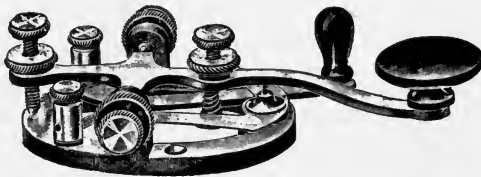

Fig. 4.

rubber knob at one end, and pivoted near the other end in trunnion screws that are mounted in uprights extending from the elliptically-shaped brass base. The movement of the lever is adjustable by the knurled screw at its rear end. The other end of the lever is kept up normally by means of the spring shown, the tension thereof being regu-

lated by the knurled screw through the middle of the lever. When the knob is depressed a platinum point on the under side of the lever makes contact with a similar point fixed in a cone-shaped cap fastened to, but insulated from, the base. This latter contact point is connected by a brass strip to the front binding post, which is also insulated from the base; the other terminal is fastened directly to the base and therefore is in metallic connection with the contact point carried on the lever. An auxiliary lever, called a circuit-closer, carrying a taller knob, is pivoted on the base to move horizontally, so as to engage, when pressed toward the key lever, an extended clip on the fixed contact point, thereby short-circuiting the key.

In holding the key for sending, the index finger should rest on the knob, with the thumb and second finger on its edge for steadying the motion of the key. Depressing the key closes or *makes* the circuit and releasing the key opens or *breaks* the circuit.

Occasionally horizontally-operated keys with double contacts are employed, requiring but half the motions in the formation of telegraphic characters that are necessary with the usual vertically-operated keys. Fig. 5 shows the Bunnell "double-speed" key. The lever is attached to a post at the rear end of the key by means of a flat spring. It stands normally midway between the two platinum contacts that are supported in a

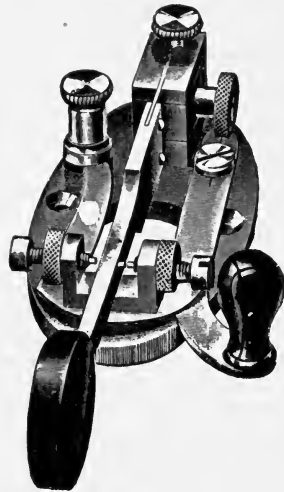

Fig. 5.

U-shaped piece, mounted on, but insulated from, the base. This connects with the binding post, the other terminal being the post which supports the lever. In operating the key, the knob should be allowed free play between thumb and finger, and the hand given a sidewise rocking motion. Moving the lever to the right or left closes the circuit.

Many semi-automatic key transmitters, called vibroplex or mecograph transmitters, are used, and permit experienced operators to signal faster than with the keys already described. The horizontally-operated lever has a pendulum extension having an adjustable vibration rate. To form a dash the operator holds the key knob to the left for a suitable length of time; to form dots the key is moved to the right and held there while the pendulum transmits automatically any desired number of dots.

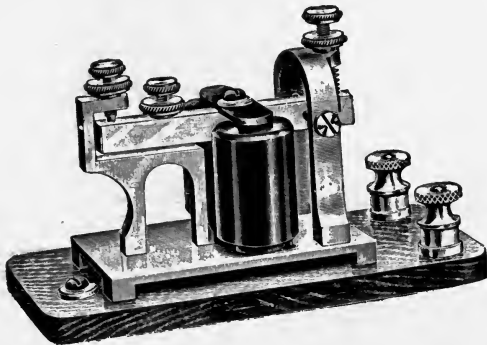

Fig. 6.

*Sounders.* Fig. 6 shows a typical sounder. It consists of a horseshoe electromagnet with two series-connected coils protected by hard-rubber shells, and a pivoted brass or aluminum lever carrying a soft-iron armature properly placed with respect to the magnet poles. The lever is

pivoted near one end in trunnion screws mounted on an inverted U-shaped standard, this end being held down normally by a spring whose compression is regulated by a knurled screw at the top of the standard. The motion of the lever is limited at the other upright by the two screws at the left, their adjustment being fixable by the locknuts. The parts mentioned are mounted on a brass surbase which is in turn mounted on the wooden base carrying the binding posts that connect with the coil terminals. Perfect sounders produce a clear loud tone and act quickly.

Sounders for main line use, that is for short lines without relays, are generally wound to have a resistance of 20



Fig. 7.

ohms, but many have resistances up to 150 ohms; for local circuit use they are usually wound to a resistance of 4 ohms.

For enhancing and concentrating the signals emitted by sounders, these instruments are encased in resonators, such as shown in Fig. 7. They are especially adapted for oper-

ators located in large offices or in noisy railway stations, and for operators using typewriters in recording received messages. The type illustrated is capable of being turned through three-fourths of a revolution, and is provided with a message clip.

*Relays.* — A relay widely used is shown in Fig. 8. It consists of a horizontally mounted electromagnet, the two cores of which are joined at the back by a soft-iron yoke. This electromagnet is movable longitudinally through the bobbin guide by means of the screw at the right, so as to vary the length of the gap between the magnet poles

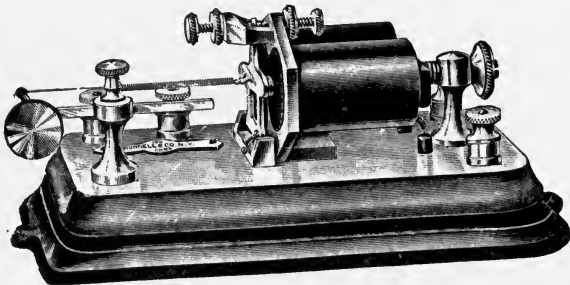

Fig. 8.

and the armature, which is mounted in front of them. This armature is pivoted at the lower end, while the upper end or tongue plays between two adjustable screws, with locknuts, supported on the bobbin guide. An adjustable retractile spring suitably mounted keeps the armature normally away from the magnet poles and against the back stop screw which contains a small piece of insulating material. When the relay is energized the platinum contact on the tongue touches a similar contact in the front stop screw and thereby completes the local circuit which is joined to the left-hand binding posts. The right-hand



binding posts are the terminals of the magnet winding, and connect with the lines.

In practice, relays have resistances ranging from 20 to 300 ohms, but 150-ohm relays are the most extensively used. A 150-ohm relay in considerable use consists of 6500 turns of No. 30 B. & S. single-silk-covered copper wire and operates commercially on 0.05 ampere, although it can be adjusted to work reliably on a current as small as 0.010 ampere. The average distance between the armature and pole faces of the magnets is about 0.03 inch. When traversed by a 25 cycle alternating current of 0.08 ampere the impedance of the relay is about 550 ohms.

The number of turns of copper wire which can be accommodated on any magnet bobbin may be quickly found by multiplying the length of the winding space in inches by the permissible depth of the winding in inches and dividing this result by a winding constant for the selected wire size, values of which constant are given in the following wire table:

B. & S. gage	Diameter of bare wire in mils	Winding constants		B. & S. gage	Diameter of bare wire in mils	Winding constants	
		Single-silk- covered copper wire	Enameled copper wire			Single-silk- covered copper wire	Enameled copper wire
16	50.82	0.00267	.....	29	11.26	0.000168	0.000137
17	45.26	0.00214	.....	30	10.03	0.000142	0.000113
18	40.30	0.00173	.....	31	8.928	0.000121	0.0000928
19	35.89	0.00138	.....	32	7.950	0.000105	0.0000767
20	31.96	0.00110	.....	33	7.080	0.0000889	0.0000645
21	28.46	0.000884	0.000845	34	6.305	0.0000766	0.0000484
22	25.35	0.000708	0.000673	35	5.615	0.0000658	0.0000398
23	22.57	0.000568	0.000534	36	5.000	0.0000570	0.0000334
24	20.10	0.000458	0.000413	37	4.453	0.0000497	0.0000268
25	17.90	0.000370	0.000327	38	3.965	0.0000437	0.0000227
26	15.94	0.000299	0.000267	39	3.531	0.0000388	.....
27	14.20	0.000244	0.000210	40	3.145	0.0000348	.....
28	12.64	0.000202	0.000170				

When a constant electromotive force is impressed on the terminals of a relay or sounder the current does not instantly assume its ultimate value because of the inductance of the electromagnet. As the inductance of a winding surrounding iron depends on the current traversing the winding and the position of the armature, it is difficult to calculate the growth of current as a function of time for these telegraph instruments. The lower curve of Fig. 9

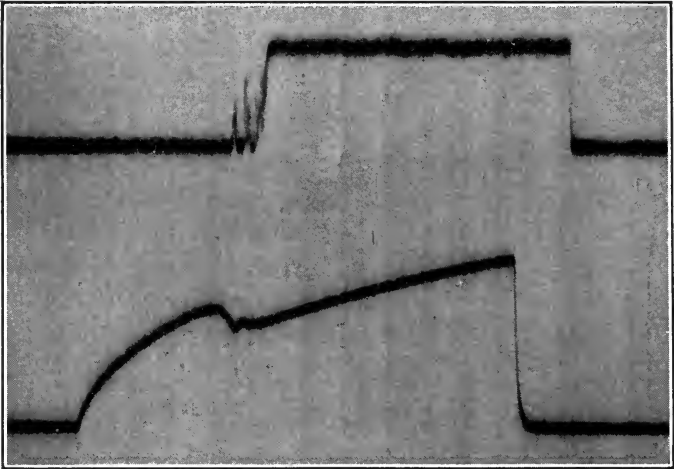

Fig. 9.

shows the growth of current strength in a typical relay as obtained experimentally by means of an oscillograph. Abscissas represent time — one inch corresponds to 0.037 second; ordinates represent current strength — one inch corresponds to 0.030 ampere. The upper curve shows the current in the circuit controlled by the relay contacts. It will be observed that one-thirtieth of a second elapses after impressing voltage on the relay coils before armature chat-

tering ceases and the local circuit is closed. This time, with different instruments, varies in some way with the ratio of the inductance to the resistance of the relay.

When the impressed voltage is withdrawn the relay armature is not immediately drawn back by the spring because of the residual magnetism in the cores. To attain quick release the armature when drawn toward the magnet poles should not quite touch them. This condition is obtained by the stop screws or else by the insertion of small non-magnetic pins in the pole faces so as to project about  $\frac{1}{64}$  of an inch.

*Registers.* — Where it is desired to record automatically the received signals, as in small telegraph offices, or with

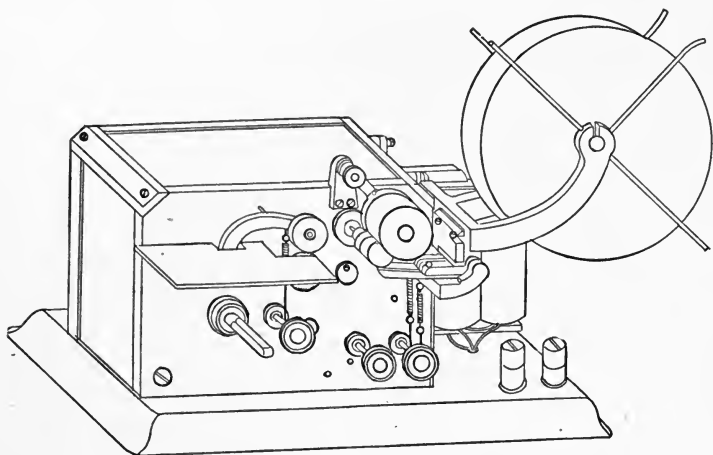

Fig. 10.

the District Telegraph Messenger Service, an ink-recording sounder or *register* may be used. A register consists of an electromagnet and a pivoted armature lever which presses a paper tape against an inked wheel when actuated. Spring-

driven clockwork moves the tape past the inked printing wheel, the motion beginning at the first current impulse

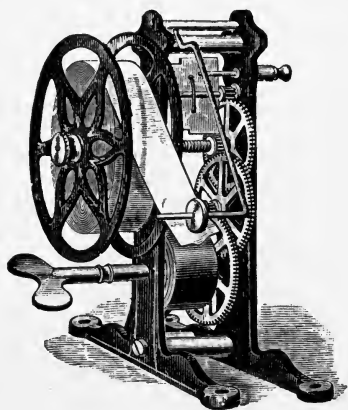

Fig. 11.

and ending some seconds after the last impulse. Fig. 10 shows a register and Fig. 11 shows an automatic paper winder used with it for winding up the paper as it is delivered from the register.

**5. Best Winding for Receiving Instruments.**— On a telegraph line the windings on the receiving instruments might have many turns of

small wire or fewer turns of larger wire for the same winding space. The former windings require a smaller current than the latter for a given magnetizing force, but at the same time have a greater resistance. On reflection it will be observed that a best winding exists for each set of conditions, which winding results in the greatest transmission distance for lines of given cross-section. The method of determining this ideal winding is given below.

If  $A$  be the winding space on an electromagnet in square inches and  $d$  be the diameter of the wire over insulation in inches, the number of turns will be

$$n = \frac{A}{d^2}, \quad (2)$$

which takes no account of bedding of wires in preceding layers or of interleaving insulation. If  $D$  be the wire diameter in mils, and  $z$  be the mean length of a turn in

inches, the resistance of the copper wire forming the winding will be

$$R_r = \frac{0.87 nz}{D^2} \text{ ohms} \quad (3)$$

at 20° cent., where the constant 0.87 is the resistance of a copper wire 1 inch long and 0.001 inch in diameter.

The steady current traversing the circuit of length  $l$  miles with  $N$  identical relays in series for an impressed unidirectional voltage  $E$  is

$$I = \frac{E}{Rl + NR_r} \text{ amperes,} \quad (4)$$

where  $R$  is the line resistance per mile. The line is assumed perfectly insulated from ground. Therefore the ampere-turns are

$$nI = \frac{EA}{d^2 \left( Rl + \frac{0.87 nzN}{D^2} \right)},$$

from which

$$l = \frac{A}{Rd^2} \left( \frac{E}{nI} - \frac{0.87 Nz}{D^2} \right).$$

Taking  $g$  as the thickness of insulation in inches,

$$d = \frac{D}{1000} + 2g \text{ inches,}$$

$$\text{and} \quad l = \frac{A}{R \left( \frac{D}{1000} + 2g \right)^2} \left( \frac{E}{nI} - \frac{0.87 Nz}{D^2} \right) \text{ miles.} \quad (5)$$

In order to find the maximum distance of transmission as a function of wire diameter, this equation is differentiated with respect to  $D$  and equated to zero. Whence

$$D^3 - \frac{1.74 zN (nI)}{E} D - \frac{1,740 zgN (nI)}{E} = 0,$$

which is of the form  $D^3 - PD - Q = 0$ . The solution of this form is

$$D = 2\sqrt{\frac{P}{3}} \cos \left( \frac{1}{3} \cos^{-1} \left[ \frac{\frac{Q}{2}}{\left(\frac{\sqrt{P}}{3}\right)^3} \right] \right)^* \text{ mils.} \quad (6)$$

This result gives the size of wire to be used in winding the coils of the receiving instrument, and substituting this value in equation (3) gives the instrument resistance.

As a numerical illustration consider relays having the following constants:

Sectional area of winding on both coils =  $A = 1.0$  sq. in.,

Mean length of turn =  $z = 2.4$  inches,

Number of relays in circuit =  $N = 10$ ,

Impressed voltage =  $E = 120$  volts,

Ampere-turns necessary for actuation =  $nI = 200$ ,

Thickness of silk insulation =  $g = 0.001$  inch.

For these values

$$P = \frac{1.74 z N (nI)}{E} = \frac{1.74 \times 2.4 \times 10 \times 200}{120} = 69.6,$$

$$Q = 1000 g P = 1000 \times 0.001 \times 69.6 = 69.6,$$

and consequently the wire diameter for the relay is

$$D = 2\sqrt{\frac{69.6}{3}} \cos \left( \frac{1}{3} \cos^{-1} \frac{\frac{69.6}{2}}{\sqrt{\left(\frac{69.6}{3}\right)^3}} \right) \\ = 2\sqrt{23.2} \cos \left( \frac{1}{3} \cos^{-1} 0.312 \right) = 9.632 \cos 23^\circ 57' = 8.80 \text{ mils.}$$

\* If the bracketed expression is greater than unity, hyperbolic cosines are taken. For cosine tables see the Appendix.

The nearest standard wire size hereto is No. 31 B. & S. gage, for which  $D = 8.93$  mils. Using No. 31 wire, the number of turns on both relay bobbins is

$$\frac{1.00}{(0.00893 + 0.002)^2} = 8360,$$

and the resistance of the instrument is

$$R_r = \frac{0.87 \text{ } n\Omega}{D^2} = \frac{0.87 \times 8360 \times 2.4}{(8.93)^2} = 219 \text{ ohms.}$$

Thus the ideal relay winding for the given conditions would consist of 8360 turns of No. 31 copper wire having a resistance of 219 ohms. With 10 of these instruments the maximum distance of telegraphic transmission is such that the resistance of the whole line exclusive of relays is (from equation 4)

$$\frac{En}{200} - NR_r = \frac{120 \times 8360}{200} - 10 \times 219 = 2826 \text{ ohms.}$$

Using a 12.4-ohm-per-mile line, this means a transmission distance of  $\frac{2826}{12.4} = 228$  miles.

The dependance of the ideal winding upon the impressed voltage and number of relays used in the circuit, for otherwise identical conditions assumed in the foregoing illustration, is shown in the table on the following page.

The same method may be used in determining the most suitable windings for main-line sounders.

In practice there are various standard relay and sounder resistances, and for a given set of conditions, that type of instrument winding is selected which will approach closely to the ideal winding. Usual resistances of receiving instruments are 20, 50, 75, 100, 150, 250 and 300 ohms. Main-

line relays of 37.5 ohms resistance are also used on many commercial and railway telegraph lines.

Number of relays	40 Volts				80 Volts			
	Calculated wire diameter, in mils	Nearest B. & S. gage number	Relay resistance in ohms	Maximum line resistance exclusive of relays	Calculated wire diameter in mils	Nearest B. & S. gage number	Relay resistance in ohms	Maximum line resistance exclusive of relays
2	6.91	33	506	1416	5.01	36	1700	4760
6	11.67	29	94	576	8.37	32	334	2036
10	14.94	27	39.5	367	10.70	29	94	1340
15	18.2	25	16.4	258	12.90	28	61	949
20	20.9	24	10.6	198	14.94	27	39.5	734
30	25.5	22	4.36	137	18.20	25	16.4	516
	120 Volts				160 Volts			
	Calculated wire diameter, in mils	Nearest B. & S. gage number	Relay resistance in ohms	Maximum line resistance exclusive of relays	Calculated wire diameter in mils	Nearest B. & S. gage number	Relay resistance in ohms	Maximum line resistance exclusive of relays
6	6.91	33	506	4248	6.04	34	762	7028
10	8.80	31	219	2826	7.68	32	334	4740
13	9.99	30	144	2274	8.70	31	219	3841
16	11.02	29	94	1916	9.60	30	144	3224
20	12.28	28	61	1576	10.70	29	94	2680
30	14.94	27	39.5	1101	12.90	28	61	1898

**6. Sources of Current.** — In telegraphy the current for main and local circuits is furnished occasionally by primary batteries (such as Gravity, Fuller, Edison-Lalande, Dry, and Leclanche cells), more frequently by storage or secondary batteries, but is furnished chiefly by dynamo electric machines.

*Primary Batteries.* — Primary cells consist of two dissimilar metals (or one may be carbon) immersed in an electrolyte; and when these are connected externally by means of an electric circuit, the chemical energy of the cell is gradually converted into electrical energy, and a current is maintained in the circuit. By this action one of the metal electrodes, the anode, is slowly consumed. To prevent



the adhesion of liberated gas at the other electrode, or cathode, during current delivery, a depolarizer is employed which combines readily with the gas evolved. In some cells, as in the Fuller and Leclanche types, the cathode and depolarizer are contained in porous cups. When commercial metals containing impurities are used, the anode is also consumed by local action without contributing to the production of current in the circuit. This deleterious process, which goes on whether the cell delivers current or not, is minimized by amalgamation of the anode.

Cells such as the Gravity, Fuller and Edison-Lalande types are suitable for closed-circuit work, while the Dry and Leclanche cells are suitable for intermittent service.

Of primary batteries the Gravity cell is the most extensively used in telegraphy. Fig. 12 shows the Crow-foot gravity cell, the copper being placed in the bottom of the jar and the zinc suspended from the upper edge. Zinc sulphate ( $\text{ZnSO}_4$ ) is the electrolyte and copper sulphate ( $\text{CuSO}_4$ ) is the depolarizer of this cell, which yields a voltage of about 1.0, and has an internal resistance of approximately 2 to 3 ohms.

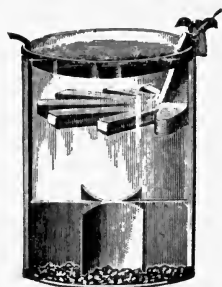

Fig. 12.

When a battery furnishes current to several circuits, its internal resistance causes the current in each circuit to become less as the number of circuits connected in parallel to the same battery increases.

*Storage Batteries.*—Storage or secondary batteries are reversible cells which can be charged from some source of direct current and later discharged. Charging increases the chemical energy of the cell, and this energy reverts to

electrical energy during discharge. The usual form of storage battery consists of a lead peroxide ( $\text{PbO}_2$ ) positive grid and a spongy lead ( $\text{Pb}$ ) negative grid in an electrolyte of dilute sulphuric acid of specific gravity 1.2. During discharge these electrodes are gradually changed to lead sulphate ( $\text{PbSO}_4$ ), a poor conductor of electricity. Recharge converts the electrodes to their initial states. The voltage of the cells when fully charged is 2.5, and the voltage beyond which it is inadvisable to discharge them, because of otherwise excessive sulphating, is 1.8.

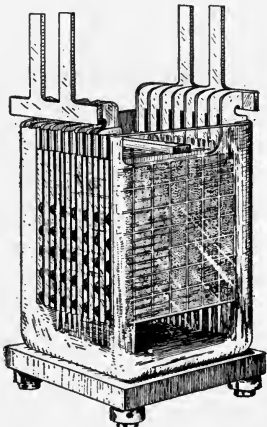

Fig. 13.

The rating of these storage batteries in ampere-hours is based on a uniform 8-hour discharge. A more rapid discharge results in a lowered ampere-hour capacity. The capacity of a cell depends primarily on the size and number of plates and their character, and is generally from 40 to 60 ampere-hours for each square foot exposed surface of positive plate. Fig. 13 shows a 560-ampere-hour storage cell made by the Electric Storage Battery Company.

The Edison storage battery is also suitable for telegraphic purposes. Its positive electrodes consist of grids of nickel-plated steel supporting nickel oxide intermixed with flakes of pure nickel, and the negative electrodes consist of similar grids containing iron oxide. The electrolyte is a 21 per cent solution of caustic potash in distilled water and is contained in a nickel-plated sheet-steel case.

The ampere-hour capacity of these batteries is based on

a 5-hour discharge rate. The voltage of a cell is 1.2 at normal discharge; for charging 1.85 volts are required per cell. Fig. 14 shows the appearance of an 80-ampere-hour

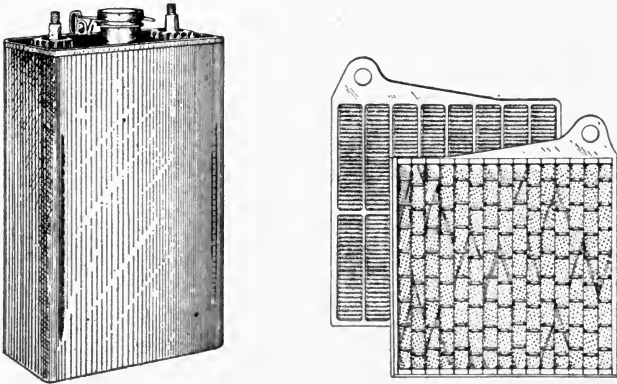

Fig. 14.

Edison storage battery, and also the positive (at the right) and negative plates.

Storage cells may be charged directly from direct-current service mains or through boosters and motor-generators. If only alternating current is available, it may be changed into direct current for the charging of storage batteries by means of electrolytic or mercury-vapor rectifiers, or by means of converters or motor-generators.

*Generators.* — Electric generators are extensively used in large telegraph offices for the operation of long lines and local instruments. They may be driven by steam or gas engines, but more generally by electric motors which receive either direct or alternating current from service mains. For the operation of telegraph circuits of all types different voltages are required from about 25 to 400 volts.

The voltages now considered standard for main-line

operation are 80, 160, 240 and 320 by the Western Union Telegraph Company, and 85, 125, 200 and 385 by the Postal Telegraph-Cable Company, while for local circuit operation they are 26 and 52 with the former and 40 volts

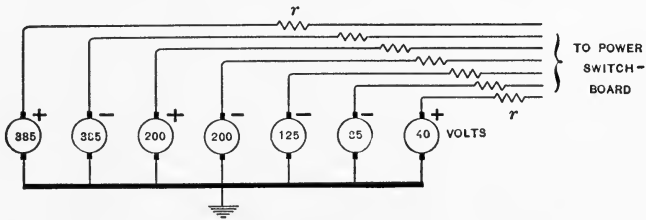

Fig. 15.

with the latter company. The generators for the two higher voltages are generally duplicated so as to permit of reversal of potential, as necessary in duplex and quadruplex service (see Chapters II and III). With printing telegraph systems 110 volts are generally used.

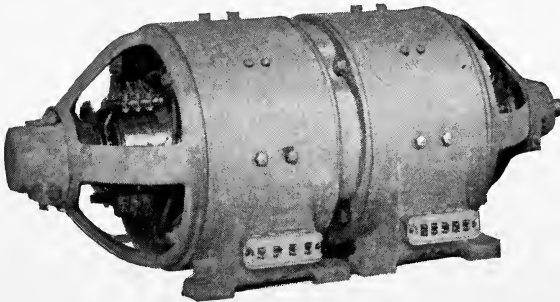

Fig. 16.

The arrangement of generators at a telegraph office is shown in Fig. 15, the voltages indicated being those of the Postal Telegraph-Cable Company. Protective resistances,  $r$ , in series with the generators, are used to prevent injury to the machines in case of line short-circuits, etc. Fig. 16

shows the appearance of General Electric Company motor-generator sets each composed of a direct-current motor and generator. The 220-volt 3-wire direct-current system with neutral wire grounded is sometimes used, where available, for telegraphic purposes. Dynamotors and mercury-vapor rectifiers are also frequently employed.

It is common practice to have a source of electromotive force at both ends of simplex lines instead of a single source of equal total voltage at one end, because of better line operating characteristics during wet weather.

**7. Telegraph Codes.** — Telegraph codes consist of various combinations of dots, dashes and spaces for the representation of letters, numerals and punctuation marks. Two codes are in extensive use, the American Morse, or simply *Morse*, and the Continental Morse, or simply *Continental*. The Morse code is used throughout the United States and Canada for overland signalling except in printing telegraphy. In punctuation, however, the Phillips Punctuation code has generally superseded it because of its greater completeness. The Continental, or so-called universal code, is in use throughout the world for submarine telegraphy and also in almost every country except those mentioned for overland signalling. The codes are given on the two pages following.

In the code characters the length of a dot is taken as the unit of measurement of dashes and spaces. The ordinary dashes are three times as long as dots, the long dashes for letter *l* and cipher in the Morse code are respectively five and seven times as long as a dot, the spaces between the elements of letters are equal to dots, the longer spaces in the letters *C*, *O*, *R*, *Y*, *Z* and *&* of the

## ALPHABET

LETTERS	MORSE	CONTINENTAL
A	— —	— —
B	— — — —	— — — —
C	— — —	— — — — —
D	— — —	— — — —
E	—	—
F	— — — —	— — — — —
G	— — — — —	— — — — —
H	— — — —	— — — — —
I	— —	— —
J	— — — — — —	— — — — — — —
K	— — — — —	— — — — —
L	— — — —	— — — — —
M	— — — —	— — — — —
N	— — —	— — — —
O	— — —	— — — — —
P	— — — — —	— — — — — —
Q	— — — — —	— — — — — — —
R	— — — —	— — — — —
S	— — — —	— — — — —
T	— — — —	— — — — —
U	— — — — —	— — — — —
V	— — — — — —	— — — — — —
W	— — — — — —	— — — — — —
X	— — — — — —	— — — — — — —
Y	— — — — — —	— — — — — — — —
Z	— — — — — —	— — — — — — — —
&	— — — — — —	— — — — — — — —

## NUMERALS

FIGURES	MORSE	CONTINENTAL
1	— — — — —	— — — — — — or — — —
2	— — — — —	— — — — — — or — — — — —
3	— — — — —	— — — — — —
4	— — — — —	— — — — — —
5	— — — — —	— — — — — or — —
6	— — — — —	— — — — — —
7	— — — — —	— — — — — —
8	— — — — —	— — — — — — or — — — — —
9	— — — — —	— — — — — — or — — — — —
0	— — — — —	— — — — — — or — — — — —



Morse code are twice as long as dots, and the spaces between letters and between words are respectively three and six times as long as dots.

The Continental code, having more dashes than the Morse code, requires a little longer time in the transmission of any given message expressed in that code than when expressed in Morse code.

A partial list of abbreviations used in commercial telegraphy follows:

Scotus — Supreme Court of the United States

Bk — Break

Ck — Check

Fm — From

Ga — Go ahead

Min — Wait a minute

Nm — No more

No — Number

x (placed after check) — Get reply to message

x x x . . . — Omission

4 — Where shall I go ahead?

8 — Wait, I am busy

Thus, in case of doubt as to the accuracy of a transmitted message, the receiving operator breaks and sends the letters bk, ga and the last word correctly received; whereupon the sending operator continues from that word. Abbreviations used in differentiating the various classes of telegraphic service are given in § 8 of Chap. V, and of cable service are given in § 10 of Chap. XI.

**8. Telegraph Lines.** — Galvanized iron, hard-drawn copper and occasionally steel wire are used for telegraph lines. The sizes generally employed on overhead lines are



from No. 9 to 14 B. & S. (Brown & Sharpe) gage copper wire and from No. 4 to 12 B. W. G. (Birmingham Wire Gage) iron wire. The increasing use of hard-drawn copper wire for telegraph lines is due to its having a lower resistance than iron for the same tensile strength, and to the fact that it is practically non-corrosive. Telegraph conductors in cables for transmission over relatively short distances are of from No. 14 to 19 B. & S. soft copper.

The weights, diameters and resistances of telegraph line wires are given in the following table:

Hard-drawn copper wire				Galvanized iron wire (E. B. B. quality)			
B. & S. Gage No.	Diameter in mils	Weight in pounds per mile	Resistance at 60° Fahr. per mile in ohms	B. W. G. No.	Diameter in mils	Weight in pounds per mile.	Resistance at 60° Fahr. per mile in ohms.
9	114.4	208	4.22	4	238	787	5.97
10	101.9	166	5.28	5	220	673	6.98
11	90.74	132	6.65	6	203	573	8.20
12	80.81	105	8.36	7	180	450	10.44
13	71.96	83	10.55	8	165	378	12.43
14	64.08	65	13.29	9	148	305	15.41
				10	134	250	18.80
				11	120	200	23.50
				12	109	165	28.48
Soft copper wire							
14	64.08	65	13.12				
15	57.07	52	16.54				
16	50.82	42	20.67				
17	45.26	32	26.55				
18	40.30	25.6	33.60				
19	35.89	20.7	41.47				

Temperature rise increases the resistance of copper 0.24 per cent per degree Fahr. and increases that of iron 0.35 per cent per degree Fahr. reckoned from 0° Fahr.

Copper-clad or bimetallic wire is also used to some extent for telegraph lines. It consists of a steel core to which is welded a coating of copper, forming a wire of high tensile

strength and fairly low resistance. Several grades are available that differ in conductivity, depending upon the relative amounts of copper and steel used.

Bare overhead conductors are supported by glass insulators mounted on wooden, or sometimes concrete and steel telegraph poles. These points of support offer leakage current paths from the conductor to ground. Even in dry weather the insulation resistance between the conductor and ground is not infinite, but of the order of 10 to 100 megohms per mile of line, while in wet and foggy weather the insulation resistance may fall to a fraction of 1 megohm per mile.

In the foregoing pages only perfectly insulated lines were considered. On actual lines, because of the distributed nature of the leakage paths, it is more difficult to determine the exact relation between the various factors involved. A rough approximation on lines of short or medium length to the actual conditions is obtained by considering all the leakage paths to be grouped into one equivalent path at the middle point of the line, as shown in Fig. 17.

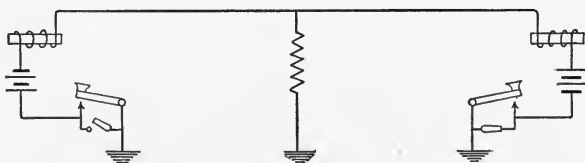

Fig. 17.

It is evident from the figure that even though the circuit is open at one station, current flows from the battery at the other station through the relay, part of the line, and the equivalent leakage path to ground. It follows, therefore, that at no time is the current flow in the receiving in-

struments wholly interrupted; and consequently their retractile springs must be adjusted to release the armatures on a certain minimum current strength. In damp weather when the insulation resistance of the line is lowered the relays must be more delicately adjusted, because the currents flowing in the circuit when one switch and when both switches are closed are more nearly equal.

Thus, on a 600-mile No. 9 B. & S. aerial copper line having a 250-ohm relay and an 80-volt battery at each end, and having an insulation resistance of 10 megohms per mile, the steady current traversing the relay when one key is open is

$$I = \frac{80}{250 + 300 \times 4.22 + \frac{10,000,000}{600}} = 0.0044 \text{ ampere,}$$

and when both keys are closed the current is

$$I = \frac{2 \times 80}{2 \times 250 + 600 \times 4.22} = 0.0528 \text{ ampere.}$$

On the other hand, if the insulation resistance be taken as one-half megohm per mile, the current when one key is open would be

$$I = \frac{80}{250 + 300 \times 4.22 + \frac{500,000}{600}} = 0.034 \text{ ampere,}$$

showing that under these conditions the relay must be adjusted to operate on 0.0528 ampere and release the armature on 0.034 ampere. If so adjusted and if the insulation resistance falls still lower, the line would be rendered inoperative.

With assigned insulation resistance, terminal resistance

and relay adjustment, it is possible, on the basis of the foregoing paragraphs, to determine the maximum permissible length of line for line conductors of any size. Let

- $l$  = maximum length of ground-return line in miles,  
 $R$  = line resistance per mile in ohms,  
 $R_r$  = resistance of each relay in ohms,  
 $N$  = number of relays in circuit (assumed uniformly distributed between terminal stations),  
 $R_i$  = insulation resistance per mile in ohms,  
 $E$  = voltage impressed at each end of line,  
 $I_1$  = current in amperes necessary to actuate relay, and  
 $I_2$  = current in amperes which will just cause release of armature,

then 
$$I_2 = \frac{E}{\frac{NR_r}{2} + \frac{Rl}{2} + \frac{R_i}{l}}, \quad (7)$$

and 
$$I_1 = \frac{2E}{NR_r + Rl}. \quad (8)$$

Eliminating  $E$  from equations (7) and (8), and solving for  $l$ , there results,

$$l^2 + \frac{NR_r}{R}l - \frac{2I_2R_i}{R(I_1 - I_2)} = 0,$$

from which the maximum transmission distance is

$$l = -\frac{NR_r}{2R} + \sqrt{\left(\frac{NR_r}{2R}\right)^2 + \frac{2I_2R_i}{R(I_1 - I_2)}}, \quad (9)$$

an expression not involving the impressed voltage.

As a numerical illustration, consider a No. 9 B. & S. copper conductor having a 250-ohm relay at each end which is adjusted to operate on 0.06 ampere and release

on 0.04 ampere. For an insulation resistance of  $\frac{1}{2}$  megohm per mile, the maximum permissible length of line is

$$l = -\frac{2 \times 250}{2 \times 4.22} + \sqrt{\left(\frac{250}{4.22}\right)^2 + \frac{2 \times 0.04 \times 500,000}{4.22(0.06-0.04)}}$$

$$= -59.3 + 691.0 = 631.7 \text{ miles.}$$

The voltage of the battery at each end should be

$$E = \frac{I_1}{2}(NR_r + Rl) = \frac{0.06}{2}(2 \times 250 + 4.22 \times 631.7)$$

$$= 95 \text{ volts,}$$

as obtained by using equation (8).

This approximate solution of the telegraph circuit will be referred to again because it is less involved than the exact solution which is considered in Chap. X. Experience has proven that the maximum distance of transmission on long aerial lines is limited principally by line leakage.

**9. Speed of Signalling.** — The speed with which signals may be transmitted over a telegraph line depends upon three factors, namely the speed of the sending operator, the nature of the line, and the responsiveness of the receiving instrument.

An experienced operator can send from 30 to 40 five-letter words per minute by hand transmission. Semi-automatic devices may be availed of to raise this sending speed. Much higher speeds are attainable by automatic transmitters, as described later (§ 1, Chap. IV).

It was pointed out in the last section that the current through the receiving device connected to a leaky line does not cease altogether upon opening one key. It is

evident that the greater the line insulation resistance the more rapid will be the current change in the relay coils with movements of the key, and consequently the quicker the actuation and release of the relay armature. On a long line with considerable leakage, rapid signalling may cause the duration of contact for dots to be so short as to prevent the current in the relay from attaining a value sufficient to attract its armature. More deliberate or "heavy" sending must then be resorted to, implying slower signalling speed. Thus, the shorter the line the higher may be the speed of signalling.

Further, the line itself, especially if a cable, limits the speed of transmission. As most large telegraph offices are in the business centers of cities, short sections of nearly all long aerial lines are placed in cables under ground and therefore the speed of signalling on these lines is limited by the cable sections. In cables a conductor is very near its return conductor or the grounded sheath, and consequently its electrostatic capacity is high. It will be shown in § 4 of Chap. XI, that the signalling speed over cables (having negligible inductance and leakance) is inversely proportional to the product of total line capacity and total line resistance. That is, if  $C$  be the capacity in farads per mile of conductor, and  $R$  be the resistance in ohms per mile, then

$$\text{Signalling speed} \propto \frac{1}{(Cl)(Rl)} \propto \frac{1}{CRl^2}, \quad (10)$$

where  $l$  is the length of the cable in miles. This proportionality shows that for a given size of cable the signalling speed varies inversely with the square of its length.

It is safe to say that the speed possibilities on long

fairly well insulated aerial lines even with short cable sections is greater than the operating speed of the receiving instruments. In § 4 it was stated that the time of current growth in a relay depends upon the ratio of its inductance to its resistance. Rather than increase the relay resistance to obtain rapid response, it is more advisable to reduce its inductance. This may be done by decreasing the number of turns, by connecting the two coils in parallel instead of in series, by increasing the reluctance of the magnetic circuit either by removing the iron yoke or by lengthening the air gap between armature and magnet cores, and by using a shunting condenser. Some of these suggestions, however, conflict with the conditions for maximum magnetization with a given current.

The necessary mass of the relay armature should be apportioned in such a way as to possess the least moment of inertia about the pivots so as to acquire a high velocity under the action of a given force. The greater part of its mass should therefore be near the axis. The contact points, however, are preferably placed far from the pivots in order to reduce the angular motion of the armature and permit signals to follow each other in rapid succession. By embodying the features mentioned relays have been constructed which respond to signals sent at speeds as high as 400 words per minute.

**10. Simplex Repeaters.** — It was shown in § 8 that leakage is the important factor in limiting the distance of telegraphic signalling. Using a No. 9 B. & S. copper conductor with two 250-ohm relays with given adjustment (which implies a given signalling speed) it was found that the maximum permissible length of line is 631.7 miles

when the insulation resistance is assumed as  $\frac{1}{2}$  megohm per mile. If a No. 6 wire, which has double the cross-section ( $R = 2.09$ ), were used instead, the maximum length of line under otherwise identical conditions would be 865.9 miles. Thus, using a conductor of twice the size and costing twice as much would only increase the distance of transmission 37 per cent. It is apparent from this illustration that the cost of transcontinental telegraphy over a single continuous circuit would be prohibitive.

If such long lines are subdivided into several shorter sections, say from 300 to 600 miles in length, each section terminating in a relay, signals may be automatically trans-

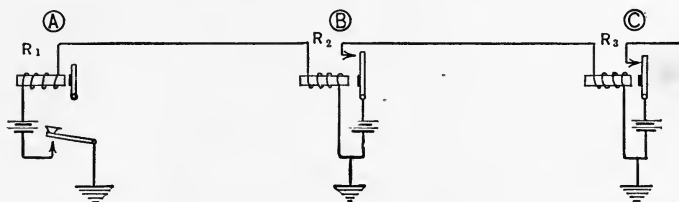

Fig. 18.

mitted thereby into the next section, and so on to the terminus of the line, without requiring unduly large line conductors. The speed of signalling will then be that of the section which allows the slowest transmission less the speed loss in the relays. Two-line sections of such an arrangement are shown in Fig. 18, from which is seen the possibility of transmitting toward the right, but also the futility of endeavoring to transmit in the opposite direction. In order to permit of signalling in either direction, the intermediate relays  $R_2, R_3 \dots$  are replaced by *repeater sets*.

A repeater set consists of two relays and two transmit-



ters which are electrically and mechanically arranged to allow signalling in either direction and in such a way as to automatically prevent one transmitter breaking at the repeater station the line circuit which it controls when that circuit is repeating into the other. Two standard closed-circuit repeaters which accomplish these results will now be described.

*Weiny-Phillips Repeater.* — The connections of a Weiny-Phillips repeater set are shown in Fig. 19, in which  $T$  and  $T'$

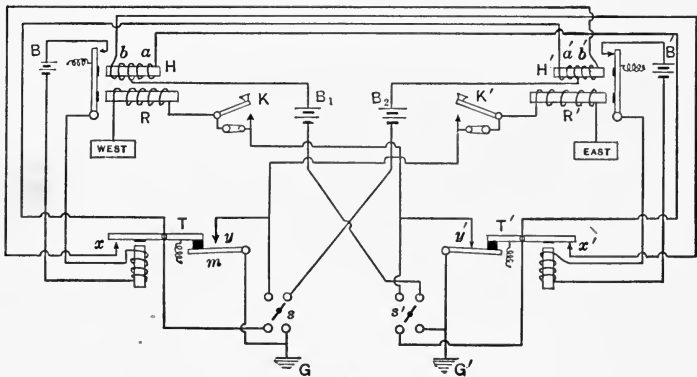

Fig. 19.

are the transmitters, and  $R$  and  $R'$  are the relays. Each relay has an extra magnet,  $H$  or  $H'$ , called a holding-coil, mounted above the ordinary magnets so as to act on the same moving element, as illustrated in Fig. 20. Its winding has a tap at its middle point, so that if current enters at this point, it will traverse the two parts of the winding,  $a$  and  $b$ , in opposite directions, and consequently produce no magnetization in the core. The transmitter  $T$  has a small auxiliary lever  $m$ , insulated from and controlled by the main lever, each lever making contact with a platinum

contact point when the magnets of the transmitter are energized. The switches  $s$  and  $s'$  on the transmitters

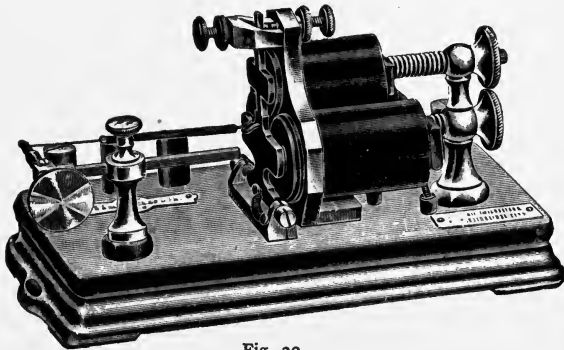

Fig. 20.

enable an operator to sever the two circuits, leaving each complete in itself for simplex operation. Fig. 21 shows the Weiny-Phillips transmitter.

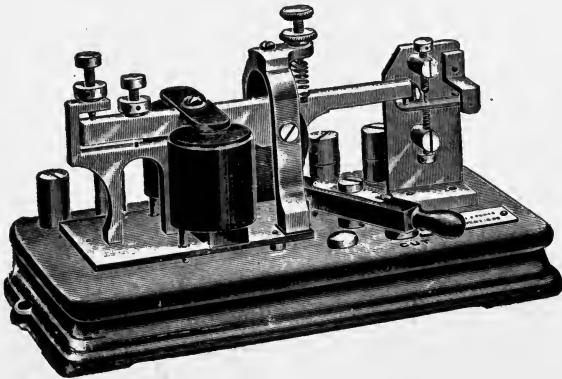

Fig. 21.

Normally, when both the eastern and western circuits are closed at the distant stations, current flows through all magnet windings of the repeater set. Thus, normally,

current flows from the western station through the main-line coils of relay  $R$ , circuit-closing switch of the key  $K$ , and contact  $y'$  (which is closed) of the transmitter  $T'$ , to ground at  $G'$ . Similarly, current flows from the eastern station through  $R'$ ,  $K'$ , and  $y$  to  $G$ . Both relay armatures are therefore attracted and keep the transmitter coils energized through the batteries  $B$  and  $B'$ . The contacts  $x$ ,  $y$  and  $x'$ ,  $y'$  are thus normally closed and currents from the batteries  $B_1$  and  $B_2$  flow through both windings of the holding coils. Generators are very frequently used instead of batteries.

When the western operator opens the circuit preparatory to signalling, the main-line coils of relay  $R$  are deprived of current and the armature is released, inasmuch as the holding coil  $H$  exerts no attraction due to the neutralization of magnetizing forces developed in the two windings. This results in opening the circuit of the magnet of transmitter  $T$  and the release of its armature. The positions of the moving elements of the instruments at this instant are as shown in Fig. 19. The circuit of the winding  $b'$  of the holding coil  $H'$  is broken at  $x$  and consequently the uninterrupted current flowing through its associate winding  $a'$  holds the tongue of relay  $R'$  against its contact stud irrespective of current condition in the main-line coils. This in turn maintains current flow through the winding of transmitter  $T'$  and prevents the opening of the western circuit at  $y'$ , and the opening at  $x'$  of coil  $b$  of the holding coil  $H$ , which is therefore not magnetized. In this way the continuity of the western circuit is preserved at the repeater while repeating eastward. A moment after breaking the circuit at  $x$ , the eastern circuit is broken at  $y$  and the distant relay releases its armature.

When the western operator depresses his key, relay  $R$  will be actuated, and then the transmitter  $T$  closes the eastern circuit at  $y$ , which is followed by the closing of coil  $b'$  at  $x$ . The distant eastern relay is thus energized. Signalling in the reverse direction is accomplished in the same manner.

*Atkinson Repeater.* The Atkinson repeater set consists of two ordinary relays  $R$  and  $R'$ , two transmitters  $T$  and  $T'$  similar in design to the Weiny-Phillips transmitters, and two repeating sounders  $S$  and  $S'$  which combine the functions of relay and sounder, the connections of the set being shown in Fig. 22. The contacts of the repeating sounders are shunted across the corresponding relay contacts.

Normally, when no messages are being transmitted, the windings of all the repeater instruments carry current. Thus, the western line current traverses the contact  $x$  (which is closed) of the transmitter  $T$  and the winding of relay  $R'$  to ground. Similarly, the eastern line current traverses  $x'$  and  $R$  to ground. Both relay armatures are therefore in contact with their front connecting studs and keep the transmitter magnets energized by means of the batteries  $B$  and  $B'$ . The contacts  $y$  and  $y'$  are thus normally closed and currents from the batteries  $b$  and  $b'$  actuate the repeating sounders  $S$  and  $S'$  respectively.

When the western operator opens the key prior to signalling, relay  $R'$  loses its magnetism and its armature falls back, thereby opening the circuit of the magnet of transmitter  $T'$ , inasmuch as sounder  $S'$  remains energized and does not short-circuit the relay contacts. The lever of this transmitter first opens a circuit at  $y'$  and immediately

afterward opens a circuit at  $x'$ . The conditions are then as shown in Fig. 22. The opening of the circuit at  $y'$  causes the demagnetization of sounder  $S$  and the release of its armature. The magnet of transmitter  $T$  will thereby be kept energized regardless of the armature position of relay  $R$ . In this way the continuity of the western circuit is preserved at  $x$ . The circuit opened at  $x'$  is the eastern line circuit. Thus, the relay at the eastern station

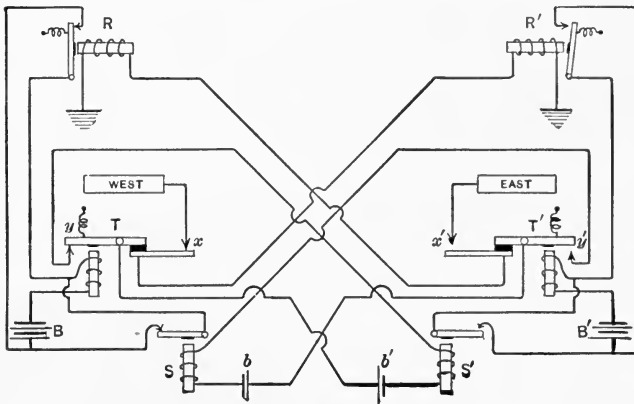

Fig. 22.

releases its armature as the distant western operator opens the circuit.

As this operator then depresses his key, relay  $R'$  is energized and its armature closes the transmitter circuit at  $T'$ , the result of which being the closing of the eastern circuit at  $x'$ , followed by the closing of the circuit of repeating sounder  $S$ . The actuation of the sounder, however, does not open the circuit of the transmitter magnet  $T$ , because the relay  $R$ , energized by the eastern line battery (not shown) at the closing of contacts  $x'$ , keeps its circuit closed.

Signalling in the reverse direction can be traced through the repeater in the same manner.

*Other Repeaters.* — Many other closed-circuit simplex repeaters are in use, among which may be mentioned the Milliken, Ghegan, Horton, Neilson and Toye repeaters.\* † They all differ in the methods employed to prevent one transmitter breaking the circuit, that is repeating into the other circuit. Repeaters may also be arranged for repeating into two or more circuits; the Maver multiple repeater\* is one of this type.

For the satisfactory operation of repeaters, attendants, each in charge of a certain number of sets, are required to supervise the working of the repeaters and make such adjustments as are necessary to maintain uninterrupted service despite changes in weather conditions and irregularities in sending. With several types of self-adjusting repeaters, such as the Catlin and D'Humy repeaters,† this supervision may be dispensed with.

There are various types of open-circuit repeaters, the simplest of which, employing only two double-contact re-

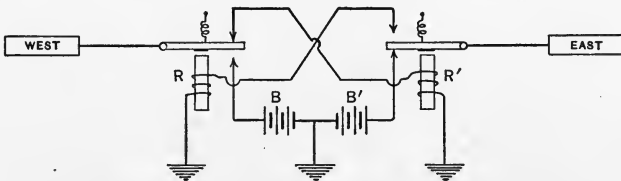

Fig. 23.

lays, is represented in Fig. 23. When no messages are being transmitted, no current flows through the line wires and repeater relays, and consequently both relay arma-

\* For description see Maver's "American Telegraphy."

† Described in McNicol's "American Telegraph Practice."

tures rest against their upper contact studs. When the western operator depresses his key, relay  $R'$  attracts its armature, and current, supplied by battery  $B'$ , flows over the eastern line. At the same time the magnet circuit of relay  $R$  is broken at the upper contact point so that the continuity of the western circuit remains uninterrupted.

### PROBLEMS.

1. How far would it be possible to telegraph over a perfectly insulated ground-return line having 8.36 ohms resistance per mile of length with an impressed voltage of 120, if the current necessary to actuate the two 75-ohm relays is 0.07 ampere?

2. How many gravity cells, each having a voltage of 1.0 and an internal resistance of 2.5 ohms, would be required to transmit signals over an 80-mile telegraph line which has a resistance of 5.28 ohms per mile and is equipped with two 150-ohm relays requiring a current of 0.04 ampere?

3. Three relays are adjusted to operate on 250 ampere-turns, and have the following constants:

Relay No. 1	20 ohms resistance.....	2400 turns,
Relay No. 2	75 ohms resistance.....	4500 turns,
Relay No. 3	150 ohms resistance.....	7500 turns.

If these relays were connected in series across 20-volt mains, which relays would operate? What voltage would cause all three to operate?

4. What is the best winding for four main-line sounders operating on 400 ampere-turns when used on a telegraph line which requires 40 volts? The sounders are of identical construction and have a winding cross-section of 0.9 square inch and a mean length of turn of 2.2 inches; double-cotton-insulated wire to be used, the insulating covering being four mils thick.

5. Over how long a line, having 13.3 ohms resistance per mile, could the four sounders of the preceding problem operate when the impressed voltage is 40 volts?

6. Four separate telegraph lines, each having a total resistance of 1000 ohms including receiving instruments, are supplied with current by one battery of 100 gravity cells, which has an internal re-

sistance of 220 ohms. Determine the current strength in a circuit when only one circuit is closed and also when all four circuits are closed.

7. Decipher the following message:



8. What would be the costs per mile of two telegraph lines of standard sizes having approximately 10.5 ohms resistance per mile, one constructed of galvanized iron and the other of hard-drawn copper wire? The costs of iron and copper may be taken as  $4\frac{1}{2}$  and 16 cents per pound respectively.

9. A 400-mile No. 6 B. W. G. aerial iron line, having a 250-ohm relay and a 120-volt generator at each end, shows an insulation resistance of 1 megohm per mile in wet weather. What currents flow through one relay when the key at the other station is open and when closed?

10. Calculate the maximum permissible length of a No. 10 B. & S. copper telegraph line having six 250-ohm relays which are adjusted to operate on 0.05 ampere and release on 0.025 ampere, if the insulation resistance of the line be taken as  $\frac{1}{2}$  megohm per mile. Compute the proper voltage to be impressed at each end.

11. If the speed of telegraphic signalling over a 100-mile cable of No. 16 B. & S. copper, having a capacity of 0.12 microfarad per mile, is 200 five-letter code words per minute, what would be the possible signalling speed over a 60-mile cable of No. 19 B. & S. wire having a capacity of 0.11 microfarad per mile?



## CHAPTER II

### DUPLEX TELEGRAPHY

1. **Duplex Telegraph Systems.** — By duplex signalling is meant the simultaneous transmission of signals in opposite directions without interference over a single line. Four operators are required for each duplex circuit, one sending and one receiving operator at each station. The message capacity of a duplexed line is therefore twice that of the same line when operated simplex. When telegraphic traffic over a given line exceeds that which can be handled satisfactorily by simplex signalling, it is advisable to install the necessary apparatus at the terminal stations for duplex signalling, thereby avoiding the expense of erecting another line. Duplex telegraphy was first performed in 1853 by Dr. Wm. Gintl; its practical operation began about 1868.

Duplex circuits do not permit of the intromission of intermediate stations, but repeating stations may be inserted on long duplex lines. In telegraph systems intended for duplex signalling, the receiving instruments at both stations must be in circuit at all times ready to respond to signals sent from the distant station, and yet so designed that the receiving instrument at each station will not respond to signals sent by that station. These conditions are met in various ways in the different duplex systems.

There are three systems of duplex telegraphy: the *differential duplex*, the *polar duplex* and the *bridge duplex*

systems.\* The first system, although now infrequently used for duplex signalling, is an essential part of the quadruplex telegraph system to be described in the next chapter, and consequently will be here discussed. Where it is advisable to employ a battery at one end of the line only, a combination of the differential and polar duplex systems may be used for duplex operation over short distances.

**2. The Differential Duplex.** — The differential duplex, also known as the *single-current duplex* and as the *Stearns duplex*, utilizes a differential relay as the receiving instrument. This is a relay with two windings, identical as to number of turns and resistance, through which currents

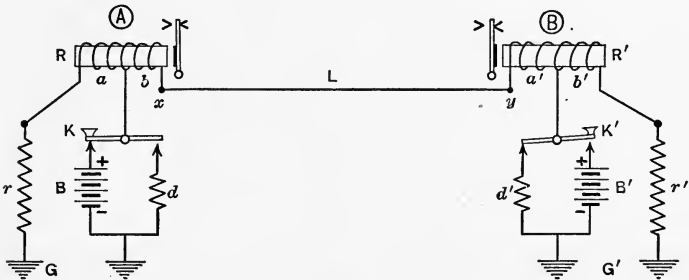

Fig. 1.

may flow in the same or in opposite directions around its iron cores. The corresponding turns of the windings are preferably wound side by side so as to avoid the formation of consequent magnetic poles. For clearness in diagrams, however, these windings will be shown as being adjacent.

The scheme of connections of the differential duplex is represented in Fig. 1, which shows a line *L* extending between the two stations *A* and *B*, having a ground return

\* Early duplex schemes are described in Prescott's "Electricity and the Electric Telegraph."

path. The relays  $R$  and  $R'$  have two windings each ( $a, b$  and  $a', b'$ ), the common terminal being joined to the levers of keys  $K$  and  $K'$  respectively. The similar batteries  $B$  and  $B'$  are connected with like poles to the front contacts of the keys, while resistance coils  $d$  and  $d'$ , having a resistance equal to the internal battery resistance, are connected to the rear key contacts. In this way the resistance of the circuit is unaltered whether the keys are on the front or the rear contacts. The resistance coil  $r$  is adjusted to have a resistance equal to that of the line  $xy$  plus the resistance from the point  $y$  to ground at  $G'$  and the ground resistance  $G'$  to  $G$ , and similarly the coil  $r'$  to have a resistance equal to that of the line plus that from the point  $x$  to ground at  $G$  and back to  $G'$  (the ground resistance being usually neglected). With this adjustment, if a current enter either relay at the junction of its two coils, it would divide equally between the two paths to ground presented to it, each path including one of the relay coils. The equal components of this current in the two coils circulate around the core in opposite directions and consequently the magnetomotive force developed by one is neutralized by that developed by the other, thereby exerting no attractive force on the relay armature.

The resistances of the coils  $r$  and  $r'$  are experimentally adjusted in practice so that the home relay is not affected by movements of the keys. The resistances may, however, be determined as follows: The resistances of the two batteries will be assumed equal and of value  $R_b$  ohms each, the resistances of the two relays likewise of  $R_r$  ohms each; then from the symmetry of the circuit the two coils  $r$  and  $r'$  will also have equal resistance, say  $r$  ohms. The line will be assumed perfectly insulated from ground and

of resistance  $Rl$  ohms. For exact neutralization of magnetizing forces in the two relays, the resistance of the one path,

$$\frac{R_r}{2} + r + R_b \quad (1)$$

must equal that of the other path, which is

$$R_b + \frac{R_r}{2} + Rl + \frac{R_r}{2} + \frac{1}{\frac{1}{R_b} + \frac{1}{\frac{R_r}{2} + r}} \quad (2)$$

Whence  $\left(r - \frac{R_r}{2} - Rl\right)\left(R_b + \frac{R_r}{2} + r\right) = R_b\left(\frac{R_r}{2} + r\right)$ ,

and  $r^2 - Rlr - \left(R_r R_b + R_b Rl + \frac{R_r^2}{4} + \frac{R_r Rl}{2}\right) = 0$ .

Therefore the resistance of each coil is

$$r = \frac{Rl}{2} + \frac{1}{2} \sqrt{(Rl + R_r)(Rl + R_r + 4R_b)} \quad (3)$$

Thus, if 200-ohm relays are connected to the ends of a 2000-ohm line and if a 200-volt gravity battery having 250 ohms internal resistance be employed at each end, then the resistance coils  $r$  and  $r'$  would each have a resistance of

$$\begin{aligned} r &= \frac{2000}{2} + \frac{1}{2} \sqrt{(2000 + 200)(2000 + 200 + 4 \times 250)} \\ &= 2327 \text{ ohms.} \end{aligned}$$

These values are indicated in Fig. 2, and it may be verified that the resistances of the four paths:  $m, n, p, m - G, p, m, q, G' - G', t, q, m, G - q, s, t, q$ , are all equal and have a resistance of 2677 ohms.

An inspection of Fig. 1 will reveal the principle of operation of this system. If neither key be depressed, no circuit containing an E.M.F. is closed and therefore no relay is actuated. The depression of only one key at either station will fail to actuate the relay at that station because of equal and oppositely directed currents in the halves of

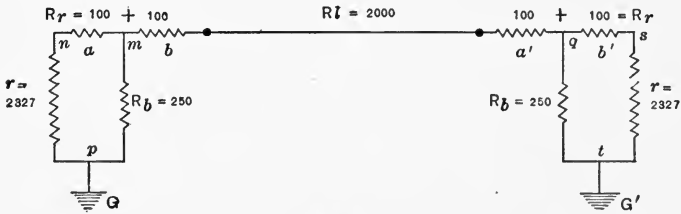

Fig. 2.

its relay coils, but will actuate the relay at the remote station because of the additive action of these currents. The depression of both keys connects both batteries in opposition and, since no current then flows in the line wire nor in the line coils  $b$ ,  $a'$ , of the relays, both relays are actuated by the currents flowing in their other coils. Although a key has no control over the home relay, it will be observed that when both keys are depressed each relay is operated by current from the home battery.

Thus in this system a relay is properly actuated whenever the key at the other station is depressed regardless of the position of the other key.

In the numerical illustration, the steady currents in milliamperes traversing the relay coils under the various conditions, are readily seen to be those given in the following table. The figures following the braces give the equivalent currents through one coil and the stars indicate the operation of the relays.

## CURRENTS IN RELAY COILS

Relay	Coil	Neither key depressed	Key K only depressed	Both keys depressed	Key K' only depressed
R	a b	○ } ○	68 } ○ 68 } ○	75 } 75* ○ } 75*	6 } 74* 68 } 74*
R'	a' b'	○ } ○	68 } 74* 6 } 74*	○ } 75* 75 } 75*	68 } ○ 68 } ○

In the manipulation of the two keys as shown, there are constantly recurring intervals during which the key levers are in an intermediate position, touching neither contact stud. This condition is apt to cause confusion of signals, especially on leaky lines. In differential duplex circuits where primary cells are used, this confusion of signals may be avoided by the employment of transmitters so designed that contact is made with one stud an instant before contact is broken with the other. The appearance of such *continuity-preserving transmitters*, operated magnetically by means of a local circuit, is shown in Fig. 3.

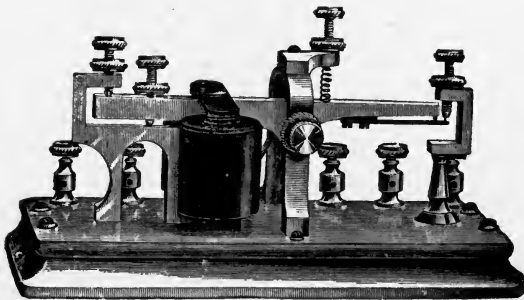

Fig. 3.

The connections of one station of a duplex circuit using this transmitter, are shown in Fig. 4, wherein *T* is the transmitter, and *j* and *k* are the contact studs, the other

letters having the same significance as before. The transmitter has an auxiliary spring lever, insulated from the main lever, which may make contact either with the fixed

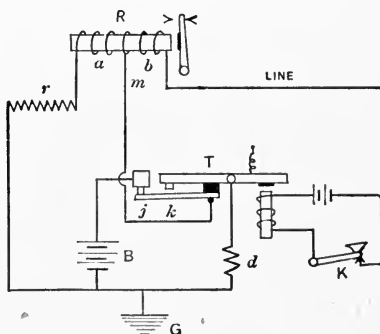

Fig. 4.

stud *j* or with the stud *k* attached to the main lever. When the key is depressed the contact at *j* is made before that at *k* is broken, and when the key is released, the contact at *k* is made before that at *j* is broken. In this way the circuit from *m* to ground is always complete. The momentary short-circuits of the line battery during the excursions of the transmitter lever do not prove injurious to the battery.

3. **Artificial Lines.** — The resistances *r* and *r'* of Fig. 1, each possessing a resistance equal to that of the line plus that of the terminal apparatus at the remote station, are aptly termed *artificial lines*. But, since actual telegraph lines have electrostatic capacity with respect to ground, for more exact imitation the artificial lines should also have capacity. When the artificial line has the same capacity as the line wire, then the currents through them and through the relay coils will rise and fall at the same rate. That this result is essential is evident from the fact

that if the current should rise more quickly to its ultimate value or decay more rapidly to zero in one relay coil than in its companion coil, the armature would give a momentary kick and produce a false signal upon each depression or release of the home key. When the resistance and capacity of the artificial line in a duplex circuit are so adjusted that the depression of a key produces no effect upon the home relay, the circuit is said to be *balanced*.

The arrangement of an artificial line which is used by the Postal Telegraph-Cable Company for duplex telegraphic

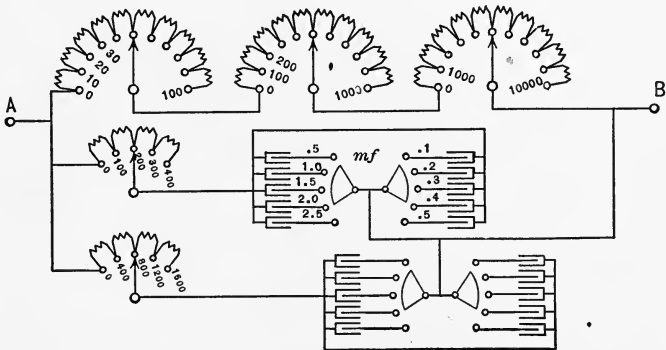

Fig. 5.

signalling is given in Fig. 5. The resistance between the terminals A and B can be varied from 10 to 11,100 ohms, and each of the two condenser sets can be adjusted from 0.1 to 3.0 microfarads. This wide adjustment permits of its use on lines of different lengths, resistances and capacities. Parts of the 400- and 1600-ohm resistances are connected in series with the two condenser sets in order to vary the time of their charge and discharge to approximate the corresponding times for the line.

The design of the Western Union artificial line is shown



in Fig. 6. The resistance between the terminals "Ground" and "Relay" can be varied from 25 up to 11,000 ohms, and each of the two condenser sets can be adjusted from  $\frac{1}{8}$  to  $3\frac{7}{8}$  microfarads. One of the resistances connected in series with the condensers can be varied from 100 to 500

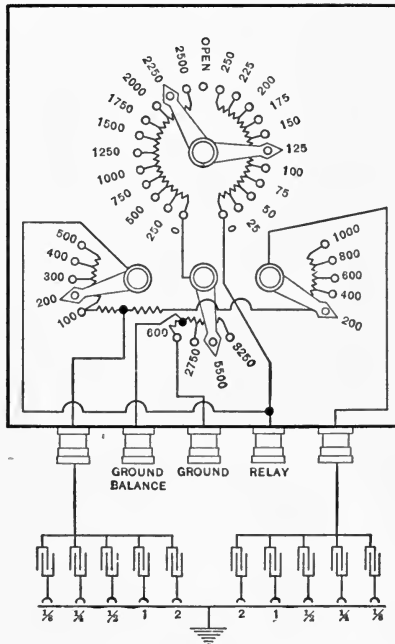

Fig. 6.

ohms while the other adds from 200 to 1000 ohms. When a line becomes leaky in wet weather, the resistance of its artificial lines must be lowered for balance.

**4. Polarized Relays.**—The polar duplex telegraph system depends for its operation upon reversals in the direction of current flow. In this system, the function of the key is not to make and break the circuit as in the

Stearns duplex, but instead to present alternately the positive and negative poles of the battery to the line. Obviously the receiving instrument employed must operate upon current reversals, and such an instrument is called a *polarized relay*.

The principle of the simple polarized relay may be explained with the aid of Fig. 7. A U-shaped permanent magnet magnetized to have two equal South poles as indicated at (a) has pivoted at its mid-point a soft iron armature which projects upward and plays between two pole pieces that are attached to the ends of the magnet, as shown at (b). The North magnetic pole is then shifted to the position shown, and it is evident that the armature

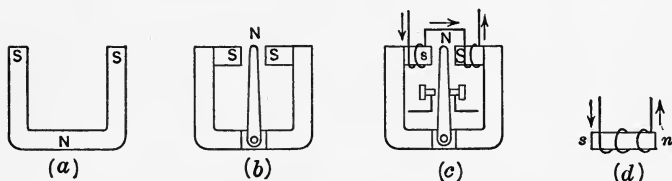

Fig. 7.

will remain against whichever pole piece it is placed, for no retractile spring is used. A winding surrounds each pole piece and the two windings are connected in series. Remembering that a current traversing a winding around an iron core will cause the formation of magnetic poles as shown at (d), it will be evident that if a current traverses the windings as indicated by the arrows at (c) the magnetization due to the permanent magnet in the left-hand pole piece will be partially neutralized while that in the other pole piece will be strengthened. Consequently the armature will be drawn over toward the stronger right-hand pole piece, and make contact with the right contact

screw. If the direction of current flow be reversed, the left-hand pole piece will be the stronger and therefore the armature will make contact with the left-hand contact stud. Thus, every time the direction of current changes, the armature will move from one contact screw to the other.

The windings of the polarized relay may also be wound differentially in the same way as with the ordinary or *neutral* differential relays, already described.

Each coil contains an equal number of turns belonging to the two windings. To avoid complicated diagrams, differentially-wound relays will be represented as in Fig. 8, with a tap *m* at the middle point of the winding.

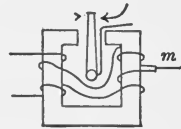

Fig. 8.

When current is sent through the coils differentially in either direction the armature will not move from the position previously assumed.

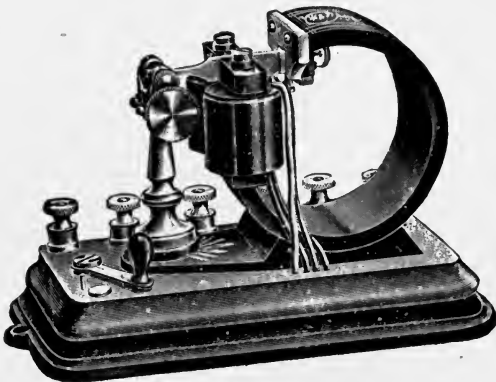

Fig. 9.

Fig. 9 shows one form of differentially-wound polarized relay. The armature is pivoted in a brass casing just

below the upper end of the semicircular-shaped permanent magnet and extends between the adjustable pole pieces of the electromagnet coils that are mounted on the other end of the permanent magnet. The post supporting the contact points is shown at the left.

In practice polarized relays usually have resistances of from 50 to 500 ohms, and will operate satisfactorily on currents of from 5 to 200 milliamperes. When traversed by currents of from 10 to 15 milliamperes, the inductances of such relays are from 1.5 to 6 henrys when the air gap between armature and pole faces is about 0.02 inch.

**5. The Polar Duplex.**—The connections of the apparatus used on a polar duplex line for primary battery operation are shown in Fig. 10. The pole-changing trans-

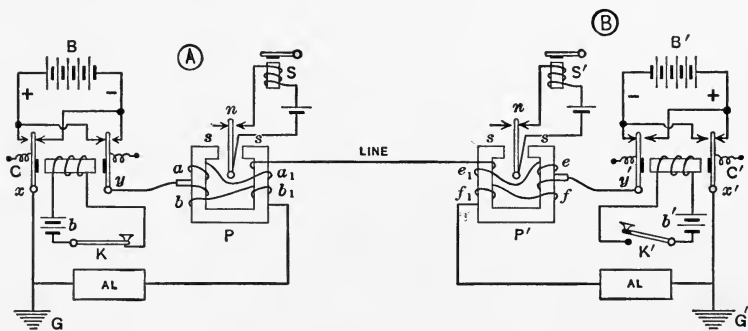

Fig. 10.

mitters, represented by  $C$  and  $C'$ , consist of double armature relays, each armature playing between two contact studs. When the key  $K$  is not depressed, retractile springs hold the armatures  $x$  and  $y$  respectively in contact with the positive and negative terminals of the battery  $B$ , but when the key is depressed the armatures are attracted

and  $x$  and  $y$  are respectively in contact with the negative and positive poles of the battery. In other words, depression of the key reverses the polarity of the home battery with respect to the circuit.

The differentially-wound polarized relays are shown at  $P$  and  $P'$  and control the operation of the local sounders  $S$  and  $S'$  respectively. The letters  $s$  and  $n$  on the relay poles represent the South and North poles due to the permanent magnets alone. The properly-balanced artificial lines are shown at  $AL$ . The proper resistance of the artificial line may be calculated similarly to the method given in § 2.

When both keys are open, it is seen that the negative terminals of both main batteries are connected to the mid-points of the relay windings, and that therefore no current traverses the line coils  $a, a_1$  and  $e, e_1$  of the relays. Currents, however, will flow in the artificial line coils  $b, b_1$  and  $f, f_1$ , and these are in such direction as to strengthen the left-hand poles of the polarized relays and weaken their right-hand poles, and consequently both armatures will be drawn to the left and away from the sounder contacts. Hence both sounders are idle when both keys are open.

If only key  $K$  be depressed, the positive pole of battery  $B$  is connected to the line and the conditions are exactly as represented in the figure. About twice as much current flows through the line coils of the relays as through the artificial line coils, so that the operation of the relays depends upon the direction of current in the line coils. The current in the coils  $a$  and  $a_1$  strengthens the left-hand pole and weakens the right-hand pole of relay  $P$ , and consequently the armature stays away from its sounder contact. At the other station the current in the line coils

$e$  and  $e_1$  strengthens the right-hand pole and weakens the left-hand pole of relay  $P'$ , and therefore the armature closes the local circuit and the sounder  $S'$  responds. In like manner the depression of key  $K'$  only will operate the sounder  $S$ . Thus, the manipulation of one key controls the operation of the distant sounder, but does not control the home sounder.

When both keys are simultaneously closed, no current again flows over the line, because the positive poles of both batteries are in contact with the line. The currents in the artificial line coils are now in such a direction as to weaken the left-hand poles and strengthen the right-hand poles of both relays. Both armatures are then held against the local circuit contacts and both sounders operate. In this way signalling can be carried on in opposite directions over a single wire. If relays are used that have their armatures magnetized South, reversal of the batteries will cause the system to operate in the same way.

Continuity-preserving pole-changers may be used with polar duplex systems if current is supplied by primary batteries, but their use is not so important as the use of continuity-preserving transmitters with differential duplex systems. For, assume key  $K$  to be depressed while key  $K'$  is open, and consider the instant when the armatures of the pole-changer  $C$  are midway between their contacts. The battery  $B$  is then completely cut off from the circuit and the line circuit is completed to ground at  $G$  only through all coils of the relay  $P$  and the artificial line. The line current from battery  $B'$  flowing through these coils of the home relay strengthens the left-hand pole and weakens the right so that sounder  $S$  does not operate. At the other station more current traverses the coils  $f, f_1$  than the coils

$e$ ,  $e_1$  and consequently the left-hand pole of relay  $P'$  is strengthened and the other is weakened, so that sounder  $S'$  is not operated until the armatures of the distant pole-changer touch their front contacts. Conversely, sounder  $S'$  will release its armature at the instant when armatures  $x$  and  $y$  leave their front contacts. Again, assume that key  $K$  is held down, as in Fig. 10, which means that the relay armatures of  $P$  and  $P'$  are respectively on their left and right contact studs, and that sounder  $S'$  is actuated. If now key  $K'$  is also depressed the pole-changer  $C'$  operates, and its armatures will be drawn toward their front stops. Consider the instant when these armatures are in their intermediate positions, touching neither contacts. The battery  $B'$  is then completely isolated, and the only path for the line current at station  $B$  is through all four coils of relay  $P'$  and through the artificial line to ground at  $G'$ . The current supplied by battery  $B$  enters the relay  $P$  at junction  $y$  and divides between the line and artificial line coils. The current through the coils of relay  $P'$  keeps the right-hand pole magnetized stronger than the left so that sounder  $S'$  will remain actuated. At the other station more current flows through the coils  $b$  and  $b_1$  than through the others, and is in such direction as to magnetize the right-hand pole stronger than the left and consequently the sounder  $S$  will operate as soon as the armatures  $x'$  and  $y'$  leave their rear contacts. Conversely, sounder  $S$  will remain actuated until these armatures again touch their rear contacts. Thus false signals can hardly ensue with the polar duplex if properly balanced.

A polar duplex circuit is balanced in practice by first adjusting the polarized relays, with all current cut off, so that the armatures will move with equal force from their

intermediate positions to either stop and remain there. Then connect the relays in circuit. At one station alternately depress and release the key while varying the resistance of the artificial line until such manipulation of the key does not alter the behavior of the home relay. The capacity of the artificial line is adjusted by first moving back that magnet pole piece which is on the side away from the local circuit contact, and then, starting with all the condensers in circuit, gradually diminish the capacity and alter the resistances in series with the condensers, while depressing and releasing the key at intervals, until the relay armature will not kick with every movement of the key. This adjustment signifies that the current grows and decays simultaneously in both relay windings. Then restore the pole piece to its proper position, and the balance is complete. The other station is adjusted similarly.

A single-armature pole-changer, such as illustrated in Fig. 11, is extensively used with duplex telegraph circuits

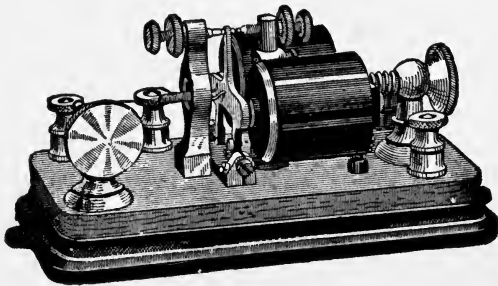

Fig. 11.

when operated by generators. The armature moves between two contacts, one being connected to the positive terminal of one generator and the other contact to the negative terminal of another similar generator, the two



other generator terminals being grounded as shown in Fig. 12. Another generator supplies current to the local pole-changer circuit. The same generators may furnish

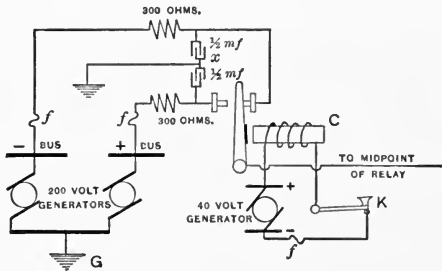

Fig. 12.

current to other duplex circuits, by connecting these circuits, each with protective fuses,  $f, f, f$ , to the positive and negative bus-bars.

This figure shows the transmitting arrangement used by the Postal Telegraph-Cable Company. At the instant of transferring contact from one stud to the other a spark is produced and drawn across the air gap, thereby bridging the two 200-volt generators through the 300-ohm protective resistances. These resistances (usually in lamp form) protect the machines in cases of accidental short-circuit. This spark is effectively quenched by the provision of a discharge path to ground through a  $\frac{1}{2}$ -microfarad condenser, for each machine, as shown. Three-hundred ohm or 600-ohm protective resistances are usually connected in series with the generators.

In order to find the current strength in the various portions of a polar duplex circuit let  $R_p, R_b, R_l$  and  $r$  be respectively the resistances of the polarized relays, battery or protective resistance in series with generator, perfectly in-

sulated line, and artificial line, let  $I$ ,  $I_1$  and  $I_2$  be respectively the current supplied by each battery or generator, current in artificial line and current in line wire, and let  $E$  be the voltage of each battery or generator. Then, when both keys are open or both closed

$$I = I_1 = \frac{E}{\frac{R_p}{2} + R_b + r} \text{ and } I_2 = 0; \quad (4)$$

when one key is closed

$$I_1 = \frac{E - R_b I}{\frac{R_p}{2} + r}, \quad I_2 = \frac{2(E - R_b I)}{R_p + Rl} \text{ and } I = I_1 + I_2, \quad (5)$$

whence 
$$I = \frac{E(2R_p + Rl + 2r)}{R_b(R_p + Rl) + \left(\frac{R_p}{2} + r\right)(R_p + Rl + 2R_b)}. \quad (6)$$

In order to have  $I_2$  twice as great as  $I_1$ , the artificial lines should have a resistance of  $r = \frac{R_p}{2} + Rl$ .

Where only generators of higher voltage are in service, as necessary for the operation of long quadruplex telegraph circuits (see next chapter), the potential may be reduced to values sufficient for duplex operation by the introduction of a leakage path to ground. The connections of one station of such a *leak duplex* circuit, as used by the Postal Telegraph-Cable Company, are shown in Fig. 13. Fourteen-hundred-ohm resistances are in series with the generators, and 2200-ohm shunt or leak paths are provided to ground. The difference of potential between the point  $y$  and ground does not exceed  $\frac{2200}{1400 + 2200} \times 380$  or 233 volts and this occurs when the armature is midway between

the pole-changer contacts. Assuming that each winding of the polarized relay has a resistance of 150 ohms and that

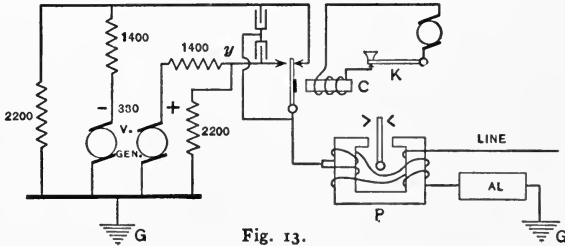

Fig. 13.

the artificial line has a resistance of 1700 ohms, this potential difference would fall to

$$380 - 1400 \frac{380}{1400 + \frac{(1700 + 150) 2200}{2200 + 1700 + 150}} \text{ or } 159 \text{ volts,}$$

when the armature makes contact so that no current flows over the line. In this way the voltages available at the pole-changer contacts are rendered materially less than the terminal voltages of the generators.

**6. Improved Polar Duplex.** — The arrangement of the improved polar duplex circuit due to Davis and Eaves and now employed by the Postal Telegraph Company is shown in Fig. 14. The principle of operation is identical with that already described in connection with Fig. 10, and it will be observed that the transmitting arrangement used is that of Fig. 12. The additional features of this duplex circuit are the resistances  $g, h, j, k, l$  and  $m$  and the condensers  $c, c', c_1$  and  $c_2$ , the functions of which will be explained presently.

It was pointed out in the last section in describing the polar duplex circuit, that with the home key open, (1) the

home sounder is not operated until the distant pole-changer armature touches its front contact and (2) that it will cease to operate at the instant this armature leaves this front contact. Also, that with the home key closed, (3) the home sounder will operate as soon as the distant pole-changer armature leaves its rear contact and (4) will remain actuated until this armature again touches its rear contact. Thus, conditions 2 and 3 permit of faster transmission of signals than the others. The introduction of the non-inductive resistances  $g$ ,  $h$ ,  $j$  and  $k$ , each of 500-ohms resistance and the 12-microfarad condensers  $c$  and  $c'$

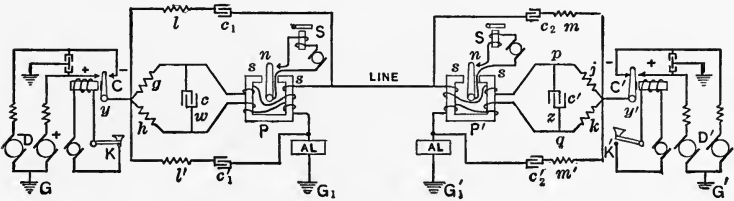

Fig. 14.

is for the purpose of quickening transmission for the slow conditions (1) and (4).

When both keys are open the negative generator terminals touch armatures  $y$  and  $y'$  of the pole-changers and no current traverses the line, line coils of both relays, or resistances  $g$  and  $j$ . Currents, however, flow from the generators to ground, through the artificial lines, lower relay windings and resistances  $h$  and  $k$  back to their respective generators. As a consequence the condensers  $c$  and  $c'$  will be charged respectively to the potential differences existing across the resistances  $h$  and  $k$ , the plates  $w$  and  $z$  being charged positively. If, now, key  $K$  is depressed, the armature  $y$  of pole-changer  $C$  travels from the rear to the front contact. In its intermediate position, the armature

isolates the generators  $D$ . A current now flows from the generator  $D'$  to ground, through the left-hand artificial line, relay  $P$ , resistances  $h$  and  $g$ , line, upper coils of relay  $P'$  and resistance  $j$  back to the generator; and this current is about one-half that which flows from the same generator through the right-hand artificial line, lower coils of relay  $P'$  and resistance  $k$  back to the generator. The charge on condenser  $c$  remains practically unchanged because its potential difference, that across coils  $g$  and  $h$ , is due to a current of approximately half the initial strength though double the initial resistance. This condenser will produce no appreciable discharge.

At the other station, however, the potential difference of condenser  $c'$  is now that across coil  $k$  minus that across coil  $j$ , and is therefore approximately half that possessed before and in the same sense. This condenser will then discharge partially and a current pulse flows from  $q$  through the lower coils of relay  $P'$ , both artificial lines, relay  $P$ , resistances  $g$  and  $h$ , line, upper coils of relay  $P'$  to the other condenser terminal at  $p$ . This current does not affect the relay  $P$ , but it does tend to operate the relay  $P'$  momentarily. This discharge current through all coils of  $P'$  is in the same direction as that which will flow through its upper coils when the pole-changer armature  $y$  reaches the front contact. Thus the condenser discharge begins the operation of the home relay at the instant the distant pole-changer armature leaves the rear contact, and this operation is completed by the generators as this armature reaches its front contact. The improvement for the fourth condition can be traced similarly.

The function of the four 600-ohm non-inductive resistances  $l$ ,  $l'$ ,  $m$  and  $m'$ , with the four 1-microfarad condensers

$c_1$ ,  $c_1'$ ,  $c_2$  and  $c_2'$ , shunted around the relays is to provide an auxiliary path to ground, for inductive disturbances from neighboring telegraph, telephone or high-tension transmission lines, which does not include the relay windings, thereby eliminating such interference with the operation of the duplex circuit. The shunt circuits offer a further advantage in that the first portion of the current pulse for each signal over this home shunt path reaches the other end of the line a little in advance of the current which passes through the home relay windings. This action assists in attaining a high signalling speed.

**7. Short-line Duplex.** — The circuit of the Morris duplex, which system is successfully employed by the Western Union Telegraph Company on many short lines, is shown in Fig. 15. It utilizes a neutral relay at one sta-

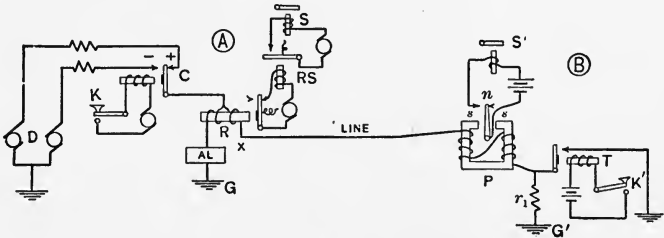

Fig. 15.

tion and a polarized relay at the other, and employs main-line generators at one station only. The artificial line has a resistance equal to the resistance from the point  $x$  to ground at  $G'$ . The resistance of the compensating rheostat  $r_1$  is adjusted so that three times as much current flows through the line when the key  $K'$  is depressed as when  $K'$  is open. These conditions are:

$$r = Rl + R_p + r_1, \quad (7)$$

and 
$$r_1 = \frac{2 R_b (R_r + 2 r)}{2 R_b + R_r + 2 r} + R_r + 2 (Rl + R_p), \quad (8)$$

where  $R_p$  and  $R_r$  are the resistances of the polarized and differential neutral relays respectively,  $R_b$  is the resistance in series with the generator,  $Rl$  is the resistance of the assumedly perfectly-insulated line and  $r$  is the resistance of the artificial line. Thus, if  $Rl = 1000$  ohms,  $R_b = 300$  ohms,  $R_r = 200$  ohms and  $R_p = 400$  ohms, then

$$r = r_1 + 1400,$$

$$r_1 = \frac{600 (200 + 2 r)}{800 + 2 r} + 3000,$$

whence  $r = 4966$  ohms and  $r_1 = 3566$  ohms.

The function of the *repeating sounder RS* is to eliminate false signals when key  $K$  is depressed while the other key is held down. The reversal in magnetization of relay  $R$  takes place quickly and before its armature has an opportunity to fall back to its rear contact and open the circuit of sounder  $S$ . In view of the foregoing descriptions, the operation of this duplex system may be readily understood without further comment, by tracing the conditions when no keys, either of the two keys, and both keys are depressed.

**8. The Bridge Duplex.** — The form of the bridge duplex circuit resembles that of the Wheatstone bridge, in having four arms with the home receiving instrument connected across opposite arm junctions, as shown in Fig. 16. For the station  $A$  the bridge arms are: winding  $a$  of the *retardation coil I*, line  $xy$  plus the paths from  $y$  to ground at the right-hand station, artificial line  $AL_1$ , and the winding  $b$  of the same retardation coil. The arrangement for station  $B$  is identically the same. The simple polarized relays are

connected across the junctions  $x, w$  and  $y, z$ . The artificial line at each station is adjusted to equal the resistance of the line and the apparatus at the distant station, and the resistances of the two coils of each retardation coil are equal.

When both keys are idle, the armatures of the pole-changers  $C$  and  $C'$  rest against their rear stops which are joined to the positive generator terminals, and therefore no current traverses the line wire. At station  $A$  a current divides at the point  $m$ , one part traversing winding  $a$  and relay  $P$ , and the other part traversing winding  $b$ , both

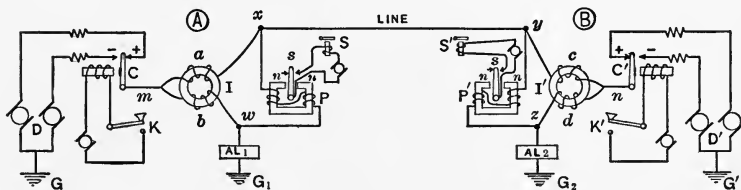

Fig. 16.

currents then combining at the point  $w$  to flow through the artificial line  $AL_1$  to ground and back to the other generator terminal; while at station  $B$ , a current divides at the point  $n$ , one part traversing winding  $c$  and relay  $P'$ , and the other part traversing winding  $d$ , both currents then combining at the point  $z$  to flow through the artificial line  $AL_2$  to ground and back to the other generator terminal. It will be observed that the direction of the currents through the two relays is such that the relay armatures touch their idle contacts and therefore do not close the local sounder circuits, as indicated in the figure.

When the key  $K$  is depressed, the armature of pole-changer  $C$  touches the negative generator terminal, and consequently more current flows over the line than through either artificial line, and this current flows from  $y$  to  $x$ .



The line current entering at the point  $y$  is made up of the current coming through the coil  $c$  and that coming from  $z$  through the relay  $P'$ . The direction of this current is such that the right-hand pole of the relay will be more strongly magnetized than the left and consequently its armature closes the sounder circuit. At station  $A$  the arriving current divides at the point  $x$ , and that part which traverses the relay  $P$  is in such direction as to magnetize the left-hand pole more strongly than the right, so that this relay will not close the sounder circuit. Thus, the depression of one key controls the operation of the distant relay and sounder.

If both keys are closed, both pole-changer armatures will be in contact with the negative generator terminals, and again no current will flow over the line. Currents will now flow through relay  $P'$  from  $z$  to  $y$ , and through relay  $P$  from  $w$  to  $x$ , and their direction is such as to magnetize the right-hand poles stronger than the others and consequently the relay armatures will close both sounder circuits. Although each relay is caused to operate by its home battery, yet its action is controlled entirely by the distant key.

It will be noted that each receiving instrument is always shunted, so that only a part of the generator current can flow through the relay. The magnitudes of the currents in the various paths can best be compared by means of a numerical illustration.

Using 800-ohm polarized relays, 300-ohm resistances in series with each generator, and retardation coils with 500 ohms resistance per winding, at the ends of a 1900-ohm perfectly-insulated line, requires that the artificial lines be adjusted to have a resistance of 2500 ohms. The joint re-

sistance of the paths from the points  $x$  or  $y$  to ground at the corresponding station is then 600 ohms (calculated according to equation (9) following); thus the resistances of the artificial lines are correct, viz.  $1900 + 600 = 2500$  ohms. The steady currents, in milliamperes, flowing through these paths for various sending conditions with 150-volt generators, are given in the following table, and their directions are indicated by + and - in connection

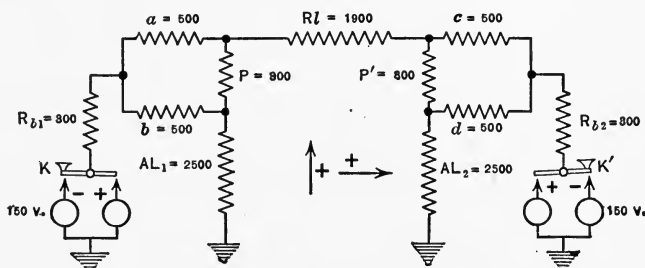

Fig. 17.

with the scheme of Fig. 17, the + sign signifying a current flowing upwards or toward the right, while - denotes a current flowing downwards or toward the left. The stars represent the operation of relays.

## CURRENTS IN BRIDGE DUPLEX CIRCUIT

Condition	Resistance $R_{b1}$	Coil $a$	Coil $b$	† Relay $P$	$AL_1$	Line	$AL_2$	† Relay $P'$	Coil $c$	Coil $d$	Resistance $R_{b2}$
Neither key depressed.....	+48	+13	+35	-13	-48	0	-48	-13	-13	-35	+48
Key $K$ depressed.....	-120	-71	-49	-13	+36	-84	-36	+13*	-71	-49	+120
Key $K'$ depressed.....	+120	+71	+49	+13*	-36	+84	+36	-13	+71	+49	-120
Both keys depressed.....	-48	-13	-35	+13*	+48	0	+48	+13*	+13	+35	-48

† By equation (80) of Chap. X.

The resistance of the terminal apparatus when  $a = b$  is calculated from the equation

$$R_0 = \frac{aP(2R_b + a) + R_b\overline{AL}(2a + P) + a\overline{AL}(a + P)}{(2a + P)(R_b + \overline{AL}) + a(a + P)}, \quad (9)$$

which is obtained by an application of Kirchhoff's laws. Since, for a perfectly insulated line

$$AL = R_0 + Rl,$$

by combining with equation (9) there results that the proper resistance of the artificial line should be

$$AL = \frac{Rl}{2} + \frac{1}{2}\sqrt{(Rl)^2 + 4Q}, \quad (10)$$

where  $Q = \frac{a(a + 2R_b)(Rl + P) + RlP(a + R_b)}{2a + P}$ . (11)

The bridge-duplex arrangement used by the Western Union Telegraph Company embodies various improvements on the system described, and will now be considered.

The retardation coil comprises two 500-ohm coils wound upon a circular core of rectangular cross-section, made up of soft iron wires. The core has an inside diameter of  $3\frac{1}{2}$  inches, an outside diameter of  $5\frac{3}{8}$  inches, and is  $1\frac{5}{8}$  inches wide; it is composed of about 6000 turns of No. 26 B. & S. annealed iron wire. Each winding has 7900 turns of No. 29 B. & S. double-cotton-covered copper wire and has a resistance of about 400 ohms. Its resistance is brought up to 500 ohms by adding approximately 110 turns of No. 28 german silver wire wound back on themselves, to render this compensating winding non-inductive.

Each 500-ohm coil possesses considerable inductance, and consequently a current coming over the line wire meets at first with great opposition in traversing the retardation

coil, because of the counter electromotive force of self-induction which is developed in it. This electromotive force is in such direction as to assist in the rapid growth of current in the polar relay to a value momentarily greater than the steady value. This initial pulse of current through the relay causes its armature to be moved from stop to stop with great rapidity. The retardation coils do not hinder outgoing currents very much because differing currents pass through the two windings of the coils differentially, and the magnetism developed in the core by one winding is neutralized to some extent by that developed by the other, and hence the coils for this condition are less inductive than before.

In order that the speed of pole-changer armatures shall be high, two series-connected electromagnets are provided on each instrument, one on either side of the armature. The iron cores of the front magnet are laminated while those of the rear magnet are solid and surrounded by copper sleeves, thereby causing the magnetism to be established much more rapidly in the front than in the rear magnets. Light retractile springs hold the armatures against their back contacts when the keys are elevated. When the key is depressed, current flows through both pole-changer electromagnets, but the armature is drawn toward the front contact because sufficient attraction is first exerted by the front magnet. As the armature is now further from the rear magnet, subsequent full magnetization of this magnet cannot cause its return. However, when the key is released, the rear magnet retains its magnetism much longer than the other, and consequently the armature is brought over to its rear contact far more rapidly than if the spring alone were acting. For 26-volt

local-circuit operation each electromagnet has a resistance of 4 ohms, while for 52-volt operation each has 13 ohms resistance.

A milliammeter, reading to 50 milliamperes in either direction, is placed in series with the polarized relays to measure the current flowing and to facilitate line balancing. When the artificial line resistance and capacity are so adjusted that the milliammeter needle is practically unaffected by the manipulation of the home key, a good working balance is established.

For increasing the resistance of short lines for operation at the voltages usually employed in duplex signalling, a line-resistance box is used at each station. It contains two separate and identical sets of resistances (five 250-ohm resistances in each set) simultaneously adjustable by means of a double lever. These resistances are interposed in the real and artificial lines at the points *w*, *x*, *y* and *z*, Fig. 16. The variation of each line resistance requires an adjustment of the distant artificial line. The insertion of this resistance, which is almost perfectly insulated from ground, in the line circuit during wet weather, raises the apparent insulation of the whole line, that is the insulation resistance per ohm of line is greater than before.

The method of quenching the sparks produced at the pole-changer contacts is similar to that shown in Fig. 12, but the ground connection at the point *x* is replaced by a 20-ohm resistance lamp connected in series with the condensers; or a single  $\frac{1}{4}$  mf. condenser may be used instead of the two  $\frac{1}{2}$  mf. series-connected condensers. In practice non-adjustable 1 mf. condensers are also connected to the points *m* and *n* of Fig. 16, their other terminals being grounded.

9. Advantage of Double-current Duplex Systems. — It has been stated that the differential or single-current duplex is infrequently used because of the superiority in practice of the polar- and bridge-duplex systems, these latter being called *double-current duplexes*. Considerable difficulty is experienced in maintaining operation over single-current duplex lines when the weather is unfavorable, because the line insulation is poor. That this is the case can be seen from the following illustration.

In § 2 a 474-mile, 2000-ohm differential duplex line with two 200-ohm relays was considered. A 200-volt gravity battery having an internal resistance of 250 ohms and a 2327-ohm artificial line was employed at each end. The

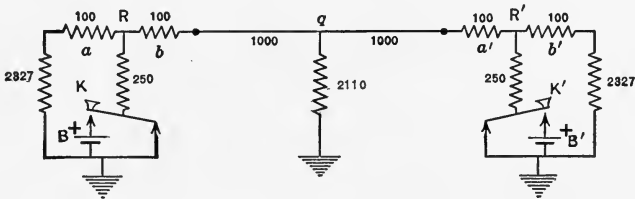

Fig. 18.

table in that section shows the current strengths in the relay coils when the line is perfectly insulated. If the insulation resistance should fall to 1 megohm per mile, and considering the distributed leakage to be concentrated at the middle of the line, the conditions are representable by Fig. 18.

It can readily be verified that the currents then traversing the relay coils, under otherwise identical conditions, will be as shown in the following table. The figures following the braces give the equivalent currents through one relay coil.

CURRENTS IN NEUTRAL RELAY COILS, EXPRESSED IN MILLIAMPERES

Relay	Coil	Neither key depressed	Key <i>K</i> only depressed	Both keys depressed	Key <i>K'</i> only depressed
<i>R</i>	<i>a</i>	0 } 0	67 } 18	72 } 40	5 } 57
	<i>b</i>	0 } 0	85 } 18	32 } 40	52 } 57
<i>R'</i>	<i>a'</i>	0 } 0	52 } 57	32 } 40	85 } 18
	<i>b'</i>	0 } 0	5 } 57	72 } 40	67 } 18

To assure satisfactory operation under these conditions the relays must be adjusted so that they will not operate on 18 milliamperes through one coil, but will operate on 40 milliamperes. For longer lines or for poorer insulation this margin of 22 milliamperes will be reduced and operation rendered unsatisfactory.

Consider a polar duplex line to have the same constants. When this line is perfectly insulated, the currents traversing the relay coils are as tabulated below, the values being computed in accordance with equations (4), (5) and (6).

CURRENTS IN POLARIZED RELAY COILS, EXPRESSED IN MILLIAMPERES

Relay	Coil	Both keys raised or depressed	One key only depressed
<i>R</i>	<i>a</i>	75 } 75	62 } 75
	<i>b</i>	0 } 75	137 } 75
<i>R'</i>	<i>a'</i>	0 } 75	137 } 75
	<i>b'</i>	75 } 75	62 } 75

When the line is poorly insulated, and the multitude of leakage paths be considered grouped at the middle point *q* of the line, and one key be depressed, this point *q*, being midway between + 200 and - 200 volts, will be at zero potential with respect to ground, and consequently leak-

age will cause no alteration in current distribution, and the current values in the last column still apply. The following table shows the currents then traversing the relay windings for all key positions. A margin of at least 40

CURRENTS IN POLARIZED RELAY COILS, EXPRESSED IN MILLIAMPERES

Relay	Coil	Both keys raised or depressed	One key only depressed
R	a	72	62
	b	32 } 40	137 } 75
R'	a'	32	137
	b'	72 } 40	62 } 75

milliamperes is effective for operating the relays. Of course, if these leakage paths were considered uniformly distributed along the line, the tabulated values would be altered somewhat, but it is clear that the double-current duplex systems are not as sensitive to weather variations as is the single-current system and consequently excel it in operation.

**10. Duplex Repeaters.** — Duplex repeaters are not as complicated in theory as simplex repeaters, for it is only necessary to connect the magnet of the pole-changer that controls one circuit with the contact points of the receiving relay of another line. A still simpler arrangement, dispensing with pole-changers, and called a *direct-point repeater*, is widely used.

*Polar Direct-point Repeater.* — The schematic diagram of the polar direct-point repeater is given in Fig. 19. The repeating station is equipped with four generators,  $D_1$  and  $D_2$ , two differentially-wound polarized relays,  $P_1$  and  $P_2$ , and two artificial lines. The elements of the originating and receiving stations  $A$  and  $B$  are also shown. When both keys  $K$  and  $K'$  are elevated they rest on the rear con-



tacts which are connected to the negative generator terminals. For this condition all four relay armatures will rest against their left contacts, as indicated in the figure. The armatures of repeater relays  $P_1$  and  $P_2$  will be against the negative contacts of generators  $D_1$  and  $D_2$ , no current will flow over either line wire, and sounders  $S$  and  $S'$  will not be actuated.

The depression of key  $K$  causes a greater current to flow over the western line and line coils of relays  $P$  and  $P_1$  than through their artificial line coils, and its direction will be such as to move only the armature of relay  $P_1$  to the right, thereby touching the positive generator termi-

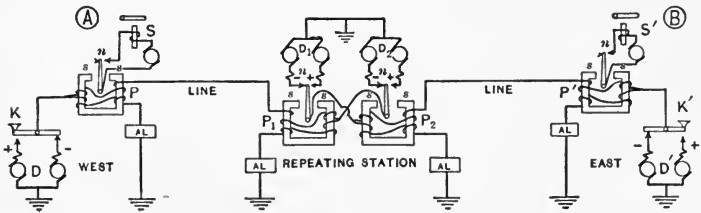

Fig. 19.

nal. of  $D_1$ . A greater current will then flow over the eastern line and line coils of relays  $P_2$  and  $P'$  than through their artificial line coils, and its direction is such as to move only the armature of relay  $P'$ , which then closes the local sounder circuit. Thus key  $K$  controls the operation of repeater relay  $P_1$ , of relay  $P'$  and of sounder  $S'$  at the remote station. In the same way key  $K'$  controls the operation of repeater relay  $P_2$ , relay  $P$  and sounder  $S$ .

When both keys are depressed it will be seen that all relay armatures press against their right-hand contacts, no current flows over either line, and both sounders are operated. Thus messages being transmitted in opposite direc-

tions over a single wire are simultaneously repeated without interference.

Fig. 20 shows the connections of the direct-point duplex repeater used by the Postal Telegraph-Cable Company. The principle of operation is identical with that just described, but there are several additional features. For the operation of reading sounders  $S_2$  and  $S_4$  at the repeating station, the *leak* relays  $L_1$  and  $L_2$  in series with 20,000-ohm

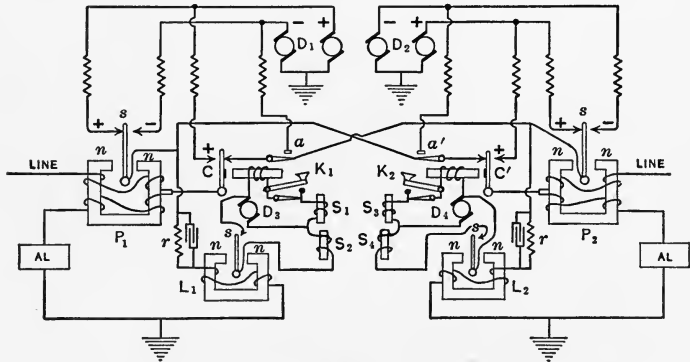

Fig. 20.

resistances  $r$ ,  $r$  (shunted by 1-mf. condensers) are bridged from ground to the armatures of the repeater relays  $P_1$  and  $P_2$ . The transmission of signals from one station to the other through the repeater for the various positions of the keys can readily be traced, the pole-changers  $C$  and  $C'$  remaining in the positions shown.

This repeater arrangement permits of separation, by the upward movement of the switches  $a$  and  $a'$ , into two polar-duplex sets. Thus duplex signalling may be effected between the left-hand station and the repeater station by manipulating the key  $K_1$  and the distant key, and also distinct duplex signalling may be carried on between the

repeater station and the right-hand station by manipulating the key  $K_2$  and the distant key. These sets differ from those described in connection with Figs. 10 and 12 only in the introduction of the leak relays. The unmarked coils are 300-ohm protective resistances.

*Bridge Direct-point Repeater.* — The arrangement of the repeater used with the bridge duplex by the Western Union Telegraph Company is shown in Fig. 21. The instrument positions represented are for the normal condition, that is, no signals being sent in either direction, the positive generator terminals being connected to the

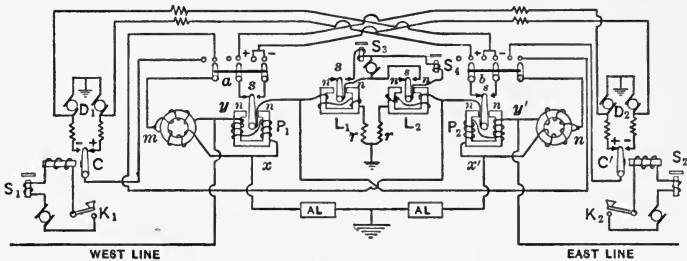

Fig. 21.

line at both stations. Reference to the explanation of the bridge duplex and Fig. 16 will indicate that the armatures of the two repeater relays  $P_1$  and  $P_2$  and consequently those of the leak relays  $L_1$  and  $L_2$  rest against their left-hand contacts. Further, no current traverses the two line wires, and the two reading sounders  $S_3$  and  $S_4$  at the repeating station are not actuated.

When the key at the western station is depressed, thereby bringing the line in contact with the negative terminal of the home generator, current will flow through the repeater relay  $P_1$  from the point  $x$  to  $y$ , and consequently its armature will be drawn over to the right.

This will cause the operation of sounder  $S_3$  through the leak relay  $L_1$ , and the negative generator terminal will be in contact with the junction  $n$  of the right-hand retardation coil. Current will then flow over the eastern line and through the relay  $P_2$  from the point  $y'$  to  $x'$  so that the armatures of relays  $P_2$  and  $L_2$  will remain as shown. The eastern line current is in such direction as to operate the polarized relay and sounder at the eastern station (see § 8).

The depression of both keys will cause all armatures to rest against their right-hand contacts, thereby actuating the sounders  $S_3$  and  $S_4$  and also the sounders at the terminal stations.

When the double-throw triple-pole switches  $a$  and  $b$  are moved to the left, the repeater is separated into two distinct bridge-duplex sets that differ from that already described only in the addition of the leak relays. It can be seen, then, that the western and repeating stations and that the repeating and eastern stations can engage in separate duplex signalling, both the repeater and leak relays being in use in this divided service. The resistances  $r$  are adjustable to have the following values: 8,000, 12,000, 16,000 and 20,000 ohms.

**11. Half-set Repeaters.** — Where it is found desirable to join a duplex line with a simplex line for through simplex operation in either direction, a *half-set* repeater is used. One-half of the apparatus necessary for a simplex repeater of any type will serve as a half-set repeater.

The connections of a Weiny-Phillips half-set repeater joined between a simplex line and a polar-duplex circuit are shown in Fig. 22. The repeater apparatus is shown between the two broken lines, while the simplex and

duplex receiving apparatus are shown respectively on the left and right sides as *A* and *B*. This apparatus is usually interconnected at a switchboard by means of flexible double-conductor cords equipped with plugs or wedges which fit into appropriate jacks, these cords being represented, for the sake of simplicity, by dotted lines.

The operation of the repeater transmitter *T* is controlled by the armature of the polarized relay *P*, and the operation of the pole-changer *C* is controlled by the armature of the repeater relay *R*<sub>1</sub>. The function of the differ-

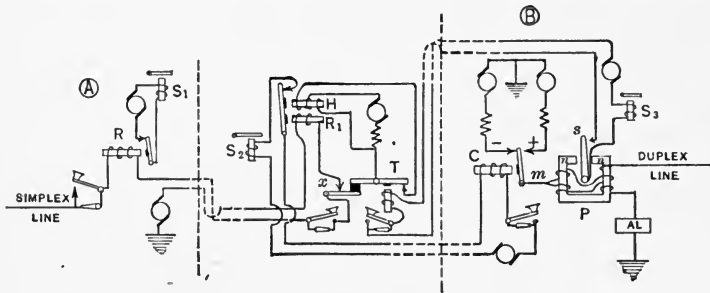

Fig. 22.

ential holding coil *H* of the Weiny-Phillips relay has been explained in § 10 of Chap. I.

In the normal condition, when the distant keys on both lines are depressed (or circuit-closers closed) current flows over the simplex line, distant relay and relays *R* and *R*<sub>1</sub>, and the duplex line will be in contact with the negative generator terminal. The armature of relay *P* will rest against the right-hand contact regardless of the position of the armature of the pole-changer *C* (because the distant pole-changer makes contact with the negative generator terminal), and consequently the armatures of sounder *S*<sub>3</sub> and of transmitter *T* will be attracted. Equal and oppo-

ing currents traverse the windings of the holding coil  $H$  so that its core is not magnetized; nevertheless the armature of the repeater relay will be attracted owing to the current in the main coil  $R_1$ . The attraction of this armature closes the magnet circuit of pole-changer  $C$  and its armature places the negative generator terminal in contact with the junction  $m$  of the relay windings. This action does not affect relay  $P$ , but the distant polarized relay on the duplex line responds and operates its local sounder.

When the key at the distant office on the simplex line is raised, no current flows through this line and relays  $R$  and  $R_1$ , and, therefore, their armatures will be released. The armature of the repeater relay opens the circuit of the pole-changer magnet which causes the positive battery terminal to be placed on the junction  $m$ . The relay  $P$  will not be affected, but the distant relay on the duplex line will open the home sounder circuit. In this way signals formed by the key on the simplex line are repeated to a distant station on a duplex line.

If, instead, the distant key on the duplex line be raised, the armature of relay  $P$  will be drawn over to the left-hand side, causing the magnet of transmitter  $T$  to be de-energized. This action opens the simplex line at  $x$ , and consequently the distant sounder on the simplex line releases its armature. Although no current flows through the relay  $R_1$  the magnetism developed in the core of the holding coil  $H$  by current in one of its coils is sufficient to hold over the armature, which action keeps the distant sounder on the duplex line energized. When the key at the remote end of the duplex line is again depressed, the armature of relay  $P$  is drawn to the sounder contact and

the armature of the transmitter is again attracted, thereby closing the simplex line at the repeating station. Thus the composite circuit operates as a closed-circuit simplex line.

Some important duplex circuits are operated simplex through half-set repeaters by current reversals instead of ordinary Morse simplex operation, because of higher speed possibilities and lesser dependence upon weather conditions. The Associated Press leased wire is operated in this way, the signalling being carried out by mecograph transmitters.

#### PROBLEMS.

1. A perfectly-insulated differential duplex line has a resistance of 1500 ohms and is equipped with a 140-ohm differential relay at each end. If the battery resistance is 200 ohms, calculate the proper resistance of the artificial lines.

2. When one key of the circuit of Prob. 1 is closed, thereby introducing a 160-volt battery, how much current flows through the line and through each artificial line?

3. A 2000-ohm polar-duplex line has a 300-ohm polarized relay, and a 2644-ohm artificial line at each end. Using 600-ohm resistances in series with the 200-volt generators, determine the current strength in each relay coil for the various positions of the signalling keys.

4. If the line of the preceding problem be operated on 380 volts as a leak duplex with 2200-ohm leak paths, compute the current strengths in the relay coils when one key is depressed and when both keys are either raised or depressed.

5. A Morris duplex line, having 800 ohms resistance, employs a 300-ohm polarized relay at one end and a 140-ohm differential neutral relay at the other end. Using 600-ohm protective resistances in series with the generators, determine the proper resistance values of the artificial line and compensating rheostat.

6. Derive equation (9) for the terminal resistance of a bridge-duplex circuit.

7. What should be the resistance of the artificial lines used with a perfectly-insulated bridge-duplex circuit having a 1000-ohm line, when using 600-ohm polarized relays, 200-ohm protective resistances and 500-ohm (each winding) retardation coils?

8. If in unfavorable weather conditions the line of Probs. 1 and 2 has a total leakage resistance to ground of 1500 ohms, considered concentrated at the mid-point of the line, determine the relay adjustment that will cause satisfactory operation.



## CHAPTER III

### QUADRUPLEX TELEGRAPHY

1. **Quadruplex Systems.** — A quadruplex telegraph system provides for the simultaneous transmission of two groups of signals in one direction and also two groups of signals in the opposite direction without interference over a single telegraph line. When in full use, eight operators are required for each quadruplex circuit, two receiving and two sending operators being located at each terminal station. Quadruplex signalling was devised by Thomas A. Edison, and was first placed in operation in 1874 by the Western Union Telegraph Company. It is now employed on many lines over distances up to 500 miles.

Quadruplex systems are generally based on a combination at each station of the single-current and double-current duplex systems, which have been described in the foregoing chapter. The single-current, or Stearns duplex, permits of the simultaneous transmission of one message in each direction through changes in current *intensity*, and the double-current system, either the polar or bridge duplex, permits of the simultaneous transmission of one message in each direction through changes in current *direction*. When these duplex systems are combined to form a quadruplex circuit, the latter is called the *polar side*, or *first side*, of the system, and the former is called the *neutral side*, or *second side*, of the system.

The manner in which these systems are combined is

illustrated in Fig. 1, which shows one station *A* equipped with apparatus only for sending and the other station *B* equipped with apparatus only for receiving messages. This circuit permits of the simultaneous transmission of two independent messages over one wire in the same direction, which transmission is called *diplex* signalling. Key *K* is a form of continuity-preserving pole-changer, which, when depressed, causes its lever contact *a* to raise the upper spring *u* away from the fixed contact *b*, and permits the lower spring *l* to follow until it strikes against this fixed contact. The key *K'* is a transmitter which changes the number of cells of the battery *B* which is included in

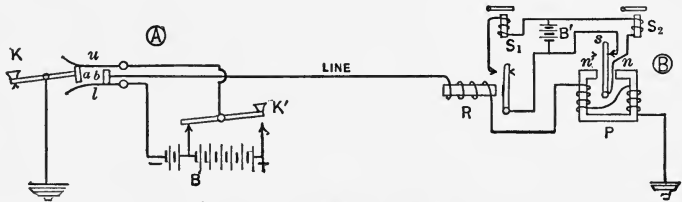

Fig. 1.

the circuit. Both keys are normally held in their upper positions by retractile springs. Relay *R* is a neutral relay which has its spring so adjusted that the armature will not be attracted when the small current, supplied by the left-hand part, or *short end*, of the battery traverses the relay winding, but will be attracted when supplied with current from the entire, or *long end*, of the battery. Instantaneous reversal of current direction has no effect upon this relay (see § 3). The polarized relay *P* responds only to current reversals and is not influenced by changes in current intensity, so long as this intensity exceeds 3 to 5 milliamperes.

When neither key is depressed the short end of the

battery is in circuit and key contacts  $a$  and  $b$  are respectively connected to the negative and positive battery terminals. It will be seen that the current then flowing is not strong enough to operate the neutral relay  $R$  and is in the wrong direction to operate the polarized relay  $P$ . When key  $K$  is depressed (as shown in the figure) the current flowing is not altered in intensity, but is reversed in direction, and consequently relay  $P$  responds and causes the actuation of its sounder  $S_2$  through the local battery  $B'$ . When key  $K'$  is also depressed the direction of current flow remains unaltered but its intensity is now sufficient to operate neutral relay  $R$ , which in turn operates sounder  $S_1$ . Thus, pole-changing key  $K$  controls the polarized relay, and the transmitting key  $K'$  independently controls the neutral relay, thereby enabling the simultaneous transmission of two messages from one station to another over a single wire.

**2. Operation of Quadruplex Systems.** — By duplicating the apparatus necessary for the diplex circuit just described and employing differentially-wound relays and an artificial line at each end of the line wire, as in the duplex systems, it is possible to send two messages in each direction at the same time, thereby affording quadruplex telegraphic signalling. Such a quadruplex circuit extending between two stations  $A$  and  $B$ , and operated by batteries, is shown in Fig. 2. It will be observed that the pole-changers  $C$  and  $C'$  are electromagnetically controlled by the keys  $K$  and  $K'$ , and that the transmitters  $T$  and  $T'$  are similarly controlled by the keys  $K_1$  and  $K_2$ . The short ends of the main batteries  $B$  and  $B'$  are connected in circuit when the keys  $K_1$  and  $K_2$  are open, and the entire batteries

are in circuit when these keys are depressed. The figure shows the long-end battery to have three times as many cells as the short-end battery. The positive and negative terminals of these batteries are connected to the line junctions  $x$ ,  $y$ , when the keys  $K$  and  $K'$  are raised and depressed respectively.

The figure represents the condition when the circuit is idle, all four keys being in the raised position. In this condition the positive terminals of the short ends of both main-line batteries are joined to the junctions  $x$  and  $y$ , consequently no current flows through the line coils of all relays nor through the line wire. A current will flow, however, from each

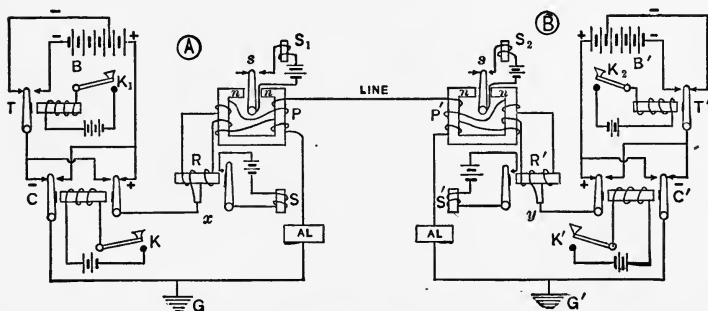

Fig. 2.

main battery through the artificial line coils of both relays, through the artificial line, and back to the other battery terminal. These currents are too weak to operate the neutral relays  $R$  and  $R'$ , and they are in the wrong direction to operate the polarized relays  $P$  and  $P'$ . Consequently the armatures of all sounders,  $S$ ,  $S'$ ,  $S_1$  and  $S_2$ , will remain drawn up by their retractile springs.

When key  $K$  is depressed the armatures of pole-changer  $C$  will be attracted and the negative terminal of the home

battery will be connected to the junction  $x$ , and the positive terminal will be grounded. The main-line batteries are now cumulatively connected, and more current traverses the line and line coils of all relays than flows through the artificial lines and artificial line coils of these relays. For ease in presentation, let the current traversing the artificial lines be considered of unit intensity, and let the adjustment of these lines be such that the current in the line wire when either key  $K$  or  $K'$  only is depressed be 2 units. Currents, then, of 1 unit intensity flow through the artificial line coils of all relays, and opposing currents of 2 units intensity flow through their line coils. The surplus of 1 unit current through all the line coils of the relays is insufficient to actuate the neutral relays  $R$  and  $R'$ ; it is in the proper direction to operate polarized relay  $P'$ , but is in the wrong direction to operate polarized relay  $P$ . In the same way, the depression of key  $K'$  only causes the operation of relay  $P$ . Thus the depression of a pole-changing key causes the operation of the distant polarized relay and the actuation of the sounder controlled by it.

The *depression of both pole-changing keys* places the negative battery terminals to the junctions  $x$  and  $y$ , and, since the two identical main-line batteries are opposed to each other, no current flows over the line wire. Currents of unit intensity flow through the artificial line coils of all relays, and, as before, are too weak to operate the neutral relays  $R$  and  $R'$ . The direction of these currents is such as to operate both polarized relays.

The *closing of key  $K_1$* , all other keys being open, introduces the long end of battery  $B$  into the circuit. Its voltage being assumed three times that of the short-end

battery  $B'$ , the opposing line currents will not neutralize, but a current of 2 units will flow from station  $A$  to station  $B$  and through the line coils of all relays. At station  $A$  a current of 3 units intensity flows through the artificial line coils of the relays and artificial line, while at the other station a current of 1 unit intensity flows through the corresponding circuit. The currents through the two coils of relay  $R$  are in opposite directions around the core and, consequently, partially neutralize each other, the surplus of 1 unit current being insufficient to operate this instrument. This surplus current in the artificial line coils of the relay  $P$  is in such direction as to hold its armature away from the sounder contact. The currents through the two coils of relay  $R'$  are in the same direction around the core and are equivalent to a current of 3 units traversing a single coil. This current is strong enough to operate relay  $R'$ , for this instrument is so adjusted. The currents flowing through the coils of polarized relay  $P'$  are both in the wrong direction to operate this instrument. Thus, the depression of key  $K_1$  causes the operation of neutral relay  $R'$ ; similarly the closing of key  $K_2$  causes the operation of neutral relay  $R$ .

The *depression of both keys  $K_1$  and  $K_2$*  connects the long ends of both batteries to the circuit. No current flows over the line wire, but currents of 3 units intensity traverse the artificial line coils of all relays. These currents are sufficiently strong to operate the neutral relays  $R$  and  $R'$ , but are in the wrong direction to operate the polarized relays  $P$  and  $P'$ . Sounders  $S$  and  $S'$ , therefore, respond to the depression of both transmitting keys  $K_1$  and  $K_2$ .

When *keys  $K$  and  $K_1$  are closed*, the negative terminal of the long-end battery  $B$  is joined to the point  $x$ , while the

positive terminal of the short-end battery  $B'$  is joined to the point  $y$ . A current of 4 units intensity will flow over the line from the right toward the left, a current of 3 units will flow through the artificial line circuit at the left and a current of 1 unit will flow through the artificial line circuit at the right. It will be seen that the relays  $P'$  and  $R'$  respond, thereby operating sounders  $S_2$  and  $S'$ .

In the same manner, the currents in the various portions of the circuit and the relays affected, for the remainder of the 16 possible combinations of key positions, may be traced. Having given the constants of any circuit, the currents

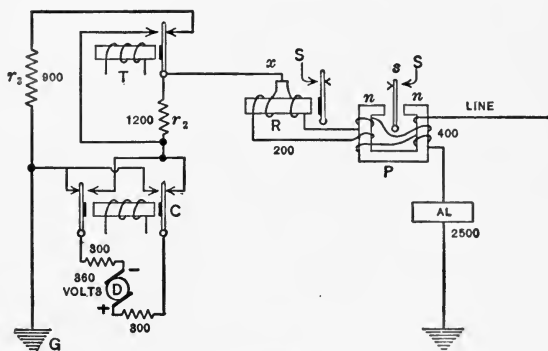

Fig. 3.

traversing the various relay coils can be determined in the usual manner.

The main-circuit connections of one station of a quadruplex circuit, using the Field key system with a single generator instead of the battery, are shown in Fig. 3. The function of the pole-changer  $C$  is the reversal of the generator  $D$ , while that of the transmitter  $T$  is the variation of available potential difference by means of the resistances  $r_2$  and  $r_3$ . When the armature of the transmitter is

attracted, the added resistance  $r_2$  is short-circuited and the resistance from the point  $x$  to ground at  $G$  is  $2 \times 300$  or 600 ohms, and when this armature is released the resistance is  $\frac{900(1200 + 600)}{900 + 1200 + 600}$  or 600 ohms, as before. The terminal resistance therefore remains unaltered regardless of the position of the transmitter armature.

To consider the variation in current produced by the movements of the transmitter armatures, let, as in the preceding chapter:

$R_p$  = resistance of polarized relays,

$R_r$  = resistance of neutral relays,

$R_b$  = resistance of protective coils in series with generators,

$r$  = resistance of artificial lines,

and  $E$  = voltage of generator.

Then, if the apparatus at the distant station is also as shown in Fig. 3 (that is, all keys open), the line current is zero and the current supplied by each generator is

$$I = \frac{E}{\frac{(R_p + R_r + 2r)r_3}{R_p + R_r + 2(r + r_3)} + r_2 + R_b}, \quad (1)$$

of which, the part that traverses the artificial line circuit is

$$I_1 = \frac{E - I(R_b + r_2)}{\frac{R_p + R_r}{2} + r}, \quad (2)$$

the remainder traversing the leak resistance  $r_3$ . When the armatures of both transmitters are attracted, the current flowing through the artificial line circuit is

$$I_1 = I = \frac{E}{\frac{R_p + R_r}{2} + r + R_b}. \quad (3)$$



Thus, if the resistances of the various paths are as indicated in the figure, the currents traversing the artificial line circuit when the transmitter armatures are both released and when both attracted are respectively 35.3 and 106 milliamperes. The attraction of the armatures thus triples the current flowing and this larger current is sufficient to operate the neutral relays. The currents for other key positions might be similarly determined.

At times it is feasible to raise the current ratio from 3 to 1 up to 4 to 1, which may be done by changing the added resistance to 1800 ohms and altering the leak resistance to 800 ohms, if the resistance in series with the generator remains the same. For any other current ratio  $\tau$ , or other series generator resistance  $R_b$ , the added and leak resistances should be respectively

$$r_2 = R_b (\tau - 1) \quad (4)$$

and

$$r_3 = \frac{R_b \tau}{\tau - 1} \quad (5)$$

In practice two generators at each station are more frequently employed in quadruplex service than one generator. The connections of one station, according to the Field key system with two generators, are shown in Fig. 4. Its similarity to the preceding figure will be noticed, and consequently the foregoing equations apply to this arrangement also. The relay contacts marked *S* are those against which the armatures must rest in order to operate the sounders.

To balance a quadruplex circuit the distant generators may be disconnected from the circuit while the resistance of the home artificial line is adjusted to equal the resistance of the line plus the terminal apparatus at the other

end. In order that the removal of the distant generators will not alter the terminal resistance, a switch,  $s_1$ , is ar-

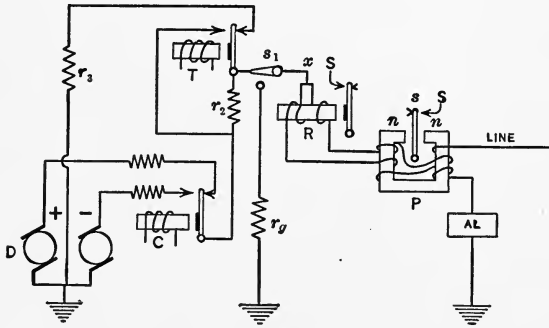
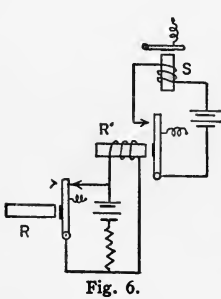
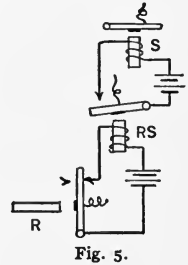

Fig. 4.

ranged to introduce a resistance  $r_0$  from the junction  $x$  to ground which equals the resistance connected in series with the generators.

**3. Avoidance of Sounder-armature Release During Current Reversals in Neutral Relay.** — When a neutral relay of a quadruplex circuit is actuated, and the position of the pole-changing key at the other station is altered meanwhile, the magnetism in the core of this relay is reversed. This means that the magnetism falls to zero and then rises to the same intensity in the opposite direction. As a consequence the attracting force also passes through zero, and a moment exists when the relay armature is not held against its front contact point. During this brief interval the local sounder circuit is opened and the sounder armature is momentarily released. In the operation of a quadruplex system such periods of zero magnetism in the neutral relay cores are constantly recurring, and result in false signals.

Various methods have been adopted for avoiding the release of the sounder armature during these short non-magnetization periods of the neutral relay. One method has already been mentioned in connection with the Morris duplex system, described in § 7 of the foregoing chapter; namely, the insertion of a repeating sounder. The connections of the local-sounder and repeating-sounder circuits are illustrated in Fig. 5. The repeating sounder *RS* has a heavy armature lever so as to render its action slow. It is evident that when the magnetism of the neutral relay *R* passes through its zero value, the relay armature would have to be drawn against its rear contact before the sounder *S* would release its armature. Since, in practice, the relay armature falls back but a small distance before magnetism of sufficient intensity in the opposite direction is again established to attract the armature, it follows that no false signals will arise.



Another device, for accomplishing this result, now extensively used on the quadruplex circuits of the Postal Telegraph-Cable Company, is the Diehl relay arrangement, which is shown in Fig. 6. It will be observed that the sounder *S* is actuated as long as the armature of relay *R* is away from its rear stop. When this armature touches its rear contact, the local battery, which supplies current to the relay *R'*, is short-circuited through a protective resistance, and consequently neither this relay nor the sounder is energized.

Neutral relays equipped with an extra coil, which receives current during the period of current reversal in the other coils from a condenser or from a reactor, are also used in order to avoid false signals. The arrangement used by the Western Union Telegraph Company with its quadruplex circuits is shown in Fig. 7. Each winding of

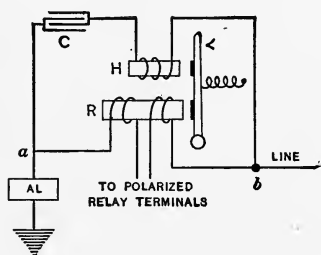

Fig. 7.

the main relay has a resistance of 350 ohms while the extra or holding coil *H* has a resistance of 225 ohms. The condenser *C* has a capacity of about 3 microfarads. As the condenser is charged to the difference of potential across the points *a* and *b*, the instant the distant

pole-changer armature leaves either contact in the act of reversing the polarity of the distant generator, the condenser immediately discharges through the holding coil, thus keeping the armature attracted during the interval that the current reverses in the main relay coils. The Freir self-polarizing neutral relay also gives satisfaction with quadruplex systems.

In order that the period of current reversal be as short as possible the movements of the pole-changer armatures between their contacts should be reduced as much as practicable. Quick reversals of magnetism in the relay cores are made possible by the use of relays possessing little inductance and having laminated cores.

**4. The Postal Quadruplex.** — The Davis-Eaves quadruplex is now largely used by the Postal Telegraph-Cable Company, and is illustrated in Fig. 8, which shows the ap-

paratus at one station. This arrangement is modelled after the improved polar duplex described in § 6 of the foregoing chapter. The functions of the bridge coils  $g$  and  $h$  with the bridged condenser  $c$ , and the shunt paths containing the resistances  $l$  and  $l'$  and the condensers  $c_1$  and  $c_1'$ , have there been explained. The operation of the transmitter  $T$  in varying the available potential by means of the leak resistance  $r_3$  and the added resistance  $r_2$  has been considered in connection with Figs. 3 and 4. The condenser  $c_3$  curbs the sparking at the transmitter contacts. The pole-changer  $C$  and the transmitter  $T$  are equipped with permanent magnets,  $pp$ , so arranged as to hasten the

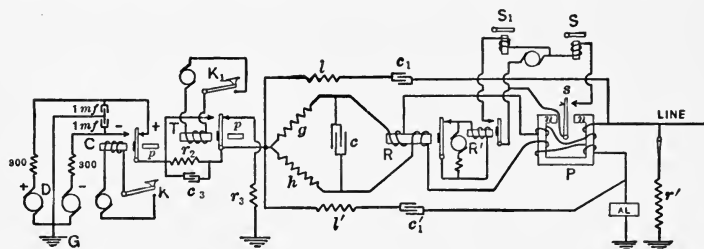

Fig. 8.

return of their armatures to the rear contact points. Neutral relay  $R$  controls the operation of sounder  $S_1$  through the Diehl relay  $R'$ , as explained by means of Fig. 6. A high-resistance leak path to ground is provided by closing a switch introducing resistance  $r'$ . Four local generators are shown in order to avoid complication of the diagram, but in practice only one generator is employed. The constants of the main circuit are: resistances of  $g = h = 500$  ohms, of  $l = l' = r_2 = 600$  ohms, of  $r_3 = 450$  ohms, of  $R = 60$  ohms, of  $P = 200$  ohms, and of  $r' = 25,000$  ohms; capacities of  $c_1 = c_1' = c_3 = 1$  microfarad, and of

$c = 12$  microfarads. The generator voltage should be from 250 to 385 volts.

5. **The Western Union Quadruplex.** — The quadruplex circuits, now the standard of the Western Union Telegraph Company, embody the principles of the bridge duplex, already considered in § 8 of Chap. II. The connections of the apparatus at one station of the Western Union quadruplex are shown in Fig. 9. The retardation coil *I*, the milliammeter *A*, the pole-changer *C*, the line resistance box, and the method of quenching the sparking at the pole-changer contacts have already been described in connection with the bridge duplex. The variation in

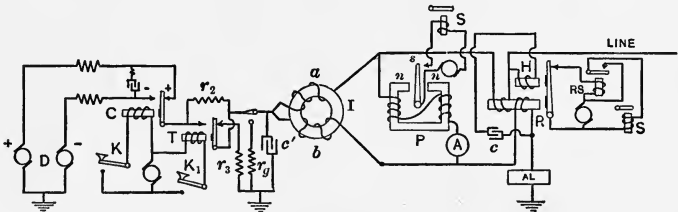

Fig. 9.

available potential is again effected by the Field system, *T* being the transmitter and  $r_2$  and  $r_3$  being respectively the added and leak resistances. Both the repeating sounder and neutral-relay holding-coil methods (see § 3) are utilized in tiding over the period of zero magnetization in the neutral relay core. Each artificial line is adjusted to equal, in resistance and capacity, the main-line wire plus the apparatus at the distant station. The ground resistance  $r_0$  facilitates line balancing. This resistance is also contained in the artificial line box, as shown in Fig. 6 of the preceding chapter, and connects with the terminal marked "Ground Balance."

When the distant pole-changer places the negative generator terminal to the line, the armature of the polarized relay at the home station will close its local sounder circuit, but when it places the positive terminal to the line the polarized relay will not operate its sounder. An alteration in current intensity from a minimum to a maximum value, or vice versa, does not affect the polarized relay whether it be against one contact or the other. Each polarized relay is unaffected by the movements of the home pole-changer.

The neutral relay is connected in the circuit exactly as in Fig. 2, that is, one winding is connected in series with the line wire while the other is connected in series with the artificial line. Each neutral relay operates only on the attraction of the armature of the distant transmitter, for the current then traversing this receiving instrument is three times as great as when the transmitter armature is not attracted, and because the retractile spring on the relay is adjusted so that its armature will not be attracted when the relay is traversed by the weaker current.

The charge residing in the condenser  $c$ , bridged across the line and artificial line through the holding coil of the neutral relay, will be relieved whenever the distant pole-changer armature leaves either contact. This discharge causes a pulse of current to traverse the holding coil, which pulse is sufficient to hold the armature of the neutral relay (if attracted prior to current reversal), against the front contact while the reversal of magnetism takes place in the main cores of the relay. As a further safeguard against the development of false incoming signals on the second side of the quadruplex the repeating sounder  $RS$  is used.

The constants of the main circuit are: resistances of coils  $a = b = 500$  ohms, of resistance lamps in each main potential lead = 600 ohms, of  $r_2 = 1200$  ohms, of  $r_3 = 900$  ohms,  $P = 600$  or 800 ohms,  $R = 700$  ohms and  $r_a = 600$  ohms; capacities of  $c' = 1$  microfarad, and of  $c = 1$  to 3 microfarads. The generator voltage should be sufficient to develop a current of from 0.09 to 0.15 ampere in the line wire when both transmitters and one pole-changer are closed.

When extremely bad weather renders the second side of the quadruplex inoperative, the quadruplex circuit may be used as a duplex circuit by keeping the two transmitters closed.

**6. Quadruplex Repeaters.** — In general, any two quadruplex sets can be connected together to form a quadruplex repeater. The scheme of connections of a quadruplex

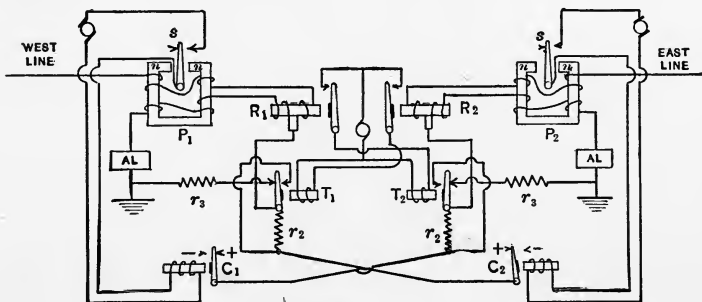

Fig. 10.

repeater is shown in Fig. 10. The polarized relays  $P_1$  and  $P_2$  control the operation of pole-changers  $C_1$  and  $C_2$  respectively, and the neutral relays  $R_1$  and  $R_2$  control the operation of transmitters  $T_2$  and  $T_1$  respectively. It is possible also to have the pole-changers controlled by the



neutral relays and the transmitters by the polarized relays. For more satisfactory operation repeating sounders may be interposed between each neutral relay and its corresponding transmitter, as already explained.

The armature positions indicated in the figure are for the normal condition, that is, when all keys at both eastern and western stations are open. This means that the positive terminal of the short-end battery or generator is joined to the line at each station as well as at the repeating station. The generators at the repeating station are not shown, but the pole-changer contacts are marked to show their respective polarities (the other generator terminals are grounded).

When the pole-changing key at the western station is depressed, twice as much current flows (toward the western station) through the line coils of relays  $R_1$  and  $P_1$  as through their other coils. This causes the operation of relay  $P_1$  but not of relay  $R_1$ . The armature of pole-changer  $C_1$  is attracted, thereby placing the negative generator terminal to the eastern line. This action does not affect the repeater relays  $R_2$  and  $P_2$  nor the distant neutral relay, but only the eastern polarized relay.

If, instead, the transmitter key at the western station be depressed, the long end of the home battery or generator will be joined to the line. Twice as much current flows (toward the repeating station) through the line coils of relays  $R_1$  and  $P_1$  as through their artificial line coils. This causes the operation of relay  $R_1$  but not of relay  $P_1$ . The attraction of the relay armature energizes the transmitter  $T_2$ , which impresses the greater generator voltage at the repeating station on the eastern line. This causes more current to flow through the artificial line coils of

relays  $R_2$  and  $P_2$  than through their other coils. The surplus current is insufficient to operate relay  $R_2$  and in the wrong direction to operate relay  $P_2$ . The distant neutral relay only responds to the depression of the western transmitter key.

In the same way the conditions may be traced, for other key positions at the two terminal stations, through the repeating station.

It is practicable to secure quadruplex operation over a portion of a line that at other portions is operated duplex. Thus, a number of lines between New York and Chicago are operated polar duplex between these terminal stations, and are also simultaneously operated differential duplex between New York and Buffalo. Such a circuit requires repeating apparatus at Buffalo that is formed by combining a direct-point duplex repeater with a quadruplex set.

**7. Duplex-duplex Signalling.** — A system of telegraphy that permits of duplex *or* duplex transmission, but not both simultaneously as in quadruplex signalling, is called

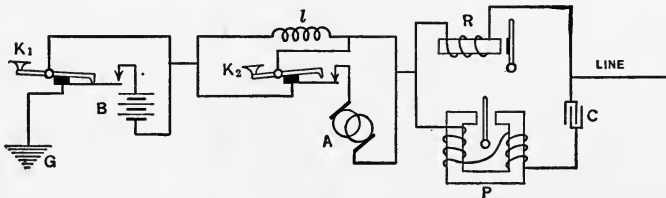

Fig. 11.

a duplex-duplex system. One such system, devised by Crehore, utilizes both an alternating current and a direct current, these currents being separated by means of inductances and condensers. Fig. 11 shows the schematic

arrangement of apparatus at one station for an open-circuit duplex-duplex system.

Continuity-preserving keys  $K_1$  and  $K_2$  respectively control the currents supplied by the battery  $B$  and alternator  $A$ . The neutral relay  $R$  and the polarized relay  $P$  are in parallel with each other, and in series with the line. The inductance of the polarized relay is neutralized by the properly-adjusted condenser  $C$ . The key  $K_2$  is shunted by a reactor  $l$  which has large inductance but little resistance.

If key  $K_1$  is depressed, a direct current flows through relay  $R$  and no current flows through relay  $P$  because of the presence of condenser  $C$ . Thus relay  $R$  as well as the distant neutral relay will operate on the depression of the direct-current key  $K_1$ .

Depression of key  $K_2$  introduces the alternator into the circuit, as shown. Because of the high inductance of relay  $R$ , only a small current will flow through it, and its retractile spring is adjusted so that the armature will not be attracted on this weak current. Polarized relay  $P$  as well as the distant polarized relay will, however, be actuated.

In this way either duplex or diplex transmission may be effected, the corresponding home instruments being also responsive to the outgoing signals. In duplex signalling one direct-current key and one alternating-current key must be used. Alternating currents of fifty to one hundred and fifty cycles may advantageously be employed. A quadruplex system may also be built up on the foregoing principles by applying alternating current to the ordinary duplex systems.

**8. Phantoplex System.** — To increase the message-carrying capacity of simplex, duplex or quadruplex lines by

additional superimposed channels, the so-called *phantoplex system* is employed by the Postal Telegraph-Cable Company. The arrangement of this system adapted to a quadruplex circuit and thereby affording *sextuplex* signaling, that is, the transmission of three messages in each direction simultaneously without interference, is shown in Fig. 12 for one station. The quadruplex connections will be recognized as those of the Field key system and explained with the aid of Fig. 4, the local circuits being omitted for simplicity.

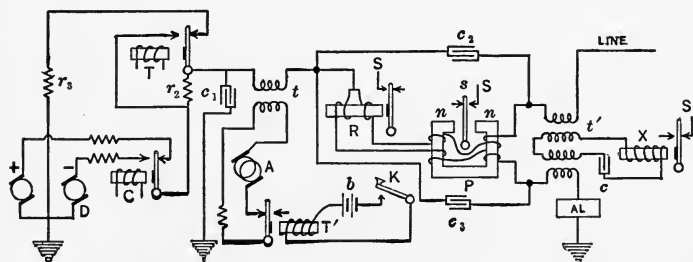

Fig. 12.

The secondary winding of a sending transformer,  $t$ , is introduced between the armature of the transmitter and the junction of the neutral relay windings. The primary winding of this transformer receives current from the alternator  $A$  (frequency from 60 to 125 cycles) when the armature of the transmitter  $T'$  rests against its rear stop, the transmitter being actuated by the current from battery  $b$  through the key  $K$ . The two primary windings of the receiving transformer  $t'$  are connected in the line and artificial line circuits, their secondary windings being properly connected in series to the phantoplex relay  $X$ , and through the condenser  $c$ . This phantoplex relay oper-

ates a sounder (not shown) when its armature rests against its rear stop.

When the key  $K$  is raised, as shown, an alternating electromotive force is induced in the secondary winding of the sending transformer, thereby superimposing an alternating current upon whatever steady currents traverse this winding. When no alternating current is superimposed on the main circuit at the other station by its sending transformer (that is, the distant key corresponding to  $K$  is closed), then the alternating current developed at  $t$  divides equally between the line and artificial line circuits. The voltages induced in the secondary windings of the home-receiving transformer oppose each other, and do not cause the attraction of the armature of phantoplex relay  $X$ . Its local circuit will be closed and the sounder actuated — the proper condition, for the distant key is closed. The alternating current that traverses the line wire also flows through one primary winding of the distant receiving transformer, no current flowing through its other primary winding. As a result the distant phantoplex relay will be energized, thereby opening its local circuit. Thus the distant phantoplex sounder will not be energized when key  $K$  is raised. Repeating sounders are used so that the fluttering of the armatures of the phantoplex relays, due to the alternating currents traversing their windings, will not affect their local sounders.

Condensers  $c_1$ ,  $c_2$  and  $c_3$  provide a direct path past the resistances and relay windings for the alternating currents. The alternating currents are of an intensity insufficient to energize the quadruplex relays.



3. If the two 300-ohm protective resistances of the single-generator quadruplex circuit shown in Fig. 3 are replaced by 200-ohm resistances, determine the proper values of the added and leak resistances necessary for a 3 to 1 current ratio.

4. Calculate the strengths of the currents in the artificial line circuit of Prob. 3, when both transmitter armatures are released and also when both are attracted.

5. Compute the terminal resistance of the Postal Quadruplex, the constants of which are given in § 4, if the artificial line has a resistance of 2000 ohms.

6. Develop the diagram of connections of a telegraph line circuit that extends from city A, through city B, to city C, which simultaneously affords two channels of communication (differential duplex) between cities A and B and two channels (polar duplex) between cities A and C.

## CHAPTER IV

### AUTOMATIC AND PRINTING TELEGRAPHY

1. **Wheatstone Automatic Telegraphy.** — When rapid or accurate telegraphic signalling is to be accomplished, automatic transmitting and receiving devices are availed of, and consequently such rapid telegraphs are usually called *automatic telegraph systems*. The Wheatstone automatic system has been most extensively used and permits of satisfactory telegraphic transmission at speeds up to 400 words per minute. The messages to be transmitted are perforated in specially prepared oiled or parchmented paper tapes in accordance with the Morse code, and these tapes are then automatically propelled through a transmitter, which is really a high-speed pole-changer, driven by springs or weights, or, more modernly, by electric motors. The Wheatstone transmitter is connected in the line circuit in the same way as is the pole-changer of a duplex circuit. The messages are received at the distant station by an inking polarized relay, called a Wheatstone recorder, which records the message in the Morse code on a tape, as is done by a register.

The transmitting tapes are prepared by means of three-key mallet perforators or keyboard perforators, and appear as in Fig. 1, which shows the punching for the word "relay." The Morse characters are also shown, the letter *l* in automatic telegraphy being written: dot, dash, dash, dash (Postal), or dot, dot, dash, dash (Western Union), instead of



a long dash. The size of standard perforator tape is 0.47 inch wide and from 4 to 5 mils thick. The center line of holes, or *guide holes*, are 0.1 inch apart when the perforator

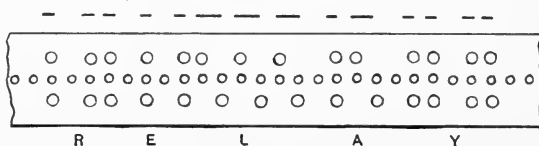

Fig. 1.

is properly adjusted. A dot appears as three holes in a vertical line, a space appears as one guide hole, and a dash appears as four holes: two guide holes and two others, one above the first guide hole and the other below the second guide hole. Longer spaces are allowed between words, sentences and messages.

A mallet perforator with interchangeable punch-blocks

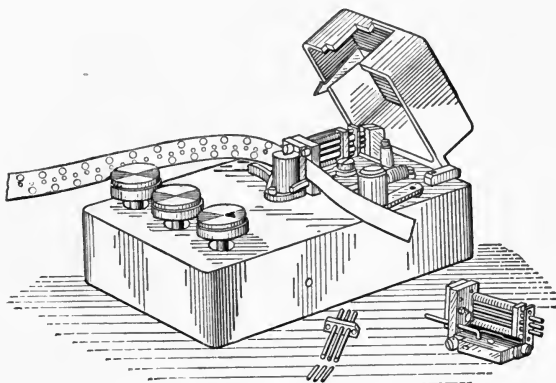

Fig. 2.

and removable punch-ends is shown in Fig. 2. The depression of the left plunger punches a dot, the center plunger punches a space, and the right plunger punches a dash.

The punching operator uses a rubber-tipped mallet in each hand for depressing the plungers. The plungers are restored by springs to their normal position after each depression, which action advances the tape one space after the depression of the dot or space plungers, and two spaces after depression of the dash plunger, the tape feeding being accomplished by a small spur-wheel which engages in the guide holes.

The principle of operation of the Wheatstone high-speed transmitter can be explained with the aid of Fig. 3, which illustrates simplex transmission from the left-hand to the

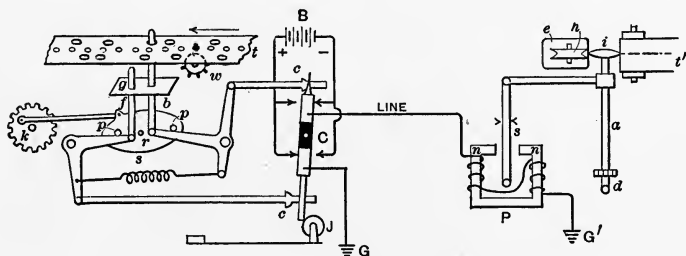

Fig. 3.

right-hand station. Only those mechanical features of the transmitter are shown which serve directly in the capacity of pole-changer. The transmitting tape *t* is moved along over a slotted platform, in the direction indicated by the arrow, by means of the spur-wheel *w* which engages in the guide holes. Another wheel, not shown, is mounted above the spur-wheel and serves to press the tape against the platform. Rods *f* and *b* pass freely through a guide plate *g* so that they remain respectively in line with the front and back rows of holes, and are spaced longitudinally so that their distance apart equals the distance between two adjacent guide holes. The rocking beam *r* carries out-

wardly-projecting pins  $p$ ,  $p$ , which limit the upward motion of the rods against the tendency of the spring  $s$ . The eccentric gear-wheel  $k$ , driven at any desired speed by clockwork, or by an electric motor, causes the rocking beam to oscillate through a small arc around its central pivot. With each downward movement of the rod  $b$  the tape moves forward one space or the distance between two successive guide holes. The motions of the rods  $f$  and  $b$  are transmitted to the pole-changer  $C$  by means of the cranks, rods and the ivory collets  $c$ ,  $c$ . The function of the jockey-roller  $J$  is to hasten the movements of the pole-changer and to insure steady contacts.

If the transmitter is set in operation without carrying a tape, the rise and fall of the rods will be unhindered, and every time the front rod  $f$  is in its upper position, the positive terminal of the battery  $B$  is connected to the line while its negative terminal is grounded, and every time the back rod  $b$  is in its upper position (as in Fig. 3) the negative battery (or generator) terminal is joined to the line. Thus the battery is reversed with every half oscillation of the rocker arm when the transmitter is operating idly.

These current reversals cause the armature of the polarized relay  $P$  to oscillate simultaneously, which motion is translated to the printing wheel shaft  $a$  that is kept revolving by means of the gear-wheel  $d$ . Whenever the positive battery terminal is joined to the line at the transmitter, the direction of the current through the polarized relay is such as to hold the printing wheel  $i$  against the inking wheel  $h$  which dips in the ink reservoir  $e$ . And when the negative battery terminal is connected to the line, the current direction is such as to press the inking

wheel almost against the moving receiving tape  $t'$ . These currents are called *spacing* and *marking* currents respectively. Thus, when the transmitter operates without tape, a succession of dots appears on the receiving tape.

At the instant represented in the figure rod  $b$  has passed through the tape, thereby sending a marking current and causing the printing wheel to press almost against the receiving tape and leave an ink mark thereon. The rocking beam then draws down rod  $b$  and allows rod  $f$  to rise; meanwhile the tape has moved forward one space. In this case the signal is a dot, and consequently rod  $f$  in its upward motion meets the front or lower hole and so passes through it. The complete transit of this rod causes the shifting of the pole changer  $C$  and the sending of a spacing current; consequently the printing wheel  $i$  is withdrawn from the receiving tape to the inking wheel. A dot is printed on the receiving tape.

If, instead, the signal were a dash, the upward movement of rod  $f$  would be arrested by the tape, because in a dash perforation there is no lower hole in line with the upper hole. As a consequence, the pole-changer would not be operated. Tracing the operation further, the upward movement of rod  $b$  would also be restricted, but the next upward movement of the other rod  $f$  would cause it to pass through the lower hole, which movement reverses the pole-changer. The time elapsing since the last reversal is sufficient to form a dash signal on the receiver tape. It will be observed that the current pulse for a dash signal is of the same direction as for a dot signal, but three times as long. For relatively low transmission speeds the signals may be read from a sounder connected to the local-circuit contacts of the receiving relay.

Fig. 4 shows an automatic transmitter made by Muirhead & Co., Ltd., for cable signalling. It is provided with a local pole-changer, speed regulator, speed indicator, and a switch for shifting connections from transmitter to hand-key sending, which at the same time lifts the paper wheel off the spur-wheel. The mechanical devices of the trans-

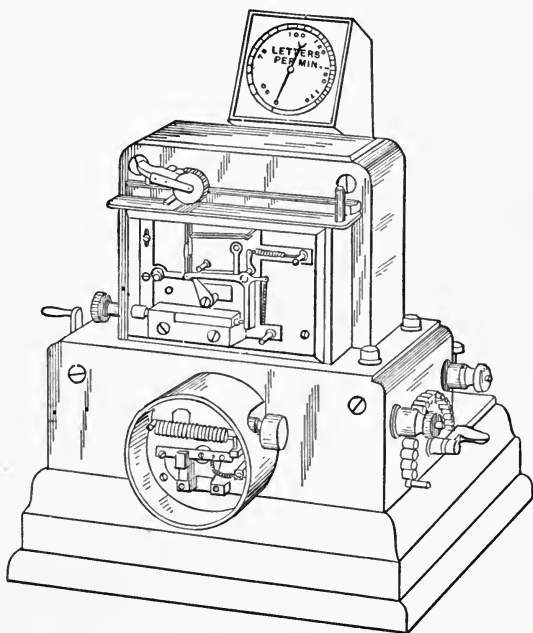

Fig. 4.

mitter are somewhat different from those shown in Fig. 3, but have the same function.

The connections of the Wheatstone automatic system for duplex operation are indicated in Fig. 5, which shows only the electrical features at one station. The connections are those of the polar duplex, already described, with a choice

of pole-changers. When the switch  $S$  is to the left as shown, the automatic transmitter  $C$  is in circuit, and when this switch is shifted to the right, the pole-changer  $C_1$  controlled by the key  $K$  is in circuit. The Wheatstone recorder  $P$  is immune from the movements of the home transmitting devices  $C$  or  $C_1$  and will only respond to the operation of

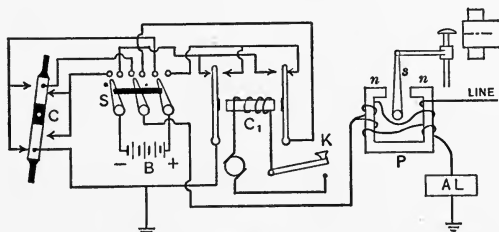

Fig. 5.

either the distant automatic transmitter or the distant manually-operated pole-changer. The Wheatstone system is almost invariably operated duplex.

Repeaters for use with the Wheatstone automatic system resemble polar direct-point duplex repeaters (§ 10, Chap. II) thereby dispensing with automatic transmitters at the repeating station for through operation. A Wheatstone recorder may be introduced at the repeater as a leak relay to enable the attendant to discern the character of the signals passing through the repeater.

The system described has been used by the Western Union Telegraph Company for many years. The automatic system used by the Postal Telegraph-Cable Company differs herefrom in the reception of the signals. It employs instead of the inking Wheatstone recorder, an electromagnetic punch, or *reperforator*, invented by d'Humy.

The reperforator punches characters in a moving tape somewhat similar to those of the transmitting tape. If the

completed receiving tape be passed slowly through a reproducer, whose speed is in control of the receiving operator, the messages can be read by ear and simultaneously copied by hand or on a typewriter. The punches of the reperforator are adjusted to travel over a very short distance, and their motion is rendered rapid by strong retractile springs and by a series condenser in the punch magnet circuits. Such small and rapid motion of the punches combined with a tape take-up device are the essential features of the reperforator, for they shorten the time of tape stoppages during punching and compensate for these stoppages respectively, thereby preventing tearing of the tapes.

**2. Ticker Telegraphs.** — A *ticker telegraph system* comprises a transmitter and a number of receiving instruments, called *tickers*, which print the messages in ordinary type on paper tape as they are received. The various ticker systems for the dissemination of news and stock quotations differ widely in the mechanical construction of instruments, but the fundamental operating principles are not very different.

A schematic diagram of a transmitter with one ticker of such a tape-printing system is given in Fig. 6. The transmitter consists of a shaft  $S$  driven by a constant-speed motor  $M$  through a friction clutch  $k$ . Mounted on this shaft is a current-reversing commutator  $c$ , formed by a pair of metal crown-shaped wheels which are fitted into but insulated from each other. The wheels connect through brushes with the negative and positive terminals respectively of generators  $D$  and  $D'$ , the other generator terminals being grounded. The shaft also carries an escapement wheel  $e$ , and a contact arm  $a$  which passes

over the contact points located on the contact disk *C*. The escapement is controlled by an electromagnet *m* through the keyboard *K*. Upon the depression of any key no current from the battery *B* will flow through the electromagnet until the contact arm *a* reaches the contact stud corresponding to the key depressed. At that instant the armature of magnet *m* will be attracted, thereby arresting the rotation of the shaft and commutator. Thus the shaft is stopped at a particular place for each depressed key.

At the receiver the type-wheel *T* is rotated by clock-

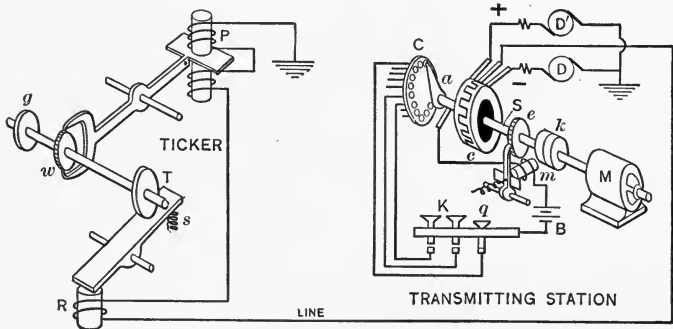

Fig. 6.

work through the gear-wheel *g*, but this rotation is constrained by means of the escapement wheel *w*. The armature of polarized relay *P* controls this escapement wheel. The rear end of the armature of printing relay *R*, when this instrument is operated, presses the tape, which moves over the armature, against the type-wheel; consequently that letter will be printed on the tape which, at the moment of operation of the relay *R*, is in the lowest position.

If *n* characters are to be employed in transmission, there must be *n* keys on the keyboard, *n* notches on the escape-



ment wheel  $e$ ,  $n$  contact studs on  $C$  and  $n$  segments on the commutator  $c$ ; the commutator brushes and the contact arm  $a$  being properly aligned with respect to the notches on the escapement wheel. Thus, depressing any given key will always stop the shaft at the same place. At the receiver there are also  $n$  characters on the type-wheel and  $n$  teeth on the escapement wheel.

In operation, when no keys are depressed, the transmitter shaft revolves uniformly and the current supplied to the line is periodically altered in direction by the commutator. This reversal of polarity occurs so rapidly that the current in relay  $R$  never reaches a value sufficient to cause the attraction of its armature before the next reversal takes place, consequently the rear end of this armature does not press the tape against the type-wheel. However, the alternating current traversing the sensitive polarized relay  $P$  causes its armature to shift its position with each reversal in polarity, thereby operating the escapement. One revolution of the transmitter shaft produces  $n$  current reversals and the escapement wheel at the receiver moves through  $n$  notches, or one revolution. It is evident, then, that if the type-wheel is started with its characters in a certain position, it will always remain during proper operation in the same relative position with respect to the transmitter shaft. The proper position of the type-wheel is such that the letter  $a$  will be in the printing position when the  $a$ -key of the transmitting keyboard is depressed.

Upon the depression of any key the motion of the shaft and commutator will be momentarily arrested. This stopping is permitted by the friction clutch without affecting the rotation of the motor. During this instant the

current ceases to alternate in direction, and relay *R* is enabled to attract its armature. This action presses the tape against the type-wheel, thus printing the character corresponding to the key that is depressed at the transmitter keyboard. As the armature resumes its former position through the intervention of spring *s*, the tape is moved forward one space by clockwork and is ready for the printing of the next character.

The system just described is known as a single-wire and single type-wheel ticker system. To avoid spelling figures, which occur very frequently in stock quotations, figures and fractions should also be provided on the keyboard and type-wheel. Adding to the 26 letters of the alphabet 10 figures and say 7 fractions would increase the size of the wheel and would materially decrease the speed of operation. Instead, it is customary to use two type-wheels on the same ticker-shaft and adjacent to each other, one containing letters and a couple of dots, and the other containing figures and fractions. As the numbers of characters on both type-wheels should be identical, the fractions may be repeated and the still-existing deficiency may be made up by dots. A ticker so equipped is called a two-wheel ticker.

In two-wheel tickers provision must be made for shifting either the type-wheels or the tape in order to print from either wheel. This shifting is accomplished electromagnetically in a variety of ways in the various ticker systems. For fast working an additional wire is generally used for the current which actuates the shifting magnet, thus necessitating two line wires to each ticker.

Should, for any reason, the type-wheel of a ticker be thrown out of step with the transmitter, as may occur

upon sticking of the escapement wheel or momentary interruptions of the line wire, a jumble of letters on the tape will

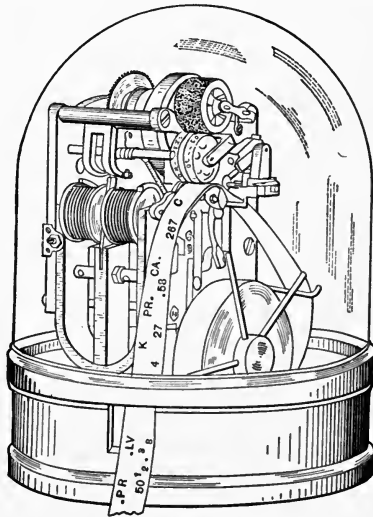

Fig. 7.

result. Automatic devices, termed *unison devices*, are availed of to bring the tickers back into step whenever desired.

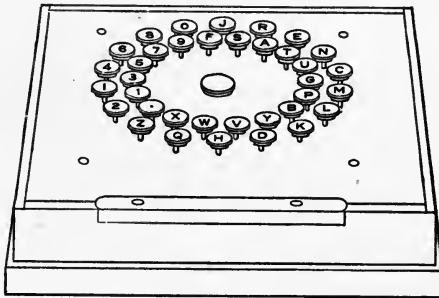

Fig. 8.

Generators are now more frequently employed in the operation of ticker systems than batteries, the generator

leads being provided with fuses and protective resistances. Condensers are also used in these systems for the elimination of sparking at the transmitter contacts.

The appearance of the ticker used by the Stock Quotation Telegraph Company in New York is shown in Fig. 7.

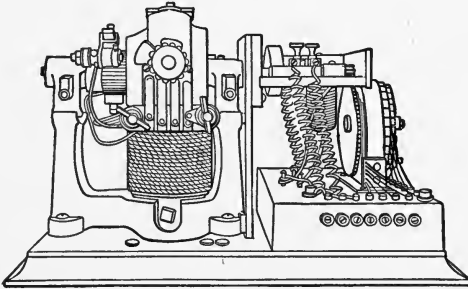

Fig. 9.

It has 8 ohms resistance and requires about 0.65 ampere for operation. Figs. 8 and 9 show respectively the keyboard and motor-driven transmitter used at the central station of a ticker system. The cost of ticker service is about \$20 per month. Fac-simile reproductions to full

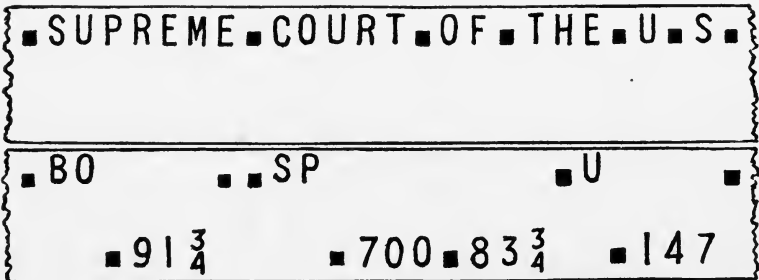

Fig. 10.

scale of the received tapes of a news ticker and a stock quotation system are given in Fig. 10; the significance of

the stock abbreviations on the lower tape being BO = Baltimore & Ohio, SP = Southern Pacific, and U = Union Pacific.

3. **The Barclay Page-printing Telegraph System.** — The Barclay printing telegraph system is now extensively used by the Western Union Telegraph Company, and comprises a keyboard perforator, an automatic transmitter, and a receiving polarized relay which repeats the arriving

**BARCLAY PRINTING TELEGRAPH CODE**

A	—	— — —	O	9	— — —
B	@	- — — -	P	0	- — — —
C	:	— — — —	Q	1	— — — —
D	\$	— — — —	R	4	— — — —
E	3	- — — -	S	#	— — — —
F	%	— — — -	T	5	- — — -
G	&	- — — —	U	7	- — — -
H	£	- — — —	V	;	— — — —
I	8	- — — —	W	2	— — — —
J	'	- — — —	X	1	- — — —
K	(	— — — —	Y	6	— — — —
L	)	- — — —	Z	"	— — — —
M	?	— — — —	.		— — — —
N	¢	- — — —	,		— — — —
Space		— — —	Paper Feed		— — — —
Type Shift		— — —	Carriage Return		- — — —

signals into a set of local relays which control the operations of the printing magnets, the received message being directly printed in page form on message blanks. This system may be operated successfully through several repeaters. Its capacity is about 100 words per minute over lines 1000 miles long.

*Transmitting Apparatus.* Messages to be transmitted are first perforated in prepared paper tapes, exactly as

in the Wheatstone automatic telegraph system described in § 1, only a different code is employed. The code used in the Barclay system has three elements for each character and these are separated from each other by short or long spaces, as shown on the preceding page. The spaces between the various words, figure groups, etc., are formed by three closely-spaced dots. Thus, the perforations in the transmitting tape for the word "relay" would appear

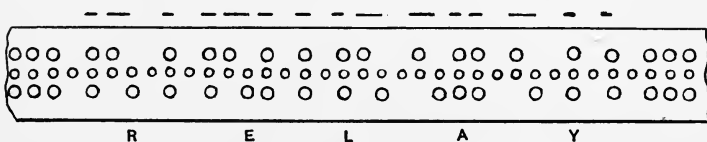

Fig. 11.

as in Fig. 11 (compare with Fig. 1 showing perforations according to Morse code).

The Kleinschmidt perforator, now largely used with the Barclay page-printer, is shown in Fig. 12, and is a purely mechanical device for punching the tape, but derives its motive power from an electric motor. All the perforations representing a letter, figure or other character on the tape, as well as their proper spacing, are produced by a single depression of the key. After this depression, the tape is advanced a distance commensurate with the space occupied by the letter or figure. After about 60 letters are punched an indicator lamp illuminates giving a warning that the end of a line (on the receiving page) is approaching. The pointer, which indicates the number of letters perforated, is returned to zero by the depression of the indicator key before the limiting number of 75 characters have been prepared.

The automatic transmitter used with the Barclay print-

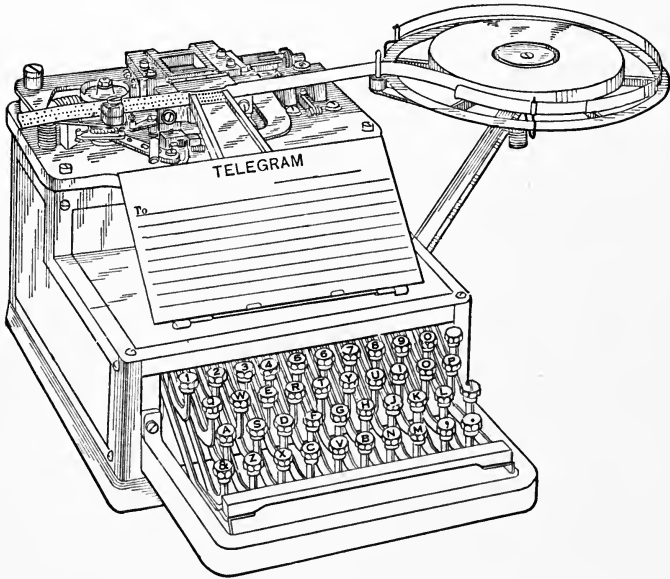

Fig. 12.

ing system is a Wheatstone transmitter, or high-speed pole-changer, as described in § 1. A front elevation of the upper portion of this transmitter is shown in Fig. 13, wherein most of the letters refer to the same parts as in Fig. 3.

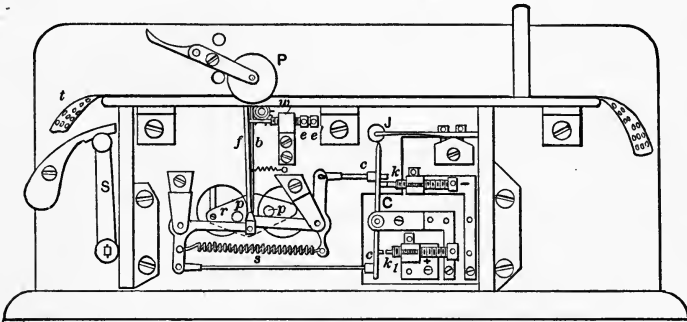

Fig. 13.

The pole-changer contacts are shown at  $k$  and  $k_1$ , and connect respectively with the negative and positive terminals of the generators. In operation the adjustment of the rods  $f$  and  $b$  must be very precise, and is effected by the screws  $e$  and  $e'$ . When the switch  $S$  is thrown to the left the paper wheel  $P$ , which is shown bearing upon the tape, is raised out of engagement with the spur-wheel  $w$ , thereby halting the progression of the tape. A local pole-changer for hand signalling is located in the base of the automatic transmitter. In practice, when the transmitter operates without tape, from 40 to 70 current reversals take place per second.

When the front rod  $f$  is at the upper end of its travel the positive generator terminal is joined to the line, and when the other rod is in a similar position the negative generator terminal connects to the line. Thus, for each letter there are six current pulses, three positive and three negative, and the code is so arranged that there is at least one long current pulse among the first five, either positive or negative, per character. In the letter  $R$  ( $\cdot - \cdot$ ), for example, these current pulses have the following sequence: short negative, short positive, long negative, long positive, short negative, long positive, the last pulse corresponding to the space between this and the next following letter. The significance of the code elements are therefore:

dot	= short negative current;
dash	= long negative current;
short space	= short positive current;
long space	= long positive current.

*Receiving Apparatus.* — The current impulses sent out by the transmitter are received by a differentially-wound



polarized relay of special construction to render it quick acting. To attain this end, its magnetic circuit has several air gaps, the moving element has a small moment of inertia, and the two coils of each winding are connected in parallel. The series resistance of each winding is 150 ohms. A top view of this relay is shown in Fig. 14, in which *a* is

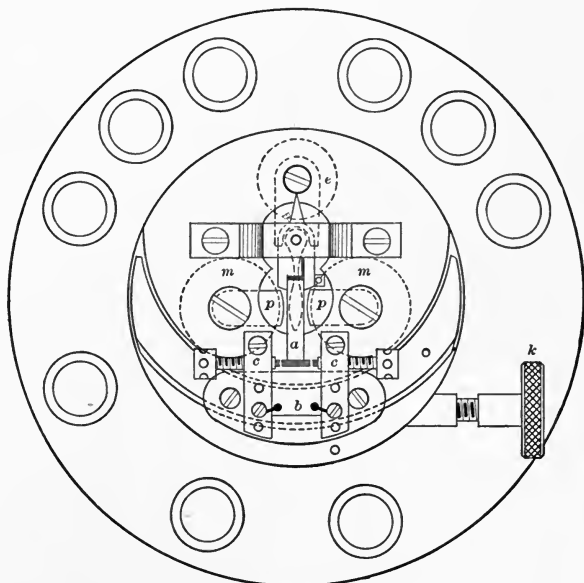

Fig. 14.

the armature tongue, *e* is the separately-excited energizing coil which takes the place of the usual permanent magnet, *m, m* are the main winding bobbins with the pole-pieces *p, p*; *c, c* are the platinum contacts, and *k* is the knurled screw which moves the bridge *b* carrying these contacts.

The connections of the main line and artificial line circuits of automatic duplex apparatus as arranged in the

Barclay printing telegraph system are shown in Fig. 15 for one terminal station. In the figure, *C* is the pole-changer, *D, D* are the generators, *P* is the polarized relay with its coils connected in parallel, *AL* is the artificial line, and *g* is a differential galvanometer which aids in line balancing. Repeaters for use with this system resemble polar duplex direct-point repeaters.

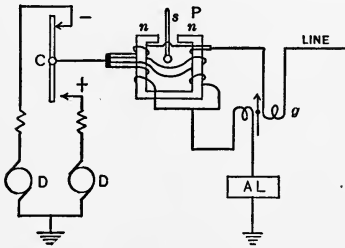

Fig. 15.

The main-line relay controls through the intervention of a "printer relay," a "separator relay," an "escapement magnet" and a "sunflower" distributing switch, the operation of five "distributing relays" with multiple contact points, which in turn control the operation of 32 "printer" magnets. The actuation of the distributing relays, as dependent upon the nature of the received current impulses, may be studied with the aid of diagram Fig. 16, in which the various intermediate devices mentioned are indicated.

The separator relay is a neutral relay which is adjusted to be responsive only to long current impulses in either direction. The escapement magnet is a polarized relay which controls the movement of the escape wheel. This wheel has 45 teeth and is mounted on the same shaft as the unison wheel with 15 teeth, the shaft tending to rotate under the influence of an electric motor. The six current pulses of each letter or character, alternately negative and positive, that traverse the escapement magnet cause the escape wheel to turn through a distance corresponding to 3 teeth and the unison wheel through a distance of one

tooth. As the unison wheel turns, its teeth successively butt against the toes of the six pivoted levers marked 1, 2, 3, 4, 5 and 6; thereby establishing connections with the five distributing relays and the sixth pulse or "final" relay. However, the circuits of the five distributing relays are only completed when the armature of the separator relay is on its front contact, which occurs only when a long current pulse traverses its winding.

Suppose the letter *R* is being received; the impressed pulses are: short -, short +, long -, long +, short -, and long +. Fig. 16 shows the armature positions during the *first pulse*. The armatures of the line and printer relays are respectively on their right and left contacts, the armature of the separator relay is not attracted, and the armature of the escapement magnet is toward the right. The unison wheel has turned through one-sixth the distance between two teeth, thereby causing a tooth to engage the toe of pivoted lever 1. But inasmuch as the circuit of distributor relay 1 is interrupted at the separator relay armature, the closing of its circuit at the sunflower does not cause the operation of relay 1, which remains inoperative until the end of the cycle of current pulses for the selected letter. During the *second pulse* the armatures of the line and printer relays and of the escapement magnet will be in their opposite positions, and the armature of the separator relay will still remain unattracted. Therefore the completion of the circuit of relay 2 at the sunflower does not cause the operation of relay 2. The *third pulse* is of dash duration, so the separator relay is capable of attracting its armature by current supplied by generator *D*. The escape wheel has moved another half notch, bringing a tooth of the unison wheel in engagement with the toe of

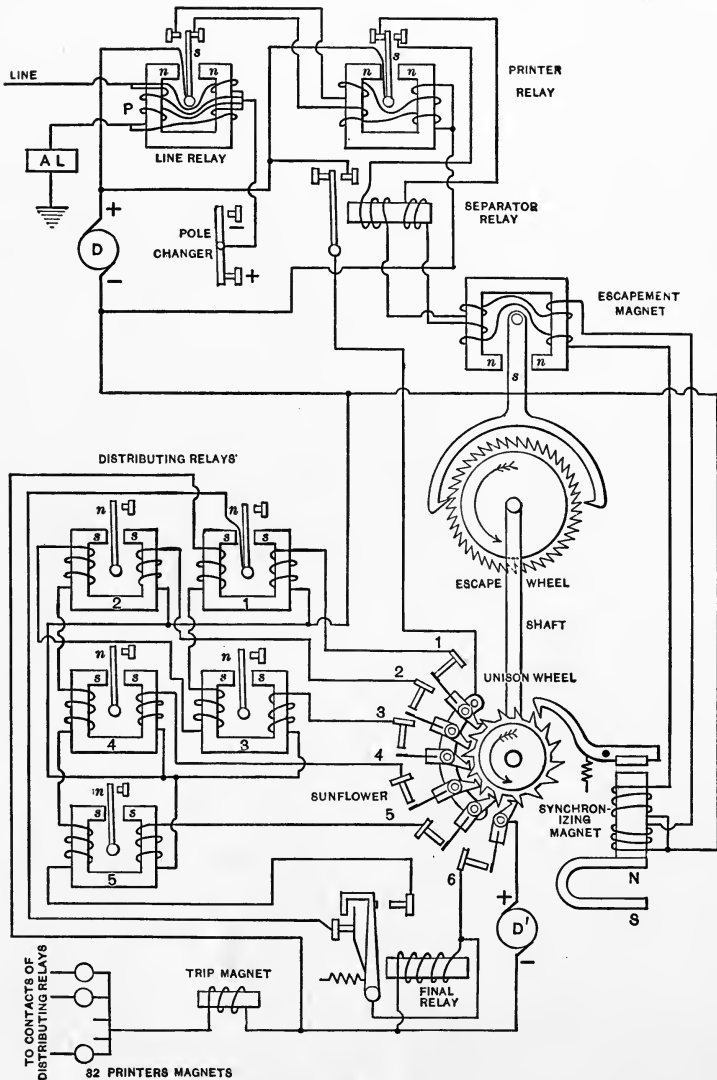

Fig. 16.

pivoted lever 3. Relay 3 will therefore be operated and remain so until the expiration of the remaining three-current pulses. The *fourth pulse* likewise causes the operation of distributor relay 4. As the *fifth pulse* is of short duration, relay 5 will not be actuated. Thus for the letter *R*, relays 3 and 4 are operated and close local circuits (not shown in this figure) which hold all printer magnets open except that which prints the letter *R*, as will be described subsequently. The *closing of sunflower contact 6* causes a current pulse always of long duration, since it represents the interval between letters, to flow from the generator *D'* through the rear spring contact of the final relay, through the particular printer magnet corresponding to the letter *R*, which places this letter in the printing position, and through the trip magnet which causes the type-wheel to come in contact with the message blank. Since the establishment of this sixth pulse the armature of the final magnet has been moving forward due to the current through its winding. This movement soon opens the circuit of the printer and trip magnets, but is adjusted not to do so until the proper printing of the desired letter is accomplished. Immediately after opening this circuit, the armature comes in contact with its front stop, thereby establishing a current through the left-hand or "reset" coils of the five distributing relays, which is in a direction to cause the armatures of the relays previously energized to resume their normal position on the left, in readiness for the next letter.

The distributing system, whereby a particular printer magnet out of thirty-two is selected by means of the five distributing relays, is shown in Fig. 17. Relay 1 is equipped with two contacts, relay 2 with four contacts, relay 3 with eight contacts, relay 4 with sixteen contacts, and relay 5

with thirty-two contacts. The small contact levers shown in the figure are insulated from each other.

The sequence of the long-current pulses in any letter or

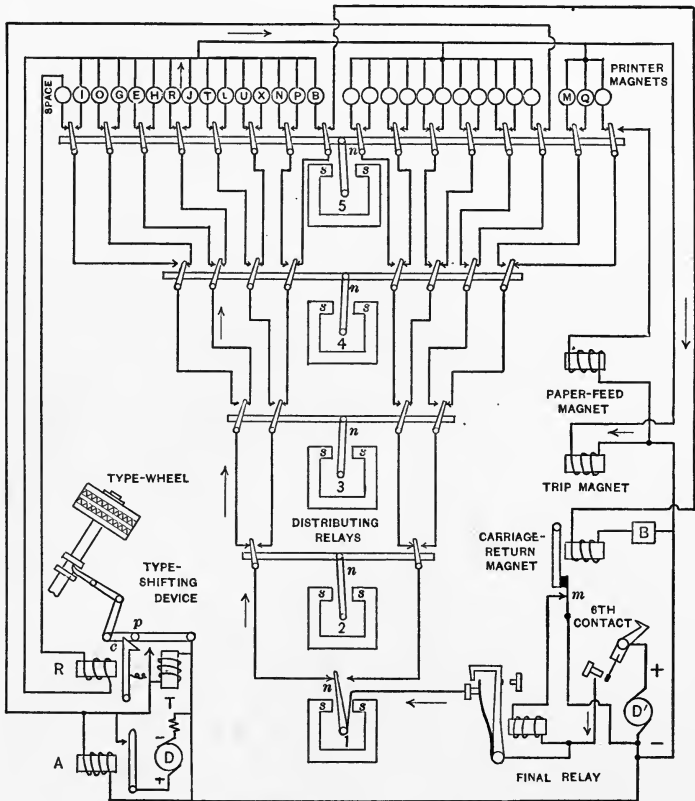

Fig. 17.

character determines the relay or group of relays that will be operated in the selection of the particular printer magnet. In the transmission of letter *R* the third and fourth relays are operated, causing their armatures to move to-

ward the right. This condition is represented in Fig. 17, and it is evident that the only printer magnet circuit that is closed is that which places the letter *R* in the printing position, the direction of current flow being indicated by the arrows. Current simultaneously traverses the trip magnet which urges the type-wheel, now rotated to its proper position, against the paper, causing the printing of the letter *R* thereon. In a similar manner the selection of the printer magnet for any other letter or character is accomplished.

The printing of the "upper-case" characters, given in the second column of the Barclay printing code, is accomplished by raising the type-wheel, which carries 56 characters grouped in two rows, so that the upper-case letters are brought into the printing line. Raising the type-wheel is done by the type-shift magnet *T* and its assisting magnet *A*, and the type-wheel remains raised until a "space" is transmitted, which lowers the type-wheel (if raised) through the operation of the type-release magnet *R*, as shown also in Fig. 17. As the sixth current pulse is of insufficient duration to cause the proper actuation of the type-shift magnet *T*, the assisting magnet *A* keeps the circuit of the other closed until the type-wheel is raised. Since magnets *T* and *A* are connected in parallel, both will be magnetized when the sixth current pulse of the type-shift group passes through their coils. Magnet *A* attracts its armature and causes current to flow from generator *D* through the coils of the type-shift magnet until the armature of this magnet is at the end of its travel. When this occurs the windings of both magnets are short-circuited, the assisting magnet releasing its armature, thereby opening the circuit of generator *D*. The armature

of the type-shift magnet is held down by the catch  $c$  engaging the pin  $p$ ; consequently the type-wheel is maintained in its upper position for the printing of upper-case letters until released by the attraction of catch  $c$  by the type-release magnet  $R$ , which operates on the reception of the "space" character.

Shifting of the paper for line spacing is accomplished by the paper-feed magnet which is actuated by the sixth pulse following 5 dash current pulses. Its operation is identical with that of the type-shift magnet, being assisted also by an auxiliary magnet, not shown in the diagram.

The carriage, holding the paper upon which the message is printed, is returned to the starting position by means of the carriage-return magnet, the mechanism, as before, not being shown in the figure. When the armature of this magnet is attracted, causing the return of the carriage, the circuit of the final relay is opened at the normally-closed contacts  $m$ . As a result, the current through the final relay is interrupted before its armature spring breaks contact with its rear stop, through which current continues to flow from generator  $D'$  to energize the carriage-return magnet. The instant the carriage arrives at its starting position, the circuit-breaker  $B$  opens the circuit of the carriage-return magnet, which in releasing its armature, completes at  $m$  the circuit of the final relay, thereby permitting this relay to reset the distributing relays.

Reverting to Fig. 16, the lever of the synchronizing magnet is seen to act upon the unison wheel. The function of this magnet is to restore the unison wheel to the zero position, if, for any reason, it gets out of step with the incoming current pulses. The winding of this instrument, which is of the polarized type, is such that its permanent



magnetization is opposed by negative current pulses and assisted by positive current pulses. Since the armature of this magnet is adjusted not to operate on short-current pulses, only long positive current pulses bring the synchronizer into action. Such pulses occur in some letters, and occur invariably at the end of each letter or character. In proper operation, the hook on the synchronizer lever rests in spaces between the teeth of the unison wheel, and would interfere with its motion at the end of each letter were not the synchronizer magnet energized at that instant by a long positive pulse. Should any pulses of a letter be lost, this magnet would restore synchronism upon the reception of the next following long positive current pulse.

**4. Other Printing Telegraph Systems.**—The Mor-  
krum page-printing telegraph system is also used at present both by the Western Union Telegraph and Postal Telegraph-Cable Companies. The Baudot tape-printing system is extensively used abroad, the system being operated simplex, duplex or multiplex. The Hughes tape-printing system is largely employed in Europe, about 3000 instruments being now in use. The Rowland multiplex and the Wright page-printing systems were for a time used on some circuits of the Postal Company. The Burry page-printing telegraph is used by the Stock Quotation Telegraph Company for disseminating general and financial news in New York City and vicinity.

Many other systems have been invented and are now used more or less here and abroad for the direct printing of the received messages, among which may be mentioned the systems of Munier, Murray, Essick, Dean, Creed, Siemens, Kinsley and Buckingham, the last being the fore-

runner of the Barclay printing system, herein described. Multiplex page-printing telegraph systems will be considered in Chap. VI.

### PROBLEMS

1. Show the appearance of a transmitting tape for automatic telegraphic transmission with perforations representing the word "Wheatstone."

2. How many words may be telegraphically transmitted in one direction over a wire by the Wheatstone automatic system in 6 hours if the perforated tape is passed through the transmitter at the rate of 4 words per second? Allow two per cent for idleness in changing tapes.

3. Fill out the letter designations of the blank printer magnet circles of the Barclay printer shown in Fig. 17.

4. When the speed of the Barclay transmitter is such that forty current reversals take place per second when running without tape, and considering the length of the average letter to be the average of the characters of the Barclay code, how many five-letter words could be transmitted per minute in each direction with this printing system?

## CHAPTER V

### TELEGRAPH OFFICE EQUIPMENT AND TELEGRAPH TRAFFIC

1. **Protective Devices.** — Fuses are used in telegraph circuits to protect these circuits from damage which might result from an excessive flow of current through them. They are made of fusible material, generally of lead or of an alloy of tin and lead, and assume the form of wire or strips provided at each end with a copper terminal which engages the contacts of the fuse receptacles. With enclosed fuses the fusible material is surrounded by a finely-divided non-combustible powder that is contained in an insulating casing. All fuses are placed at accessible places, generally in telegraph offices, so as to facilitate replacement in case of their melting.

Fuses are rated at 80 per cent of the greatest current they can carry indefinitely without melting. Thus, a fuse would carry a current 25 per cent greater than the normal rated current strength. For telegraph service fuses of  $\frac{1}{2}$ -ampere capacity and upward are used. Line fuses also offer protection to terminal apparatus when the lines are crossed with electric distributing and other high-voltage lines.

Lightning arresters are employed at telegraph offices and also on lines, as a protection against injury to terminal apparatus and attendant operators, that would otherwise result from lightning strokes or relieved abnormal induced charges. These arresters provide a short path to ground

through a small insulating gap, generally of air, that is readily broken down and rendered conductive by such discharges. The length of these gaps is such that the operating voltages in telegraph service cannot initiate arcs across the spark gaps.

In practice, satisfactory fuses and lightning arresters for telegraph circuits assume a variety of forms, concededly more or less familiar. The type of protector now used by the Western Union Telegraph Company is shown in Fig. 8.

2. **Peg Switch Panels.**—A switching arrangement adapted for use at intermediate stations on simplex lines

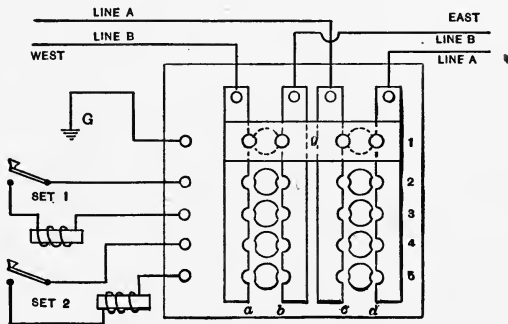

Fig. 1.

is shown in Fig. 1, and is called a *peg switch* panel or a *strap and disc switch* panel. The wall panel shown is used where two-line wires pass through an intermediate office, and provides means for introducing either set of receiving instruments into either line, for cross connecting, for looping these lines with or without introducing home instruments, and for cutting off one side of a line.

This panel consists of four brass straps and two rows of discs, five in each row. The line terminals are on the

upper ends of the straps, and the instrument terminals are along the left edge of the panel. The latter terminals are in line horizontally with the discs, and each terminal is in electrical connection with the discs located in the same horizontal row. The plate *g* is placed transversely over the straps and over the two upper discs, but is insulated from the vertical straps by a small air gap, thereby serving as the ground plate of a lightning arrester. Any disc may be connected to either of the straps between which it is located by means of a brass plug or peg, which fits in the holes formed between the discs and straps. These holes are in five horizontal rows numbered 1, 2, 3, 4 and 5, and in four vertical rows lettered *a*, *b*, *c* and *d*, so that any one of the 20 holes may readily be referred to. Two receiving sets, each consisting of relay and key, are also shown connected to the panel terminals. The insertion of a plug in any of the four upper holes grounds the corresponding strap.

When it is desired to insert receiving set 1 into line *A*, plugs are inserted in holes *c* 2 and *d* 3 (or *c* 3 and *d* 2). If, at the same time, it be desired to complete line *B* without a receiving set, plugs are inserted in holes *a* 4 and *b* 4 (or *a* 5 and *b* 5). To cross connect the two lines with receiving instruments in each circuit, plugs are placed in holes *a* 2 and *d* 3, and *b* 4 and *c* 5. Instead, to cut off the western section of line *A*, leaving receiving set 1 in its other section, insert plugs in holes *c* 1, *c* 2 and *d* 3. In order to loop the two eastern wires together with or without intermediate set 1, insert plugs respectively in holes *b* 2 and *d* 3 or in holes *b* 2 and *d* 2.

For the accommodation of additional lines at intermediate or terminal offices, peg panels having a corre-

spondingly greater number of straps and discs may be used. A combination of the peg-switch panel and the spring-jack device, the latter shown in Fig. 2, forms a

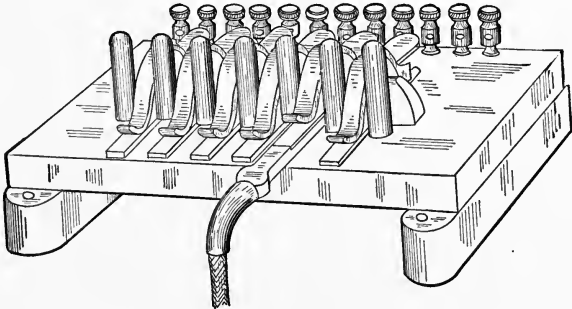

Fig. 2.

widely used panel. The insertion of a wedge, as shown, raises the *shank* away from the fixed *shoe* and introduces into the line whatever apparatus is connected with the wedge cord. Single- and double-conductor wedges are used for various purposes, and more than one wedge may be inserted in a spring jack, thus meeting a variety of telegraph-circuit requirements.

**3. Main and Loop Switchboards.** — In large telegraph offices the switching arrangements for the interconnection of all classes of circuits are located at switchboards. Usually these switchboards are divided into two parts: the *main switchboard*, at which terminate the incoming line wires, each wire being equipped with a group of pin-jacks; and the *loop switchboard*, at which the local office circuits or *loops* may be connected from one circuit to another. The pin-jacks on both switchboards are so connected that each line or local circuit is complete for normal operation.

Changes in these normal conditions are effected by single or double flexible conductors or *patching cords* having plug terminals which fit into the jacks. Fig. 3 shows the type of pin-jacks and plugs now extensively used on telegraph and telephone switchboards.

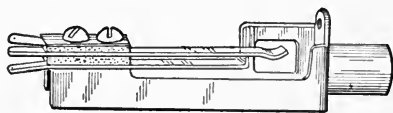

Fig. 3.

*Main Switchboards.* —

All line wires terminate at the main switchboard which is equipped with properly connected jacks for the establishment of any desired connections with these wires.

A main switchboard comprises a variety of circuits. A

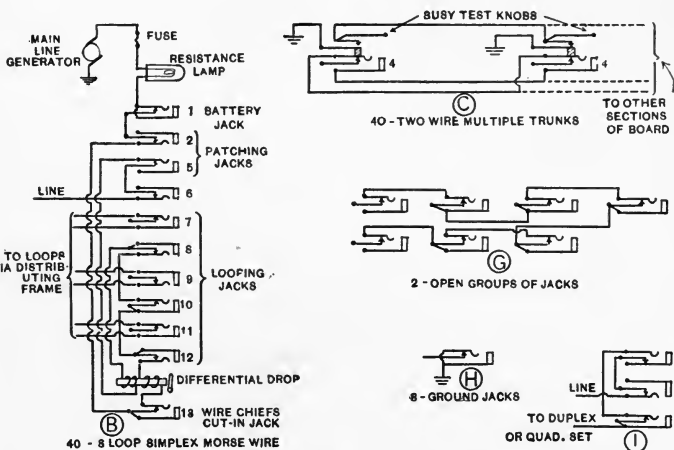

Fig. 4.

typical panel of the Western Union main switchboard for terminal offices contains nine types of circuits, five of which are shown in Fig. 4, the number of circuits of each

type being indicated. The remaining four types are shown as circuits *A*, *D*, *E* and *F* in Fig. 6 in connection

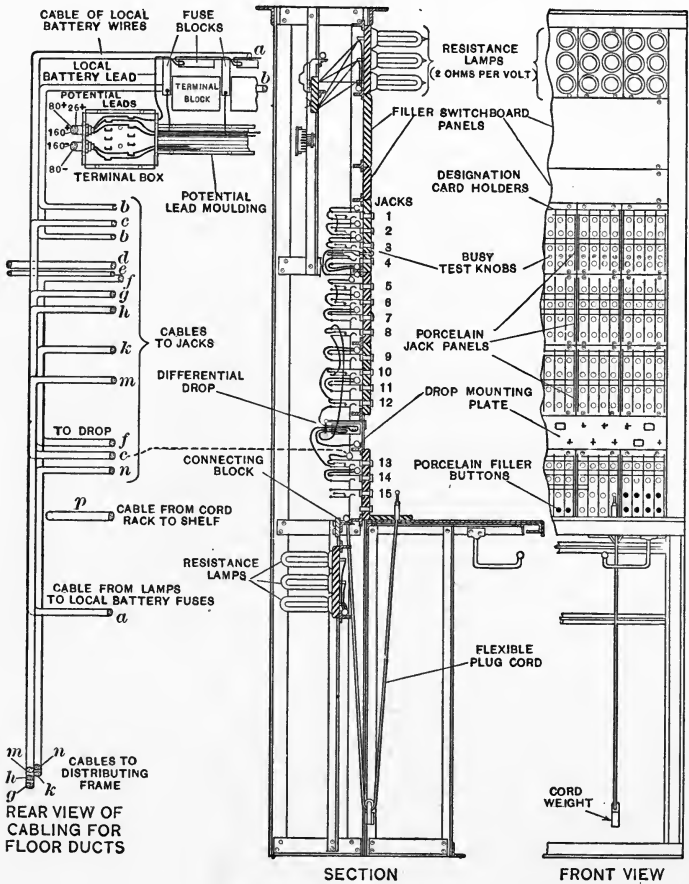

Fig. 5.

with the loop switchboard, twenty *A*, four *D*, ten *E* and twenty *F* circuits being employed. Circuits for combined telegraphy and telephony are also provided where necessary.



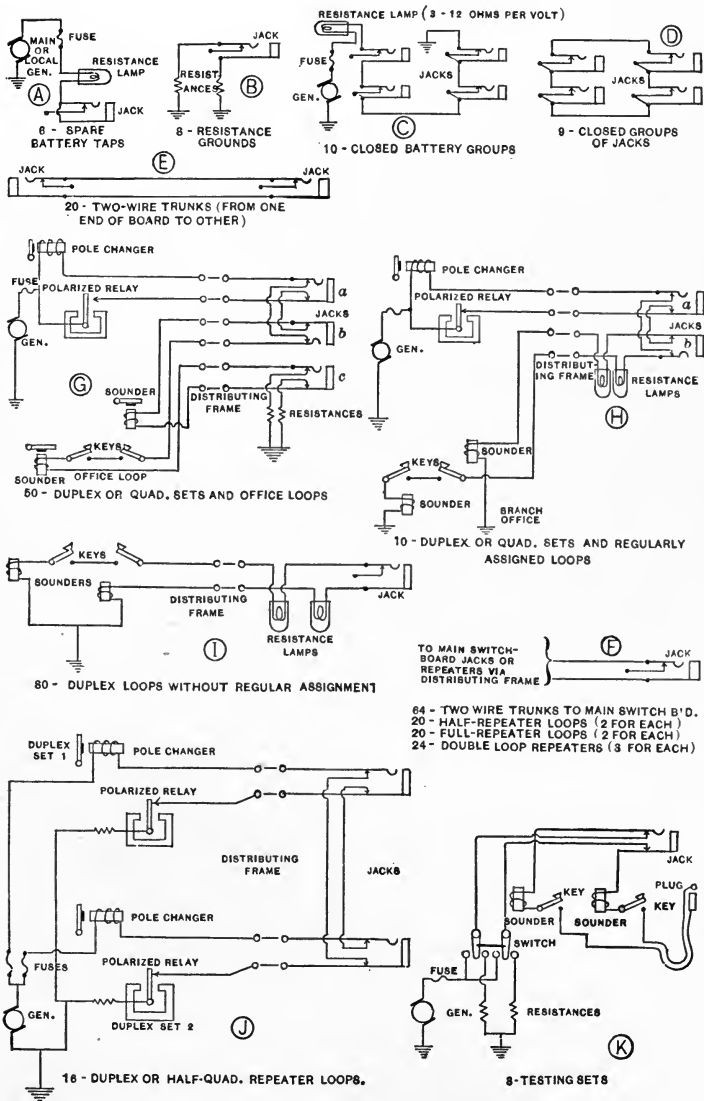

Fig. 6.

Referring to Fig. 4; circuit *B* is used for simplex service which may require three loops or sets each, the loops being included by inserting the plugs of patching cords in jacks 7-8, 9-10 and 11-12; circuit *C* is used on multi-section switchboards for extending loops and other circuits from one section to another; circuit *G* is used in cases of loop failures and circuit *H* is used for testing purposes where it is required to ground a line. For duplex or quadruplex circuits it is only necessary to connect the line through three jacks to the corresponding set via the loop switchboard and distributing frame, as indicated by circuit *I*.

The design of this switchboard is shown in Fig. 5, the jacks bearing numbers corresponding to those in Fig. 4.

*Loop Switchboards.* — A loop switchboard is generally installed at large telegraph offices to provide facilities for conveniently changing local circuit connections of duplex and quadruplex sets from one operating table to another at the main office or for distributing these connections to subscribers or branch offices, so as to take care of varying traffic requirements. The terminals of such local circuits extend to pin jacks on the loop switchboard, the board circuits being so arranged that the local apparatus regularly assigned to the same circuit is normally connected thereto, changes in these connections being made with flexible patching cords.

A loop switchboard includes a variety of circuits. A typical panel of the Western Union one-section loop switchboard comprises the eleven types of circuits shown in Fig. 6, the number of circuits of each type being indicated.

Circuit *A* is used in the testing of simplex circuits; circuit *B* is used in testing, or in case of failure of the resistances or contacts of an office loop, it replaces the lower

jack of circuit *G*; circuits *C* and *D* enable simplex apparatus, loops, repeaters, etc., to be readily joined in series, the former including a current source; circuit *E* permits of the interconnection of apparatus terminating at remote portions of the board by means of two short patching cords instead of one long one; the jacks of circuit *F* connect with receiving sets, repeaters, half-repeaters, etc., or extend to jacks on the main switchboard; circuits *G* and *H* connect the apparatus of a duplex or quadruplex set for normal operation, the latter circuit being used where an outside loop is regularly assigned to the set; circuit *I* is used for branch office loops that are not regularly assigned to any particular duplex set, and may replace those normally assigned in circuits *G* and *H*; circuit *J* normally joins the two duplex or half-quadruplex sets that constitute the duplex repeater; circuit *K* serves as a testing set for making any desired tests on duplex or quadruplex sets.

**4. Distributing Frames.** — Before telegraph aerial or underground lines reach the main switchboard at an office they pass through a distributing frame generally placed in back of the switchboard. Office cables extend from this frame to the main and loop switchboards and to the instrument tables on which repeater, duplex and quadruplex apparatus are located. Fig. 7 shows three units of a Western Union distributing frame. The right or "horizontal" side has 8 horizontal strips which carry terminal blocks for connection, say, to office apparatus, while the left or "vertical" side has 3 vertical strips which may carry similar terminal blocks or office protectors and connect with the incoming line cables. Each horizontal segment accommodates 20 terminal clips for an equal number

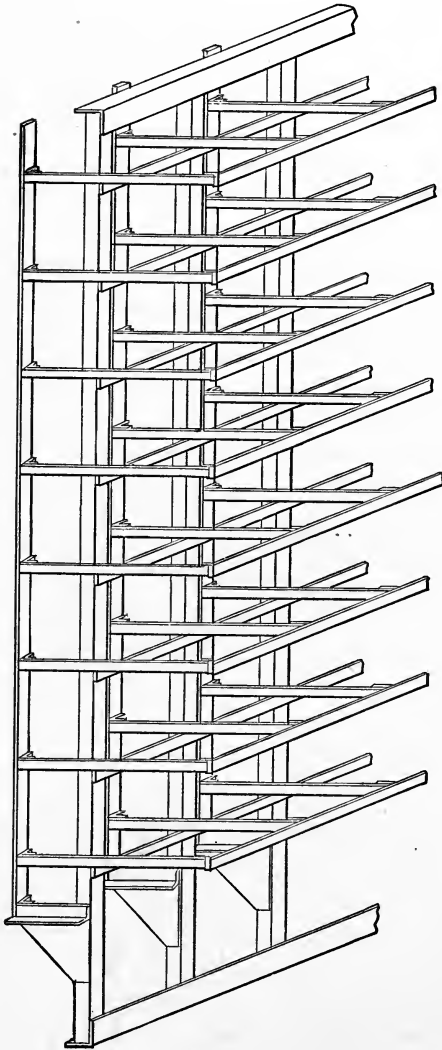

Fig. 7.

of wires and each vertical strip accommodates 100 protectors. These connections to terminal clips and protectors are permanent. Any desired connection may be made between the different pieces of apparatus in the office, or between such apparatus and entering lines, by cross-connecting or "bridle" wires at the distributing frame. Switchboard rearrangements or changes in traffic requirements are, therefore, readily met by shifting the bridle wires without altering the apparatus and line wiring to the distributing frame.

The type of protector used comprises a one-half ampere

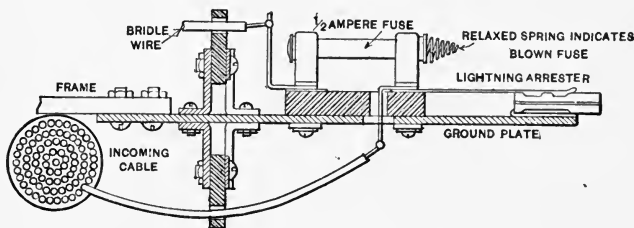

Fig. 8.

indicating fuse and a lightning arrester formed by two carbon blocks separated by a thin strip of mica, and is shown in Fig. 8.

**5. Instrument Tables.** — Telegraph apparatus at large telegraph offices is arranged in a very compact form on instrument tables. One general form of instrument table construction is shown in Fig. 9, which shows that portion of one side of a long table occupied by the apparatus of one quadruplex set. A duplex set requires about 13 inches and a duplex repeater set about 33 inches of table length.

The location of the apparatus of a Western Union quadruplex set on this table is generally as indicated in

the figure, the upper shelf being reserved for signalling purposes. The unit-section instrument tables used by the Postal Telegraph Cable Company are constructed of angle and sheet iron with apparatus located on four narrow tiers, each unit accommodating two quadruplex sets, or four duplex sets, or four repeater sets.

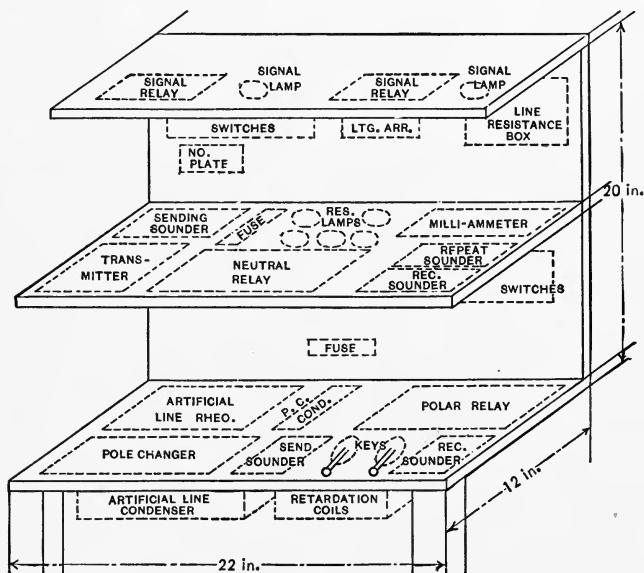

Fig. 9.

Attendants constantly oversee the operation of such duplex, quadruplex and repeating apparatus, each attendant having supervision of a certain number of sets.

**6. Power Switchboards.** — A switchboard for a telegraph power plant should comprise the necessary switching facilities, measuring and regulating devices for the placing of the desired potentials of correct polarity on the terminals

of the distributing panel from which conductors lead to the main switchboard. As most telegraph power plants consist of motor-generator units, which alter the voltage of the available commercial current supply to values suitable for telegraphic purposes, switchboards for such plants should also include motor-starting switches and rheostats. To maintain continuity of service in case of shut-down of the commercial current supply, arrangements are made if possible, for break-down connection with another source, or, if the available current sources are not dependable, a storage battery or, where practicable, a steam, gas or oil engine and generator, is installed.

The appearance of a typical power switchboard now used by the Western Union Telegraph Company for a motor-generator plant is shown in Fig. 10, scale  $\frac{1}{2}$ . The board is mounted directly over the machines, each panel controlling the motor-generators below it. The left-hand panel controls three machines, one generator having its positive terminal permanently grounded, another its negative terminal grounded, and the middle generator serves as a spare unit which may replace either of the others by shifting the reversing switch. The smaller switchboard panel is intended for two machines, one delivering current to the local circuits and the other a spare unit. All generator and motor-starting switches and the voltmeters are provided with enclosed fuses on the face of the board.

The connections of this power board for motor-generators with direct-current motors are shown in Fig. 11. Three 160-volt and two 26-volt motor-driven generators are shown, the outer 160-volt machines and the left-hand 26-volt machine being in service. When the middle 160-volt generator is to replace its left neighbor, it is

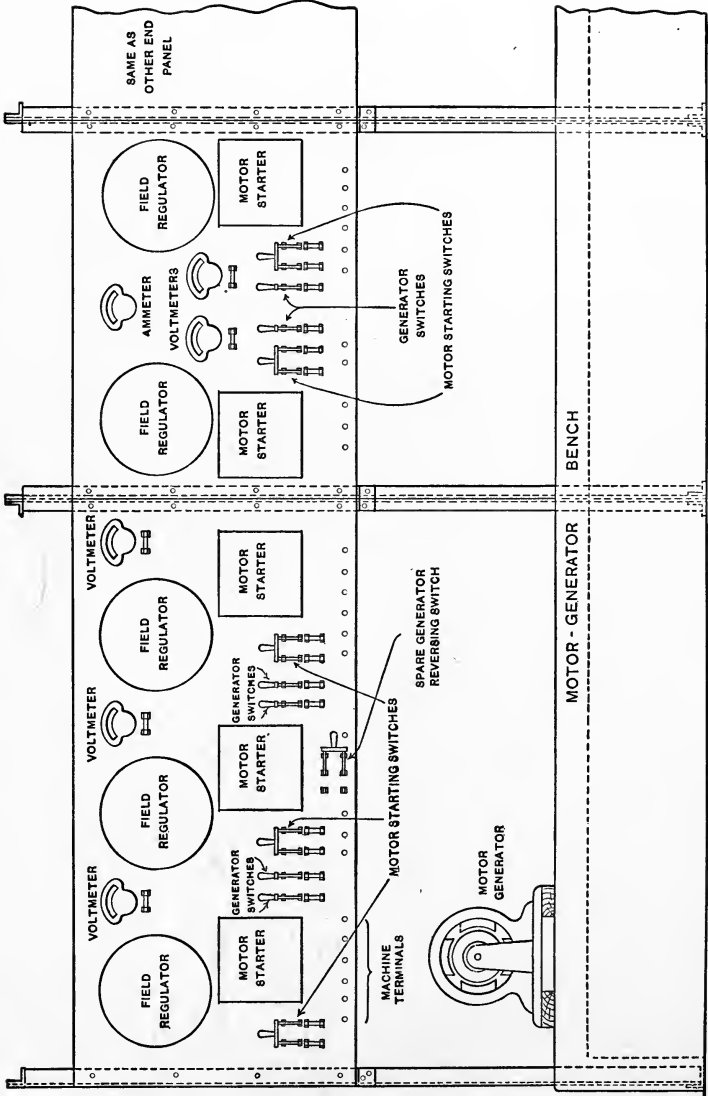

Fig. 10.



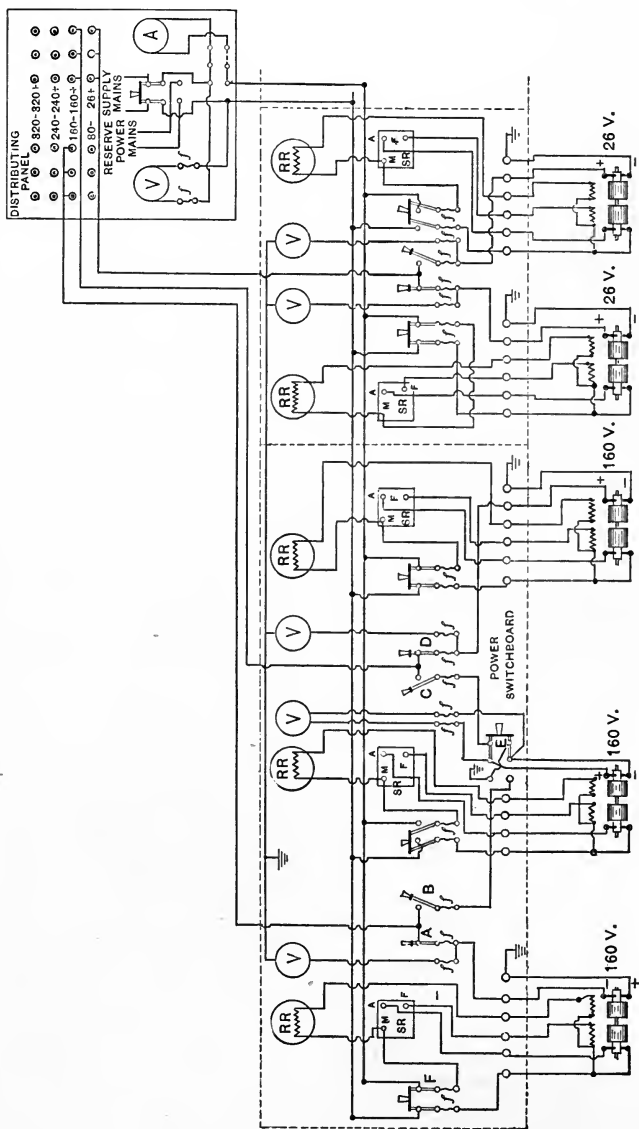

Fig. II.

started and brought up to proper voltage by means of its field-regulating rheostat *RR* and placed in parallel with its neighbor by throwing switch *E* to the left and closing switch *B*. Thereafter switches *A* and then *F* are opened. In the figure *V* and *A* indicate voltmeters and ammeters respectively, *f* indicates fuses and *SR* represents motor-starting rheostats with no-voltage release, the terminals marked *M*, *A* and *F* connecting with the service main, motor armature and motor field respectively. The generator leads go to a distributing panel which provides convenient means for distributing the proper current to the various classes of circuits. This panel also includes the main service switch and instruments.

Switchboards for motor-generators, having alternating-current single-phase, two-phase or three-phase motors, differ slightly from the board described in that different starting devices and motor switches are employed.

### TRAFFIC

**7. Types of Messages.** — Messages for telegraphic transmission may be written in plain language, be expressed in code words, or be couched in cipher. Code words are actual or artificial pronounceable words having not more than 10 letters. The object of employing code words is the saving of telegraph tolls, inasmuch as a single word is given a meaning expressible in plain language only by several words or even a sentence. A few code words with their interpretation according to the Western Union Travelers' code are given below:

ALLAH	Arrived all right, address letters to care of . . . . .
BALMY	Are very busy. Please return soon as possible.
BRING	There is no occasion for alarm.
COVER	Can you send me letter of introduction to . . . . .?

- ENTER Arrangements are progressing satisfactorily.
- LUNAR I (or . . . . .) do not wish to take responsibility for deciding.  
You (or . . . . .) know all the circumstances and must  
decide what shall be done.
- PEGGY Market very strong. Prices have advanced since last  
advice.
- PUNCH Please accept my heartiest congratulations.
- SPIKE Have sent telegraphic money order as requested.
- SCORN We wish you all a Happy New Year.

Cipher messages are used solely for secrecy. Such messages consist of unpronounceable groups of letters or of groups of figures, or both. They can be read only by the sender and recipient, in accordance with some pre-arranged scheme. Considerable time is necessary for couching and deciphering such cipher messages. As an illustration, the Confederate cipher used during the Civil War will be cited, the keywords employed by the Confederates being "Complete Victory," "Manchester Bluff" and later "Interest." The cipher is made up by giving numbers to the letters of the alphabet as below:

a	b	c	d	e	f	g	h	i	j	k	l	m	n	o	p	q	r	s	t	u	v	w	x	y	z
1	2	3	4	5	6	7	8	9	10	11	12	13	14	15	16	17	18	19	20	21	22	23	24	25	26
27	28	29	30	31	32	33	34	35	36	37	38	39	40	41	42	43	44	45	46	47	48	49	50	51	52

To write a cipher message add the respective numbers corresponding to the letters of the keyword and of the message (letter for letter, repeating the keyword if necessary), subtract the *index number* 1, and the corresponding letters will yield the cipher message. Thus to write "Reach Richmond to-day," using the keyword "Interest," proceed as below:

	R	E	A	C	H	R	I	C	H	M	O	N	D	T	O	D	A	Y	(message)
	18	5	1	3	8	18	9	3	8	13	15	14	4	20	15	4	1	25	
	I	N	T	E	R	E	S	T	I	N	T	E	R	E	S	T	I	N	(keyword)
	9	14	20	5	18	5	19	20	9	14	20	5	18	5	19	20	9	14	
Sum minus one	26	18	20	7	25	22	27	22	16	26	34	18	21	24	33	23	9	38	
	Z	R	T	G	Y	V	A	V	P	Z	H	R	U	X	G	W	I	L	(cipher)

The last line is the appropriate cipher message.

To decipher a message according to this cipher, subtract numbers corresponding to keyword from number corresponding to cipher (letter for letter), add the index number 1, and the corresponding letters will yield the message. By varying this scheme and using different keywords, an infinite variety of cipher codes may be developed. The characters of cipher words are transmitted with double spacing as a safeguard for avoiding errors.

**8. Classes of Service and Tariffs.** — Several classes of telegraph service are rendered by the large telegraph companies. The overland services offered by the Postal and Western Union Companies are: *telegrams* and *night letters*; the latter company also offers *day letters*.

Present rates (1914) for commercial telegrams from New York City to the capitals of the states and territories in the United States and of some of the provinces in the Dominion of Canada, are given in the table on the following page, which includes also the rates to Mexico City and Dawson City, Yukon. Day rates apply to messages intended for immediate delivery whereas night rates apply to telegrams for delivery the following morning. The number before the dash is the rate in cents for telegrams of 10 words or less (address and one signature free), and the number following the dash is the charge for each additional word.

Night letters containing 50 words (or less) may be sent at the 10-word day message rate, one-fifth of this rate being charged for each additional group of 10 words; and day letters of 50 words (or less) may be sent at  $1\frac{1}{2}$  times the night letter rate. Day letters are forwarded as promptly as the facilities of the company permit only in subordination to the full-paid telegrams, and night letters are trans-

City	Rates		City	Rates	
	Day	Night		Day	Night
Montgomery, Ala.....	60-4	50-3	Carson City, Nev.....	100-7	100-7
Juneau, Alaska.....	260-23	260-23	Fredericton, N. B.....	50-3	40-3
Phoenix, Ariz.....	100-7	100-7	Concord, N. H.....	35-2	25-1
Little Rock, Ark.....	60-4	50-3	Trenton, N. J.....	25-2	25-1
Victoria, Brit. Col.....	100-7	100-7	Santa Fe, N. Mex.....	75-5	60-4
Sacramento, Cal.....	100-7	100-7	Albany, N. Y.....	25-2	25-1
Denver, Col.....	75-5	60-4	Raleigh, N. C.....	50-3	40-3
Hartford, Conn.....	25-2	25-1	Bismarck, N. Dak.....	75-5	60-4
Dover, Del.....	30-2	25-1	Halifax, N. S.....	50-3	40-3
Washington, D. C.....	30-2	25-1	Columbus, Ohio.....	40-3	30-2
(National capitol)			Oklahoma City, Okla...	75-5	60-4
Tallahassee, Fla.....	60-4	50-3	Ottawa, Ont.....	50-3	40-3
Atlanta, Ga.....	60-4	50-3	(Capitol of Dominion)		
Boise, Id.....	100-7	100-7	Toronto, Ont.....	50-3	40-3
Springfield, Ill.....	50-3	40-3	Salem, Ore.....	100-7	100-7
Indianapolis, Ind.....	50-3	40-3	Harrisburg, Pa.....	30-2	25-1
Des Moines, Ia.....	60-4	50-3	Charlottetown, P. E. I...	75-5	65-5
Topeka, Kan.....	60-4	50-3	Quebec, Quebec.....	50-3	40-3
Frankfort, Ky.....	50-3	40-3	Providence, R. I.....	30-2	25-1
Baton Rouge, La.....	60-4	50-3	Columbia, S. C.....	60-4	50-3
Augusta, Me.....	40-3	30-2	Pierre, S. Dak.....	75-5	60-4
Winnipeg, Manitoba.....	75-5	60-4	Nashville, Tenn.....	50-3	40-3
Annapolis, Md.....	30-2	25-1	Austin, Tex.....	75-5	60-4
Boston, Mass.....	30-2	25-1	Salt Lake City, Utah....	75-5	60-4
Mexico City, Mexico.....	175-12	175-12	Montpelier, Vt.....	35-2	25-1
Lansing, Mich.....	50-3	40-3	Richmond, Va.....	40-3	30-2
St. Paul, Minn.....	60-4	50-3	Olympia, Wash.....	100-7	100-7
Jackson, Miss.....	60-4	50-3	Charlestown, W. Va.....	40-3	30-2
Jefferson City, Mo.....	60-4	50-3	Madison, Wis.....	60-4	50-3
Helena, Mont.....	75-5	60-4	Cheyenne, Wyo.....	75-5	60-4
Lincoln, Neb.....	60-4	50-3	Dawson City, Yukon...	425-20	425-20

mitted sometime during the night at the convenience of the company and are delivered the following morning. Such deferred service is offered at attractive rates in order to keep the equipment effectively busy at all hours, or in other words, to keep up the *load factor* of the equipment.

Day and night letters must be written in plain English and must not contain code words. The letters BLUE, NL or NITE are prefixed to a message and transmitted to inform the receiving operator as to the class of service desired, whether day letters, night letters or night-rate telegrams respectively. The indication DH (representing dead head) is used on unpaid messages for company matters, etc. When a group of messages of one class is transmitted,

a single indication on the first message of a group suffices for successive messages until a different indication is received.

A message blank bearing a message for transmission should contain the following information:

ITEM No.	ITEM	BY WHOM WRITTEN
1	Originating city	} Sender or telegraph clerk.
2	Date	
3	Addressee (name and address)	
4	Message	
5	Signature	
6	Indication as to class of service (Different blanks are used for the various classes.)	
7	Telegraph clerk's number	} Telegraph clerk.
8	Time of filing	
9	Check of number of words	
10	Wire number	} Sending operator.
11	Office call letter at destination	
12	Sending operator's sign	
13	Time of transmission	
14	Receiving operator's sign	

The first six, the ninth, tenth, thirteenth and fourteenth items as well as the call-letter of the originating office are transmitted and appear upon the received message blank that is delivered to the addressee. If a reply is to be prepaid the letters RP followed by the number of words prepaid are transmitted and also appear upon sending and receiving message blanks.

**9. Handling of Traffic.** — The methods employed in handling commercial telegraphic traffic depends largely upon the volume of incoming and outgoing traffic. In a large center the handling of this traffic at the main office must be fully systematized in order to facilitate prompt

transmission and delivery of messages. Somewhat different methods of handling traffic are naturally employed at different places; that used in a large city will here be outlined.

The telegraphic stations of a city for the reception and transmission of messages comprise a main office and many branch offices distributed throughout the city. The Western Union Telegraph Company has about 200 branch offices in New York City. Messages for transmission may reach these branch offices either by submission in person or by representative, or may be collected by messenger upon call, no charge being made for this service. Messages may also be telephoned from telephone subscribers' stations to the main office by requesting the telephone operator for "Western Union" or for "Postal," and upon connection, dictating the message to the answering telegraph clerk. The tolls for a message so sent will either be collected upon delivery or will be charged to the sender on his telephone bill. Messages received at branch offices are sent to the main office in two ways: the blanks may be carried by pneumatic tube carriers from those offices that are connected with the main office by such tubes, or else the message is telegraphed to the main office.

The messages arriving at the main office for telegraphic transmission are sorted at a central distributing place or routing room and are distributed by mechanical carriers to division stations, each division being a portion of the operating floor seating operators who transmit on lines terminating in some geographical division of the country. Check boys or girls carry the message blanks from the division stations to the proper operators. After the operators have transmitted a message, they indorse the blank

(by inscribing items 10-14 of the scheme given in foregoing section) and place it in a message clip. Check boys pass up and down the aisles and remove the blanks from the clips and take them to the division stations from whence they are carried mechanically to a searching room. Here the blanks are examined as to the indorsement and are filed away and preserved for a reasonable length of time.

Incoming messages are typewritten upon suitable blanks by the receiving operators or are automatically printed by the printing telegraphs. These incoming messages are carried by check boys and mechanical carriers to the routing room, where they are sorted. Such messages requiring retransmission are carried to the proper sending operator in the same way as originating messages. The remaining messages are for local distribution within the city confines. These city messages are sorted and may be telephoned directly to the addressee if he be a telephone subscriber, or else sent to his nearest branch office either by pneumatic tube or by wire, and from there delivered by messenger to the addressee.

The traffic manager at a large telegraph office is kept constantly informed regarding the amount of traffic over the various interurban and important lines, so that if necessary he may alter the customary routing of messages in order that telegraphic business at all centers may be adequately disposed of with the available existing facilities. Thus, if an unusual amount of traffic has accumulated at Philadelphia for transmission to Chicago via New York, and if the traffic from Philadelphia to Boston, and from Boston to Chicago is light, the traffic manager would direct the operators at Philadelphia to send some of the messages to Chicago via Boston. In the event of severe



storms felling pole-lines between important centers, the traffic manager endeavors to re-establish service between these points over another route even if very circuitous.

Records of the amounts of traffic accommodated on the various line circuits are kept for the information of telegraph engineers who determine the necessity for additional lines and equipment or suggest rearrangements of existing facilities for improving the service.

**10. The Telegraph in Railway Operation.** — The handling of steam trains in accordance with telegraphic orders began in 1851, and since that time has been rapidly extended to all railroad systems. Since 1907 the telephone is also used in train dispatching and in the directing of train movements; at present, about 70,000 miles of railroad in this country are telephonically handled.

A large majority of all telegraph offices in the United States are located in railway stations, and large amounts of commercial and especially railway telegraph traffic are handled through them. Railway telegraph traffic may deal with inter-departmental business or with train movements, the latter traffic being usually urgent and requiring immediate attention. Such traffic on a railroad division includes the progress of passenger and freight trains, attendance to emergencies as they arise, information on the location of rolling stock, messages concerning shipments, and so on.

The use of the telegraph for issuing and receiving such information generally requires two local single-wire circuits linking the principal office of the division with its various local offices. One of these circuits, termed the *train wire*, is used by the train dispatcher, and the other, termed the

*message wire*, is used for transmission of commercial and railway telegrams. On unimportant branch roads both services are sometimes handled over a single circuit, whereas on long or busy railway divisions the more important offices may be connected to a special circuit to relieve congestion of traffic on the other circuits. Between the principal division offices of a system and the general offices or administrative center of the railroad are a series of circuits, which may be operated simplex, duplex or quadruplex, with or without repeaters, as the traffic or length of the circuit may warrant. Thus, an idea of the extent of the telegraph circuits of the Northern Pacific system (which operates over 6000 miles of main-line track) may be gained from the following list of principal circuits now operated out of the St. Paul, Minn., general office. This list, given by M. H. Clapp, does not include some local circuits operating out of St. Paul to points in the direct vicinity of the Twin Cities. There are four repeating stations on the St. Paul-Tacoma line, at which traffic is also relayed to different offices to which direct wires are not provided.

Circuit from St. Paul to	Circuit operated	Distance in miles
Tacoma, Wash.....	Quadruplex	1900
Missoula, Mont.....	"	1250
Spokane and Pasco, Wash.....	"	1650
Helena, Mont.....	"	1130
Billings and Livingston, Mont.....	"	1008
Dickinson, N. D., and Glendive, Mont.....	"	667
Fargo, N. D., and Dilworth, Minn.....	"	252
Duluth, Minn.....	Duplex	152
Winnipeg, Man. — Local 32 offices.....	Simplex	483
Fargo, N. D. — Local 41 offices.....	"	252
Duluth, Minn. — Local 40 offices.....	"	152
St. Paul Division. — Local 30 offices..	"	170

**II. Telegraph Statistics.** — The United States censuses of electrical industries show the following statistics of the domestic telegraph industry in the years 1880, 1902, 1907 and 1912:

## COMMERCIAL LAND AND OCEAN TELEGRAPH SYSTEMS

	1880	1902	1907	1912
Number of companies or systems.....	77	25	25	27
Nautical miles of ocean cable..	(a)	16,677	46,301	67,676
Miles of single wire owned and leased.....	291,213	1,318,350 (b)	1,577,961	1,814,196 (c)
Number of messages.....	31,703,181 (d)	91,655,287	103,794,076	109,377,698
Number of telegraph offices.....	12,510	27,377	29,056	30,864
Dollars total income.....	16,696,623	40,930,038	51,583,868	64,762,843
Average number of employees (e)	14,928	27,627	28,034 (f)	37,295
Employees salaries and wages (dollars) (g).....	4,886,128	15,039,673	17,808,249	24,964,994

(a) Not separately reported.

(b) Includes miles of wire operated by W. U. Tel. Co. outside of the United States.

(c) Exclusive of 314,329 miles of wire wholly owned and operated by railway companies for their own business.

(d) For 54 companies out of 77.

(e) Does not include railway operators also doing work for telegraph companies.

(f) For 23 companies out of 25.

(g) Two companies in 1907 and one in 1902 did not separate salaries and wages from operation expense. The wages of persons enumerated above spending a part of their time in telegraph service are those received for telegraphic service only.

The large decrease in the number of separate companies from 1880 to 1902 was due to numerous consolidations of formerly competing companies. Far more than one-half of the number of telegraph offices tabulated are located in railway stations, and these offices are not used exclusively for the transmission of messages for the general public.

The extent to which the telegraph industry is controlled by a few companies is indicated by the fact that the six largest companies reported 99 and 97.7 per cent of the total tabulated income in the years 1902 and 1907, respectively.

The 1907 census also shows that 625 railway companies in the United States, operating 225,059 miles of single track, owned 383,833 and leased 423,991 miles of telegraph wire, and sent 258,589,333 telegraph messages for railroad business during the year.

Comparative telegraphic statistics of various countries selected from Senate Document No. 399, dated 1914, for the year 1910 (except where otherwise stated) are tabulated below:

TELEGRAPH STATISTICS OF DIFFERENT NATIONS

Country	Population	Annual telegrams per capita	Average receipt per domestic telegram in cents	Telegraph offices	Miles of telegraph wire
				Per 10,000 of population	
Austria.....	28,571,934	0.73	22.4	1.58	50
Belgium.....	7,074,910	1.25	14.2	2.31	36
Denmark.....	2,585,660	1.31	14.0	2.17	34
France.....	38,961,945	1.65	12.1	5.21	108
Germany.....	63,886,000	0.92	18.0	7.06	175
Great Britain.....	41,976,827	2.18	17.2	3.33	135
Hungary.....	20,886,487	0.59	25.1	2.20	42
Italy.....	32,475,253	0.55	19.3 (a)	2.36	38
Japan.....	49,732,952	0.60	12.3	0.86	20
Luxemburg (1905)...	246,455	0.84	9.0	13.16	29
Netherlands.....	5,591,701	1.19	15.0	2.49	40
New Zealand.....	1,062,792	8.09	15.7	18.51	357
Norway.....	2,240,032	1.48	13.4 (a)	7.08	142
Russia.....	152,009,300	0.24	42.0	0.55	28
Sweden.....	5,294,885	0.80	15.3	5.39	37
Switzerland.....	3,315,443	1.75	17.2	7.13	48
United States (1912)					
(b).....	95,410,503	1.09	45.0	3.42	190

(a) Minimum message rate.

(b) Statistics computed from preliminary report on Land Telegraph Stations: 1912, issued Feb., 1914.

It will be observed that of the countries tabulated, the average cost per telegram is least in Luxemburg and most in the United States, and that the yearly telegrams per individual is most in New Zealand and least in Russia.

## PROBLEMS

1. How are the two lines passing through a four-strap peg switch panel (see Fig. 1) interconnected at this panel without introducing intermediate receiving instruments into either line?

2. How may a simplex line having three loops at the main switchboard give service to three additional subscribers or brokers' offices?

3. Show the connections at one end of a duplex line through the main and loop switchboards and through the distributing frame, when the operators are stationed at an office some distance away from the main telegraph office. (Refer to circuit I of Fig. 4, circuit G of Fig. 6 and Fig. 16 of Chap. II.)

4. How may the duplex line of the preceding problem be temporarily assigned to some other branch telegraph office?

5. Using the Confederate cipher, the key word "Manchester Bluff," and the index number 1, decipher: YCPNLPDTRTPXCSL.

## CHAPTER VI

### MISCELLANEOUS TELEGRAPHS

1. **Multiplex Telegraph Systems.** — Multiplex telegraphy means the simultaneous transmission, without interference, of a plurality of messages in either or both directions, over a single line. The duplex, quadruplex, duplex-diplex and phantoplex systems already described and also the alternating-current systems of Picard and Mercadier may be considered multiplex systems, but in practice this name is applied to those systems utilizing synchronous rotation of contact *distributors* located at the two terminal stations. Inasmuch as the maximum speed of hand transmission is only about 40 words per minute, it is evident that the speed possibilities of telegraph lines even with short cable sections are not being utilized. With the automatic telegraph the lines are more effectively used, for speeds of 250 to 400 words per minute in each direction are maintained. Multiplex telegraphs also conduce to better utilization of the lines and permit of signalling at rates up to about 200 words per minute in each direction.

In the Delany multiplex system the line is successively assigned for short intervals to several pairs of operators by means of synchronously revolving distributors, the intervals being so short that during the hand transmission of a dot signal by one operator, he has exclusive momentary use of the line several times. Thus, if one pair of operators receive the line 36 times per second and assum-

ing the average word to have the equivalent of 18 dots, signalling at the rate of 40 words per minute indicates 3 contacts per dot. Between these contacts the line is periodically assigned to about five other pairs of operators. Thus, each telegraphic character is made up of short impulses rather widely separated as compared with their duration. Such signals are rendered intelligible when transmitted by pole-changing keys and received by polarized relays, as in the polar or bridge-duplex systems.

The Delany system, adapted for hand signalling, was used for a number of years but has gradually given way to the more accurate printing multiplex systems. The Rowland multiplex page-printing telegraph, which affords octuplex signalling as a quadruple duplex, was for a time used on some circuits of the Postal Telegraph-Cable Company and is now being further improved. The Baudot tape-printing and the Murray page-printing multiplex systems are at present considerably used abroad, being operated as double or quadruple duplex systems. The Murray multiplex (§ 2) has also begun its operation in this country, affording a speed of 40 words per minute in each of eight channels over a single wire between two cities 250 miles apart. A quicker telegraph service is possible with multiplex printing telegraphs than with ordinary automatic transmission because of the direct printing of the received messages.

**2. The Murray Multiplex Page-printing Telegraph.** — The principal instruments used in the Murray multiplex telegraph are keyboard tape perforators, automatic transmitters, distributors and electromagnetically-operated printers.

The tapes are perforated according to a special 5-unit code, the units for each letter, figure or other character being arranged transversely to the tape. The alphabet perforations are shown in Fig. 1 to correct size, the letters being separated by the space character which consists of one perforation immediately below the guide hole. The tape passes directly through a constant-speed automatic transmitter, patterned after the Wheatstone transmitter, and is then wound in rolls by an automatic tape-winder. The transmitter is provided with a starting and stopping

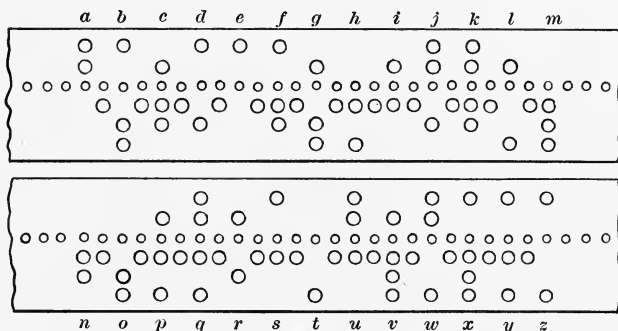

Fig. 1.

lever for use in case the transmitter overtakes the performing operator.

The function of the distributors is evident from Fig. 2, wherein a single line provides four channels of communication in either direction by means of the distributor arms  $D$  and  $D'$ , sweeping over the contacts  $a$ ,  $b$ ,  $c$  and  $d$  at stations A and B respectively. By joining duplex terminal apparatus to the contact points at both ends of the line quadruple duplex or octuplex signalling is rendered possible. Only one artificial line is used at each station. The contacts are preferably multiplied so that a distributor arm con-



nects with one duplex set several times in one revolution, thereby reducing the rotational speed of these arms.

It is absolutely essential that both contact arms occupy the same relative positions at all times, that is, they must rotate synchronously. Such rotation is secured by the

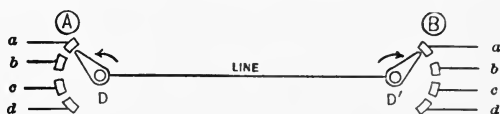

Fig. 2.

use of manually-started motors having tooth-wheel iron armatures and periodically excited field magnets, the contact arms being mounted directly on the motor shaft. Periodic field excitation is obtained by the use of reeds which are kept vibrating at their natural frequency. To maintain synchronism the distributor at one station sends

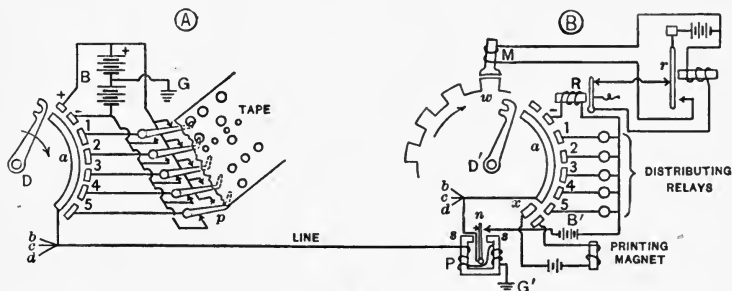

Fig. 3.

to that at the other station one or more governing impulses during each revolution of the arm, which impulses control the speed of the distant motor.

The circuit arrangements for securing synchronous rotation of the distributors and for signalling over one of the communicating channels are schematically shown in Fig. 3,

the groups of contacts for the other channels (that is, the return over  $a$  and duplex over  $b$ ,  $c$  and  $d$  of Fig. 2), as well as the vibrating reed and distributor motor at station A, being omitted for the sake of clearness. The toothed wheel  $w$  of the distributor motor, when once set in rotation, will advance one tooth every time the vibrating reed  $r$  makes one complete vibration due to the impulsive currents reaching the magnet  $M$  every time the reed touches its front contact. The reed is kept in vibration electromagnetically in the usual manner, that at station B being adjusted to operate one or two per cent faster than that at A. Thus if distributor arm  $D'$  reaches the contact marked  $-$  while the other arm  $D$  is still on the contact marked  $+$ , a current pulse from battery  $B$  will flow over the line and through the polarized relay  $P$  in such direction as to close the contact of this relay. This momentary contact enables battery  $B'$  to actuate the governing relay  $R$  and open the vibrator circuit for an instant, thereby retarding slightly the vibration of the reed and the rotation of the distributor arm  $D'$ . If both arms were to pass over the  $-$  contacts simultaneously, the contact of the polarized relay would be open and no governing impulse would reach relay  $R$ .

Thereafter, the two distributor arms pass together successively over the main contacts 1, 2, 3, 4 and 5, and then over similar sets of contacts for the other transmitting channels (not shown). The polarity of the five current pulses sent out upon the line at station A depends upon the positions of the rocking pins which, in turn, depend upon the tape perforations, as in the Wheatstone transmitter, the various permutations of positive and negative pulses corresponding to the various letters and other characters to

be transmitted. At station B the five main contacts are connected to an equal number of distributing relays which select the particular printer magnets in a manner very similar to that explained with the aid of Fig. 16 of Chap. IV. As the contact arm passes over the contact  $x$ , the printing magnet is energized, causing the printing on the receiver message blank of that letter whose printer magnet was selected by the distributing relays.

From the foregoing it will be understood how this method of signalling can be extended to give quadruple-duplex or possibly even sextuple-duplex transmission over a single-line wire, the received characters over each communicating channel being directly printed. Messages requiring retransmission to remote places may be directly perforated in tapes at the intermediate station, the five magnets that set the punches of the receiving perforator being connected in series with the corresponding distributing relays of the printer.

**3. The Pollak-Virag Writing Telegraph.** — The Pollak-Virag rapid telegraph system has been installed on a number of European telegraph lines and affords signalling at rates up to 700 words per minute over two-wire lines.

Tape transmission is utilized in the Pollak-Virag writing telegraph, the perforations for the various characters being of various sizes and located in one or more of six rows. The paper tape is prepared on a keyboard perforator, all the perforations for a letter or other character being made by a single depression of a key. The tape is passed over a motor-driven drum  $D$ , Fig. 4, which is formed of six electrically-distinct rings. Two brushes,  $b$  and  $b'$ , each spanning three rings, press the tape against the drum and

make contact with its rings through the perforations, the duration of contact depending upon the size of the perforation. Rings 1, 2 and 3 connect to battery *B* so that brush *b* and the upper line wire may have a potential with respect to the other line wire of say + 50, + 30 or - 30 volts respectively. Similarly, rings 4, 5 and 6 connect to battery *B'* so that brush *b'* and junction *x* may have a potential with respect to ground of say + 30, - 30 and - 50 volts respectively. Combinations of contacts of different durations and in correct sequence with these six rings occasion current pulses in the line which actuate a

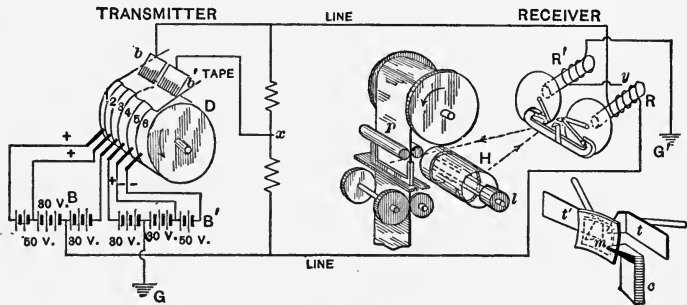

Fig. 4.

specially-designed receiver to produce in script the various letters and figures.

The receiving instrument resembles two telephone receivers (*R* and *R'*, Fig. 4) whose diaphragms are placed in one plane. In front of the diaphragms is mounted a permanent magnet, from the center and ends of which project soft iron strips with forwardly-extending pointed tips. A small soft iron sheet carrying the mirror *m* (shown in the lower right corner) is magnetically held against the three tips. The motions of the two diaphragms of re-

ceivers  $R$  and  $R'$  are transmitted by means of links to the tips  $t$  and  $t'$  respectively, which are located 1 mm. above and to the left of the center tip  $c$  respectively. Therefore, if the diaphragm of receiver  $R$  vibrates the mirror will rotate about a horizontal axis, and if the other diaphragm vibrates the mirror will rotate about a vertical axis. If both vibrate, the mirror will describe the motion of the resultant vibration.

A small pencil of light issuing from an electric light  $l$  impinges upon the mirror and is reflected as a spot of light upon a band of photographic paper  $p$ . A revolving opaque hood  $H$  having a helical slit encloses the lamp so that the spot of light will advance from one side of the paper to the other, and then jump to the next line, and so on. If the mirror vibrates in accordance with transmitted impulses, its motions will be properly recorded. After exposure, the sensitive paper travels down through solutions which develop and fix the paper in about 15 seconds, revealing legible script.

The two-line wires join with the terminals of the winding of receiver  $R$ , which is actuated by portions of the battery  $B$ , this receiver forming all vertical components of the transmitted characters. Both line wires are used as a single conductor for the other receiver circuit by means of the neutral points  $x$ , formed by a high-resistance shunt at the transmitter, and  $y$ , the mid-point of the winding of receiver  $R$ . In this way battery  $B'$  actuates receiver  $R'$  (ground being the return path), this receiver forming all horizontal components of the characters. In order to abolish the disturbing influences of resistance, inductance and capacity when signalling over long lines, various condensers and reactors may be introduced at particular places

in the circuit. Condensers connected in parallel with the receivers  $R$  and  $R'$  are introduced to soften the action of the currents. Synchronous rotation of the hood at the receiver and the drum at the transmitter is not necessary in this system.

The nature of the perforations and the corresponding received script is indicated in Fig. 5 for the word "message." The direction and relative magnitudes of the impressed voltages are indicated at the left, and the received graph for only the vertical components is shown immediately

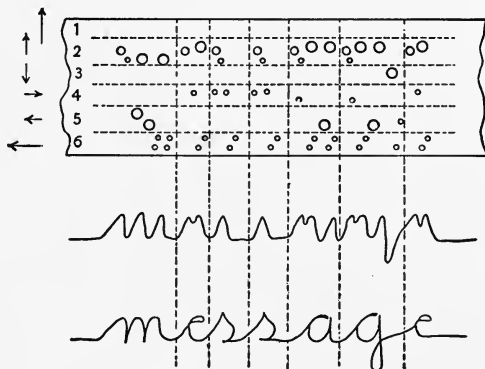

Fig. 5.

below the tape. The actual received trace, which corresponds to both vertical and horizontal movements, is shown at the bottom.

**4. The Telautograph.** — The telautograph is an instrument for the electrical reproduction of handwriting at a distance, invented by Prof. Elisha Gray and perfected by Geo. S. Tiffany, and consists of a transmitter and a receiver. The appearance of the instrument made by the Gray National Telautograph Company is shown in Fig. 6. These

devices may be operated singly over a private line or connected through a switchboard so as to enable any two instruments to be used together. Also, a single transmitter may be arranged to operate a number of receivers simultaneously.

At the transmitter the pencil is attached by a system of levers to two contact rollers which bear against the inner

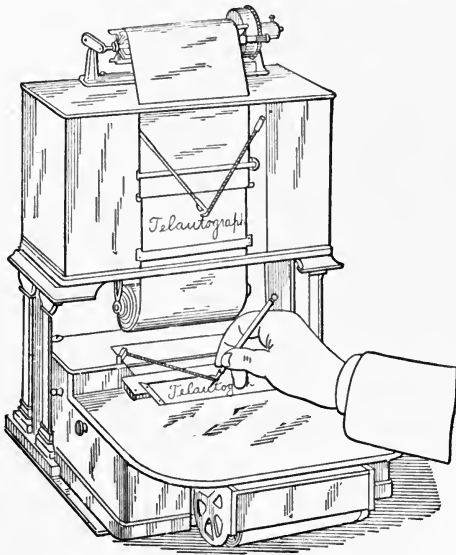

Fig. 6.

surfaces of two curved rheostats, which are connected across direct-current supply mains, usually of 115 volts. The potential difference between either end of each rheostat and the accompanying roller varies with the position of this roller, which position changes in writing. These varying voltages are impressed on circuits which extend to the

receiver, where they terminate in coils wound on copper bobbins and arranged to move horizontally within intense magnetic fields against the action of springs. In operation the two coils are displaced in proportion to the forces acting on them, which forces are proportional to the currents traversing the coils, which currents vary with the impressed voltages, and which, in turn, depend upon the displacements of the transmitting rollers from their zero positions, thereby rendering the displacement of each coil proportional to that of the corresponding roller. The coils at the receiver are connected by a system of levers which actuates the recording pen, the lever system being similar to that at the transmitter. Thus, the motion of the pen is the resultant of the motions of the two coils, which motions are proportional to those of the transmitting contact rollers, and they are the component motions of the transmitting pencil; therefore, the receiving pen duplicates the motions of the transmitting pencil.

The simplified scheme of connections of the improved transmitter and receiver is shown in Fig. 7, which also

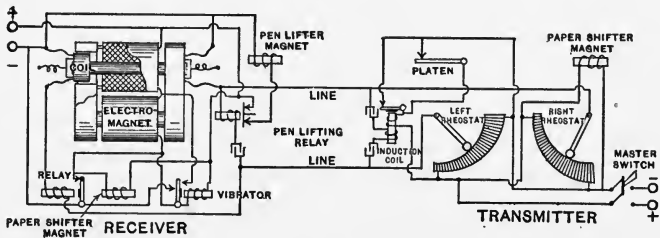

Fig. 7.

indicates the various auxiliary devices utilized in realizing commercial practicability. The apparatus used for the transmission of the writing motions is apparent, the left



and right rollers on the transmitter rheostats connecting directly with the two corresponding receiver coils that are located in separate annular air gaps of one magnetic circuit. The two pairs of power terminals connect to commercial electrical supply mains.

The functions of the auxiliary devices are as follows:— The master switch controls the paper shifter magnet which operates a clamp that pulls the paper through one line space over the transmitter platen. Shifting of the receiver paper is similarly accomplished, the shifting magnet being locally energized through the contacts of the relay which is included in one of the two line wires and which is likewise under the control of the master switch.

This relay also serves to complete the circuit of the electromagnet which develops the magnetic field for the receiver coils. It will be observed that the winding on the lower bobbin may be periodically short-circuited by the spring armature of a vibrator. This action causes the intensity of the magnetic field to flicker rapidly and produces a minute vibration in the receiver coils. Friction of the pen on the paper and in the moving parts of the receiver is greatly reduced by this vibration, and consequently the pen is very sensitive to small changes in the line currents. Although small alternating currents are induced in the coils by this vibratory motion, the pen-lifting relay bridged across the line wires will not operate, because of the equality of these opposing currents.

Pen lifting is accomplished at the receiver by means of a locally-operated magnet placed back of the receiver writing platen, the armature carrying a rod adapted to move the pen arms and lift the pen away from the paper when the magnet is energized. This pen-lifter magnet is

controlled by a pen-lifting relay that has a peculiarly constructed armature which is set into violent vibration and makes imperfect contact with its contacts points when alternating current passes through the relay winding, but which armature is quiescent and makes good contact with its contact points when no current traverses the winding. At the transmitter the secondary winding of a small induction coil is bridged across the line wires through two condensers, and the primary winding derives its energy from the power mains through a vibrating armature. A contact beneath the writing platen is arranged to short-circuit the vibrator when the platen is not depressed. Thus, during intervals when no characters are written no electromotive force is induced in the secondary winding of the coil, no current traverses the pen-lifting relay and consequently the circuit of the pen-lifter magnet is closed, thereby lifting the pen away from the paper. Depression of the platen by the transmitter pencil in writing, permits operation of the vibrator and occasions an alternating electromotive force in the secondary winding of the coil. This induced voltage develops a current that traverses the two-line wires simultaneously with the "writing" currents and also traverses the pen-lifting relay. The armature of this relay is thereby agitated so that the pen-lifter magnet is effectively open-circuited, and the release of its armature permits the receiving pen to touch the paper.

Ink for the receiving pen is contained in a small stoppered bottle with an orifice near the bottom, the ink being retained by atmospheric pressure. When the telautograph is idle, retractile springs hold the pen in the ink at this orifice. In order to close the master switch it is necessary to bring the transmitting pencil to a position corresponding

to that of the pen and to press the pencil on a button there located, thereby releasing a catch that holds the master switch. This process is repeated for each paper-shifting operation so that sudden large movements of the receiving pen are avoided.

5. **Telephotography.** — The electrical transmission of photographs from one place to another, called *telephotography*, may be accomplished by utilizing the property of the element selenium by virtue of which it varies its electrical resistance under the influence of light. The lowering of selenium resistance with increasing intensity of white light is shown in Fig. 8 for three different "cells," which are metallic

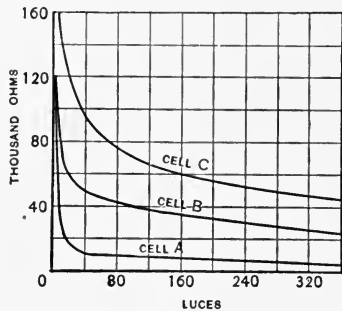

Fig. 8.

grids properly coated with selenium. Intensity of illumination is expressed in lucas (*sing.* lux), the lux being the intensity of light at one meter's distance from a standard candle. The resistance  $R$  of a cell under illumination  $I$  can be conveniently expressed as

$$R = \frac{c}{I^n}, \quad (1)$$

where  $c$  is a constant depending upon the selenium cell, and  $n$  is an exponent whose value depends upon the duration of exposure and wave-length of light, and lies between 0.25 and 1.0. The resistance change in selenium with light variation is not instantaneous, but most of this change

occurs during the first few instants, as indicated in Fig. 9, which represents a three minutes exposure of cell *B* to light of 100 lucas intensity, with subsequent recovery.

Dr. Korn has perfected telephotographic apparatus which is in successful practical operation over several long distance lines.

The complete apparatus for a station consists of a transmitter and a receiver mounted together, each having a long tube through which light from the lamps at one end, passes to the rotating cylinders at the other. The princi-

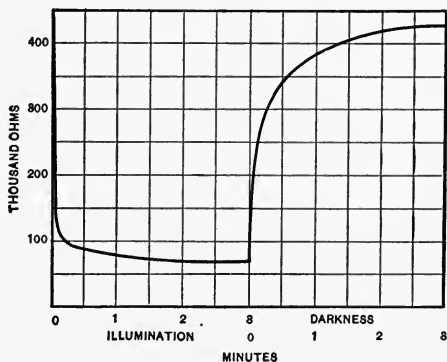

Fig. 9.

pal details of the improved Korn transmitter and receiver are shown in Figs. 10 and 11 respectively.

In the transmitter the Nernst lamp *L* sends out, through lens *A*, a beam of light which is received upon the diaphragm *g*, after passing through lens *G*. The diaphragm serves to concentrate the light to a point upon the glass cylinder, around which is placed the photograph in the shape of a positive film, the cylinder being mounted upon the rotating shaft *V*. The beam of light passes through the photographic film and is reflected upward within the

cylinder by the prism  $P$  and impinges upon the selenium cell  $S_1$ . The cylinder  $T$ , in addition to its rotary motion, has an axial movement, so that all parts of the photo-

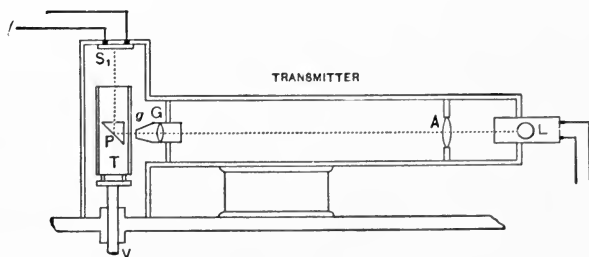

Fig. 10.

graph successively pass the point of light. As the cylinder revolves, the illumination on the selenium cell will change, thus sending a current of variable intensity to the receiver.

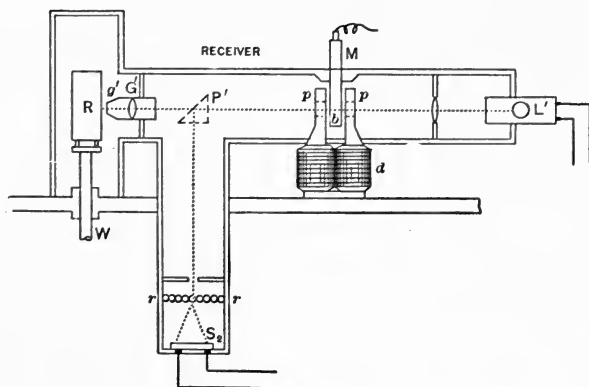

Fig. 11.

The receiver, Fig. 11, is provided with a Nernst lamp  $L'$  which sends out a beam of light through the galvanometer shutter  $b$ . This galvanometer, called a *light-relay*, consists of an electromagnet  $d$ , provided with long perforated

pole-pieces  $pp$ , between which is placed the moving element  $M$ . This consists of a double fine platinum wire under tension, carrying a small sheet of aluminium foil  $b$ . When a current flows through the wire, the electromagnet being separately excited, the aluminium sheet is deflected to one side and the amount of the deflection is proportional to the current flowing. Thus, the intensity of the beam of light which passes through the light-relay to the cylinder  $R$  depends upon the current in the line. The cylinder is mounted on a revolving shaft  $W$ , which has also an axial movement, so that all parts of the cylinder surface are brought successively under the point of light emerging from the diaphragm. Thus, the variable current coming from the transmitter causes a corresponding variation in the amount of light incident upon the receiving cylinder, and an exact reproduction of the original photograph may be obtained upon developing the received image.

It is necessary for the proper operation of this apparatus that the resistance change of the selenium cell be rapid so that it will respond almost immediately to the variations of light incident upon it. Such quick action is secured by the use of a second selenium cell connected with the cell of the transmitter, so that the resultant conductivity-time curve of both rises quickly at the start and falls quickly upon darkening the cell. As the receiver of a station is not in use when sending, the light-relay of the receiver can be employed in this connection, as shown in Fig. 11. In the bottom of the vertical mirror-lined chamber is the cell  $S_2$ , which receives illumination from the lamp  $L'$  by means of the reflecting prism  $P'$ . To secure a diffused light upon this selenium cell, a series of glass cylindrical rods is inter-

posed at  $r$ . When the transmitter cell  $S_1$ , Fig. 10, is illuminated, a current flows through the home light-relay deflecting its shield, and thus gives the compensating cell  $S_2$  a corresponding illumination. The two cells are connected in opposition, and the resulting current variation

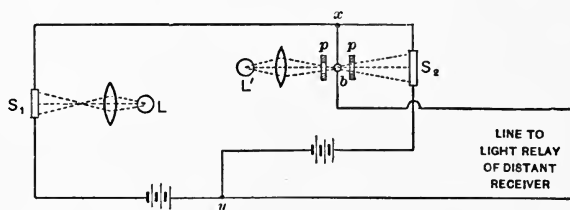

Fig. 12.

corresponds very closely with the variations of light, owing to the fact that the two cells are selected to give different resistance changes under the same illumination.

The method of connecting the selenium cells is shown in

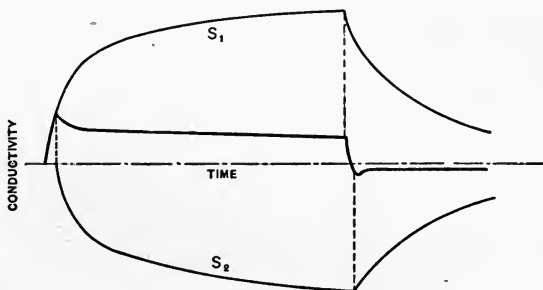

Fig. 13.

Fig. 12. The shape of the differential current which flows between  $x$  and  $y$  is shown in Fig. 13, in which the conductivity-time curve of each cell is indicated, one above and the other below the datum line. As cell  $S_2$  is not illuminated as soon as cell  $S_1$ , its curve will begin shortly

after that of the latter. As will be observed, the time of rise and decay of current are practically identical, and the rate of change is exceedingly rapid. The use of the compensating cell results in a considerable gain in photographic detail.

As the normal swing of the light-relay is from 0.01 to 0.02 second, a rapid variation of current is permissible, and the cylinder at the transmitting end can, therefore, be rotated very rapidly. At present a photograph 9 inches by 6 inches can be reproduced in less than 12 minutes, the size of the received image being 4 inches by  $2\frac{1}{2}$  inches.

It is obvious that the cylinder at the transmitting station and that at the receiving station must revolve at the same speed, otherwise, no image reproduction could be obtained. The speed of the receiving cylinder is adjusted to be about one per cent faster than that of the transmitter. The former is brought to a stop at the end of each revolution, and when the transmitter cylinder has finished its revolution, a current impulse of the reverse direction is sent to the receiving station actuating a relay there and releasing the cylinder. Both cylinders then start up together upon the next revolution.

A modification of the light-relay has lately been introduced by Korn, called a *step-relay*, for controlling weak high-frequency currents which serve to initiate high-tension arcs. The currents so started are either sent directly over the line to affect the receiver, or are used to furnish a perforated tape corresponding to the picture for affecting its transmission at suitable speed. He has also devised another transmitting method which dispenses with selenium cells and thereby permits of larger line currents. This method employs a photographically-prepared copper sheet upon which are formed parallel striations of gelatin in



greater or less widths depending upon the darkness or brightness of the various parts of the image to be transmitted. This sheet is placed around a metal cylinder, and as it revolves and also advances axially, a metal stylus traverses the striations and causes contact to be broken for long or short intervals in accordance with the width of the striations. The resulting intermittent currents pass through the light-relay at the receiver and reproduce the image as before.

Marino has developed a system of color telephotography which utilizes the sustained high-frequency electrical oscillations derived from three direct-current arcs that are shunted by condensers and inductances. These Thomson

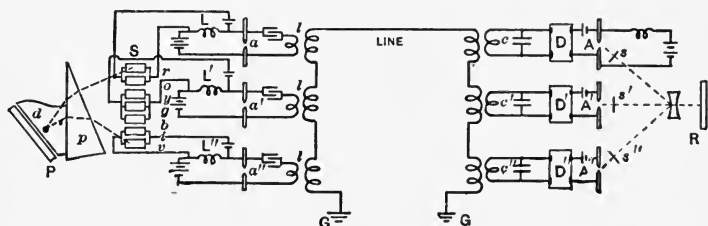

Fig. 14.

arcs are arranged to produce oscillations of different frequencies whose amplitudes are controlled by seven selenium cells, every cell being most sensitive to one of the seven primary colors. At the receiver these oscillations control other arcs connected in circuits that are tuned to the respective frequencies. The manner in which color variations are transmitted in this system is indicated in Fig. 14.

A long opaque diaphragm  $d$ , with properly placed apertures of about 1 mm. diameter, passes uniformly in front of an illuminated plate  $P$  bearing the picture to be transmitted. These apertures are spaced transversely about

1 mm. apart and longitudinally a distance equal to the width of the plate, therefore light from every point of the picture, after passing through a lens, falls successively on the prism  $p$ . Each ray is dispersed by the prism, and impinges upon the set of selenium cells  $S$  located so that each cell receives light of one color, thereby actuating one or more of the cells according to its constituent colors. These cells are in three groups, each group with a battery being bridged across the inductance ( $L, L'$  or  $L''$ ) connected in the supply circuit of the arc ( $a, a'$  or  $a''$ ). Variations in the resistances of the selenium cells modulate the voltages across the arcs and consequently affect the amplitudes of the oscillations that are developed in the three condensive circuits. These oscillations induce corresponding currents in the line coils  $l$ , and are superimposed upon each other to form the line current.

At the receiver the three component oscillations of the line current are sorted out by means of the tuned oscillatory circuits  $c, c'$  and  $c''$ , and are rectified by audion or crystal detectors  $D, D'$  and  $D''$ . The detectors vary the potential difference of the three receiving arcs  $A, A'$  and  $A''$ , and consequently vary their brilliancy. In front of the arcs are colored screens —  $s$ , a mixture of red and orange;  $s'$ , a mixture of yellow, green and blue; and  $s''$ , a mixture of indigo and violet — the emitted rays from all three arcs being recombined and focussed upon a particular point of the receiving plate  $R$ . Each resulting beam is therefore rendered identical in color variations and intensity with the original.

**6. Television.** — The property of selenium of varying its resistance under the influence of light is also utilized

in experiments to attain a practical method of seeing at a great distance by means of a connecting wire or wires. Numerous such systems of television have been patented; indeed elementary geometrical patterns have been successfully transmitted by Ruhmer between Brussels and Liege, a distance of 72 miles, his transmitter consisting of 25 selenium cells, each about 5 centimeters square.

Rignoux and Fournier have developed a system of television, involving the employment of a multitude of cells but employing only two connecting wires between the stations. The currents from the various circuits are taken successively by a rapidly rotating collector arm at

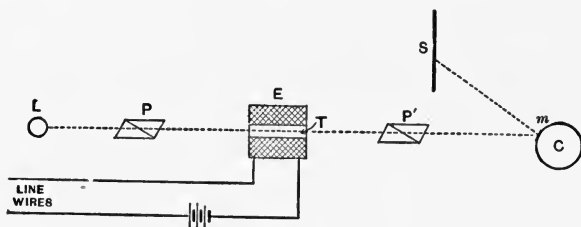

Fig. 15.

the transmitting station and supplied to the two-line wires. The principle of the receiving device is based upon the Faraday effect. The arrangement of the apparatus at this station is shown in Fig. 15, in which *L* is a source of light whose rays are polarized by the prism *P* and then traverse a tube *T* containing water, or better, carbon bisulphide. A second Nicol prism *P'* is so rotated about the direction of the light ray as an axis that the polarized light cannot pass through it, and is then fixed in this position. If a current flows through the electromagnet *E* which surrounds the tube filled with liquid, the angle of polarization changes and the prism *P'* no longer prevents

the light from passing through it. Thus, a beam of light of varying intensity, corresponding to the illumination of the particular selenium cell connected at that instant with the line wires, falls upon the cylinder *C*, which rotates in synchronism with the collector arm at the transmitting station. This cylinder carries a number of small mirrors *m*, which are so arranged that the light reflected from each falls on a particular part of the screen *S*. On this screen is therefore formed a picture, consisting of patches of various degrees of brightness, of the object exposed at the transmitter. The different parts of the picture, although projected successively, will appear simultaneous, if the entire picture is produced within a fraction of a second. An indefinite repetition of this process yields a persistent picture.

In Low's system of television the received currents magnetically control the positions of slots which admit light to squares on the receiving screen that are located in the same positions as the corresponding selenium cells at the transmitter.

**7. Military Induction Telegraphs.**—In times of war crudely-constructed pole lines and often short lines of bare wire laid on the ground are utilized in the telegraphic transmission of military information. Because of the low insulation resistance of such lines, and because of the difficulty of transporting means for the production of electricity, the ordinary simplex signalling methods are not used, but, instead, signalling by means of induced currents at high voltage is employed. Such induction telegraphy permits of signalling over distances of about 300 miles with only 3 to 6 dry cells.

The circuit of an induction telegraph includes the secondary winding of an induction coil at each station, the primary winding being joined to a local circuit with a key and battery. A current pulse is induced in the secondary coil whenever the primary circuit is made or broken, but no steady current is induced either when the key is kept open or when kept closed. Since the direction of the secondary momentary current when the primary circuit is broken is opposite to that when the primary circuit is closed, it will be observed that a polarized receiving instrument is essential for the operativeness of this type of telegraph circuit. Using step-up induction coils, high line voltages may be availed of with few cells, thereby rendering induction telegraphs admirably suited for military purposes even for fairly long lines.

The United States army induction telegraph field kit includes a polarized receiving instrument, a key, several dry cells and an induction coil, mounted in a portable box. The induction coil has 100 times as many turns on the secondary as on the primary winding, and takes about 12 watts at 4 volts. The circuit of a simplex induction telegraph is shown in Fig. 16, in which  $P, P'$  are polarized relays,  $S, S'$  are sounders,  $B, B'$  are local batteries,  $K, K'$  are keys, and  $p$  and  $s$  are respectively the primary and secondary windings of the induction coils  $I, I'$ . Upon depressing the key  $K$ , an induced current of momentary duration will be produced in the secondary winding of induction coil  $I$ , flowing, say, upward, which current in flowing through the two polarized relays to ground  $G'$  at the distant station causes their armatures to touch the sounder contacts. Both sounders will operate as the result of the completion of their local circuits. Although the current

pulse over the line is of very short duration, the polarized relay armatures will remain against their sounder contacts until the key is released. The subsequent opening of key *K* produces a reverse current pulse through the line and the relay windings, which causes the relay armatures to open their respective sounder circuits. Signalling in the opposite direction may be accomplished similarly.

To reduce further the impedimenta during warfare, the polarized relay and local sounder are replaced by a *polarized sounder* in induction telegraph sets devised by G. R.

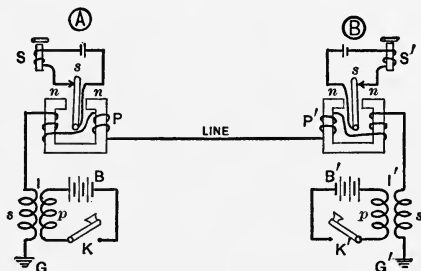

Fig. 16.

Guild for use by the United States Signal Corps. Such sounders resemble those of the usual type except in that the soft-iron yokes joining the lower ends of the magnet cores are replaced by permanent horseshoe magnets, thereby giving a definite polarity to the poles of the electromagnet cores. A current through the coils will cause the armature to be more or less strongly attracted according as the electromagnetization assists or opposes that of the permanent magnet. The retractile spring of the polarized sounder is adjusted so that reversal of current direction will effect its proper operation with currents as small as 10 milliamperes. Inasmuch as these instruments may be dif-

ferentially wound (shown at *PS* in Fig. 17), they may be used advantageously for duplex induction telegraphic signalling.

Induction telegraph repeaters are used for repeating into simplex closed- or open-circuit lines or into another induction telegraph circuit. Fig. 17 shows the arrangement for repeating from an induction telegraph to a closed-circuit simplex line, and *vice versa*, using polarized and polarized-repeating sounders. The position of the armatures corresponds to the normal condition for no transmission of messages. The arrows *a* and *a'* indicate the direction of the induced currents in the line circuit on the closing of the local circuits including batteries *B* and *b'* respectively. The armature of the polarized repeating sounder *PR*<sub>2</sub> is biased to remain on its lower contact except when a current flows through either of its coils. The letters *n* and *s* indicate the polarity of the polarized sounders which is occasioned by their permanent magnets. The opening of the

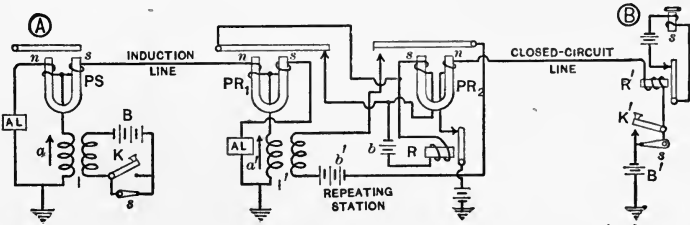

Fig. 17.

armature contact of the other repeating sounder *PR*<sub>1</sub> removes the short-circuit from the left-hand coil of repeater *PR*<sub>2</sub>, thereby energizing this coil, but at the same time the introduction of its resistance reduces the current strength in relay *R* to a value insufficient to keep its armature attracted. The repeating of signals in either direction may readily be traced (see problem 5).

## PROBLEMS

1. Decipher the tape shown below, which represents part of a message transmitted by the Murray multiplex telegraph.

2. If operators can perforate transmitting tapes at the rate of only 4 letters per second, how many operators would be required to keep the transmitters at one station of the Murray quadruple-duplex and of the Pollak-Virag writing telegraphs supplied if their transmitters are operated at 40 and 700 words (each of 5 letters) per minute respectively?

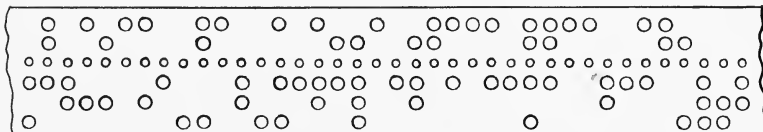

3. The rheostats of the telautograph are not of the same width from one end to the other, but have a width that is calculated to compensate for the variation of the line resistance occasioned by the inclusion of more or less of the resistance of these rheostats. Formulate an equation giving the resistance from one end to any point on the rheostat so that the line current will be strictly proportional to the distance of that point from the reference end.

4. The resistances of a selenium cell are 30,000 and 20,000 ohms under illuminations of 20 and 100 lucas intensity. Calculate its resistance under an illumination of 1 lux.

5. With the aid of Fig. 17 describe the operation of the instruments for repeating from a closed-circuit to an induction telegraph line, and *vice versa*.



## CHAPTER VII

### MUNICIPAL TELEGRAPHS

1. **Fire-alarm Telegraphy.** — Signalling systems are installed in cities and towns to enable the inhabitants to notify the fire-fighting force promptly of the discovery and location of a fire. The facts that a fire in its incipiency is more readily subdued than after it has made considerable headway, and that the loss of human life and property is always imminent, render it imperative that the fire-fighting force reach the scene of the fire and begin its activities in the shortest possible time. Fire-alarm telegraph systems should have street signalling stations or fire-alarm signal boxes at convenient points throughout the territory served that are capable of being operated by any one when an occasion demands. In villages and towns where the fire-fighting force is composed of volunteers, the operation of a signal box sounds a public alarm which indicates the location of the signal box operated, and the volunteers hasten to their quarters for the fire apparatus and then proceed therewith to the fire. In cities maintaining paid fire departments, the operation of a signal box sends a distinctive signal to a central station which is equipped with facilities for disseminating this information to the firemen stationed at the apparatus houses of the fire department.

The time interval between the discovery of a fire by an individual and the arrival of the firemen at a fire in a

city may be divided into three periods. First, the time required for the individual to reach the nearest street signal box after his discovery of fire; second, the time taken between the sending of the signal, usually called "turning in the alarm" or "pulling the box," and the repeating of this signal in the apparatus houses of the fire department; and, third, the time elapsing from the reception of the signal at apparatus houses to the arrival at the scene of the fire of those fire-fighting companies that are expected to "turn out" or answer the particular signal.

Of these periods, the *first* depends largely upon the proximity of the nearest fire-alarm box; thus, in the Borough of Manhattan of New York City the distribution of boxes is such that the nearest box is anywhere from 100 to upward of 800 feet from a building, depending to a certain extent upon the nature of the businesses or residences of the various districts. This time period is frequently reduced by the use of supplementary or auxiliary boxes installed in buildings and leased from private concerns, which are designed when operated to trip automatically the nearest street fire-alarm box, and also by the use of thermostatic devices located in buildings and operated by the fire itself to send signals to the office of the company giving the service, from which point the alarm is telegraphically transmitted to the central station. The *second* time period comes within the province of municipal fire-alarm telegraphs, and depends upon the signalling speed of the fire-alarm boxes, of central station repeating, and of the signal-receiving devices at apparatus houses. Alarm transmission in New York City requires, on the average, somewhat less than 50 seconds from the pulling of the box to the

last stroke of the gong at apparatus houses. The *third* time period depends upon the rapidity with which the apparatus is turned out, its speed in advancing to the fire and the distance it must traverse. The increasing use of motor-propelled fire-fighting apparatus within recent years has materially diminished the duration of this time period.

It is apparent that the fire-alarm boxes of a municipal fire-alarm telegraph system might be individually connected to the central station by electric circuits, each terminating in an annunciator drop which bears the number of the box associated with it, and that the signalling devices at the apparatus houses might also be connected to the central station by separate circuits, thereby enabling operators to signal particular fire companies that a fire exists within their districts. The great cost of a large number of such diverging circuits located on poles or in underground conduits renders such a system prohibitive. Instead, in fire-alarm systems, a number of signal boxes are connected in series on one circuit, and similarly the signalling devices at a number of apparatus houses are connected to one circuit; in small municipalities both types of devices are frequently joined to a single circuit. In Manhattan there are approximately 40 box circuits averaging 26 fire-signal boxes per circuit. While such series-circuit systems introduce more elaborate fire-alarm boxes, in that each must send a distinctive signal and should be immune from interference by the simultaneous actuation of other boxes on the same circuit, the reduction of the cost of line material and its installation renders such systems far more economical than the individual-circuit arrangement mentioned above.

2. **Fire-alarm Signal Boxes.** — The fire-alarm boxes that are distributed throughout a city are usually mounted on posts located near the curb of sidewalks so as to be conspicuous. One style of fire-alarm post, with a glass globe for illumination at night, is shown in Fig. 1.



Fig. 1.

The turning in of an alarm necessitates the opening of key boxes in order to expose the "hook," the pulling of which starts the mechanism for transmitting the alarm. Some key boxes have trap locks on their outer doors, and when a key is inserted it cannot be withdrawn until released by a fire department officer with his "release" key. Keys to such boxes are customarily distributed to responsible citizens of a town, each key being numbered for identification. Other boxes have keys permanently trapped in the locks and covered with key guards consisting of an iron casing with a glass cover. Breaking the glass leaves the key accessible. With keyless boxes, a handle protrudes from the front of the box, as shown in Fig. 1. In one type of keyless box, turning the handle opens the door to expose the hook for pulling, and also sounds a local alarm on a large gong within the box for attracting the attention of persons in the vicinity, thereby discouraging the sending of

false alarms. With the other type of keyless box, the turning of the handle sounds the local alarm as well as operates the signalling mechanism without opening the box.

Fire-alarm boxes are generally designed to operate on

normally-closed circuits. Each signal box is equipped with a spring-driven mechanism which, when set in motion by pulling the hook, revolves a *signal wheel* that causes the circuit to be opened a definite number of times with definite time intervals between, thereby transmitting to the central station a code signal indicating the number and thus the location of the particular box operated. Two such signal wheels located in different fire-alarm boxes are shown in Fig. 2 at *A* and *B*. Each wheel has groups of projections, one group representing units, another tens, and so on, and when it revolves the projections suc-

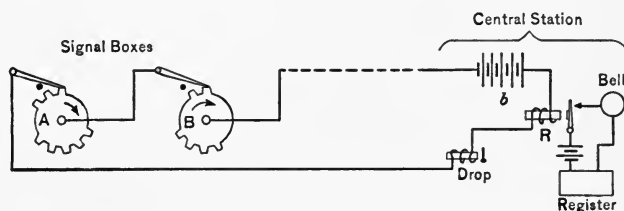

Fig. 2.

cessively touch a contact spring, thereby closing the circuit which extends to the receiving relay *R* situated at the central station. The normal position of the two signal wheels is indicated in the figure, one wheel having 3 and 5 projections and the other 2 and 4 projections in its two groups. When wheel *A* is set in motion, the circuit is opened 3 times and after a pause is opened 5 times, which action causes the bell at the central station to strike 3 times and then 5 times, a signal interpreted as 35. The mechanism is arranged to rotate the signal wheel a certain number of times, usually four, with one depression of the hook, consequently transmitting 4 *rounds* of number 35 in a complete signal. The signal boxes are designed so

that the mechanism when once started cannot be interfered with by subsequent pulling of the hook, thus guarding against mutilation of the transmitted signals by excited persons who do not heed the usual directions appearing on the inner cover of signal boxes to "pull the hook down once and let go."

With signal boxes connected in series and having the parts indicated in Fig. 2, it is possible that two boxes on the same circuit might be pulled at about the same time, and as both signal wheels would then revolve, the signal transmitted by each would be mutilated by that sent by the other, and both would be lost. Such interference might arise, not only because of the breaking out of two fires at almost the same time in districts served by one circuit, but also because of two individuals seeing the same fire from different points and turning in alarms from different signal boxes. The latter condition is often minimized by *interlacing* the signal-box circuits, so that alternate boxes in both directions are joined to different circuits. Both of these causes of signal interference, however, may be eliminated by the use of signal boxes arranged so that a box cannot transmit its signal while an alarm, originating at another box, is being transmitted over the same circuit. Such non-interfering signal boxes first came into use in 1870 through the invention of Gamewell, and have since been perfected by Crane, Gardiner, Ruddick and others.

Ruddick, in 1889, introduced features in signal boxes whereby, if two boxes were pulled simultaneously, neither would interfere with the other, but both would transmit their signals properly, one after the other, or successively. Thus, if a box is pulled while another is transmitting, the mechanism of the former would operate without

affecting the circuit until the line is again free, and then this box would automatically assume control of the circuit and send its signal.

Fire-alarm signal boxes may, therefore, be grouped into three types in accordance with the foregoing description,

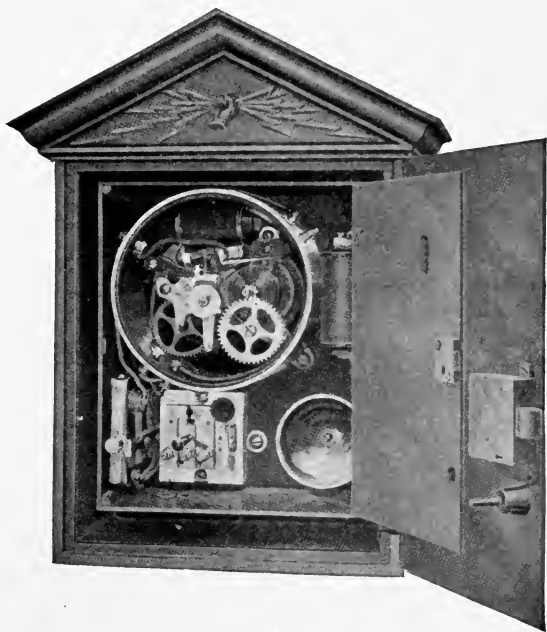

Fig. 3.

namely: *plain boxes*, which are devoid of the non-interfering and successive features, *non-interfering boxes*, which have not the successive feature, and *successive boxes*, which are also non-interfering. The successive non-interfering type of fire-alarm box represents the highest development of signalling devices on series fire-alarm circuits.

Fig. 3 shows the interior of the positive non-interfering

successive fire-alarm signal box made by the Gamewell Fire Alarm Telegraph Company. These boxes are provided with a mechanism capable of giving 16 rounds at one operation of the starting device, a single-stroke bell for striking at the box the signal that is being transmitted, a signal key for transmitting code signals, a test switch for keeping the circuit closed while electrical or mechanical tests are being made on the box, a protector against abnormal currents, a lightning arrester and a plug switch for including either the signal key or the signal wheel in the circuit or for grounding the circuit at the box during tests. The outer dimensions of this signal box are 18 by 13 by 6 inches.

The scheme of the mechanism and connections of a Gamewell successive signal box is indicated in Fig. 4. The line wires terminate at the outer plates of the plug switch, the inner plate being grounded. The electrical devices in the box are kept normally short-circuited by the contacts  $C'$ , which are kept closed by the door of the signal box, and by the contacts  $C''$ , which are kept closed except when the box is actuated. When contacts  $C'$  or  $C''$  are open, the line circuit includes the rear key contact, the bell magnet, the "succession" magnet, and the signal contacts  $C$ . The opening and closing of the signal contacts is under the control of signal lever  $L$ , pivoted at  $h$ , which carries a small roller  $R$  for riding over the teeth of signal wheel  $W$ . The movements of lever  $L$  are limited by the actions of locking lever  $B$ , pivoted at  $e$ , by catch  $T$ , pivoted at  $a$ , and by controlling lever  $E$ , pivoted at  $d$ . Signal wheel  $W$  and gear wheel  $G$  are mounted on the same shaft and are driven by the main driving wheel  $D$  under the influence of the spiral spring  $S$ , the signal wheel mak-



ing 8 revolutions during one revolution of the driving wheel, at a speed governed by an escapement and fan, not shown.

When the mechanism is at rest, the driving wheel is locked by pawl *P*, which is attached to lever *B*, because

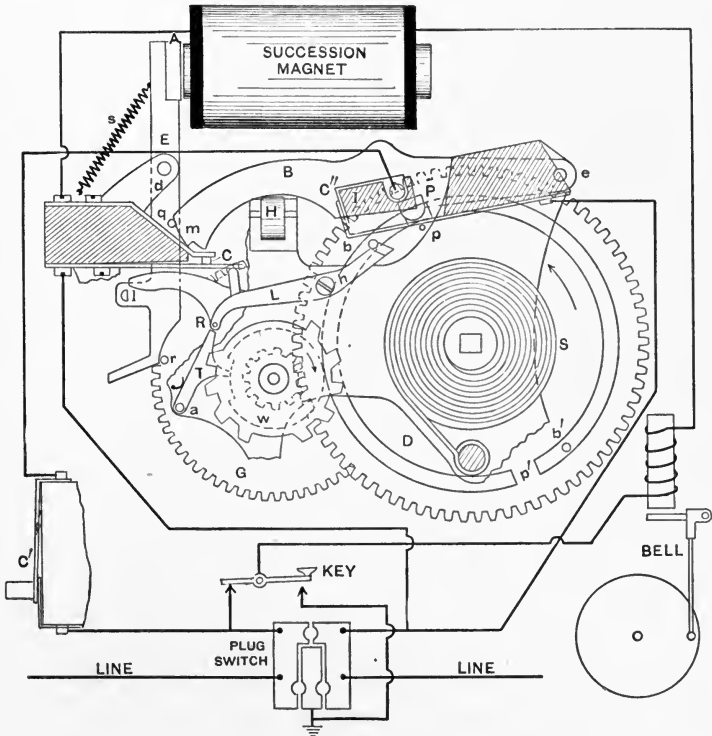

Fig. 4.

the pawl rests in slot *p* or *p'* of the upwardly-extending flange of driving wheel *D*. When the hook *H* is pulled, the locking lever *B* is raised, carrying with it insulating block *I*, thereby opening contacts *C''*. At the same time the pawl is raised out of slot *p* and the mechanism is set in

motion, the pawl then slides over the periphery of the flange on *D*. Signal lever *L* does not fall immediately, because it is momentarily held by pin *b* or *b'* carried on the driving wheel. If during this short test interval the line circuit is uninterrupted, a current will flow through the succession magnet and its armature *A* will be attracted, consequently keeping locking pin *l* to the left and clear of signal lever *L*. As pin *b* passes the downwardly-projecting hook of the signal lever, this lever will fall and the roller *R* will engage the teeth of the signal wheel, since catch *T* is pushed to the left when the first tooth on the signal wheel reaches roller *R*, and is kept in this position until the complete signal is transmitted by means of the notched wheel beneath *W* and, for a time during each revolution, by lever *L* itself. While the signal lever is in its lower position, pin *l* banks against its left end in order to keep lever *E* clear of the signal lever during the intervals when the line circuit is opened at *C* and the succession magnet is deprived of current. After the signal wheel has revolved four times slot *p'* will be in position for pawl *P* to fall into it, which action arrests the motion of the mechanism. The engagement of pin *b'* with the right-hand end of the signal lever raises roller *R* from the signal wheel and causes the contacts *C* to be closed.

If, when the signal box is pulled, another is transmitting its signal over the same line, the succession magnet will be deprived of current at some instant during the brief period that the signal lever is held up by pin *b* or *b'*, and consequently, spring *s* is enabled to pull lever *E* away from the magnet. Locking pin *l* then prevents the signal lever from bearing on *W*, and causes contacts *C* to be kept closed. As the normal line current, when traversing the

succession magnet, is not sufficiently strong to enable this magnet to attract its armature when retracted to the full extent, contacts *C* will be kept closed. Restoring pin *r* bears against the shoe at the lower end of lever *E* once in each revolution of the signal wheel, and moves this lever clockwise so as to bring armature *A* close to the magnet. This movement, which carries pin *l* clear of the signal lever, does not cause this lever to drop, because catch *T* has moved to the right during this interval, since its lip has been pressed into the recess of the notched wheel beneath the signal wheel *W*. After 4 revolutions of the signal wheel the pawl *P* will drop into the slot of the flange on *D*, but only partially, because the downward movement of lever *B* is checked by pin *q* striking the shoulder *m*. In consequence, the pawl is forced out of this slot, and the mechanism continues in operation. At the next instant lever *E* is moved by the restoring pin *r* so as to bring armature *A* close to the magnet. If, while the armature is in this position, it is kept attracted by the magnet, the signal lever will fall after engaging pin *b* or *b'*, and roller *R* will ride on the signal wheel. The box now has control of the circuit, and will transmit the box number. But if, while the armature was close to the magnet, it was not kept attracted, lever *E* would be pulled back by spring *s*, and the signal key would be kept up by the locking pin *l*. Thus, the box "looks in" on the circuit every little while, and if it finds the circuit idle it assumes control of the circuit. Should the circuit still be open after the signal wheel has revolved 16 or 20 times, the mechanism is automatically stopped by a ratchet-lever (not shown) and the box number will not be transmitted.

The appearance of the non-interfering successive signal

box made by the Star Electric Company is shown in Fig. 5. This box is equipped with a mechanism capable of repeating its signal number forty times with one winding of the spring, a single-stroke bell, a signal key, a test switch for testing the operation of the mechanism by the response of the bell without sending any signals to the receiving

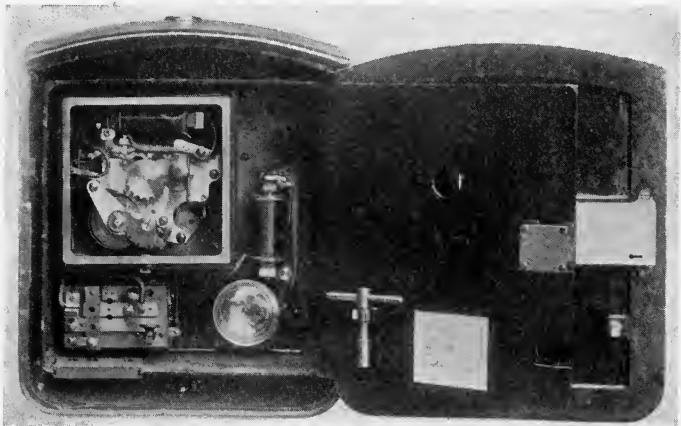

Fig. 5.

devices on the box circuit, a protector against abnormal currents, a lightning arrester and a grounding switch.

Fire-alarm boxes that are wound by the act of pulling the starting lever, termed *sector boxes*, are also used, the mechanisms being driven either by springs or weights.

**3. Public Alarms.** — In villages or towns having volunteer fire brigades, the volunteers are called by the sounding of a public alarm which is operated by electromechanical devices connected in the same circuit as the signal boxes. Fig. 6 shows a Gamewell electromechanical whistle-

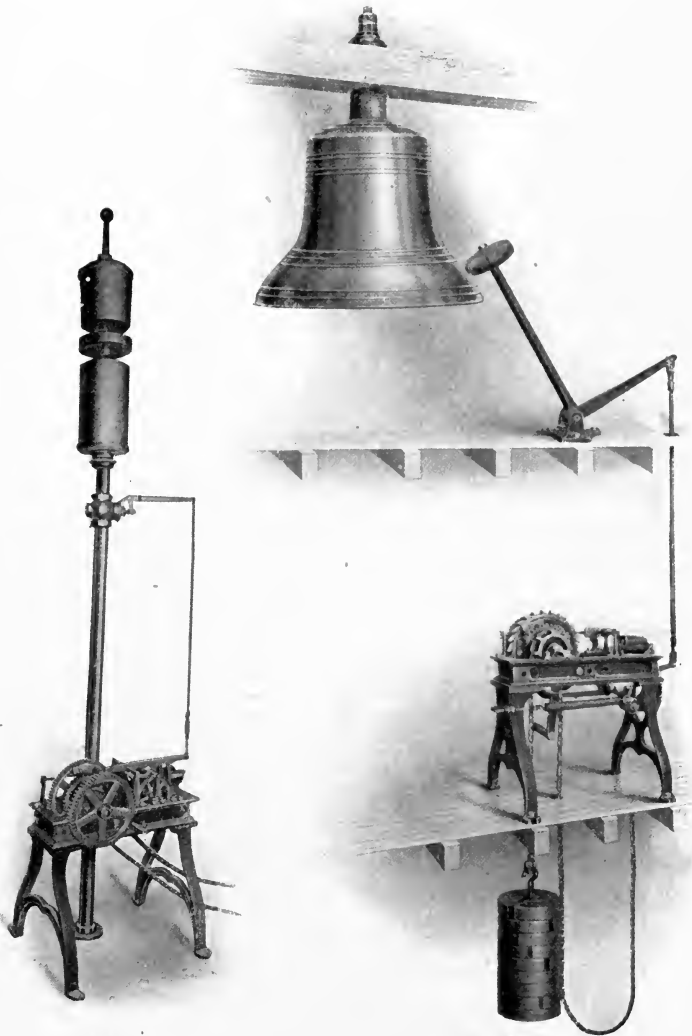

Fig. 6.

Fig. 7.

blowing machine with a two-bell steam gong. This type of public alarm gives satisfactory results where a steam pressure of 80 pounds per square inch is maintained. The weight-driven mechanism opens the whistle valve simultaneously with the circuit openings, and returns to its normal position every time the circuit is closed, thus rendering the signal blasts sharp and distinct. Compressed air is also used for blowing horn alarms, the operation being effected in the same way as with steam gongs. Electric horns are now being introduced for public fire alarms.

Bells are frequently used for sounding public alarms in cases of fire. A bell with its electrically-controlled striking mechanism is illustrated in Fig. 7. Bell-striking and whistle-blowing machines may be wound up manually or by automatic motor-driven machines called electrolifts.

**4. Fire-alarm Central Stations.** — The central stations of fire-alarm telegraph systems comprise apparatus for receiving, recording, and transmitting signals and fire alarms, which devices may be designed for manual, semi-automatic or automatic operation. Manually-operated stations are frequently equipped also with facilities for semi-automatic and automatic transmission of signals. The gravity or storage battery for operating all the circuits of the system is located at the central office. The size and character of fire central-station equipments for cities and towns naturally depend upon local conditions and upon the scope of the fire-signalling system. Typical installations for central stations will now be considered.

At a *manual central station*, each signal-box circuit terminates in a visual drop and a relay; the latter actuates

a bell and one pen of a multiple-pen register, Fig. 2. Incoming alarms are received by one or more operators, who are on duty at all times. Having heard the bell signal and seen the record on the register tape, an operator proceeds to transmit the alarm to the apparatus houses. As the receiving instruments at these houses are usually



Fig. 8.

grouped on several circuits, it is necessary to transmit the signal over all apparatus-house circuits simultaneously. This is accomplished by fire-alarm transmitters, three types of which are illustrated in Figs. 8, 9 and 10.

Fig. 8 represents a spring-driven detachable signal-wheel transmitter with signal wheels that are cut to correspond with those in all the fire-alarm boxes of the system. These wheels are orderly arranged on pegs as shown, or,

if numerous, are placed in accessible drawers. Upon receiving an alarm, the proper signal wheel is selected and placed in position on the mechanism, and then the handle is drawn to start the mechanism and transmit the signal.

Fig. 9 shows a Gamewell one-dial four-number adjus-

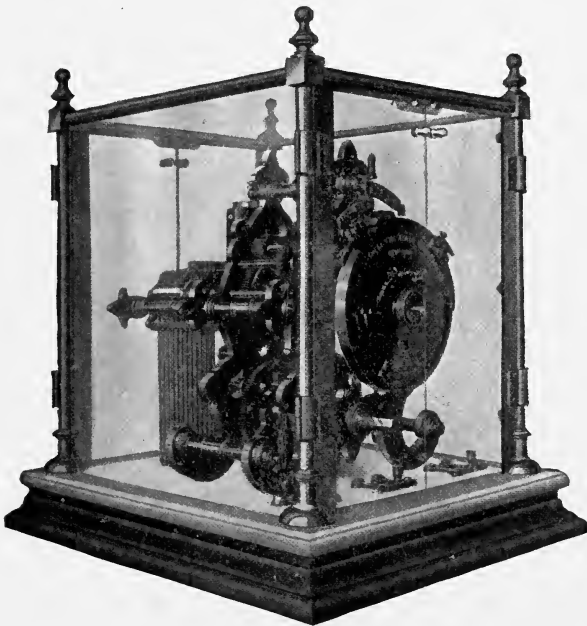

Fig. 9.

table-speed weight-driven transmitter. The box number to be transmitted is set on the dial at the front by moving the four slotted disks relative to each other. The number of rounds transmitted may be varied by drawing a lever toward the right to the positions marked 1, 2, 3 or 4. This movement causes the multiple contacts at the rear



to be opened the proper number of times and at the correct intervals, thereby transmitting the box number simultaneously over all the apparatus-house circuits.

The Star Electric Company's one-dial four-number transmitter is illustrated in Fig. 10. Each digit is set by moving a lever down to the desired number, and the number is then displayed near the top of the instrument.

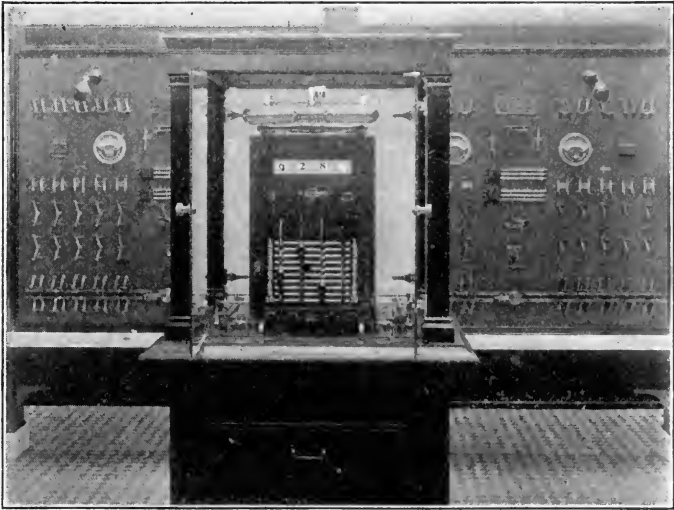

Fig. 10.

These transmitters may be equipped with speed-changing devices so that one or more rounds of signals may be transmitted over one class of circuits at a certain speed and then, by an automatic shifting of the mechanism, the remaining rounds of the signals may be transmitted over another class of circuits at a different speed.

Some circuits extending to the apparatus houses also have a key and a relay at their central station ends, the

relay with a local bell enabling the reception of signals originating at the apparatus houses.

*Automatic central stations* are used principally where a fire-alarm system requires two or more circuits but is not large enough to warrant the attendance of operators. Automatic repeaters are used in such stations for repeating signals that come in on any one circuit over all the other circuits. These repeaters should possess non-interfering features in order to avoid confusion of signals transmitted by two or more boxes located on different circuits when pulled at the same time. Such non-interfering repeaters

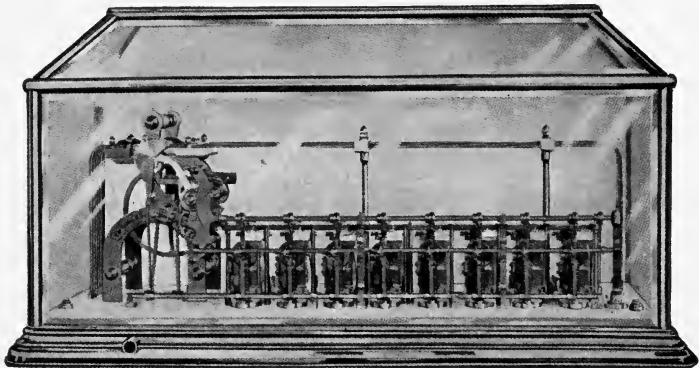

Fig. 11.

have been devised by Skelton, Kirnan, Cole and others. Fig. 11 shows an 8-circuit automatic repeater made by the Gamewell Fire Alarm Telegraph Co.

The operation of a Gamewell repeater will be understood by a consideration of Fig. 12, which shows the repeating arrangement and one box-circuit magnet with auxiliary devices in the normal condition. The weight-driven transmitting cylinder *D* is mounted eccentrically

on shaft *S* so as to move contact rollers *R* and *R'* against or away from their respective contact springs in the process of repeating alarms over box and gong circuits other than that over which an alarm is being transmitted. As

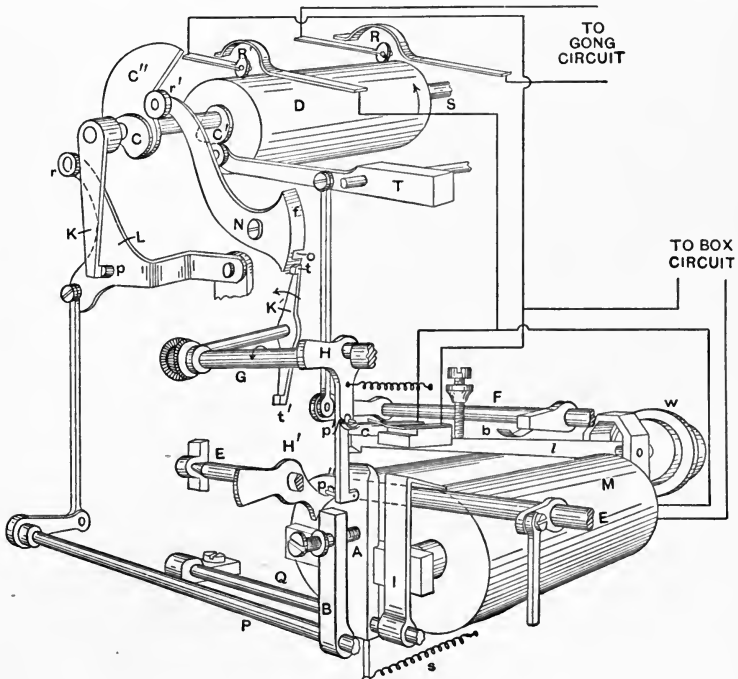

Fig. 12.

many contacts may be provided as there are gong and signal-box circuits in the fire-alarm telegraph system. The transmitting cylinder makes one complete revolution every time a box circuit is opened. Shafts *E*, *F*, *G*, *P* and *Q* extend to the right in front of other repeater magnets, and carry levers before each magnet precisely as illustrated for the one box-circuit magnet.

When the current through magnet  $M$  is interrupted, armature  $A$  is drawn back by spring  $s$ , carrying lever  $B$  back with it. This movement of  $B$  raises lever  $L$  and withdraws pin  $p$  from the path of detent  $K$ , which is rigidly attached to shaft  $S$ . As a result, cylinder  $D$  with its cams  $C$ ,  $C'$  and  $C''$  is set in rotation. Cam  $C$  then acts upon roller  $r$  to depress lever  $L$ , thereby restoring armature  $A$  and resetting pin  $p$  to obstruct detent  $K$  at the end of its revolution. Cam  $C'$  depresses lever  $T$ , which through shaft  $F$  and spring  $b$  lowers locking lever  $l$  so as to engage and hold armature  $A$  against the action of spring  $s$  while no current traverses the electromagnet. Cam  $C''$  slowly lowers the right-hand end of lever  $N$ , and as the opening  $o$  reaches tip  $t$  of detent  $K'$ , this tip is forced through the opening by clockwork. Shaft  $G$  makes only a half revolution because tip  $t'$ , when it reaches its upper position, is held against the face  $f$  of lever  $N$ . After roller  $r'$  of lever  $N$  reaches its highest position it is gradually lowered by clockwork to its normal position, in the process of which tip  $t'$  escapes through opening  $o$ , thus permitting another half revolution of shaft  $G$ . A series of latches  $H$ , one for each repeater magnet, is mounted loosely on eccentrics on shaft  $G$ , so that the first half revolution of this shaft lowers the latch, and the second half revolution restores it. With those magnets whose armatures are kept attracted because of the normal current traversing them, the downward movements of latches  $H$  cause locking levers  $l$  to move down and hold the armatures, and also effect the opening of contacts  $c$  by means of the pins  $p'$ . But with the electromagnet of the box-circuit over which a signal is being transmitted, the latch  $H$  was pushed back by the outward movement of the armature so that its

downward movement does not affect the corresponding contacts  $c$ . This latch  $H$  is kept back by pin  $p''$  on  $H$  engaging with latch  $H'$  during the further excursions of the signalling armature. Every time the circuit is closed at the signal box the armature is drawn up close to the cores of the electromagnet, thereby releasing the locking lever by the overbalancing effect of weight  $W$ . When signalling ceases all devices are automatically restored to the normal position. A break in any circuit will cause that circuit to be automatically locked out by the locking lever until the disabled circuit has been repaired. The circuit on which a signal originates is indicated at the repeater by the drop  $I$ , which is thrown back by the armature when the circuit is first opened. All alarms transmitted by the repeater are usually recorded on a register.

With systems arranged for semi-automatic operation, incoming signals are received and recorded at the central station, but after one round of a box number has been signalled, the operator may cause the remaining rounds to be transmitted directly to the apparatus houses of the fire department.

The signal-box and apparatus-house circuits of a fire-alarm telegraph system generally terminate at a switchboard in the central station, upon which is located the various devices associated with these circuits. Where storage batteries are used for operating the circuits, a battery switchboard is installed for enabling the charging of the cells in series, multiple, or series-multiple as may be necessary, for switching from one battery to a reserve battery, and for testing purposes. Such a switchboard is shown in Fig. 10, located behind the fire-alarm transmitter.

5. **Signalling Devices at Apparatus Houses.** — In fire-alarm signalling systems having automatic central stations or having manual stations employing a single method in



Fig. 13.

transmitting alarms, the signalling equipment at apparatus houses comprises electromechanical gongs and frequently registers or visual alarm indicators. The gongs have spring-driven mechanisms and strike one blow every time the circuit is closed. The usual sizes of gongs are 6, 8, 9, 10, 12, 15 and 18 inches in diameter. The indicators are spring-driven electromechanical devices for displaying the box numbers in large figures, being operated only by the first round of signals. Such indicators are designed for showing either three or four digits, each digit being brought into view by a wheel bearing the numbers from 1 to 9 on its periphery. The mechanism is of the step-by-step type, and is manually restored by the pulling of a

cord. Both gong and indicator may be combined into one instrument as shown in Fig. 13, which depicts a 15-inch electromechanical gong with a three-digit indicator.

Registers yield a record of received alarms either by

ink marks or perforations in paper tapes. Fig. 14 shows a punching register, paper take-up reel and an automatic time and date stamp which prints on the register tape the exact time that alarms are received.

With systems having manual central stations and employing two different methods in transmitting alarms to apparatus houses, two circuits enter each of these houses from the central station, and these are called "gong cir-

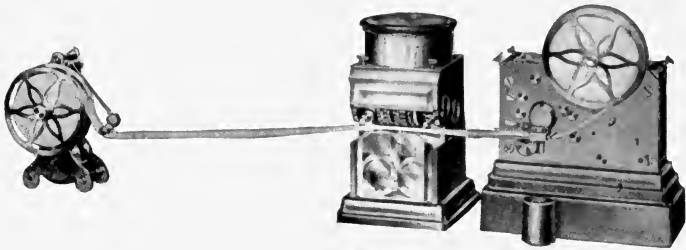

Fig. 14.

cuits" and "joker circuits." The gong circuits terminate at apparatus houses in electromechanical gongs and sometimes also in indicators, as described above. The joker circuits terminate in single-stroke electric bells, or tappers, having 5- or 6-inch gongs, and also frequently in registers. With such systems one or more rounds of signals may be transmitted at high speed over the joker circuits and then the remaining rounds transmitted over the gong circuits at the necessarily slower speed suitable for electromechanical gongs, or vice versa.

Where routine telegraphic communication is desirable between the central office and the apparatus houses, joker circuits are also equipped with relays, sounders and keys at all stations. These circuits may be used for routine instructions and messages when no alarms are being trans-

mitted, but as soon as alarm transmission commences, telegraphic communication ceases. Such circuits, enabling both telegraphic and alarm signalling, are called *combination circuits*. A scheme of connections of a signal equipment at apparatus houses for use on gong and combination circuits is represented in Fig. 15, the gong circuits being normally open and the combination circuit normally closed. Relay armature *a*, controlling the telegraphic

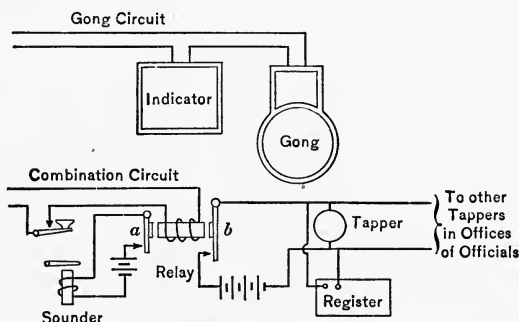

Fig. 15.

apparatus, is attracted when the small normal currents traverse the combination circuit, but armature *b*, controlling the tapper, is attracted only when a larger current is sent out on the line, which function is performed by the central station transmitter in the process of transmitting alarms.

**6. Operation and Routine of a Fire-alarm Telegraph System.**—The operation of municipal fire departments in receiving and responding to alarms is obviously different in the various cities. A particular fire department, that of Brooklyn, N. Y., which serves a population of 1,800,000 inhabitants and protects an area of 71 square miles, will here be considered.



There are 1800 fire-alarm boxes included in 40 circuits which lead to the manual central station on Jay St., and there are 4 combination and 7 gong circuits extending from this central station to the 91 apparatus houses of the department. Each box circuit terminates at the central office in a relay, which controls one pen of a 30-pen register and a tapper. Each of these box circuits passes through one or more apparatus houses for affording convenient places for line testing. Two rounds of an alarm are transmitted over the gong circuits by means of a four-dial four-number transmitter, and then two rounds are transmitted manually over the combination circuits by means of a multiple key. A three-position telephone switchboard at the central station is connected to the "Main" exchange of the New York Telephone Company through 10 trunk lines, for receiving calls for fire-fighting apparatus by telephone. Each apparatus house is joined to this private branch telephone switchboard by a direct or a party line.

An area of 4.8 square miles of Brooklyn is protected by high-pressure service, supplied by two pumping stations. Alarms of fire are received at these stations simultaneously with the apparatus houses and a water pressure of 75 pounds per square inch is immediately applied to the water mains. There are 215 telephone boxes connected directly with the pumping stations for enabling fire department officers to call for increased pressure or order the system shut down.

The duties of fire companies and officers are largely directed by an assignment book. Upon the pulling of a box (or sending a first alarm) and the subsequent receipt of the number of that box at the apparatus houses, certain

engine companies, hook and ladder companies, and chiefs immediately respond to the alarm. Upon the receipt of a second, third and fourth alarms from the same signal box, other companies respond without other notification than the receipt of the particular alarm, and further, still other companies move from their own quarters into those made vacant by companies responding to earlier alarms. If more apparatus is needed than available on the fourth alarm, special calls are made by the central station operator. Such calls are also made in order to supply a substitute for any company that for various reasons may be prevented from answering an alarm sent from a box to which that company is regularly assigned. The operator must, therefore, be kept constantly informed upon the preparedness of all companies and officers to respond to immediate call.

To illustrate the use of this method of answering alarms upon signal, consider that box 93, located at Borough Hall, be pulled. The location of this signal box and that of the various fire companies in this section of Brooklyn are indicated in Fig. 16 by small circles bearing the proper numbers of the companies. Numbers between 30 and 50 represent battalion chiefs, numbers between 100 and 200 represent hook and ladder companies, numbers over 200 represent engine companies, numbers preceded by *S* represent fire insurance salvage corps, numbers 10 and 11 represent deputy chiefs, *C* represents the chief of the department, 6 represents a water tower, *S*! represents a searchlight engine and numbers preceded by *FB* represent fire boats. The assignments for box 93 follow, the first line gives the numbers of the companies and officers responding to the first alarm from this box, the second line those for



the second alarm, etc., the sequence of the numbers of each group being the order in which the companies are expected to arrive at the signal box. These assignments are also shown in Fig. 16 by the light dotted lines marked I, II, III and IV which are drawn to include the locations of all companies and officers that are assigned to answer the first second, third and fourth alarms respectively sent from box 93. The changes of company locations on the third and fourth alarms are also indicated.

Station	Engine companies	Hook and ladder companies	Deputy chief	Battalion chiefs	Water tower	Companies to change locations	
						Engine companies	H. & L. Co's.
93 Joralemon and Court Streets	205, 224, 207	118, 110	10	31, 33	....	.....	.....
	226, 204, 206, 256 SI	103	....	32	6	.....	.....
	203, 208, 210	105	....	34	....	{ 209 to 226 } { 251 to 206 }	119 to 118
	219, 279, 202	.....	....	....	....	{ 235 to 219 } { 239 to 204 }	.....

Alarms beyond the first are sent to the central station by officers of the fire department or their aids by transmitting, with the telegraph key at any signal box near the fire, the numbers 2, 2 and the box number for the second alarm, or 3, 3 and the box number for the third alarm, etc. Any engine company may be ordered by the central-station operator to respond to a box to which it is not regularly assigned by transmitting over the apparatus-house circuits the number 5, the box number and then the company number in close succession. Such special calls may also be made for hook and ladder companies by transmitting the number 7, the box number and then the company number. On their return from a fire, engine companies and hook and ladder companies signify their preparedness

to answer another call by transmitting respectively to the central office over the combination circuits the numbers 4, 4, 4 and the company number, and 4, 4, 4, 7 and the company number, the operator answering this signal by the numbers 2, 3. Should a company be called out on a "still alarm," one of its firemen informs the central operator to this effect by transmitting 2, 2, 2, the company number and then the number of the box nearest the scene of the fire.

In all five boroughs of New York City (280 square miles) there are 13 deputy chiefs, 43 battalion chiefs, 181 engine companies, 93 hook and ladder companies, 10 fireboats and 8 hose companies; the personnel totals 6740 individuals. The number of fires and false alarms and the resulting loss to buildings and contents in this city during the first nine months of 1913 are given below; the average loss per fire during this period is found to be \$542.

1913	Number of fires	Number of false alarms	Loss in dollars
Total (Jan.-Sept.) . . . . .	9660	1293	5,215,087
Average per day . . . . .	35	5	19,103

**7. Police Patrol Telegraphs.** — Signalling systems are installed in cities for enabling policemen to transmit code signals for summoning assistance, calling ambulances or patrol wagons, and informing headquarters that they are on duty, and to communicate with their superior officers by telephone. Such police-patrol signal systems have many features in common with fire-alarm signal systems, already described. Means for transmitting signals from headquarters to convenient points in the city, for calling any or all patrolmen to their nearest street stations for

the purpose of receiving instructions, may be incorporated in police signal systems. In some cities police signal systems utilize telephone instruments exclusively.

Police signal boxes resemble fire-alarm boxes in that they include a mechanism for transmitting the box number by means of a signal wheel, a telegraph key and a single-stroke bell. In addition, police signal boxes have a telephone receiver, a telephone transmitter and an induction

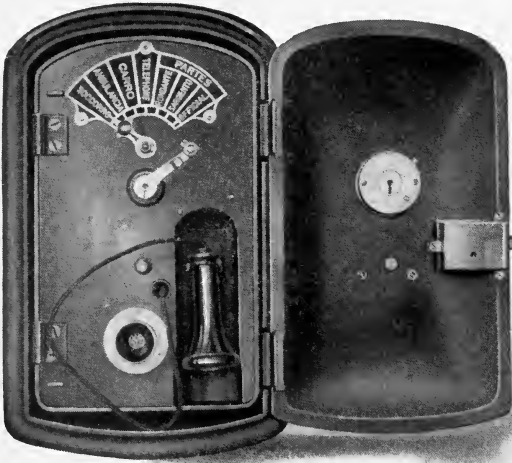

Fig. 17.

coil, properly connected together to form a telephone set. Fig. 17 represents a Gamewell 7-call police signal box with its outer door open, and Fig. 18 shows the same box with both outer and inner doors open to exhibit the various parts.

When a policeman has occasion to send any one of the seven code signals, he moves a pointer to the proper position as indicated by the plate on the inner cover (Fig. 17)

and then pulls the crank located just below the pointer. Thus, if the pointer of box 34 is placed in the second position corresponding to "ambulance," the mechanism would transmit 2 dots at slow speed followed after a short pause by the box number 3, 4 at faster speed. If a patrolman transmits an "on duty" code signal and the central station attendant wishes to converse with him, the

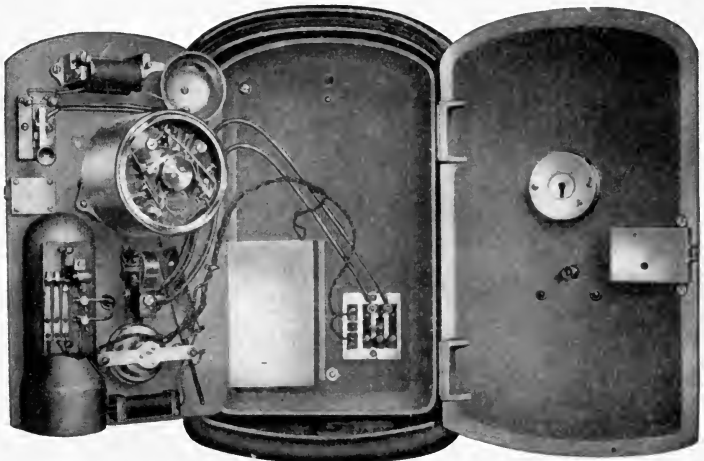

Fig. 18.

attendant depresses a key a prearranged number of times immediately after receiving the code signal, which act causes the bell at the signal box to sound accordingly, thereby notifying the patrolman to use the telephone.

Numbered keys may be given to responsible citizens with which they can operate the police signal boxes when in need of police assistance without opening the outer door, such keys when used being trapped in the locks for identifying the possessors.

Incoming signals are usually received at the precinct

headquarters by a tapper and a register. Calls for patrol wagons are transmitted by the operator to the police stables and garages, the number of the signal box being

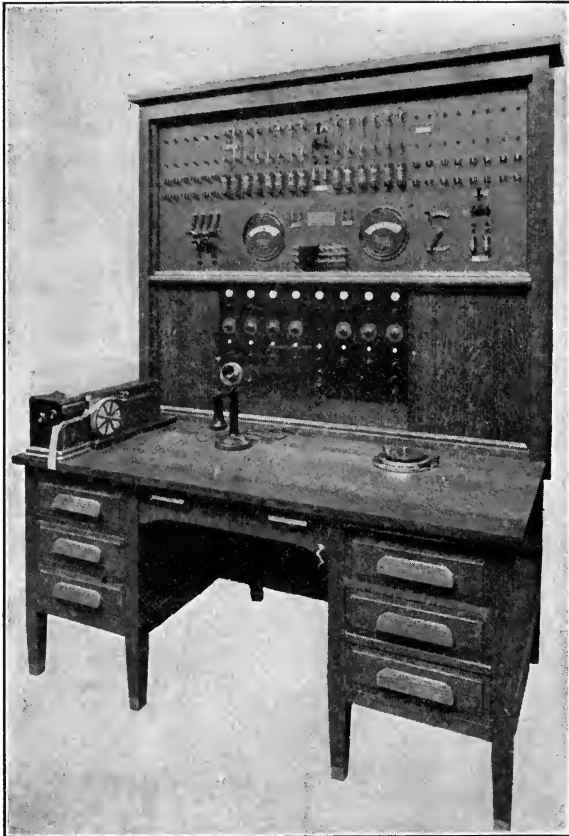

Fig. 19.

sent out by detachable signal-wheel or special dial transmitters. The equipment at the stables and garages usually includes an electromechanical gong and indicator as illus-



trated in Fig. 13, a register with take-up reel as indicated in Fig. 14, a tapper and a telephone set. Upon the receipt of a call for a patrol wagon at these places, a wagon is dispatched from the stable nearest the signal box from which the call originated.

Fig. 19 shows the Star Electric Company's unit-type central-office police desk with the necessary devices for receiving code or telephone calls over box circuits, for transmitting calls for patrol wagons and ambulances, for calling one or more patrolmen on duty by flashlight or bell signals to proceed to their nearest signal boxes for receiving orders, for controlling and charging the storage battery which supplies current to the signal circuits, and for testing the continuity and insulation of the circuits. This cabinet is arranged for 3 box circuits, 2 flashlight circuits, 1 chief's circuit, 1 stable circuit and 1 test circuit.

#### **8. Statistics of Police and Fire Signalling Systems. —**

The latest published census statistics of fire-alarm and police-patrol telegraph systems in the United States are for the year 1907. The following table gives data selected from this census on signalling systems used for fire alarms exclusively, those used jointly for fire alarm and police signal service, and those used for police patrol signalling exclusively, the various systems being grouped according to population of the cities wherein installed.

Of the 38 cities with a population in excess of 100,000, there are 28 + 8 or 36 having fire-alarm systems; the remaining 2 cities, Kansas City and St. Joseph, Mo. depended entirely upon the telephone for transmitting alarms of fire. Of the 40 cities having from 50,000 to 100,000 inhabitants,

39 have fire-alarm systems and Kansas City, Kans. depended upon telephonic fire-alarm transmission. The cities of Quincy, Ill. and Chester and Williamsport, Pa. of 36,000, 34,000 and 29,000 inhabitants respectively, were reported as having no fire-alarm systems.

## Fire-alarm signal systems

	Cities having populations of					Total
	100,000 and over	50,000 to 100,000	25,000 to 50,000	10,000 to 25,000	Less than 10,000	
Number of cities in group *	38	40	82	281	.....	.....
Fire-alarm systems	28	35	69	231	568	931
Fire alarms received in 1907	39,581	10,700	14,372	17,688	14,175	96,516
Signal boxes	12,151	4,268	5,337	8,700	9,895	40,401
Telephone boxes	216	.....	37	112	131	496
Miles of single wire	17,218	3,377	3,447	5,322	5,973	35,337
Manual transmitters	30	16	14	46	58	164
Automatic transmitters	24	34	52	103	73	286
Receiving circuits	584	265	368	712	880	2,809
Transmitting circuits	332	182	196	366	394	1,470

## Combined fire-alarm and police-patrol signal systems

Combined systems	8	4	10	14	12	48
Fire alarms received in 1907	19,832	959	1,848	945	619	24,203
Signal boxes †	8,118	669	931	665	338	10,721
Telephone boxes	1,915	127	31	109	10	2,192
Miles of single wire	19,223	1,154	763	601	156	21,897
Manual transmitters	17	2	4	6	2	31
Automatic transmitters	8	4	8	3	1	24
Receiving circuits	356	34	74	81	27	572
Transmitting circuits	108	20	52	35	13	228

## Police-patrol signal systems

Police signal systems	27	29	39	52	31	178
Signal boxes †	3,758	1,204	1,020	761	256	6,999
Telephone boxes	1,054	110	153	226	152	1,695
Miles of single wire	8,788	1,543	1,601	1,148	498	13,578
Transmitters	107	12	21	31	3	174
Receiving circuits	358	117	181	136	96	888
Transmitting circuits	191	75	120	76	29	491

\* Population based on 1900 census.

† Combined signal and telephone boxes were in most cases reported as signal boxes.

**PROBLEMS**

1. Explain that if two successive fire-alarm boxes are pulled simultaneously, that box whose number has the lowest first digit will assume control of the circuit before the other signal box.

2. Show the scheme of connections at the central office of 3 fire-alarm box circuits, each terminating in a relay and a drop, the relays controlling the operation of a common tapper and a 3-pen register.

3. Formulate the assignments of fire-fighting companies and officers for signal box number 234 located at Fulton St. and Hudson Ave., Brooklyn. The location of this box and of the various companies and officers is shown in Fig. 16, the same number of companies being assigned to this box as to box 93.

## CHAPTER VIII

### RAILWAY SIGNAL SYSTEMS

1. **Classes of Railway Signalling.** — Railway signals for the conveyance of information to those engaged in running trains or cars fall into the following classes: (a) *block signals* which indicate whether or not a train may proceed into the next track section or block; (b) *train-order signals* for advising engineers when train-dispatcher's orders are to be given them; (c) *route or switch signals* for authorizing the passage of trains over junctions, crossings, drawbridges, etc.; (d) *other signals*, such as flags, lanterns and torpedoes, for the warning of temporary dangers, and fixed signs for indicating speed limits, location of water tanks, etc. Classes *b* and *d* lie outside the scope of electric signalling, the former class always being manual signals operated by the telegraphers who take the train orders.

Block signals are used on lengths of track devoid of switches and crossings for limiting the space between two trains on the same track to an amount affording a proper braking distance for those trains running over this track at maximum speed. On single-track roads, block signals also give proceed and stop indications to trains advancing in opposite directions. Block signals may be manually operated, manually controlled, or automatic. *Manually-operated block signals* are operated either by engine drivers or motormen upon reaching a block, or by attendants stationed along the roadway who set their signals in accord-

ance with information of train movements received by telegraph or telephone from their neighboring attendants. *Manually-controlled block signals* are set by attendants, the action of one in operating signals being under the control of another; thus, two attendants, one at each end of a block, must act in setting a signal. *Automatic block signals* are actuated by track or trolley attachments, or are operated through an electric track circuit, the train movements governing the signals in both cases. These arrangements control either a local electric circuit which operates the signal, or a valve which allows compressed air or gas to move the signal.

Route or switch signals are the signals of *interlocking plants* which comprise groups of switches and signals that govern the movements of trains at crossings, junctions, terminal yards, etc. The switches and signals of interlocking plants may be moved manually or by means of compressed gas or of electricity under the control of levermen, the individual movements for establishing a track route following each other in a predetermined order. These signals also act in conjunction with the block signals just beyond interlocked territories.

**2. Types of Signals.** — Signals for block systems and interlocking plants may be electric lights, semaphores (with lights as night signals), or enclosed disk signals (with lights as night signals). These signals indicate in different ways the commands: Stop — danger, proceed with caution, and clear — proceed. With light signals, these commands are displayed by utilizing a distinctive color for each: thus, red is used as the danger signal, green generally as the clear signal, and orange-yellow usually as the caution signal.

Semaphores are either of the two-position or three-position type, the blade positions for the various indications being shown in Fig. 1. A high three-position semaphore is shown at *A*, this signal being mounted on iron masts placed beside the tracks or on signal bridges. A dwarf

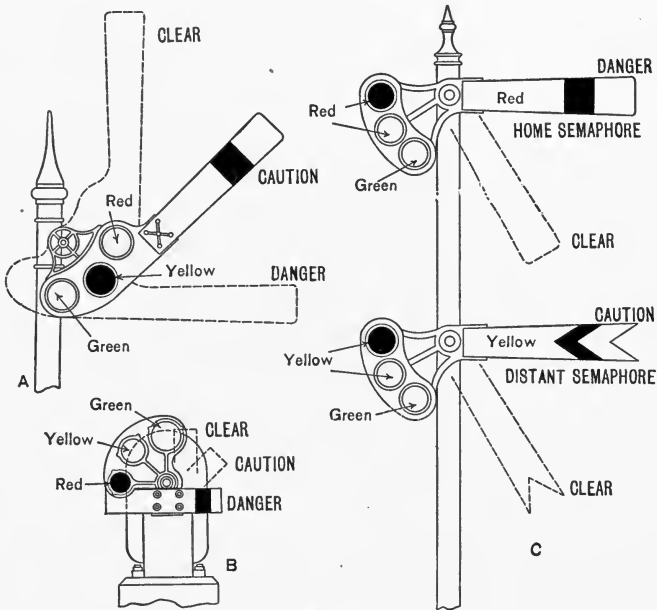

Fig. 1.

three-position signal is shown at *B*, and is mounted directly alongside of the tracks, usually at interlocking plants. These three-position upper-quadrant signals indicate by their blade positions: danger when horizontal, caution when inclined upward at 45 degrees, and clear when vertical. Two two-position semaphore signals mounted on the same mast are shown at *C*, the upper serving as the *home blade*

and the lower as the *advance* or *distant blade* of a block signal. Both blades horizontal signify "stop," the upper inclined downward 60 degrees and the lower horizontal mean "proceed with caution," and both inclined downward 60 degrees signify "clear." Spectacles carrying colored glasses are fastened rigidly to the semaphore blades so as to move in front of lamps, thereby displaying at night colored light signals corresponding to the blade positions.

Enclosed disk signals consist of an electromagnet whose armature controls the position of a wire hoop covered with colored bunting, all enclosed in a glass-covered case. When the magnet is energized, the colored disk is drawn away from the aperture and a white background is visible; when released, the disk falls into position and its color is displayed. Colored glass disks, similarly controlled and moving before a lamp, serve as the night signals. Such enclosed signals, while once widely used, are now infrequently employed.

Electric light signals assume a variety of forms depending upon the conditions of use; three styles made by the Union Switch and Signal Company are shown in Fig. 2. The block signal used by the Interborough Rapid Transit Company in the New York Subway is shown at *A*. The upper or home signal displays either a red or a green light, and the lower or distant signal shows either a yellow or a green light, both being provided with an auxiliary miniature semaphore signal immediately below the lenses for use in case of lamp failures. Colored glass disks supported in vertical sliding frames move in front of the lamp apertures by means of compressed air, the valves being controlled by electric track circuits (§ 5). The block signal used in the Pennsylvania Railroad Tubes under the Hudson and East

Rivers is shown at *B*, the three upper lights performing the same function as a three-position semaphore, since only one can be illuminated at a time. The lower lamp always

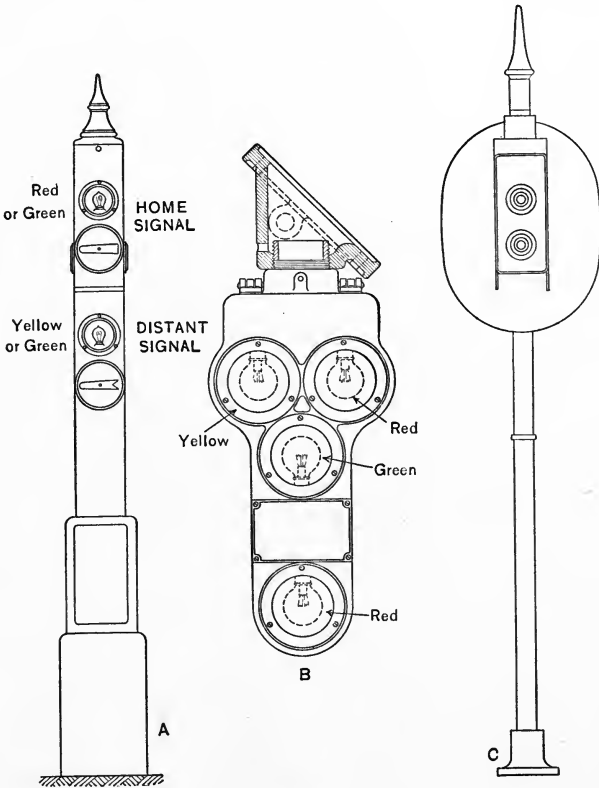

Fig. 2.

remains lighted and serves as a fixed signal. Similar signals with an additional lower lamp are used as interlocking signals. At *C* is shown a type of signal for daylight service used by the Indianapolis, Columbus & Southern



Traction Company and by other electric railway companies.

Semaphores for block and interlocking signals are sometimes distinguished from each other by their color or by the shape of the ends of their blades. The indications of semaphores used with automatic block signal systems may be normally danger or clear. A normal danger signal ordinarily stands at "danger," but goes to "clear" as a train approaches it if the block governed by the signal is clear, returning to "danger" when the train enters the block. A normal clear signal stands at "clear" except when a train occupies the block governed by the signal. Normal clear signals are now preferred by signal engineers.

Mechanical, electric, electro-pneumatic and electro-gas devices are used for actuating the semaphores and switches of interlocking plants, and (excepting the first), for operating the semaphores of automatic block signal systems. Electric-motor semaphores are now more frequently installed than semaphores actuated in other ways.

The mechanism of the Style B upper-quadrant two-position direct-current semaphore, manufactured by the Union Switch & Signal Company, is shown in Fig. 3. The track circuit is arranged so that the motor *A* and the holding magnet *B* receive current while the block governed by the signal is being cleared. When the signal subsequently indicates "clear" the motor is open-circuited but the flow of current through the holding magnet remains uninterrupted. The holding magnet is fixed to the "slot arm" *C* which rocks around pivot *D*. This slot arm carries the rod *E* which connects with the semaphore blade, and also carries a system of links terminating in the cam piece *F* which may engage the trunnions of the chain *G*. The

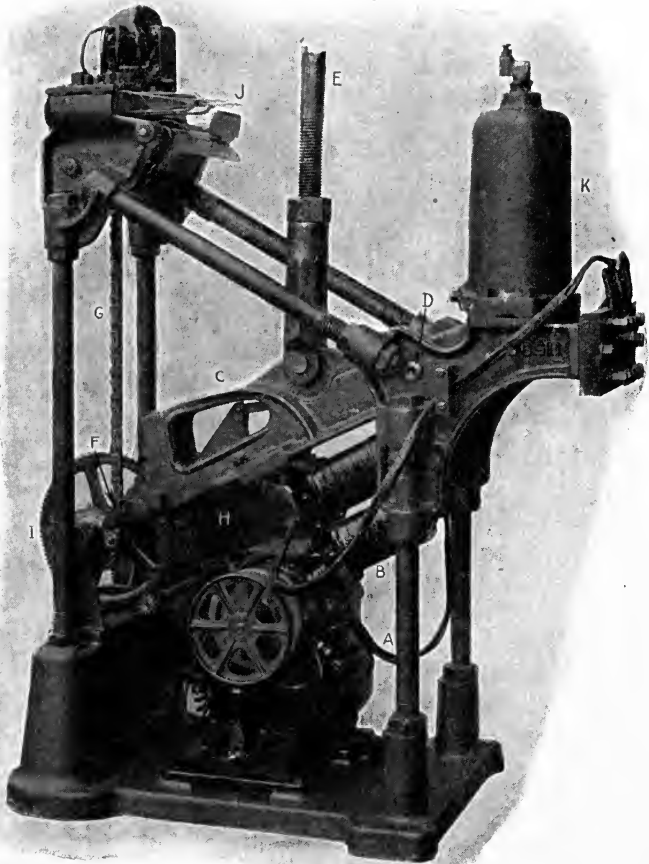

Fig. 3.

passing of a train out of the block causes the operation of the semaphore motor, the rotation of which produces an upward movement of the chain through the gear-wheels *H* and *I*. Simultaneously, the armature of the holding magnet is attracted, thereby holding the system of links

and the cam  $F$  rigid. This cam, consequently, engages a trunnion of the upwardly-moving chain, and the slot arm is carried to its upper position, corresponding to the clear position of the semaphore. At this position, the circuit of the motor is automatically opened at  $J$  by the slot arm, this arm remaining in its upper position as long as the holding magnet is energized.

The presence of a train in the block causes the release of the holding-magnet armature and the loosening of cam  $F$ , this action allowing the slot arm to descend by gravity to the position shown in the figure. The pneumatic buffer  $K$ , connected to the right-hand end of the slot arm, permits the gradual return of the semaphore to this danger position. Series-wound or induction alternating-current motors may also be used with this mechanism. By the addition of another slot arm, the same motor may operate the other position for a one-blade three-position signal or the second blade of a two-arm (home and distant) signal.

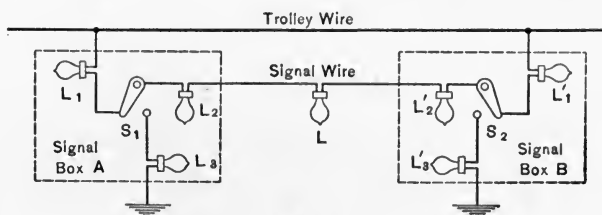

Fig. 4.

**3. Manual Block Signal Systems.** — The scheme of a manually-operated block signalling arrangement, frequently used on single-track electric railways operating relatively few cars, is shown in Fig. 4. A signal box, having three electric lights,  $L_1$ ,  $L_2$  and  $L_3$ , and a two-point switch  $S$ , is located at each end of a block. No illuminated lamp at

either end indicates that the block is clear, and illuminated lamps at either end denote that the block is occupied by a car and that no other car may enter until these lights are extinguished. A motorman, reaching signal box *A* and finding no lamps lit, moves switch  $S_1$  to the right, thereby causing lamps  $L$ ,  $L_2$ ,  $L_3$ ,  $L_1'$  and  $L_2'$  to be illuminated, and proceeds into the block toward signal box *B*. The lights now displayed by both signal boxes permit no other motorman, advancing from either direction, to enter this occupied block. The lamp  $L$ , joined in the signal wire, indicates to the motorman in the block that the signals are still set against advancing cars. Upon reaching signal box *B*, the motorman moves switch  $S_2$  to the left, thereby extinguishing all lamps and clearing the block. It will be observed that irrespective of the positions of switches  $S_1$  and  $S_2$ , if no lamps are lit, a movement of either switch will light the lamps at each box, or, if lamps are illuminated, a movement of either switch will extinguish them. With 550-volt trolley circuits, five 110-volt lamps are connected in series when illuminated.

With manually-controlled block signal systems, arrangements are utilized whereby each operator stationed along the roadway cannot clear his own signal for an approaching train until it is unlocked through electrical means by the operator located at the other end of the block, his own signal thereby displaying the danger signal to trains advancing in the opposite direction.

**4. Location of Automatic Block Signals.** — A *home signal* is one showing the condition of the track directly in front of a train, and which, if in the stop or danger position, is not to be passed except as governed by the rules of the

railway company. A *distant signal* shows the condition of the track some distance ahead of a train, and, if in the caution position, may be passed if the train is brought under control, prepared to stop at the next home signal. Distant signals should be placed a distance in advance of the home signals permitting the fastest trains to be brought to standstill without overrunning the corresponding home signals. This braking distance may be from 1000 to 3000 feet, whereas the length of blocks is usually from 2500 to 8000 feet; the two distances depending upon traffic, train speed and roadway conditions.

An automatic *overlap system* without distant signals is indicated in Fig. 5. Each home signal controls a block

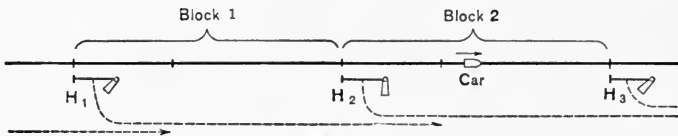

Fig. 5.

plus an overlap equal to a braking distance beyond the next signal (as indicated by the dotted lines), thereby insuring that a stopped car is always protected by a signal located at least a braking distance behind it. The two-position semaphores  $H_1$  and  $H_3$  are shown held in the clear position, while  $H_2$  is in the stop position owing to the presence of the car in block 2. The objection to this overlap system is that an engine driver or a motorman, knowing that at times there are two signals at "stop" between him and the train ahead, may be careless and overrun a stop signal without speed diminution on the belief that he will have ample time to stop, thereby courting danger.

Because of this objection, the automatic block systems

represented in Figs. 6 and 7 are preferred and generally employed for double-track signalling. In Fig. 6, distant signals  $D_2$  and  $D_3$  give advance indications of the positions of home signals  $H_2$  and  $H_3$  respectively. When at "caution," a distant signal signifies to an approaching train:

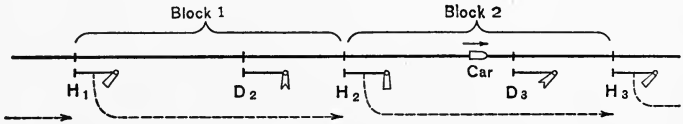

Fig. 6.

expect to find the next home signal at "danger." For the position of the car shown in the figure, signals  $H_1$ ,  $D_3$  and  $H_3$  are in the clear position,  $D_2$  is in the caution position, and  $H_2$  is in the stop position.

In Fig. 7, shorter blocks are represented wherein a distant signal is mounted on the same mast with the home signal

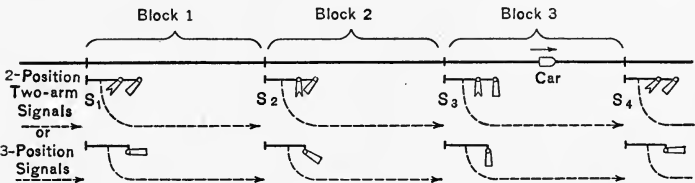

Fig. 7.

of the preceding block. The track length controlled by each home signal is shown by the dotted lines. The indications of the two-position two-arm semaphore signals while a car is in block 3 are:  $S_1$  and  $S_4$  at "clear,"  $S_2$  at "caution," and  $S_3$  at "stop." The corresponding indications of three-position semaphores are shown at the bottom of the figure.

The foregoing double-track signal systems are not

applicable to single-track roads, because they afford no protection against oppositely-moving cars, but a number of automatic block-signal systems have been devised and installed for single-track railway operation. One such system, called the TDB (Traffic Direction Block) System, has been recently introduced by the Union Switch & Signal Company, and is now in operation on a number of inter-urban electric railways. In this automatic block system, the distance between adjacent sidings is a block for oppo-

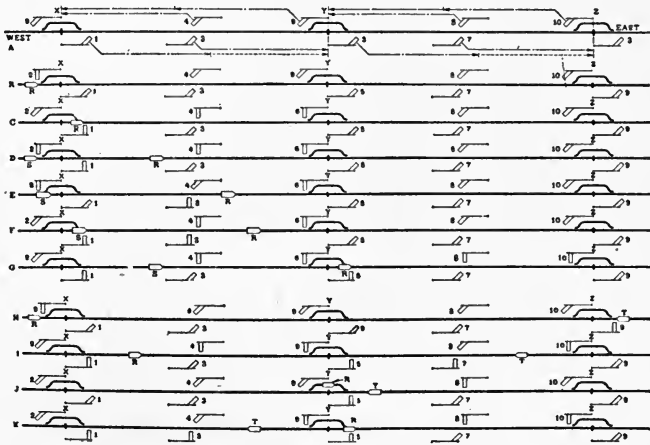

Fig. 8.

sitely-moving cars, called an *opposing block*, and half of this distance is a block for cars moving in the same direction, or a *following block*. Thus, each opposing block forms two following blocks.

Fig. 8 shows the location of semaphore signals in two opposing blocks of this signal system and gives the indications of these signals as one or more cars proceed through the blocks. Each opposing block is equipped with four sig-

nals, two being located at its ends and the other two being located a distance of 500 to 1000 feet on either side of its middle point. Each signal at a siding governs the track to the signal at the next siding in the case of opposing car movements, but only to the next signal in the case of following car movements; whereas the intermediate signals govern the track to the next signal for following car movements. The track sections controlled by each signal are indicated at *A* by *broken* lines for following movements and by *dotted* lines for opposing movements. The signals may be of either the light or the semaphore types, the latter, with two-position indications in the upper left-hand quadrant, are represented in the figure. This type of semaphore is widely adopted on electric roads, because the motorman's view of them is not obstructed by the poles which support the trolley wire.

An eastbound car *R* is approaching siding *X* at *B*, Fig. 8, and, consequently, signal 2 is in the stop position. At *C*, this car has passed out of the block to the left, thereby clearing signal 2 and setting at stop signals 1, 4 and 6. A second car *S* is approaching siding *X* at *D* while the first car *R* is approaching signal 3. It is seen that signal 1 protects the rear of the first car and signals 4 and 6 protect this car against opposing car movements. At *E*, car *R*, having passed signal 4, causes signal 1 to clear for the following car *S*. At *F*, car *S* has entered the first following block while car *R* is in the second following block; consequently, signals 4 and 6 still protect the cars against opposing car movements and signals 1 and 3 protect against following car movements. The first car has passed siding *Y* at *G* into the next opposing block, it being observed that both cars are protected from both directions. The



signal indications for westbound cars may similarly be traced.

The four remaining diagrams, *H*, *I*, *J* and *K*, show the signal indications for two cars *R* and *T* approaching siding *Y* from opposite directions. At *J*, the eastbound car has taken the siding, and does not affect any signals while off the main track.

**5. Automatic Block Signalling.**—Automatic block signal systems may be divided into two groups: first, those wherein trains or cars affect signal apparatus on arrival at definite places along the roadway and, after passing these points, leave the apparatus wholly beyond their control while proceeding through the block, and subsequently, when leaving the block, again affect the apparatus to restore it to its normal condition; and second, those wherein the train or car is itself continuously in direct control of the signal for the block over which it is passing, through the medium

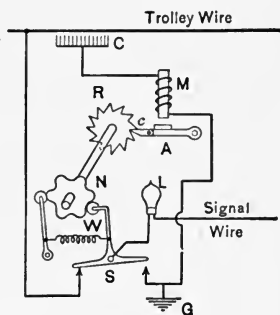

Fig. 9.

of a track circuit. While cheaper to install, the first group does not afford such thorough and continuous protection as does the second group of signal systems. Block signals of the first group were formerly used on some steam railways, and are now giving marked satisfaction on a number of interurban electric railways, the latter permitting better signal actuation.

Fig. 9 shows the apparatus at one end of a block for an automatic signal system of the first group as applied to an

electric railway. The arrangement is similar to the manual block signal described in § 3, except that the switch *S*, Fig. 4, is moved automatically when the car passes the block limits. This action is accomplished when the trolley wheel reaches the signal contactor *C*, Fig. 9, for the wheel then touches the spring contacts of *C* and the trolley wire simultaneously and causes a momentary current to flow from the trolley wire through the switch-controlling magnet *M* to ground at *G*. The consequent attraction of armature *A* of this magnet permits the campiece *c* to turn the ratchet wheel *R* through a distance of one tooth. This causes the notched wheel *N*, having half as many crests as the ratchet wheel has teeth, to turn an amount equal to the distance from a hollow to a crest. A projection of the switch arm *S* carries a small wheel *W* which rides on the notched wheel. When wheel *W* rests in a hollow (as shown), switch *S* closes its left contact, and when it rests on a crest, switch *S* closes its right contact.

When both signal sets of a block are in the position illustrated, no current traverses the signal wire with its lamps *L*, thereby giving the indication that the block is clear. When a car enters the block, the magnet is momentarily energized and the attraction of its armature causes a limited rotary movement of wheels *R* and *N*. Switch *S*, in consequence, moves to its opposite position and closes the right and opens the left contact. This action illuminates lamp *L* and the other lamps connected in the signal wire, thereby giving the stop indication to other cars advancing in the same or in the opposite direction. As the car moves out of the block, the switch at the other signal is similarly moved and the lamps are extinguished, thus again clearing the block.

The Chapman Automatic Signal System employs contactors which are returned by a spring to their normal position after they have been moved in either direction by a trolley wheel. The signals used with this system are of the semaphore type and are actuated by electromagnets. There are three magnets in each signal, two for controlling the indication of the semaphore arm, and the third for closing certain contacts upon momentary actuation as a car enters a block section. The three positions of the semaphore blade indicate: horizontal — car approaching in opposite direction, inclined downward 45 degrees — clear, vertically downward — car in block receding from you.

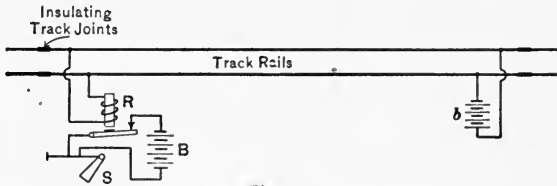

Fig. 10.

The principle of all automatic block signal systems of the second group is the operation of a relay whenever a pair of wheels with their connecting axle enters or leaves a block. The scheme of such systems for steam railroads is illustrated in Fig. 10. A battery is located at one end of a block and connected across the two track rails of a section, which are separated from the rails of the adjacent sections by insulating joints. The rails serve as conductors for the current from battery *b* to a track relay *R*, which is located at the other end of the block and likewise connected across the track rails. The relay controls through its contact points the local circuit of battery *B* and the semaphore signal *S*. When no car is in the block, relay *R* is energized and the

local circuit is closed, thereby holding the signal at clear. When a car enters the block, the battery  $b$  is short-circuited by the car wheels and axles, and the relay is deprived of current. The consequent opening of the local circuit at the relay sets the signal in the danger position. The battery and relay are placed at opposite ends of a track section, because this arrangement protects against broken rails and also indicates open bonds between rail-lengths. Either primary or storage batteries are used, and these are located in battery wells or chutes beside the tracks.

When distant signals are used with the scheme represented in Fig. 10, polar-neutral track relays are employed,

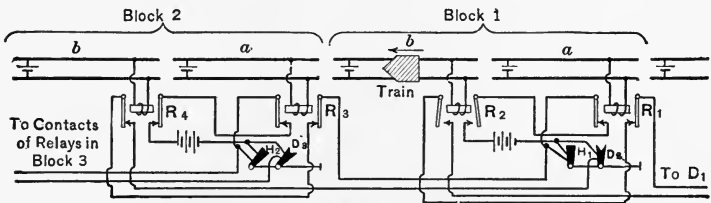

Fig. 11.

their neutral armatures controlling the home signals and their polarized armatures controlling the distant signals; the operation of a home semaphore blade moving a pole-changer for reversing the current in the relay of the preceding block. This system is called the polarized or "wireless" automatic block signal system.

Each signal may be controlled by any number of track-circuit relays, and each relay may have a plurality of contacts. Thus, Fig. 11 shows the scheme of connections for normally-clear two-arm semaphores (located as in Fig. 7) for two blocks of a track intended for traffic in one direction only. Each block is shown divided into two track

sections *a* and *b*, so as to increase the reliability of the track circuits by reducing the effect of current leakage from one rail to the other along ballast and ties. Track relays  $R_1$  and  $R_2$  control the home blade  $H_1$  of block 1, relays  $R_3$  and  $R_4$  control the home blade  $H_2$  of block 2, and relays  $R_1$ ,  $R_2$ ,  $R_3$  and  $R_4$  control the distant blade  $D_2$ . The operation of the signals for indicating the track conditions with the passage of a train can be understood readily from an

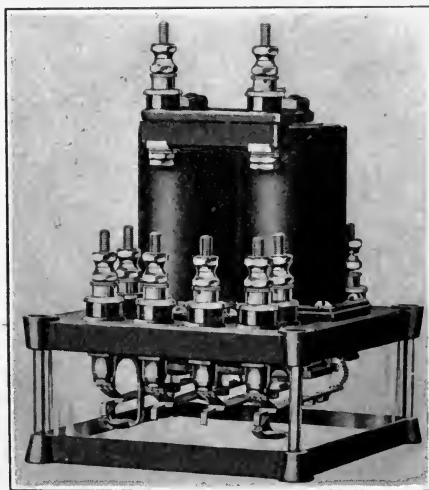

Fig. 12.

examination of the diagram, if it be remembered that each semaphore blade assumes the horizontal position whenever its local circuit is opened at a relay contact. For the position of the train indicated, the contacts of relay  $R_2$  are open and, therefore, home blade  $H_1$  and distant blades  $D_1$  and  $D_2$  will be horizontal.

A large variety of track circuits is utilized in practice for different types of automatic block signalling, using

normally-clear or normally-danger signals on single- or double-track steam and electric roads in connection with overlap, non-overlap or preliminary-section systems.

The appearances of two types of direct-current track relays manufactured by the General Railway Signal Company are shown in Figs. 12 and 13. That shown in Fig. 12 is the Taylor tractive-type relay and has 4 contacting fin-

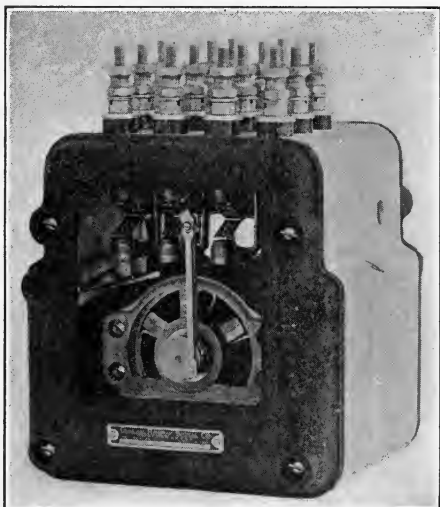

Fig. 13.

gers, each with front and back contacts; that shown in Fig. 13 is a three-position motor-type relay also with 4 contacting fingers, the closing of one or the other sets of contacts being accomplished by a partial rotation of the motor armature through the medium of an eccentric link.

**6. Automatic Block Signals on Electric Railways.**— Signalling on electric railways is accomplished in a some-

what different manner from that employed on steam railroads as just described, because the track rails are utilized as a return path for the current required in car propulsion.

*One-rail Block Signal System.* — Where it is possible to spare the conductivity of one track rail in the return of the propulsion current, as on elevated roads where the supporting structure serves also as a return path, one track rail is sectionalized and used for block signalling. Alternating current is now usually employed for signalling with this arrangement, requiring the use, on direct-current railways, of relays that are responsive to alternating current but not to direct current, and, on alternating-current railways, of relays that are responsive only to alternating current of higher frequency than the propulsion current.

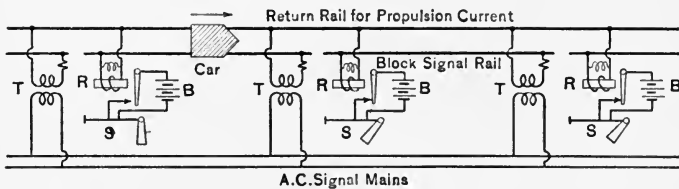

Fig. 14.

Fig. 14 shows the scheme of connections of the one-rail automatic block signalling system. The transformers  $T$  supply alternating current to the "exit end" of each track section from the alternating-current supply mains. The alternating-current relays  $R$ , connected at the opposite end of the track sections, control the operation of signals  $S$  through the local batteries  $B$ , as before, or through alternating-current motors fed by transformers joined to the signal mains. Each relay is shunted by an impedance to keep direct currents from the instrument. Usual transmission voltages are from 2200 to 4400, and at each block

are stepped down to 220 or 110 volts for the operation of alternating-current semaphore motors, and to 6 to 15 volts for the operation of the track circuits and lamp signals.

This system is used in the New York Subway, where approximately 700 signals, 500 track circuits and 40 interlocking plants are used. During the morning and evening rush hours 150 subway trains per hour pass 96th Street, this heavy traffic demanding blocks as short as 1500 feet. The signal mains supply 60-cycle current at 500 volts to the block transformers, each having two secondary windings, one which feeds the track circuit at 10 volts, and the other which feeds the lamp signal circuits at 50 volts. The valve-

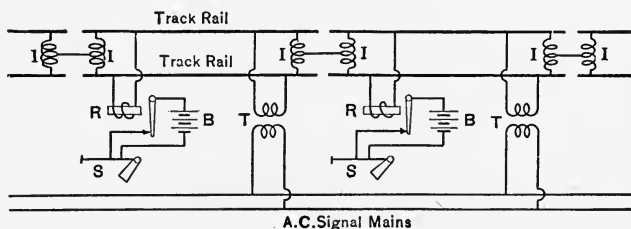

Fig. 15.

controlling magnets of the electro-pneumatic signal mechanisms are operated by direct current at 16 volts supplied by storage batteries.

*Two-rail Block Signal System.* — Both track rails of an electric railway may be used simultaneously as a return for the propulsion current and as conductors for the signalling current by the employment of *impedance bonds* placed between and connected across the track rails at both ends of each track section. These bonds are shown at *I* in Fig. 15, the middle points of the windings of adjacent bonds being connected together. In other respects, the one-rail



and two-rail signal systems are identical; compare the schemes of Figs. 14 and 15.

The impedance bonds have little resistance but large inductance, for they consist of heavy windings of copper around massive laminated-iron cores as illustrated in Fig. 16. For 600-volt railways the resistance of a bond may

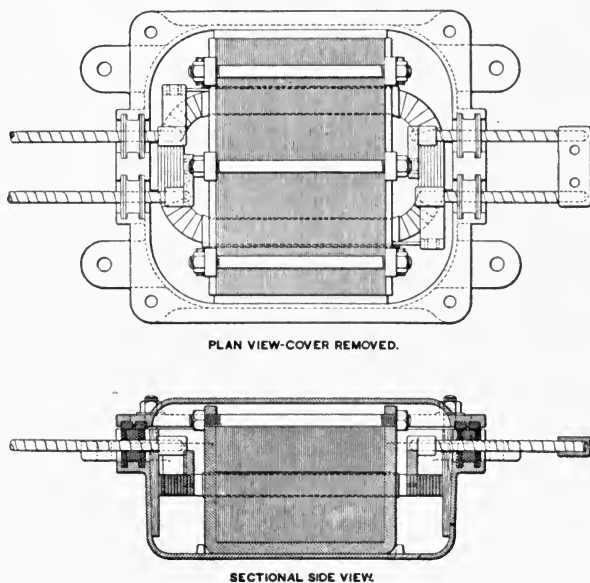

Fig. 16.

be from 0.0004 to 0.0015 ohm. The propulsion current, in being carried around the insulating joints which separate the track signal circuits from each other, flows differentially through the bonds and, consequently, does not magnetize their cores. Therefore, the propulsion current will not affect the signalling apparatus. The impedance of the bonds to the alternating current used for signalling is so

great in comparison with that of the relays that the presence of the bonds will not affect the operation of the alternating-current track relays.

The two-rail block signal system is installed on a number of direct-current railways, a few of which are: the West Jersey and Seashore Railroad, the Washington, Baltimore & Annapolis Electric Railroad, the Hudson and Manhattan Railroad, and in the electrified zones of the New York Central, the Pennsylvania, and the Southern Pacific Railroads.

This block signal system is also used on alternating-current electric railways, the relays being designed not to respond to the propulsion currents, but to respond to currents of a higher frequency used in signalling. Thus, on 25-cycle electric railways the signalling is usually accomplished by currents of 60-cycle frequency. Signal installations of this type include the New York, Westchester and Boston Railway, the Chicago, Lake Shore & South Bend Railway, and the electrified zone of the New York, New Haven and Hartford Railroad.

*Alternating-current Track Relays.* — The vane-type alternating-current relay, shown in Fig. 17, made by the Union Switch & Signal Company is widely used with one-rail block signal systems. It consists of a C-shaped laminated core carrying two field coils, one on either side of the core air-gap. The pole-pieces of the core are provided with single turns of wire short-circuited upon themselves, called *shading coils*. An aluminum vane, pivoted in jewel bearings, is arranged to move up and down in the air-gap. When an alternating current traverses the field coils, a shifting magnetic flux is established at the air-gap with the aid of the shading coils, which flux causes an upward

movement of the vane. Contact fingers mounted on the shaft carrying the vane are thereby brought against stationary contacts connecting with the terminals on the cover.

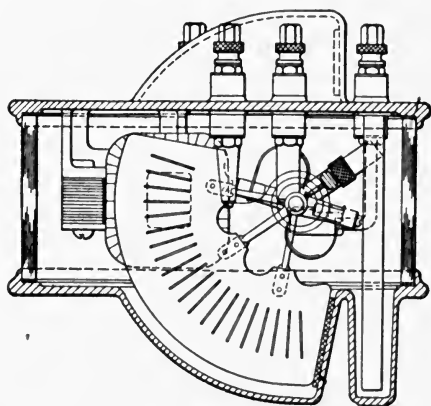

Fig. 17.

Fig. 18 shows the appearance of the centrifugal frequency track relay made by the same concern and used on alternating-current electric railways employing the two-rail block signal system. Other types of alternating-current relays for both one-rail and two-rail automatic signal systems are available.

**7. Interlocking Plant Signals.** — Track switches and signals at railroad crossings, junctions, crossovers, draw-bridges and terminal yards are operated mechanically, electrically or electro-pneumatically and are actuated by the levers of interlocking machines under the control of levermen. An interlocking machine is usually placed as close as possible to the devices which it controls, but numerous such machines are in use which are 6000 feet

distant from some of the devices controlled. The use of mechanical interlocking machines is restricted to short distances, say up to 1000 feet; but the electric and electro-pneumatic machines may be used for controlling devices at great distances. Fig. 19 shows the Unit Lever type Electric Interlocking Machine, in combination with the

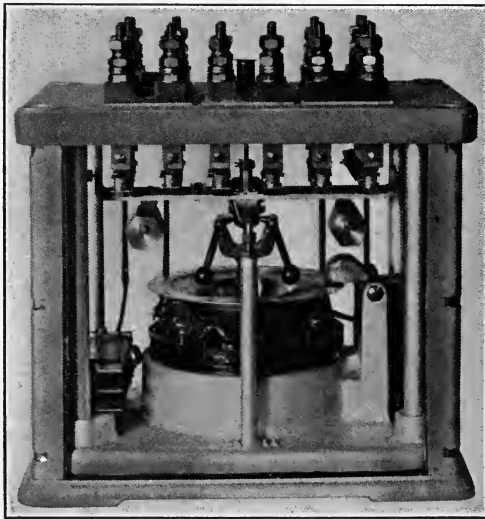

Fig. 18.

operating switchboard and indicator groups, made by the General Railway Signal Company. This machine has 38 levers for operating switches and signals and has 14 indicators. Such indicators are used for checking the correspondence of movement between the lever and the device which it operates, the indications being received after the operation of the device has been properly completed. The movement of a lever locks all levers conflicting with its new position and operates the device which it

controls. This interlocking of levers is performed at the "locking bed" located at the front of the machine, by horizontal *locking bars* carrying V-shaped dogs which engage notches in vertical *tappet bars*. Upon moving a lever, its tappet bar is moved vertically and one or more locking bars are moved by the dogs which engage them, and the

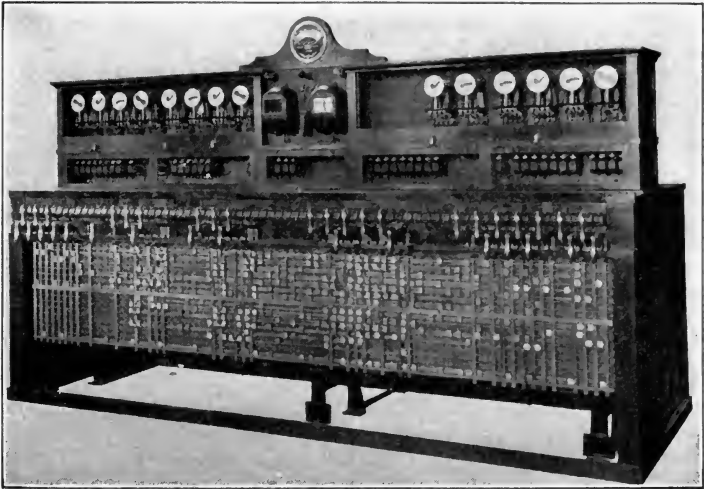

Fig. 19.

dogs carried by these bars move into the notches on certain tappet bars, thus locking their corresponding levers.

A simple illustration of the function of an interlocking machine will be considered in connection with Fig. 20 which represents the position of signals and derails at a single-track railway crossing. In this diagram 1, 6, 7 and 12 are distant signals, 2, 5, 8 and 11 are home signals, and 3, 4, 9 and 10 are derails, all devices being represented in their normal positions, that is, the derails open and semaphore blades horizontal. To permit a train to pass from

A to B requires that derails 3 and 4, and signals 1 and 2 must be reversed, and for proper protection to this train while on the crossing, derails 9 and 10, and signals 5, 6, 7, 8, 11 and 12 must be held normal. This is accomplished by the levers of the interlocking machine, which bear the same numbers as their corresponding devices. Therefore,

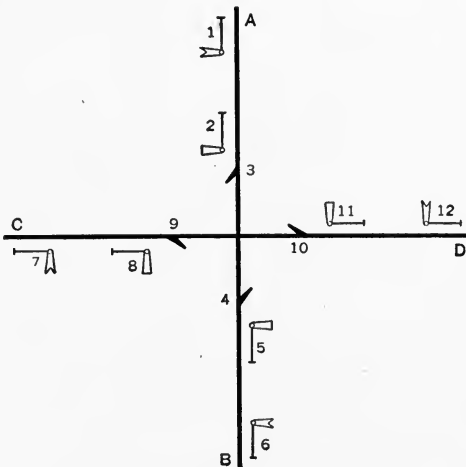

Fig. 20.

derail levers 3 and 4 when reversed should each lock derail levers 9 and 10 normal, and conversely. Further, to prevent levers 8 and 11 being reversed before levers 9 and 10 are reversed, it is necessary that levers 8 and 11 when reversed should each lock levers 9 and 10 reversed. Each distant signal when reversed locks its home signal reversed. Finally, lever 2 when reversed should lock lever 5 normal, and lever 8 when reversed should lock 11 normal. These operations may be tabulated in the form of a chart as shown on the next page, thus forming the *locking sheet* for the

interlocking machine. It will be observed that converse lockings are not duplicated, for it is understood that if one lever locks another lever normal, the opposite is also true, that is, the latter lever locks the former normal.

Lever	When reversed locks	
	Reversed	Normal
1	2	
2	3 4	5
3		9 10
4		9 10
5	3 4	
6	5	
7	8	
8	9 10	
9		
10		
11	9 10	8
12	11	

### PROBLEMS

1. At what minimum separation may two cars travelling in the same direction be operated at full speed over a track with the signal arrangements shown in Figs. 5, 6, 7 and 8? Express the result in each case in terms of block lengths.

2. Describe the operation of the relays and semaphore signals of the automatic block signal system illustrated in Fig. 11 as a train advances from one track section to another.

3. A 1.3 volt primary battery supplies 0.5 ampere to one end of a track circuit 3600 feet long, at the other end of which is a 3.5 ohm track relay. The voltage measured from rail to rail at frequent intervals along this track section showed a drop of 3.5 millivolts for each 30-ft. track length, this being due to resistance of track and bonds, and to leakage across ballast and ties. What percentage of the battery current traverses the relay?

4. Draw up the locking sheet for an interlocking machine to be installed at a single-track railway junction at which the signals and switches are located as shown below. The distant signals 1, 2, 8 and 11 show the indications of the home signals 3, 4, 7 and 10 respectively;

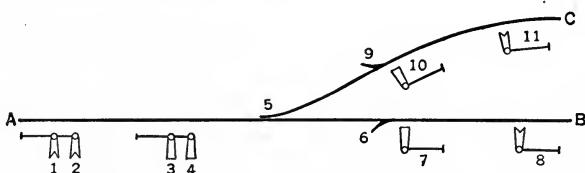

signals 1 and 3 apply to route AC, and signals 2 and 4 apply to route AB. Switch 5 is shown normally open, and the derails 6 and 9 are normally set to derail. It should be noted that lever 5 of the machine is under the immediate control of either lever 6 or 9, for lever 3 (or 4) cannot be reversed until lever 9 (or 6) has been reversed.



## CHAPTER IX

### TELEGRAPH LINES AND CABLES

**1. Aerial Open Lines.**— Line conductors for telegraphic signalling may be: bare wires mounted overhead at some distance from each other on poles or towers; insulated wires grouped together, forming a cable, and usually enclosed in a lead sheath, either suspended at short intervals from a steel cable fastened to poles or else drawn into underground conduits; or cables comprising one or more well-insulated conductors surrounded by a waterproof covering and steel armor, as in submarine cables. These types will be considered in the order mentioned.

For overhead telegraph lines galvanized iron of various grades, hard-drawn copper and sometimes steel or copper-clad steel wire are employed. The sizes, weights and resistances of the conductors generally used are given in § 8 of Chap. I. The increasing adoption of copper for telegraph lines is due to its low resistance (about one-sixth that of iron), its high tensile strength (45,000 to 68,000 pounds per square inch) and its non-corrosion under ordinary atmospheric conditions.

*Joints.*— Lengths of iron line wire are usually joined by placing the two ends side by side and winding half the overlap of each wire spirally around the other; this is called the Western Union joint. For joining copper line wires the McIntyre connector is widely used, which consists of a double copper tube, of correct size to fit the line

wire. The ends of the wires are inserted from opposite ends, one through each of the twin tubes, and the sleeve is then twisted through three complete turns. Such joints do not require soldering.

*Insulators.*—The insulators for supporting bare overhead telegraph lines in this country are generally constructed of glass, and sometimes of porcelain. The design of the standard form of insulator is shown at the left of Fig. 1, the dimensions in inches being indicated thereon. Its small diameter, coupled with the relatively large distance along the surface from the wire groove to the insulator pin, conduces to the maintenance of high-insulation resistance despite accumulations of dirt and other foreign matter on the insulator surface. The insulator at the right of Fig. 1 shows the standard form of two-piece transposition insulator. Insulators having double flanges or “petticoats” at the bottom are sometimes used when greater insulation resistance is desired.

The line wire when attached to the insulators is not passed around the insulator but is laid in the groove at one side and is tied in this position by short pieces of wire of the same size as the line wire and which pass around the insulator. The middle portion of Fig. 1 shows the standard type of insulator pin for supporting the insulators on the pole cross-arms. They are commonly made of chestnut, locust or oak, both the shank and thread being tapered. Wood-top steel pins and wood bracket-pins are also used, the latter being fastened directly to the pole (Fig. 4).

*Poles.*—Wooden poles are most generally used for supporting aerial telegraph or telephone lines, except where unusually large spans demand strong towers of steel or re-

inforced concrete. In this country white cedar, chestnut, cypress, pine and redwood poles are principally used for this purpose. These poles are from 20 to 80 feet in height, but those from 25 to 40 feet are the more usual. The height of poles to be used in a given locality is governed by several conditions, such as ordinances requiring a minimum distance of the lowest wire above the ground,

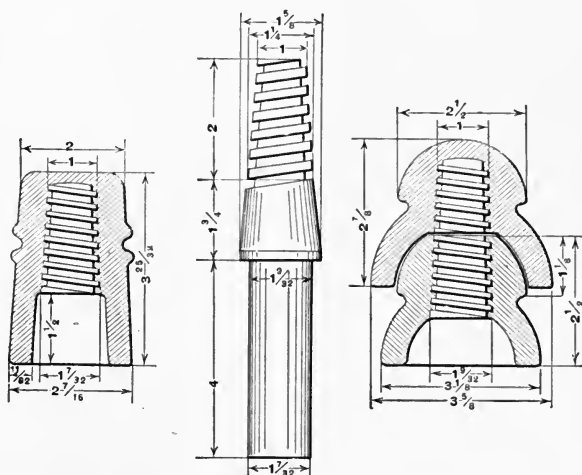

Fig. 1.

non-interference of the wires with the possible activities of the fire department, clearance at trolley and railway crossings, etc. The poles are from 5 to 8 inches in diameter at the top, with an increase in diameter of about one inch in every 10 feet toward the bottom. Poles are set from 5 to 10 feet into the ground, according to the height of the pole and the nature of the soil. In many cases it is desirable to treat the lower ends of the poles so as to minimize decay where they are embedded in the ground. This

treatment consists of applying a preserving fluid, such as creosote or carbolineum oil, applied by pressure, dipping or by brush. Poles decayed at the ground may be repaired by placing a rigid collar of reinforced concrete around the decayed portion of the poles.

The size of the poles should be selected so that the transverse forces, due to the tension in the wires at turns in the line and to wind pressure on poles and wires, do not exceed the breaking stress of the pole. The pull, exerted at the center of load at a point  $L_c$  feet above the ground, that will break a circular-sectioned pole having a diameter  $d$  feet at the ground line, may be expressed as

$$F = \frac{Ad}{8L_c} S \text{ pounds,} \quad (1)$$

where  $A$  is the cross-sectional area of the pole at the ground in square inches and  $S$  is the tensile strength in pounds per square inch. Accepted values of the maximum fibre stress  $S$  for some woods are given below:

Chestnut.....	6,000-10,000	} pounds per sq. in.
Cypress.....	5,000- 8,000	
White cedar.....	4,000- 8,000	
Yellow pine.....	4,000- 8,000	

In proper designs much lower values of this maximum fibre stress are employed, thereby allowing a considerable factor of safety.

At a turn in the line, if the horizontal angle between the directions of the wires at either side of the pole be  $\theta$ , and the tension in each of  $N$  wires be  $T$  pounds, then the transverse force acting on the pole at a height  $L_c$  feet above the ground is

$$F' = 2 NT \cos \frac{\theta}{2} \text{ pounds,} \quad (2)$$

which assumes that the tension in the wires is the same on both sides of the pole. The wind pressure on the pole, having an average diameter of  $d_a$  feet and a height of  $H$  feet above the ground, will be equivalent to a force of  $Kd_aH$  pounds acting at the center of the pole, where  $K$  is the wind pressure per square foot of projected pole area, usually taken as a maximum of 8 pounds. This force acting at the center of the pole may be replaced by a force at the center of load of, say,  $0.6 Kd_aH$  pounds acting at a point distant  $L_c$  or  $\frac{5}{6}$  of the pole height from the bottom. If the wind blows in the direction of the resultant transverse force  $F'$ , the wind pressure on the wires will be  $\frac{KNld_i}{12} \sin \frac{\theta}{2}$ , where  $l$  is the distance between poles in feet, and  $d_i$  is the diameter of each conductor over a possible ice coating, in inches. Therefore the maximum wind pressure on the pole and wires which may assist the transverse force on the pole at a turn in the line is

$$F'' = K \left( 0.6 d_a H + 0.0833 N l d_i \sin \frac{\theta}{2} \right) \text{ pounds,} \quad (3)$$

and consequently a pole should be selected so that

$$F > F' + F''$$

with a considerable factor of safety. If this requirement demands a pole of unusually large diameter for an assumed factor of safety and for a given angular change in the direction of the pole line, a smaller pole may be used if reinforced by the use of guy wires or braces of suitable types. Such reinforcement is generally utilized with terminal poles, with poles at the ends of long wire spans or with poles near a curve or corner. Fig. 2 indicates the method of guying a line at a road crossing.

To consider a specific example, assume a bend of 160 degrees in a 24-wire, 3-arm pole line of No. 9 B. & S. gage copper wire, supported on white-cedar poles projecting 30 feet above the ground and spaced 130 feet apart. If the maximum fibre stress be taken as 6000 pounds per square inch, and the diameter of the pole at the ground is 1 foot, and at the top is 8 inches, the transverse force on the

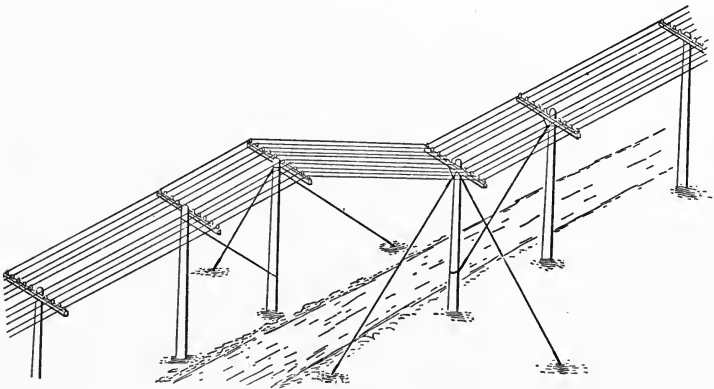

Fig. 2.

corner pole acting at the center of load (say at a point 25 feet from the ground) necessary to break the pole is

$$F = \frac{\pi (6)^2 \times 1}{8 \times 25} 6000 = 3390 \text{ pounds.}$$

If the tension of each wire be 200 pounds, the transverse force due to wire tension at the corner pole is

$$F' = 2 \times 24 \times 200 \cos \frac{160^\circ}{2} = 1670 \text{ pounds,}$$

and if the outside diameter of the ice-covered wire be taken as 1.114 inches, thereby allowing  $\frac{1}{2}$  inch of ice all

around the conductors, the transverse force due to wind pressure is

$$F'' = 8 \left( 0.6 \frac{8 + 12}{2 \times 12} 30 + 0.0833 \times 24 \times 130 \times 1.114 \sin \frac{160^\circ}{2} \right) \\ = 2376 \text{ pounds.}$$

Thus, the total transverse force that may act on the pole under consideration is  $1670 + 2376 = 4046$  pounds, a force greater than the assumed breaking stress of the pole, or 3390 pounds. Therefore this corner pole must be firmly guyed or braced in order to maintain telegraphic service over this line in times of severe wind and sleet.

*Cross-arms.*—The cross-arms for a telegraph pole are made of sound, thoroughly seasoned straight-grained timber, either creosoted or painted. The standard cross-arms measure  $3\frac{1}{4}$  by  $4\frac{1}{4}$  inches, and may vary in length from 3 to 10 feet, depending upon the number of wires accommodated. These cross-arms are attached to the poles by placing them in *gains* or slots cut in the poles and securing them in position either by lag-screws or by bolts which pass through the pole.

The strength of standard cross-arms is indicated in the following table, which gives the results of recent tests conducted by the Forest Service on 6-foot, 6-pinch cross-arms:

	Average maximum downward load in pounds
Longleaf pine (75 per cent heart) . . . . .	10,180
Longleaf pine (100 per cent heart) . . . . .	9,780
Longleaf pine (50 per cent heart) . . . . .	8,980
Shortleaf pine . . . . .	9,260
Shortleaf pine (creosoted) . . . . .	7,650
Douglas fir . . . . .	7,590
White cedar . . . . .	5,200

Cross-arms are further secured by iron or steel braces, as indicated in Fig. 3, which also shows the usual spacing in inches of insulators and cross-arms.

Poles at line terminals or at the ends of long spans are

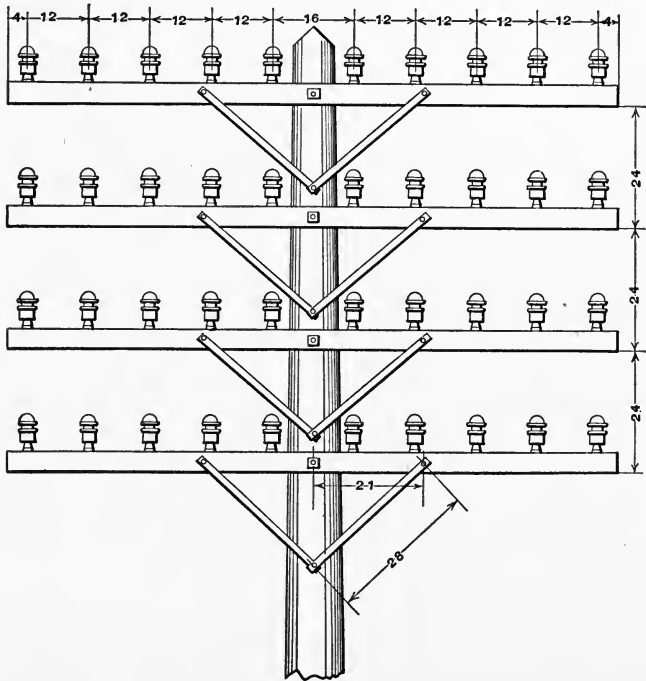

Fig. 3.

usually provided with double cross-arms, placed on opposite sides of the poles and bolted together.

*Lightning Arresters.* — To protect pole lines against destruction by lightning, it is common practice to lead a ground wire to the top of at least every tenth pole. Fig. 4 shows one arrangement employing a double-grooved in-



sulator mounted on a bracket pin. It will be observed that a small gap is formed between the ground wire and the line wire, over which a lightning discharge may take place and pass to ground. The lower end of the ground wire usually connects with an iron pipe driven into the ground at least two feet away from the pole.

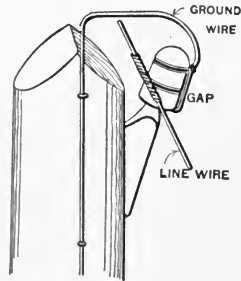

Fig. 4.

2. **Wire Spans.**—In suspending wires from pole cross-arms, the tension of the wire should be such that at the lowest attainable temperature the tension due to the weight of the wire with possible coverings of sleet and snow and due to wind pressure must not exceed a predetermined value. The physical constants of various sizes of hard-

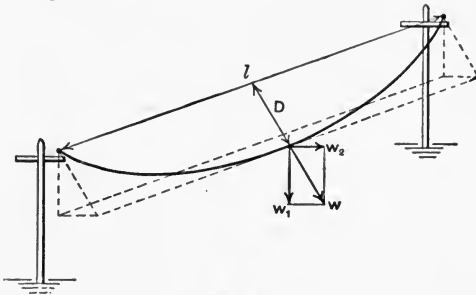

Fig. 5.

drawn copper and galvanized iron wire are given in the following table. The values of tensile strength given in this table should not be used directly in determining the proportions of wire spans, but should be divided by a proper factor of safety, say 2 to 4, so that the wire may

withstand excessive momentary loads to which the line may be occasionally subjected.

Hard-drawn Copper					Galvanized Iron Wire				
Modulus of Elasticity = 16,000,000 pounds per sq. in.					Modulus of Elasticity = 26,000,000 pounds per sq. in.				
Coefficient of Expansion = 0.000095 per deg. fahr.					Coefficient of Expansion = 0.000067 per deg. fahr.				
B. & S. Gage No.	Diameter in inches	Area in square inches	Tensile strength in pounds	Weight in pounds per foot	B.W.G. No.	Diameter in inches	Area in square inches	Tensile strength in pounds	Weight in pounds per foot
9	0.114	0.01028	630	0.0396	4	0.238	0.0445	2120	0.1490
10	0.102	0.00815	525	0.0314	5	0.220	0.0380	1820	0.1275
11	0.091	0.00646	420	0.0249	6	0.203	0.0324	1550	0.1085
12	0.081	0.00513	330	0.0198	7	0.180	0.0254	1210	0.0853
13	0.072	0.00407	270	0.0157	8	0.165	0.0214	1020	0.0716
14	0.064	0.00323	213	0.0124	9	0.148	0.0172	820	0.0578
					10	0.134	0.0141	670	0.0474

In determining the proper sag of a wire span, the maximum weight of the wire with sleet or ice loads must be known. In view of the variation of climatic conditions, it is usual to assume an ice coating of  $\frac{1}{2}$  inch thickness all around the wire as the severest load, the weight being 0.033 pound per cubic inch. Wind pressure must also be considered, this force being assumed horizontal and perpendicular to the wire. The maximum wind pressure may be taken as 8 pounds per square foot of projected area of the wire or of the ice cylinder; this value corresponds approximately to a wind velocity of 60 miles per hour. The minimum temperature may be considered as  $-20$  deg. fahr. and the maximum temperature as  $120$  deg. fahr., these temperatures being reasonable values for the northern part of this country.

Let  $w_1$  = weight of wire and ice per foot of wire length,

and  $w_2$  = wind pressure per foot of wire length, then the resultant force per foot will be

$$w = \sqrt{w_1^2 + w_2^2}, \quad (4)$$

and the wire will assume the position indicated in Fig. 5. With relatively small spans, the curve assumed by a wire suspended between two insulators approximates with sufficient accuracy to a parabola. On this assumption the sag in feet at the lowest probable temperature will be

$$D = \frac{wl^2}{8T}, \quad (5)$$

where  $w$  is the resultant force in pounds per foot of wire length,  $l$  is the distance between the supporting insulators on the same horizontal level in feet, and  $T$  is the maximum allowable tension in the wire in pounds (assumed uniform throughout the length of the wire).

The length of the wire in feet may be expressed as

$$L = l + \frac{8D^2}{3l}. \quad (6)$$

If this wire were removed from the supports and laid on the ground its length would be

$$L_u = \frac{L}{1 + \frac{T}{AE}}, \quad (7)$$

where  $L_u$  is the unstressed length of the wire in feet,  $A$  is the area of the wire cross-section in square inches and  $E$  is the stretch modulus of elasticity of the wire material in pounds per square inch.

Inasmuch as wires are strung without ice coverings and usually in fair weather on other than the coldest days, it is

desirable to know what sags to allow at the higher temperatures so that, with the severest external loading at lowest temperature, the tension will not exceed the maximum allowable value. The increase of the unstressed length  $L_u$  due to a temperature rise of  $t$  Fahr. degrees above the former temperature is  $L_u kt$ , where  $k$  is the temperature coefficient of linear expansion per Fahr. degree reckoned from the former temperature. Therefore the total unstressed length of the wire at the higher temperature will be

$$L_t = L_u (1 + kt); \quad (8)$$

but when strung its length will be

$$L_{st} = L_t \left( 1 + \frac{T'}{AE} \right), \quad (9)$$

where  $T'$  is the tension of the wire at the higher temperature. Also by analogy with equations (5) and (6), the sag at this temperature is

$$D_t = \frac{w_0 l^2}{8 T'}, \quad (10)$$

and the length of the wire is

$$L_{st} = l + \frac{8 D_t^2}{3 l}, \quad (11)$$

where  $w_0$  is the resultant force per foot of wire length with no ice covering.

In order to find the sag  $D_t$  of the wire without ice at any temperature in terms of the unstressed length  $L_u$  at the lowest temperature, eliminate  $L_t$ ,  $L_{st}$  and  $T'$  from equations (8) to (11), and there results,

$$D_t^3 - \frac{3l}{8} [L_u (1 + kt) - l] D_t - \frac{3 L_u (1 + kt) w_0 l^3}{64 AE} = 0.$$

This cubic equation is of the form

$$D_i^3 - 3 PD_i - 2 Q = 0, \quad (12)$$

where

$$P = \frac{l}{8} [L_u (1 + kt) - l] \quad (13)$$

and

$$Q = \frac{3 L_u (1 + kt) w_0 l^3}{128 A E}. \quad (14)$$

The solution of equation (12) is

$$D_i = 2 \sqrt{P} \cos \left( \frac{1}{3} \cos^{-1} \frac{Q}{\sqrt{P^3}} \right) \quad (15)$$

when  $P^3 > Q^2$ , but when  $P^3 < Q^2$  hyperbolic cosines must be used.

As an illustration, consider a No. 9 B. & S. gage hard-drawn copper wire suspended between insulators 130 feet apart, the factor of safety being taken as 2. From the foregoing table,  $T = \frac{630}{2} = 315$  pounds,  $A = 0.01028$  square inch, the wire diameter = 0.114 inch and the weight of copper per foot = 0.0396 pound. The outer diameter of an ice coating  $\frac{1}{2}$  inch thick all around the wire would be 1.114 inch, and the weight of this covering would be  $\frac{\pi (1.114 + 0.114)}{4} \times 12 \times 0.033 = 0.382$  pound per foot.

The wind pressure would be  $\frac{8 \times 1.114}{12} = 0.743$  pound per linear foot. Whence

$$w = \sqrt{(0.0396 + 0.382)^2 + (0.743)^2} = 0.854,$$

and the sag at the lowest temperature (say -20 deg. fahr.) becomes, from equation (5),

$$D = \frac{0.854 (130)^2}{8 \times 315} = 5.73 \text{ feet.}$$

The length of the wire when unstressed is therefore

$$L_u = \frac{130 + \frac{8(5.73)^2}{3 \times 130}}{1 + \frac{315}{0.01028 \times 16,000,000}} = \frac{130.674}{1.0019} = 130.43 \text{ feet.}$$

To find the sag at 120 deg. Fahr., substitute the foregoing

value of  $L_u$ ,  $w_0 = \sqrt{(0.0396)^2 + \left(\frac{8 \times 0.114}{12}\right)^2} = 0.0857$ ,

and  $t = 140$  in equations (13) and (14). Thus,

$$P = \frac{130}{8} [130.43 (1 + 0.0000095 \times 140) - 130] = 9.75,$$

and

$$Q = \frac{3 \times 130.43 (1 + 0.0000095 \times 140) 0.0857 (130)^3}{128 \times 0.01028 \times 16,000,000} = 3.51.$$

Since  $P^3 > Q^2$ , the sag at this temperature, from equation (15), is

$$\begin{aligned} D_t &= 2 \sqrt{9.75} \cos \left( \frac{1}{3} \cos^{-1} \frac{3.51}{\sqrt{(9.75)^3}} \right) \\ &= 6.24 \cos 27^\circ 47' = 5.52 \text{ feet,} \end{aligned}$$

and its vertical component is

$$D'_t = \frac{0.0396}{0.0857} 5.52 = 2.55 \text{ feet.}$$

For unusually long spans, such as river crossings, wire of steel or copper-clad steel are more suitable than of hard-drawn copper or galvanized iron.

**3. Economical Span Length.**—To determine the pole spacing conducive to a minimum annual maintenance charge on the supporting structures of an aerial line, let

$n$  = economic number of poles per mile,

$h$  = minimum required distance of wires above ground in feet,

$H$  = height of pole above ground in feet,

$C_i$  = cost of cross-arms, insulators and pins per pole in dollars,

$r$  = average interest and depreciation rate on poles, insulators, etc.,

$w_1$  = weight per foot of wire in pounds at maximum sag,

$T$  = tension in conductor in pounds at maximum sag, and  $D'$  = maximum vertical sag in feet.

Assume that the cost of the line wire will not vary with the pole spacing, and that the cost of the poles ready to set varies as the square of their height, or  $C_p = aH^2$  dollars, where  $a$  is a constant. Then the pole spacing is  $l = \frac{5280}{n}$  feet, and the height of the poles is (see § 2)

$$H = h + D' = h + \frac{w_1 l^2}{8T} = h + \frac{w_1}{8T} \left( \frac{5280}{n} \right)^2 \text{ feet.} \quad (16)$$

The cost of line material per mile, exclusive of conductors, is

$$C = n(C_i + C_p) \text{ dollars;}$$

consequently the annual expense per mile for maintaining the pole line is

$$C_a = rn \left\{ C_i + a \left[ h + \frac{w_1}{8T} \left( \frac{5280}{n} \right)^2 \right]^2 \right\} \text{ dollars.} \quad (17)$$

To determine the minimum annual expense equate to zero the differential coefficient of  $C_a$  with respect to  $n$ . Then

$$\frac{dC_a}{dn} = rC_i + arh^2 - \frac{arw_1h(5280)^2}{4Tn^2} - \frac{3arw_1^2(5280)^4}{64T^2n^4} = 0,$$

or

$$n^4 - \frac{arw_1h(5280)^2}{4T(C_i + ah^2)}n^2 - \frac{3arw_1^2(5280)^4}{64T^2(C_i + ah^2)} = 0. \quad (18)$$

This equation is of the form  $x^2 - px - q = 0$ , and when  $p$  and  $q$  are positive quantities the solution may be written

$$\text{as } x = \frac{p}{2} + \sqrt{\left(\frac{p}{2}\right)^2 + q}. \quad \text{If } n^2 = x,$$

$$p = \frac{arw_1h(5280)^2}{4T(C_i + ah^2)}, \quad (19)$$

and

$$q = \frac{3arw_1^2(5280)^4}{64T^2(C_i + ah^2)}, \quad (20)$$

then

$$n = \sqrt{\frac{p}{2} + \sqrt{\left(\frac{p}{2}\right)^2 + q}}. \quad (21)$$

As an illustration, consider the following values suggestive of the order of magnitude of the cost constants for a 3-arm 24-wire pole line with poles 6 inches in diameter at top:

$$\begin{aligned} a &= 0.006, \\ C_i &= 1.50, \\ r &= 0.15. \end{aligned}$$

Then for No. 9 B. & S. gage hard-drawn copper wires covered with ice  $\frac{1}{2}$  inch thick all around and suspended with a factor of safety of 3, at the minimum distance of 20 feet above the ground,

$$T = 210 \text{ pounds,}$$

and

$$w_1 = 0.422 \text{ pound per foot (page 265).}$$



For these constants

$$p = \frac{0.006 \times 0.422 \times 20 (5280)^2}{4 \times 210 (1.50 + 0.006 \times 20^2)} = 430,$$

and  $q = \frac{3 \times 0.006 (0.422)^2 (5280)^4}{64 (210)^2 (1.50 + 0.006 \times 20^2)} = 226,000;$

whence from equation (21) the economic pole spacing is

$$n = \sqrt{215 + \sqrt{(215)^2 + 226,000}} = 27 \text{ poles per mile.}$$

The height of towers to be used, and the annual maintenance of the supporting structure for the wires, may now be found from equations (16) and (17) respectively, yielding  $H = 29.5$  feet above ground, and  $C_a = 27$  dollars per mile.

**4. Telegraph Cables.**—Aerial and underground telegraph cables are formed of any desired number of annealed copper wires, from No. 14 to No. 19 B. & S. gage, individually insulated with prepared paper, fibre or sometimes rubber. These conductors are assembled in layers, forming a cylindrical group or *core* and held in shape by one or more spiral coverings of paper, and the whole is then enclosed in a lead sheath or else is covered with tarred jute and is surrounded by a cotton braid saturated with water-proof compound. Lead-covered paper-insulated cables are now principally used in telegraphy, and are called *saturated-core* cables if the paper insulation is saturated with an insulating compound, or *dry-core* cables if the insulation is untreated. The saturated-core cables excel the dry-core cables in the protection afforded in case of mechanical injury, but have a higher electrostatic capacity, due to the larger specific inductive capacity of the insulating compound. Low capacity is especially desired in telephonic

transmission and therefore dry-core cables with somewhat smaller wires (usually of No. 19 to No. 22 B. & S. gage for local distances) are considered standard practice. In order to exclude moisture from dry-core cables, the ends of sections when supplied by manufacturers, are always saturated with paraffin or other insulating compound for a distance of about two feet, and the lead sheath is then hermetically sealed. The sheaths for cables may be of pure lead, lead and antimony composition, or lead with a small percentage of tin; their minimum thicknesses are outlined in the following table.

Number of conductors	Thickness of sheath
10 to 100	Inch $\frac{5}{64}$
100 to 200	$\frac{8}{32}$
200 to 400	$\frac{7}{64}$

The conductors of a paper-insulated cable may have a single, double or triple wrap of manila rope paper spirally applied, the thickness of each being from 0.004 to 0.008 inch. The thickness of the insulation around the conductors of a rubber-insulated aerial or underground telegraph cable varies from 20 to 60 mils.

Telegraph companies usually specify that the individual rubber-insulated conductors for a telegraph cable be immersed in water for 24 hours and thereafter while still immersed be able to withstand an alternating electro-motive force of 1000 volts, applied for one minute between the conductor and the water. With dry-core cables the finished lead-covered cable is subjected to a similar test. The insulation resistance of each conductor is then

measured by an application of 100 volts for one minute across this conductor and all the other wires and the sheath, the reference temperature being 60 deg. fahr. A table showing the variation of the average insulation resistance with temperature is usually supplied by the cable manufacturer.

Cables are also used where telegraph lines extend across rivers, lakes and bays, or from the mainland to islands. Such submarine cables are formed of either rubber- or paper-insulated conductors within a lead sheath, this sheath being covered with several layers of jute thoroughly saturated with a waterproof compound. Cables to be installed on rocky river-beds or in waters having rapid currents are provided in addition with an armor of galvanized iron wire, which is surrounded by jute servings saturated with a compound of pitch and fine sand.

The telegraph cable mileage in the United States in 1907 is tabulated below:

Location	Miles of cable	Miles of single wire in cables	Average number of wires per cable
Overhead.....	2589	40,066	15.5
Underground.....	1130	37,727	33.4
Submarine*.....	3769	7,382	2.0
Total.....	7488	85,175	

\* Exclusive of ocean cables.

The weights and prices of the Standard Underground Cable Company's telegraph cables, composed of No. 14 B. & S. gage conductors with fibre or paper insulation measuring  $\frac{5}{32}$  inch in diameter over insulation, are given in the following table:

Number of conductors	Diameter over sheath in inches	Weight in pounds per foot	Catalog price in cents per foot
5	0.76	1.41	25.1
10	0.97	1.93	33.9
20	1.16	2.55	45.7
50	1.63	4.23	81.2
100	2.18	6.54	133.9
150	2.55	8.45	181.5

*Aerial Cable Installation.*—In supporting overhead cables on pole lines it is necessary to provide supports between poles because the cable itself does not possess sufficient strength to sustain its own weight over ordinary pole spans. The required support is furnished by solid or stranded galvanized steel *messenger* wires of proper size, in accordance with the weight of the cable and length of span, to which the cable is fastened by means of appropriate hangers at intervals of about 2 feet. The messenger wire is fixed to the sides of poles or to their lower cross-arms by means of suitable messenger supports. The sizes and breaking stresses of various grades of steel messengers are given in the following table:

Diameter in inches		Weight in pounds per 100 feet	Breaking stress in pounds			
			Bessemer	Siemens-Martin	High-strength	Plow
Solid.....	0.192	9.8	....	2,500	4,300	6,000
	0.225	13.4	....	3,500	5,900	8,000
Stranded.....	0.250	13.0	2,500	3,060	5,100	7,600
	0.312	22.0	4,200	4,860	8,100	12,100
	0.375	30.0	5,700	6,800	11,500	17,250
	0.437	40.0	7,600	9,000	15,000	22,500
	0.500	52.0	9,800	11,000	18,000	27,000

The sags of messengers at different temperatures and the transverse stresses on aerial cable pole lines may be determined in the same manner as shown in § 2. One type of cable hanger, known as the metropolitan, is represented in Fig. 6.

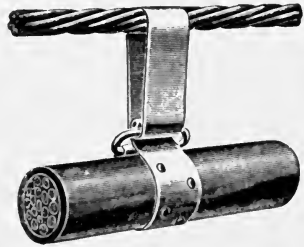

Fig. 6.

**5. Underground Cable Installation.** — In densely-populated localities it is customary to place telegraph and

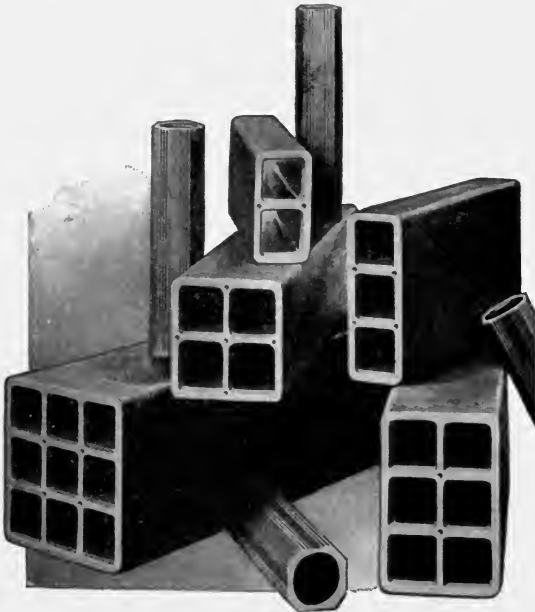

Fig. 7.

other electric cables underground. These cables are not buried in the ground, but are drawn into finished ducts

or conduit from one manhole to another. When laid, conduit having a sufficient number of ducts to allow for future growth is placed in a trench and is partially or entirely surrounded with concrete. Fibre and vitrified-clay conduits are those principally installed, but ducts may also be formed in concrete directly. Fig. 7 illustrates the single-duct and multiple-duct types of vitrified clay conduit manufactured by the H. B. Camp Company. The lengths of multiple-duct conduit are held in alignment by dowel pins and each joint is wrapped with a layer of wet muslin or burlap and thereafter plastered with cement mortar. The top of conduits should not be less than 20 inches below the street surface.

The arrangement of a six-duct conduit of concrete, fibre, multiple-duct clay and single-duct clay is shown in Fig. 8, with dimensions in inches. The total costs per trench foot of these types of conduit construction installed, including repaving but exclusive of manholes, as estimated by W. N. and C. L. Matthews, for various numbers of ducts, are given in the following table:

Number of ducts	Costs per trench foot in dollars			
	Concrete	Fibre	Multiple clay	Single clay
1	0.39	0.44	.....	0.51
2	0.56	0.67	0.73	0.76
3	0.73	0.88	1.03	1.05
4	0.83	0.91	0.98	1.09
6	0.97	1.22	1.37	1.46
8	1.17	1.55	1.64	1.92
12	1.40	1.98	2.11	2.45
16	1.67	2.42	2.72	3.01
20	1.95	2.94	3.22	3.63

This table is based upon the spacings shown in Fig. 8, but with multiple-duct vitreous clay conduit 1 inch of concrete is allowed between the sections, and it assumes that the conduit is laid in streets with granite or equivalent paving. Oftentimes the concrete at the sides of the con-

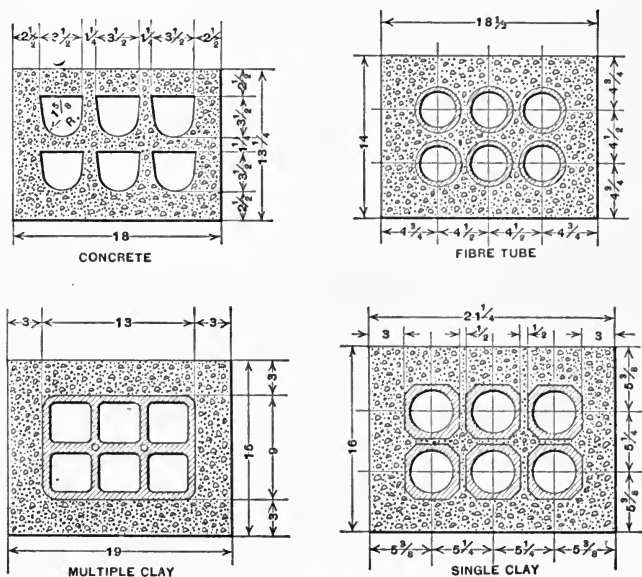

Fig. 8.

duit is dispensed with, thereby reducing the cost of installation.

Manholes, or conduit-openings, are located along the conduit line at suitable distances apart, rarely greater than 700 feet, to facilitate the installation, repair and removal of cable sections. The manholes are constructed of brick or concrete, in sizes of 3 ft. by 3 ft. and upwards, depending on the number of cables to be accommodated. Fig. 9

shows a section of an oval manhole whose inside dimensions are 7 ft. by  $3\frac{1}{2}$  ft. The costs of manholes of either construction vary from about \$60 to \$150 according to their size and the nature of the ground where they are installed.

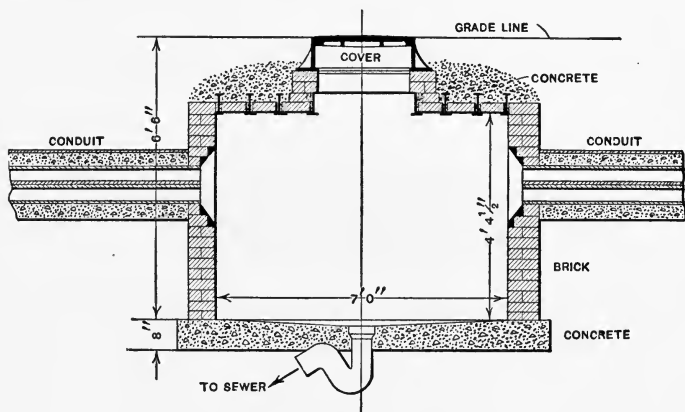

Fig. 9.

*Cable Splices.* — Aerial and underground cables are almost invariably spliced near poles or in manholes respectively. The method of making splices in multi-conductor paper-insulated cables is indicated in Fig. 10. Two cables to be spliced are placed in position so that their conductors overlap from 12 to 24 inches, depending on the number of conductors. The corresponding innermost conductors of the two cables are then twisted together as shown at A, and a paper or cotton tube is placed over the joint as shown at B. All others are similarly spliced with the joints staggered (C, Fig. 10), and then the entire splice is boiled out with paraffin and wrapped with muslin or linen. A lead sleeve, whose inside diameter exceeds the



outside diameter of the cable sheaths by 1 or  $1\frac{1}{2}$  inches, is then placed over the splice and is joined to the sheath by means of wiped soldered joints.

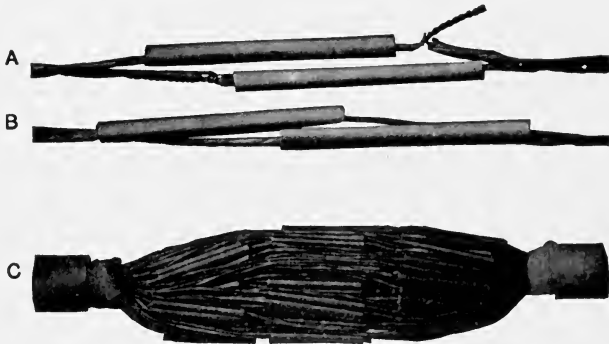

Fig. 10.

*Cable Pole Boxes.* — At suburban points beyond which it is not deemed necessary to extend underground cable lines, and at water crossings, cables are brought to the tops of poles and terminated in cable pole boxes, as shown in Fig. 11. Combined fuses and lightning arresters are located within this cable box, as shown at *f*, and are interposed between the bare aerial wires and the cable conductors.

*Electrolysis of Underground Cable Sheaths.* — If stray electric currents of an electric railway system, in wending their way back to the generating station, flow out of cable sheaths in moist locations at certain places, electrolytic decomposition of the sheaths occurs at these places, for the sheaths there behave as anodes in electrolytic cells. Continued electrolytic decomposition, or electrolysis, causes the pitting of the cable sheath, and the consequent admission of moisture to the insulation around the conductors within the protecting sheath. The extent of

electrolysis depends upon the number of ampere-hours conducted, since, according to Faraday's Law, one ampere flowing out of a lead sheath into an electrolyte for one hour would dissolve 3.87 grams of lead.

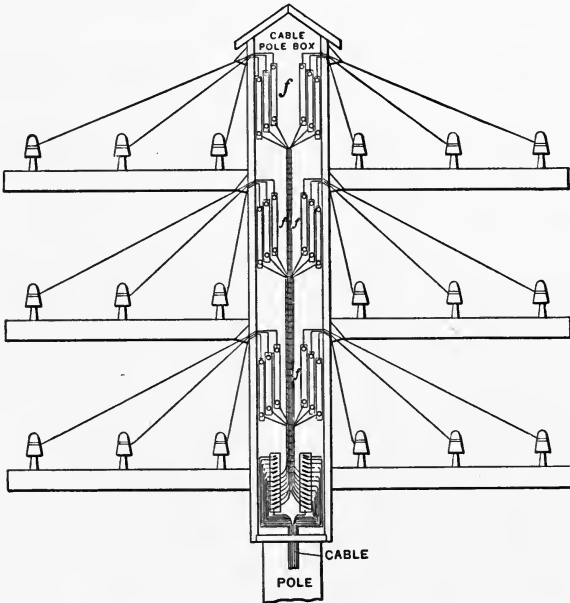

Fig. 11.

In order to locate the regions where this rapid corrosion of cable sheaths takes place, tests are made at manholes to determine the potentials of the sheaths with respect to the adjacent ground, and the amounts of current carried by them. By thus observing the direction and value of the stray currents at a number of manholes, the places where currents leave the cables and pass to the moist ground are readily determined. Where a cable sheath is found by test to be decidedly positive with respect to

ground or to the railway track, a temporary connection of heavy copper wire including an ammeter may be made from the sheath to a suitable ground, to the track, or to a neighboring negative feeder. Readings at other places where the sheath was positive to earth may then be repeated, and if conditions are improved, a permanent soldered bond is installed so that the current may flow from the cable along a wire instead of into an electrolyte. Where several cables pass through a manhole it is good practice to bond all of them together. After such bonds are in place, another complete and final survey is made. The use of negative track feeders of proper copper disposition, and possibly with negative boosters in these feeders, reduces the stray railway currents to a large extent.\*

**6. The Earth as a Return Path.**—Professor Steinheil in 1837 made the discovery that the earth may be used as a portion of an electric circuit. It has been stated that the resistance of the earth when used as a return circuit for a telegraph line is very small if the line terminals are properly grounded. To verify this statement, consider a hemispherical ground electrode of radius  $a$  centimeters to be buried a short distance below the earth's surface. The resistance of the earth outward from this electrode to a distance  $d$  centimeters is

$$R = \int_a^d \frac{\rho dr}{2\pi r^2}, \quad (22)$$

as expressed by Heaviside, where  $\rho$  is the specific resistance of the earth, assumed uniform, in ohms per centi-

\* See Sheldon & Hausmann's "Electric Traction and Transmission Engineering," p. 157; G. I. Rhodes' paper, A.I.E.E., Trans. 1907, p. 247.

meter cube, and  $r$  and  $r + dr$  are the radii of concentric hemispherical equipotential surfaces, in centimeters. The distribution of resistance outward from this electrode may be calculated from equation (22) by considering the resistances over the distances, say  $a$  to  $2a$ ,  $2a$  to  $4a$ , and so on. Thus

$$R_1 = \frac{\rho}{2\pi} \int_a^{2a} r^{-2} dr = \frac{\rho}{4\pi a} \text{ ohms,}$$

$$R_2 = \frac{\rho}{2\pi} \int_{2a}^{4a} r^{-2} dr = \frac{\rho}{8\pi a} \text{ ohms, etc.}$$

The following table shows the resistance values for the various distances from the electrode, and Fig. 12 shows the total resistance outward from the electrode for a particular case in which  $\rho = 800$  ohms per centimeter cube and  $a = 1$  foot = 30.5 centimeters.

Distance in centimeters	Resistance in ohms
$a$ to $2a$	$0.07958 \rho/a$
$2a$ to $4a$	$0.03979 \rho/a$
$4a$ to $8a$	$0.01989 \rho/a$
$8a$ to $16a$	$0.00994 \rho/a$
$16a$ to $32a$	$0.00497 \rho/a$
$32a$ to $64a$	$0.00248 \rho/a$
$64a$ to $128a$	$0.00124 \rho/a$

It is seen that the greater share of the ground resistance is very near the electrode, consequently good conductivity of the soil near the electrode is essential, but with greater distances from the electrode the earth's conductivity becomes of less importance. It is also to be noted that the resistance varies inversely with the size of the electrode, whence the desirability of utilizing available extensive municipal water pipes as ground electrodes.

Inasmuch as the resistance between two electrodes is principally in the neighborhood of these electrodes, the total resistance between them might be expressed as

$$R = \int_a^\infty \frac{\rho dr}{2\pi r^2} + \int_{a'}^\infty \frac{\rho dr}{2\pi r^2} = \frac{\rho}{2\pi} \left( \frac{1}{a} + \frac{1}{a'} \right), \quad (23)$$

where  $a$  and  $a'$  are the radii of the two electrodes respectively, it being understood that one electrode is not perfectly insulated from its mate. Some instances of almost complete electrical isolation of the ground at a locality from the earth have been observed. Thus, to secure telegraphic communication with Nashville, Tenn., it was found necessary to extend a ground-wire from that city to an effective ground

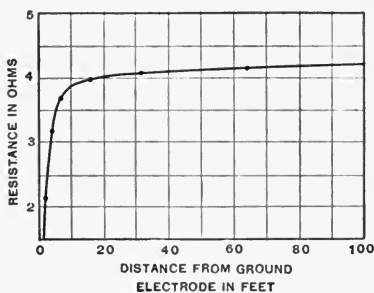

Fig. 12.

at a point several miles distant. On the other hand, large sections of the earth *between* two widely-separated stations may be perfectly insulating without materially increasing the resistance of the ground return.

When the pipes of a community's water supply are not available as a ground electrode, satisfactory ground connections may be made by driving two or more iron pipes about 2 inches in diameter into moist earth in the basement of the telegraph office. Line and office connections with such pipe grounds are of copper wire, usually larger than No. 9 B. & S. gage, well soldered to the pipes.

In the practical measurement of ground resistance either another permanent electrode presenting a known ground

resistance or two auxiliary temporary ground electrodes or *grounds* are used, these test grounds being at least 15 feet distant from each other and from the permanent main ground whose resistance is to be measured. In the first case the series resistance of the two grounds minus the resistance of the known ground gives to a fair degree of accuracy the resistance of the desired ground. In the second case, employing two auxiliary grounds in the measurement of the main ground, the resistance between each pair is observed. Then, if  $R_1$  be the series resistance between the main and first auxiliary grounds,  $R_2$  that between the main and second auxiliary grounds and  $R_3$  that between the two auxiliary grounds, it follows that the earth resistance at the main ground is

$$R = \frac{R_1 + R_2 - R_3}{2}. \quad (24)$$

The resistance of a ground will vary from time to time, depending upon the amount of moisture in the soil in the immediate neighborhood of the electrode. In practice these resistance measurements are made periodically, at least once a year.

The Western Union Telegraph Company specifies that the resistances of various classes of grounds should not in general exceed the following values:

Central office battery grounds.....	0.1 ohm,
Small office and test station grounds.....	5 ohms,
Lightning arrester grounds.....	15 ohms,
High-potential protection grounds.....	25-100 ohms.

**7. Electrical Constants of Telegraph Conductors.** — The four electrical constants of a line conductor are: resistance, inductance, capacity and leakance.

*Resistance.* — The resistance to direct currents of a wire of area  $A$  square inches, at any temperature  $t$  degrees cent., expressed in ohms per mile, is

$$R = 0.02495 \frac{\rho}{A} (1 + \alpha t), \quad (25)$$

where  $\rho$  is the specific resistance in microhms per centimeter cube of the material at  $0^\circ$  cent., and  $\alpha$  is the mean temperature coefficient of electrical resistance per centigrade degree reckoned from  $0^\circ$  cent. Accepted values of these constants for copper and iron follow:

Material	$\rho$	$\alpha$
Annealed copper (stand.)	1.587	0.00427
Hard-drawn copper . . . . .	1.631	0.00414
Galvanized iron . . . . .	9.69	0.0058

Tabulated values of the resistances of standard sizes of telegraph wire are given in Chap. I. The conductivity of commercial copper and bimetallic wire is usually specified as a percentage of that of standard annealed copper.

*Inductance.* — The self-inductance of a single linear cylindrical wire, mounted at a height  $h$  above the ground which serves as the return path, is

$$L = 0.000741 \log_{10} \frac{4h}{D} + 0.0000805 \mu \quad (26)$$

henrys per mile, where  $D$  is the diameter of the conductor and  $\mu$  is its permeability. A short table of logarithms appears in the appendix. The mutual inductance between two parallel ground-return wires, mounted at the same height above the ground and separated by a distance  $d$ , in henrys per mile, is

$$M = 0.000741 \log_{10} \frac{\sqrt{4h^2 + d^2}}{d}. \quad (27)$$

In these expressions,  $h$ ,  $D$  and  $d$  must be expressed in the same units. Therefore the total inductance of the two similar wires for equal currents in the same direction is

$$L_s = \frac{1}{2} (L + M), \quad (28)$$

while for equal currents in opposite directions is

$$L_0 = 2(L - M) \quad \text{or} \quad 0.00148'2 \log_{10} \frac{2d}{D} + 0.000161 \mu. \quad (29)$$

Equation (29) indicates that the inductance of wires within a grounded conducting sheath is very small, inasmuch as the sheath, which may be considered as the return path, is very near the conductors.

For compound conductors consisting of a steel core surrounded by a copper shell, the factor  $\mu$  in the foregoing equations is replaced by the values given in the following table for various ratios  $n$  of the conductivity of the compound wire to that of a solid copper wire of the same outside diameter,  $\mu'$  being the permeability of the steel core.

$n$	Factor to replace $\mu$
0.2	$0.298 \mu' + 0.1292$
0.3	$0.1012 \mu' + 0.204$
0.4	$0.0416 \mu' + 0.294$
0.5	$0.0185 \mu' + 0.386$

This table, derived from that given by Fowle,\* assumes steel to have 12 per cent of the conductivity of copper.

*Capacity.* — The capacity of a single overhead wire utilizing ground as its return, in microfarads per mile, is

$$C = \frac{0.0894}{\cosh^{-1} \frac{2h}{D}}, \dagger \quad (30)$$

\* Electrical World, v. 56, p. 1474.

† Sheldon and Hausmann's "Electric Traction and Transmission Engineering," p. 230.



the symbols having the same significance as above. For large values of  $\frac{h}{D}$ , it is more convenient to use the very approximate equation

$$C = \frac{0.0894}{\log_{\epsilon} \frac{4h}{D}}, * \quad (31)$$

where  $\epsilon$  is the base of Napierian logarithms and is equal to 2.7183. Logarithms to the base  $\epsilon$  may be obtained by multiplying the corresponding logarithms to the base 10 by 2.3026; that is,  $\log_{\epsilon} x = 2.3026 \log_{10} x$ .

When a number of overhead wires are located near each other, the capacity of each wire is increased by the presence of the others. For two parallel ground-return wires suspended at the same height above the ground and separated a distance  $d$  from each other, Heaviside gives as the capacity of each wire in microfarads per mile:

$$C = \frac{0.0894 \log_{\epsilon} \frac{4h}{D}}{\left(\log_{\epsilon} \frac{4h}{D}\right)^2 - \left(\log_{\epsilon} \frac{\sqrt{4h^2 + d^2}}{d}\right)^2}. \quad (32)$$

Their mutual capacity in microfarads per mile is

$$C_m = \frac{0.0894 \log_{\epsilon} \frac{\sqrt{4h^2 + d^2}}{d}}{\left(\log_{\epsilon} \frac{4h}{D}\right)^2 - \left(\log_{\epsilon} \frac{\sqrt{4h^2 + d^2}}{d}\right)^2}. \quad (33)$$

As the number of wires in close proximity to each other increases, the formulæ for their individual and mutual

\* Sheldon and Hausmann's "Alternating Current Machines," p. 313.

capacities become more and more unwieldy for numerical computation.\*

Thus, for a single No. 9 B. & S. gage wire, suspended 25 feet above the ground, the capacity is

$$C = \frac{0.0894}{2.3026 \log_{10} \frac{4 \times 25 \times 12}{0.1144}} = 0.00966 \text{ mf. per mile.}$$

If another similar ground-return wire be placed horizontally 1 foot distant from the first, then

$$\log_e \frac{4h}{D} = 9.25 \quad \text{and} \quad \log_e \frac{\sqrt{4h^2 + d^2}}{d} = 3.91;$$

therefore the capacity of each wire, as obtained from equation (32), is now

$$C = \frac{0.0894 \times 9.25}{(9.25)^2 - (3.91)^2} = 0.01178 \text{ mf. per mile.}$$

The mutual capacity of the wires is found to be

$$C_m = 0.0050 \text{ mf. per mile.}$$

The capacity of a single-conductor cable within a concentric metallic sheath, in microfarads per mile, is

$$C = \frac{0.0894 k}{\log_e \frac{d}{D}}, \quad (34)$$

where  $k$  is the specific inductive capacity or permittivity of the homogeneous separating medium or dielectric,  $d$  is the inside diameter of the conducting sheath and  $D$  is the diameter of the conductor. If the dielectric consists of  $n$

\* Refer to Oliver Heaviside, "Collected Papers," v. 1, p. 45; Louis Cohen "Calculation of Alternating Current Problems," p. 97.

cylindrical layers having different specific capacities  $k_1, k_2, \dots, k_n$ , and of outer diameters  $d_1, d_2, \dots, d$  respectively, the capacity of the conductor in microfarads per mile is

$$C = \frac{0.0894}{\frac{1}{k_1} \log_{\epsilon} \frac{d_1}{D} + \frac{1}{k_2} \log_{\epsilon} \frac{d_2}{d_1} + \dots + \frac{1}{k_n} \log_{\epsilon} \frac{d}{d_{n-1}}}. \quad (35)$$

The capacity of multi-conductor dry-core paper-insulated aerial or underground cables, in microfarads per mile, are usually as follows:

B. & S. gage number	Mutual capacity	Grounded capacity
Telegraph cables.....	14	.....
	16	.....
	18	.....
Telephone cables.....	13	0.108
	16	0.108
	19	0.111-0.120
	22	0.105-0.125

The *mutual capacity* is that of a conductor with respect to its mate of a twisted pair, all the other wires being grounded to the sheath. The *grounded capacity* is that of one wire against all the others grounded to the sheath.

*Leakance.*—The reciprocal of the insulation resistance of a line, when expressed in ohms, is called the *leakage conductance* or *leakance* of the line and this constant may be expressed in terms of a unit which is often called the *mho*.

The insulation resistance of a well-constructed open line fastened to insulators that are mounted on poles or towers may be from about 50 to 100 megohms per mile in clear weather, but will drop to a fraction of a megohm during

prevailing wet and foggy weather. Thus, the leakance of the wire at insulators, at places where the wire touches trees, etc., due to moisture and dirt, is of the order of from  $10^{-5}$  to  $10^{-8}$  mhos.

The insulation resistance of a rubber- or paper-insulated wire within a sheathed cable is usually over 200 megohms per mile (at  $60^{\circ}$  fahr.) when laid, spliced and connected to terminals, each wire being measured against all the rest and the sheath. Submarine cables generally have an insulation resistance of over 1000 megohms per mile. The leakance of a properly-installed cable is not affected by weather conditions unless moisture enters as the result of mechanical injury to the cable sheath.

**8. Elimination of Inductive Interferences on Telegraph and Telephone Lines.**—Whenever direct currents are established, changed in intensity and stopped, or whenever alternating currents are maintained, in an electric circuit, electromotive forces are induced in all neighboring conductors (*a*) due to the varying *magnetic* field, the induced voltages being dependent upon the time-rate of change of current in the inducing circuit and the proximity of the wires to this circuit, and (*b*) due to the varying *electrostatic* field, the resulting current flow being dependent upon the time-rate of change of voltage in the inducing circuit and the proximity of the wires to this circuit. Thus, when telegraph and telephone circuits are located in parallel proximity to the lines of large alternating-current railway and power-transmission systems, the latter operating at voltages up to 150,000 volts, these circuits derive by electromagnetic and electrostatic induction sufficient voltages to interfere seriously with their

proper transmission of signals. Fig. 13 shows the disturbing effect on a ground-return telegraph line  $AB$  during the brief time that the alternating current in the disturbing wire  $CD$  is growing from zero to its positive maximum value, the full and dotted arrows on the telegraph line indicating respectively the currents produced electromag-

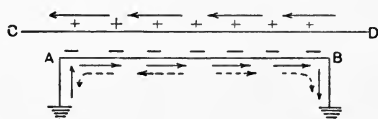

Fig. 13.

netically and electrostatically. The directions of these currents change repeatedly in unison with the current in the disturbing wire. With metallic circuits having the outgoing and return conductors close together, which is the almost universal arrangement of telephone lines, electromagnetic disturbances may be eliminated so far as the terminals are concerned by transposing the two wires of the telephone line at the center of exposure to the dis-

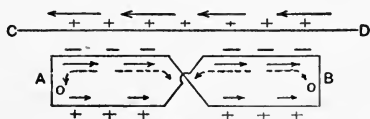

Fig. 14.

turbing wire, as shown in Fig. 14, for the same conditions as in the preceding figure. However, electrostatic disturbances, while reduced, are not eliminated, but it is evident that such disturbances may be minimized by frequent transposition of the two-line wires. When numerous aerial telephone lines are mounted on the same poles a careful consideration will yield a satisfactory arrangement of transpositions for the elimination of mutual disturbances

as well as those occasioned by adjoining power circuits. Fig. 15 shows a single aerial transposition made at a transposition insulator of the type represented at the right of Fig. 1.

Simple expedients for the elimination of small inductive interferences on earth-return telegraph lines have been de-

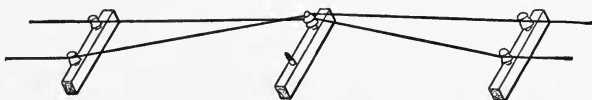

Fig. 15.

vised and usually involve: the addition of inductance and resistance to the line, shunting of relays with resistances or condensers, or the provision on each relay of a neutralizing winding which connects with one coil of a transformer whose other coil is inserted in the line wire. Severe inductive disturbances on grounded lines, however, require better neutralization. Conductors within metallic sheaths

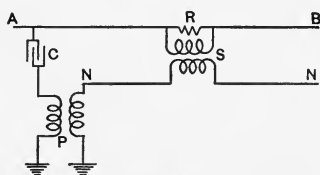

Fig. 16.

are shielded from electrostatic but not from electromagnetic induction.

Fig. 16 indicates one method for diminishing electrostatic and electromagnetic disturbances on a ground-return line.

At frequent intervals along the line one coil of current transformers  $S$  is bridged across a resistance  $R$  in the telegraph line  $AB$ , the other coil being properly joined in series with a neutralizing wire  $NN$ , or, if practicable, with the disturbing wire itself. Also a potential transformer  $P$  has one coil included in the neutralizing wire, and its other coil with a condenser  $C$  of proper capacity is

bridged from the telegraph wire to ground. This neutralizing wire is placed parallel and close to the telegraph line or lines and inasmuch as it is subject to the same magnetic effects as the signal wires, the currents developed in it are arranged to oppose by transformer action those developed in the telegraph lines, thereby neutralizing electromagnetic disturbance. Electrostatic induction is neutralized by the potential transformer  $P$  in a similar manner.

Another method\* particularly suitable for single-phase alternating-current railway systems and not requiring an additional conductor is shown in Fig. 17. The telegraph

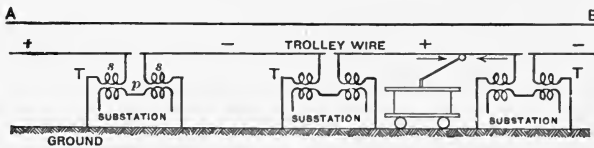

Fig. 17.

wire  $AB$  parallels the sectionalized overhead trolley wire which has alternate sections of opposite polarity, as indicated, in order to minimize electrostatic induction. Each section is fed at both ends from adjacent substations by means of the secondary windings  $s$  of the transformers  $T$ , whose primary windings  $p$  are connected across the high-tension transmission line, not shown. A car located between substations draws some current from each substation depending upon its distance therefrom, and these currents flow in opposite directions, the greater current over the shorter distance, and vice versa. Electromagnetic induction is neutralized by this arrangement.

The present method of overcoming the detrimental

\* Taylor's "Telegraph and Telephone Systems as Affected by Alternating-current Lines," Trans. A.I.E.E., v. 28, p. 1202.

effects of induction on the telegraph and telephone lines paralleling the single-phase lines of the New York, New Haven & Hartford Railroad, recommended by a committee including Mr. G. M. Yorke, is giving marked satisfaction in practical operation. The generator voltage of 11,000 volts is stepped up to 22,000 volts by means of auto-transformers *A*, Fig. 18, situated in the power station;

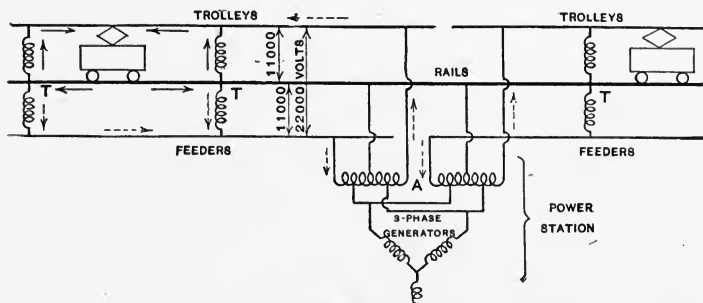

Fig. 18.

one terminal of each transformer joins with the contact conductors or trolleys, the other joins with feeders which extend along the roadway, and the mid-point connects to the rails. The arrangement is similar to three-wire direct-current distribution systems except that the direct load is on one side of the circuit, the other side receiving its share through the sectionalizing auto-transformers *T*, *T* situated on sectionalizing bridges at frequent intervals over the roadway. It will be seen that any train draws its current from the auto-transformers on either side, the directions of the currents in the 11,000-volt and 22,000-volt circuits being indicated by full and dotted arrows respectively. Inasmuch as the two parts of the current taken by a train flow in opposite directions toward this train, electromagnetic effects on adjacent telegraph and telephone lines are



neutralized. Since the feeders may be placed in the same general direction as the contact conductors with respect to neighboring lines, electrostatic disturbances may also be neutralized, although such disturbances were inappreciable along the electrified zone of the New Haven Railroad.

9. **Simultaneous Use of Lines for Telegraphy and Telephony.**—A pair of line wires forming a metallic telephone circuit may be utilized at the same time as one or two ground-return telegraph lines, without interference between the two classes of service. A single telegraph line may also be used simultaneously as a grounded telephone

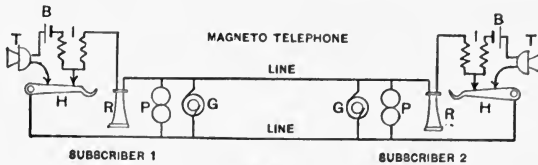

Fig. 19.

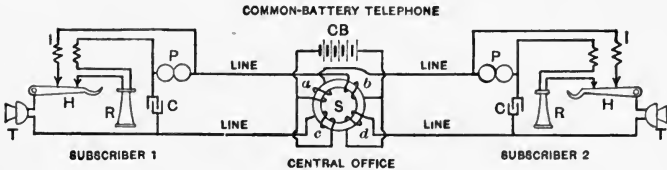

Fig. 20.

line. Such combined working is extensively employed for gaining increased earning capacity of the wire plant.

*Telephone Circuits.*—Figs. 19 and 20 show respectively the connections of the telephonic apparatus for the intercommunication of two subscribers joined to a *magneto* and a *common-battery* telephone system. Sound waves imping-

ing upon the diaphragm of a telephone transmitter vary its electrical resistance and consequently vary the current in the corresponding line circuit; the varying current flowing through the magnet of the telephone receiver produces a varying attraction for the iron diaphragm, the motions of which set up sound waves in the air which are similar to those incident on the transmitter diaphragm.

Each subscriber's set of a magneto telephone consists of a telephone transmitter *T*, telephone receiver *R*, hand-driven magneto or alternating-current generator *G* (open-circuited normally), polarized bell *P*, induction coil *I*, local battery *B* and receiver hook switch *H*. A subscriber's set of a common-battery exchange does not include a generator and local battery, but has a condenser *C* which keeps the set open-circuited to direct current when not in use; the circuit for such current is closed by the hook switch when the receiver is lifted therefrom in the act of calling and when conversing with another subscriber. Electrical energy for the operation of the common-battery telephone circuit is supplied by the battery *CB* located at the central office, this battery also supplying current to numerous other similar circuits, each circuit having its own repeating coil *S*. The apparatus at the central office used in the establishment and in the supervision of the connection between the two subscribers is not shown in the figure.

The repeating coil *S* is similar in design to the retardation coils used with the bridge duplex telegraph circuits (p. 71), except that the resistance of each of the four windings is usually from 20 to 40 ohms. Coils *b* and *c* form the primary winding, and coils *a* and *d* form the secondary winding of a transformer when subscriber 1 is talking, the reverse being true when subscriber 2 is talking.

Variations in current magnitude in one subscriber's circuit are thus inductively transferred to the circuit of the other subscriber.

*Simplex Signalling over Telephone Lines.* — The *simplex simultaneous* signalling system affords the transmission of one telephone and one telegraph message over one pair of wires, as indicated in Fig. 21. The two wires are used as

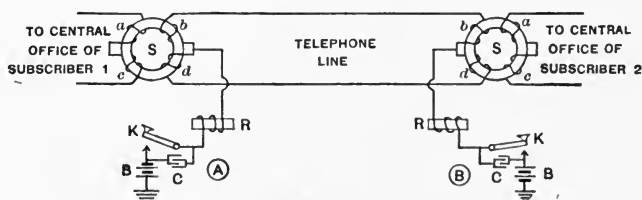

Fig. 21.

a metallic telephone circuit, and both wires in parallel are used as the line wire of a ground-return telegraph line. The junctions between the coils *b* and *d* of the two repeating coils *S,S* connect with the usual telegraphic apparatus at single Morse stations. When the lines and repeating coils are properly balanced, the current for actuating the telegraph relays divides equally between the two-line wires in flowing from station *B* to *A*, and these portions flow in opposite directions around the iron cores of the repeating coils, thereby contributing no magnetization to the cores. Consequently the telegraph currents will not affect the telephone instruments which connect with the repeating coil windings *a* and *c*. Inasmuch as the points of attachment of the telegraphic apparatus are neutral points of the telephone line, the telephone voice and ringing currents will not affect the telegraph relays. The simultaneous transmission of both messages is improved

by the shunting of condensers  $C$  around the key contacts. It is evident that the resistance of the telegraph line circuit is only half that of one of the telephone lines.

Intermediate telegraph stations may be readily introduced into the circuit of Fig. 21 by inserting two retardation coils and joining the mid-points of their coils to the telegraph apparatus at the intermediate office.

In telephony, an extension of the circuit arrangement, shown in Fig. 21, whereby two telephone circuits each with two repeating coils permit of the establishment of a third telephone circuit, is much used for long-distance transmission. This third, or so-called *phantom* circuit, utilizes the two conductors of one of the *side* or *physical* circuits as the outgoing conductor, and the two conductors of the other physical circuit as the return (see Fig. 24), with an obvious gain in transmission efficiency.

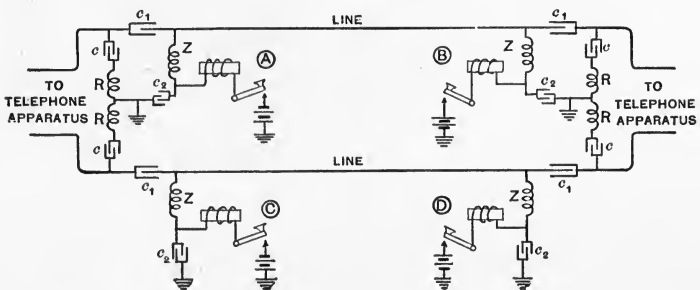

Fig. 22.

*Composite Signalling.* — Composite simultaneous signalling secures the transmission of one telephone and two telegraph messages over one pair of wires, each telephone wire serving as a ground-return telegraph line. Pioneer work in this field was done by Van Rysselberghe. Fig. 22 shows a modernized arrangement of the composite system,

and it will be observed that impedance coils and condensers, for opposing respectively the alternating telephone and the direct telegraph currents, are the principal features.

It is seen that the upper and lower telegraph currents are confined to their respective line wires because of the condensers  $c_1$ . The condensers  $c_2$  eliminate sparking at the key contacts and also take care of the rise and fall of the current in the telegraph circuit so as not to influence the telephone instruments. The telephone circuit includes both line wires and the four condensers  $c_1$ . Because of the high impedance of the retardation coils  $Z$  to alternating currents of high frequency (telephone currents are often considered to have a representative frequency of 800 cycles per second), the telephone currents are prevented from entering the telegraph circuits. The function of the retardation coils  $R$  and condensers  $c$  is to balance the telephone line and guard against mutual interferences between the telephone and telegraph circuits. The two coils  $R$  at each end may also be replaced by a repeating coil of the type shown in Fig. 21.

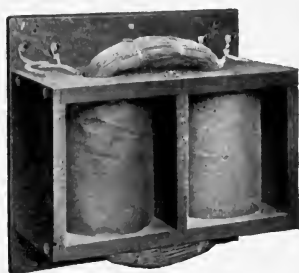

Fig. 23.

The following numbers indicate the order of magnitude of the condenser capacities:  $c = 2$  mf.,  $c_1 = 2$  mf. and  $c_2 = 6$  mf. The impedances  $Z$  and  $R$  are windings on soft iron cores of the closed type (Fig. 23) and possess large inductance; their resistances are respectively 50 and 30 ohms.

Telephone ringing over composited lines by the usual

low-frequency generators (about 16 cycles) is unsatisfactory because the impedance of the retardation coils  $Z$  is small to these ringing currents, resulting in chattering of the relay armatures. Instead, calling is accomplished by means of weak high-frequency currents (about 300 cycles) over the lines which actuate suitable relays that control the operation of local low-frequency ringing devices.

*Phantom Circuits with Simplex and Compositel Telephone Lines.*— Two telephone circuits, each adapted for simplex telegraphic signalling, as shown in Fig. 21, may also simultaneously serve as the conductors of a phantom

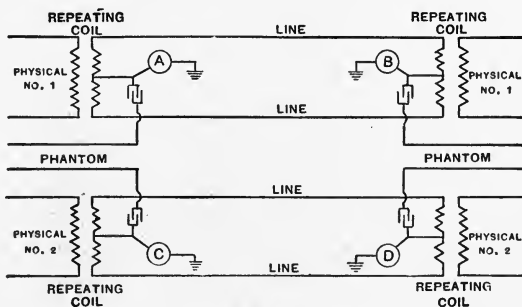

Fig. 24.

telephone circuit, as shown schematically in Fig. 24. The location of the simplex telegraphic apparatus is indicated by the letters  $A$ ,  $B$ ,  $C$  and  $D$ . In a similar manner, two telephone circuits, each adapted for composite working as shown in Fig. 22, may also simultaneously serve as the conductors of a phantom telephone circuit, thereby securing 4 telegraphic and 3 telephonic channels over 4 wires.

*Railway Composite Signalling.*— Telephonic and telegraphic communication may also be effected simultaneously over a single line, both services utilizing the ground as the return path. Such telephonic transmission over existing

telegraph lines is possible over distances up to say 200 miles, and is therefore useful principally in supplementing telegraphic signalling on railway telegraph lines.

The arrangement of the apparatus at a terminal station for such composite signalling differs from that used with magneto or common-battery systems, and is shown in Fig. 25. Several intermediate telegraph and intermediate

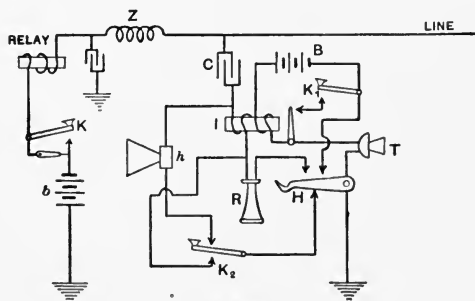

Fig. 25.

telephone sets may be operated on a line, code signalling being utilized for telephonic calling. Portable telephone sets may be carried on the trains so that in cases of emergency one may be bridged from the line to ground at any place, enabling prompt requests for directions or assistance. At intermediate telegraph stations a condenser and a resistance bridge the telegraph set so as to maintain the continuity of the line for telephonic currents, and to prevent the high-frequency signalling current affecting the telegraph relay.

Referring to Fig. 25, the presence of the impedance coil  $Z$  prevents telephone currents passing through the relay, as before; also the presence of the condenser  $C$  hinders the telegraph currents from entering the telephone circuit. The signalling current is produced by an induction coil  $I$

with a vibrator, the coil also serving for transmission purposes when talking. The signal-receiving device is a special telephone receiver or *howler h*, with a heavy diaphragm, which is responsive to incoming high-frequency signalling currents.

To signal another telephone station the keys  $K_1$  and  $K_2$  are depressed; in reality both keys are combined so they will open and close together. The closing of key  $K_1$  sets the armature of induction coil  $I$  in vibration, and the core is repeatedly magnetized and demagnetized. The alternating current induced in the other winding thereby flows from ground, through the lower contacts of hook-switch  $H$  and key  $K_2$ , through coil  $I$  and condenser  $C$  to the line. At the other stations this signalling current flows through the condenser  $C$ , howler  $h$ , upper contact of key  $K_2$  and lower contact of hook-switch  $H$  to ground, thus operating the howler.

Having secured the distant station attendant, the keys are released and the receiver  $R$  is lifted from the hook. The local transmitter circuit is now completed and the receiver is placed in connection with the line through the condenser  $C$  and the secondary winding of the induction coil.

### PROBLEMS

1. For a factor of safety of 5 against wind pressure, what should be the diameter of poles at the ground line for supporting 10 No. 6 B. W. G. iron wires at intervals of 100 feet along a straight path? The poles project 25 feet above the ground and the center of load may be considered as 5 feet from the pole-tops. Allow 8000 pounds per square inch as the breaking fibre stress of the poles, and assume an ice coating  $\frac{1}{2}$  inch thick all around the conductors.

2. What sag should be allowed in 100-foot spans of No. 9 B. & S. gage hard-drawn copper wires while being strung at a temperature



of 80 degrees fahr., so that the tension in the wires with a  $\frac{1}{2}$ -inch ice coating at  $-20$  degrees fahr. will not exceed 300 pounds?

3. Determine the economic pole spacing for a pole line with No. 12 B. & S. gage hard-drawn copper wires in which the maximum allowable tension is specified as 100 pounds. The wires are to have a minimum clearance of 20 feet above ground, the cost of cross-arms, insulators, pins, etc., is \$2.00 per pole, and the pole cost-constant is  $a = 0.005$ .

4. Estimate the cost per mile installed of two 100-conductor (No. 14 B. & S.) lead-covered telegraph cables located in a clay underground conduit, with manholes 440 feet apart, each costing \$75.00. The cost of drawing the cables in the conduit and splicing the conductors may be assumed as 7 cents per foot of cable.

5. Millivoltmeter readings over 6-foot lengths of a lead-sheathed cable, taken at two successive manholes, were 1.0 and 0.25 millivolts. If the outside diameter of the sheath is 2.5 inches and the thickness of its wall is  $\frac{1}{8}$  inch, determine the current leaving the cable-sheath to ground between the manholes, the resistivity of lead being taken as 8 microhms per inch cube.

6. Two auxiliary grounds were employed in the measurement of the ground resistance at a newly-constructed permanent ground, and a battery in series with an adjustable resistance of  $r$  ohms was successively bridged from one ground electrode to each of the others. The voltage  $V$  across the battery, the voltage drop  $V'$  over the resistance  $r$  and the earth potential difference  $E$  volts were observed for each case with a voltmeter, resulting in the following data:

Quantity	From permanent to first auxiliary ground	From permanent to second auxiliary ground	Across the two auxiliary grounds
$r$	70	50	110
$V$	10.3	10.0	11.0
$V'$	6.8	7.2	7.8
$E$	0.3	-0.1	0.2

The ground resistance of each path is  $\frac{V - V' + E}{V'}$   $r$ , whence the resistance of the permanent ground may be computed.

7. Two No. 9 B. & S. gage copper wires one foot apart horizontally are suspended 25 feet above the ground. Calculate the total inductance per mile of both wires for currents in the same and in opposite directions.

8. A single conductor 0.30 inch in diameter is surrounded by two concentric layers of insulating material each 0.25 inch thick, the inner and outer layers having specific capacities of 3 and 2 respectively, and these are surrounded by a metallic armor. Compute the capacity of this cable per mile of length.

9. Draw a scheme of connections for compositing two telephone circuits which serve simultaneously as the physical circuits of a phantom telephone circuit.

## CHAPTER X

### THEORY OF CURRENT PROPAGATION IN LINE CONDUCTORS

1. **The Transmission of Current Impulses along Telegraph Lines.**—The currents at any instant that pass different points of a line conductor differ from each other, and become less and less the more remote the point of consideration is from the generator end of the line conductor. This is due to the distributed nature of the four line constants: resistance, inductance, capacity and leakage. In determining the effect at any place on a telegraph

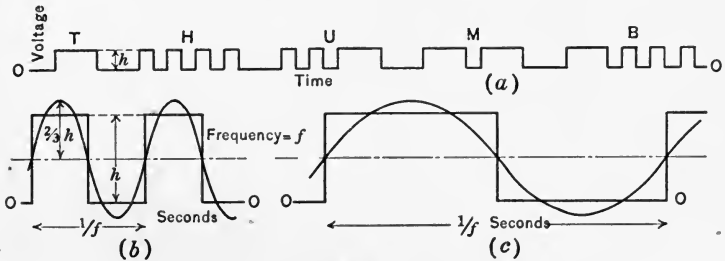

Fig. 1.

line of impressing an electromotive force at one or both of its terminals, it is necessary to consider the conditions existing in telegraphic transmission. The nature of the impulses to be transmitted by a telegraph line may be inferred from graph (a), Fig. 1, which indicates the sequence and duration of the voltage applications to the line for the word "thumb." It is seen from this figure that telegraphic transmission involves the propagation of long

and short unidirectional impulses of constant magnitude  $h$ , which are variously grouped and spaced. The theory of propagation of such irregular impulses may be considered in the following ways:

$\alpha$ . The impulses may be considered as made up of a continuously applied direct current of magnitude  $\frac{h}{2}$ , upon which is superposed an alternating current of rectangular wave-shape of amplitude  $\frac{h}{2}$ . While this rectangular wave-

shape is susceptible to resolution into a Fourier's Series of sine curves whose relative frequencies are the successive odd numbers, it is much more convenient in the theory of telegraphic transmission to consider a single equivalent sine-wave alternating current rather than such a multiplicity of harmonics which together constitute the actual impulse. Graphs (b) and (c), Fig. 1, reveal the approximation of "equivalent" sine curves to dot and dash wave-shapes respectively, the amplitude being conveniently taken as

$\frac{2}{3}h$ . The frequencies of the equivalent alternating cur-

rents in the two cases correspond respectively to the number of dots and to the number of T's which may be sent out on the line per second, the latter frequency being  $\frac{1}{3}$  of the former or *dot-frequency*. Neither frequency prevails for more than several cycles, but nevertheless this *alternating-current theory of transmission* leads to an approximate idea of the propagation of telegraphic characters, especially when the speed of signalling approaches the theoretically attainable limit imposed by the conductor. It may be remarked that a somewhat similar condition exists in telephony, for in practical telephonic transmission calculations a

“representative” frequency of 800 cycles per second is considered appropriate for a single equivalent sine-wave alternating current, which is recognized in preference to a constantly-varying series of complex wave-shapes that actually constitute articulate speech. The frequency of the equivalent telegraphic alternating current to be used in any particular calculation depends upon the speed of signalling, the dot-frequency varying possibly from 15 cycles or less with hand transmission to 125 cycles with automatic transmission. The computed sinusoidal current wave-shape at any point of the line may then be reduced to its corresponding rectangular wave-shape.

$\beta$ . If the speed of telegraphic signalling over a line is much below that theoretically attainable thereon, the time of growth and fall of the unidirectional current impulse will be short in comparison to the duration of a dot signal, and consequently the steady value of the current at every place on the line will be reached within every signal. Therefore the magnitude of the received impulses may be ascertained on the basis of a maintained direct current flowing over the line, the effects of inductance and capacity being ignored because these constants influence only the growth and fall of the current value. This method of treatment may be termed the *direct-current theory of transmission*.

$\gamma$ . On the contrary, if the speed of signalling is such that the current at any place does not nearly assume the ultimate value that accompanies slower signalling during the time of dot or dash signals, then a consideration of the growth and subsequent fall of the current alone is of importance. This consideration of occurrences during the repeated transitional periods of application and withdrawal of voltage on the line may be called the *transition*

*theory of transmission*, and is utilized chiefly in the treatment of submarine cable telegraphy for computing the shape of arrival current curves.

The transmission theories just enumerated will be considered in the order named, the first two being developed in the present chapter while the third is discussed in the following chapter devoted to submarine telegraphy.

### *Alternating-current Transmission Theory*

**2. Propagation of Alternating Currents along Uniform Conductors of Infinite Length.** — The impression of a sinusoidal or harmonic alternating *E.M.F.* upon a localized circuit, having resistance  $R$ , inductance  $L$  and capacity  $C$ , initiates three reactions of the circuit as follows: (a) resistance reaction ( $RI'$ ), the overcoming of which produces heat; (b) inductance reaction ( $L \frac{dI'}{dt}$ ), the overcoming of which develops a magnetic field; (c) capacity reaction ( $\frac{1}{C} \int I' dt$ ), the overcoming of which forms an electrostatic field; where  $I'$  is the instantaneous current value, and  $t$  represents time. With long line circuits the electrical constants of the circuit are distributed in space, and consequently the current, while everywhere sinusoidal, has not the same value or phase throughout the circuit.

The simplest case of alternating-current wave propagation is that on conductors of infinite length, since on such lines the effect of reflection of the waves at the distant end can be ignored. Consider the element  $ds$  of an infinitely long uniform line with a perfectly-conducting ground return, at a distance  $s$  from the end upon which a simple harmonic electromotive force is impressed, as shown in

Fig. 2. A current will flow through the conductor, and at the instant  $t$  at the element  $ds$  it may be represented by  $I'$ , and that in the adjacent elements by  $I' + dI'$  and  $I' - dI'$ , the latter referring to the element more remote from the generator. Let  $E'$ , at this instant, be the potential of the line with respect to the earth at the element  $ds$  and let the potentials of the adjacent elements above that of the earth be  $E' + dE'$  and  $E' - dE'$  respectively. Let  $R$ ,  $L$  and  $C$  in homologous units represent respectively the

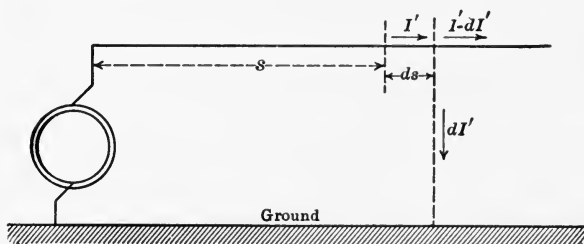

Fig. 2.

uniformly distributed resistance, inductance and capacity of the line per unit length.

The difference of potential between the two ends of the element  $ds$  is  $dE'$  and this must be equal to the sum of the resistance and inductance reactions of the elementary circuit occasioned by the current  $I'$ . As only the reactions of the conductor need be considered, there results for this element

$$L ds \frac{dI'}{dt} + R ds I' = - dE',$$

or

$$L \frac{dI'}{dt} + R I' = - \frac{dE'}{ds}. \quad (1)$$

Since the line has capacity with respect to earth, it takes a charging current; and since the line is not perfectly

insulated from ground, a slight leakage current will flow. Therefore the current which does not continue beyond the element  $ds$ , but which flows from the line to ground under the voltage  $E'$ , is

$$-dI' = \frac{d}{dt}(E'C ds) + E'g ds,$$

where  $g$ , the leakage conductance or leakance, is the reciprocal of the apparent insulation resistance per unit length of line. Then

$$-\frac{dI'}{ds} = C \frac{dE'}{dt} + E'g. \quad (2)$$

Differentiating (1) with respect to time, there results

$$L \frac{d^2I'}{dt^2} + R \frac{dI'}{dt} = -\frac{d}{dt} \left( \frac{dE'}{ds} \right) = -\frac{d}{ds} \left( \frac{dE'}{dt} \right),$$

and differentiating (2) with respect to distance, there results

$$-\frac{d^2I'}{ds^2} = C \frac{d}{ds} \left( \frac{dE'}{dt} \right) + g \frac{dE'}{ds}.$$

Substitution of the former in the latter equation gives

$$\frac{d^2I'}{ds^2} = CL \frac{d^2I'}{dt^2} + RC \frac{dI'}{dt} - g \frac{dE'}{ds},$$

and replacing the last term by its equivalent from (1) there is obtained the equation of propagation of current along a uniform line, as

$$CL \frac{d^2I'}{dt^2} + (RC + gL) \frac{dI'}{dt} = \frac{d^2I'}{ds^2} - RgI', \quad (3)$$

the solution of which shows the current value at the point  $s$  of the line at the time  $t$  in terms of the line constants  $R$ ,  $L$ ,  $C$  and  $g$ .



Similarly, by differentiating (1) with respect to distance, and (2) with respect to time, and then combining the resulting expressions, there is obtained

$$CL \frac{d^2 E'}{dt^2} + (RC + gL) \frac{dE'}{dt} = \frac{d^2 E'}{ds^2} - RgE'. \quad (4)$$

Equations (3) and (4), for current and voltage distribution respectively, are true for any length of line, and are identical, so that the solution of one of them suffices.

Since the magnitude of the current must decrease in receding from the generator end of the infinitely long line, and since the current is simple harmonic when the impressed electromotive force is such, and differs in phase therefrom more and more as  $s$  increases, the following representation of the current at any point  $s$  of the infinitely long line at the time  $t$  suggests itself:

$$I' = I \epsilon^{-\beta s} \cos (pt - \alpha s), \quad (5)$$

where  $I$  is the maximum value of the current at the generator end of the line,  $p$  is  $2\pi$  times the frequency of the impressed harmonic electromotive force,  $\epsilon^{-\beta}$  is the diminution in magnitude of the wave over unit length of circuit,  $\alpha$  is the phase retardation per unit distance which in degrees is  $\frac{180\alpha}{\pi}$ ,  $\beta$  and  $\alpha$  being constants which depend upon the resistance, inductance, capacity and leakance of the line, and  $\epsilon$  being the base of Napierian logarithms.

The substitution of this assumed expression for the current  $I'$  with proper values of  $\alpha$  and  $\beta$  in (3) will satisfy this equation and permit of the evaluation of the constants  $\alpha$  and  $\beta$ . Thus, differentiating (5) with respect to time,

$$\frac{dI'}{dt} = -pI \epsilon^{-\beta s} \sin (pt - \alpha s),$$

and again,

$$\frac{d^2 I'}{dt^2} = -p^2 I \epsilon^{-\beta s} \cos(pt - \alpha s);$$

and differentiating with respect to distance,

$$\begin{aligned} \frac{dI'}{ds} &= \alpha I \epsilon^{-\beta s} \sin(pt - \alpha s) - \beta I \epsilon^{-\beta s} \cos(pt - \alpha s) \\ &= I \epsilon^{-\beta s} \{ \alpha \sin(pt - \alpha s) - \beta \cos(pt - \alpha s) \}, \end{aligned}$$

and again,

$$\begin{aligned} \frac{d^2 I'}{ds^2} &= I \epsilon^{-\beta s} \{ -\alpha^2 \cos(pt - \alpha s) - \alpha \beta \sin(pt - \alpha s) \} \\ &\quad - \beta I \epsilon^{-\beta s} \{ \alpha \sin(pt - \alpha s) - \beta \cos(pt - \alpha s) \} \\ &= I \epsilon^{-\beta s} [(\beta^2 - \alpha^2) \cos(pt - \alpha s) - 2\alpha\beta \sin(pt - \alpha s)]. \end{aligned}$$

Substituting these values in equation (3), there results,

$$\begin{aligned} &-p^2 C L I \epsilon^{-\beta s} \cos(pt - \alpha s) - (RC + gL) p I \epsilon^{-\beta s} \sin(pt - \alpha s) \\ &+ R g I \epsilon^{-\beta s} \cos(pt - \alpha s) - I \epsilon^{-\beta s} [(\beta^2 - \alpha^2) \cos(pt - \alpha s) \\ &- 2\alpha\beta \sin(pt - \alpha s)] = 0, \end{aligned}$$

or

$$\begin{aligned} &p^2 C L \cos(pt - \alpha s) + p(RC + gL) \sin(pt - \alpha s) \\ &- R g \cos(pt - \alpha s) + (\beta^2 - \alpha^2) \cos(pt - \alpha s) \\ &- 2\alpha\beta \sin(pt - \alpha s) = 0. \end{aligned}$$

This expression can only be true if

$$p^2 C L - R g = -(\beta^2 - \alpha^2) = \alpha^2 - \beta^2, \quad (6)$$

and if

$$p(RC + gL) = 2\alpha\beta. \quad (7)$$

These are simultaneous equations which can be solved for  $\alpha$  and  $\beta$ . Thus, substituting the value of  $\alpha$  from (7) in (6) gives the following biquadratic:

$$\beta^4 + (p^2 L C - R g) \beta^2 - \frac{p^2}{4} (RC + gL)^2 = 0,$$

whence

$$\begin{aligned}\beta^2 &= -\frac{p^2 LC - Rg}{2} + \frac{1}{2} \sqrt{(p^2 LC - Rg)^2 + p^2 (RC + gL)^2} \\ &= \frac{1}{2} [\sqrt{p^2 R^2 C^2 + p^2 g^2 L^2 + R^2 g^2 + p^4 L^2 C^2} - p^2 LC + Rg].\end{aligned}$$

Therefore,

$$\beta = \sqrt{\frac{1}{2} [\sqrt{(p^2 C^2 + g^2)(R^2 + p^2 L^2)} - p^2 LC + Rg]}, \quad (8)$$

and similarly

$$\alpha = \sqrt{\frac{1}{2} [\sqrt{(p^2 C^2 + g^2)(R^2 + p^2 L^2)} + p^2 LC - Rg]}. \quad (9)$$

The constant  $\beta$  is called the *attenuation coefficient*, and  $\alpha$  is called the *wave-length constant*. Having determined the values of  $\alpha$  and  $\beta$ , the current at any point on the line distant  $s$  from the generator at the time  $t$  may be determined when the maximum current value is known at the end upon which the electromotive force of frequency  $\frac{p}{2\pi}$  is impressed.

At some other point on the line distant  $r$  from the generator end, the current value at the instant  $t$  is

$$I_r' = I e^{-\beta r} \cos (pt - \alpha r).$$

If this more distant point  $r$  be chosen so that the current there will be in phase with that at the point  $s$  at that instant, then

$$\cos (pt - \alpha s) = \cos (pt - \alpha r).$$

Between these points  $r$  and  $s$  there is an integral number of complete waves,  $n$ ; therefore, the wave-length is

$$\lambda = \frac{r - s}{n}.$$

Since the phase retardation can be considered over this distance as  $2\pi n$ ,

$$\alpha s + 2\pi n = \alpha r;$$

consequently,

$$\frac{2\pi}{\alpha} = \frac{r-s}{n} = \lambda.$$

As the frequency of the impressed electromotive force is  $\frac{p}{2\pi}$  cycles per second, the velocity of wave propagation will be

$$v = \frac{p}{2\pi} \lambda = \frac{p}{\alpha}. \quad (10)$$

In cables, because of the close proximity of the conductors to one another, the inductance is little and the capacity large. Since  $2\pi f$  times the inductance is small compared with the resistance of the conductors, and, in good telegraph and telephone cables, as the conductance of the insulation is small compared with  $2\pi f$  times the capacity, the attenuation constant of such cables may be expressed in a more convenient form by expanding the factors  $\sqrt{R^2 + p^2L^2}$  and  $\sqrt{p^2C^2 + g^2}$  of equation (8) by the binomial theorem and disregarding terms of higher order than the second as being too small to make any appreciable difference. Then

$$\begin{aligned} \sqrt{(R^2 + p^2L^2)(p^2C^2 + g^2)} &= R \left( 1 + \frac{p^2L^2}{2R^2} \right) (pC) \left( 1 + \frac{g^2}{2p^2C^2} \right) \\ &= pCR \left( 1 + \frac{p^2L^2}{2R^2} + \frac{g^2}{2p^2C^2} + \frac{L^2g^2}{4C^2R^2} \right). \end{aligned}$$

Neglecting the last term for similar reasons, the attenuation constant becomes

$$\begin{aligned} \beta &= \sqrt{\frac{pCR}{2} \left( 1 + \frac{p^2L^2}{2R^2} + \frac{g^2}{2p^2C^2} - \frac{pL}{R} + \frac{g}{pC} \right)} \\ &= \sqrt{\frac{pCR}{2}} \sqrt{\left( 1 + \frac{g}{2pC} - \frac{pL}{2R} \right)^2 + \left( \frac{pL}{2R} + \frac{g}{2pC} \right)^2}. \end{aligned}$$

If the inductance be entirely ignored, there results herefrom

$$\beta = \sqrt{\frac{pCR}{2}} \sqrt{\left(1 + \frac{g}{2pC}\right)^2 + \frac{g^2}{4p^2C^2}} = \sqrt{\frac{pCR}{2}} \left(1 + \frac{g}{2pC}\right),$$

by disregarding  $\frac{g^2}{4p^2C^2}$ . This expression is convenient in considering wave transmission over cables. If the leakage conductance be taken as zero, it reduces to

$$\beta = \sqrt{\frac{pCR}{2}}.$$

### 3. Velocity of Wave Propagation over an Ideal Line. —

An ideal line may be considered a perfectly insulated one employing conductors of zero resistance, for then the attenuation would be nil. Thus, by substituting in (8) and (9),  $g = 0$  and  $R = 0$ , there results

$$\beta = 0 \quad \text{and} \quad \alpha = p \sqrt{LC}.$$

Therefore, the velocity of wave propagation on such a line

$$\text{would be} \quad v = \frac{1}{\sqrt{LC}}. \quad (11)$$

The inductance of a straight conductor due to the magnetic flux surrounding the conductor, in electromagnetic units per centimeter length, is

$$2 \mu \log_e \frac{d-D}{D},$$

and the capacity thereof in electrostatic units per centimeter length is

$$\frac{k}{2 \log_e \frac{d-D}{D}},$$

where  $D$  is the diameter of the wires and  $d$  is their inter-axial separation.

As there are  $9 \times 10^{20}$  electrostatic units in one electromagnetic unit of capacity, the square root of the product of these expressions in electromagnetic units is

$$\sqrt{LC} = \frac{\sqrt{\mu k}}{3 \times 10^{10}}.$$

Therefore, the velocity of electric wave propagation, when the resistance and leakance of the conductors are neglected, is

$$v = \frac{3 \times 10^{10}}{\sqrt{\mu k}} \text{ centimeters per second.} \quad (12)$$

With conductors in a medium like air, for which both the permeability  $\mu$  and the permittivity  $k$  are unity, the velocity of propagation is 300,000 kilometers per second (186,000 miles per second), which is identical with the velocity of light. For actual lines the velocity of wave propagation is somewhat lower than this value.

#### 4. Wave Propagation along Conductors of Finite Length.

— In the foregoing discussion of wave propagation on infinitely long lines, no cognizance was taken of reflection of the outgoing waves upon arrival at the distant terminal of the circuit. Voltage and current waves, which together constitute an electromagnetic wave, when traversing relatively short circuits having distributed capacity and inductance, are partially reflected at both ends thereof with or without phase reversal, total reflection taking place only when the impedances at the terminals of the lines are either zero or infinity (that is, short-circuited or open-circuited). If a single impulse be impressed upon the circuit, a wave will travel back and forth along the line, until it is attenuated to practically nothing. If such waves continually depart

from one end of a line, and each wave is reflected a great many times, alternately at the other and initial ends of the circuit, before extinction, the current and voltage everywhere on the line will be gradually built up and ultimately assume their final values. This steady state is approached by successive jumps and not uniformly, although attained in a very short time — perhaps a second. After the steady state is reached, all the outgoing waves may be considered together as a single resultant wave-train, and all the returning waves as another single wave-train. The following method of deriving the equations of current and voltage distribution on lines of finite length for the steady state displays the results physically as two oppositely moving wave-trains, each of definite initial amplitude. By not considering the short, unsteady period immediately following the voltage application, a simplification of operations may be effected over the foregoing method of treatment by introducing the complex quantity, inasmuch as one independent variable — that of time — is eliminated thereby. The resulting expressions are complex quantities and their interpretation must be made accordingly.

Harmonically varying quantities can be represented by vectors. The length of such a vector shows the maximum value of the quantity, and its direction indicates the phase of that quantity. Each vector may be resolved into two rectangular component vectors, say, one horizontal and the other vertical. To distinguish vertical from horizontal components, a symbol, usually  $j$ , is placed before the vertical component. Thus, the expression  $a + jb$  means that  $b$  is to be added vectorially at right angles to  $a$ . Obviously the magnitude of the resultant vector is  $\sqrt{a^2 + b^2}$ , and the angle it makes with the horizontal component is

$\tan^{-1} \frac{b}{a}$ . The interpretation of this quadrantal operator or neomon  $j$  is  $j = \sqrt{-1}$ .

By applying the operator to equations (1) and (2) and counting the distance  $s$  positive from the receiving end of the line, it follows that for the steady state

$$\frac{dE_m}{ds} = (R + jpL) I_m, \quad (13)$$

and

$$\frac{dI_m}{ds} = (g + jpC) E_m, \quad (14)$$

which are relations independent of time, wherein  $E_m$  and  $I_m$  represent the maximum values of electromotive force and current respectively at any point on the circuit. The factor  $(R + jpL)$  may be called the *conductor impedance*, and  $(g + jpC)$  the *dielectric admittance*. Differentiating these expressions and substituting gives respectively

$$\frac{d^2 E_m}{ds^2} = (R + jpL)(g + jpC) E_m,$$

and

$$\frac{d^2 I_m}{ds^2} = (R + jpL)(g + jpC) I_m.$$

For convenience, let  $(R + jpL)(g + jpC) = \gamma^2$ , then the equations of wave propagation along conductors become

$$\frac{d^2 E_m}{ds^2} = \gamma^2 E_m, \quad (15)$$

and

$$\frac{d^2 I_m}{ds^2} = \gamma^2 I_m. \quad (16)$$

These are identical differential equations of electromotive force and current which differ in the terminal conditions



only, and consequently the solution of one of them will suffice.

Choosing the latter expression and multiplying through by  $2 \frac{dI_m}{ds}$ , there results

$$2 \frac{d^2 I_m}{ds^2} \cdot \frac{dI_m}{ds} = 2 \gamma^2 I_m \frac{dI_m}{ds},$$

which, when integrated, becomes

$$\left( \frac{dI_m}{ds} \right)^2 = \gamma^2 I_m^2 + c_1.$$

Replacing the constant of integration  $c_1$  by  $\gamma^2 c_2^2$ , where  $c_2$  is also a constant, and separating the variables, there obtains

$$\frac{dI_m}{\sqrt{I_m^2 + c_2^2}} = \gamma ds.$$

Integration gives

$$\log_e [c_3 (I_m + \sqrt{I_m^2 + c_2^2})] = \gamma s,$$

where  $c_3$  is another constant of integration. Writing in exponential form, this equation becomes

$$\epsilon^{\gamma s} = (I_m + \sqrt{I_m^2 + c_2^2}) c_3.$$

Squaring,

$$I_m^2 + c_2^2 = \frac{\epsilon^{2\gamma s}}{c_3^2} + I_m^2 - 2 I_m \frac{\epsilon^{\gamma s}}{c_3},$$

or

$$\frac{\epsilon^{2\gamma s}}{c_3^2} - c_2^2 = 2 I_m \frac{\epsilon^{\gamma s}}{c_3};$$

whence

$$I_m = \frac{\epsilon^{\gamma s}}{2 c_3} - \frac{c_2^2 c_3}{2 \epsilon^{\gamma s}}.$$

Choosing constants  $A$  and  $B$  so that

$$A = \frac{1}{2 c_3} \quad \text{and} \quad B = \frac{c_2^2 c_3}{2},$$

the expression for the maximum value of the current at a distance  $s$  from the receiving end of the line becomes

$$I_m = A\epsilon^{\gamma s} - B\epsilon^{-\gamma s}, \quad (17)$$

where the two constants must be evaluated from the terminal conditions.

Since the exponential coefficient  $\gamma$  is the square root of the product of two complex numbers, it is also a complex quantity, and may be written

$$\gamma = \beta + j\alpha,$$

where  $\alpha$  and  $\beta$  are its two rectangular components. Then

$$(\beta + j\alpha)^2 = (R + jpL)(g + jpC), \quad (18)$$

or

$$\beta^2 + 2j\alpha\beta + j^2\alpha^2 = Rg + jgpL + jpRC + j^2p^2CL;$$

and remembering that  $j = \sqrt{-1}$ , this becomes

$$(\beta^2 - \alpha^2) + 2j\alpha\beta = (Rg - p^2CL) + j(gpL + pRC).$$

This equation can only be true if

$$\alpha^2 - \beta^2 = p^2CL - Rg,$$

and if

$$2\alpha\beta = p(RC + gL).$$

These expressions are identical with equations (6) and (7), and, therefore, the components of  $\gamma$  have the same significance as before; namely,  $\beta$  is the attenuation coefficient and  $\alpha$  is the wave-length constant, the values of which are given by equations (8) and (9) respectively. The quantity  $\gamma$  is called the *propagation constant* of the line.

The maximum current value at a point on the line distant  $s$  from the receiving end may now be indicated as

$$I_m = A\epsilon^{(\beta+j\alpha)s} - B\epsilon^{-(\beta+j\alpha)s}.$$

Writing for the exponential function with the imaginary exponent the equivalent trigonometric expression  $\epsilon^{\pm j\alpha s} =$

$\cos \alpha s \pm j \sin \alpha s$ , the equation for  $I_m$  becomes

$$I_m = A e^{\beta s} (\cos \alpha s + j \sin \alpha s) - B e^{-\beta s} (\cos \alpha s - j \sin \alpha s), \quad (19)$$

the first term of which, since it increases as  $s$  increases, may be considered the main current wave, and the second term may be called the reflected current wave. The amplitudes of these waves at the receiving end are respectively  $A$  and  $B$ .

The maximum value of the voltage at the same point on the line can be obtained by differentiating (19) or (17) and substituting in equation (14),

$$E_m = \frac{\beta + j\alpha}{g + j\beta C} [A e^{\beta s} (\cos \alpha s + j \sin \alpha s) + B e^{-\beta s} (\cos \alpha s - j \sin \alpha s)]. \quad (20)$$

To evaluate the constants  $A$  and  $B$ , two conditions must be known, as current and voltage at one end of the line, or current at one terminal and voltage at the other terminal of the line; thus, at the receiving end  $s = 0$ , and equations (19) and (20) give the maximum current and voltage values respectively at this point as

$$I_r = A - B,$$

and

$$E_r = \frac{\beta + j\alpha}{g + j\beta C} (A + B).$$

The fraction  $\beta + j\alpha \div g + j\beta C$  is frequently called the *surge impedance* or *characteristic impedance* of the line. Then

$$A = \frac{1}{2} \left( I_r + E_r \frac{\beta + j\alpha}{R + j\beta L} \right), \quad (21)$$

and

$$B = \frac{1}{2} \left( -I_r + E_r \frac{\beta + j\alpha}{R + j\beta L} \right). \quad (22)$$

The ratio of the amplitude of the reflected wave to that of the main wave arriving at the receiving end, that is, the

ratio of  $B$  to  $A$ , will depend upon the character of the terminal apparatus, and may be called the *coefficient of reflection*. This coefficient is

$$m = \frac{B}{A} = \frac{E_r \frac{\beta + j\alpha}{R + jpL} - I_r}{E_r \frac{\beta + j\alpha}{R + jpL} + I_r}.$$

Representing the impedance of the terminal apparatus by  $Z_r$ , this expression becomes

$$m = \frac{Z_r \frac{\beta + j\alpha}{R + jpL} - I}{Z_r \frac{\beta + j\alpha}{R + jpL} + I} = \frac{Z_r(\beta + j\alpha) - (R + jpL)}{Z_r(\beta + j\alpha) + (R + jpL)}. \quad (23)$$

For total absorption of the wave,  $m = 0$ , and the receiver impedance should be

$$Z_r = \frac{R + jpL}{\beta + j\alpha}.$$

Substituting the values of  $A$  and  $B$  in equations (19) and (20), the complete equations for the maximum values of current and voltage at any point of the line at a distance  $s$  from the end to which the receiver is connected, become respectively

$$I_m = \frac{1}{2} \left[ \left( I_r + E_r \frac{\beta + j\alpha}{R + jpL} \right) e^{\beta s} (\cos \alpha s + j \sin \alpha s) + \left( I_r - E_r \frac{\beta + j\alpha}{R + jpL} \right) e^{-\beta s} (\cos \alpha s - j \sin \alpha s) \right], \quad (24)$$

and

$$E_m = \frac{1}{2} \left[ \left( E_r + I_r \frac{\beta + j\alpha}{g + jpC} \right) e^{\beta s} (\cos \alpha s + j \sin \alpha s) + \left( E_r - I_r \frac{\beta + j\alpha}{g + jpC} \right) e^{-\beta s} (\cos \alpha s - j \sin \alpha s) \right]. \quad (25)$$

If it be desired to reckon the distance in the opposite direction, that is, from the generator to the receiving ends of the line, the sign of  $s$  must be reversed in equations (13) and (14), and there result for the current and voltage at any point distant  $s$  from the generator end of the line, respectively,

$$I_m = \frac{1}{2} \left[ \left( I_g + E_g \frac{\beta + j\alpha}{R + j\beta L} \right) \epsilon^{-\beta s} (\cos \alpha s - j \sin \alpha s) + \left( I_g - E_g \frac{\beta + j\alpha}{R + j\beta L} \right) \epsilon^{\beta s} (\cos \alpha s + j \sin \alpha s) \right], \quad (26)$$

and

$$E_m = \frac{1}{2} \left[ \left( E_g + I_g \frac{\beta + j\alpha}{g + j\beta C} \right) \epsilon^{-\beta s} (\cos \alpha s - j \sin \alpha s) + \left( E_g - I_g \frac{\beta + j\alpha}{g + j\beta C} \right) \epsilon^{\beta s} (\cos \alpha s + j \sin \alpha s) \right], \quad (27)$$

where  $E_g$  and  $I_g$  are the maximum voltage and current values at the generator end of the circuit.

The terminal conditions in any given problem are usually specified, the voltage being considered the standard phase. In the present notation for vector rotation a current leading the voltage in phase is written  $i_1 + ji_2$ , and a lagging current is represented by  $i_1 - ji_2$ .

The foregoing equations may also be employed with equal relevancy to calculations involving effective current and voltage values instead of the maximum values of these quantities. Short tables of exponential and trigonometric functions appear in the Appendix.

**5. Simplified Equations of Wave Propagation.** — The solution of the equations of wave propagation can be transformed into a more convenient form, as shown by Kennelly,

by expanding the factors  $\epsilon^{\pm\gamma s}$  of equation (17). Thus, by Maclaurin's series,

$$\begin{aligned}\epsilon^{\pm\gamma s} &= 1 \pm \gamma s + \frac{(\gamma s)^2}{2} \pm \frac{(\gamma s)^3}{3} + \frac{(\gamma s)^4}{4} \pm \frac{(\gamma s)^5}{5} + \dots \\ &= \left(1 + \frac{(\gamma s)^2}{2} + \frac{(\gamma s)^4}{4} + \dots\right) \pm \left(\gamma s + \frac{(\gamma s)^3}{3} + \frac{(\gamma s)^5}{5} + \dots\right);\end{aligned}$$

that is,  $\epsilon^{\pm\gamma s}$  can be expanded into two series, one containing even powers of  $\gamma s$  and the other having odd powers thereof. From hyperbolic trigonometry, these series are called respectively the hyperbolic cosine and hyperbolic sine, and are written

$$1 + \frac{(\gamma s)^2}{2} + \frac{(\gamma s)^4}{4} + \dots = \cosh \gamma s,$$

and

$$\gamma s + \frac{(\gamma s)^3}{3} + \frac{(\gamma s)^5}{5} + \dots = \sinh \gamma s.$$

Therefore,

$$\epsilon^{\pm\gamma s} = \cosh \gamma s \pm \sinh \gamma s.$$

Equation (17) for the current on the line at a point distant  $s$  from the receiving end may thus be written

$$\begin{aligned}I_m &= A (\cosh \gamma s + \sinh \gamma s) - B (\cosh \gamma s - \sinh \gamma s), \\ \text{or } I_m &= (A - B) \cosh \gamma s + (A + B) \sinh \gamma s. \quad (28)\end{aligned}$$

The maximum value of the voltage at the same point can be found by differentiating (28) and substituting in equation (14).

$$\text{Since} \quad \frac{d}{ds} \cosh \gamma s = \gamma \sinh \gamma s,$$

$$\text{and} \quad \frac{d}{ds} \sinh \gamma s = \gamma \cosh \gamma s,$$

there results

$$(g + j\omega C) E_m = (A - B) \gamma \sinh \gamma s + (A + B) \gamma \cosh \gamma s,$$

whence

$$E_m = \frac{\beta + j\alpha}{g + jpC} \left[ (A - B) \sinh \gamma s + (A + B) \cosh \gamma s \right]. \quad (29)$$

The constants  $A$  and  $B$  of expressions (28) and (29) may be determined from the conditions at the receiving end of the line. Let  $E_r$  and  $I_r$  be maximum values respectively of the voltage and the outgoing current at this terminal. Then, for  $s = 0$ , since  $\cosh(0) = 1$  and  $\sinh(0) = 0$ ,

$$I_r = A - B,$$

and 
$$E_r = \frac{\beta + j\alpha}{g + jpC} (A + B).$$

Substituting these values yields

$$I_m = I_r \cosh \gamma s + E_r \frac{\beta + j\alpha}{R + jpL} \sinh \gamma s, \quad (30)$$

and

$$E_m = I_r \frac{\beta + j\alpha}{g + jpC} \sinh \gamma s + E_r \cosh \gamma s. \quad (31)$$

The hyperbolic functions of the propagation constant  $\gamma$  may be written, since  $\gamma = \beta + j\alpha$ ,  
 $\cosh \gamma s = \cosh(\beta s + j\alpha s) = \cosh \beta s \cdot \cos \alpha s + j \sinh \beta s \cdot \sin \alpha s$ ,  
 and

$$\sinh \gamma s = \sinh \beta s \cdot \cos \alpha s + j \cosh \beta s \cdot \sin \alpha s.$$

Then the equations of current and voltage at any point on a line at a distance  $s$  from the receiving end thereof are

$$I_m = I_r (\cosh \beta s \cdot \cos \alpha s + j \sinh \beta s \cdot \sin \alpha s) + E_r \frac{\beta + j\alpha}{R + jpL} (\sinh \beta s \cdot \cos \alpha s + j \cosh \beta s \cdot \sin \alpha s), \quad (32)$$

and

$$E_m = E_r (\cosh \beta s \cdot \cos \alpha s + j \sinh \beta s \cdot \sin \alpha s) + I_r \frac{\beta + j\alpha}{g + jpC} (\sinh \beta s \cdot \cos \alpha s + j \cosh \beta s \cdot \sin \alpha s). \quad (33)$$

When  $s$  is measured from the generator toward the receiving end of the line, equations (30) and (31) become

$$I_m = I_g \cosh \gamma s - E_g \frac{\beta + j\alpha}{R + jpL} \sinh \gamma s, \quad (34)$$

and

$$E_m = E_g \cosh \gamma s - I_g \frac{\beta + j\alpha}{g + jpC} \sinh \gamma s. \quad (35)$$

From equation (34) it is seen that for an infinitely long line, on which the current at the inaccessible end is zero,

$$I_g \cosh (\infty) = E_g \frac{\beta + j\alpha}{R + jpL} \sinh (\infty),$$

whence

$$I_g = E_g \frac{\beta + j\alpha}{R + jpL}. \quad (36)$$

By substituting this value in the same expression, the current at a distance  $s$  from the generator end of such a line becomes

$$I_m = I_g (\cosh \gamma s - \sinh \gamma s) = I_g e^{-\gamma s}, \quad (37)$$

which shows that the entering current decreases logarithmically to zero as  $s$  increases to  $\infty$ . This expression is analogous to equation (5). Similarly, on an infinitely long line

$$E_m = E_g e^{-\gamma s}. \quad (38)$$

Tabulated numerical values of the hyperbolic sines and cosines appear in the Appendix. The hyperbolic functions of complex quantities may be obtained directly from tables and charts prepared by Prof. Kennelly.

**6. Current and Voltage Distribution on Lines for any Terminal Condition.** — The current and voltage relations in circuits having distributed capacity and inductance with



given terminal conditions under a given impressed electromotive force will now be considered. Three cases arise, namely: *a*, line open-circuited at receiver; *b*, line short-circuited at same place; and *c*, apparatus of given impedance connected to the receiving end of the line.

(*a*) When the line is open-circuited at the receiving end ( $I_r = 0$ ), the current  $I_a^0$ , entering it at the other end, is obtained from equation (34) by placing  $I_m = 0$ . Since

$$\frac{\sinh \gamma s}{\cosh \gamma s} = \tanh \gamma s,$$

there results

$$I_a^0 = E_g \frac{\beta + j\alpha}{R + jpL} \tanh \gamma s_1, \quad (39)$$

where  $s_1$  represents the total length of the line conductor. Upon substitution in equations (34) and (35), there results respectively the values of current and voltage at any point distant  $s$  from the generator end of the line, when the other end is open-circuited, as

$$I_m^0 = E_g \frac{\beta + j\alpha}{R + jpL} (\cosh \gamma s \tanh \gamma s_1 - \sinh \gamma s), \quad (40)$$

and

$$E_m^0 = E_g (\cosh \gamma s - \sinh \gamma s \tanh \gamma s_1). \quad (41)$$

When  $s = s_1$ , these equations reduce respectively to the current and voltage at the open end, viz:

$$I_r^0 = 0, \quad (42)$$

$$\text{and} \quad E_r^0 = \frac{E_g}{\cosh \gamma s_1} = E_g \operatorname{sech} \gamma s_1, \quad (43)$$

since  $\cosh^2 \gamma s_1 - \sinh^2 \gamma s_1 = 1$ .

(*b*) The current and voltage relations at any point of a line which is short-circuited at the distant end are easily

obtained, since the voltage at that end,  $E_r$ , is zero. By placing  $E_m = 0$  when  $s = s_1$ , in equation (35), there results the current entering the circuit as

$$I_o^s = E_o \frac{g + j\dot{p}C}{\beta + j\alpha} \coth \gamma s_1. \quad (44)$$

The current and voltage at any place are, therefore, respectively, from equations (34) and (35),

$$I_m^s = E_o \frac{g + j\dot{p}C}{\beta + j\alpha} (\cosh \gamma s \coth \gamma s_1 - \sinh \gamma s), \quad (45)$$

and

$$E_m^s = E_o (\cosh \gamma s - \sinh \gamma s \coth \gamma s_1). \quad (46)$$

The conditions at the short-circuited end are obtainable herefrom by replacing  $s$  by  $s_1$ , whence

$$I_r^s = \frac{E_o}{\sinh \gamma s_1} \cdot \frac{g + j\dot{p}C}{\beta + j\alpha} = E_o \frac{g + j\dot{p}C}{\beta + j\alpha} \operatorname{csch} \gamma s_1, \quad (47)$$

and

$$E_r^s = 0.$$

(c) When the character of the receiving apparatus is specified, that is, when its impedance,

$$Z_r = R_r + j \left( \dot{p}L_r - \frac{1}{\dot{p}C_r} \right),$$

is known, the voltage and current at any point of the line may be determined in terms of the impressed electromotive force. By placing  $s = s_1$ , equations (34) and (35) give the current and voltage at the receiving apparatus; and dividing the latter by the former, there results

$$\frac{E_r}{I_r} = Z_r = \frac{E_o \cosh \gamma s_1 - I_o \frac{\beta + j\alpha}{g + j\dot{p}C} \sinh \gamma s_1}{I_o \cosh \gamma s_1 - E_o \frac{\beta + j\alpha}{R + j\dot{p}L} \sinh \gamma s_1},$$

from which

$$I_o = E_o \frac{Z_r \frac{\beta + j\alpha}{R + j\phi L} \sinh \gamma s_1 + \cosh \gamma s_1}{Z_r \cosh \gamma s_1 + \frac{\beta + j\alpha}{g + j\phi C} \sinh \gamma s_1}. \quad (48)$$

By substituting this value in the same equations there results respectively as the current and voltage at a point on the line distant  $s$  miles from the generator:

$$I_m = E_o \frac{\beta + j\alpha}{R + j\phi L} \times \left[ \frac{Z_r \sinh \gamma s_1 + \frac{R + j\phi L}{\beta + j\alpha} \cosh \gamma s_1}{Z_r \cosh \gamma s_1 + \frac{\beta + j\alpha}{g + j\phi C} \sinh \gamma s_1} \cosh \gamma s - \sinh \gamma s \right], \quad (49)$$

and  $E_m = E_o \times$

$$\left[ \cosh \gamma s - \frac{Z_r \sinh \gamma s_1 + \frac{\beta + j\alpha}{g + j\phi C} \cosh \gamma s_1}{Z_r \cosh \gamma s_1 + \frac{\beta + j\alpha}{g + j\phi C} \sinh \gamma s_1} \sinh \gamma s \right]. \quad (50)$$

These equations may be more conveniently expressed by choosing an angle  $\phi$  such that

$$\tanh \phi = \frac{Z_r(\beta + j\alpha)}{R + j\phi L},$$

and they assume the following forms:

$$I_m = E_o \frac{\beta + j\alpha}{R + j\phi L} [\coth(\gamma s_1 + \phi) \cosh \gamma s - \sinh \gamma s], \quad (51)$$

and

$$E_m = E_o [\cosh \gamma s - \coth(\gamma s_1 + \phi) \sinh \gamma s]. \quad (52)$$

These general expressions are similar in form to those derived under case (b).

At the terminal apparatus of impedance  $Z_r$ , the current and voltage in terms of the impressed electromotive force  $E_o$  may be obtained from equations (49) and (50) by putting  $s_1$  for  $s$ ; whence

$$I_r = \frac{E_o}{Z_r \cosh \gamma s_1 + \frac{\beta + j\alpha}{g + jpC} \sinh \gamma s_1}, \quad (53)$$

and

$$E_r = \frac{E_o}{\cosh \gamma s_1 + \frac{\beta + j\alpha}{g + jpC} \cdot \frac{\sinh \gamma s_1}{Z_r}}. \quad (54)$$

The general expressions (49) to (54) reduce to those derived under cases (a) and (b) for lines open- and short-circuited at the distant end by placing  $Z_r$  equal to infinity and zero respectively.

**7. Effect of Impedance at Sending End.** — In the foregoing expressions the impedance,  $Z_t$ , of any apparatus which might be connected to the generator end of a line, such as a relay on a telegraph line, has been ignored. The influence of such impedance can be taken into account by replacing  $E_o$  in equations (49) to (54) by

$$E_o' - I_o \left[ R_t + j \left( pL_t - \frac{1}{pC_t} \right) \right] = E_o' - I_o Z_t, \quad (55)$$

where  $R_t$ ,  $L_t$  and  $C_t$  are respectively the resistance, inductance and capacity of the transmitting device, Fig. 3, and  $I_o$  is the current entering the line.

This current value, from (51) by placing  $\gamma s = 0$ , is

$$I_o = E_o \frac{\beta + j\alpha}{R + jpL} \coth (\gamma s_1 + \phi),$$

where

$$\phi = \tanh^{-1} \left( \frac{Z_r(\beta + j\alpha)}{R + jpL} \right),$$

which, when substituted in equation (55), yields

$$E_g = \frac{E_g'}{1 + Z_t \frac{\beta + j\alpha}{R + jpL} \coth(\gamma s_1 + \phi)}.$$

By replacing the value of  $E_g$  in equations (51) and (52) by this quantity, there result respectively the complete and

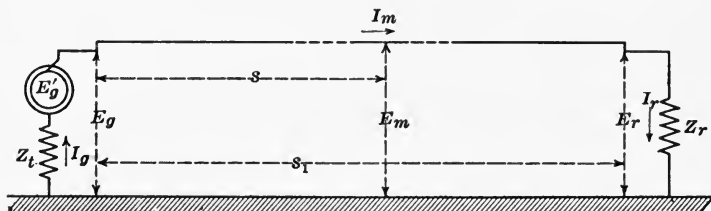

Fig. 3.

general expressions for the current and voltage values at any point on the line distant  $s$  miles from the generator as

$$I_m = E_g' \frac{\beta + j\alpha}{R + jpL} \cdot \frac{\cosh \gamma s \cdot \coth(\gamma s_1 + \phi) - \sinh \gamma s}{1 + Z_t \frac{\beta + j\alpha}{R + jpL} \coth(\gamma s_1 + \phi)}, \quad (56)$$

and

$$E_m = E_g' \frac{\cosh \gamma s - \sinh \gamma s \cdot \coth(\gamma s_1 + \phi)}{1 + Z_t \frac{\beta + j\alpha}{R + jpL} \coth(\gamma s_1 + \phi)}. \quad (57)$$

By placing  $s = s_1$  in the foregoing general expressions for current and voltage distribution on lines, the condi-

tions at the receiving end of the circuit are obtained; namely,

$$I_r = \frac{E_g'}{(Z_r + Z_t) \cosh \gamma s_1 + \left( \frac{\beta + j\alpha}{g + jpC} + Z_r Z_t \frac{\beta + j\alpha}{R + jpL} \right) \sinh \gamma s_1},$$

and

(58)

$$E_r = \frac{E_g' Z_r}{(Z_r + Z_t) \cosh \gamma s_1 + \left( \frac{\beta + j\alpha}{g + jpC} + Z_r Z_t \frac{\beta + j\alpha}{R + jpL} \right) \sinh \gamma s_1}.$$
(59)

These equations are together represented by the determinantal expression

$$I_r = \frac{E_g'}{\begin{vmatrix} Z_r & 1 & 0 \\ -Z_t & 1 & \sinh \gamma s_1 \\ \frac{\beta + j\alpha}{g + jpC} & -Z_r \frac{\beta + j\alpha}{R + jpL} & \cosh \gamma s_1 \end{vmatrix}} = \frac{E_r}{Z_r}. \quad (60)$$

The equations derived in §§ 4-7 are applicable to all alternating-current circuits having distributed resistance, inductance and capacity in the steady state, and with any terminal condition at either end. They are extremely useful in solving transmission problems not only in telegraphy, but also in telephony and power transmission. In applying the equations to circuits employing two or more line conductors, the significance of the symbols must be properly interpreted.

### 8. Illustration of Sine-wave Telegraphic Transmission.

— Consider a 150-volt (effective value) alternating-current generator to be connected to one end of a 600-mile simplex ground-return aerial telegraph line of No. 10 B. & S. gage

copper wire, the line having a 300-ohm relay at each terminal. Determine the current and voltage relations in the circuit for a signalling speed yielding a dot-frequency of 15 cycles per second.

The maximum value of the impressed harmonic voltage is  $150\sqrt{2}$  or 212.2 volts, which may be considered the equivalent of a unidirectional voltage of 320 volts, as outlined in § 1. The electrical constants of the line per mile will be taken as follows:

$$R = 5.28 \text{ ohms,} \quad (\text{page 29})$$

$$L = 3.10 \times 10^{-3} \text{ henrys,} \quad \left. \begin{array}{l} \\ \end{array} \right\} \text{ For a single wire 25 feet}$$

$$C = 9.54 \times 10^{-9} \text{ farads,} \quad \left. \begin{array}{l} \\ \end{array} \right\} \text{ above ground (page 283)}$$

and  $g = 2.00 \times 10^{-6}$  mhos.

While the inductance of the relays depends upon several conditions, its value in this calculation will, however, be considered constant at 5 henrys; whence the impedance of each relay at 15 cycles is

$Z_r = Z_l = R_r + j\omega L_r = 300 + 2\pi 15 \times 5j = 300 + 471j$  ohms, and the absolute value is

$$\sqrt{R_r^2 + \omega^2 L_r^2} = \sqrt{300^2 + 471^2} = 558 \text{ ohms.}$$

The attenuation and wave-length constants of the line are respectively obtained from equations (8) and (9) as

$$\beta = 0.00331,$$

and

$$\alpha = 0.000808.$$

The velocity of propagation and the wave-length are respectively

$$v = \frac{2\pi 15}{0.000808} = 116,650 \text{ miles per second,}$$

and

$$\lambda = \frac{2\pi}{0.000808} = 7770 \text{ miles.}$$

Further, since

$$s_1 = 600 \text{ miles,}$$

$$E_g' = 212.2 \text{ volts,}$$

$$g + j\dot{p}C = (2.0 + 0.899j) 10^{-6} \text{ mhos,}$$

$$R + j\dot{p}L = 5.28 + 0.292j \text{ ohms,}$$

$$\frac{\beta + j\alpha}{g + j\dot{p}C} = \frac{(\beta + j\alpha)(g - j\dot{p}C)}{g^2 + \dot{p}^2C^2} = 1528 - 283j,$$

$$\frac{\beta + j\alpha}{R + j\dot{p}L} = (635 + 118j) 10^{-6},$$

$$\gamma s_1 = \beta s_1 + j\alpha s_1 = 1.986 + 0.4848j,$$

$$\begin{aligned} \sinh \gamma s_1 &= \sinh 1.986 \cdot \cos 0.4848 + j \cosh 1.986 \cdot \sin 0.4848 * \\ &= 3.163 + 1.730j, \end{aligned}$$

and  $\cosh \gamma s_1 = 3.284 + 1.666j,$

it follows from equation (58) that the maximum value of an alternating current arriving at the remote end of the 600-mile telegraph line is

$$\begin{aligned} I_r &= 212.2 \div \begin{cases} 2(300 + 471j)(3.284 + 1.666j) + [1528 \\ - 283j + (300 + 471j)^2(635 + 118j)10^{-6}] \\ (3.163 + 1.730j) \end{cases} \\ &= \frac{212.2}{5070 + 6157j} = 0.0169 - 0.0206j \text{ ampere,} \end{aligned}$$

or  $I_r = 16.9 - 20.6j$  milliamperes.

The absolute value of this maximum alternating-current value is  $\sqrt{(16.9)^2 + (20.6)^2} = 26.7$  milliamperes, and the corresponding unidirectional current of rectangular wave shape is  $\frac{3}{2} \times 26.7 = 40.1$  milliamperes.

The potential difference across the distant relay is

$$\begin{aligned} E_r &= I_r Z_r = (0.0169 - 0.0206j)(300 + 471j) \\ &= 14.77 + 1.78j \text{ volts.} \end{aligned}$$

\* See tables in Appendix.





*Effect of Employing Higher Signalling Speeds.* — If instead of 15 cycles, the speed of signalling in the foregoing example had been ten times as great as before, making the dot-frequency of the equivalent alternating current 150 cycles, then under otherwise identical conditions:

$$\begin{aligned} p &= 942.5, \\ \beta &= 0.00446, \\ \alpha &= 0.00597, \\ v &= 157,900 \text{ miles per second,} \\ \lambda &= 1052 \text{ miles,} \\ Z_r = Z_t &= 300 + 4710j \text{ ohms,} \\ \gamma_{s1} &= 2.676 + 3.582j, \end{aligned}$$

and the current traversing the remote relay is found to be

$$I_r = 1.08 - 0.457j \text{ milliamperes.}$$

The absolute value of this received current is 1.17 milliamperes, and the corresponding unidirectional current of rectangular wave-shape is  $\frac{3}{2} \times 1.17 = 1.75$  milliamperes. This value is only 4.3 per cent of that obtainable when the signalling speed is one-tenth as great. The influence of signalling speed upon the magnitude of the received impulses is, therefore, evident.

### *Direct-current Transmission Theory*

**9. Current in Leaky Line Conductors.** — When a unidirectional electromotive force is impressed upon a line conductor, the current at every point of the line assumes a steady value. Ignoring the short unsteady period of current growth, the steady current value at any point on the line distant  $s$  from its generator end may be determined without considering the effects of inductance and capacity of the line conductor. The current and voltage equations

to be satisfied are obtained by placing  $L = 0$  and  $C = 0$  in equations (1) to (4); whence for a leaky line

$$\frac{dE}{ds} = -RI, \quad (61)$$

$$\frac{dI}{ds} = -gE, \quad (62)$$

and

$$\frac{d^2I}{ds^2} = RgI, \quad (63)$$

$$\frac{d^2E}{ds^2} = RgE, \quad (64)$$

where  $R$  is the conductor resistance per mile, and  $g$  is the leakage conductance per mile of conductor length. Equations (63) and (64) are identical equations which differ only in the terminal conditions, and, therefore, the solution of one will suffice.

Choosing the former equation and multiplying both sides by  $2 \frac{dI}{ds}$ , there results

$$2 \frac{d^2I}{ds^2} \cdot \frac{dI}{ds} = 2 RgI \frac{dI}{ds},$$

which, when integrated, becomes

$$\left(\frac{dI}{ds}\right)^2 = RgI^2 + c_1.$$

Replacing the constant of integration  $c_1$  by  $Rgc_2^2$ , where  $c_2$  is also a constant, and separating the variables, there results

$$\frac{dI}{\sqrt{I^2 + c_2^2}} = \sqrt{Rg} ds.$$

Another integration yields

$$\log_e [c_3 (I + \sqrt{I^2 + c_2^2})] = \sqrt{Rg} \cdot s = \beta s,$$

where  $c_3$  is another constant of integration and  $\beta = \sqrt{Rg}$  is the attenuation constant. In exponential form, this equation becomes

$$\epsilon^{\beta s} = c_3 (I + \sqrt{I^2 + c_2^2}).$$

Squaring, and solving for  $I$ , gives

$$I = \frac{\epsilon^{\beta s}}{2 c_3} - \frac{c_2^2 c_3 \epsilon^{-\beta s}}{2}.$$

For convenience let  $\frac{1}{c_3} = A + B$  and  $c_2^2 c_3 = A - B$ ; further, let the exponential terms be replaced by their equivalent hyperbolic functions, viz.:

$$\epsilon^{\pm \beta s} = \cosh \beta s \pm \sinh \beta s.$$

Then 
$$I = A \sinh \beta s + B \cosh \beta s. \quad (65)$$

Differentiating this expression with respect to distance and substituting the result in equation (62), there results

$$E = -\frac{\beta}{g} (A \cosh \beta s + B \sinh \beta s). \quad (66)$$

Equations (65) and (66) are the expressions for current and voltage respectively at any point of the line, but the constants  $A$  and  $B$  are still to be evaluated from the terminal conditions.

If one source of electromotive force supplies current to the line and this source be located at one terminal, then the constants  $A$  and  $B$  may be determined by placing  $s = 0$  and representing the current and voltage at this end by  $I_0$

and  $E_0$  respectively. Since  $\cosh(0) = 1$ , and  $\sinh(0) = 0$ , it follows that

$$A = -\frac{g}{\beta} E_0,$$

and

$$B = I_0.$$

Substituting these values in equations (65) and (66) yields the current and voltage respectively at any point on the line distant  $s$  from its generator or sending end as

$$I = I_0 \cosh \beta s - \frac{g}{\beta} E_0 \sinh \beta s, \quad (67)$$

and 
$$E = E_0 \cosh \beta s - \frac{\beta}{g} I_0 \sinh \beta s. \quad (68)$$

Connecting a receiving instrument of resistance  $R_r$  to the far end of the line which has a length  $s_1$ , the current traversing this instrument would be

$$I_r = I_0 \cosh \beta s_1 - \frac{g}{\beta} E_0 \sinh \beta s_1, \quad (69)$$

and the voltage across its terminals would be

$$E_r = E_0 \cosh \beta s_1 - \frac{\beta}{g} I_0 \sinh \beta s_1. \quad (70)$$

Since  $R_r = \frac{E_r}{I_r}$ , it follows that the current entering the line will be

$$I_0 = E_0 \frac{R_r \frac{g}{\beta} \sinh \beta s_1 + \cosh \beta s_1}{R_r \cosh \beta s_1 + \frac{\beta}{g} \sinh \beta s_1}. \quad (71)$$

If, as is usual, there is a resistance at the sending end also, then  $E_0$  in the foregoing should be replaced by  $E_0' - I_0 R_s$ ,

where  $E_g'$  is the voltage of the generator, and  $R_t$  is the total resistance at the generator end of the line. Whence

$$I_g = E_g' \frac{R_r \frac{g}{\beta} \sinh \beta s_1 + \cosh \beta s_1}{(R_r + R_t) \cosh \beta s_1 + \left( \frac{\beta}{g} + R_r R_t \frac{g}{\beta} \right) \sinh \beta s_1}. \quad (72)$$

Substituting this value in equation (69) gives the current traversing the remote receiving instrument in terms of the generator voltage as

$$I_r = \frac{E_g'}{(R_r + R_t) \cosh \beta s_1 + \left( \frac{\beta}{g} + R_r R_t \frac{g}{\beta} \right) \sinh \beta s_1}. \quad (73)$$

Ayrton and Whitehead have shown that the best resistance of a receiving instrument on a leaky telegraph line is

$$R_r' = \frac{\beta}{g} \tanh \beta s_1$$

irrespective of the relation between the torque exerted and the ampere-turns applied.

**10. Illustration of Direct-current Signalling on a Leaky Telegraph Line.** — Consider a simplex telegraph circuit

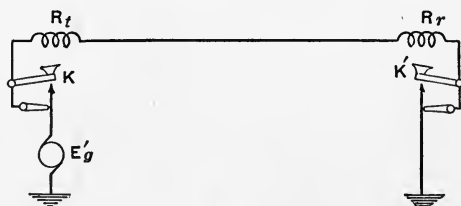

Fig. 5.

with a 320-volt direct-current generator at one terminal, as shown in Fig. 5. The line wire is 600 miles long of No.

10 B. & S. gage copper wire, and a 300-ohm relay is connected at each end. To determine the currents traversing the relays for various positions of the keys  $K$  and  $K'$ , when the insulation resistance is 0.5 megohm per mile.

In this example

$$\begin{aligned} E_g' &= 320 \text{ volts,} \\ R_t &= R_r = 300 \text{ ohms,} \\ R &= 5.28 \text{ ohms,} \\ g &= 2.00 \times 10^{-6} \text{ mhos,} \end{aligned}$$

and

$$s_1 = 600 \text{ miles;}$$

therefore,  $\beta = \sqrt{5.28 \times 2.00 \times 10^{-6}} = 0.00324,$

$$\beta s_1 = 1.944,$$

$$\sinh \beta s_1 = 3.422,$$

$$\cosh \beta s_1 = 3.565,$$

$$\frac{g}{\beta} = 0.000617,$$

$$\frac{\beta}{g} = 1620.$$

When both keys, or their circuit-closing switches, are closed, the current entering the line is obtained from equation (72) as

$$\begin{aligned} I_g &= 320 \frac{300 \times 0.000617 \times 3.422 + 3.565}{600 \times 3.565 + (1620 + 300^2 \times 0.000617) 3.422} \\ &= \frac{320 \times 4.198}{2139 + 5734} = 0.1706 \text{ ampere,} \end{aligned}$$

or 170.6 milliamperes; and the current that reaches the other end of the line is obtained from equation (73) as

$$I_r = \frac{320}{2139 + 5734} = 0.0406 \text{ ampere,}$$

or 40.6 milliamperes.

The closeness of this result to that obtained in § 8 by means of the alternating-current method for the same conditions and a 15 cycle frequency justifies the use of the direct-current method whenever the speed of signalling is much below the theoretically attainable speed on the line, as with hand signalling on open wire lines. The alternating-current method excels when dealing with long aerial and underground cables.

When key  $K'$  is opened, no current traverses the home relay, but the current flowing through the relay at the generator end of the line is obtained from equation (69) by placing  $I_r = 0$  and replacing  $E_g$  by  $E_g' - I_g R_t$ ;

$$\text{thus } I_g^\circ \cosh \beta s_1 = \frac{g}{\beta} (E_g' - I_g R_t) \sinh \beta s_1,$$

$$\text{whence } I_g^\circ = E_g' \frac{\sinh \beta s_1}{R_t \sinh \beta s_1 + \frac{\beta}{g} \cosh \beta s_1}$$

$$\text{or } I_g^\circ = \frac{E_g'}{R_t + \frac{\beta}{g} \coth \beta s_1}. \quad (74)$$

Substituting the numerical values herein gives

$$I_g^\circ = \frac{320}{300 + 1620 \times 1.042} = 0.161 \text{ ampere.}$$

For satisfactory operation, therefore, the relay at the generator end of the line must be very closely adjusted, for it should attract its armature on 170.6 milliamperes and release it on 161 milliamperes; thus giving a margin of 9.6 milliamperes. This condition is improved by the use of generators at both ends of the line, as will now be considered.



**11. Simplex Signalling with Generators at Both Line Terminals.** — If two equal cumulatively-connected sources of current be located one at each terminal of a line, as in the usual simplex Morse telegraph circuit, then the con-

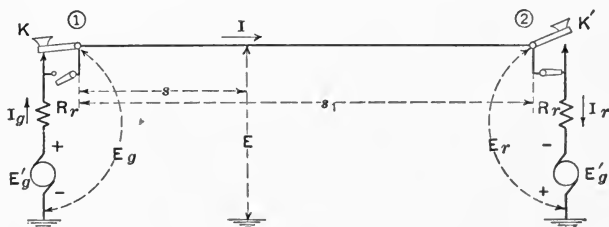

Fig. 6.

stants  $A$  and  $B$  of equations (65) and (66) are evaluated upon a consideration of the conditions shown in Fig. 6. Herein  $E'_g$  is the electromotive force of each generator,  $R_r$  is the total resistance at each terminal station,  $E_g$  and  $E_r$  are the potentials with respect to ground of the line wire at the stations 1 and 2 respectively, and  $I_g$  and  $I_r$  are the currents at these stations respectively.

When both keys are closed as shown, the current and line voltage at station 1 are obtained by placing  $s = 0$  in equations (65) and (66) respectively, whence

$$I_g = B,$$

and

$$E_g = -\frac{\beta}{g}A = E'_g - I_g R_r.$$

Similarly the current and line voltage at station 2 are obtained by placing  $s = s_1$  in the same equations, thus

$$I_r = A \sinh \beta s_1 + B \cosh \beta s_1,$$

and  $E_r = -\frac{\beta}{g}(A \cosh \beta s_1 + B \sinh \beta s_1) = -(E'_g - I_r R_r).$

The constants  $A$  and  $B$  are ascertainable from these four equations, and are

$$A = E_g' \frac{R_r \frac{g}{\beta} (1 - \cosh \beta s_1) - \sinh \beta s_1}{2 R_r \cosh \beta s_1 + \left( \frac{g}{\beta} R_r^2 + \frac{\beta}{g} \right) \sinh \beta s_1}, \quad (75)$$

and

$$B = E_g' \frac{\cosh \beta s_1 + R_r \frac{g}{\beta} \sinh \beta s_1 + 1}{2 R_r \cosh \beta s_1 + \left( \frac{g}{\beta} R_r^2 + \frac{\beta}{g} \right) \sinh \beta s_1}. \quad (76)$$

Substituting these values in equations (65) and (66) results in the current and voltage equations for any point on the line distant  $s$  from one end, when equal generators are connected to both ends of the line wire.

The current traversing the relays at stations 1 and 2 are respectively

$$I_g = B,$$

and

$$I_r = A \sinh \beta s_1 + B \cosh \beta s_1$$

as already indicated. Upon replacing  $A$  and  $B$  herein by their equivalents given in equations (75) and (76), these currents are found to be equal, as might be inferred from the symmetry of the line and terminal conditions, and have the value

$$I_g = I_r = E_g' \frac{\cosh \beta s_1 + R_r \frac{g}{\beta} \sinh \beta s_1 + 1}{2 R_r \cosh \beta s_1 + \left( \frac{g}{\beta} R_r^2 + \frac{\beta}{g} \right) \sinh \beta s_1}. \quad (77)$$

When one of the keys is opened the current traversing the relay at the other terminal station is given by equation (74).

To illustrate the advantage of dividing the total voltage

on a telegraph line, one-half being impressed at each end, consider the same circuit as was discussed in the preceding article. In this case a 160-volt generator is located at each end of the 600-mile line.

The current traversing each relay when both keys are closed is given by equation (77) as

$$I_g = I_r = 160 \frac{3.565 + 300 \times 0.000617 \times 3.422 + 1}{2 \times 300 \times 3.565 + (0.000617 \times 300^2 + 1620)3.422}$$

$$= 0.1056 \text{ ampere} = 105.6 \text{ milliamperes,}$$

while the current traversing a relay when the key at the opposite station is opened is given by equation (74) as

$$I_g^o = \frac{160}{300 + 1620 \times 1.042} = 0.0805 \text{ ampere}$$

$$= 80.5 \text{ milliamperes.}$$

The comparison of the two generator arrangements for the line under consideration is revealed in the following table, the current values being expressed in milliamperes. It is seen that with a generator at each end the operating margin is 25.1 milliamperes, as against 9.6 milliamperes at the home relay for a single generator of double voltage at the home end of the line.

Key positions	320-volt generator at home end		160-volt generators at both ends	
	Current through relay at generator end	Current through relay at distant end	Current through relay at home end	Current through relay at distant end
Both keys closed.....	170.6	40.6	105.6	105.6
Distant key open.....	161	0	80.5	0
Home key open.....	0	0	0	80.5
Operating Margin.....	9.6	40.6	25.1	25.1

12. **Duplex and Quadruplex Signalling.** — The theory of signalling on leaky lines discussed in the preceding pages is also applicable to duplex and quadruplex telegraph circuits if the terminal conditions are properly deduced. The general expressions for current and voltage are equations (65) and (66), wherein the constants  $A$  and  $B$  depend upon the conditions existing at the ends of the line wire. The values of these constants with duplex and quadruplex signalling are different from those pertaining to simplex signalling, already considered.

In a polar duplex circuit, let  $R_p$  = entire resistance of each polarized relay,  $R_b$  = resistance of each battery or of

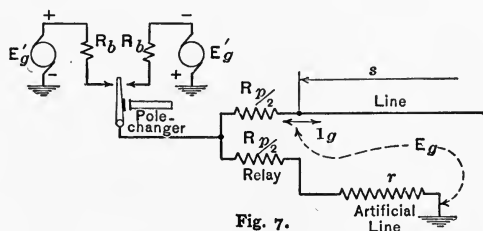

the protective resistance in series with each generator, and  $r$  = resistance of each artificial line, as indicated in Fig. 7 for one station. Placing  $s = 0$  in equations (65) and (66), there results

$$I_g = B,$$

$$\text{and } E_g = -\frac{\beta}{g}A = \frac{\frac{R_p}{2} + r}{R_b + \frac{R_p}{2} + r} E'_g - I_g \frac{R_p}{2} = qE'_g - I_g \frac{R_p}{2},$$

where  $\frac{\frac{R_p}{2} + r}{R_b + \frac{R_p}{2} + r} = q$  for simplicity. The current and

voltage conditions at the other end are obtained by placing  $s = s_1$ , whence

$$I_r = A \sinh \beta s_1 + B \cosh \beta s_1,$$

$$\text{and } E_r = -\frac{\beta}{g} \left( A \cosh \beta s_1 + B \sinh \beta s_1 \right) = \pm \left( qE_o' - I_r \frac{R_p}{2} \right),$$

the plus sign being taken when the two batteries or generators oppose each other as when both pole-changers are either idle or energized, and the negative sign being taken when the two current sources assist each other as with only one pole-changer energized. These expressions assume the current traversing the artificial lines to remain constant irrespective of key movements.

Solving for  $A$  and  $B$  from the preceding four equations, yields

$$B = qE_o' \frac{-\cosh \beta s_1 \pm \frac{R_p}{2} \cdot \frac{g}{\beta} \sinh \beta s_1 \pm 1}{\left( \pm 1 - 1 \right) \frac{R_p}{2} \cosh \beta s_1 + \left( \pm \frac{g}{\beta} \cdot \frac{R_p^2}{4} - \frac{\beta}{g} \right) \sinh \beta s_1}, \quad (78)$$

$$\text{and } A = \frac{g}{\beta} \left( B \frac{R_p}{2} - qE_o' \right). \quad (79)$$

The upper signs in equation (78) are employed when the generators oppose and the lower signs are used when the generators assist each other. Substitution of these values in equations (65) and (66) gives the final expressions for current and voltage in the case of a polar-duplex telegraph circuit.

The bridge duplex and the quadruplex terminal conditions may be similarly analyzed and the current and voltage equations formed.\* It is to be noted that the current passing through the relay of a bridge duplex circuit ex-

\* An excellent treatment of these conditions appears in a paper by F. F. Fowle on "Telegraph Transmission," Trans. A.I.E.E., v. 30, p. 1683.

pressed in terms of the current  $I_g$  at the end of the line wire and the voltage  $E_g'$  of the generator is

$$I_{\text{relay}} = \frac{aE_g' - aI_g(2R_b + r + a)}{(r + R_b)(2a + P) + a(a + P)}, \quad (80)$$

where  $P$  is the resistance of the relay,  $a$  = resistance of each half of the retardation coil,  $r$  = resistance of artificial line, and  $R_b$  = resistance in series with generator.

### PROBLEMS

1. Determine the attenuation and wave-length constants of a perfectly-insulated ground-return line having the following constants per mile, when the frequency of the impressed electromotive force is 50 cycles:  $R = 4.25$  ohms,  $L = 0.002$  henry, and  $C = 0.016$  microfarad.

2. Compute the current and voltage at both ends of an 800-mile line of No. 10 B. & S. gage copper wire and having a 300-ohm relay at each end. A 150-volt 15-cycle alternating-current generator is to be considered connected in one terminal of this simplex circuit in place of a 320-volt direct-current generator. The constants of the relay and line are those given in § 8. Construct the vector diagram of currents and electromotive forces.

3. Verify the value of  $I_r$  given in § 8 for signalling on a particular line at a speed corresponding to a dot-frequency of 150 cycles.

4. For different key positions, determine the unidirectional currents traversing the 250-ohm terminal relays on a 400-mile simplex telegraph line of No. 9 B. & S. gage copper wire. Assume the line to have an insulation resistance of 0.5 megohm per mile, and that a single 160-volt direct-current generator located at one terminal station supplies current to the circuit.

5. Calculate the currents traversing the relays of the line mentioned in the preceding problem when the 160-volt generator is replaced by two 80-volt generators, one at each line terminal.

6. Solve Problem 3 of Chap. II, taking into account a uniformly distributed leakance of  $10^{-6}$  mhos per mile for this 475-mile polar duplex circuit.

## CHAPTER XI

### SUBMARINE TELEGRAPHY

1. **Theory of Cable Telegraphy.** — Because of the large capacity and small leakance of submarine telegraph cables, the direct-current transmission theory discussed in the foregoing chapter is inapplicable to signalling over cables. However, the alternating-current transmission theory already considered may be utilized for cable telegraphy if the speed of signalling is such that a steady state is constantly approached within a reasonable margin. For practicable speeds on commercial cables this theory is limited to cable sections of moderate length. When the steady state is not nearly approached during each signal, then the growth and fall of the direct-current accompanying the application and withdrawal of constant voltage to one end of the cable are alone of importance. The consideration herein presented of these transitional states on long cables, conveniently called the *transition theory of transmission*, will reveal the nature of the current which reaches the distant terminal of the cable.

If a steady voltage  $E$  is applied to one end of a perfectly-insulated cable of length  $l$ , while the other end is grounded, the potential at each point gradually rises until its value at any point distant  $s$  from the sending end is

$$E_m' = E \frac{l-s}{l}, \quad (1)$$

which indicates that the voltage-distance graph for the steady condition is a straight line falling from  $E$  to zero, as shown in Fig. 1. Should this condition be altered, say

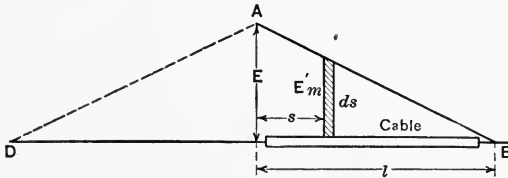

Fig. 1.

by grounding the sending end, then the voltage there at that instant would be zero, but at other places in the cable would be as indicated by equation (1). The subsequent voltage at any point is found by drawing an image of  $AB$  toward the left, forming a curve  $DAB$ , and considering this curve to represent a periodic function of distance; which is, therefore, expressible by a Fourier's series of the form

$$E_m' = F_0 + F_1 \sin \theta + F_2 \sin 2\theta + \dots + F_n \sin n\theta + G_1 \cos \theta + G_2 \cos 2\theta + \dots + G_n \cos n\theta,$$

where  $\theta = \frac{s\pi}{l}$  and  $n$  is any integer. To evaluate the coefficients, multiply both members by  $\sin n\theta$  times the width  $ds$  of the element and summate these elementary areas over the distance  $DB$ , and there results

$$\begin{aligned} \int_0^{2l} E_m' \sin n\theta ds &= F_0 \int_0^{2l} \sin n\theta ds + F_1 \int_0^{2l} \sin \theta \cdot \sin n\theta ds \\ &+ \dots + F_q \int_0^{2l} \sin q\theta \cdot \sin n\theta ds + \dots \\ &+ F_n \int_0^{2l} \sin^2 n\theta ds + G_1 \int_0^{2l} \cos \theta \cdot \sin n\theta ds + \dots \\ &+ G_q \int_0^{2l} \cos q\theta \cdot \sin n\theta ds + \dots + G_n \int_0^{2l} \cos n\theta \cdot \sin n\theta ds. \end{aligned}$$



Since  $E_m' = E - \frac{s}{l} E$ ,  $d\theta = \frac{\pi}{l} ds$ , and when  $s = 2l$  then  $\theta = 2\pi$ ,

$$\begin{aligned} E \int_0^{2\pi} \sin n\theta \, d\theta - \frac{E}{\pi} \int_0^{2\pi} \theta \sin n\theta \, d\theta &= F_0 \int_0^{2\pi} \sin n\theta \, d\theta \\ + F_1 \int_0^{2\pi} \sin \theta \cdot \sin n\theta \, d\theta + \dots + F_q \int_0^{2\pi} \sin q\theta \cdot \sin n\theta \, d\theta \\ + \dots + F_n \int_0^{2\pi} \sin^2 n\theta \, d\theta + G_1 \int_0^{2\pi} \cos \theta \cdot \sin n\theta \, d\theta + \dots \\ + G_q \int_0^{2\pi} \cos q\theta \cdot \sin n\theta \, d\theta + \dots + G_n \int_0^{2\pi} \cos n\theta \cdot \sin n\theta \, d\theta. \end{aligned}$$

The terms of this expression are integrated as follows:

$$\int_0^{2\pi} \sin n\theta \, d\theta = \left[ \frac{\cos n\theta}{n} \right]_0^{2\pi} = 0.$$

$$\int_0^{2\pi} \theta \sin n\theta \, d\theta = \left[ \frac{\theta}{n^2} \sin n\theta - \frac{\theta}{n} \cos n\theta \right]_0^{2\pi} = -\frac{2\pi}{n}.$$

$$\begin{aligned} \int_0^{2\pi} \sin q\theta \cdot \sin n\theta \, d\theta &= \frac{1}{2} \int_0^{2\pi} \left[ \cos(q-n)\theta - \cos(q+n)\theta \right] d\theta \\ &= \frac{1}{2} \left[ \frac{\sin(q-n)\theta}{q-n} - \frac{\sin(q+n)\theta}{q+n} \right]_0^{2\pi}. \end{aligned}$$

When  $q$  and  $n$  are different integers, substitution of the limits reduces this expression to zero.

$$\begin{aligned} \int_0^{2\pi} \sin^2 n\theta \, d\theta &= \frac{1}{2} \int_0^{2\pi} (1 - \cos 2n\theta) \, d\theta \\ &= \frac{1}{2} \left[ \theta - \frac{\sin 2n\theta}{2n} \right]_0^{2\pi} = \pi. \end{aligned}$$

$$\begin{aligned} \int_0^{2\pi} \cos q\theta \cdot \sin n\theta \, d\theta &= \frac{1}{2} \int_0^{2\pi} \left[ \sin(n+q)\theta + \sin(n-q)\theta \right] d\theta \\ &= -\frac{1}{2} \left[ \frac{\cos(n+q)\theta}{n+q} + \frac{\cos(n-q)\theta}{n-q} \right]_0^{2\pi}. \end{aligned}$$

This expression is zero whether the integers  $q$  and  $n$  are equal or unequal. Therefore, by substitution,

$$\frac{2E}{n} = \pi F_n \text{ or } F_n = \frac{2E}{\pi n},$$

and consequently the potential at any point of the cable distant  $s$  from the sending end where  $E$  volts are impressed, reaches the maximum value of

$$E_m' = \frac{2E}{\pi} \left( \sin \theta + \frac{1}{2} \sin 2\theta + \dots + \frac{1}{n} \sin n\theta \right)$$

$$\text{or } E_m' = \frac{2E}{\pi} \sum_{n=1}^{\infty} \left( \frac{1}{n} \sin \frac{n\pi s}{l} \right). \quad (2)$$

This equation represents the voltage distribution at the instant of grounding the sending end of the cable.

If, now, the potential distribution be left to itself, then the diminishing voltage all along the cable must satisfy the differential equation of propagation over a uniform line, namely, equation (4) of Chap. X, which is

$$CL \frac{d^2 E'}{ds^2} + (RC + gL) \frac{dE'}{dt} + RgE' = \frac{d^2 E'}{ds^2}, \quad (3)$$

where  $C$ ,  $L$ ,  $g$  and  $R$  are the cable constants per unit length. But in submarine telegraphy the inductance of cables is very small and the leakage conductance is very low, that is,  $L$  and  $g$  are negligibly small; so that the equation to be satisfied reduces to

$$\frac{d^2 E'}{ds^2} = RC \frac{dE'}{dt}, \quad (4)$$

the so-called "telegraph equation."

A solution of this equation suggests itself of the form

$$E' = E_m' \epsilon^{-n^2 bt} = \frac{2E}{\pi} \sum_{n=1}^{\infty} \left( \frac{1}{n} \epsilon^{-n^2 bt} \sin \frac{n\pi s}{l} \right), \quad (5)$$

where  $E'$  is the voltage at the point distant  $s$  from the sending end at a time  $t$  after grounding that end. Differentiating this expression twice with respect to distance there results  $-\frac{n^2\pi^2}{l^2}E'$ , and differentiating with respect to time there results  $-n^2bE'$ . Substituting these values in (4) yields

$$\frac{-n^2\pi^2 E'}{l^2} = -RCn^2bE';$$

whence 
$$b = \frac{\pi^2}{RCl^2}. \quad (6)$$

With this interpretation of the exponential constant, equation (5) is a solution of equation (4), for it reduces to equation (2) when  $t = 0$ , is zero when  $t = \infty$ , and is zero when  $s = 0$  or  $s = l$ .

The *fall* in voltage at the point of reference during the time  $t$  elapsing since *suppression* of voltage  $E$  at sending end by grounding is

$$e' = E_m' - E' = \frac{2E}{\pi} \left\{ \sum_{n=1}^{\infty} \left( \frac{1}{n} \sin \frac{n\pi s}{l} \right) - \sum_{n=1}^{\infty} \left( \frac{1}{n} e^{-n^2bt} \sin \frac{n\pi s}{l} \right) \right\}. \quad (7)$$

On the other hand, if the origin of time were taken at the instant when the voltage  $E$  is *applied*, the *rise* in voltage during the time  $t$  at the point of reference is also given by equation (7). This expression also satisfies equation (4) since it is the difference of two expressions which satisfy it separately.

The growth of current in the cable at the point under consideration is obtained by differentiating (7) with respect to distance, and using  $de' = -R ds \cdot I'$ . Thus, the current

value at a time  $t$  after applying the voltage  $E$  to the sending end is

$$I' = -\frac{2E}{Rl} \left\{ \sum_{n=1}^{\infty} \cos \frac{n\pi s}{l} - \sum_{n=1}^{\infty} \left( \epsilon^{-n^2bt} \cos \frac{n\pi s}{l} \right) \right\}. \quad (8)$$

At the receiving end  $s = l$ , and the current is

$$I_r' = -\frac{2E}{Rl} \left\{ \sum_{n=1}^{\infty} \cos n\pi - \sum_{n=1}^{\infty} \left( \epsilon^{-n^2bt} \cos n\pi \right) \right\}.$$

But  $\sum_{n=1}^{\infty} \cos n\pi = -1 + 1 - 1 + 1 - \dots$ ;

transposing the first term of the right hand member, there results

$$1 + \sum_{n=1}^{\infty} \cos n\pi = 1 - 1 + 1 - 1 + \dots,$$

and adding these two series term by term it will be found that

$$\sum_{n=1}^{\infty} \cos n\pi = -\frac{1}{2}.$$

Consequently, the instantaneous current at the grounded receiving end is

$$I_r' = \frac{E}{Rl} \left\{ 1 + 2 \sum_{n=1}^{\infty} \left( \epsilon^{-n^2bt} \cos n\pi \right) \right\}, \quad (9)$$

when both ends of the cable are without sending or receiving instruments. The series

$$\sum_{n=1}^{\infty} \left( \epsilon^{-n^2bt} \cos n\pi \right) = -\epsilon^{-bt} + \epsilon^{-4bt} - \epsilon^{-9bt} + \dots,$$

and when  $t$  is zero, the sum is  $-1 + 1 - 1 + \dots = -\frac{1}{2}$  as before, and therefore  $I_r'$  is zero when time begins.

As the foregoing expression for  $I_r'$  is slowly convergent for small values of  $t$  it is more convenient, for purposes of

evaluating the received current at first, to alter its form into a rapidly-converging series by means of an equality due to Fourier that

$$1 + 2 \sum_{n=1}^{\infty} \epsilon^{-\frac{n^2\pi}{q^2}} \cos \frac{2n\pi p}{q} = q \sum_{m=-\infty}^{\infty} \epsilon^{-\pi(p+mq)^2}.*$$

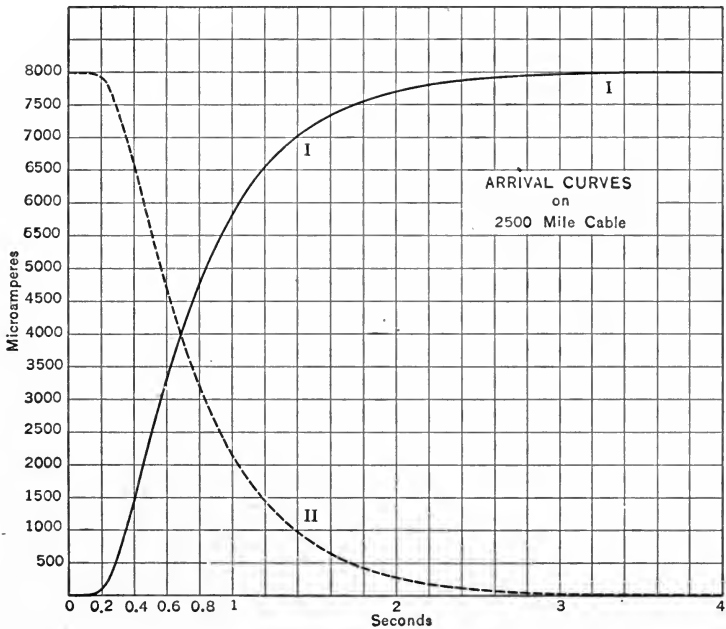

Fig. 2.

Taking  $bt = \frac{\pi}{q^2}$  and  $\frac{2p}{q} = 1$ , equation (9) becomes

$$I_r' = \frac{E}{Rl} \sqrt{\frac{\pi}{bt}} \sum_{m=-\infty}^{\infty} \epsilon^{-\pi(\frac{1}{2} + m)^2 \frac{\pi}{bt}};$$

\* Sir William Thomson, "Collected Papers," V. 2, p. 48; 1884 ed.

then using equation (6), there results

$$I_r' = 2E \sqrt{\frac{C}{\pi Rl}} \sum_{m=0}^{\infty} \epsilon^{-\frac{(2m+1)^2\pi^2}{4bt}}. \quad (10)$$

If the key be kept depressed, the current at the receiving end will grow from 0 for  $t = 0$  to the value  $\frac{E}{Rl}$ , as obtained from (9) by placing  $t = \infty$ . The graph of current growth will resemble curve *I*, Fig. 2. When the battery is removed and the sending end grounded, the current at the other end will decay as shown by curve *II*, which is the same as curve *I* drawn downward from the steady current value as axis.

**2. Illustration of Current Growth at the Receiving End of a Cable.** — As an example of the growth of the current at the receiving end of a cable, consider a 2500-mile cable having a total resistance of 5000 ohms and a total capacity of 987 microfarads to have 40 volts impressed upon the sending end. Thus,  $Rl = 5000$  ohms and  $Cl = 0.000987$  farad; therefore  $b = \frac{\pi^2}{5000 \times 0.000987} = 2.00$ , and the ultimate current value at the grounded receiving end of the cable is 0.0080 ampere. Values of  $I_r'$  to an accuracy of a fraction of one per cent can be obtained by using only the first terms of equations (9) and (10), if the latter be used for time intervals up to one second, say, and the former for longer intervals. For the conditions of this example, the equations utilized are

$$I_r' = 2E \sqrt{\frac{C}{\pi Rl}} \epsilon^{-\frac{\pi^2}{4bt}} = \frac{0.02003}{\sqrt{t}} \epsilon^{-\frac{1.2337}{t}} \text{ amperes for } t < 1,$$

and

$$I_r' = \frac{E}{Rl} \left( 1 - 2 \epsilon^{-bt} \right) = 0.008 \left( 1 - 2 \epsilon^{-2t} \right) \text{ amperes for } t > 1.$$

The values of current at the receiving end of this cable as calculated from these expressions (see table of exponential functions in Appendix) for different values of  $t$  are given in the following table, and are also shown by curve  $I$  of Fig. 2. It will be observed that the application of voltage to one end of a cable produces an instantaneous effect at the other, but the growth of current at first is so extremely slow as to give rise to the impression that there is at first a "silent interval."

$t$ seconds	$I_r'$ microamperes	$t$ seconds	$I_r'$ microamperes
0	0	0.80	4794
0.05	0.0000017	0.90	5357
0.10	0.279	1.00	5835
0.15	14.96	1.20	6548
0.20	93.6	1.50	7204
0.25	288	1.70	7466
0.30	599	2.00	7707
0.40	1451	2.50	7892
0.50	2401	4.00	7995
0.60	3302	10.00	7999
0.70	4112	$\infty$	8000

**3. Transmission of Telegraphic Signals.** — The alphabetic code used generally for cable telegraphy is the continental Morse Code, comprising for its characters various combinations of dots and dashes as tabulated in § 7 of Chap. I. The transmission of a letter is usually accomplished by repeated applications of constant potential for equal intervals of time to one end of the cable, the potential

differing in direction for dots and for dashes. With this method of signalling over cables the code for alphabet and figures is better represented as below, dots and dashes being indicated respectively by upwardly and downwardly projecting rectangles of equal length.

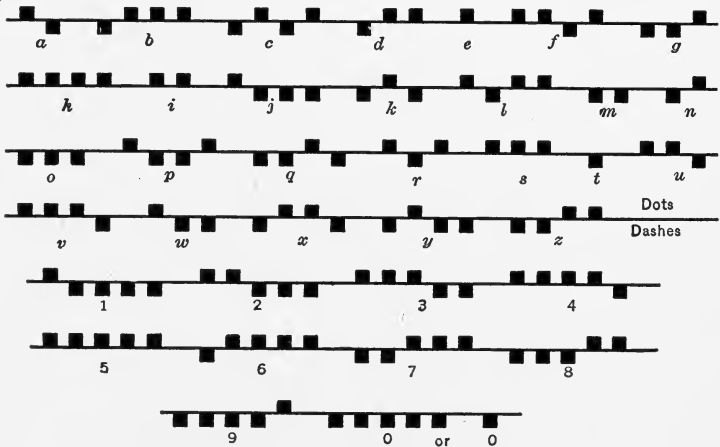

Taking  $\tau$  seconds as the duration of a dot or dash element, the interval between elements is generally  $\tau$ , that between letters  $3\tau$ , and that between words  $7\tau$ . By an analysis of traffic matter it is found that the average letter contains 7.2 elements, including space between letters, and hence requires  $7.2\tau$  seconds for transmission.

Signals are usually sent, therefore, as a succession of equal rectangular voltage-time pulses differing in direction and spaced irregularly. If the alternating-current theory of wave propagation were applied to cable signalling, two hypothetical frequencies for an equivalent sine wave would be recognizable, namely: the dot-frequency, as outlined in the foregoing chapter, and the *reversal-frequency*, as



indicated in Fig. 3; the former being twice as high as the latter. Kennelly\* has considered both frequencies in ascertaining the best resistance of receiving instruments on cables, and the influence of terminal apparatus upon signalling speed. He has shown that the receiving instru-

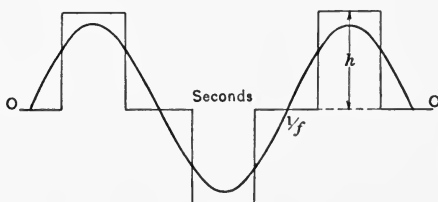

Fig. 3.

ment for greatest sensitiveness should have a resistance equal to the resistance component of the surge impedance of the cable plus the resistance component of reactive apparatus, if any, in the receiving circuit. The surge impedance, from § 4 of Chap. X, being in general

$$\frac{\beta + j\alpha}{g + jpC} \text{ or } \sqrt{\frac{R + jpL}{g + jpC}}$$

becomes  $\sqrt{\frac{R}{jpC}}$  ohms for highly insulated cables, where  $p = 2\pi$  times the frequency (dot- or reversal-frequency as selected) of the equivalent alternating current. Thus, taking a reversal-frequency of 4 cycles per second in the numerical illustration of § 2, and with no reactive apparatus at the receiver, the best resistance of the winding of the receiving instrument, as found by this method, is the resistance component of

\* "Hyperbolic Functions applied to Electrical Engineering," 1912, Chap. 9.

$$\sqrt{\frac{\frac{5000}{2500}}{2\pi 4j \frac{0.000987}{2500}}} = \sqrt{202,000} (90^\circ) = 449 (45^\circ)$$

or is  $449 \cos 45^\circ = 317$  ohms.

Reverting to the transition theory of cable transmission, a dot or dash may be transmitted by applying a unidirectional voltage at the sending end of the cable for  $\tau$  seconds, thereafter grounding that end; consequently the equation for a dot or dash is obtained by subtracting from equation (9) a similar equation in which the time  $t$  is replaced by  $t - \tau$ ; whence

$$I_d' = \frac{2E}{Rl} \left\{ \sum_{n=1}^{\infty} \left( \epsilon^{-n^2bt} \cos n\pi \right) - \sum_{n=1}^{\infty} \left( \epsilon^{-n^2b(t-\tau)} \cos n\pi \right) \right\}. \quad (11)$$

In other words, a dot is transmitted by the maintenance of voltage at the sending end for an infinite time, and after  $\tau$  seconds the application of an equal opposite potential also maintained indefinitely. The subtraction indicated in equation (11) is most conveniently done graphically. The curve of arrival of a dash element for a contact lasting 0.1 second on the cable considered in the foregoing numerical illustration is shown by curve  $I$  of Fig. 4 as the sum of curves  $a$  and  $b$ . An enlarged view of this curve is shown by curve  $T$ , the multiplier being 5. It will be evident that the shorter the contact the lower and flatter will be the curve of received current for a dot or dash element.

By applying the foregoing method it is a simple matter to construct a curve showing the received instantaneous current for any combination of dots and dashes. It is only necessary to plot the same dash arrival curve in the proper places and with proper direction and then add the ordinates.

Thus in Fig. 4 are also shown the forms of received signals on this cable for the letters *E*, *N*, *D*, *B* and *BT*, the lower dotted lines representing the nature of the impressed elec-

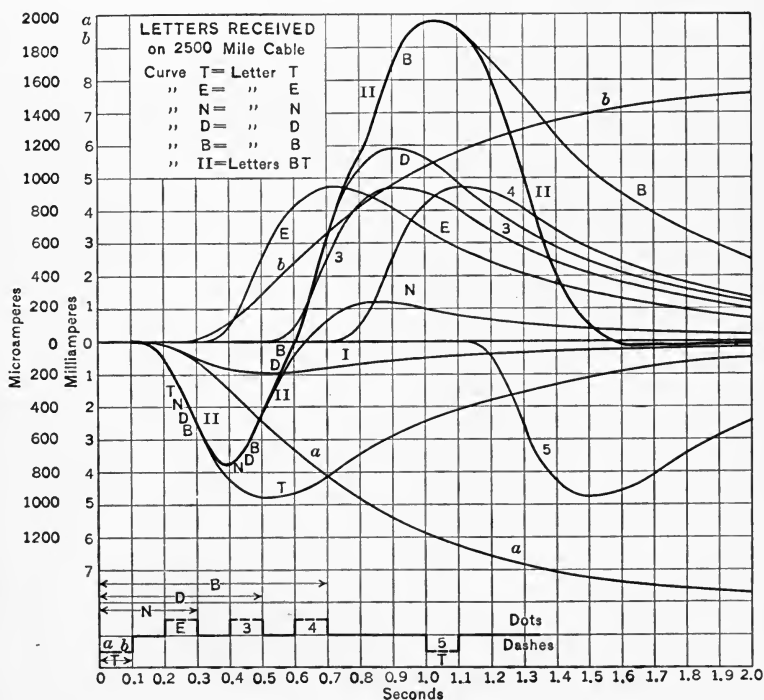

tromotive force. Curve *II* exhibits the cumulative action of successive like signals for a signalling speed of  $\frac{60}{7.2 \times 0.1} = 83.3$  letters per minute and the result is apparently undecipherable, but still it would be legible to an expert recorder attendant.

In Fig. 5 is shown the received current curve for the

same letters *BT* sent at the same speed on a shorter cable having the same constants per unit length as that previously considered. The variations in this curve are very prominent and are easily interpreted.

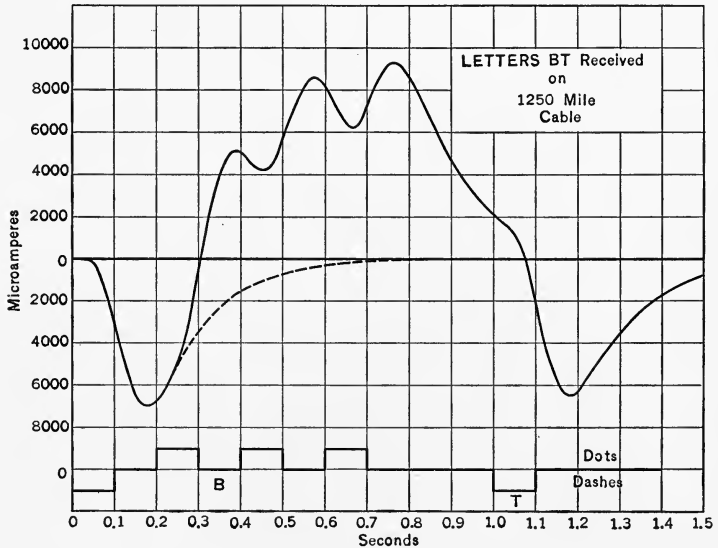

Fig. 5.

The receiving instrument used in cable telegraphy over relatively short distances (several hundred miles) is the ordinary sensitive relay, while over long distances the siphon recorder is used. The siphon recorder, devised by Lord Kelvin in 1867, traces on a paper tape the curve of current which traverses the instrument winding. This recorder is a D'Arsonval galvanometer, the movements of the coil of which are transmitted by means of two silk fibres to an extremely small glass siphon. As one end of this siphon passes transversely to and fro across the slowly-

moving tape, it takes ink at the other end from a small reservoir and exudes it upon the paper in the form of a wavy line. To eliminate friction, the siphon is kept vibrating rapidly, by means of an electromagnetic vibrator, so as to oscillate perpendicularly to the paper, thereby forming a trace that really consists of a succession of closely

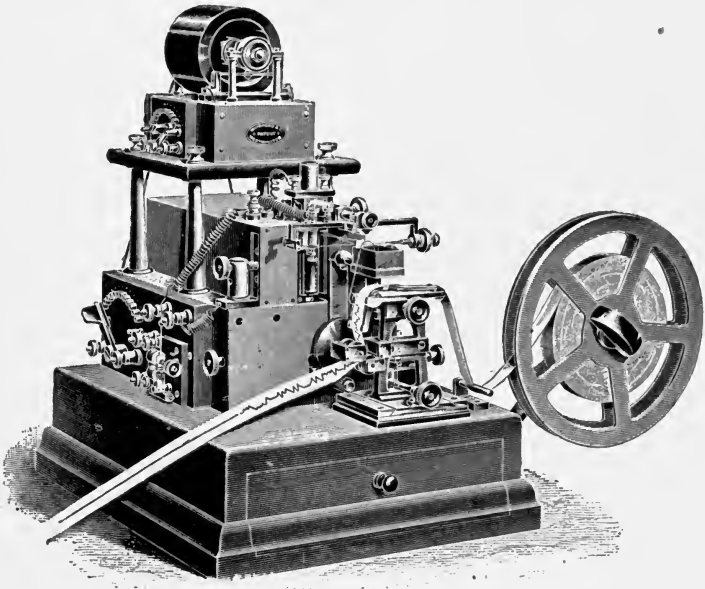

Fig. 6.

spaced dots. Fig. 6 shows a siphon recorder made by Muirhead & Co., Ltd. The suspension piece with vibrator is shown in Fig. 7.

Fig. 8 is a reproduction to exact size of a portion of a message which was transmitted over the Bay Roberts, N. F.-New York 1610-mile cable at a speed of 200 letters per

minute  $\left(\tau = \frac{60}{200 \times 7.2} = 0.0416 \text{ second}\right)$ . The dotted neutral line shows that the siphon recorder in practice does not behave as a fixed-zero instrument.

The resistance of siphon recorders is usually between 300 and 800 ohms, and their inductance about 0.2 to 0.3 henry.

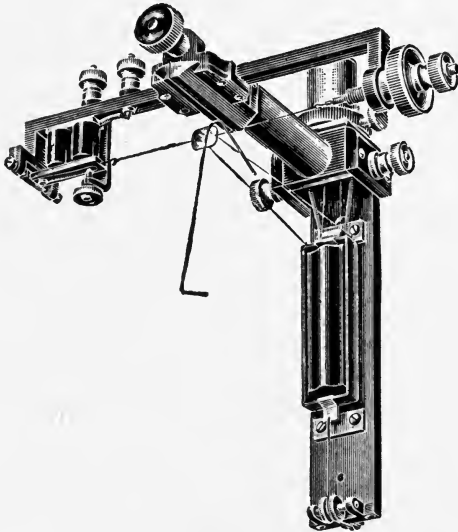

Fig. 7.

The recorder will operate satisfactorily on a current as small as 20 to 40 microamperes.

Signals are sent either manually or by means of automatic transmitters such as described in § 1 of Chap. IV. Fig. 9 shows a cable key with removable contact levers. Automatic transmission by means of perforated tapes results in greater speed and more regularity in the signals than is possible with hand transmission; it is the method, therefore, chiefly employed in cable telegraphy.

4. **Speed of Signalling.** — From the foregoing expressions it will be seen that the received current is a function of  $bt$ , consequently the time required to establish a given current at the far end varies inversely with  $b$  or directly

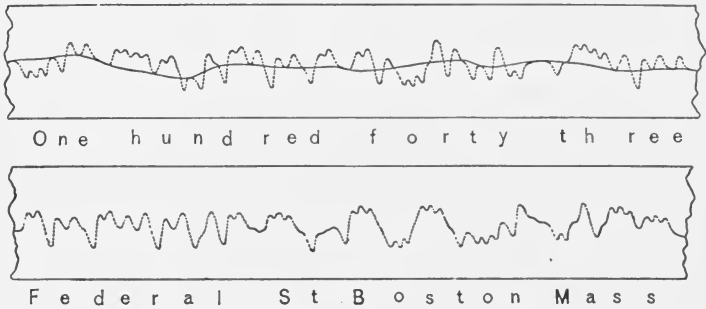

Fig. 8.

with  $\frac{CRl^2}{\pi^2}$ . Since the speed of signalling varies inversely with the time required for establishing the necessary current, this speed varies directly with  $\frac{\pi^2}{CRl^2}$ , or it varies in-

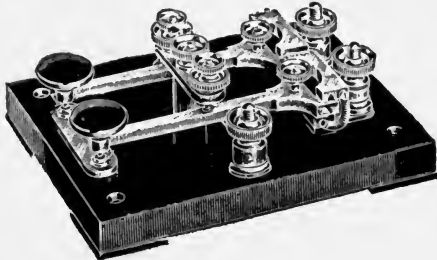

Fig. 9.

versely with the product of the total resistance and total capacity of the cable. Also, when  $C$  and  $R$  are kept constant, the speed of signalling varies inversely with the square of the cable length.

Accordingly, the speed of signalling over a given distance may be increased by decreasing the total capacity or the total resistance or both. The capacity depends upon the conductor diameter, upon the distance between conductor and metallic sheath and upon the dielectric constant of the cable insulation. Greater separation between conductor and armor and the use of larger wire are accompanied by an increase in cost. Further, with very few exceptions, no insulating material having a lower dielectric constant than gutta percha compound has been successfully used up to the present time in submarine cables.

The statement that the speed of signalling varies inversely with the product of total resistance and total capacity of a cable is called the "CR Law" and was announced by Lord Kelvin. In other words, two cables of length  $l_1$  and  $l_2$  having the constants  $C_1, R_1$  and  $C_2, R_2$  respectively will be similar (that is, yield the same arrival curves under identical conditions) when

$$C_1 R_1 l_1^2 = C_2 R_2 l_2^2. \quad (12)$$

This is only true when the cable is entirely devoid of inductance and leakance, has no terminal apparatus, and is earthed at both ends. Malcolm has shown that two cables having the constants  $C_1, L_1, R_1, g_1$  and  $C_2, L_2, R_2, g_2$  and with terminal apparatus of impedances  $Z_{t1}, Z_{r1}$  and  $Z_{t2}, Z_{r2}$  at transmitting and receiving ends respectively will be similar when

$$\frac{R_1 l_1}{R_2 l_2} = \frac{L_1 l_1}{L_2 l_2} = \frac{C_2 l_2}{C_1 l_1} = \frac{g_2 l_2}{g_1 l_1} = \frac{Z_{t1}}{Z_{t2}} = \frac{Z_{r1}}{Z_{r2}} = \eta, \quad (13)$$

and the size of the signals will be in the ratio of  $\eta$  to 1. This generalized expression may be appropriately called Malcolm's law. It reduces to equation (12) when the



cable inductance and leakance and the terminal apparatus are ignored.

Fig. 4 shows the graph of current received over a 2500-mile cable without terminal apparatus for the letters *BT* with contacts of 0.1 second. Taking 7.2 elements for an average letter including space, the number of five-letter words transmitted per minute over this cable, having  $CRl^2 = 4.935$  ohm-farads or seconds, under these conditions would be  $\frac{60}{(7.2 \times 5 + 4) 0.1} = 15$ . Signalling at this speed gives legible results, as evinced by the figure. The greater legibility for the same signalling speed over a shorter cable is manifest from Fig. 5 for  $CRl^2 = 1.234$  seconds. The maximum speed of signalling over any cable is determined by constructing arrival curves of various words using different values of  $\tau$  and submitting these to an experienced operator to determine the limit of legibility. On short cables the inertia of the receiving instrument prevents the attainment of the theoretically possible speed of transmission.

The use of condensers in series with a cable at one or both of its ends affords better definition in the received signals. The curves of Fig. 10, calculated according to a method given by Malcolm,\* show the arrival curves for the same cable considered in the foregoing numerical illustration, with terminal condensers. Curve *I* represents the received current curve when a condenser of  $\frac{1}{2} \frac{1}{C}$  the capacity of the cable is connected in series with the cable at one end. Curve *II* represents the current curve when a condenser of  $\frac{1}{10} \frac{1}{C}$  the capacity of the cable is connected at each end. This curve is considerably lower than the first but its decay is

\* The Electrician, V. 69, pp. 315-318 and 98r.

much more rapid. The advantage of introducing a condenser of  $\frac{1}{40}$  the capacity of the cable in series with it at its middle point, if possible from a practical viewpoint, is shown by curve *III*. The ultimate steady current value for all of these conditions is zero.

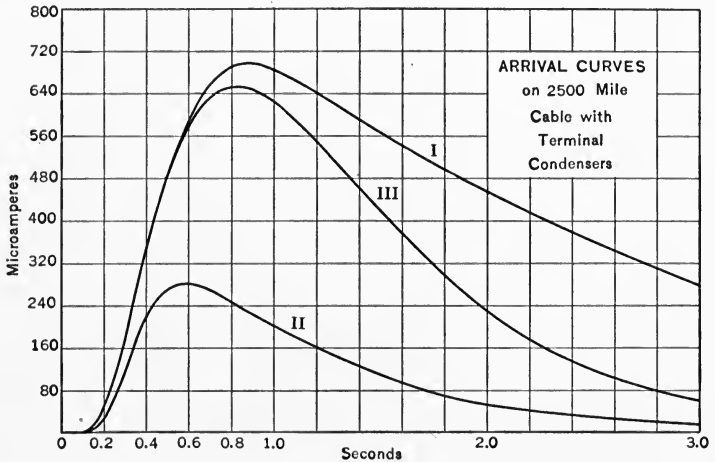

Fig. 10.

By subtracting from curve *II* a similar curve following the first at an interval of 0.1 second, the received current curve for a dot of that duration will result, and is shown in Fig. 11 by curve *I*. A comparison of this curve with curve *T* of Fig. 4 displays the fact that the maximum current is attained sooner with condensers than without them, but this maximum is very much lower; and further that the positive current lobe is followed by a negative pulse when using condensers.

When the letters *BT* are transmitted over this cable with condensers of 98.7 microfarads at each end, the received

current appears as in Fig. 11, curve *II*, when the time of a dot or a dash is 0.1 second. The result is more legible than the curve of Fig. 4 for the same signalling speed without

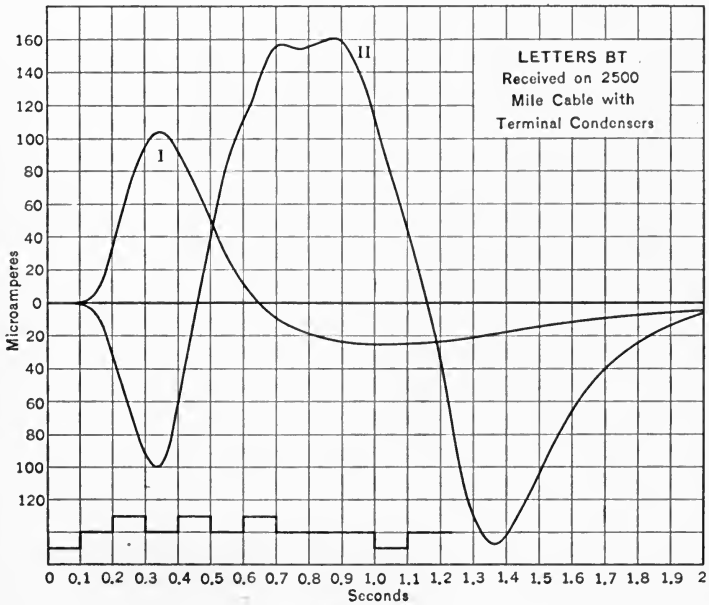

Fig. 11.

condensers, and, consequently, the speed with condensers might be increased for the same degree of legibility. The use of condensers at the ends of cables also serves to stop earth currents and to facilitate duplex cable operation (§ 7).

**5. Picard Method of Signalling.** — In transmitting signals over great distances through several cables connected in series the speed of signalling is very low, but if messages are repeated at intermediate stations the speed of signalling is higher and is limited by the speed on that

cable section having the largest value of  $CRl^2$ . This repeating of messages has been done manually, but from time to time schemes have been devised and placed in operation to utilize automatic retransmission in order to avoid error and loss of time. When the received signals are such that if a straight zero line of some width be drawn on the tape all of the lobes which correspond to dots or dashes still project on their respective sides of this zero line, then the retransmission of these signals may be accomplished automatically by the use of suitable relays, such as the Brown drum relay or the Muirhead gold-wire relay.

The signalling systems of Picard and Gott, using modifications of the ordinary Morse code, are arrangements for permitting the automatic retransmission of messages, even on cables having a large value of  $CRl^2$ .

In the Picard method, the signals are formed by the time interval between two momentary oppositely-directed equal impulses, a dash being distinguished from a dot by a longer interval between these impulses. Thus, the impressed

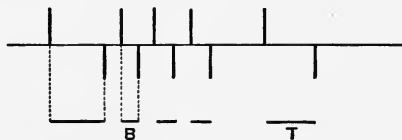

Fig. 12.

impulses for the letters  $BT$  are roughly shown in Fig. 12. These impulses are impressed upon the cable by means of two polarized relays  $P, P'$  and a local condenser  $C$ , connected as shown in Fig. 13. A depression of the key  $K$  causes a momentary kick of the right-hand relay armature against its contact stud and connects the positive pole of the main battery  $B$  to the cable for an instant. When the

key comes to rest after each dot or dash signal the other relay armature shifts and causes the negative pole of the battery to be connected momentarily to the cable. Between these cable impulses the sending end of the cable is open-circuited, and the impressed charge passes through

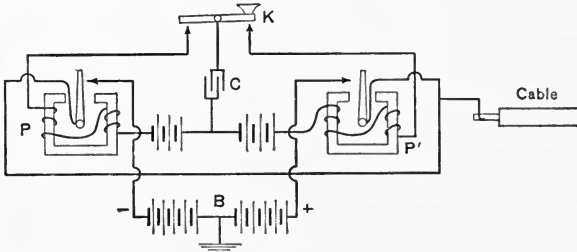

Fig. 13.

the receiver. The receiving device is a suspended-coil relay which has no retractile springs and is free to respond to cable impulses. This system has been used for many years on the three Marseilles-Algiers cables (560 miles) belonging to the French government for Morse signalling and also for Baudot printing telegraphy from Paris to Algiers with automatic translating relays at Marseilles.

**6. Gott Method of Signalling.** — The method of cable signalling devised by Gott utilizes the Morse code of short applications of potential for dots and longer applications for dashes, with successive elements in opposite directions, and employing a sensitive relay at the receiver. Inasmuch as a relay of definite and sufficient sensibility connected to the far end of a long cable operated at high speed in the ordinary way (§ 3) could not properly automatically retransmit unidirectional impulses into another cable owing to the spreading out of the signals received by it, the message in the Gott

system consists of an assemblage of lobes, alternately positive and negative, one lobe for each dot and one for each dash, and the latter distinguished from the former by their greater length. Fig. 14 shows the results obtained by using

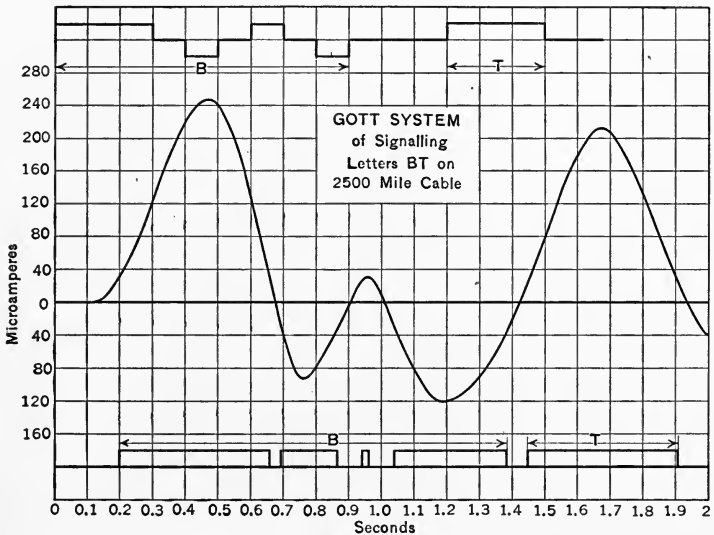

Fig. 14.

this method over a long cable. The upper line shows the impressed voltage on the 2500-mile cable previously considered with terminal condensers, for the letters *BT*, having dashes three times as long as dots; the curve shows the current form received at the end of this cable and traversing the relay; and the lower line shows the voltage impressed upon the second cable by the relay, which is assumed to respond to currents as small as 30 microamperes. The curve is constructed by the addition of properly placed dot arrival curves of the type shown by curve *I* of Fig. 11, and dash arrival curves obtained by adding two curves

(the latter reversed) of the type shown by curve *II* of Fig. 10 with an interval of 0.3 second between them. It will be observed that the second dot in Fig. 14 is very short while the third dot is almost as long as the dashes. This distortion of signals may render deciphering difficult, but the method can be improved upon by giving each impressed letter its theoretically best shape. Much better results are attained over shorter cable sections.

One arrangement for automatically reversing the direction of the voltage impressed upon the cable is shown in

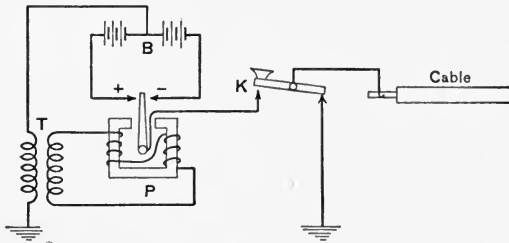

Fig. 15.

Fig. 15. The outer terminals of the split battery *B* connect with the contacts of the polarized relay *P*, and the middle tap is grounded through the primary winding of transformer *T*. The secondary winding of this transformer connects with the coils of the relay. Depressing the key *K* charges the cable with a polarity depending upon whichever contact stud the relay armature is touching. Permitting the key to resume its normal position will cause the cable to be grounded at the sending end after each signal.

The function of the transformer is to control the relay armature so that successive impulses will always be of different polarity. Assuming the armature to rest against

its left contact, depression of the key will cause a current to be produced in the secondary of the transformer and in the relay coils in such direction as to hold the armature to the left contact, thereby securing firm contact. Releasing the key causes a current of opposite polarity to flow through the relay coils, consequently the armature will move against the opposite contact stud in readiness for the next signal. For automatic retransmission, from an overland line to a submarine cable or from one cable to another, the key may be replaced readily by the armature of a relay.

The receiver employed with this system is a recorder with a contact-making tongue attached to the moving coil. This tongue plays between two contacts, alternately touching one and then the other. These contacts are connected together and lead to a battery and sounder (or relay) and back to the tongue, thus forming a local circuit for the reading of the received Morse dot and dash characters.

**7. Duplex Cable Telegraphy.** — In modern practice telegraph cables are generally duplexed so that messages may be sent in both directions simultaneously. This practice involves the use of an artificial cable equivalent in capacity and resistance to the actual cable arranged at each end of the submarine cable, as shown in Fig. 16. Artificial cables may be constructed in a variety of ways. The Muirhead artificial cable is widely used and consists of zigzag tinfoil sheets, connected in series, separated by means of paraffined paper from other sheets of tinfoil. The latter sheets are grounded, or may be grounded through resistances, while the zigzag sheets are so proportioned as to have the requisite resistance and also the proper capacity with respect to the grounded sheets.



The real and artificial cables may be considered as forming two arms of a Wheatstone bridge, the other arms being formed by two nearly equal condensers  $C_1$  and  $C_2$  of from 30 to 80 microfarads capacity each, arranged in the so-

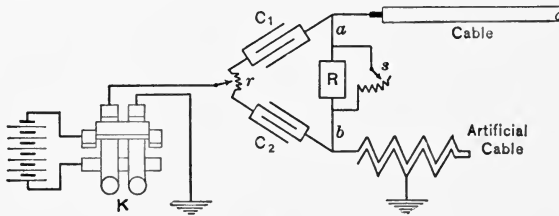

Fig. 16.

called *double block*. One of these condensers should be slightly adjustable in capacity so that with the variable resistance,  $r$ , an accurate balance may be secured. The siphon recorder,  $R$ , provided with an adjustable inductive shunt,  $s$ , is connected across the bridge, while the reversible battery is connected from  $r$  to ground through the double key  $K$ . The function of the inductive shunt is to make up the deficiency in recorder inductance for maximum arrival current, so that, according to the alternating-current transmission theory already mentioned, the receiving circuit reactance neutralizes the reactance component of the cable surge-impedance. Another arrangement employs a condenser in series with the recorder and shunted by a resistance, the inductive shunt being bridged across both condenser and recorder.

When balance is procured, depression of one of the keys establishes a current which divides equally in the two circuits, one through the condenser  $C_1$  and the cable and the other through the condenser  $C_2$  and the artificial cable. Hence the terminals  $a$  and  $b$  of the recorder have the same

potential and, consequently, no current flows through this instrument. Thus, manipulation of the key does not affect the home recorder.

If, however, a current arrives at this end of the cable, part passes through the recorder to ground jointly through the artificial cable and condenser  $C_2$ , while the remainder passes through the condenser  $C_1$  directly to ground. Thus the key at one end controls the operation of the recorder at the other end of the cable. In this way signals may traverse the cable in opposite directions at the same time without interference. The Gott signalling method is also applicable to duplex cable operation. Considerable care must be exercised in adjusting the artificial lines to secure a good balance, and such adjustment is always made with the distant end of the cables open-circuited.

**8. Sine-wave Signalling.** — A method of signalling on cables was devised by Crehore and Squier which employs a tape transmitter for impressing half sine waves of electromotive force upon the cable instead of the usual rectangular wave-forms. The battery ordinarily employed is, therefore, replaced in this system by a low-frequency alternator. The tape has three lines of holes, the upper for dots, the lower for dashes, and the center line of guide holes engages with a toothed wheel driven by the alternator shaft so that the tape travels a definite distance for each revolution of the alternator armature. The tape passes beneath two rollers attached to levers, which close a local circuit at their other ends whenever perforations move under a roller. Two relays in this local circuit connect the alternator to the cable in the proper way and for a proper time. The appearance of the tape and the corresponding form of the

impressed voltage for the letters *cab* are shown in Fig. 17. The mechanical and electrical features of the transmitter excel those of the Wheatstone automatic transmitter.

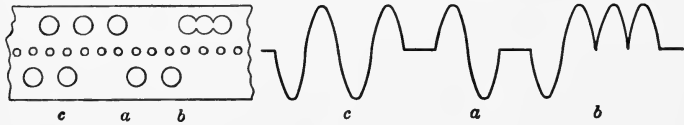

Fig. 17.

This system of signalling was operated experimentally by its inventors over actual submarine cables and resulted in a higher signalling speed than afforded with the usual battery system under like conditions. Recently, Malcolm\* has published the results of his analytical investigation of this sine-wave system of cable signalling, in which he concludes that (a) the received signals resulting from short applications of any symmetrical electromotive force are independent of the shape of the voltage wave and dependent only upon its mean value, and (b) the impressed sine-wave voltage produces less shock at the sending end of the cable than the abrupt battery wave-shapes. It is not unreasonable to expect the commercial application of this sine-wave signalling system.

**9. Design of Submarine Cables.** — A submarine cable consists of a copper conductor surrounded by a tube of gutta-percha insulation, all of which is protected by jute coverings and by spirally-laid metallic armor. It has been pointed out that the speed of signalling on such cables (ignoring terminal apparatus, inductance and leakance) varies inversely with the product of the conductor resistance and the capacity of the conductor with respect to the sheath.

\* The Electrician, v. 72, pp. 14-17, 50-52, 131-134, 245-247.

A large conductor surrounded by a thin tube of insulation may have the same product of capacity and resistance as a small conductor surrounded by a thick tube of insulation, but the cost will be different. To find the sizes of conductor and insulation which yield the minimum cost of cable of given length for a specified signalling speed (that is, for a given value of  $CR$ ), the expression of total cost in terms of conductor diameter is differentiated and equated to zero. No cognizance will be taken of the armor and other protecting coverings as these items do not affect the electrical characteristics of the cable, but they may be included in determining the economic cable, if desired, without altering the method of procedure.

The weight of a copper wire one mile long and having a cross-section of one circular mil is 0.016 pound. If  $c_1$  be the cost of copper in dollars per pound, then the cost of a stranded conductor  $l$  miles long and  $D$  mils in diameter is

$$0.016 sD^2 l c_1 \text{ dollars,} \quad (14)$$

where  $s$  is the stranding factor or the ratio of the copper cross-section in circular mils to the cross-section of the circle of diameter  $D$ ; thus, for a seven-strand conductor having strands of equal size,  $s = \frac{7}{9}$ .

If  $d$  be the diameter in mils over the insulation, the volume of insulation will be

$$\frac{12 \times 5280}{1,273,240} l (d^2 - D^2) = 0.0497 l (d^2 - D^2) \text{ cu. in.,}$$

where 1,273,240 is the number of circular mils in a square inch. Taking  $\delta$  as the density of the insulating material in pounds per cubic inch, and  $c_2$  as the cost in dollars per pound of this material, its cost will be

$$0.0497 l (d^2 - D^2) \delta c_2. \quad (15)$$

As the capacity of two concentric cylinders 1 mile long, the inner of diameter  $D$  and the outer of diameter  $d$ , separated by a medium of uniform specific inductivity  $k$ , is

$$C = \frac{0.0894 k}{\log_{\epsilon} \frac{d}{D}} \text{ microfarads}$$

(§ 7, Chap. IX), and as the resistance of the stranded conductor, having a resistivity of  $\rho$  ohms per circular-mil mile at sea temperature, is

$$R = \frac{\rho}{sD^2} \text{ ohms,}$$

it follows that the product is

$$CR = \frac{0.0894 \rho k}{sD^2 \log_{\epsilon} \frac{d}{D}}$$

whence  $d = D \epsilon^{\frac{K}{D^2}}$ , (16)

where  $K = \frac{0.0894 k \rho}{(CR)s}$ .

Substituting this value of  $d$  in equation (15) and combining with (14), the total cost of the cable exclusive of armor and other coverings is

$$\text{Cost} = 0.016 s D^2 l c_1 + 0.0497 l D^2 \delta c_2 \left( \epsilon^{\frac{2K}{D^2}} - 1 \right). \quad (17)$$

Differentiating and equating to zero, there results

$$0.032 s D l c_1 + 0.0497 l \delta c_2 \left( 2 D - \frac{4K}{D} \right) \epsilon^{\frac{2K}{D^2}} - 0.0994 l \delta D c_2 = 0$$

or  $\left( \frac{2K}{D^2} - 1 \right) \epsilon^{\frac{2K}{D^2}} = \frac{0.032 c_1 s}{0.0994 c_2 \delta} - 1 = F$  for convenience.

It is possible to determine  $D$  from this expression in terms of the known factors  $K$  and  $F$ , and this is best done graphically. Fig. 18 shows the relation of  $\frac{2K}{D^2}$  to  $F$ .

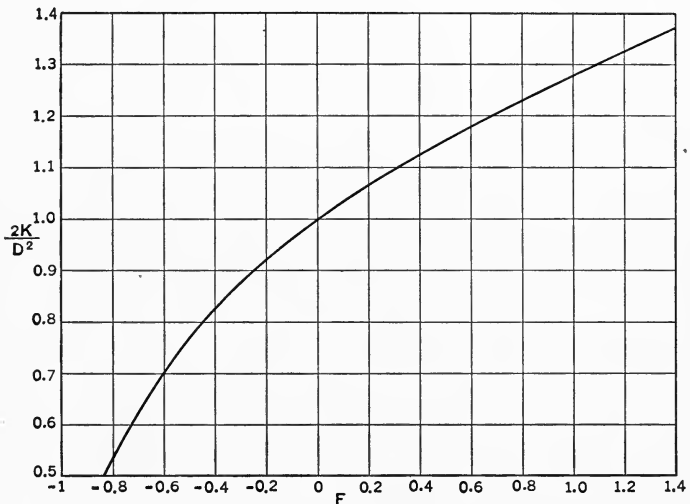

Fig. 18.

As a numerical illustration, let it be required to design the most economical 2500-mile seven-strand submarine cable for a value of  $CR = 0.6$  ohm-mf. per mile (that is  $CR^2 = 3.75$  seconds). Let

$$c_1 = 0.16$$

$$c_2 = 0.80$$

$$\delta = 0.037$$

$$k = 3.04$$

$$\rho = 51,000,$$

$$\text{then } F = \frac{0.032 \times 0.16 \times 0.778}{0.094 \times 0.80 \times 0.037} - 1 = 0.354,$$

and 
$$K = \frac{0.0894 \times 3.04 \times 51,000}{0.6 \times 0.778} = 29,700.$$

From Fig. 18, for  $F = 0.354$ ,  $\frac{2K}{D^2} = 1.115$  and, therefore, the diameter of the stranded conductor is

$$D = \sqrt{\frac{29,700 \times 2}{1.115}} = 231 \text{ mils,}$$

and the diameter over insulation is

$$d = 231 e^{\frac{29,700}{(231)^2}} = 403 \text{ mils.}$$

The total cost of the conductor and insulating material as determined from equation (17) is  $265,000 + 401,000 = 666,000$  dollars.

Had the conductor been a single wire (i.e.,  $s = 1$ ) the cost would be less for the same signalling speed. Its diameter would then have been 196 mils and its diameter over insulation 358 mils (no correction being made for increase in resistance due to stranding). The cost would be \$576,000. Solid conductors, however, are not frequently used because of the greater liability of fracture in laying the cable.

To make certain that the stranded cable has sufficient insulation resistance, the foregoing diameters are substituted in the following equation:

$$\text{Insulation resistance} = \frac{\sigma}{2\pi} \int_D^{\frac{d}{2}} \frac{dx}{x} = \frac{\sigma}{2\pi} \log_e \frac{d}{D} \quad (18)$$

megohms per mile, where  $\sigma$  is the resistance in megohms between opposite faces of a cube of the insulation one mile on a side when at sea temperature but at atmospheric

\* See Table of Exponential Functions in Appendix.

pressure. Taking  $\sigma = 28,000$  in the numerical illustration, the insulation resistance will be 2480 megohms per mile. Under the enormous pressures existing at great depths under water, the insulation resistance of the cable when laid is greater than when tested in the factory. Taking 0.05 per cent increase per fathom (1 fathom = 6 feet) the insulation resistance at a depth of 1500 fathoms will be 4340 megohms per mile, which is adequate. The design of cables for specified insulation resistance is of secondary importance to signalling speed, inasmuch as leakance relatively affects the shape or amplitude of the arrival current curve but little, so long as it remains constant.

The weight of conductor and insulation is

$$\frac{0.016 sD^2 + 0.0497 (d^2 - D^2)\delta}{2000} \text{ tons per mile,}$$

which weight is generally less than one-fifth of the total weight of the cable. The amount of protection on cables

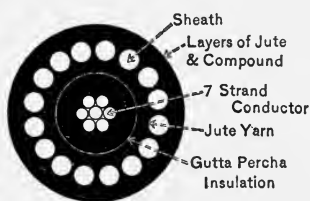

Fig. 19.

depends on the depth of submergence, and is light on deep-sea cable sections and heavy for the shore-end sections of cables. In order to facilitate the laying and recovering of cables they should be as light as is consistent with the stresses

to which they are subjected. Weights of galvanized iron or steel cable sheaths for various depths of cable submergence are indicated roughly by

$$\frac{300}{(\text{depth in fathoms})^{0.8}} \text{ tons per mile.}$$



The weight of jute, tape and preservative compound may be from 40 to 100 per cent of the weight of the metallic sheath. Fig. 19 shows to proper size the cross-section of the 2500-mile cable considered in this article, well protected for a depth of 1500 fathoms.

The electrical constants of a few long cables are given below:

Cable	Length in miles*	Total resistance in ohms	Total capacity in microfarads
Anglo-American Atlantic (Valentia to Heart's Content).....	2129	3388	776
Second German Atlantic (Borkum to Fayal).....	2207	5218	774
Pacific (Fanning Island to Fiji)....	2354	10936	746
Atlantic (Canso to Waterville)....	2493	4895	914
Commercial Pacific (San Francisco to Honolulu).....	2622	4975	875

\* Distances over sea are more frequently expressed in nautical miles (nauts); 1 naut = 1.152 miles.

The cost of laying a cable is generally estimated as half of the cost of the cable. The life of a submarine cable is variously estimated as from 30 to 40 years; in fact, portions of cables laid from 1851 to 1854 from England to neighboring countries are still in use.

The commercial status of submarine telegraphy is indicated by the fact that in 1911 there were over 2000 cables in the world aggregating 314,000 miles of cable and representing an estimated investment of 350 million dollars.

**10. Types of Cable Service and Tariffs.** — There are two types of cable service rendered at present by some of the large telegraph companies, namely: *full-rate service* for code and urgent messages requiring prompt transmission and delivery, and *deferred service* to many countries for

messages in plain language not requiring the greatest expedition and involving transmission within 24 hours. In addition the Western Union Telegraph Company renders *cable letter service* and *week-end letter service* across the Atlantic for less important communications in plain language which should not be subjected to the delay of over-sea mails. The following conditions and rates apply at present (July, 1914) to the various types of service.

*All Classes.* Addresses and signatures are counted and charged for, but no charge is made for name of originating city and date. In addresses, the names of delivery offices, countries, provinces, states, etc., are each counted as one word regardless of the number of letters employed. The cost of full addresses may be avoided by using code addresses, which are permitted by all governmental administrations upon payment of a fee. In plain language, words of 15 letters or less are counted as one word. Abbreviated words and illegitimate combinations of words are inadmissible. Every isolated character counts as one word, and words joined by a hyphen or separated by an apostrophe are counted as separate words. Punctuation marks are only transmitted upon the expressed desire of the sender, and then charged for as one word each.

*Full-rate service.* Full-rate messages may be in code or cipher language or in any plain language expressible in Roman letters. Code messages, formed of regular or artificial words not making intelligible phrases, must be pronounceable and must not contain more than 10 letters. Cipher messages, formed of either unpronounceable groups of letters or of groups of figures, are counted at the rate of 5 characters, or fraction thereof, to a word. The presence of a code word in an otherwise plain language message

subjects the entire message to the 10-letter code count, but plain language words in cipher messages are reckoned 15 letters to a word. If unpronounceable groups of letters appear in code or plain language messages, such groups are subject to the 5-letter cipher count. Fraction bars, periods, commas and decimal points grouped with figures count as figures. Replies to a message may be prepaid by writing before the name and address the letters RP followed by the figure showing the number of words prepaid (this indication is charged as one word). The following table shows the rates per word to points in some of the principal countries from New York City.

Present cable rates in cents (July, 1914)

*Argentine Republic.....	65	*Japan.....	133
*Australia.....	66	Montenegro †.....	34
*Austria-Hungary.....	32	*Norway.....	35
*Belgium.....	25	Panama.....	40
Bermuda.....	42	*Paraguay.....	65
*Brazil.....	70-249	*Peru (except Iquitos, Masisea, Or- ellana, Requena=115).....	65
Bulgaria †.....	35	Philippine Islands.....	112-136
*Cape Colony.....	86	Porto Rico.....	50
*Chili.....	65	*Portugal.....	39
‡China (except Macao=127).....	122	Roumania †.....	34
Cuba (except Havana=15).....	20	Russia (in Europe).....	43
*Denmark.....	35	*Servia †.....	34
*Egypt.....	50-58	Siam.....	105
*France.....	25	*Spain.....	38-40
*Germany.....	25	*Sweden.....	38
*Great Britain and Ireland.....	25	*Switzerland.....	30
*Greece.....	36	*Transvaal.....	86
*Holland.....	25	Turkey (in Europe) †.....	43
Honduras.....	55	*Uruguay.....	65
*India.....	74	Venezuela.....	100
*Italy.....	31		

\* Countries to which Deferred Service may be utilized at present.

† Secret language prohibited.

‡ Deferred service only to Pekin, Hankow, Tientsin, Amoy, Chefoo, Foochow, Shanghai, Tsingtau, Weihaiwei, Hong Kong, and Macao.

It is of historical interest to recall that in the early pioneer days of transatlantic telegraphy the minimum tariff was £20 (\$100) for 20 words and £1 for each additional word.

*Deferred service.* Deferred messages must be written in one language which may be that of the country of origin or of destination or may be in French, the letters LCO, LCD or LCF respectively being prefixed to the address as indicative of the type of service and the language used (one word is charged for this indication or prefix). The text of the message must be entirely in plain language, numbers, except in addresses, being also written in words. The rates for deferred service is one-half those shown in the foregoing table to the countries therein starred, except to Great Britain and Ireland where the rate is 9 cents per word. Replies may be prepaid as in full-rate service but the instruction as to the number of words prepaid must be expressed in terms of full rates.

*Cable and Week-end letter service.* Cable and week-end letters must be written in plain language of the country of origin or of destination, the indication CLP or CLT and WLP or WLT respectively being prefixed to the address as indicative of the type of service and the method of delivery beyond London or Liverpool, whether by post or telegraph. Cable letter tolls are based on an initial charge of 75 cents for 12 words (13 including indication) and week-end letters on an initial charge of \$1.15 for 24 words (25 including indication), plus 5 cents for each additional word in both cases. These charges cover cable transmission only and do not include terminal telegraphic charges. The letters may be mailed to the New York Western Union Cable Office, the week-end letters being sent in time for mail delivery at this office on Saturday evenings. The charges cover delivery in London or Liverpool and mail delivery to all other places abroad. With telegraphic delivery beyond these cities cable letters are deliverable during the day following their date

and week-end letters on Monday forenoon; and the following additional charge per word is made to points in: Great Britain and Ireland — 1 cent, Holland and Belgium — 2 cents, France— $7\frac{1}{2}$  cents, Italy— 6 cents, Germany—9 cents, and in other countries at the regular foreign rates. Figures when not used as cipher are counted each group of 5 or less as a word. Replies may be prepaid as in deferred service.

Cable letter service is likewise in operation with Cuba, the rate between New York and Havana being one dollar for 20 words (including prefix), plus 5 cents for each additional word. Double this rate applies to letters for other points in Cuba. Week-end letter service is in operation with Argentine Republic, Chili and Peru, and the tariff between New York and these countries is \$4.85 for 24 words (25 including prefix) plus 20 cents for each additional word, the letters being delivered on Tuesday mornings.

### PROBLEMS

1. Compute the values of the current received at one end of the 2129-mile Anglo-American Atlantic cable, having  $R = 1.591$  ohms per mile and  $C = 0.3645$  microfarad per mile, at instants respectively of 0.2, 0.4, 0.6, 0.8, 1.0, 1.4, 1.8, and 2.5 seconds after impressing 30 volts on the cable; also plot a curve showing these values co-ordinated to time.

2. From the curve of the preceding problem construct graphically the curve of arrival on this Atlantic cable of a dot element for a contact on 30 volts lasting 0.05 second.

3. Using the dot arrival curve of the foregoing problem as a basis, construct the shape of signals received over the cable for any three-letter word.

4. What may be the signalling speed in terms of 5-letter code words on a 1000-mile cable having a total resistance of 3000 ohms and a total capacity of 350 microfarads for the same legibility of received signals as represented by Fig. 4.

5. Plot the received signals for the letters *HE* (for  $\tau = 0.1$  second with 40 volts) sent through the 2500-mile cable considered in §§ 2 to 4 according to the Gott system. Curve I of Fig. 11 shows the magnitude and shape of the dot element. Show the type of signals retransmitted into another cable if the receiving relay is actuated by a current of 40 microamperes.

6. Determine the economic dimensions of the conductor and insulation of the cable considered in § 9 if the cost of insulation be taken as 55 cents per pound, other constants remaining unaltered.

7. Calculate the weights per mile and the total cost of 7-strand conductor and insulation for a 1000-mile cable having a value of  $CR = 1.05 \times 10^{-6}$  seconds. The cost of copper is 17 cents and the cost of insulation is 1 dollar per pound. Take  $k = 3.1$ .

8. What would be the possible maximum annual net income of a duplexed cable when continuously used for automatic transmission of code messages averaging 8.5 letters to the word and 9 words to the message, if the dot element  $\tau$  is 0.05 second and the space between messages is  $12\tau$  (the symbol "understand"—3 dots, dash, dot, is frequently used between messages); the apportioned revenue over this cable section being 8 cents per word? Two operators prepare tapes and feed the transmitter and two decipher the received messages; they work in 8 hour shifts and receive an average weekly salary of 26 dollars. Allow 3 per cent depreciation on the cost of the cable installed and terminal apparatus, which was \$1,000,000.

9. How much would it cost to send the following cable letter:

CLT-RP 10 Instrument Cambridge

Give price and delivery spectrophotometer and radio-micrometer with scale  
Richardbrown Brooklyn.

10. Decipher the message reproduced below which was received over a 1600-mile cable.

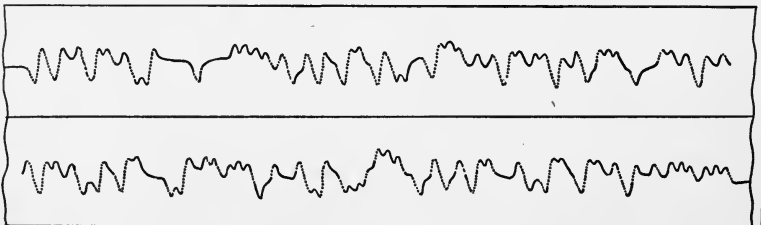

## APPENDIX

TABLES OF TRIGONOMETRIC FUNCTIONS,  
EXPONENTIAL FUNCTIONS, LOGARITHMS AND  
HYPERBOLIC FUNCTIONS

TABLE I.—TRIGONOMETRIC (CIRCULAR) FUNCTIONS

u		sin u	cos u	u		sin u	cos u
Degrees	Radians			Degrees	Radians		
0	0	0	1.0000	13.5	.....	0.2334	0.9724
0.5	.....	0.0087	1.0000	.....	0.24	2377	9713
.....	0.01	0100	0.9999	14.0	.....	2419	9703
1.0	.....	0175	9998	.....	25	2474	9689
.....	02	0200	9998	14.5	.....	2504	9681
1.5	.....	0262	9997	.....	26	2571	9664
.....	03	0300	9996	15.0	.....	2588	9659
2.0	.....	0349	9994	.....	27	2667	9638
.....	04	0400	9992	15.5	.....	2672	9636
2.5	.....	0436	9990	16.0	.....	2756	9613
.....	05	0500	9988	.....	28	2764	9611
3.0	.....	0523	9986	16.5	.....	2840	9588
.....	06	0600	9982	.....	29	2860	9582
3.5	.....	0610	9981	17.0	.....	2924	9563
4.0	.....	0698	9976	.....	30	2955	9553
.....	07	0699	9976	17.5	.....	3007	9537
4.5	.....	0785	9969	.....	31	3051	9523
.....	08	0799	9968	18.0	.....	3090	9511
5.0	.....	0872	9962	.....	32	3146	9492
.....	09	0899	9960	18.5	.....	3173	9483
5.5	.....	0958	9954	.....	33	3240	9460
.....	10	0998	9950	19.0	.....	3256	9455
6.0	.....	1045	9945	.....	34	3335	9428
.....	11	1098	9940	19.5	.....	3338	9426
6.5	.....	1132	9936	20.0	.....	3420	9397
.....	12	1197	9928	.....	35	3429	9394
7.0	.....	1219	9925	20.5	.....	3502	9367
.....	13	1296	9916	.....	36	3523	9359
7.5	.....	1305	9914	21.0	.....	3584	9336
8.0	.....	1392	9903	.....	37	3616	9323
.....	14	1395	9902	21.5	.....	3665	9304
8.5	.....	1478	9890	.....	38	3709	9287
.....	15	1494	9888	22.0	.....	3746	9272
9.0	.....	1564	9877	.....	39	3802	9249
.....	16	1593	9872	22.5	.....	3827	9239
9.5	.....	1650	9863	.....	40	3894	9211
.....	17	1692	9856	23.0	.....	3907	9205
10.0	.....	1736	9848	.....	41	3986	9171
.....	18	1790	9838	23.5	.....	3987	9171
10.5	.....	1822	9833	24.0	.....	4067	9135
.....	19	1889	9820	.....	42	4078	9131
11.0	.....	1908	9816	24.5	.....	4147	9100
.....	20	1987	9801	.....	43	4169	9090
11.5	.....	1994	9799	25.0	.....	4226	9063
12.0	.....	2079	9781	.....	44	4259	9048
.....	21	2085	9780	25.5	.....	4305	9026
12.5	.....	2164	9763	.....	45	4350	9005
.....	22	2182	9759	26.0	.....	4384	8988
13.0	.....	2250	9744	.....	46	4440	8961
.....?	23	2280	9737	26.5	.....	4462	8949



TABLE I.—TRIGONOMETRIC (CIRCULAR) FUNCTIONS—(Continued)

$u$		sin $u$	cos $u$	$u$		sin $u$	cos $u$
Degrees	Radians			Degrees	Radians		
.....	0.47	0.4529	0.8916	37.5	.....	0.6088	0.7934
27.0	.....	4540	8910	.....	0.66	6131	7900
27.5	.....	4617	8870	38.0	.....	6157	7880
.....	48	4618	8870	.....	67	6210	7838
28.0	.....	4695	8829	38.5	.....	6225	7826
.....	49	4706	8823	.....	68	6288	7776
28.5	.....	4772	8788	39.0	.....	6293	7771
.....	50	4794	8776	39.5	.....	6361	7716
29.0	.....	4848	8746	.....	69	6365	7713
.....	51	4882	8727	40.0	.....	6428	7660
29.5	.....	4924	8704	.....	70	6442	7648
.....	52	4969	8678	40.5	.....	6494	7604
30.0	.....	5000	8660	.....	71	6518	7584
.....	53	5055	8628	41.0	.....	6561	7547
30.5	.....	5075	8616	.....	72	6594	7518
.....	54	5141	8577	41.5	.....	6626	7490
31.0	.....	5150	8572	.....	73	6669	7452
31.5	.....	5225	8526	42.0	.....	6691	7431
.....	55	5227	8525	.....	74	6743	7385
32.0	.....	5299	8480	42.5	.....	6756	7373
.....	56	5312	8473	.....	75	6816	7317
32.5	.....	5373	8434	43.0	.....	6820	7314
.....	57	5396	8419	43.5	.....	6884	7254
33.0	.....	5446	8387	.....	76	6889	7248
.....	58	5480	8365	44.0	.....	6947	7193
33.5	.....	5519	8339	.....	77	6961	7179
.....	59	5564	8309	44.5	.....	7009	7133
34.0	.....	5592	8290	.....	78	7033	7109
.....	60	5646	8253	45.0	.....	7071	7071
34.5	.....	5664	8241	.....	79	7104	7039
.....	61	5729	8197	.....	80	7174	6967
35.0	.....	5736	8192	.....	85	7513	6600
35.5	.....	5807	8141	.....	90	7833	6216
.....	62	5810	8139	.....	1.00	8415	5403
36.0	.....	5878	8090	.....	1.10	8912	4536
.....	63	5891	8080	.....	1.20	9320	3624
36.5	.....	5948	8039	.....	1.30	9636	2675
.....	64	5972	8021	.....	1.40	9855	1700
37.0	.....	6018	7986	.....	1.50	9975	0707
.....	65	6052	7961	.....	1.60	9996	-.0292

The functions of larger angles are:

Function	When angle $u$ lies between			
	45° and 90°	90° and 180°	180° and 270°	270° and 360°
sin $u$ =	cos (90° - $u$ )	sin (180° - $u$ )	- cos (270° - $u$ )	- sin (360° - $u$ )
cos $u$ =	sin (90° - $u$ )	- cos (180° - $u$ )	- sin (270° - $u$ )	cos (360° - $u$ )

TABLE II. — EXPONENTIAL FUNCTIONS

$x$	$e^x$	$e^{-x}$	$x$	$e^x$	$e^{-x}$	$x$	$e^x$	$e^{-x}$
0	1.0000	1.0000	0.50	1.6487	0.6065	1.00	2.7183	0.3679
0.01	0101	0.9901	51	6653	6005	02	7732	3606
02	0202	9802	52	6820	5945	04	8202	3535
03	0305	9704	53	6989	5886	06	8864	3465
04	0408	9608	54	7160	5827	08	9447	3396
05	0513	9512	55	7333	5769	10	3.0042	3329
06	0618	9418	56	7507	5712	12	0649	3263
07	0725	9324	57	7683	5655	14	1268	3198
08	0833	9231	58	7860	5599	16	1899	3135
09	0942	9139	59	8040	5543	18	2544	3073
10	1052	9048	60	8221	5488	20	3201	3012
11	1163	8958	61	8404	5434	22	3872	2952
12	1275	8869	62	8589	5379	24	4556	2894
13	1388	8781	63	8776	5326	26	5254	2837
14	1503	8694	64	8965	5273	28	5966	2780
15	1618	8607	65	9155	5220	30	6693	2725
16	1735	8521	66	9348	5169	32	7434	2671
17	1853	8437	67	9542	5117	34	8190	2618
18	1972	8353	68	9739	5066	36	8962	2567
19	2093	8270	69	9937	5016	38	9749	2516
20	2214	8187	70	2.0137	4966	40	4.0552	2466
21	2337	8106	71	0340	4916	42	1371	2417
22	2461	8025	72	0544	4868	44	2207	2369
23	2586	7945	73	0751	4819	46	3060	2322
24	2712	7866	74	0959	4771	48	3929	2276
25	2840	7788	75	1170	4724	50	4817	2231
26	2969	7711	76	1383	4677	52	5722	2187
27	3100	7634	77	1598	4630	54	6646	2144
28	3231	7558	78	1815	4584	56	7588	2101
29	3364	7483	79	2034	4538	58	8550	2060
30	3499	7408	80	2255	4493	60	9530	2019
31	3634	7334	81	2479	4449	62	5.0531	1979
32	3771	7261	82	2705	4404	64	1552	1940
33	3910	7189	83	2933	4360	66	2593	1901
34	4049	7118	84	3164	4317	68	3656	1864
35	4191	7047	85	3396	4274	70	4739	1827
36	4333	6977	86	3632	4232	72	5845	1791
37	4477	6907	87	3869	4190	74	6973	1755
38	4623	6839	88	4109	4148	76	8124	1720
39	4770	6771	89	4351	4107	78	9299	1686
40	4918	6703	90	4596	4066	80	6.0496	1653
41	5068	6637	91	4843	4025	82	1719	1620
42	5220	6570	92	5093	3985	84	2965	1588
43	5373	6505	93	5345	3946	86	4237	1557
44	5527	6440	94	5600	3906	88	5535	1526
45	5683	6376	95	5857	3867	90	6859	1496
46	5841	6313	96	6117	3829	92	8210	1466
47	6000	6250	97	6379	3791	94	9588	1437
48	6161	6188	98	6645	3753	96	7.0993	1409
49	6323	6126	99	6912	3716	98	2427	1381

TABLE II. — EXPONENTIAL FUNCTIONS — (Continued)

$u$	$e^u$	$e^{-u}$	$u$	$e^u$	$e^{-u}$
2.00	7.3891	0.13534	4.50	90.017	0.011109
05	7679	12873	55	94.632	010567
10	8.1662	12246	60	99.484	010052
15	5849	11648	65	104.585	009562
20	9.0250	11080	70	109.947	009095
25	4877	10540	75	115.584	008652
30	9742	10026	80	121.510	008230
35	10.4856	09537	85	127.740	007828
40	11.0232	09072	90	134.290	007447
45	11.5883	08629	95	141.175	007083
50	12.1825	08209	5.00	148.413	006738
55	12.8071	07808	05	156.022	006409
60	13.4637	07427	10	164.022	006097
65	14.1540	07065	15	172.431	005799
70	14.8797	06721	20	181.272	005517
75	15.6426	06393	25	190.566	005248
80	16.4446	06081	30	200.337	004992
85	17.2878	05784	35	210.608	004748
90	18.1741	05502	40	221.406	004517
95	19.1060	05234	45	232.758	004296
3.00	20.086	04979	50	244.692	004087
05	21.115	04736	55	257.238	003888
10	22.198	04505	60	270.426	003698
15	23.336	04285	65	284.291	003518
20	24.533	04076	70	298.867	003346
25	25.790	03877	75	314.191	003183
30	27.113	03688	80	330.300	003028
35	28.503	03508	85	347.234	002880
40	29.964	03337	90	365.037	002739
45	31.500	03175	95	383.753	002606
50	33.115	03020	6.00	403.43	0024788
55	34.813	02872	7.00	1,096.6	0009119
60	36.598	02732	8.00	2,981.0	00033546
65	38.475	02599	9.00	8,103.1	00012341
70	40.447	02472	10.00	22,026	000045400
75	42.521	02352	11.00	59,874	000016702
80	44.701	02237	12.00	162,754	000006144
85	46.993	02128	13.00	442,413	0000022603
90	49.402	02024	14.00	1,202,600	00000083153
95	51.935	01925	15.00	3,269,000	00000030590
4.00	54.598	01832	16.00	8,886,100	00000011253
05	57.397	01742	17.00	24,155,000	000000041399
10	60.340	01657	18.00	65,660,000	000000015230
15	63.434	01576	19.00	178,482,000	0000000056028
20	66.686	01500	20.00	485,165,000	0000000020612
25	70.105	01426	21.00	1,318,800,000	00000000075826
30	73.700	01357	22.00	3,584,900,000	00000000027895
35	77.478	01291	23.00	9,744,800,000	00000000010262
40	81.451	01228	24.00	26,489,100,000	00000000003775
45	85.627	01168	25.00	72,004,800,000	00000000001389

TABLE III. — LOGARITHMS TO BASE 10

No.	0	1	2	3	4	5	6	7	8	9
10	00000	00432	00860	01284	01703	02119	02530	02938	03342	03743
11	04139	04532	04922	05307	05690	06070	06446	06819	07188	07555
12	07918	08279	08637	08990	09342	09691	10037	10380	10721	11059
13	11394	11727	12057	12385	12710	13033	13354	13672	13988	14301
14	14613	14922	15229	15533	15836	16137	16435	16732	17026	17319
15	17609	17898	18184	18469	18752	19033	19312	19590	19866	20140
16	20412	20683	20952	21219	21484	21748	22011	22272	22531	22789
17	23045	23300	23553	23805	24055	24304	24551	24797	25042	25285
18	25527	25768	26007	26245	26482	26717	26951	27184	27416	27646
19	27875	28103	28330	28556	28780	29003	29226	29447	29667	29885
20	30103	30320	30535	30749	30963	31175	31386	31597	31806	32015
21	32222	32428	32633	32838	33041	33244	33445	33646	33846	34044
22	34242	34439	34635	34830	35025	35218	35411	35603	35793	35984
23	36173	36361	36549	36736	36922	37107	37291	37475	37658	37840
24	38021	38202	38382	38561	38739	38916	39094	39270	39445	39619
25	39794	39967	40140	40312	40483	40654	40824	40993	41162	41330
26	41497	41664	41830	41996	42160	42325	42488	42651	42813	42975
27	43136	43297	43457	43616	43775	43933	44091	44248	44404	44560
28	44716	44871	45025	45179	45332	45484	45637	45788	45939	46090
29	46240	46389	46538	46687	46835	46982	47129	47276	47422	47567
30	47712	47857	48001	48144	48287	48430	48572	48714	48855	48996
31	49136	49276	49415	49554	49693	49831	49969	50106	50243	50379
32	50515	50651	50786	50920	51055	51189	51322	51455	51587	51720
33	51851	51983	52114	52244	52375	52504	52634	52763	52892	53020
34	53148	53275	53403	53529	53656	53782	53908	54033	54158	54283
35	54407	54531	54654	54777	54900	55022	55145	55267	55388	55509
36	55630	55751	55871	55991	56110	56229	56348	56467	56585	56703
37	56820	56937	57054	57171	57287	57403	57519	57634	57749	57863
38	57978	58093	58206	58320	58433	58546	58659	58771	58883	58995
39	59106	59218	59328	59439	59550	59660	59770	59879	59989	60097
40	60206	60314	60423	60531	60638	60745	60853	60959	61066	61172
41	61278	61384	61490	61595	61700	61805	61909	62014	62118	62221
42	62325	62428	62531	62634	62737	62839	62941	63043	63144	63246
43	63347	63448	63548	63649	63749	63849	63949	64048	64147	64246
44	64345	64444	64542	64640	64738	64836	64933	65031	65128	65225
45	65321	65418	65514	65609	65706	65801	65896	65992	66087	66181
46	66276	66370	66464	66558	66652	66745	66839	66932	67025	67117
47	67210	67302	67394	67486	67578	67669	67761	67852	67943	68034
48	68124	68215	68305	68395	68485	68574	68664	68753	68842	68931
49	69020	69108	69197	69285	69373	69461	69548	69636	69723	69810
50	69897	69984	70070	70157	70243	70329	70415	70501	70586	70672
51	70757	70842	70927	71012	71096	71181	71265	71349	71433	71517
52	71600	71684	71767	71850	71933	72016	72099	72181	72263	72346
53	72428	72509	72591	72673	72754	72835	72916	72997	73078	73159
54	73239	73320	73399	73478	73556	73635	73713	73791	73878	73957
55	74036	74115	74194	74273	74351	74429	74507	74586	74663	74741
56	74819	74896	74974	75051	75128	75205	75282	75358	75435	75511
57	75587	75664	75740	75815	75891	75967	76042	76118	76193	76268
58	76343	76418	76492	76567	76641	76716	76790	76864	76938	77012
59	77085	77159	77232	77305	77379	77452	77525	77597	77670	77743
60	77815	77887	77960	78032	78104	78176	78247	78319	78390	78462

TABLE III.—LOGARITHMS TO BASE 10. — (Continued)

No.	0	1	2	3	4	5	6	7	8	9
61	78533	78604	78675	78746	78817	78888	78958	79029	79099	79169
62	79239	79309	79379	79449	79518	79588	79657	79727	79796	79865
63	79934	80003	80072	80140	80209	80277	80346	80414	80482	80550
64	80618	80686	80754	80821	80889	80956	81023	81090	81158	81224
65	81291	81358	81425	81491	81558	81624	81690	81757	81823	81889
66	81954	82020	82086	82151	82217	82282	82347	82413	82478	82543
67	82607	82672	82737	82802	82866	82930	82995	83059	83123	83187
68	83251	83315	83378	83442	83506	83569	83632	83696	83759	83822
69	83885	83948	84011	84073	84136	84198	84261	84323	84386	84448
70	84510	84572	84634	84696	84757	84819	84880	84942	85003	85065
71	85126	85187	85248	85309	85370	85431	85491	85552	85612	85673
72	85733	85794	85854	85914	85974	86034	86094	86153	86213	86273
73	86332	86392	86451	86510	86570	86629	86688	86747	86806	86864
74	86923	86982	87040	87099	87157	87216	87274	87332	87390	87448
75	87506	87564	87622	87680	87737	87795	87852	87910	87967	88024
76	88081	88138	88196	88252	88309	88366	88423	88480	88536	88593
77	88649	88705	88762	88818	88874	88930	88986	89042	89098	89154
78	89209	89265	89321	89376	89432	89487	89542	89597	89653	89708
79	89763	89818	89873	89927	89982	90037	90091	90146	90200	90255
80	90309	90363	90417	90472	90526	90580	90634	90687	90741	90795
81	90848	90902	90956	91009	91062	91116	91169	91222	91275	91328
82	91381	91434	91487	91540	91593	91645	91698	91751	91803	91855
83	91908	91960	92012	92065	92117	92169	92221	92273	92324	92376
84	92428	92480	92531	92583	92634	92686	92737	92789	92840	92891
85	92942	92993	93044	93095	93146	93197	93247	93298	93349	93399
86	93450	93500	93551	93601	93651	93702	93752	93802	93852	93902
87	93952	94002	94052	94101	94151	94201	94250	94300	94349	94398
88	94448	94498	94547	94596	94645	94694	94743	94791	94841	94890
89	94939	94988	95036	95085	95134	95182	95231	95279	95328	95376
90	95424	95472	95521	95569	95617	95665	95713	95761	95809	95856
91	95904	95952	95999	96047	96095	96142	96190	96237	96284	96332
92	96379	96426	96473	96520	96567	96614	96661	96708	96755	96802
93	96848	96895	96942	96988	97035	97081	97128	97174	97220	97267
94	97313	97359	97405	97451	97497	97543	97589	97635	97681	97727
95	97772	97818	97864	97909	97955	98000	98046	98091	98137	98182
96	98227	98272	98318	98363	98408	98453	98498	98543	98588	98632
97	98677	98722	98767	98811	98856	98900	98945	98989	99034	99078
98	99123	99167	99211	99255	99300	99344	99388	99432	99476	99520
99	99564	99607	99651	99695	99739	99782	99826	99870	99913	99957

Characteristics of Logarithms:

$$\log 4030 = 3.6053$$

$$\log 403 = 2.6053$$

$$\log 40.3 = 1.6053$$

$$\log_e x = 2.3026 \log_{10} x$$

$$\log 4.03 = 0.6053$$

$$\log 0.403 = \bar{1}.6053$$

$$\log 0.0403 = \bar{2}.6053$$

$$\log 0.00403 = \bar{3}.6053$$

Useful Constants:

$$e = 2.7182818$$

$$\pi = 3.1415927$$

$$1 \text{ radian} = 57.29578 \text{ degrees.}$$

$$1 \text{ degree} = 0.0174533 \text{ radian.}$$

TABLE IV.—HYPERBOLIC FUNCTIONS

<i>u.</i>	<i>sinh u.</i>	<i>cosh u.</i>	<i>u.</i>	<i>sinh u.</i>	<i>cosh u.</i>	<i>u.</i>	<i>sinh u.</i>	<i>cosh u.</i>
0.00	0.0000	1.0000	0.50	0.5211	1.1276	1.00	1.1752	1.5431
01	0100	0001	51	5324	1329	05	2539	6038
02	0200	0002	52	5438	1383	10	3356	6685
03	0300	0005	53	5552	1438	15	4208	7374
04	0400	0008	54	5666	1494	20	5095	8107
05	0500	0013	55	5782	1551	25	6010	8884
06	0600	0018	56	5897	1609	30	6984	1.9709
07	0701	0025	57	6014	1669	35	7991	2.0583
08	0801	0032	58	6131	1730	40	1.9043	1509
09	0901	0041	59	6248	1792	45	2.0143	2488
10	1002	0050	60	6367	1855	50	1293	3524
11	1102	0061	61	6485	1919	55	2496	4619
12	1203	0072	62	6605	1984	60	3756	5775
13	1304	0085	63	6725	2051	65	5075	6995
14	1405	0098	64	6846	2119	70	6456	8283
15	1506	0113	65	6967	2188	75	7904	2.9642
16	1607	0128	66	7090	2258	80	2.9422	3.1075
17	1708	0145	67	7213	2330	85	3.1013	2585
18	1810	0162	68	7336	2402	90	2682	4177
19	1911	0181	69	7461	2476	95	4432	5855
20	2013	0201	70	7586	2552	2.00	6269	7622
21	2115	0221	71	7712	2628	05	3.8196	3.9483
22	2218	0243	72	7838	2706	10	4.0219	4.1443
23	2320	0266	73	7966	2785	15	2342	3507
24	2423	0289	74	8094	2865	20	4571	5679
25	2526	0314	75	8223	2947	25	6912	4.7966
26	2629	0340	76	8353	3030	30	4.9370	5.0372
27	2733	0367	77	8484	3114	35	5.1951	2905
28	2837	0395	78	8615	3199	40	4662	5569
29	2941	0423	79	8748	3286	45	5.7510	5.8373
30	3045	0453	80	8881	3374	50	6.0502	6.1323
31	3150	0484	81	9015	3464	55	3645	4426
32	3255	0516	82	9150	3555	60	6.6947	6.7690
33	3360	0549	83	9286	3647	65	7.0417	7.1123
34	3466	0584	84	9423	3740	70	4063	4735
35	3572	0619	85	9561	3835	75	7.7894	7.8533
36	3678	0655	86	9700	3932	80	8.1919	8.2527
37	3785	0692	87	9840	4029	85	8.6150	8.6728
38	3892	0731	88	0.9981	4128	90	9.0596	9.1146
39	4000	0770	89	1.0122	4229	95	9.5268	9.5791
40	4108	0811	90	0265	4331	3.00	10.0179	10.0677
41	4216	0852	91	0409	4434	05	10.5340	10.5814
42	4325	0895	92	0554	4539	10	11.0765	11.1215
43	4434	0939	93	0700	4645	15	11.6466	11.6895
44	4543	0984	94	0847	4753	20	12.2459	12.2866
45	4653	1030	95	0995	4862	25	12.8758	12.9146
46	4764	1077	96	1144	4973	30	13.5379	13.5748
47	4875	1125	97	1294	5085	35	14.2338	14.2689
48	4986	1174	98	1446	5199	40	14.9654	14.9987
49	5098	1225	99	1598	5314	45	15.7343	15.7661

TABLE IV.—HYPERBOLIC FUNCTIONS.—(Continued)

$u$ .	$\sinh u$ .	$\cosh u$ .	$u$ .	$\sinh u$ .	$\cosh u$ .
3.50	16.5426	16.5728	6.00	201.7132	201.7156
55	17.3923	17.4210	05	212.0553	212.0577
60	18.2855	18.3128	10	222.9278	222.9300
65	19.2243	19.2503	15	234.3576	234.3598
70	20.2113	20.2360	20	246.3735	246.3755
75	21.2488	21.2723	25	259.0054	259.0074
80	22.3394	22.3618	30	272.2850	272.2869
85	23.4859	23.5072	35	286.2455	286.2472
90	24.6911	24.7113	40	300.9217	300.9233
3.95	25.9581	25.9773	45	316.3504	316.3520
4.00	27.2899	27.3082	50	332.5700	332.5716
05	28.6900	28.7074	55	349.6213	349.6228
10	30.1619	30.1784	60	367.5469	367.5483
15	31.7091	31.7249	65	386.3915	386.3928
20	33.3357	33.3507	70	406.2023	406.2035
25	35.0456	35.0598	75	427.0287	427.0300
30	36.8431	36.8567	80	448.9231	448.9242
35	38.7328	38.7457	85	471.9399	471.9410
40	40.7193	40.7316	90	496.1369	496.1379
45	42.8076	42.8193	6.95	521.5744	521.5754
50	45.0030	45.0141	7.00	548.3161	548.3170
55	47.3109	47.3215	05	576.4289	576.4298
60	49.7371	49.7472	10	605.9831	605.9839
65	52.2877	52.2973	15	637.0526	637.0534
70	54.9690	54.9781	20	669.7150	669.7157
75	57.7878	57.7965	25	704.0521	704.0528
80	60.7511	60.7593	30	740.1497	740.1504
85	63.8663	63.8741	35	778.0980	778.0986
90	67.1412	67.1486	40	817.9919	817.9925
4.95	70.5839	70.5910	45	859.9313	859.9318
5.00	74.2032	74.2099	50	904.0210	904.0215
05	78.0080	78.0144	55	950.3711	950.3716
10	82.0079	82.0140	60	999.0976	999.0981
15	86.2128	86.2186	65	1050.323	
20	90.6334	90.6389	70	1104.174	
25	95.2805	95.2858	75	1160.786	
30	100.1659	100.1709	80	1220.301	
35	105.3018	105.3065	85	1282.867	
40	110.7009	110.7055	90	1348.641	
45	116.3769	116.3812	7.95	1417.787	
50	122.3439	122.3480	8.00	1490.479	
55	128.6168	128.6207	05	1566.698	
60	135.2114	135.2150	10	1647.234	
65	142.1440	142.1475	15	1731.690	
70	149.4320	149.4354	20	1820.475	
75	157.0938	157.0969	25	1913.813	
80	165.1482	165.1513	30	2011.936	
85	173.6158	173.6186	35	2115.090	
90	182.5173	182.5201	40	2223.533	
95	191.8754	191.8780	45	2337.537	





## INDEX

---

- Abbreviations on ticker tapes, 121.  
used in telegraph transmission, 28.
- Added resistance of *Field* quad., 93.
- Admittance, dielectric, 316.
- Advantage of double-current duplex,  
74.  
using two generators on simplex  
lines, 342.
- Aerial cables, 269.  
installation of, 272.  
lines, 253.
- Alarm indicators, 210.
- Alarms of fire, transmission of, 189.  
public, 200.
- Alphabets, telegraph, 26, 121, 164,  
356.
- Alternating-current track relays,  
246.  
transmission theory, 304.  
illustration of, 330.
- Armor on cables, 380.
- Arresters, lightning, 135, 260.
- Arrival curves on cables, 353.
- Artificial cables, 372.  
lines, 47, 51.  
calculation of, 47, 62, 67, 71.
- Atkinson, Richard L.*, repeater, 40.
- Attenuation coefficient, 311.
- Automatic block signals, 225.  
fire-alarm repeaters, 206.  
repeaters, 37.  
retransmission over cables, 368.  
telegraphy, 108.  
transmitter, 110, 122.
- Auto-transformers in eliminating  
line induction, 292.
- Ayrton, Prof. William E.*, receiver  
resistance, 338.
- Balanced circuit, conditions of, 52.
- Balancing polar duplex, 59.  
quadruplex, 93.
- Barclay, John C.*, printing telegraph,  
121.
- Batteries, location on lines, 6.  
primary, 20.  
secondary, 21.
- Baudot, Jean M. E.*, printer, 133, 163.
- Bell-striking machines, 202.
- Block signals, automatic, 237.  
for electric roads, 231.  
for steam roads, 239.  
location of automatic, 232.  
manual systems, 231.  
one-rail system, 243.  
TDB system, 235.  
two-rail system, 244.  
types of, 224.
- Bonding of cable sheaths, 279.
- Bonds, impedance track, 244.
- Boxes, cable pole, 277.  
fire-alarm, 192.  
police signal, 218.
- Bridge duplex, 67.  
current in relay of, 345.  
direct-point repeater, 79.  
*Wheatstone*, 67, 373.
- Brooklyn fire-alarm system, 212.

- Brown, Sidney G.*, drum relay, 368.  
*Buckingham, Charles L.*, printer, 133.  
 Bunnell keys, 8.  
*Burry, John*, printing telegraph, 133.
- Cable keys, 363.  
 letters, 382.  
 service, 381.  
 splices, 276.  
 tariffs, 381.  
 telegraphy, theory of, 347.
- Cables, artificial, 372.  
 attenuation constant of, 312.  
 capacity of, 287.  
 constants of some, 381.  
 design of submarine, 375.  
 installation of, 272.  
 telegraph, 269.
- Capacity of cables, 287.  
 line wires, 284.
- Callin, Fred*, repeater, 42.
- Cells, voltaic, 20.
- Central stations, fire-alarm, 202.
- Chapman, Winthrop M.*, block signals, 239.
- Characteristic impedance of line, 319.
- Cipher messages, 151.
- Circuits on Northern Pacific, 158.
- Clapp, Martin H.*, statistics, 158.
- Closed-circuit *Morse* system, 2, 5.
- Code, *Barclay* printing, 121.  
 cable, 356.  
 Continental, 25.  
*Morse*, 25.  
*Murray* multiplex, 164.  
*Phillips* punctuation, 25.  
 words, 150.
- Cole, Frederick W.*, repeater, 206.
- Combination fire-alarm circuits, 212.
- Common-battery telephone, 293.
- Composite signalling, 296.  
 railway, 298.
- Condensers in series with cables, 365.  
 with artificial lines, 52.
- Conductance, leakage, 287.
- Conductors, constants of, 262, 282.
- Conduit, underground, 274.
- Continental telegraph code, 25, 356.
- Continuity-preserving pole-changers, 58.  
 transmitters, 50.
- Copper-clad wire, 29.  
 inductance of, 284.  
 line wire, 29, 262.
- Corrosion of cable sheaths, 277.
- Cosines, table of, 388, 394.
- Crane, Moses G.*, fire-alarm box, 194.
- Creed, Frederick G.*, printer, 133.
- Crehore, Dr. Albert C.*, cable signalling, 374.  
 duplex-duplex, 102.
- CR Law, 364.
- Cross-arms, pole, 259.
- Current distribution equations, 308.  
 general, 329.  
 in duplex circuits, 50, 62, 69, 75.  
 in leaky lines, 334.  
 propagation over lines, 303.  
 ratio in quadruplex, 93.  
 received over cable, 352.  
 sources, 20.  
 variation in quadruplex, 92.
- D'Arsonval, Dr. Arsene*, galvanometer, 360.
- Davis, Minor M.*, duplex, 63.  
 quadruplex, 96.
- Day letters, 152.
- Dean, Robert L.*, printer, 133.
- Deferred cable service, 381.  
 overland service, 152.

- Delany, Patrick B.*, multiplex telegraph, 162.
- Desk, police central-office, 221.
- D'Humy, Fernand E.*, repeater, 42.  
reperforator, 114.
- Diehl, Clark E.*, relay scheme, 95, 97.
- Dielectric admittance, 316.  
permittivity, 286.
- Differential duplex, 46.  
neutral relay, 46.  
polarized relay, 55.
- Diplex signalling, 86.
- Direct-current transmission theory, 305, 334.  
illustration of, 338.  
point repeaters, 76.
- Disk railway signals, 227.
- Distance of transmission over leaky lines, 32.  
over perfectly-insulated lines, 4.
- Distributing frames, 143.
- Distributors, synchronous, 164.
- Disturbances, inductive, 288.  
elimination of, 290.
- Dot-frequency, 304, 356.
- Double-block condenser scheme, 373.  
current duplex, 74.
- Dry-core cables, 269.
- Duplex automatic telegraphy, 113.  
balancing, 59.  
*Barclay*, printing telegraph, 126.  
bridge, 67.  
cable telegraphy, 372.  
*Davis and Eaves*, 63.  
differential, 45.  
diplex signalling, 102.  
double-current, 74.  
leak, 62.  
*Morris*, 66.  
polar, 56.  
improved, 63.
- Duplex, Postal Telegraph Co., 63.  
repeaters, 76.  
short-line, 66.  
signalling, theory of, 344.  
single-current, 46.  
*Stearns*, 46.  
switchboard circuits, 142.  
telegraphy, 45.  
Western Union Co., 71.
- Dwarf railway signals, 226.
- Earth as return path, 1, 279.  
resistance, 280.
- Eaves, Augustus J.*, duplex, 63.  
quadruplex, 96.
- Economic cable determination, 376.  
span lengths, 266.
- Edison, Thomas A.*, battery, 20, 22.  
quadruplex, 85.
- Electric railways, signals for, 231, 237, 242.  
telegraphy, *see* Telegraphy.
- Electrolysis of cable sheaths, 277.
- Electromagnetic induction, 288.
- Electrostatic induction, 288.
- Equivalent sine curves, 304.
- Essick, Samuel V.*, printer, 133.
- Exponential functions, 390.
- Faraday, Prof. Michael*, law of, 278.  
polarizing effect, 183.
- Fibre stress in poles, 256.
- Field, Stephen D.*, key system, 91.
- Fire-alarm boxes, 192.  
central stations, 202.  
devices at apparatus houses, 210.  
repeaters, 206.  
systems, operation of, 212.  
statistics of, 221.  
telegraphy, 189.  
transmitters, 203.

- Fourier, Jean B. J.*, series, 304, 348.  
*Fournier, Prof.*, television, 183.  
*Fowle, Frank F.*, copper-clad wire, 284.  
*Freir, Samuel P.*, neutral relay, 96.  
 Frequency, dot-, 304, 356.  
     reversal-, 356.  
*Fuller, John*, battery, 20.  
 Fuses, 135.  
  
 Galvanized iron wire, 29, 262.  
*Gamevell, John N.*, fire-alarm box, 194.  
*Gardiner, James M.*, fire-alarm box, 194.  
 General equations of line current and voltage, 329.  
 Generators, 23.  
*Ghegan, John J.*, repeater, 42.  
*Ginil, Dr. Wilhelm*, duplex, 45.  
 Gong circuits, fire-alarm, 211.  
     electromechanical, 210.  
*Gott, John*, cable signalling, 369.  
 Gravity battery, 20.  
*Gray, Prof. Elisha*, telautograph, 170.  
 Ground as return path, 1, 279.  
     connections, 281.  
     resistance, 2, 280.  
 Grounded capacity of cables, 287.  
 Growth of current in cables, 351.  
     in relay, 14, 35.  
*Guild, George R.*, induction telegraph, 186.  
 Guying of aerial lines, 257.  
  
 Half-set repeaters, 80.  
 Handling of telegraphic traffic, 154.  
 Hangers, cable, 272.  
 Hard-drawn copper wire, 29, 262.  
*Heaviside, Oliver*, earth resistance, 279.  
     wire capacity, 285.  
  
 High-potential leak duplex, 62.  
*Horton, Lewis*, repeater, 42.  
 Howler, telephone, 300.  
*Hughes, Prof. David E.*, printer, 133.  
 Hyperbolic functions, table of, 394.  
     use of, 18, 265, 284, 322.  
  
 Ideal line, velocity of wave propagation on, 313.  
 Impedance at ends of line, 326.  
     characteristic, of line, 319.  
     conductor, 316.  
     of relays, 13.  
     surge, 319, 357.  
     track bonds, 244.  
 Indicators, fire-alarm, 210.  
 Inductance of line wires, 283.  
 Induction repeaters, 187.  
     telegraphs, 184.  
 Inductive line interference, 288.  
     shunt for recorders, 373.  
 Installation of aerial cables, 272.  
 Instrument tables, 145.  
 Insulation resistance of cables, 270, 288, 379.  
     of lines, 30, 287.  
 Insulators, 254.  
 Interlacing of circuits, 194.  
 Interlocking machines, 247.  
     plant signals, 225, 247.  
 Intermediate offices, 6.  
 Iron line wire, 29, 262.  
  
 Jacks, pin-, 139.  
     spring-, 138.  
 Joints in line wire, 253.  
 Joker fire-alarm circuits, 211.  
  
*Kelvin, Lord (Wm. Thomson)*, CR law, 364.  
     recorder, 360.

- Kennelly, Dr. Arthur E.*, hyperbolic functions, 321, 324.  
receiver resistance, 357.
- Keyboard, ticker, 119.
- Keys, 8, 363.
- Kinsley, Carl*, printer, 133.
- Kirnan, William H.*, repeater, 206.
- Kleinschmidt, Edward E.*, perforator, 122.
- Korn, Dr. Artur*, telephotography, 175.
- Lalande, F. de*, battery, 20.
- Leak duplex, 62.  
relays, 78.  
resistance of *Field* quad., 93.
- Leakage, line, 30.
- Leakance of lines, 287.
- Leclanché, Georges*, battery, 20.
- Legibility of recorder tapes, 359.
- Letters, cable, 382.  
day and night, 152.
- Light-relay, 177.  
signals on railways, 225.
- Lightning arresters, 135, 260.
- Lines, aerial open, 253.  
artificial, 47, 50.  
capacity of, 284.  
inductance of, 283.  
inductive interference on, 288.  
leakance of, 287.  
resistance of, 29, 283.  
telegraph, 28.
- Local circuits, 4.  
duplex and quadruplex, 141.
- Locking sheet, 250.
- Logarithms, table of, 392.
- Loop switchboards, 141.
- Low, A. M.*, television, 184.
- Löwy, Heinrich*, earth resistance, 2.
- Maclaurin, Colin*, series, 322.
- Magnet bobbins, windings of, 13.
- Magneto telephone circuit, 293.
- Main switchboards, 139.
- Malcolm, Dr. Henry W.*, law, 364.
- Mallet perforator, 109.
- Manholes, 275.
- Manual block signals, 224, 231.
- Marino, Algeri*, telephotography, 181.
- Marking current, 112.
- Matthews, W. N.* and *Claude L.*, conduit costs, 274.
- Maver, William, Jr.*, repeater, 42.
- McIntyre, C.*, connector, 253.
- Mecograph transmitting key, 10.
- Mercadier, Prof. Ernest J. P.*, telegraph system, 162.
- Messages, telegraph, types of, 150.
- Messenger wires, 272.
- Military induction telegraphs, 184.
- Milliken, George F.*, repeater, 42.
- Morkrum printer (*Chas. L. Krum* and *Jay Morton*), 133.
- Morris, Robert H.*, duplex, 66.
- Morse, Prof. Samuel F. B.*, code, 25.  
telegraph system, 1.
- Motor-generator sets, 24.  
switchboard connections of, 147.
- Muirhead, Dr. Alexander*, artificial cable, 372.  
relay, 368.
- Multiplex, *Murray*, page printer, 163.  
telegraphy, 162.
- Municipal telegraphs, 189.
- Munier, Claude J. A.*, printing telegraph, 133.
- Murray, Donald*, printer, 133, 163.
- Mutual capacity of wires, 285.  
inductance of wires, 283.

- Neilson, Hugh*, repeater, 42.  
 Neomon, interpretation of, 316.  
*Nernst, Dr. Wallther*, lamp, 177.  
 Neutral relays, construction of, 12.  
     differential, 46.  
     effect of current reversals in, 94.  
     with extra coil, 96.  
*Nicol, William*, prism, 183.  
 Night letters, 152.  
 Non-interfering repeater, 206.  
     signal boxes, 194.  
  
 Open-circuit *Morse* system, 5.  
 Oscillogram of current growth, 14.  
 Overlap railway signal system,  
     233.  
  
 Paper winder, 16, 211.  
 Patching cords, 139.  
 Peg-switch panel, 136.  
 Perforator, keyboard, 122.  
     *Kleinschmidt*, 122.  
     mallet, 109.  
 Permittivity of dielectric, 286.  
 Phantom telephone circuit, 296.  
 Phantoplex system, 103.  
*Phillips, Walter P.*, punctuation  
     code, 25.  
     repeater, 37, 80.  
 Photographs, transmission of, 175.  
 Physical telephone circuits, 296.  
*Picard, Pierre*, cable signalling, 367.  
     telegraph system, 162.  
 Pins, insulator, 254.  
 Plugs for pin jacks, 139.  
 Polar direct-point repeater, 76.  
     duplex, 56.  
 Polarized block-signal system, 240.  
     relays, 53, 125.  
     sounder, 186.  
 Polar-neutral track relay, 240.  
  
 Pole boxes, cable, 277.  
     changer, 56.  
     Western Union, 72.  
     spacing, economic, 266.  
     telegraph, 254.  
 Police patrol boxes, 218.  
     central offices, 220.  
     telegraphs, 217.  
     statistics of, 221.  
*Pollak, Dr. Antoine*, writing tele-  
     graph, 167.  
 Postal polar duplex, 63.  
     quadruplex, 96.  
 Power switchboards, 146.  
 Primary batteries, 20.  
 Printing telegraph, *Barclay*, 121.  
     various, mention of, 133.  
 Printing telegraphy, 115.  
 Problems, 43, 83, 106, 134, 161, 188,  
     223, 251, 300, 346, 385.  
 Propagation constant of line, 318.  
 Protective devices, 135.  
     resistances, 24, 61.  
 Protectors, 145.  
 Public fire alarms, 200.  
  
 Quadrantal operator, 316.  
 Quadruplex, *Davis-Eaves*, 96.  
     *Field* key system, 91.  
     Postal Telegraph Co., 96.  
     repeaters, 100.  
     signalling, theory of, 344.  
     switchboard circuits, 141.  
     systems, operation of, 87.  
     telegraphy, 85.  
     Western Union, 98.  
  
 Railway composite signalling, 298.  
     interlocking signals, 247.  
     operation, the telegraph in, 157.  
     signal systems, 224.

- Receiver, *Barclay* printing, 126.  
*Korn* telephotographic, 177.  
*Pollak-Virag*, 168.
- Receiving instruments, best resistance of, 357.  
 best winding for, 16.
- Recorder, siphon, 360.  
*Wheatstone*, 108, 114.
- Reflection coefficient, 320.
- Registers, 15, 210.
- Relay current in bridge duplex, 345.
- Relays, ampere-turns for, 4.  
 cable, 368.  
 construction of neutral, 12.  
 current growth in neutral, 14.  
 design of, 35.  
*Diehl* arrangement of, 95, 97.  
 differential neutral, 46.  
 polarized, 55, 125.  
 leak, 78.  
 light-, 177.  
 phantoplex, 204.  
 polarized, 53.  
 resistance of, 13, 19, 56.  
 step-, 180.  
 track, 240, 246.  
 use of, 3.  
 windings, 16.
- Repeaters, *Atkinson*, 40.  
 closed-circuit, 37.  
 direct-point, 76.  
 duplex, 76.  
 fire-alarm, 206.  
 half-set, 80.  
 induction, 187.  
 open-circuit, 42.  
 quadruplex, 100.  
 simplex, 35.  
 various, mention of, 42.  
*Weiny-Phillips*, 37, 80.
- Repeating coil, 294.  
 sounders, 40, 67, 95.
- Reperforator, 114.
- Resistance of artificial lines, 52.  
 of *Field* quadruplex, 93.  
 of grounds, 282.  
 of polarized relays, 56.  
 of relays, 13.  
 of selenium, 175.  
 of siphon recorders, 362.  
 of sounders, 11.  
 of telegraph lines, 29.  
 of the earth, 279.  
 of wires, 283.
- Resonators for sounders, 11.
- Retardation coils, 67.  
 construction of, 71.
- Retransmission over cables, 368.
- Reversal-frequency, 356.
- Rheostats, artificial line, 52.
- Rignoux*, television, 183.
- Ringling over composited lines, 297.
- Rowland, Prof. Henry A.*, printing telegraph, 133, 163.
- Ruddick, John J.*, fire-alarm box, 194.
- Ruhmer, Ernst*, television, 183.
- Sags of wires, 262.
- Saturated-core cables, 269.
- Secondary batteries, 21.
- Sector signal boxes, 200.
- Seeing at a distance, 183.
- Selenium resistance as affected by light, 175.
- Self-inductance of wires, 283.
- Semaphores, 225.  
 operation of, 229.
- Semi-automatic transmitters, 10.
- Sextuplex signalling, 104.
- Shading coils on relay, 246.
- Shunt, inductive, 373.

- Side circuit, 296.  
*Siemens, Dr. E. Werner*, printer, 133.  
 Signal boxes, fire-alarm, 192.  
     Gamewell Company, 196.  
     police, 218.  
     successive, 195.  
 Signalling speed on cables, 363.  
     types of, *see* Telegraphy.  
 Signals, railway, 224.  
 Silent interval in cable operation, 355.  
 Simplex instruments, 8.  
     repeaters, 35.  
     signalling on telephone lines, 295.  
     with one generator, 336.  
     with two generators, 341.  
     switchboard circuit, 142.  
     telegraphy, 1.  
 Simultaneous telegraphy and telephony, 293.  
 Sines, table of, 388, 394.  
 Sine-wave cable signalling, 374.  
     equivalent, 304.  
     transmission, illustration of, 330.  
 Single-current duplex, 46.  
     line repeaters, 35.  
     *Morse* circuit, 2.  
 Siphon recorder, 360.  
*Skelton, Francis A.*, repeater, 206.  
 Sounders, ampere-turns for, 3.  
     construction of, 10.  
     polarized, 186.  
     repeating, 67, 95.  
     resistance of, 11.  
     windings of, 16.  
 Spans, economic length of, 266.  
     wire, 261.  
 Spark quenching at contacts, 61, 73.  
 Specific inductive capacity, 286.  
 Speed, effect of signalling, 334.  
     of cable signalling, 363.  
     of signalling, 33.  
 Splices, cable, 276.  
 Spring jacks, 138.  
*Squier, Col. George O.*, cable signalling, 374.  
 Statistics of cables, 271, 381.  
     of telegraph systems, 159.  
 Steam railways, signals for, 239.  
*Stearns, Joseph B.*, duplex, 46.  
*Steinheil, Prof. Karl A. von*, earth return, 279.  
 Step-relay, 180.  
 Storage batteries, 21.  
 Strap and disc switch, 136.  
 Stresses in poles, 256.  
 Submarine cables, design of, 375.  
     telegraphy, 347.  
 Successive signal boxes, 195.  
 Sunflower distributor, 126.  
 Surge impedance, 319, 357.  
 Switchboards, fire-alarm, 209.  
     police telegraph, 220.  
     power, 146.  
     telegraph, 138.  
 Synchronous distributors, 164.  
 Tape, perforated transmitting, 108,  
     122, 164, 167.  
     siphon recorder, 361.  
     ticker, 120.  
 Tariffs, cable, 381.  
     telegraph, 152.  
*Taylor, John D.*, relay, 242.  
 Telautograph, 170.  
 Telegrams, 152.  
 Telegraph cables, 269.  
     equation, 350.  
     induction, 184.  
     in railway operation, 157.  
     lines, 253.  
     current propagation in, 303.  
     municipal, 189.



- Telegraph statistics, 159.  
 Telegraphy, automatic, 108.  
     cable, 347.  
     duplex, 45.  
         cable, 372.  
     fire-alarm, 189.  
     multiplex, 162.  
     police-patrol, 217.  
     printing, 115.  
     quadruplex, 85.  
     simplex, 1.  
     simultaneous telephony and, 293.  
     submarine, 347.  
     synchronous, 162.  
     writing, 167.  
 Telephone circuits, 293.  
 Telephoning of messages, 155.  
 Telephony on telegraph lines, 298.  
     simultaneous telegraphy and, 293.  
 Telephotography, 175.  
     color, 181.  
 Television, 182.  
 Test grounds, 282.  
 Theory of current propagation, 303.  
*Thomson, Prof. Elihu*, arcs, 181.  
 Ticker telegraphs, 115.  
*Tiffany, George S.*, telautograph, 170.  
 Time stamp, automatic, 211.  
 Timing of condenser discharge, 52.  
*Toye, Benjamin B.*, repeater, 42.  
 Track circuits, 239.  
     relays, 240, 246.  
 Traffic-direction-block system, 235.  
     telegraph, 150.  
         handling of, 154.  
 Transformers, use of, in eliminating  
     inductive interference, 290.  
 Transition theory of transmission,  
     305, 347.  
 Transposition insulator, 254.  
     of line wires, 289.  
 Transmission distance on leaky lines,  
     32.  
         on perfectly-insulated lines, 4.  
     of current over line, 303.  
     of signals over cables, 355.  
     theory, alternating-current, 306.  
         direct-current, 334.  
         transition, 305, 347.  
 Transmitters, automatic, 110, 122.  
     continuity-preserving, 50, 58.  
     fire-alarm, 203.  
     *Korn* telephotographic, 176.  
     pole-changing, 56.  
     *Pollak-Virag*, 167.  
     repeater, 38, 40.  
     semi-automatic, 10.  
     ticker telegraph, 115.  
     *Wheatstone*, 108.  
 Trigonometric functions, 388.  
 Underground cables, 269.  
     installation of, 273.  
     conduit, 274.  
 Uniform lines, current distribution  
     on, 306.  
*Van Rysselberghe, Prof. Francois*,  
     composite signalling, 296.  
 Vector representation, 315.  
 Velocity of wave propagation, 312.  
 Vibrator, siphon recorder, 361.  
 Vibroplex transmitting key, 10.  
*Virag, Josef*, writing telegraphs, 167.  
 Voltage distribution equations, 309.  
     general, 329.  
     on cables, 350.  
 Voltages, standard, in telegraphy, 24.  
 Wave-length constant, 311.  
     propagation, theory of, 306.  
 Wedges for spring jacks, 138.

- Week-end letters, 382.  
Weights of cable, 271, 380.  
    sheaths, 380.  
    of line wire, 29, 262.  
*Weiny, Roderick H.*, repeater, 37,  
    80.  
Western Union bridge-duplex, 71.  
    quadruplex, 98.  
    switchboards, 139.  
*Wheatstone, Sir Charles*, automatic  
    telegraph, 108.  
    bridge, 67, 373.  
Whistle-blowing machine, 200.  
*Whitehead, Charles S.*, receiver re-  
    sistance, 338.  
Winding constants of magnets, 13.  
    for receiving instruments, 16.  
Wire, bimetallic, 29.  
    capacity of line, 284.  
    leakance of line, 287.  
    inductance of line, 283.  
    resistance of line, 29, 283.  
    sizes of line, 29.  
    spans, 261.  
    tensile strength of, 262.  
    weights of line, 29, 262.  
*Wright, John E.*, printer, 133.  
Writing telegraphs, 167.  
*Yorke, George M.*, line induction, 292.

LIST OF WORKS  
ON  
ELECTRICAL SCIENCE

PUBLISHED AND FOR SALE BY

D. VAN NOSTRAND COMPANY,  
25 Park Place, New York.

---

- ABBOTT, A. V. *The Electrical Transmission of Energy. A Manual for the Design of Electrical Circuits. Fifth Edition, enlarged and rewritten.* With many Diagrams, Engravings and Folding Plates. 8vo., cloth, 675 pp. . . . . Net, \$5.00
- ALEXANDER, J. H. *Elementary Electrical Engineering in Theory and Practice.* A class-book for junior and senior students and working electricians. Illustrated. 12mo., cloth, 208 pp. . . . . \$2.00
- ARNOLD, E. *Armature Windings of Direct-Current Dynamos. Extension and Application of a general Winding Rule.* Translated from the original German by Francis B. DeGress. Illustrated. 8vo. cloth, 124 pp. . . . . \$2.00
- ASHE, S. W. *Electricity Experimentally and Practically Applied. Second Edition.* 422 illustrations. 12mo., cloth, 375 pp. . Net, \$2.00
- ASHE, S. W., and KEILEY, J. D. *Electric Railways Theoretically and Practically Treated.* Illustrated. 12mo., cloth.
- Vol. I. *Rolling Stock. Second Edition.* 285 pp. . . . . Net, \$2.50
- Vol. II. *Substations and Distributing Systems.* 296 pp. . . . Net, \$2.50

- ATKINSON, A. A. **Electrical and Magnetic Calculations.** For the use of Electrical Engineers and others interested in the Theory and Application of Electricity and Magnetism. *Fourth Edition, revised* Illustrated. 12mo., cloth, 310 pp. ....Net, \$1.50
- ATKINSON, PHILIP. **The Elements of Dynamic Electricity and Magnetism.** *Fourth Edition.* Illustrated. 12mo., cloth, 405 pp. \$2.00
- Elements of Electric Lighting,** including Electric Generation, Measurement, Storage, and Distribution. *Tenth Edition,* fully revised and new matter added. Illustrated. 12mo., cloth, 280 pp. ....\$1.50
- Power Transmitted by Electricity and Applied by the Electric Motor,** including Electric Railway Construction. Illustrated. *Fourth Edition,* fully revised and new matter added. 12mo., cloth, 241 pp. ...\$2.00
- AYRTON, HERTHA. **The Electric Arc.** Illustrated. Svo., cloth, 479 pp. ....Net, \$5.00
- AYRTON, W. E. **Practical Electricity.** A Laboratory and Lecture Course. 300 illustrations. 6x8 $\frac{3}{4}$ , cloth, 562 pp. ....Net, \$3.00
- BAKER, J. T. **The Telegraphic Transmission of Photographs.** 63 illustrations. 12mo., cloth, 155 pp. ....Net, \$1.25
- BARHAM, G. B. **Development of the Incandescent Electric Lamp.** 25 illustrations, 2 plates, 5 $\frac{1}{2}$ x8 $\frac{3}{4}$  cloth. 206 pp. ....\$2.00
- BEDELL, FREDERICK. **Direct and Alternating Current Manual.** With directions for testing and a discussion of the theory of electrical apparatus. *Second Edition, greatly enlarged.* Assisted by C. A. Pierce. Illustrated. 6x9, cloth, 373 pp. ....Net, \$2.00
- BEDELL, F. and CREHORE, A. C. **Alternating Currents.** An analytical and graphical treatment for students and engineers. *Fifth Edition.* 112 illustrations. Svo., cloth, 325 pp. ...Net, \$2.50
- BLAINE, ROBERT G. **The Calculus and Its Applications.** A practical treatise for beginners especially engineering students. 79 illustrations. 12mo., cloth, 330 pp. ....Net, \$1.50
- BONNEY, G. E. **The Electro-Plater's Hand Book.** A Manual for Amateurs and Young Students of Electro-Metallurgy. *Fourth Edition, enlarged.* 61 Illustrations. 12mo., cloth, 208 pp. ....\$1.20
- BOTTONE, S. R. **Magnetos For Automobilists; How Made and How Used.** A handbook of practical instruction on the manufacture and adaptation of the magneto to the needs of the motorist. *Second Edition, enlarged.* 52 illustrations. 12mo., cloth, 118 pp. ....Net, \$1.00

- BOWKER, WM. R.** *Dynamo, Motor, and Switchboard Circuits for Electrical Engineers: a practical book dealing with the subject of Direct, Alternating, and Polyphase Currents. Second Edition, greatly enlarged, 130 illustrations. Svo., cloth, 180 pp.....Net, \$2.50*
- BROADFOOT, S. K.** *Motors, Secondary Batteries and Accessory Apparatus. 16 illustrations. 16mo., cloth. 100 pp. (Installation Manuals Series).....Net, 0.75*
- BROUGHTON, H. H.** *Electric Cans. Their design, construction and application. 600 illustrations and plates. 120 tables, 6x9, cloth, 848 pp.....Net, \$9.00*
- CARTER, E. T.** *Motive Power and Gearing for Electrical Machinery; a treatise on the theory and practice of the mechanical equipment of power stations for electric supply and for electric traction. Second Edition, revised. Illustrated. Svo., cloth, 700 pp.....Net, \$5.00*
- CHILD, C. D.** *Electric Arcs. Experiments upon arcs between different electrodes in various environments and their explanation. 58 illustrations. 5x7, cloth, 203 pp.....Net, \$2.00*
- CHILD, CHAS. T.** *The How and Why of Electricity: a book of information for non-technical readers, treating of the properties of Electricity, and how it is generated, handled, controlled, measured, and set to work. Also explaining the operation of Electrical Apparatus. Illustrated. Svo., cloth, 140 pp.....\$1.00*
- COLLIS, A. G.** *High and Low Tension Switchgear Design. 94 illustrations and folding plates, 6x9, cloth, 233 pp.....Net, \$3.50*
- Switchgear and The Control of Electric Circuits. 47 illustrations. 4½x6½, cloth, 85 pp. (Installation Manuals Series)..... Net, 0.50*
- COOPER, W. R.** *Primary Batteries: their Theory, Construction, and Use 131 Illustrations. Svo., cloth, 324 pp.....Net, \$4.00*
- CRAMP, W.** *Continuous Current Machine Design. 137 illustration. Svo., cloth, 240 pp.....Net, \$2.50*
- CREEDY, F.** *Single-Phase Commutator Motors. 98 illustrations, 6x9, cloth, 120 pp.....Net, \$2.00*
- CROCKER, F. B.** *Electric Lighting. A Practical Exposition of the Art for the use of Electricians, Students, and others interested in the Installation or Operation of Electric-Lighting Plants.*
- Vol. I.—The Generating Plant. Seventh Edition, entirely revised. Illustrated. Svo., cloth, 482 pp.....\$3.00**
- Vol. II.—Distributing System and Lamps. Sixth Edition. Illustrated. Svo., cloth, 505 pp.**

- CROCKER, F. B., and ARENDT, M.** *Electric Motors: Their Action, Control, and Application. Second Edition, Revised and Enlarged.* 169 illustrations. 6½x9¼, cloth, 315 pp. . . . . Net, \$2.50
- CROCKER, F. B., and WHEELER, S. S.** *The Management of Electrical Machinery.* Being a *thoroughly revised and rewritten edition* of the authors' "Practical Management of Dynamos and Motors." *Eighth Edition.* Illustrated. 16mo., cloth, 232 pp. . . . . Net, \$1.00
- CUSHING, H. C., Jr.** *Standard Wiring for Electric Light and Power* Illustrated. 16mo., leather, 156 pp. . . . . \$1.00
- DAVIES, F. H.** *Electric Power and Traction.* Illustrated. 8vo., cloth 293 pp. (Van Nostrand's Westminster Series.) . . . . . Net, \$2.00
- *Foundations and Machinery Fixing.* 52 illustrations. 16mo., cloth, 146 pp. (Installations Manuals Series) . . . . . Net, \$0.75
- DEL MAR, W. A.** *Electric Power Conductors. Second edition revised.* 69 illustrations. 5½x8, cloth, 330 pp. . . . . Net, \$2.00
- DEVEY, R. G.** *Mill and Factory Wiring.* 126 illustrations. 16mo., cloth, 209 pp. (Installation Manuals Series) . . . . . Net, \$1.00
- DINGER, Lieut. H. C.** *Handbook for the Care and Operation of Naval Machinery. Second Edition.* 124 Illustrations. 16mo., cloth, 302 pp. . . . . Net, \$2.00
- DUNCAN, W. G. and PENMAN, D.** *Electrical Equipment of Collieries.* 157 illustrations, 6½x8½, cloth, 329 pp. . . . . Net, \$4.00
- DWIGHT, H. B.** *Transmission Line Formulas for Electrical Engineers and engineering Students.* 27 illustrations. 2 folding plates, 12mo, cloth, 143 pp. . . . . Net, \$2.00
- DYNAMIC ELECTRICITY:** Its Modern Use and Measurement, chiefly in its application to Electric Lighting and Telegraphy, including:  
 1. Some Points in Electric Lighting, by Dr. John Hopkinson. 2. On the Treatment of Electricity for Commercial Purposes, by J. N. Shoolbred. 3. Electric-Light Arithmetic, by R. E. Day, M.E. *Fourth Edition.* Illustrated. 16mo., boards, 166 pp. (No. 71 Van Nostrand's Science Series.) . . . . . 50 cents
- ECK, J.** *Light, Radiation and Illumination.* Translated from the German of Paul Hogner. 59 illustrations. 5½x8½, cloth, 100 pp. Net, \$2.50
- EDLER, R.** *Switches and Switchgear.* Translated by Ph. Laubach. 335 illustrations. 6½x9, cloth, 412 pp. . . . . Net, \$4.00

- EDGCUMBE, K.** Industrial Electrical Measuring Instruments. Illustrated. Svo., cloth, 227 pp. . . . . Net, \$2.50
- EWING, J. A.** Magnetic Induction in Iron and other Metals. *Third Edition, revised.* Illustrated. Svo., cloth, 393 pp. . . . . Net, \$4.00
- FISHER, H. K. C., and DARBY, W. C.** Students' Guide to Submarine Cable Testing. *Third Edition, new, enlarged.* Illustrated. Svo., cloth, 326 pp. . . . . Net, \$3.50
- FLEMING, J. A., Prof.** The Alternate-Current Transformer in Theory and Practice.
- Vol. I.: The Induction of Electric Currents. *Fifth Issue.* Illustrated. Svo., cloth, 641 pp. . . . . Net, \$5.00
- Vol. II.: The Utilization of Induced Currents. *Third Issue.* Illustrated. Svo., cloth, 587 pp. . . . . Net, \$5.00
- Propagation of Electric Currents in Telephone and Telegraph Conductors. Illustrated. 6½x9½, cloth, 323 pp. . . . . Net, \$3.00
- Handbook for the Electrical Laboratory and Testing Room. Two Volumes. Illustrated. Svo., cloth, 1160 pp. Each vol. . . . Net, \$5.00
- FOSTER, H. A.** With the Collaboration of Eminent Specialists. Electrical Engineers' Pocket Book. A handbook of useful data for Electricians and Electrical Engineers. With innumerable Tables, Diagrams, and Figures. The most complete book of its kind ever published, treating of the latest and best Practice in Electrical Engineering. *Seventh Edition, completely revised and enlarged.* Fully Illustrated. Pocket Size. Leather. Thumb Indexed. 1636 pp. . . . . \$5.00
- Engineering Valuation of Public Utilities and Factories. 50 blank forms. 6x9, cloth, 361 pp. . . . . Net, \$3.00
- Electrical Cost Data, Estimates and Working Tables. *In Press*
- FOWLE, F. F.** The Protection of Railroads from Overhead Transmission Line Crossings. 35 illustrations. 12mo., cloth, 76 pp. . . . . Net, \$1.50.
- The Solution of Alternating Current Problems. *In Preparation*
- FRITH, J.** Alternating Current Design. 27 illustrations. 6x9, cloth, 131 pp. . . . . Net, \$2.00
- FREUDEMACHER, P. W.** Electrical Mining Installations. 36 illustrations. 16mo., cloth, 192 pp. (Installation Manuals Series). Net, \$1.00
- GANT, L. W.** Elements of Electric Traction for Motormen and Others. Illustrated with Diagrams. Svo., cloth, 217 pp. . . . . Net, \$2.50

- GEAR, H. B. and WILLIAMS, P. F. Electric Central Station Distribution Systems. Their Design and Construction. 139 illustrations. 8vo., cloth, 352 pp.....Net \$3.00
- GERHARDI, C. H. W. Electricity Meters; their Construction and Management. A practical manual for engineers and students. Illustrated. 8vo., cloth, 337 pp. ....Net, \$4.00
- GOLDSMITH, RUDOLF. The Alternating Current Commutator Motor. The Leakage of Induction Motors. In one volume. 247 illustrations. 5½x8½, cloth.....Net, \$3.00
- GORE, GEORGE. The Art of Electrolytic Separation of Metals (Theoretical and Practical). Illustrated. 8vo., cloth, 295 pp....Net \$3.50
- GROTH, L. A. Welding and Cutting Metals by Aid of Gases or Electricity. 124 illustrations. 8vo., cloth, 280 pp. (Van Nostrand's Westminster Series).....Net, \$2.00
- HALL, G. L. Elementary Theory of Alternate Current Working. 130 illustrations.....Net, \$1.50
- HALLER, G. F. and CUNNINGHAM, E. T. The Tesla High Frequency Coil; its construction and uses. 12mo., cloth, 56 illustrations, 130 pp.....Net, \$1.25
- HASKINS, C. H. The Galvanometer and its Uses. A Manual for Electricians and Students. *Fifth Edition, revised.* Illustrated. 16mo., morocco, 75 pp.....\$1.50
- HAY, ALFRED. Alternating Currents; their theory, generation, and transformation. *Second Edition.* 191 Illustrations. 8vo., cloth, 319 pp.....Net, \$2.50
- An Introductory Course of Continuous-Current Engineering. Illustrated. 8vo., cloth, 327 pp.....Net, \$2.50
- HAYES, H. V. Public Utilities, Their Cost New and Depreciation. 5½x8½, cloth, 275 pp.....Net, \$2.00
- HEATHER, H. J. Electrical Engineering for Mechanical and Mining Engineers. 183 illustrations. 5½x8½, cloth, 344 pp.....Net, \$3.50
- HEAVISIDE, O. Electromagnetic Theory. Two Volumes with Many Diagrams. 8vo., cloth, 1006 pp. Each Vol.....Net, \$5.00
- Vol. III.—529 pp.....Net, \$7.50



- HEDGES, K. Modern Lightning Conductors.** An illustrated Supplement to the Report of the Research Committee of 1905, with notes as to methods of protection and specifications. Illustrated. Svo., cloth, 119 pp.....Net, \$3.00
- HOBART, H. M. Heavy Electrical Engineering.** Illustrated. Svo., cloth, 338 pp.....Net, \$4.50
- **Design of Static Transformers.** 101 illustrations. 6x9, cloth, 189 pp.....Net, \$2.00
- **Electricity.** A text-book designed in particular for engineering students. 115 illustrations. 43 tables. Svo., cloth, 266 pp.,Net,\$2.00
- **Electric Trains.** 88 illustrations. Svo., cloth, 229 pp...Net, \$2.50
- **Electric Propulsion of Ships.** 44 illustrations. Sqo., cloth, 167 pp. Net, \$1.00
- HOBBS, W. R. P. The Arithmetic of Electrical Measurements.** With numerous examples, fully worked. *Twelfth Edition.* 12mo., cloth, 126 pp.....50 cents
- HOPKINS, N. M. Experimental Electrochemistry, Theoretically and Practically Treated.** Profusely illustrated with 130 new drawings, diagrams, and photographs, accompanied by a Bibliography. Illustrated. Svo, cloth, 298 pp.....Net, \$3.00
- HOUSTOUN, R. A. Studies in Light Production.** 22 illustrations. 5 $\frac{1}{4}$ x8 $\frac{1}{4}$ , cloth, 120 pp.....Net, \$2.00
- HUTCHINSON, R. W., Jr. Long-Distance Electric Power Transmission:** Being a Treatise on the Hydro-Electric Generation of Energy; Its Transformation, Transmission, and Distribution. *Second Edition.* Illustrated. 12mo., cloth, 350 pp.....Net, \$3.00
- and **THOMAS, W. D. Electricity in Mining.** Being a theoretical and practical treatise on the construction, operation and maintenance of electrical mining machinery. 12mo., cloth.....*In Press*
- INCANDESCENT ELECTRIC LIGHTING.** A Practical Description of the Edison System, by H. Latimer. To which is added: The Design and Operation of Incandescent Stations, by C. J. Field; A Description of the Edison Electrolyte Meter, by A. E. Kennelly; and a Paper on the Maximum Efficiency of Incandescent Lamps, by T. W. Howell. *Fifth Edition.* Illustrated. 16mo., cloth, 140 pp. (No. 57 Van Nostrand's Science Series.).....50 cents
- INDUCTION COILS: How Made and How Used.** *Eleventh Edition.* Illustrated. 16mo., cloth, 123 pp. (No. 53 Van Nostrand's Science Series.).....50 cents

- JEHL, FRANCIS.** The Manufacture of Carbons for Electric Lighting and other purposes. Illustrated with numerous Diagrams, Tables, and Folding Plates. 8vo., cloth, 232 pp. . . . . Net, \$4.00
- JOHNSON, J. H.** Arc Lamps and Accessory Apparatus. 20 illustrations. 16mo., cloth, 135 pp. (Installation Manuals Series). .Net, 75 cents.
- JOHNSON, T. M.** Ship Wiring and Fitting. 47 illustrations. 16mo., cloth, 92 pp. (Installation Manuals Series). . . . . Net, 75 cents.
- JONES, HARRY C.** The Electrical Nature of Matter and Radioactivity. *Second Edition, revised and enlarged.* 12mo., cloth, 218 pp. . \$2.00
- KAPP, GIBBERT.** Alternate-Current Machinery. Illustrated. 16mo., cloth, 190 pp. (No. 96 Van Nostrand's Science.) Series. . . 50 cents
- KENNEDY, R.** Electrical Installations of Electric Light, Power, and Traction Machinery. Illustrated. 8vo., cloth, 5 vols. The set \$15.00. Each . . . . . \$3.50
- KENNELLY, A. E.** Theoretical Elements of Electro-Dynamic Machinery. Vol. I. Illustrated. 8vo., cloth, 90 pp. . . . . \$1.50
- KERSHAW, J. B. C.** The Electric Furnace in Iron and Steel Production. Illustrated. 8vo., cloth, 74 pp. . . . . Net, \$1.50
- **Electrometallurgy.** Illustrated. 8vo., cloth, 303 pp. (Van Nostrand's Westminster Series). . . . . Net, \$2.00
- KINZBRUNNER, C.** Continuous-Current Armatures; their Winding and Construction. 79 Illustrations. 8vo., cloth, 80 pp. . . . . Net, \$1.50
- Alternate-Current Windings; their Theory and Construction. 89 Illustrations. 8vo., cloth, 80 pp. . . . . Net, \$1.50
- **The Testing of Alternating Current Machines in Laboratories and Test Rooms.** A practical work for students and engineers. Vol. I. General Tests; Transformers, Alternators. 141 illustrations. 5½x8¾, cloth, 164 pp. . . . . Net, \$2.00
- KOESTER, F.** Hydroelectric Developments and Engineering. A practical and theoretical treatise on the development, design, construction, equipment and operation of hydroelectric transmission plants. *Second Edition.* 500 illustrations. 4to., cloth, 475 pp. . . Net, \$5.00
- **Steam-Electric Power Plants.** A practical treatise on the design of central light and power stations and their economical construction and operation. *Second Edition.* Fully Illustrated. 4to., cloth, 455 pp. . . . . Net, \$5.00

- LANCASTER, M.** Electric Cooking, Heating and Cleaning. Edited by W. E. Lancaster, American Edition by S. L. Coles, 305 illustrations. *In Press*
- LARNER, E. T.** The Principles of Alternating Currents for Students of Electrical Engineering. Illustrated with Diagrams. 12mo., cloth, 144 pp.....Net, \$1.25
- LEMSTROM, S.** Electricity in Agriculture and Horticulture. Illustrated. 8vo., cloth.....Net, \$1.50
- LIVERMORE, V. P., and WILLIAMS, J.** How to Become a Competent Motorman: Being a practical treatise on the proper method of operating a street-railway motor-car; also giving details how to overcome certain defects. *Second Edition.* Illustrated. 16mo., cloth, 247 pp.....Net, \$1.00
- LIVINGSTONE, R.** Mechanical Design and Construction of Generators. 122 illustrations. 5½x8¾, cloth, 228 pp.....Net, \$3.50
- Mechanical Design and Construction of Commutators. 62 illustrations, 5½x8¾, cloth, 93 pp.....Net, \$2.25
- LOCKWOOD, T. D.** Electricity, Magnetism, and Electro-Telegraphy. A Practical Guide and Handbook of General Information for Electrical Students, Operators, and Inspectors. *Fourth Edition.* Illustrated. 8vo., cloth, 374 pp.....\$2.50
- LODGE, OLIVER J.** Signalling Across Space Without Wires: Being a description of the work of Hertz and his successors. *Third Edition.* Illustrated. 8vo., cloth.....Net, \$2.00
- LORING, A. E.** A Handbook of the Electro-Magnetic Telegraph *Fourth Edition, revised.* Illustrated. 16mo., cloth, 116 pp. (No. 39 Van Nostrand's Science Series.).....50 cents
- LUPTON, A., PARR, G. D. A., and PERKIN, H.** Electricity Applied to Mining. *Second Edition.* With Tables, Diagrams, and Folding Plates. 8vo., cloth, 320 pp.....Net, \$4.50
- MANSFIELD, A. N.** Electromagnets: Their Design and Construction. *Second Edition.* Illustrated. 16mo., cloth, 155 pp. (No. 64 Van Nostrand's Science Series.).....50 cents
- MASSIE, W. W., and UNDERHILL, C. R.** Wireless Telegraphy and Telephony Popularly Explained. With a chapter by Nikola Tesla. Illustrated. 12mo., cloth, 82 pp.....Net, \$1.00

- MAURICE, W.** Electrical Blasting Apparatus and Explosives, with special reference to colliery practice. Illustrated. 8vo., cloth. 167 pp..... Net, 3.50
- The Shot Firer's Guide. A practical manual on blasting and the prevention of blasting accidents. 78 illustrations. 8vo., cloth. 212 pp..... Net, \$1.50
- MONCKTON, C. C. F.** Radio Telegraphy. 173 Illustrations. 8vo cloth, 272 pp. (Van Nostrand's Westminster Series.)... Net, \$2.00
- MORECROFT, J. H. and HEHRE, F. W.** A Short Course in Testing of Electrical Machinery. *Second Edition.* Illustrated. 8vo., cloth, 160 pp..... Net, 1.50
- MORGAN, ALFRED P.** Wireless Telegraph Construction for Amateurs. 153 illustrations. 12mo., cloth, 220 pp..... Net, \$1.50
- NERZ, F.** Searchlights, Their Theory, Construction and Application. Translated by C. Rodgers. 47 Illustrations. 6x8, cloth, 145 pp. Net, \$3.00
- NIPHER, FRANCIS E.** Theory of Magnetic Measurements. With an Appendix on the Method of Least Squares. Illustrated. 12mo., cloth, 94 pp..... \$1.00
- OHM, G. S.** The Galvanic Circuit Investigated Mathematically. Berlin, 1827. Translated by William Francis. With Preface and Notes by Thos. D. Lockwood. *Second Edition.* Illustrated. 16mo., cloth, 269 pp. (No. 102 Van Nostrand's Science Series.)..... 50 cents
- OLSSON, ANDREW.** Motor Control as used in Connection with Turret Turning and Gun Elevating. (The Ward Leonard System.) 13 illustrations. 12mo., paper, 27 pp. (U. S. Navy Electrical Series No. 1.)..... Net, .50
- LOUDIN, MAURICE A.** Standard Polyphase Apparatus and Systems. *Fifth Edition, revised.* Illustrated with many Photo-reproductions, Diagrams, and Tables. 8vo., cloth, 369 pp..... Net, \$3.00
- PALAZ, A.** Treatise on Industrial Photometry. Specially applied to Electric Lighting. Translated from the French by G. W. Patterson, Jr., and M. R. Patterson. *Second Edition.* Fully Illustrated. 8vo., cloth, 324 pp..... \$4.00

- PARR, G. D. A. **Electrical Engineering Measuring Instruments for Commercial and Laboratory Purposes.** With 370 Diagrams and Engravings. Svo., cloth, 328 pp.....Net, \$3.50
- PARSHALL, H. F., and HOBART, H. M. **Armature Windings of Electric Machines.** *Third Edition.* With 140 full-page Plates, 65 Tables, and 165 pages of descriptive letter-press. 4to., cloth, 300 pp. \$7.50
- **Electric Railway Engineering.** With 437 Figures and Diagrams and many Tables. 4to., cloth, 475 pp.....Net, \$10.00
- **Electric Machine Design.** Being a revised and enlarged edition of "Electric Generators." 648 Illustrations. 4to., half morocco, 601 pp.....Net, \$12.50
- PATCHELL, W. H. **Application of Electric Power to Mines and Heavy Industries.** 91 Illustrations. 6½x9¼, cloth, 344 pp.....Net, \$4.00
- PERRINE, F. A. C. **Conductors for Electrical Distribution: Their Manufacture and Materials, the Calculation of Circuits, Pole-Line Construction, Underground Working, and other Uses.** *Second Edition.* Illustrated. Svo., cloth, 287 pp.....Net, \$3.50
- POPE, F. L. **Modern Practice of the Electric Telegraph.** A Handbook for Electricians and Operators. *Seventeenth Edition.* Illustrated. Svo., cloth, 234 pp.....\$1.50
- RAPHAEL, F. C. **Localization of Faults in Electric Light Mains.** *Second Edition, revised.* Illustrated. Svo., cloth, 205 pp.....Net, \$3.00
- RASCH, E. **Electric Arc Phenomena.** Illustrated by K. Tornberg. 52 illustrations. 12mo., cloth, 200 pp.....*In Press*
- RAYMOND, E. B. **Alternating-Current Engineering, Practically Treated.** *Third Edition, revised.* With many Figures and Diagrams. Svo., cloth, 244 pp.....Net, \$2.50
- REDFERN, T. B. and SAVIN, J. **Bells, Indicators, Telephones, Fire and Burglar Alarms.** 85 illustrations. 4¼x6¾, cloth, 123 pp. (Installation Manuals Series).....0.50
- RICHARDSON, S. S. **Magnetism and Electricity and the Principles of Electrical Measurement.** Illustrated. 12mo., cloth, 596 pp. Net, \$2.00
- ROBERTS, J. **Laboratory Work in Electrical Engineering—Preliminary Grade.** A series of laboratory experiments for first and second-year students in electrical engineering. Illustrated with many Diagrams. Svo., cloth, 218 pp.....Net, \$2.00
- ROLLINS, W. **Notes on X-Light.** Printed on deckle edge Japan paper 400 pp. of text, 152 full-page plates. Svo., cloth. ....Net, \$5.00

- RUHMER, ERNST.** Wireless Telephony in Theory and Practice. Translated from the German by James Erskine-Murray. Illustrated. Svo., cloth, 224 pp. . . . . Net, \$3.50
- RUSSELL, A.** The Theory of Electric Cables and Networks. 71 Illustrations. Svo., cloth, 275 pp. . . . . Net, \$3.00
- SAYERS, H. M.** Brakes for Tramway Cars. 6x9, cloth, 76 pp. Net, 1.25
- SEVER, G. F.** Electrical Engineering Experiments and Tests on Direct-Current Machinery. *Second Edition, enlarged.* With Diagrams and Figures. 8vo., pamphlet, 75 pp. . . . . Net, \$1.00
- SEVER, G. F., and TOWNSEND, F.** Laboratory and Factory Tests in Electrical Engineering. *Second Edition, revised and enlarged.* Illustrated. 8vo., cloth, 269 pp. . . . . Net, \$2.50
- SEWALL, C. H.** Wireless Telegraphy. With Diagrams and Figures. *Second Edition, corrected.* Illustrated. 8vo., cloth, 229 pp. Net, \$2.00
- Lessons in Telegraphy. Illustrated. 12mo., cloth, 104 pp. Net, \$1.00
- SEWELL, T.** Elements of Electrical Engineering. *Fourth Edition, revised.* Illustrated. 8vo., cloth, 444 pp. . . . . \$3.00
- The Construction of Dynamos (Alternating and Direct Current). A Text-book for students, engineering contractors, and electricians-in-charge. Illustrated. 8vo., cloth, 316 pp. . . . . \$3.00
- SHAW, P. E.** A First-Year Course of Practical Magnetism and Electricity. Specially adapted to the wants of technical students. Illustrated. Svo., cloth, 66 pp. interleaved for note taking. . . . . Net, \$1.00
- SHELDON, S., and HAUSMANN, E.** Dynamo-Electric Machinery: Its Construction, Design, and Operation.
- Vol. I.: Direct-Current Machines. *Eighth Edition, completely re-written.* Illustrated. 12mo., cloth, 281 pp. . . . . Net, \$2.50
- Vol. II.: Alternating-Current Machines: *Eighth Edition, rewritten.* cloth, 353 pp. . . . . Net, \$2.50
- Electric Traction and Transmission Engineering. 127 illustration. 12mo., cloth, 317 pp. . . . . Net, \$2.50
- SLOANE, T. O'CONNOR.** Standard Electrical Dictionary. 300 Illustrations. 12mo., cloth, 682 pp. . . . . \$3.00
- Elementary Electrical Calculations. A Manual of Simple Engineering Mathematics, covering the whole field of Direct Current Calculations, the basis of Alternating Current Mathematics, Networks, and typical cases of Circuits, with Appendices on special subjects. 8vo., cloth. Illustrated. 304 pp. . . . . Net, \$2.00

- SMITH, C. F.** Practical Alternating Currents, and Alternating Current Testing. *Third Edition*. 236 illustrations.  $5\frac{1}{2} \times 8\frac{3}{4}$ , cloth, 476 pp.  
Net, \$2.50
- SMITH, C. F.** Practical Testing of Dynamos and Motors. *Third Edition*, 108 illustrations.  $5\frac{1}{2} \times 8\frac{3}{4}$ , cloth, 322 pp. . . . . Net, \$2.00
- SNELL, ALBION T.** Electric Motive Power. The Transmission and Distribution of Electric Power by Continuous and Alternating Currents. With a Section on the Applications of Electricity to Mining Work. *Second Edition*. Illustrated. Svo., cloth, 411 pp. . . . . Net, \$4.00
- SODDY, F.** Radio-Activity; an Elementary Treatise from the Standpoint of the Disintegration Theory. Fully Illustrated. Svo., cloth, 214 pp. . . . . Net, \$3.00
- SOLOMON, MAURICE.** Electric Lamps. Illustrated. Svo., cloth. (Van Nostrand's Westminster Series.) . . . . . Net, \$2.00
- STEWART, A.** Modern Polyphase Machinery. Illustrated. 12mo., cloth, 296 pp. . . . . Net, \$2.00
- SWINBURNE, JAS., and WORDINGHAM, C. H.** The Measurement of Electric Currents. Electrical Measuring Instruments. Meters for Electrical Energy. Edited, with Preface, by T. Commerford Martin. Folding Plate and Numerous Illustrations. 16mo., cloth, 241 pp. (No. 109 Van Nostrand's Science Series.) . . . . . 50 cents
- SWOOPE, C. WALTON.** Lessons in Practical Electricity: Principle Experiments, and Arithmetical Problems. An Elementary Text-book. With numerous Tables, Formulæ, and two large Instruction Plates. *Twelfth Edition, revised*. Illustrated. Svo., cloth, 462 pp.  
Net, \$2.00
- THIESS, J. B. and JOY, G. A.** Toll Telephone Practice. 273 illustrations. Svo. cloth, 433 pp. . . . . Net, \$3.50
- THOM, C., and JONES, W. H.** Telegraphic Connections, embracing recent methods in Quadruplex Telegraphy. 20 Colored Plates. Svo., cloth 59 pp. . . . . \$1.50
- THOMPSON, S. P.** Dynamo-Electric Machinery. With an Introduction and Notes by Frank L. Pope and H. R. Butler. Illustrated. 16mo., cloth, 214 pp. (No. 66 Van Nostrand's Science Series.) . . . 50 cents
- Recent Progress in Dynamo-Electric Machines. Being a Supplement to "Dynamo-Electric Machinery." Illustrated. 16mo., cloth, 113 pp. (No. 75 Van Nostrand's Science Series.) . . . . . 50 cents

- TOWNSEND, FITZHUGH. Alternating Current Engineering. Illustrated. 8vo., paper, 32 pp.....Net, 75 cents
- UNDERHILL, C. R. Solenoids, Electromagnets and Electromagnetic Windings. *Second Edition, thoroughly revised.* 224 Illustrations. 5½x8, cloth, 313 pp.....Net, \$2.00
- URQUHART, J. W. Electroplating. A Practical Handbook. *Fifth Edition.* Illustrated. 12mo., cloth, 230 pp.....\$2.00
- Electrotyping. Illustrated. 12mo., cloth, 228 pp.....\$2.00
- WADE, E. J. Secondary Batteries: Their Theory, Construction, and Use. *Second Edition, corrected.* 265 illustrations. 8vo., cloth, 501 pp.  
Net, \$4.00
- WADSWORTH, C. Primary Battery Ignition. A simple practical pocket guide on the construction, operation, maintenance, and testing of primary batteries for automobile, motorboat, and stationary engine ignition service. 26 illustrations. 5x7, cloth, 79 pp. Net, .0.50
- WALKER, FREDERICK. Practical Dynamo-Building for Amateurs. How to Wind for any Output. *Third Edition.* Illustrated. 16mo., cloth, 104 pp. (No. 68 Van Nostrand's Science Series.)..50 cents.
- Electricity in Mining. Illustrated. 8vo., cloth, 385 pp.... \$3.50
- WATT, ALEXANDER. Electroplating and Refining of Metals. *New Edition, rewritten by Arnold Philip.* Illustrated. 8vo., cloth, 704 pp.....Net, \$4.50
- Electro-metallurgy. *Fifteenth Edition.* Illustrated. 12mo., cloth, 225 pp.....\$1.00
- WEBB, H. L. A Practical Guide to the Testing of Insulated Wires and Cables. *Fifth Edition.* Illustrated. 12mo., cloth., 118 pp...\$1.00
- WEYMOUTH, F. MARTEN. Drum Armatures and Commutators. (Theory and Practice.) A complete treatise on the theory and construction of drum-winding, and of commutators for closed-coil armatures, together with a full résumé of some of the principal points involved in their design, and an exposition of armature reactions and sparking. Illustrated. 8vo., cloth, 295 pp.....Net, \$3.00
- WILKINSON, H. D. Submarine Cable-Laying, Repairing, and Testing. *Second Edition, completely revised.* 313 illustrations. 8vo., cloth, 580 pp.....Net, \$6.00
- WRIGHT, J. Testing, Fault Localization and General Hints for Linemen. 19 Illustrations. 16mo., cloth, 88 pp. (Installation Serious Manuals.)  
Net, 50 cents.



- YOUNG, J. ELTON.** Electrical Testing for Telegraph Engineers. Illustrated. Svo., cloth, 264 pp.....Net, \$4.00
- ZEIDLER, J., and LUSTGARTEN, J.** Electric Arc Lamps: Their Principles, Construction and Working. 160 Illustrations. Svo., cloth, 188 pp.....Net, \$2.00



**A 96-page Catalog of Books on Electricity, classified by subjects, will be furnished gratis, postage prepaid, on application.**

# D. VAN NOSTRAND COMPANY

---

are prepared to supply, either from  
their complete stock or at  
short notice,

## Any Technical or Scientific Book

In addition to publishing a very large and varied number of SCIENTIFIC AND ENGINEERING BOOKS, D. Van Nostrand Company have on hand the largest assortment in the United States of such books issued by American and foreign publishers.

---

All inquiries are cheerfully and carefully answered and complete catalogs sent free on request.



THIS BOOK IS DUE ON THE LAST DATE  
STAMPED BELOW

AN INITIAL FINE OF 25 CENTS  
WILL BE ASSESSED FOR FAILURE TO RETURN  
THIS BOOK ON THE DATE DUE. THE PENALTY  
WILL INCREASE TO 50 CENTS ON THE FOURTH  
DAY AND TO \$1.00 ON THE SEVENTH DAY  
OVERDUE.

NOV 12 1941	
NOV 13 1941 M	REC'D LD
2 Aug 52 HL	MAR 5 1958
JUL 19 1952	
<i>Pacific</i>	
INTER-LIBRARY LOAN	
OCT 27 54	
NOV	APR 09 1989
18 Mar 58 AR	
IN STACKS	
MAR 5 1958	
JAN 17 1989	
CIRCULATION	LD 21-100m-7,'40 (6936s)

page to  
300 m

U.C. BERKELEY LIBRARIE



C006769267

TK5261

321586

H3

Hausmann

UNIVERSITY OF CALIFORNIA LIBRARY

