

TELEPHONE

HAND-BOOK.



Harry O. Kellogg,  
Cleveland,  
Ohio.

July 29, 1899

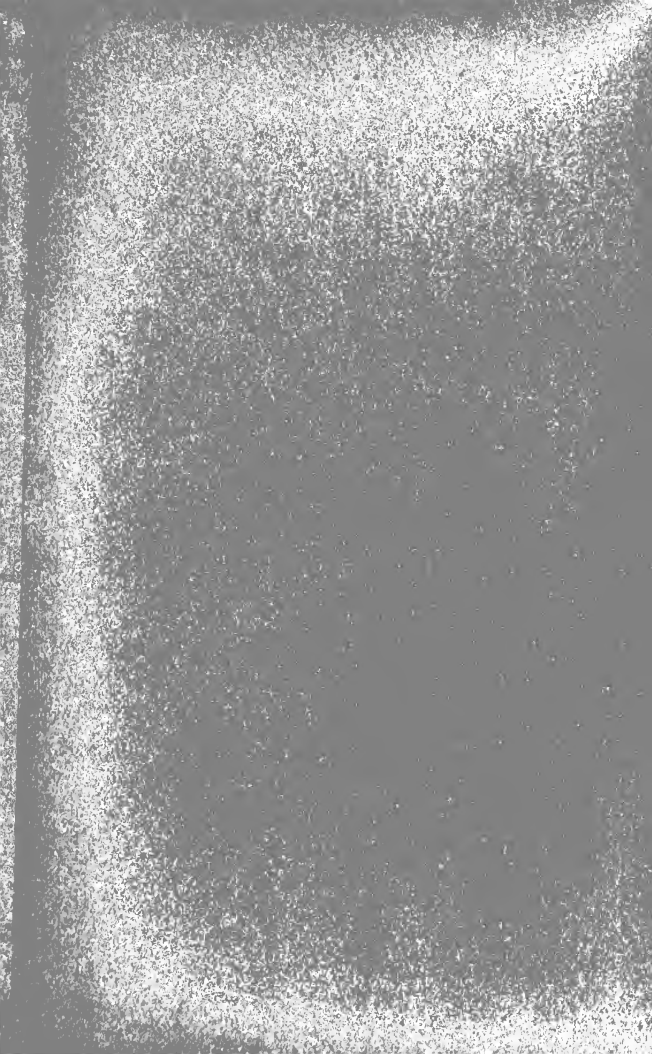

THE  
TELEPHONE HAND-BOOK

BY

HERBERT LAWS WEBB.

*Member of the American Institute of Electrical Engineers  
and of the Institution of Electrical Engineers, London*

*Author of "A Practical Guide to the Testing of  
Insulated Wires and Cables."*

—  
NEW EDITION.  
—

ELECTRICIAN PUBLISHING COMPANY,  
CHICAGO, ILL.

1899.

COPYRIGHT, 1894,  
BY  
ELECTRICIAN PUBLISHING COMPANY,  
CHICAGO, ILL.

---

ALL RIGHTS RESERVED.

# PREFACE.

---

This little book has no pretension to be considered a complete treatise on telephony as it exists in America. The time for such a work is not yet come. But it is felt that there is a demand for a practical book on telephone working and management, and THE TELEPHONE HAND-BOOK is an attempt at meeting that demand. With the exception of a few chapters dealing with certain forms of transmitters and receivers used in Europe, which are given for the information of those who are unfamiliar with other types of instruments than those used in this country, the book is based entirely on standard American practice; and most of the material, apparatus and methods described are peculiar to or have originated in this country.

With the illustrations no time nor trouble has been spared to make them clear and intelligible, and of real service to the reader. The great majority of them have been executed especially for the book; quite a number have never been published before, others have appeared in the *Electrical Engineer* and *Electrical Review*, generally in connection with my own articles. These latter have been re-drawn from the original material wherever possible.

As this is the first practical book on American telephone methods, sins of commission and omission will no doubt be met with in its pages. Any suggestions or corrections, which may be addressed to the care of the publishers, will be received in a spirit of due modesty and thankfulness.

H. L. W.

*New York, August, 1894.*





# CONTENTS.

CHAPTER.	PAGE.
1. The Invention of the Telephone .....	1
2. Sound Waves. Articulate Speech.....	2
3. Electric Telephony. The Bell Telephone .....	6
4. The Microphone.....	9
5. Current Induction. Electromagnetic Induction.....	14
6. The Induction Coil; Its Use in the Telephone Transmitter .....	16
7. The Complete Telephone Circuit.....	19
8. Magnet Telephones .....	21
9. The Bell Telephone Receiver.....	22
10. Other Forms of Magnet Telephones.....	25
11. The Gower, Ader and D'Arsonval Receivers. Mercadier's Head Receiver.....	27
12. The Siemens, Kotyra, Neumayer and Böttcher Receivers .....	31
13. Carbon Transmitters.....	35
14. The Blake Transmitter.....	36
15. The Long-distance Transmitter .....	39
16. The Solid-back Transmitter.....	43
17. The Berliner Transmitter .....	47
18. The Cuttriss Transmitter.....	51
19. Various European Transmitters.....	52
20. The Efficiency of Telephone Transmitters.....	58
21. Batteries for Telephone Work .....	60
22. Open Circuit Batteries.....	64
23. Closed Circuit Batteries .....	67
24. The Practical Management of Batteries.....	69
25. Magneto Bells .....	74
26. Automatic Switches.....	79
27. Telephone Line Construction.....	84
28. Metallic Circuits .....	89
29. Underground Wires.....	93
30. Lightning Arresters.....	99
31. Inside Wiring .....	103
32. Installation of Telephones .....	104
33. Inspection and Maintenance .....	106
34. The Condenser; Its Use in Telephony .....	112
35. Electromagnetic Retardation .....	114
36. Exchange Working.....	115
37. Small Exchanges.....	124
38. Party Lines. The Bridging Bell.....	126
39. Long Distance Telephony .....	131
40. Duplex Telephony .....	135
41. Simultaneous Telegraphy and Telephony.....	136
42. Recent Progress.....	139
Appendix .....	153
Index .....	156



# TELEPHONE HAND-BOOK.

## CHAPTER I.

### THE INVENTION OF THE TELEPHONE.

1. The speaking telephone came into existence in 1876, just eighteen years before these pages issue from the press. Prior to that time many inventors and experimenters had dabbled with the problem of transmitting sound to a distance; but Alexander Graham Bell actually solved it, and gave to the world the magnetic telephone, the foundation of the science and art of telephony.

2. Mechanical telephones, effecting the transmission of sounds by means of wooden rods and stretched strings or wires, are old, and mention is found of such devices as far back as the seventeenth century. But from the mechanical to the electrical transmission of sound waves is as great a leap as that from the old method of signaling by semaphores and beacon fires to the electric telegraph.

3. In 1837 Prof. Page, of Salem, came near to inventing the magnetic telephone when he discovered that a piece of iron would give out a sound when rapidly magnetized and demagnetized. This phenomenon, commonly called "Page's effect" (which is utilized to-day in certain forms of push buttons to indicate whether the bells they are connected with actually ring or not), was the subject of further experiments by others, but led to nothing in the direction of telephony.

4. In 1854 C. Bourseul, a Frenchman, came even nearer than Page by experimenting with a vibratory disk arranged so as to interrupt a battery current and operate another disk placed at a distance. Bourseul did not perfect his apparatus, but he got sufficiently encouraging results to prophetically and truthfully remark that he "felt certain that in a more or less distant future speech will be transmitted by electricity."

5. Philip Reis, a German, also attacked the

problem of producing an electric telephone, and did actually construct, between 1860 and 1870, an instrument, utilizing an interrupted current, that would transmit musical sounds; but he did not succeed in making a telephone that would talk whenever it was wanted to.

6. In the sixties and seventies many scientists in various countries were at work in the direction of the goal which Bell reached in 1876. Professor Elisha Gray, the distinguished inventor of the harmonic telegraph and of the telautograph, ran Professor Bell very close for the honor and glory of inventing a practical, articulating telephone, and so closely did Gray's inventions correspond with those of Bell that the patents of both were eventually taken up by the company formed to exploit the Bell telephone.

7. With Professor Bell's invention, which gave to the world the true method of electric transmission of speech and the most efficient instrument for utilizing the method, the practical science of telephony began. The lucky inventor secured patents not only on the instrument, but also on the method of transmission. Of these patents, the control of which has given the American Bell Telephone company such an impregnable monopoly, one expired, in March, 1893, and the other in January, 1894.

---

## CHAPTER II.

### SOUND WAVES. ARTICULATE SPEECH.

8. Sound waves are produced in the air by the vibrations set up by any source of sound. The molecules, or particles of air, are thrown into a state of vibratory movement, and this movement is passed on from molecule to molecule until it finally dies out through friction. Sound waves are communicated from the air to other materials, and the most dense substances are capable of responding to the vibrations set up in the air by sound waves and producing similar vibrations. Thus, a long wooden rod will be thrown into a state of vibration along its whole length by a sound made at one end, and the sound can be distinctly heard at the other end. Similarly,

if a disk or diaphragm of metal, wood or parchment be attached to each end of a tightly stretched string, sounds made in front of one of the diaphragms can be plainly heard at the other, owing to the vibrations set up in the first diaphragm being communicated by the string to the second.

9. Of all kinds of sound waves, those produced by articulate human speech are by far the most complicated. In the production of them the throat, vocal chords, mouth, tongue, teeth and lips all

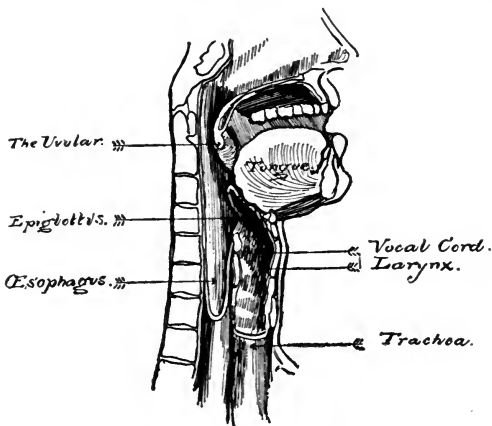

FIG. 1. HUMAN ORGANS OF SPEECH.

enter into play, and the result is not a simple series of waves or vibrations, such as are produced by musical instruments, but an extraordinary combination of extremely rapid vibrations with other vibrations superimposed upon them. Just as no two voices are exactly alike, so do no two persons in speaking produce the same kind of sound waves; and if curves could be drawn showing the form of the sound waves produced by various voices, they would be found to differ from each other with that wonderful variety that we see in faces, although all are made up of the same number of features.

10. It is by the quality, or *timbre*, that we distinguish the voices of different individuals, and in addition to *timbre*, the waves produced by articulate speech have the characteristics of *pitch* which depends on the number of vibrations per second, and *loudness*, which depends on the size of the vibrations. Thus, two tuning forks both of the same *pitch* will both give out the same note when struck, their rate of vibration being the same; but if one is much larger than the other, its vibrations will be bigger and the sound produced will consequently be louder.

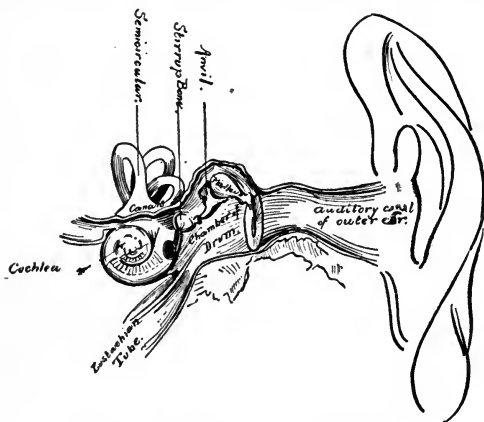

FIG. 2. SECTION OF HUMAN EAR.

11. The human organs of speech contain every appliance necessary for setting up vibrations of widely varying rate, for increasing or diminishing the size of the vibrations and for impressing on the vibrations that produce the prime sounds the necessary secondary vibrations to give the *timbre* or inflection requisite to form articulate speech. In the speaking of a single vowel or consonant all these different elements are called into action, and the vibrations set up number thousands per second, and of course are of the greatest possible delicacy.

12. To receive these complex and excessively rapid

vibrations and convey them to the brain the human organism is provided with a sensitive apparatus called the ear, in which there is much more than meets the eye of the casual observer. The tympanum, or drum,

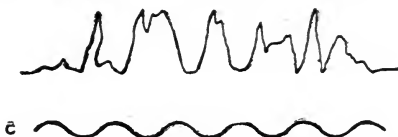

FIG. 3. WAVES PRODUCED BY ARTICULATE SPEECH AND SIMPLE NOTE.

of the ear is the diaphragm that takes up the vibrations of the waves. Attached to the tympanum, which is a sort of membrane tautly stretched across the inner part of the ear, is a chain of three delicate little bones called the stirrup, the mallet and the anvil. These bones are connected to the brain by nerves, and the sounds which impinge on the tym-

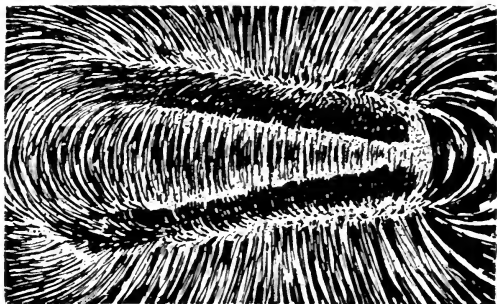

FIG. 4. MAGNETIC FIELD.

panum are transmitted to the brain by the chain of little bones and the nerves. See Figs. 1 and 2.

13. This fragmentary little sketch of the complexity of human speech and of the delicacy of the natural apparatus provided for its production and

reception is given not merely for the sake of giving it, and of following the custom of writing introductory chapters of an elementary nature, but because it has an important bearing on practical telephony. It shows that the problem of forming a connecting link through a wire between the voice and the ear was one of remarkable difficulty, of such apparent hopelessness that most men, looking at it from this point of view eighteen years ago, would have pro-

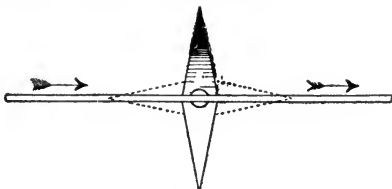

FIG. 5. ACTION OF CURRENT ON MAGNET. DOTTED LINES SHOW NORMAL POSITION OF MAGNET.

nounced its solution impossible. The solution was found, however, and for the last seventeen years articulate speech has been transmitted along wires by means of electricity. Those engaged in providing for its transmission should always bear in mind the complexity of the organs of speech and hearing, and the delicacy of the sound waves they have to deal with, and should remember that the best possible work is not too good for telephony. It is the opinion of one of the most experienced telephone engineers in the country that every telephone man should know something of acoustics and of anatomy, and that such knowledge will help him in his work by giving him a greater interest in it, besides giving him many a useful hint as to the importance of attention to detail.

### CHAPTER III.

#### ELECTRIC TELEPHONY. THE BELL TELEPHONE.

14. The transmission of sound by electricity is effected by means of undulatory currents; that is, currents continuously varying in strength and direction. A sound wave produced by articulate speech may be represented by a wavy line now bending up



and now downward, and with an infinite number of little humps and bumps at all parts of the main curves. In order, then, to reproduce such waves by means of electric currents, it is necessary to transmit currents having similar undulations and similar minute humps and bumps, and having also the same rapid variation of undulations that are present in the sound waves. See Fig. 3.

15. The intimate relation between magnetism and electricity provides a means for producing these undulatory currents in the simplest possible manner. A steel magnet produces in its neighborhood what is known as a magnetic field. We imagine the air surrounding the magnet to be permeated by what are called lines of force, which radiate most thickly from the poles. If a wire be moved about within the influence of these lines of force, a current of electricity will be set up in the wire. If the wire be held still in proximity to the magnet and any change take place in the strength of the magnet (causing a change in the lines of force) a current will be set up in the wire. However slight the movement of the wire or the change in the strength of the magnetic field, currents will be set up in the wire. See Figs. 4 and 5.

16. Professor Bell, in the course of his experiments, many of which are of the greatest interest as

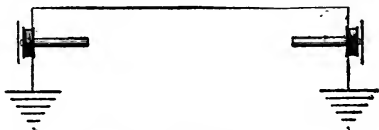

FIG. 6. SIMPLE TELEPHONIC CIRCUIT.

showing the development of the electric speaking telephone, arrived at this combination. He took a steel bar magnet and placed at one end of it a spool wound with very fine insulated copper wire. In front of the end of the magnet, and very close to it, he placed a diaphragm of thin sheet iron. The ends of the coil of copper wire were connected to two line wires, which at their distant ends were joined to the coil of a similar arrangement. The diaphragm, on being thrown into a state of vibration by the sound

waves produced near it, caused a succession of rapid changes to take place in the magnetic field surrounding the coil of wire, thus setting up currents in the coil. As the changes in the magnetic field corresponded exactly to the vibrations of the diaphragm, which in turn were identical with the sonorous vibrations communicated to it through the air, the electric currents produced in the coil necessarily corresponded in all particulars to the sound waves. Consequently, these currents being transmitted along the line wire to the distant coil produced changes in the magnetic field there similar to the changes which produced them, resulting in a vibratory movement of the diaphragm, which, setting in motion the surrounding air, caused the reproduction of the sound waves communicated to the first diaphragm. See Fig. 6.

17. A reference to the field of the Bell telephone, as shown in the diagram, Fig. 7, will help to make

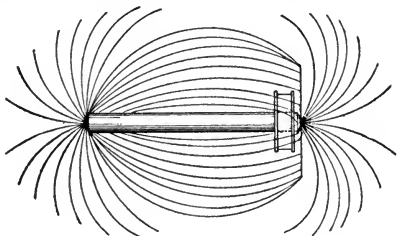

FIG. 7. FIELD OF BELL TELEPHONE.

clear the following description of the theory of its action, and also to emphasize some practical points in connection with magnet telephones. The diaphragm, being placed close to the magnet, becomes magnetized, and, as it were, part of the magnet itself, and the lines of force spread from the diaphragm back to the magnet, some of them passing through the coil. When the diaphragm is set in vibration by the sound waves directed to it, the lines of force are disturbed or distorted and the effect is to produce minute currents of electricity in the coil. It is probable that a movement of the diaphragm toward the magnet strengthens the part of the field in which

the coil is situated and condenses, as it were, the lines of force in that neighborhood, causing a current of one direction to be set up in the coil, while a movement of the diaphragm away from the magnet weakens that part of the field, spreading out the lines of force, and produces a current of opposite direction. This explanation is not held by many to contain the whole theory of the action of the Bell telephone, as it is considered that the effects produced in the transmission of speech are too remarkable to be accounted for by the very feeble currents that can be generated in such a way. Researches by various scientists indicate that there is also molecular disturbance in the diaphragm and magnet, which in part accounts for the wonderful efficiency of the transmission.

18. Considering, however, solely the theory just explained, we see that to get good transmission we need: (1) a powerful magnet, so as to have a strong magnetic field; (2) a diaphragm capable of vibrating freely, so as to cause a wide range of variation in the distribution of the lines of force; (3) a wide, shallow coil, so as to place as much of the wire as possible within the influence of the lines of force that are subject to variation by the movement of the diaphragm. These points are worth bearing in mind in the construction of magnetic telephones.

---

## CHAPTER IV.

### THE MICROPHONE.

19. When the wonderful invention of Bell's telephone became widely known other inventors set to work to devise electric speaking telephones on different principles, either with the object of eluding Bell's patent, or in order to transmit speech with greater effect. Professor Bell was so fortunate as to secure a patent on the *method* of transmitting articulate speech by means of undulatory electric currents, and as it has not been possible to devise any other electrical substitute for sound waves, this patent has upheld the Bell company in its impregnable position. But although the Bell telephone has served as the key to the telephone

monopoly it did not prove to be an efficient transmitter for lines of any considerable length, and it is unquestionable that the battery or microphone transmitter was one of the principal factors in rendering telephone communication a commercial success.

20. Count du Moncel, the eminent French scientist, discovered long before the invention of the battery transmitter that the resistance of two conductors in contact with each other varied in accordance with the variation of pressure at the point of contact. This phenomenon must have been a familiar one to electricians from the earliest times, as everyone knows that a binding post loosely screwed down is liable to introduce extra resistance into the circuit, and that in open circuit telegraph working the key must be firmly pressed down to get good signals. But practical applications of it prior to the invention of the telephone were scarcely thought of, although it is true that M. Clerac, an official of the French telegraph service, constructed in 1866 a variable resistance by putting carbon in a tube so that it could be compressed from the ends. This combination is used to-day in rheostats, or variable resistances, for various purposes.

21. It so happens that carbon is the substance that exhibits to a most marked degree the property of change of electrical resistance with change in the pressure at the point of contact, and Edison directed his attention to this in his experiments for the production of a telephone transmitter that would talk louder than Bell's magnet telephone. As a result of extended experiments on various kinds of semi-conductors, Edison devised in 1878 a form of carbon transmitter shown in Fig. 8. It consisted of a small disk of compressed lamp black placed between two conducting metal plates, one of which carried a button of bone or ivory which pressed against the diaphragm of the instrument. The carbon disk was placed in the circuit by connecting wires to the upper metal plate and to the metal case of the instrument, in metallic connection with the lower plate through the adjusting screw. When the current from a battery was passed through this instrument the changes in pressure on the carbon disk brought about by the vibration of the diaphragm, causing

corresponding changes in the resistance of the carbon, transformed the steady current into one having an undulatory character, and it was found that this transmitter connected to a Bell telephone as a receiver gave clearer articulation, and much greater

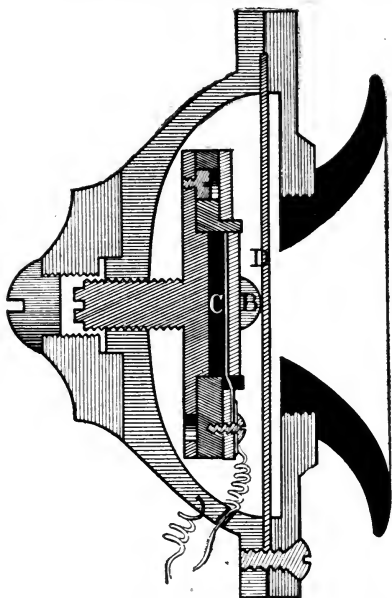

FIG. 8. EDISON CARBON TRANSMITTER. *C* CARBON DISK, *B* BUTTON, *D* DIAPHRAGM.

volume of sound, than was obtained by using a Bell instrument as a transmitter.

22. Professor Hughes, the famous Anglo-American electrician, who is one of the cleverest experimenters in the electrical world, took up the subject of the variable resistance in contacts between conductors. He established the principle that in order to obtain the maximum effect the contact must be a

*loose* one. Working on these lines he produced an instrument which he called the microphone, because he considered that it accomplished in acoustics what the microscope does in optics. It is a notable feature of Professor Hughes' experiments that he produces the most beautiful effects with the simplest possible means. His apparatus is generally made up of cigar boxes, wire nails and similar every-day materials. A very efficient form of microphone was devised by him as shown in Fig. 9. Two wire nails inserted in a circuit containing a battery and a Bell telephone were bridged across by a third nail. The

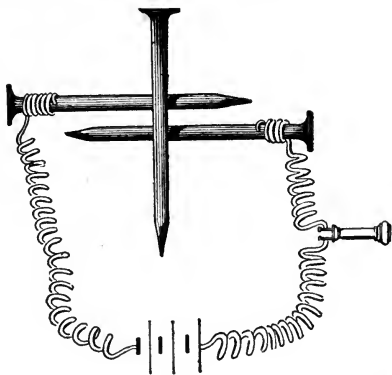

FIG. 9. HUGHES WIRE NAIL MICROPHONE.

sound of a watch or a clock ticking in the neighborhood of the nails was heard distinctly in the telephone, and even sounds of the voice could be heard. In Fig. 10 is shown a much more delicate microphone, formed by a stick of carbon with pointed ends bearing in two carbon blocks. This arrangement, attached to a sounding board, or diaphragm, of thin wood, as shown in Fig. 11, made a most perfect telephonic transmitter, capable of making the most feeble sounds imaginable quite audible in the receiver connected in the circuit.

23. These experiments on the microphone showed that for a telephone transmitter made with a carbon

disk or button a most important point was that the contact should be a *loose* one, and that the initial pressure brought to bear on the carbon should be as

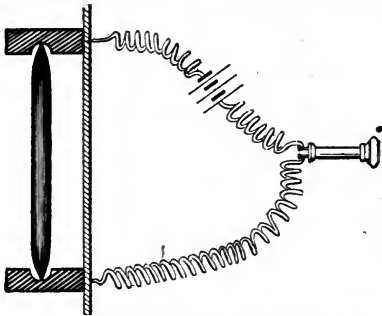

FIG. 10. HUGHES CARBON MICROPHONE.

light as possible. Hughes did not patent his invention, but carbon transmitters constructed on the principle that he discovered were patented in various countries. Every conceivable variation was made

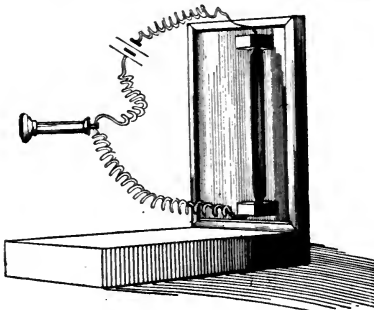

FIG. 11. HUGHES CARBON MICROPHONE, WITH DIAPHRAGM.

on the original microphone, and carbon pencils, rods, disks and buttons were employed singly, in series, in multiple arc, and in all manner of combinations. In this country the Blake instrument with loose contact

(to be described later) soon superseded the Edison, and has been for years the standard transmitter for local service.

## CHAPTER V.

### CURRENT INDUCTION. ELECTRO-MAGNETIC INDUCTION.

24. When a conductor through which a current is passing is approached to another conductor a current will appear in the latter. This effect is called induction, or, more correctly, current or electro-dynamic induction, and is utilized in various ways in the applications of electricity. There are various points to be remembered in connection with current induction between wire and wire. These can be explained by reference to the accompanying diagram, Fig. 12, which shows two circuits, one composed of

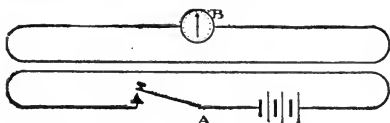

FIG. 12. CURRENT INDUCTION.

a wire connected to a battery through a key, the other a wire connected to a magnetic telephone. We will call the first, or inducing circuit, *A*, and the second, or induced circuit, *B*.

25. At the moment of closing the circuit *A* a current is induced in *B*. This current is only momentary, and no further effect is produced in *B* if the current is kept flowing with the same strength in *A*. The momentary induced current in *B* is always of the opposite direction to that of the current flowing in *A*. If in *B* we insert a galvanometer instead of a telephone, and change the ends of the circuit *A* so as to reverse their connection to the poles of the battery, each change will produce a deflection of the galvanometer needle opposite to the previous one. When the circuit *A* is broken and the current interrupted another momentary induced current appears in *B*, this time in the reverse direction to that produced by closing the circuit. So



that if we successively close and open the circuit *A* we shall produce a succession of currents of reverse directions in the circuit *B*.

26. If we keep the circuit *A* closed but insert in it a resistance that we can vary at will, then by increasing and diminishing this resistance we can produce currents of opposite directions in *B*. A sudden decrease in the resistance of *A* induces a current in *B* of the opposite direction to that flowing in *A*, while a sudden increase in the resistance of *A* induces in *B* a current of the same direction.

27. If we keep the circuit *A* closed but move it bodily nearer to *B*, we induce a current in *B* of the opposite direction to that flowing in *A*, and if we move it away from *B* we induce in *B* a current in the same direction.

28. If *A* is made of thick wire and *B* of thin wire, the electromotive force, or pressure, of the currents induced in *B* will be higher than the original electromotive force acting on *A*. Conversely, if *A* be the thinner wire and *B* the thicker, the currents induced in *B* will have a lower electromotive force than that acting on the circuit *A*.

29. In practice it is usual to call *A* the primary wire, or circuit, and *B* the secondary wire, or circuit. Using these terms we will sum up what has been already explained as follows:

(1) The appearance of a current in the primary wire induces a current in the secondary wire in the *opposite* direction.

(2) The interruption of the current in the primary wire induces a current in the secondary wire in the *same* direction.

(3) A decrease of resistance in the primary circuit induces in the secondary circuit a current in the *opposite* direction.

(4) An increase of resistance in the primary circuit induces in the secondary circuit a current of the same direction. (Of course a decrease of the resistance in the primary circuit is equivalent to an increase in the strength of the current flowing therein, and *vice versa*, so that an increase in the strength of the primary current will produce the same result in the secondary circuit as a decrease of resistance).

(5) A movement of the primary circuit toward the

secondary will induce in the secondary a current of opposite direction.

(6) A movement of the primary away from the secondary will induce in the secondary a current in the same direction.

(7) By making the primary of thick and the secondary of thin wire the electromotive force of the induced currents will be higher than that of the primary current.

(8) By making the primary of thin and the secondary of thick wire the electromotive force of the induced currents will be lower than that of the primary.

30. Electromagnetic induction is strongly akin to electro-dynamic, or current, induction, the principles of which we have just examined. If we move a magnet in the neighborhood of a wire a current is induced in the wire. By approaching one pole of the magnet to the wire we get a current of one direction, and by approaching the other pole one of opposite direction. Similarly, if we bring a wire in which a current is flowing near to a magnet suspended by a thread or supported on a pivot, we cause a movement of the magnet, and by reversing the direction of the current in the wire we reverse the movement of the magnet (see Fig. 5). If we surround an iron bar with turns of wire and send a current through the wire, we cause the bar to become a magnet, and as long as the current is kept flowing the bar will exhibit the properties of a permanent steel magnet; but it becomes inert again the moment the current is interrupted.

---

## CHAPTER VI.

### THE INDUCTION COIL. ITS USE IN THE TELEPHONE TRANSMITTER.

31. In the course of Edison's experiments with carbon transmitters he found that by making his variable carbon resistance part of a *primary* circuit, including a battery and a coil of thick wire, and causing this coil to induce currents in a *secondary* coil of thin wire the ends of which were connected to the line, he got very much better effects than with

the battery and variable resistance in the main circuit.

32. This was quite an important discovery, and the induction coil has since formed an indispensable part of almost all battery telephone transmitters. A reference to the diagram, Fig. 13, will help to explain this arrangement. It will be seen that there is an entirely separate or local circuit made up of the carbon resistance, the thick, or primary wire, of the induction coil and the battery. The ends of the fine, or secondary wire, of the induction coil are connected to the line and, consequently, to the receiver at the distant station. Edison found that by making the primary circuit of very low resistance, using a comparatively few turns of thick wire in the primary

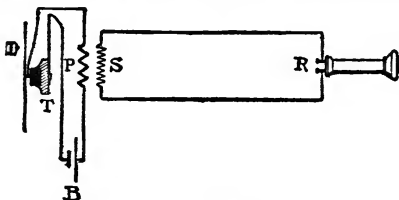

FIG. 13. DIAGRAM OF TRANSMITTER. *D* DIAPHRAGM, *T* VARIABLE RESISTANCE, *B* BATTERY, *P* PRIMARY OF INDUCTION COIL, *S* SECONDARY, *R* RECEIVER.

coil, and a large number of turns of much thinner wire in the secondary coil the effects of the variation of resistance in the primary circuit were much magnified or intensified in the induced currents set up in the secondary coil. These induced currents being sent out to line resulted in a much more effective transmission than had before been achieved.

33. From what has been said in the foregoing chapter, it will easily be understood why the induction coil works so well in telephony. We know that changes of resistance (equivalent to changes in the strength of the current) in the primary circuit induce currents in the secondary circuit, and we know that with a thick primary and thin secondary wire induced currents of increased electromotive force result. Now, if in our telephone transmitter we produce the varia-

tions of resistance in a primary circuit having a very low resistance to begin with, we effect the maximum range of variation in the strength of the current flowing in that circuit. These variations are faithfully transmitted to the secondary coil by the currents they induce in it, and as the secondary coil is of fine wire there is the additional effect that the induced currents are of high electromotive force, and therefore capable of overcoming a greater resistance in the line and producing more sensible effects in the receiver than the battery current possibly could.

34. The construction of the induction coil is shown in Fig. 14. It was found that the effects of current induction are increased if the coils are wound on an iron core made of a bundle of fine iron wires. The iron is magnetized and demagnetized under the action of the current, and as the relations between magnetism and electricity are at all points so intimate, it is not at all surprising that the presence of the magnetic field set up by the magnetism of the iron core by the current in the primary coil should have a reflex influence on the inductive effect of the primary coil on the secondary. This reflex action is of considerable

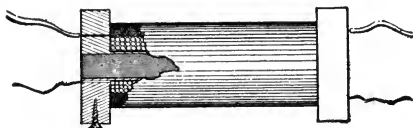
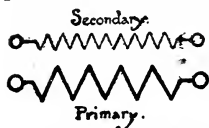

FIG. 14. INDUCTION COIL.

importance to the results produced by the coil, and it is still further increased if the coil be inclosed in an iron box.

35 The usual form of induction coil, as shown in Fig. 14, consists of a number of turns of coarse insulated copper wire wound on a spool through the centre of which is passed a bundle of fine soft iron wires. The magnetic core of the induction coil is made in this way because the iron in a divided state loses and gains its magnetism under the influence of the current much more rapidly than would a solid bar of iron; with the bundles of wire the changes in magnetization are more abrupt—

crisper, as it were—while a solid rod would be slower to become magnetized and slower to reverse or lose its magnetism, rendering the action of the coil sluggish. Over the winding of coarse wire, which is the primary of the induction coil, is placed an insulating covering of silk or paraffined paper, and above this is wound



a large number of turns of much finer insulated copper wire, which constitutes the secondary winding.

36. A great deal of experimenting has been done to determine the most suitable forms of induction coils for different

kinds of transmitters, and probably a great deal has yet to be done in this direction, as the induction coil is a most important part of the telephone circuit as long as carbon transmitters remain in use. With the Blake transmitters the resistances of the windings of the induction coil generally used are, for the primary coil, about .5 ohm, and for the secondary about 250 ohms. About 180 turns of No. 23 B. W. G. wire are used for the primary, and over 4,000 turns of No. 28 B. W. G. for the secondary.

37. For other types of transmitters, and especially for those used for speaking over very long circuits, induction coils of widely different proportions have been devised. In these coils special attention has been paid to the question of the magnetic effect of the core and of reinforcing this effect by greatly lengthening the coil and core and enclosing the coil in an iron box or cylinder. With coils of this design quite good results are obtained with 14 ohms resistance in the secondary winding and about .4 ohm in the primary. Fig. 15 shows the conventional drawing used to represent an induction coil in diagrams of telephone circuits.

## CHAPTER VII.

### THE COMPLETE TELEPHONE CIRCUIT.

38. We have already discussed the theory and principle of the electric telephone, the microphone transmitter, and of the induction coil as applied to telephony. The accompanying diagram, Fig. 16,

shows clearly the different elements in the speaking circuits of a telephone line and their relative arrangement. Each station has a transmitter, consisting of a variable resistance connected in circuit with a battery and the primary winding of an induction coil: an induction coil, the secondary winding of which is connected to the line, and a receiver, consisting of a Bell telephone, which is connected in series with the line wire and the secondary winding of the induction coil.

39. It will be noticed that the variable resistance of the transmitter, which is acted on by the sound waves directed to the transmitter diaphragm, the battery and the primary winding of the induction coil form an entirely local circuit having no metallic connection with the line wire. The actual circuit through which the voice currents travel consists of the secondary windings of the two induction coils

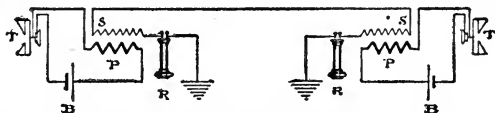

FIG. 16. DIAGRAM OF COMPLETE TELEPHONE CIRCUIT.  
*T* TRANSMITTER, *B* BATTERY, *P* PRIMARY,  
*S* SECONDARY, *R* RECEIVER.

and the two receivers. From this it is evident that at all times there are two coils in the circuit that are for the moment useless, the receiver at the speaking end and the secondary of the induction coil at the receiving end, and as extra resistance of course tends to lower the quality of transmission, arrangements have been proposed for the purpose of cutting out the secondary winding of the induction coil at the listening end and the receiver at the speaking end. But in conversation the listener changes so often into the speaker, that in practice even the handiest form of switch for such a purpose soon becomes a nuisance, and such devices are only used on long-distance instruments, where a button is provided for short-circuiting the secondary coil when listening. For short-distance work it is found better to put up with the extra resistance and retain the

simplicity of action of the ordinary telephone instrument.

40. The fact that the receivers are always in series is found to be rather a convenience in testing the condition of the primary circuit of a telephone set, as by the amount of "side tone" obtained in the receiver by talking to or tapping on the transmitter, the state of the battery, transmitter, contacts, etc., can, with a little practice, easily be gauged.

41. In this chapter we have been considering simply the elements of the talking circuit of a telephone line. The signaling apparatus, or call bells, will be treated of later.

---

## CHAPTER VIII.

### MAGNET TELEPHONES.

42. All magnet telephones—that is, telephones employing permanent magnets and iron diaphragms—are simply variations of the original Bell instrument. The Bell telephone even in its simplest form is a most wonderfully sensitive instrument. Many experiments have been made with a view to determining exactly how sensitive it is, or what is the minimum amount of current that will produce a sound in the telephone. Mr. Preece has found that an ordinary receiver will respond to a current of six ten-thousand-millionths of a milliampere. In other words, the current absorbed by a sixteen candle power incandescent lamp would be sufficient, if subdivided into such minute currents, of producing sounds in thirty billion telephones. It is obvious that nothing remains to be done in the way of improving the delicacy of such an inconceivably sensitive instrument. It is the opinion of Professor Silvanus P. Thompson that we ought, on the contrary, to use less sensitive receivers and more powerful transmitters. Such receivers, he argues, would be less responsive to foreign currents that invade telephone lines, and would still be operated by the voice currents from powerful transmitters. This suggestion has not been adopted, as, although more powerful transmitters have been introduced from time to time, no use has been made of less sensitive receivers.

43. The modifications that have been made in the

Bell telephone have been in the direction of making it more powerful, so as to enable it to reproduce more clearly the delicate overtones, or timbre vibrations of the human voice, and to give louder and more distinct articulation generally. Any modifications that can be made in such a simple instrument are obviously limited to very few directions. The magnetic field can be strengthened by using a stronger permanent magnet; the amount of wire in the coil under the influence of the magnetic lines of force can be increased, and the diaphragm can be made more responsive to vibrations, and its vibrations productive of greater effect on the coil. This last naturally follows from strengthening the field, because, as the diaphragm is magnetized by induction from the magnet, a stronger magnet will magnify the effect of the vibrations of the diaphragm on the coil. Any alteration in the thickness of the diaphragm with the idea of rendering it more responsive to vibrations has practically no effect. Indeed, it has been found that telephones will speak well even with diaphragms several inches thick, and this lends considerable weight to the theory that molecular disturbance plays an important part in the action of the telephone. We find, then, that modifications of the magnet telephone are practically limited to the magnet and the coil, and it is in this direction that improvements have been made, as we shall presently see.

---

## CHAPTER IX.

### THE BELL TELEPHONE RECEIVER.

44. It was a very short time after the invention of the telephone that the Bell instrument developed into the form in which it is so well known in this country. The early forms, as we know, were made with a horseshoe magnet attached to a baseboard, the diaphragm placed upright opposite the poles, and a mouthpiece mounted in front of the diaphragm.

45. It was found that a large air chamber between the mouthpiece and the diaphragm rendered the articulation indistinct, and the first improvement was in the shape of the mouthpiece, and in reducing



the air chamber between the mouthpiece and the diaphragm to very narrow limits. The best results were obtained by giving the mouthpiece a very narrow orifice, procuring a thin layer of air between the diaphragm and the cap, with a small opening in the centre of the cap or mouthpiece. This arrange-

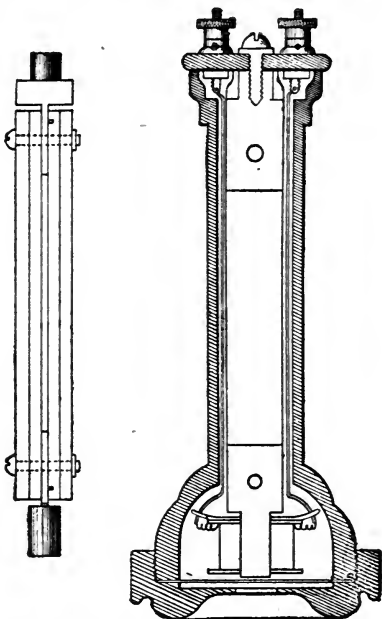

FIG. 18. MAGNET OF SINGLE  
POLE RECEIVER.

FIG. 17. SINGLE POLE  
RECEIVER.

ment gave the sonorous vibrations their maximum effect on the diaphragm; and this is a point to be borne in mind in the construction of magnet telephones.

46. The horseshoe form of magnet was discarded and a bar magnet substituted. This was enclosed in

a case, which protected the magnet and coil, and at the same time served as a handle by which to hold the instrument. So the hand telephone, or receiver, which is used throughout the United States, was evolved. With one exception the modifications that have been made in it during the last sixteen years have been merely in the minor mechanical details and in the improvement of the quality of the materials used. The only attempt to improve the electrical efficiency by any change in the design has been in

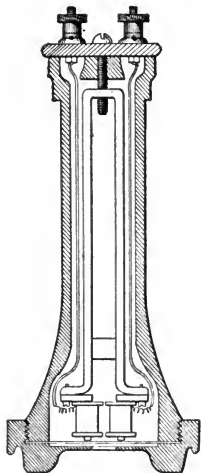

FIG. 19. DOUBLE POLE RECEIVER.

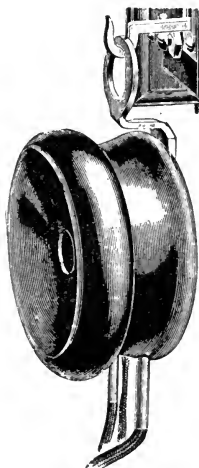

FIG 19 A. WATCH RECEIVER.

the use of magnets presenting two poles to the diaphragm instead of only one. The two-pole receivers are more expensive to make than the single pole, and are not much used by the telephone companies except for long distance work. In all ordinary situations the single pole receiver gives excellent results. If properly made and put together there is no reason why it should not, and any defects in a telephone installation are more likely to be found

in any other part of the equipment than the receiver.

47. The single-pole receiver is shown in Fig. 17. The magnet is made of the best quality of steel. It is  $4\frac{1}{2}$  inches long, and is built up of four strips separately magnetized (Fig. 18). It should hold up a weight of 16 ounces. At one end is fitted a soft iron pole piece to hold the hardwood spool on which the coil of insulated copper wire is wound, and at the other a piece of iron threaded for the adjusting screw. The wire generally used is No. 38 B. & S., insulated with silk, and the coil is wound to a resistance of 75



ohms. The diaphragm is  $\frac{1}{100}$  inch thick and about  $2\frac{1}{4}$  inches in diameter. When the dia-

phragm is clamped down by screwing on the mouth-piece its lower surface is about  $\frac{1}{32}$  inch above the surface of the pole of the magnet. The containing case is made of hard rubber. Fig. 19 shows the double pole Bell receiver made with a magnet presenting both poles to the diaphragm, each pole carrying a coil. Each coil is wound to a resistance of 65 ohms, making a total resistance in the double pole receiver of 130 ohms. Fig. 19A shows the "watch" form of receiver used for short line work, and Fig. 19B the operator's head receiver used in exchanges.

FIG. 19 B. OPERATOR'S HEAD TELEPHONE.

## CHAPTER X.

### OTHER FORMS OF MAGNET TELEPHONES.

48. In Europe considerable attention has been paid to modifications or variations of the Bell telephone with the object of producing more powerful instruments than the ordinary hand receiver. As has already been pointed out, practically the only direction that such modifications could take would be a different design of the parts, such as a strengthening of the magnet, because the principle remained the same and was not to be improved upon. A different arrangement of magnet and coil is the feature of

all the various magnetic telephones that have been produced by various experimenters, and it must be confessed that but few of these instruments offer any considerable advantage over the standard receiver

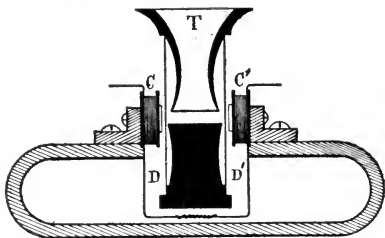

FIG. 20. PHELPS TELEPHONE. *C C'* COILS, *D D'* DIAPHRAGM, *T* MOUTHPIECE.

unless they be intended for use as transmitters, when, of course, a more powerful instrument is desirable. Only a few forms, therefore, such as can be used very effectively for transmitters over lines of moderate length, will be described.

49. In Fig. 20 is shown the form of magnetic tele-

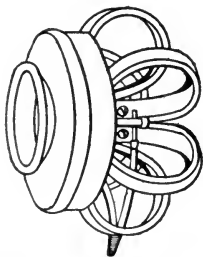

FIG. 21. PHELPS CROWN RECEIVER.

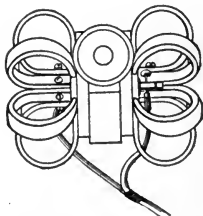

FIG. 22. PHELPS DOUBLE CROWN RECEIVER.

phone designed by the late George M. Phelps in 1878. It is made up of two diaphragms which act on two coils placed on the opposite poles of the same magnet. The idea was that as several telephones connected in series on a line would each articulate

distinctly as receivers, by combining several diaphragms and coils in one instrument a very powerful telephone could be constructed. The telephone shown in Fig. 20 consists of a steel magnet of oblong

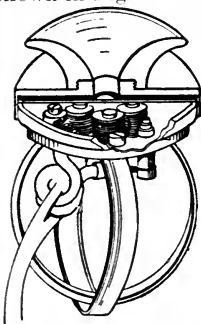

FIG. 23. GOLOUBITZKY TELEPHONE.

form to the poles of which are attached pole pieces carrying the coils. In front of each coil a diaphragm is placed, the space between these diaphragms being partly filled up by a solid block of insulating material and by the mouthpiece, leaving a small air chamber in front of each diaphragm. This telephone gave excellent results, the articulation being loud and clear. The same may be said of the "crown" receivers, shown in Figs. 21 and 22, also invented by Mr. Phelps. In these instruments a number

of steel magnets were arranged in the form of a crown, all the poles of one denomination centering at the iron pole piece carrying the coil and the opposite poles being joined to the rim of the diaphragm.

50. Following up the principle that guided Mr. Phelps in making these instruments, the strengthening of the magnetic field, Goloubitzky put forth in Europe, in 1882, the form of magnet telephone shown in Fig. 23. It has two horseshoe magnets, giving four poles, and consequently creating a strong magnetic field about the diaphragm. The two pairs of coils belonging to the two magnets are connected in series.

51. All of these telephones are capable of giving very good results, but are expensive to construct on account of the number and form of the magnets employed.

## CHAPTER XI.

THE GOWER, ADER AND D'ARSONVAL RECEIVERS.  
MERCADIER'S HEAD RECEIVER.

52. One of the very early modifications of the Bell instrument was that designed by Gower. This is a

very good form of receiver, and has been adopted by the British post office for use in the telephone systems operated by that department. As will be seen by

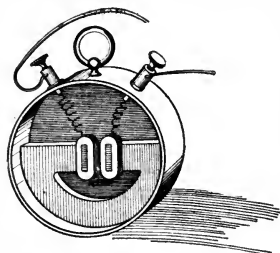

FIG. 24. GOWER RECEIVER.

rubber ring, or gasket, is placed between the diaphragm and the cover to provide the usual air

Figs. 24 and 25, a semi-circular magnet is used, presenting both poles to the diaphragm. The pole pieces that carry the coils are of soft iron and are mounted perpendicularly on the magnet. The magnet is enclosed in a circular brass case, to the inner side of the cover of which, as shown in Fig. 24, the iron diaphragm is attached. A

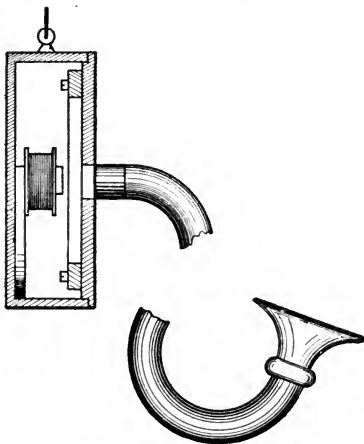

FIG. 25. GOWER RECEIVER.

chamber. To a short tube extending from the center of the cover is attached a piece of ordinary acoustic tubing terminating in an earpiece. The receiver is

not intended to be held in the hand, but is generally fixed underneath the case of the transmitter, one or two of these tubes being provided for listening. (Fig. 25.)

53. The Ader receiver is used almost exclusively in France, and has been adopted to a considerable extent in other continental countries. It is a double-pole instrument, a strong semi-circular magnet being employed. The magnet is nickel plated and serves as a handle. The principal improvement introduced by M. Ader lies in the use of an iron ring placed above the diaphragm. This serves to increase the magnetic induction of the diaphragm by the magnet.

M. Ader calls the ring the "super-exciter." Its effect is based on the principle that the magnetic induction between the magnet and its armature is increased by increasing the mass of the armature, the induction being greatest when magnet and armature are equal in mass. The "super-exciting" effect of the soft iron ring reinforces the magnetic action of the diaphragm and in no way

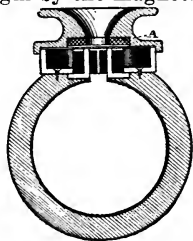

interferes with its vibrations. This form of telephone is a remarkably efficient one. There is no reason why the principle employed should not be carried out a little further by making the entire mouthpiece and cap of soft iron. The iron mouthpiece, of course, would have to be magnetically insulated from the field magnet. Fig. 26 shows a sectional view of the Ader receiver.

FIG. 26. ADER RECEIVER. A SUPER-EXCITER.

54. The D'Arsonval receiver is another double-pole instrument, in which, by an ingenious arrangement, a single coil is completely included in the magnetic field. It should be borne in mind that in double-pole instruments the wire on the coils is only partly within the field created by the magnet. The most intense magnetic field is directly between the two poles, and only the wire on the inner part of each coil is cut by lines of force. Consequently, more than one-half of the wire on each coil is practically wasted as far as induction is concerned, merely serving as a con-

ductor In the D'Arsonval receiver a curved permanent magnet is used, one pole of which terminates

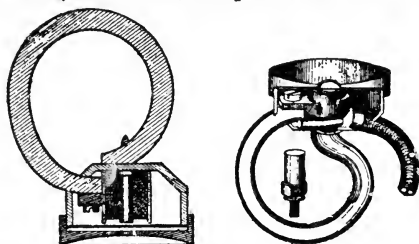

FIGS. 27 AND 28. D'ARSONVAL RECEIVER.

in a soft iron polepiece that serves as the core of the coil, and the other in an iron box, or cylinder, that

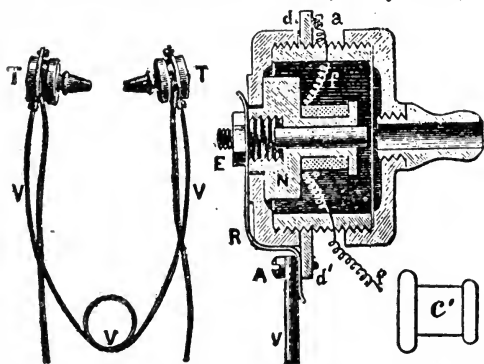

FIG. 29. MERCADIER'S BI-TELEPHONE *T T* RECEIVERS. *V* SPRING, *N* MAGNET, *E* NUT, *R* STEEL STRIP, *A* SCREW CLAMPING *R* TO *V*, *d d'* METAL COLLAR CLAMPING *V* TO RECEIVER CASE, *ff* TERMINALS OF COIL *a* CONNECTING SCREW, *c'* SOFT RUBBER NIPPLE FOR EARPIECE.

completely encloses the coil. The two poles are magnetically insulated from each other by the wooden case, to the upper part of which the diaphragm is



clamped by the mouthpiece in the usual way. Figs. 27 and 28 give a clear representation of this interesting form of telephone. It will be seen that the coil is completely within a concentric magnetic field, and therefore is exposed to maximum induction. As just suggested in reference to the Ader receiver, a soft iron mouthpiece would probably add appreciably to the efficiency of this instrument.

55. The "bi-telephone" designed by M. Mercadier is an ingenious arrangement of head receiver. As shown in the illustration, Fig. 29, it consists of two very small receivers provided with small rubber ear pieces after the manner of a phonograph attachment, and held together by a flexible steel spring. The spring connects the coils of the two receivers in series; it can be magnetized, and then also serves to re-inforce the magnets of the receivers. This instrument gives extremely clear articulation, and is extensively used in France. The small receivers weigh about  $1\frac{1}{2}$  ounces each, and the instrument is not found at all unpleasant by the operators. The illustration shows a general view of the complete instrument and a section of one of the receivers. The outline sketch in the righthand, lower corner shows the form of soft rubber nipple that has given the most satisfaction. The nipple is slipped over the earpiece.

---

## CHAPTER XII.

### THE SIEMENS, KOTYRA, NEUMAYER AND BÖTTCHER RECEIVERS.

56. The Siemens receiver, which is used extensively in Germany, does not differ greatly, except in details of construction, from the double pole Bell receiver used in this country, and it is a more unsightly instrument. A rather wide horseshoe magnet is used having two small steel plates attached at the poles which carry the soft iron pole-pieces, allowing the coils to be brought very close together, as shown in Fig. 30. Two small wooden blocks are forced between the arms of the magnet, and these serve as cleats for the wires from the coils, which terminate at two binding posts on another

block attached to the base plate. Through the base plate and block passes the adjusting screw by means of which the magnet can be raised or lowered in relation to the diaphragm. An iron staple is fixed to the base plate for hanging the receiver up by. The containing case is made of sheet iron with a wooden mouthpiece lined with brass. This is a very efficient form of receiver, and is quite powerful enough to be used as a transmitter. It is

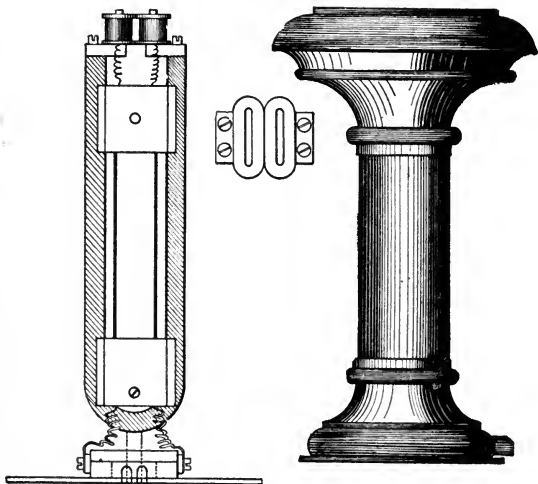

FIGS. 30 AND 31. SIEMENS RECEIVER.

rather an expensive instrument, owing to the numerous parts and different materials employed.

57. One of the main objections to double-pole telephones is the costliness of good horseshoe magnets, which are not easy to make. Kotyra's telephone aims to surmount this difficulty by the device of using a double-pole magnet built up of bar magnets. In Fig. 32 is shown a form of receiver made on this plan, having a horseshoe shaped magnet built up of a number of strips of magnetized

steel in such a manner as to give two separate poles, to which are attached the iron cores of the coils. Another and simpler form is made by building the magnet up of separate strips of different sizes, a much cheaper arrangement than the first. In fact, the horseshoe magnet built up of strips seems rather to defeat the idea of cheapness; but it is claimed that, as no forged pieces are required, such an instrument can be made very cheaply. Building up a magnet of strips of magnetized steel is, moreover, good construction, as such a magnet, commonly called a laminated magnet, retains its strength far longer than a solid one magnetized by a single charge.

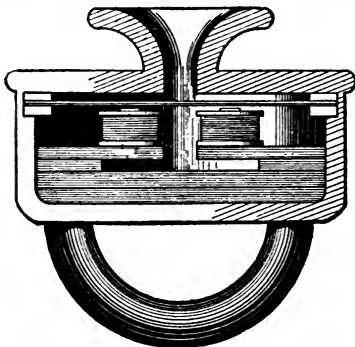

FIG. 32. KOTYRA RECEIVER.

In the instrument shown in Fig. 32 the horseshoe part of the magnet is, of course, made solid with the straight part within the case.

58. The Neumayer receiver is a good modification of the original Bell. The permanent magnet is made up of five steel bar magnets, the lower ends of which touch, and the upper grip a small cylinder of thin brass containing a core made up of a large number of pieces of fine iron wire about  $1\frac{1}{4}$  inches long. This core holds the coil of wire, and is used on the principle already explained in reference to induction coils, that by finely subdividing the iron core the effects of induction are greatly increased. Fig. 33.

which shows a section of the Neumayer instrument, gives a clear representation of its construction.

59. One of the most original forms of magnetic telephone is that designed by Böttcher in 1883. It is quite a powerful instrument and makes an excellent transmitter. Two horseshoe magnets are joined end to end, with their like poles abutting and suspended within a case of thin metal by means of wire loops attached to adjusting screws. The case rests on

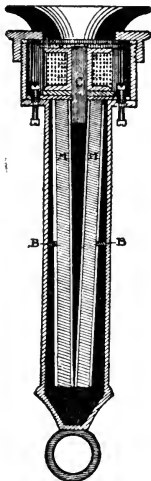

FIG 33 NEUMAYER RECEIVER. *M M* MAGNETS,  
*C* CORE OF FINE IRON WIRES, *B B* COLLAR  
BINDING MAGNETS.

wooden feet. Two coils are used, these being placed over three iron cores attached to the magnets at the junction of the magnets; that is, as originally constructed the instrument has three iron cores within each coil. Probably a single oblong core for each coil would give better results. The iron diaphragm is attached to the case just above the coils, and over the opening above the diaphragm is placed a funnel mouthpiece. By this arrangement of using a sus-

pended magnet, the magnet as well as the diaphragm is rendered capable of being thrown into vibration by the sound waves, thus causing greater changes in the magnetic field, and consequently an increased effect on the coil or coils. Such an instrument, carefully constructed, should make a very good transmitter.

60. The magnetic telephones described in the foregoing chapters form but a small proportion of the army of instruments based on the invention of Professor Bell. They have been described because each one of them is typical of some form of construction or special device offering certain advantages and the various ideas that have been incorporated in them show pretty clearly how much modification the original combination of magnet, coil and diaphragm is capable of with the hope of producing any profitable result.

---

## CHAPTER XIII.

### CARBON TRANSMITTERS.

61. As has already been said, after the introduction of the Edison carbon telephone and the Hughes microphone, the Bell telephone was relegated to the place of the receiving instrument of a telephone line, and microphonic telephones, on account of their much greater power, were used as the transmitting instrument, so that it has come about that all magnet telephones are generally spoken of as receivers, and carbon telephones as transmitters. Notwithstanding this there have been cases where magnet telephones have been used as transmitters as well as receivers for regular exchange service. In Germany the Siemens telephone, already described, was largely used as a transmitter, and in Manchester, England, where an opposition exchange service was started before the expiry of the carbon transmitter patents, the new system was operated for some time with magnet transmitters with excellent results.

62. Carbon transmitters may be generally divided into three classes; viz., those that employ a single contact for varying the resistance of the primary circuit, such as the Blake; those that employ several contacts, of which there is a large number, all of them modifications of the original Hughes microphone; and

those that employ granulated carbon, known as the Hunning type, after the originator of this idea.

63. In this country only three forms of carbon transmitter are in general use, the Blake, the "long distance" and the "solid back." The two latter are modifications of the Hunning transmitter, employing carbon granules. In Europe the variety of carbon transmitters in use by different companies and administrations is very large. A great many of these are microphonic transmitters pure and simple, containing a greater or lesser number of carbon pencils arranged in a more or less fantastic manner.

64. The patents covering the carbon transmitter are owned by the American Bell Telephone company. The Berliner patent, which was issued at the end of 1891, contains some very broad claims, and practically covers every possible form of carbon transmitter, having two "electrodes in contact with each other." The Edison patent, issued a few months later, makes a good second to the Berliner. These two patents were in interference in the Patent Office for a number of years; they were eventually both issued, and are now controlled by the Bell company, which also holds the patents on several special forms of transmitters, such as the Blake, "long distance," "solid back," and others got up in the laboratory of the company.

---

## CHAPTER XIV.

### THE BLAKE TRANSMITTER.

65. The Blake transmitter is the standard instrument for local work in the United States, and is also the principal transmitter used in Canada and Great Britain. It is a fairly good all round instrument of comparatively simple construction, cheap in first cost and cheap to maintain as it requires small battery power. Its chief disadvantage is the necessity of very careful adjustment to get good results in the first place, and of frequent inspection and readjustment to keep it up to the point of giving good transmission. When well adjusted and properly taken care of, nothing better could be desired for lines of moderate length. The construction of the Blake transmitter appears complicated at first sight, but

in reality it is very simple; each of the parts has an important function to perform, and on all being in good condition depends the efficient working of the instrument. See Figs. 34 and 35.

66. The variable resistance is made in the following way: A slender spring carrying a platinum contact point bears on the center of the diaphragm. A second spring carries a button of compressed carbon let into a rather heavy socket of brass. The face of the carbon button presses lightly on the platinum contact point of the first spring. The vibrations of the diaphragm cause the pressure of the platinum

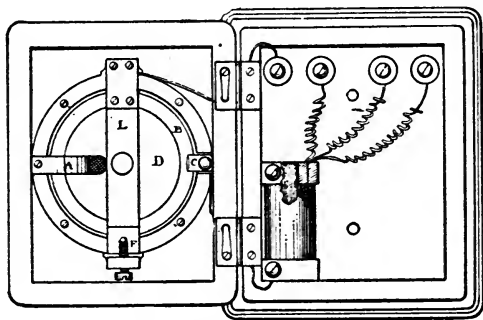

FIG. 34. BLAKE TRANSMITTER. *D* DIAPHRAGM, *B* RUBBER BAND, *C* CLIP, *A* DAMPER, *L* IRON BRACKET, *F* ADJUSTING SCREW.

point on the carbon button to vary, resulting in a variation of the resistance at the contact. The secret of the good working of the instrument is that the two sides of the contact have no rigid bearing. In Edison's first transmitter he made one carbon contact solid with the case and the other solid with the diaphragm. Consequently, the variable contact was not sufficiently "sympathetic," as it were, with the vibrations of the diaphragm, and the instrument did not work well. Blake discovered the reason of the defect and applied the remedy.

67. In the Blake transmitter the carbon button

"stands up" to the platinum contact, securing the full effect of the variations in pressure because of the weight of the brass socket; that is, because of its *inertia*, or resistance to be set in motion. The platinum contact is held against the diaphragm by the carbon button; but the normal set of its spring is *toward* the button and *away* from the diaphragm.

Consequently we have a delicately balanced arrangement that is susceptible to change by the least vibration communicated by the diaphragm to the platinum point.

68. The arrangement of the parts to allow of proper adjustment of the springs is very ingenious. An iron ring is attached to the inside of the case, this ring having a bracket, or projection, top and bottom. To the top bracket is attached a piece of angle iron bent at its upper part to a right angle, at the lower part to an obtuse angle. The lower bracket serves as a bearing for the screw by which the iron support may be adjusted. The top part of the support carries the two springs, which are insulated from each other by hard rubber washers. The carbon spring is sheathed with a rubber sleeve, the diaphragm (generally of iron) is clamped over a rubber gasket, and is provided with a damper consisting

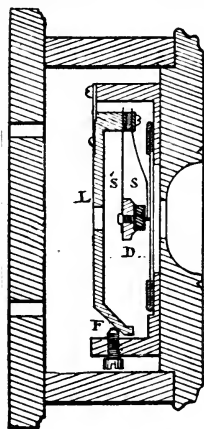

FIG. 35. SECTION OF BLAKE TRANSMITTER *D* DIAPHRAGM, *S* CARBON SPRING, *S'* PLATINUM SPRING, *L* IRON BRACKET, *F* ADJUSTING SCREW.

of a metal spring screwed to the inside of the case. This damper is rubber-covered and has a little cloth pad that presses on the diaphragm near its centre. The damper checks the vibrations of the diaphragm as quickly as they have done their work, preventing continued vibrations that would interfere with those following. The adjustment of the springs is effected by means of the screw bearing on the obtuse angle of



the iron support. Turning the screw upward forces the support, and consequently the carbon button, toward the diaphragm, increasing the pressure between the button and the platinum contact. A reverse action of the screw allows the support to come away by reason of the outward set of the spring by which it is attached to the iron frame, resulting in a decrease of the pressure between the button and the platinum contact. The normal set of the spring with the platinum contact gives it a tendency to follow the carbon button, and if the button is pulled back the platinum contact should follow it nearly half an inch. The best adjustment is when the pressure of the carbon button on the platinum contact just holds it lightly against the diaphragm, not so lightly as to allow of any separation or break when the diaphragm is vibrated by the voices. The two springs of the transmitter are, of course, connected in circuit with the primary wire of the induction coil and with the battery. The induction coil generally used in the Blake transmitter has a resistance in the primary of half an ohm and in the secondary of about 250 ohms.

---

## CHAPTER XV.

### THE "LONG DISTANCE" TRANSMITTER.

69. The Blake transmitter does not give a sufficient volume of sound to allow of its general use for talking over long circuits, and with the introduction of long distance telephony in this country there was produced a transmitter adapted to this special class of work. This transmitter, which has become well known as the "long distance," was the result of an extended series of experiments conducted in the American Bell laboratory, and it is a very excellent instrument, although it is now being supplanted by a later form called the "solid back."

70. The "long distance" transmitter, Fig. 36, is of the Hunning type, depending for its variable resistance on the compression and separation of carbon granules, but the mechanical and electrical details are far more carefully worked out than in any other form of the Hunning transmitter. The construction

is as follows: An iron box attached to the backboard contains the induction coil and supports a nickel plated arm, which carries the transmitter case. The transmitter case is of metal and has a small circular chamber, or shallow tube, the lower side of which is closed by a thin platinum diaphragm and the upper by a circular metal plate. The diaphragm is fastened to a brass ring, and really forms with this ring a shallow box, which is carefully insulated from the metallic case, as the diaphragm rests on a ring of hard rubber, and the brass ring is surrounded by a boxwood collar. This collar is slightly higher than the brass ring, and its upper edge supports a peculiarly shaped electrode, which makes metallic contact with the cover of the transmitter case.

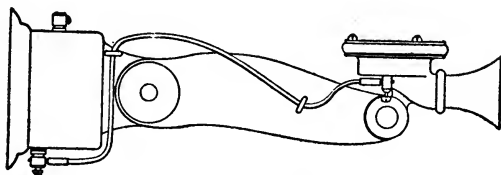

FIG. 36. LONG DISTANCE TRANSMITTER.

This electrode has the form of a small pulley with the upper flange somewhat wider than the other. When the pulley rests on the boxwood collar, its lower surface is one-sixteenth of an inch above the platinum diaphragm. The pulley has a conical hole through the centre, and its grooved rim is pierced with holes that communicate with the central one, so that it forms a sort of grid or grating, Fig. 37. Its purpose is to prevent the carbon granules from packing and to afford plenty of conducting surface through the comparatively large amount of metal it exposes at the lower face, grooved rim and numerous perforations. The pulley shaped electrode is gold-plated; its lower surface is slightly concave and highly burnished. When the electrode is in position a quantity of finely granulated carbon is poured in, filling up the space between the diaphragm and the electrode and partly filling the space between the

grooved rim and the brass ring and the holes in the electrode.

71. The circuit is made from the diaphragm (to the edge of which is attached a binding post insulated from the transmitter case) through the carbon granules to the electrode and thence by the metal

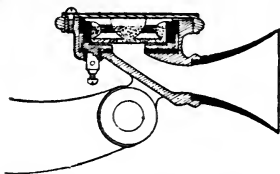

FIG. 37. SECTION OF L. D. TRANSMITTER.

case and arm. The primary wire of the induction coil is connected to two insulated binding posts on the iron box, Fig. 38 One of these is connected by an insulated cord to the insulated binding post attached to the diaphragm, and the

other to one pole of the battery. The automatic switch that throws on the battery is connected to the metal arm of the transmitter, thus completing the circuit through the cap of the transmitter case, which is in metallic connection with the pulley shaped electrode. The voice is directed to the un.

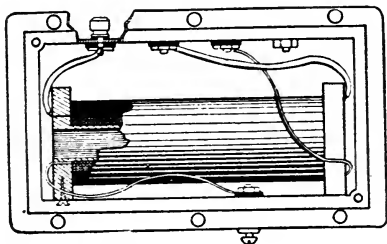

FIG. 38. INDUCTION COIL OF L. D. TRANSMITTER.

derneath side of the diaphragm by a hard rubber mouthpiece screwed into a socket in the metal transmitter case, Fig. 39. The vibrations of the diaphragm agitate the carbon granules, which, being in a finely divided state, offer many points of contact and give a wide range of resistance.

72. This transmitter has many advantages. It is

compact and slightly, and when once properly set up it needs no adjustment. It can be used with a large battery power and gives very loud transmission. The small size of the transmitter case makes it adaptable to numerous convenient and ornamental forms of desk and table instruments, as the induction coil can be put in a separate place. Its chief defects are the extreme delicacy of the platinum diaphragm, which is of very fine foil and is liable to slight indentations and other defects that depreciate the

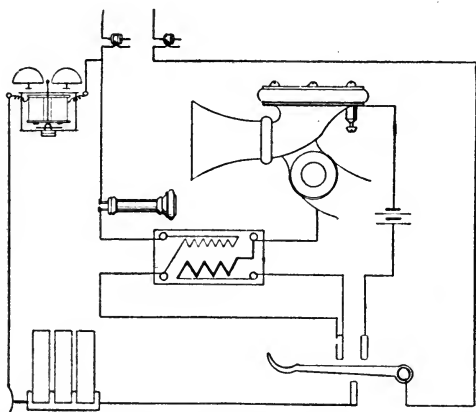

FIG. 39 DIAGRAM OF CONNECTIONS OF L. D. TRANSMITTER

transmission, and the tendency of the granulated carbon to "pack." The packing of the carbon granules, giving the carbon a condition approaching that of a solid cake of the material, affects the transmission very seriously. The vibration of the transmitter in ordinary use has a tendency to pack the carbon, and this is aided by the heating of the transmitter by the battery current; the remedy, apart from taking the transmitter to pieces and supplying fresh carbon granules, is to tap the transmitter lightly at the sides. To protect the diaphragm,

which is the only delicate part of the instrument, from outside interference, a couple of stiff wires are placed across the narrow end of the mouthpiece.

---

## CHAPTER XVI.

### THE "SOLID BACK" TRANSMITTER.

73. This instrument is also of the Hunning type. It has lately been introduced by the American Bell Telephone company, and for some time has been supplied to all new long distance stations instead of the original "long distance" transmitter just described. It was designed chiefly with a view of overcoming the trouble referred to at the end of the last chapter—the packing of the granulated carbon. In the "solid back" transmitter shown in Fig. 40 (which has in reality a hollow back), the working parts of the instrument, the diaphragm and chamber containing the electrodes and granulated carbon are mounted vertically instead of horizontally, as in the long distance. The transmitter case is of metal, and has much the form of the gong of an electric bell; it is enclosed by a perforated metal lid or cover, to which is attached the mouthpiece. The cover carries the entire transmitter, which consists of two small carbon disks enclosed in a metal chamber having an insulating lining; between the disks is a layer of finely granulated carbon, and the disks being slightly smaller than the containing chamber, the surrounding space between the edges of the disks and the side of the chamber is also filled with carbon granules. The back electrode is in metallic connection with the containing chamber, a little pin in the brass backing of the carbon disk fitting into a recess in the chamber and holding it firmly seated. The front electrode is insulated from the chamber by the insulating lining of varnished paper and by a mica disk or washer, which incloses the chamber when the front electrode is placed in position. The front electrode is secured to the vibrating diaphragm of the transmitter by means of a pin which extends from its brass backing through a hole in the centre of the diaphragm. This pin has two threads, one for a nut that clamps the mica washer over the end

of the chamber containing the two electrodes, and a finer one for two small nuts that clamp the electrode to the diaphragm.

74. The mica washer is held against the little chamber by a brass collar which screws on the brass chamber itself and secures the mica washer to it around its edge. The mica washer being clamped



FIG. 40. SOLID BACK TRANSMITTER ON DESK SET.

to the chamber at its periphery and to the front electrode at the centre, has sufficient elasticity to allow of the electrode responding to the vibrations of the diaphragm, and at the same time the transmitter chamber is effectually closed. The chamber has a projecting stud at the back which fits into a hole in a stout brass bridge and is there secured by a set screw. The metal bridge is screwed to the

cover of the transmitter case. The diaphragm, which is of metal, is secured to the cover, and is provided with the usual clip and padded dampening spring. One end of the brass bridge carries a block of insulating material, and to a small binding post, on this block a fine wire attached to the front electrode is connected. The rear electrode being in metallic contact with the bridge and through it with the case of the transmitter and the supporting arm, needs no special connection, one side of the primary circuit being connected to the arm of the transmitter.

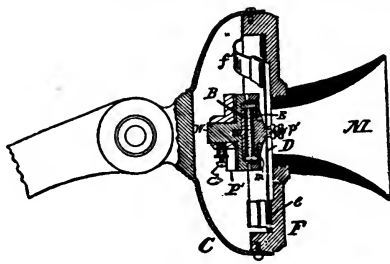

FIG. 41. SECTION OF SOLID BACK TRANSMITTER. *M* MOUTHPIECE, *D* DIAPHRAGM, *E* FRONT ELECTRODE, *B* BACK ELECTRODE, *W* ELECTRODE CHAMBER. *P* METAL BRIDGE-PIECE, *d* SET SCREW, *m* MICA WASHER. *p'* THREADED PIN ON FRONT ELECTRODE, *e* RUBBER BAND, *f* DAMPER, *C* CASE, *F* COVER.

The other side is connected by a cord which passes through a hole in the bell-shaped transmitter case to the binding post on the insulating block.

75. The vibrations of the diaphragm are communicated to the front electrode by the pin, which forms a rigid connection between them. The electrode, having a certain freedom of movement within the little chamber, varies the pressure on the layer of carbon granules between it and the back electrode, thereby setting up the usual variation of resistance required in a carbon transmitter. The design of the instrument is very good. The two electrodes

being of carbon make excellent contact with the carbon granules, thus affording the best opportunity for wide variation of resistance under vibration, while the carbon electrodes being soldered to brass disks good metallic contact is obtained with the two sides of the primary circuit. The "packing" difficulty is to a considerable extent obviated by this form of transmitter. The space in the chamber around the edges of the electrodes contains a certain quantity of granulated carbon which is not directly in the circuit and does not become heated up rapidly by the current, and any expansion of the granules immediately between the electrodes through heating causes a displacement of part of the heated carbon into the cooler; when the transmitter is out of circuit and cools off, the granules tend to resettle into their original position.

76. The chamber containing the working parts of



FIG. 42. DETAILS OF SOLID BACK TRANSMITTER. *W* ELECTRODE CHAMBER, *i* INSULATING LINING, *B* BACK ELECTRODE. *a* BRASS BACKING, *E* FRONT ELECTRODE, *b* BRASS BACKING, *p* THREAD FOR NUT *U*, *m* MICA WASHER, *u* NUT FOR CLAMPING *m* IN PLACE, *p'* THREAD FOR *t* AND *t*, *c* COVER OF *W*, *TT* NUTS FOR CLAMPING FRONT ELECTRODE TO DIAPHRAGM

the instrument is extremely small, and forms a sort of button attached to the front cover of the case. By unfastening the screws which hold the cover the entire transmitter can be withdrawn, the connecting cord joined to the insulated binding post having first been disconnected. On account of the smallness and delicacy of the parts, great care is required in handling the transmitter when assembling or taking apart. When properly set up it needs no adjustment, and indeed there is nothing that can be adjusted unless some radical defect exists. Fig. 40 gives a general view of the solid back transmitter



arranged on a desk set, and Figs. 41, 42 and 43 show the details of construction by means of a section of the transmitter mounted, a section of the various parts of the chamber and a front view of the chamber, and a back view of the cover of the transmitter case with the diaphragm and brass bridge carrying the chamber in place.

## CHAPTER XVII.

### THE BERLINER TRANSMITTER.

77. Berliner is an interesting name in telephony. Berliner discovered in 1877, independently of Hughes—the results of whose work were published at a later date—the principle (or rather, its application to tele-

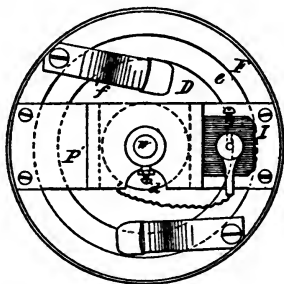

FIG. 43 BACK OF COVER OF SOLID BACK TRANSMITTER. *F* METAL COVER, *D* DIAPHRAGM, *P* METAL BRIDGE CARRYING "BUTTON." *I* INSULATING BLOCK. *W* ELECTRODE CHAMBER, *d* SET-SCREW, *e* RUBBER BAND, *f* DAMPER.

phone transmitters) of the variation of resistance at a loose contact subject to variation of pressure. Berliner lodged a  *caveat*  in the Patent Office, broadly claiming this invention, in April, 1877, and in June he applied for a patent. Edison had been working in the same line and applied for a patent in July of the same year. Berliner and Edison were declared in interference by the Patent Office. This interference was not finally decided in favor of Berliner until 1886; but meanwhile, in 1880. Drawbaugh

appeared on the scene with an application for a patent on a microphonic transmitter, and according to the rules of the Patent Office no patent could be issued to any of the three until it was determined whether the Drawbaugh claim was valid or not. This was finally decided against Drawbaugh, as it was proved that the Edison carbon transmitter had been in public use for more than two years before Drawbaugh made his application for a patent, and his application was thrown out. A patent was then issued to Berliner on the broad

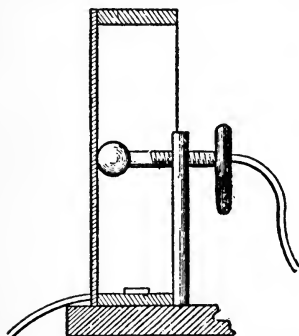

FIG. 44. BERLINER'S FIRST TRANSMITTER.

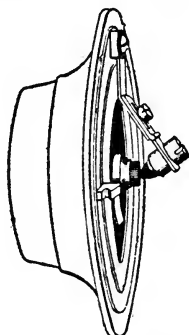

FIG. 45. BERLINER CARBON TRANSMITTER.

principle of the microphone transmitter in November, 1891. In May of the following year a patent was issued to Edison, so that both sides of the interference eventually got their patents—more than fourteen years after the filing of the original applications.

78. Both Berliner and Edison obtained in 1878 patents on special forms of transmitters designed in accordance with the principles laid down in their applications for the broad principle of battery telephones, and the Berliner transmitter especially has been modified out of all semblance to its original form. The broad claim in the Berliner patent is as follows: "The method of producing in a circuit electrical undulations similar in form to sound waves by caus-

ing sound waves to vary the pressure between electrodes in constant contact, so as to strengthen and weaken the contact and thereby increase and diminish the resistance of the circuit." The Edison patent issued in May, 1892, covers the use of carbon in telephone transmitters (Berliner, up to the filing of his application, had experimented only with metal contacts), and the broad claim is as follows: "In a telegraphic apparatus operated by sound the combination with the diaphragm of one or more contact points of

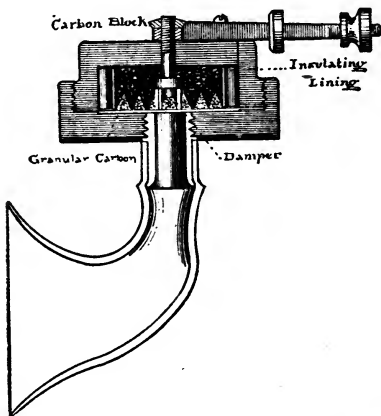

FIG. 46. BERLINER "UNIVERSAL" TRANSMITTER.

plumbago or similarly inferior conductor in the electric circuit, whereby the rise and fall of electric tension is proportionate to the pressure exerted upon the said point or points by the diaphragm." It will be seen that a combination of the Berliner and Edison patents practically embraces the fundamental principles of almost all battery telephone transmitters.

79. Fig. 44 represents the original form of experimental transmitter devised by Berliner having a metal plate forming the diaphragm with a metal ball resting against it. One side of the circuit was connected to the diaphragm and the other to the ball. The

resistance of the contact between plate and ball was varied by the vibration of the diaphragm, thus setting up the electric undulations. It will be seen that this arrangement is suspiciously like a "make and break" transmitter, as no device is shown for allowing the electrode to follow the diaphragm in its vibrations.

80. Fig. 45 shows Berliner's first form of carbon transmitter. In this instrument, which was brought out in the early days of carbon transmitters, the important improvement of giving one of the electrodes a yielding support was adopted. One of the carbon electrodes is attached to the diaphragm and the other to a socket carried on a hinged piece on the end of a bent spring secured to the transmitter case. This manner of disposing of the carbon contacts was a forerunner of the Blake invention, which is an improvement on it.

81. Berliner's "Universal" transmitter is entirely different from his early instruments. It is an excellent transmitter, and well adapted to long distance work. It has not been adopted in this country at all, but is used in South America and in some parts of Europe. In general principles of construction, although not in detail, it resembles both the long distance and solid back transmitters described in Chapters XV. and XVI. The diaphragm is a carbon disk forming one electrode. The second electrode is a circular block of carbon held so that its lower surface is a short distance above the carbon disk. The lower surface of the carbon block is corrugated, a number of deep circular grooves being cut in it, and the space between the disk and block being occupied by carbon granules, these grooves or corrugations fulfill the double purpose of affording plenty of contact surface and of dividing up the granulated carbon so as to minimize the effect of "packing."

82. The transmitter chamber is formed of a circular wooden box with a short tube screwed through the bottom for the mouthpiece. The cover, also of wood with a brass ring round its lower edge, screws into the box, and clamps down the carbon diaphragm, the connection from one side of the primary circuit to the diaphragm being made through the brass ring. The cover has an insulating lining of thick felt, which closely surrounds the upper carbon electrode

and whose lower edge rests on the diaphragm. Thus a small chamber enclosed by the diaphragm, upper electrode and insulating felt lining is provided for the granulated carbon. The upper electrode is supported by a slightly tapered brass pin fitted tightly into a hole bored through the centre of the block. The lower end of this piece carries a small piece of soft rubber tubing which bears lightly on the diaphragm and serves as a damper. The pin is clamped to the top of the cover by a screw nut. The mouth-piece used with this instrument is usually made of soft rubber.

83. From the foregoing description it will be apparent how close is the resemblance, as far as the general arrangement goes, between this transmitter and the two instruments used for long distance work in this country. The differences are mainly in the details of construction, which have been more carefully worked out in the transmitters used by the Bell companies. The "solid back," utilizing the same principle of two carbon electrodes with a layer of granules between, is a much more efficient transmitter than the Berliner. Fig. 46 is a section of the Berliner "Universal" transmitter.

---

## CHAPTER XVIII.

### THE CUTTRISS TRANSMITTER.

84. This instrument is a quite recent invention, and is due to an idea which occurred to Charles Cuttriss when working on carbon springs for another kind of apparatus. Mr. Cuttriss was quite successful in manufacturing small springs or helices of carbon, and found that they gave a wide variation of resistance, the resistance of the spring when closed being only 10 ohms and when distended as high as 500 ohms. No sparking was observed between the convolutions until the carbon was heated to between 300° and 400°. It occurred to Mr. Cuttriss that these features would be of value in a telephone transmitter, and the results of a trial fully justified his expectations. The following is an account of the performance of this interesting transmitter, given in Mr Cuttriss's own

words in an article by him published in the *Electrical Engineer* for December 16, 1891:

"Not only does the instrument transmit speech loudly, but the articulation is so remarkably clear that I have been led to look for some particular reason why this should be so. I think it will be found to be owing to the extreme lightness of the helix (generally less than one grain); to the absolute continuity of the circuit—that is to say, the elimination of electrodes—and also to the fact that, as each part of the spiral is tending to open itself, it absolutely precludes any tendency for the surfaces to jam or lock together."

In this transmitter it will be seen that there are practically no contacts, the carbon spring being simply included in the primary circuit, and, as described, the compression and elongation of the spring effect the variation of resistance.

The illustration, Fig. 47, shows the arrangement of the carbon spring in relation to the diaphragm, but is not

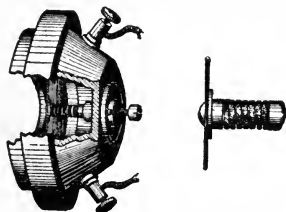

FIG. 47. CUTTRISS TRANSMITTER.

intended to represent a finished form of transmitter. The spring is cemented to the diaphragm, and a screw, to which it is connected electrically, bears against the other end to allow of regulating the tension of the spring. A separate enlarged view of the carbon spring is also shown.

## CHAPTER XIX.

### VARIOUS EUROPEAN TRANSMITTERS.

85. There are several good forms of carbon transmitters in use in Europe, and a description of some of these will probably be found of interest. A number of them are very close relatives, being modifications of the original Hughes microphone. These are generally called carbon pencil transmitters, and they differ from each other chiefly in the number and

arrangement of the carbon pencils. To this family belong the Gower, Ader, Crossley, D'Arsonval, De Jongh and Mix and Genest transmitters.

86. The Gower transmitter consists of a multiple microphone formed of eight carbon pencils radiating from a central carbon block, the other ends of the pencils resting in separate carbon blocks. This arrangement is fastened to the back of a thin wooden diaphragm. The vibrations of the diaphragm cause changes in the sixteen loose contacts. The four outer carbon blocks on each side are connected by copper strips, to which the wires of the primary circuit are joined. This transmitter is a very efficient one; with the added advantage of having no parts needing adjustment. It is used in the telephone

system of the British Postal Telegraphs, and gives good results even over the line between London and Paris. Fig. 48 shows the arrangement of the carbon contacts, and Fig. 49 the form of carbon pencil used.

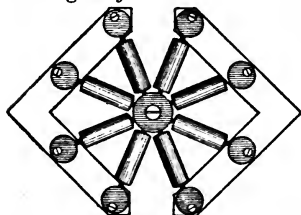

FIG. 48. VARIABLE RESISTANCE OF GOWER TRANSMITTER.

is very similar to the Gower. It employs a large number of carbons, twelve instead of eight, giving twenty-four contacts, and they are differently mounted. A wooden diaphragm carries three carbon blocks, which are hollowed out to provide bearings for the twelve carbon pencils. Fig. 50 shows the arrangement so clearly that no description is necessary.

87. The Ader transmitter, which is largely used in France,

88. The Crossley, again, is another simple variation of the same combination. Four pencils rest in bearings in four carbon blocks arranged diamond-wise on a thin wooden diaphragm. Fig 51 shows the Crossley transmitter. The chief interest attached to this instrument is that its designer obtained a patent on "multiple contact" microphones and was lucky enough to sell this patent to an English telephone company for upwards of \$80,000.

89. The D'Arsonval transmitter has carbon pencils bearing in carbon blocks. The feature which distinguishes this instrument from others of the family is that means are provided for varying the pressure between the pencils and the blocks. The carbon pencils are sheathed with a thin iron covering, and a horseshoe magnet is mounted behind them.



FIG. 49 CARBON PENCIL.

By changing the position of the magnet by means of an adjusting screw, the normal set of the carbons will be altered through the attraction of the magnet for their iron coatings. In making this improvement it will be noticed that M. D'Arsonval has robbed the carbon pencil transmitter of its chief merit—simplicity and absence of mechanism. Figs. 52 and 53, plan and section, show the arrangement of the carbons and the position of the controlling magnet.

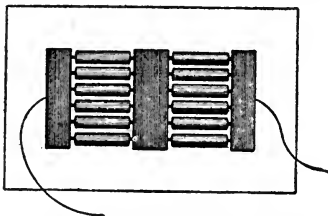

FIG 50. VARIABLE RESISTANCE OF ADER TRANSMITTER.

10. In the De Jongh transmitter a rather original disposition of the carbons is made. The diaphragm, which is mounted vertically, carries two rows of carbon blocks, four in a row. Against these blocks rest four carbon pencils connecting each pair of blocks together. The carbon pencils are supported by brass pins driven at an angle into a board placed a short distance behind the diaphragm. The four carbon blocks on each side are joined together by a wire and to these wires the two sides of the primary circuit

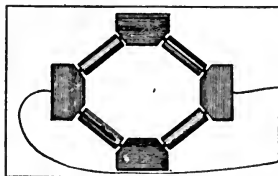

FIG. 51. VARIABLE RESISTANCE OF CROSSLEY TRANSMITTER.

driven at an angle into a board placed a short distance behind the diaphragm. The four carbon blocks on each side are joined together by a wire and to these wires the two sides of the primary circuit



are connected, there thus being eight variable contacts in the primary circuit. Fig. 54 shows a section of the De Jongh transmitter with a view of one of the carbon pencils to the right.

91. In the Mix and Genest transmitter, which is used to a great extent in Germany, a device is provided to prevent the carbon pencils from resting loosely on the edges of the bearings in the supporting blocks, the object being to eradicate the tendency to fry, sizzle and rasp that pencil microphones occasion-

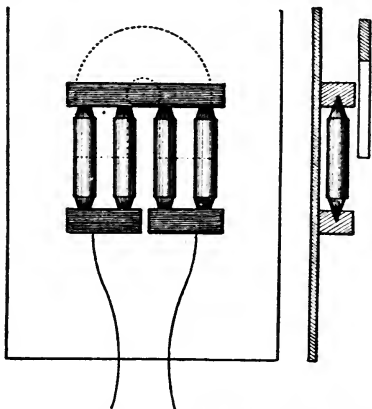

FIGS. 52 AND 53. D'ARSONVAL TRANSMITTER.

ally indulge in. The diaphragm is vertical, and has two carbon blocks grooved for three pencils. In the space between the blocks a pad or diaphragm attached to an adjustable spring presses lightly against the carbon pencils. This damper keeps the pencils from revolving and holds them against the front part of the bearings in the supporting blocks. Fig. 55 is a rear view of the Mix and Genest transmitter, and Fig. 56 is a section showing the adjustable pad and spring.

92. The transmitter adopted by the Société Générale des Téléphones—the company which organized the Paris telephone system and was recently bought out by the French government—has some interest, as

the theoretical principle of its design is to double the effect of the Blake transmitter by employing two variable contacts so arranged that a movement of the diaphragm in either direction would diminish the pressure at one contact and increase the pressure at the other. Fig. 57 gives a diagrammatic view of the double contact and the peculiar winding of the induction coil. To the diaphragm a carbon block is cemented, which carries, by means of a U-shaped piece of insulating material, a second carbon block. Resting between the carbons and making contact

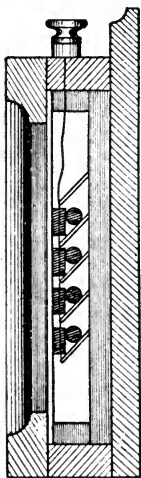

FIG. 54. DE JONGH TRANSMITTER.

with both of them is a conical metal contact piece suspended from a balanced support which is not shown in the diagram. This gives the double variable contact, and it is obvious that whichever way the diaphragm moves, the two carbons being rigidly connected to it, the pressure between one carbon and the metal plug will be increased and the pressure between the other and the plug will be diminished. The primary winding of the induction coil is made of two layers, one end of each layer is joined to one of the carbon blocks and the other two ends are joined to one pole of the battery, the second pole of the battery being connected to the metal plug. Thus there is a divided circuit in the primary winding, one branch being controlled by each of the variable contacts; the movements of the diaphragm produce at each moment increase of resistance in one branch and decrease in the other and therefore each branch sets up induced currents in the secondary winding of the coil. The effect is, theoretically, supposed to be double that produced in a Blake transmitter, and practically the result of this arrangement is a very loud transmission, but not a good quality of speech

93. The Clamond transmitter, which has recently

been patented in the United States, possesses a novel feature in the employment of a plastic variable resistance. This is made of a mixture of powdered conducting material and glycerine, vaseline or some heavy oil. The plastic mixture is enclosed in an elastic covering of collodion or soft rubber and placed between two metal contact pieces, to which the two sides of the primary circuit are joined. One of the contact pieces is attached to the diaphragm, and in this way the voice vibrations are communicated to the plastic variable resistance. It is said that this instrument gives very loud and clear transmission,

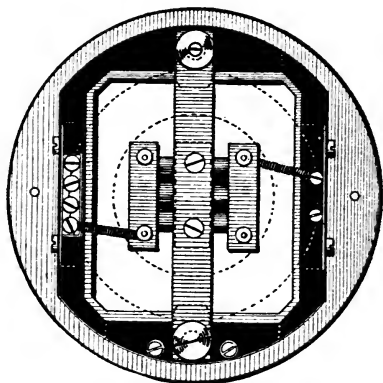

FIG. 55. MIX AND GENEST TRANSMITTER.

but it has not yet had an extended practical trial. The obvious source of trouble is that the plastic resistance will probably develop a tendency to lose its plasticity. Fig. 58 shows the form of transmitter which M. Clamond says has given the best results. Fig. 59 is a section of the button containing the plastic variable resistance. The rear electrode forms a chamber to receive the plastic material and the front electrode is a metal plug pushed into the mixture, the whole being held together by a cap or collar.

## CHAPTER XX.

## THE EFFICIENCY OF TELEPHONE TRANSMITTERS.

94. The efficiency of a telephone transmitter generally speaking, depends on the range of variation in current strength that can be produced in the primary circuit. According to the laws of induction (see Chap. V) the induced currents set up in the secondary of the induction coil are dependent on the changes in the strength of the current flowing in the primary circuit, being caused by changes in the resistance in that circuit, and it is obvious that the point to be attended to is to render the primary circuit of the transmitter capable of a wide range of

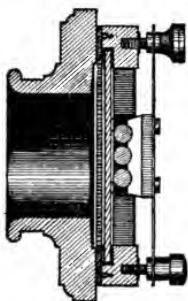

FIG. 56. SECTION OF  
MIX AND GENEST  
TRANSMITTER.

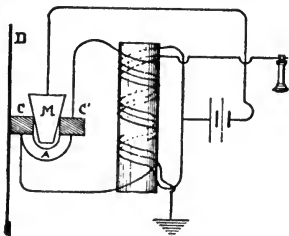

FIG. 57. DIAGRAM OF SOCIETE  
GENERALE TRANSMITTER.  
*D* DIAPHRAGM, *C C* CAR-  
BON BLOCKS, *A* INSU-  
LATING ARM, *M*  
METAL CONE.

variation of resistance. It also naturally follows from this that the normal resistance of the primary circuit must be low, because to be effective the changes in resistance must be in substantial ratio to the normal resistance of the circuit. For instance, if the normal resistance of the primary circuit of a transmitter were five ohms and any movement of the diaphragm caused an increase or decrease of half an ohm, that would change the resistance of the circuit by one-tenth of its original value. But if the normal resistance were twenty ohms, an increase or decrease of half an ohm

would change the resistance of the circuit by only one-fortieth of its original value, and the induced current set up in the secondary coil due to such a change would only have one-quarter the strength of that in the first case.

95 Consequently, it is of the first importance that the resistance of the primary circuit, consisting of the primary of the induction coil, the variable resistance controlled by the diaphragm and the battery, shall be kept low. The resistance of the primary of the induction coil is generally about half an ohm or less. That of the variable contact of the transmitter differs of course in various forms of transmitters,

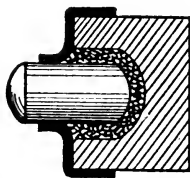
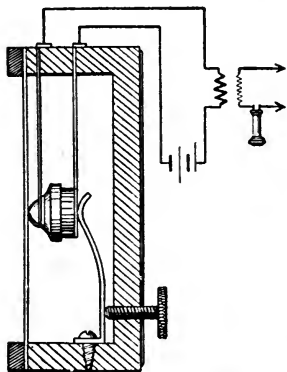

FIG. 58. CLAMOND TRANSMITTER. FIG. 59. "BUTTON" OF CLAMOND TRANSMITTER.

according to the design of the carbon buttons and disks or pencils, but it is seldom more than a few ohms. The internal resistance of the battery is the most uncertain element. It is practically never a fixed quantity, but varies according to the amount of current flowing. It increases when the battery is allowed to get in bad condition and also when the battery becomes run down or "polarized." The resistance of the variable contact also varies somewhat according to the current flowing, owing to the heating effect of the current.

96. In considering the efficiency of a transmitter, the question of the normal current flowing in the primary circuit is naturally quite as important, although in a different way, as the resistance of that circuit. It would seem at first sight that the efficiency of any transmitter might be improved almost indefinitely by simply increasing the battery power, but this is not so. The variable resistance of every transmitter is a somewhat delicate piece of electrical apparatus. A certain amount of heat is always developed at the contacts and minute arcs form at the points of the carbon particles where the current passes between the contacts. Heat up the carbon contacts too much by using too strong a current and you impair rather than improve the efficiency of the transmitter, and a point would soon be reached where the transmitter would not talk at all. By experiment it has been found how much battery power can be safely used with each form of transmitter to give the best results without incurring the risk of the carbon contacts becoming overheated when a transmitter is used for any unusual length of time.

97. The importance of keeping the normal resistance of the primary circuit of a transmitter as low as possible points to the necessity of keeping all connections and leads included in that circuit in good order, so as to prevent the introduction of any extra resistance through loose contacts at binding posts, corroded wires or other faulty connections. If the battery has to be placed at any distance from the transmitter the leads should, for the same reason, be of thick wire having an inappreciable resistance.

---

## CHAPTER XXI.

### BATTERIES FOR TELEPHONE WORK.

98. From what has been said in the preceding chapter, it naturally follows that a battery for telephone work should have a low internal resistance and that it should be capable of working for reasonable periods of time without great falling off in electromotive force or considerable rise in internal resistance. The battery should also be easy to handle, free from

obnoxious fumes, and should not require frequent attention or renewal of solutions or parts

99. These requirements, especially those referring to the electrical conditions, are difficult to satisfy. Practically every type of battery decreases in electromotive force and increases in internal resistance when working on a circuit of low resistance. This is due to what is called "polarization." The action of the current within the cell causes minute bubbles of hydrogen to collect on the negative plate, and this coating of the plate with gas diminishes the surface capable of collecting current and causes a reduction of the electromotive force of the cell and an increase of its resistance. The battery is then said to be "polarized." An important part of the make-up of most batteries is what is called the "depolarizer," which is a chemical substance, solid or in solution, able to provide oxygen to combine with the hydrogen that is liberated by the action of the battery and so to remedy or prevent polarization.

100. Batteries in which the depolarizing takes place comparatively slowly and chiefly after the battery has temporarily ceased to do work are called "open circuit" batteries, and those in which the depolarizer acts continuously while the battery is doing work, practically preventing polarization, are called "closed circuit" batteries. Open circuit batteries are intended for use where there are only occasional demands for current, periods of complete rest intervening during which the battery has time to depolarize and recover its normal strength. The best example of this type of battery is the universally used Leclanché cell. Closed circuit batteries are used for work where the demand for current is continuous or so frequently repeated and long kept up as to be practically so; there is little or no time for recuperation, and the depolarizing process must keep pace with the work the battery is doing. Examples of this class of battery are the Daniell or gravity cell and the bichromate zinc-carbon cell.

101. In the Leclanché cell the depolarizing agent is dioxide of manganese, which surrounds the carbon plate. The oxide of manganese yields up its oxygen readily for combination with the hydrogen liberated by the action of the cell, and afterward the manga-

nese absorbs fresh oxygen from the air. This process goes on comparatively slowly, hence the necessity of frequent periods of rest to enable the battery to cope with short periods of work. In the gravity or "blue-stone" batteries, the depolarizing agent is the sulphate of copper, which gives up oxygen to combine with the free hydrogen and deposits metallic copper on the copper plate of the battery. The peculiarity of this type of battery is that it keeps in the best condition when doing continuous work. If left long on an open circuit it deteriorates. In the bichromate batteries the depolarizer is a mixture of sulphuric acid and bichromate of potash or soda (generally the latter); oxygen is given out from the solution to combine with the hydrogen, and a chemical substance known as chrome alum is formed, which partly enters into the solution and is partly deposited in the form of dark crystals.

102. Up to within a few years ago open circuit batteries were used for telephone work to the exclusion of all others. The Blake transmitter works well with one Leclanché cell, as in ordinary local telephoning conversations are not long and the intervals between them usually are. But with the introduction of long-distance telephony new conditions called for a different kind of battery. More powerful transmitters needed greater battery power, and as the transmitters in many places (as at busy pay stations) are in almost constant use, a closed circuit battery was required. The most suitable type was found to be what is known as the Fuller bichromate, a battery which gives a high electromotive force, has a fairly low internal resistance, and is capable of continuous heavy work without suffering serious change in either.

103. The electromotive force of a battery depends on the materials of the plates and exciting solution used. The standard adopted is the Daniell copper sulphate cell, which has (nominally) an electromotive force of one volt. There are batteries which give considerably less than one volt and there are others that give nearly three, but very few cells will maintain for any time a working electromotive force of over two volts. The internal resistance of a battery depends on its mechanical construction, the size of



the plates, or rather the amount of surface exposed to the solution, the nearness of the two plates to each other and the conducting power of the solution and other separating material. The current developed by the battery depends on the combined resistance of the external circuit and of the battery itself. The unit of current—the ampere—is the current flowing in a circuit having a resistance of one ohm connected to a source of electromotive force equal to one volt. Thus, a battery of cells having a total electromotive force of six volts and a total internal resistance of six ohms, if connected to a circuit having a resistance of 54 ohms, would produce in that circuit a current of one-tenth of an ampere. This is according to Ohm's law, which says that the current in any circuit is equal to the electromotive force acting on that circuit divided by the total resistance of the circuit. This formula is generally written  $C = \frac{E}{R}$ ,

C standing for current, E for electromotive force and R for resistance. R, of course, represents the total resistance of the external circuit and the internal resistance of the battery, or other source of electricity.

104. It should be borne in mind that the initial electromotive force of a battery and its initial internal resistance always undergo a certain modification when the battery is at work, dependent on the resistance of the circuit to which the battery is connected. In telephone work the resistance of the circuit energized by the battery is, of course, constantly changing and this to a certain extent reacts on the battery; while the battery-current in turn affects the resistance of the circuit by the heating of the variable carbon resistance. Therefore it is impossible to say what the internal resistance of a telephone transmitter battery may be at any moment when the transmitter is in use, but we do know that the battery should have a low resistance to start with and this is a point that cannot be over emphasized.

105. In all batteries where zinc is used, the zinc is consumed and the current within the cell passes from the zinc to the carbon or copper, which acts as a collector for the current. In the external circuit the current passes from the carbon or copper to the zinc.

In speaking of batteries therefore the zinc is termed the *positive* plate and the carbon or copper the *negative* plate. In speaking of the *terminals* of a battery (or poles, as they are often incorrectly termed) the carbon is called the *positive terminal* and the zinc the *negative terminal*.

## CHAPTER XXII.

### OPEN CIRCUIT BATTERIES.

106. There are many modifications of the Leclanché cell in use. The original combination consists of a zinc-carbon cell with a solution of sal-ammoniac as exciter. The carbon plate is surrounded with a mixture of coarsely granulated manganese dioxide and carbon. In the original form, shown in Fig. 60, a porous pot was used to hold the carbon plate and surrounding mixture and the porous cup form of battery is very largely used to-day. The modifications that have been made have had the object of decreasing the internal resistance of the cell and increasing the depolarizing effect. With these objects in view Leclanche batteries are made without porous cups, the depolarizing mixture being cast in blocks which are clasped to the carbon plate by rubber bands; in other forms a fluted carbon cylinder surrounded by rods of the depolarizing mixture is used. The zinc, Figs. 61 and 61A, is either in the form of a rod or plate or of a thin cylinder which surrounds the carbon element save for a vertical opening to allow of free diffusion of the exciting solution. Cells in which the depolarizing mixture is attached to the carbon in the form of blocks or rods are generally called "agglomerate" cells. They have a much lower internal resistance than the porous cup form, both

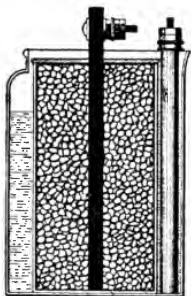

FIG 60. SECTION OF POROUS CUP LECLANCHE CELL.

because of the absence of the porous cup and because

of the larger amount of surface generally obtained in the carbon plate and depolarizer.

X 107. The important point in the Leclanché battery is that it should be made of the best materials. An inferior quality of carbon and manganese (and bad work in assembling usually goes hand in hand with bad materials) will always give a poor battery. Therefore very cheap batteries are to be avoided as they will undoubtedly prove the dearest in the end. Any type of Leclanché battery will give good results if honestly made of good materials; the agglomerate forms are to be preferred to the porous cup on account of their lower internal resistance and slower polariza-



FIG. 61. AGGLOMERATE OR "PRISM" FORM OF LE-CLANCHÉ CELL.



FIG. 61 A. TYPE OF AGGLOMERATE LE-CLANCHÉ CELLS.

tion. Some of the agglomerate forms of Leclanché have advantages over others, but this is a question that is regulated by the price, as the best made and most efficient cells are naturally the highest priced. Most of the batteries are known by special trade mark names and it would possibly be unfair to particularize in a hand-book. The conditions having been given, a choice should not be difficult.

108. There are several open circuit batteries, such as that shown in Fig. 62, on the market in which no depolarizer is used. These are well adapted to telephone work. Reliance is placed on exposing a very large surface of the carbon plate, which is generally arranged in the form of a double cylinder. This

type of battery has the merit of being extremely simple, consisting merely of zinc and carbon in a solution of sal-ammoniac, no separating material being required. Such cells (Fig. 63), on account of the large plate surface exposed and the small space between the zinc and the carbon, have a low internal resistance, but their electromotive force is also slightly lower than that of a Leclanché cell proper. They also polarize more easily than a good agglomerate Leclanché cell and the polarization lasts longer, that is, the recovery is slower. Their chief recommendations are simplicity and cheapness.

109. The electromotive force of the Leclanché

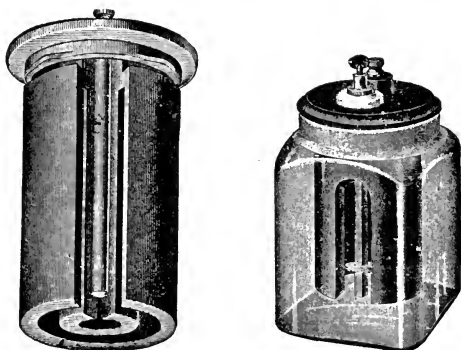

FIG. 62. LAW BATTERY. FIG. 63. LACLEDE BATTERY.  
TYPES OF ZINC-CARBON OPEN CIRCUIT CELLS  
WITHOUT DEPOLARIZER.

cell ranges from 1.4 to 1.7 volts—the voltage of almost any Leclanché cell after it has been working a short time on a circuit of low resistance falls to one volt. The internal resistance ranges from one-third of an ohm to two ohms. The lower figure is reached by the best types of agglomerate cells, while the higher is about the average of porous cup cells. If the resistance is higher than this the battery is in bad condition. The open circuit battery without depolarizer has an electromotive force of about 1.3 volts at the best and an internal resistance of about one-third

of an ohm. The voltage drops to one volt or less when the cell is at work on a low resistance.

## CHAPTER XXIII.

### CLOSED CIRCUIT BATTERIES.

110. The form of closed circuit battery most used in telephone work is the Fuller bichromate. This is a zinc-carbon cell with an exciting solution of dilute sulphuric acid or common salt, and a depolarizing solution of bichromate of soda and sulphuric acid. The zinc is cast in the shape of a conical block, and has a thick wire or rod firmly attached to it for the connection; the block rests on the bottom of a porous cup in which about an ounce of mercury is placed. The mercury keeps the zinc constantly amalgamated as the surface is worn away by the action of the battery. The porous cup (Fig. 64) holds the exciting solution of dilute acid or salt. The carbon is a plate of carbon of good quality which is placed in the outer jar containing the depolarizing mixture. In large cells two or three carbon plates connected together are generally

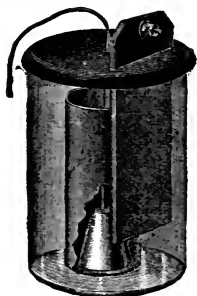

FIG. 64. FULLER BICHROMATE CELL.

used for the sake of increasing the surface of the negative plate. This battery has an electromotive force of slightly over two volts and a resistance of about one-third of an ohm.

111. The gravity battery, of which there are many forms on the market, is a modification of the original Daniell zinc-copper cell with depolarizer of copper sulphate. The exciting solution is a weak solution of zinc sulphate. The copper is placed on the bottom of the jar, and is covered with a saturated solution of copper sulphate; a quantity of crystals of copper sulphate are added to the solution to maintain it always at the point of saturation; as the copper sulphate is used up from the solution the supply is kept

up by the dissolving of the crystals. Above the copper sulphate solution is placed a solution of zinc sulphate, and the zinc plate is suspended in this solution. Owing to the different densities of the two solutions they do not mix unless the cell is shaken up; it is necessary to pour in the zinc solution very carefully and to keep the cell stationary. As before stated, this battery is not suitable for intermittent work. If left for any time on open circuit the copper solution will diffuse into the zinc solution, and black deposits of copper will form on the zinc plate, resulting in a reduction of the efficiency of the battery. The gravity battery has an electromotive force of about one volt and an internal resistance when in good condition of about one-fifth of an ohm.

112. A form of cell that can be used for both open and closed circuit work has lately attracted considerable attention, and it undoubtedly has its good features. This is the Edison-Lalande copper oxide battery. Copper oxide is an excellent depolarizer, as it parts with its oxygen very readily. In the Edison-Lalande cell, Fig. 65, a plate of compressed copper oxide is used as the negative plate. The plate is suspended from the insulating cover of the cell by a copper frame, and the zinc plate also hangs from the cover. The exciting liquid is a solution of caustic potash. In the action of the cell the copper oxide is decomposed, and metallic copper is deposited, partly on the negative plate, and partly in the form of a black powder which falls to the bottom of the cell. The good points of this battery are its simplicity, there being few parts and but a single solution, and its extremely low internal resistance, which even in the small sizes, is considerably less than one-tenth of an ohm. As an offset it has a low electromotive force, not more than three-quarters of a volt, so that two cells would be required to work a Blake transmitter, and it is an expensive cell both in first cost and in maintenance.

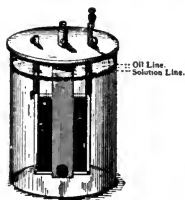

FIG. 65. EDISON-LALANDE COPPER OXIDE CELL.

## CHAPTER XXIV.

## THE PRACTICAL MANAGEMENT OF BATTERIES.

113. The battery being so important a part of a telephone equipment great care should be exercised in its selection and maintenance. The essential requisites to be observed in the selection of a battery are that the materials should be of good quality. In the Lelanché battery the carbon plate should be a hard, solid piece of gas-retort carbon; the binding post



FIG. 66. LOCK NUT BATTERY BINDING POST.

should be firmly attached to it in such a way as to guard against any risk of corrosion producing a bad contact between the plate and the post. The upper part of the carbon rod is generally soaked in paraffine wax to about an inch below the top, to prevent the solution from creeping up and crystallizing on the carbon. The zinc rod should be of pure metal and should weigh about three ounces. If a zinc plate is used it should be of rolled zinc, not cast. When the battery is set up the zinc rod is amalgamated by cleaning with dilute sulphuric acid and dipping in mercury, or by rubbing a small quantity of mercury well over the rod. The mercury adheres to the zinc and gives a bright, clean surface.

The object of the amalgamation is to prevent local action; that is, the setting up of small currents between the minute impurities that exist in even the purest grades of commercial zinc.

The film of mercury masks these foreign particles and causes them to be dissolved out as the zinc wears down without interfering with the performance of the battery by setting up local action, as they would in the absence of the mercury. The best form of binding post for both zinc and carbon elements is the double lock nut binding post with two washers (Fig. 66). This gives a far better connection than the ordinary thumb-screw binding post; it is not liable to work loose and does not damage the wire by cutting into it with the end of a screw at a single

point, as in the dome-shaped binding posts. It is quite important to have good binding posts in telephone work. Figs. 66 A and B show the best form for all connections where cords having metal tips are used.

114. The sal-ammoniac used for the solution should be as pure as can be obtained. Impurities in the solution will cause the battery to get into a dirty condition, giving deposits in the cell and on the zinc, impairing the efficiency of the battery. A test for impurities in the sal-ammoniac is to heat a small

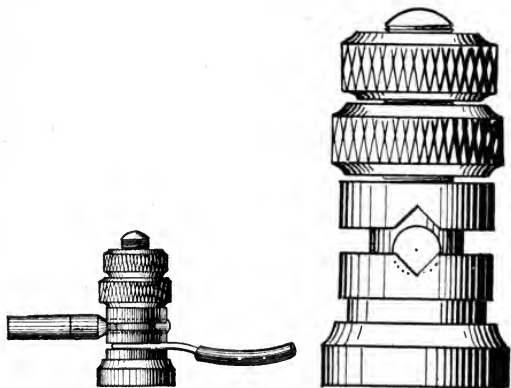

FIGS. 66A AND 66B. STANDARD LOCK NUT TELEPHONE TIP BINDING POST.

quantity over the flame of a Bunsen burner or spirit lamp. The sal-ammoniac should all go off in white fumes under the action of the heat, and if any residue is left after continued heating the sal-ammoniac is of poor quality. Another test is to add to a solution of sal-ammoniac a small quantity of hydrochloric acid and barium chloride. If the mixture becomes discolored and a precipitate is formed the sal-ammoniac is impure. Of course it is not practicable to buy chemically pure materials for batteries, but the ordinary commercial chemicals differ widely in quality, and if large quantities are used it pays to



inspect them systematically and to reject those that do not come up to a certain standard.

115. In setting up Lelanché batteries it is the usual practice to employ a saturated solution of sal-ammoniac. The risk of "creeping" will be greatly lessened, however, if the solution is slightly under the saturation point. A saturated solution should first be made, and then water to the extent of about one-tenth to one-twentieth of its volume should be added. It is a good plan to filter the solution through a coarse cloth to remove all matter floating or held in suspension in the liquid. In setting up the porous cup form of cell a small quantity of the solution should be poured into the porous cup through the hole in the sealed top. In the maintenance of the battery it should be inspected for discoloration of the solution, irregular consumption of the zinc and creeping of the solution over the tops of the plates and the containing jar. The tops of the jars are generally coated with paraffin to prevent creeping. To replenish the battery a new solution of sal-ammoniac should be used; no sal-ammoniac should ever be added to an old solution. At the same time the zinc should be washed, scraped and re-amalgamated; if the zinc is badly pitted or worn away irregularly, or eaten into near the surface of the solution, it should be thrown away, as these are signs of local action, and a new zinc should be substituted. The porous cup should be soaked in clean water for some hours and washed out. The containing jar should be thoroughly washed and dried. If any signs of creeping are observed the battery should be taken apart and thoroughly cleaned before being again set up. At all times the greatest care should be taken not to wet with the solution any part of the jar or plates above the surface of the solution in the cell, as this would almost inevitably give rise to creeping. In agglomerate batteries the carbons and agglomerate blocks or rods should be thoroughly washed and cleaned by scraping or rubbing whenever the battery is set up afresh. This applies to the carbons of batteries having no depolarizer. In most batteries the negative plate will last out several renewals of the positive, or zinc, but in time it will become clogged up with insoluble material, causing so much increase in the internal

resistance of the cell, indicated by a very weak current on short circuit, that a new carbon will be required.

116. In the Fuller battery the important point is that the zinc shall be of good quality and kept well amalgamated. A certain amount of consumption of the zinc goes on even when the battery is doing no work, but this is minimized by keeping a good supply of mercury in the porous pot for the amalgamation of the zinc. The carbon plates are similar to those used in the Leclanché battery; to get a low internal resistance three plates are used in the large sized cell. The solution placed in the porous cup with the zinc is of common salt, about three ounces of salt to a pint of water. The depolarizing solution is best made with bichromate of soda, which has various chemical advantages over bichromate of potash, and is more easily soluble in water. The proportions of the depolarizing mixture are two parts of bichromate of soda, ten parts of water and five of sulphuric acid, all by weight. Six ounces of bichromate dissolved in about a quart of water with one pound of sulphuric acid will make sufficient depolarizing solution for a half-gallon battery jar. To prepare the mixture the bichromate should be thoroughly dissolved in the water first and the acid then added very carefully and slowly; the addition of the acid causes the mixture to become heated, therefore the acid must be poured in very slowly or the sudden heat will crack the jar.

117. In the maintenance of the battery the solution in the porous cup should be renewed occasionally and the zinc cleaned; the mercury in the porous cup should be carefully preserved and the quantity kept up to the mark. The depolarizing solution should be watched for a change in color from red to brownish green; when the red color has entirely disappeared the solution is spent, and the battery must be cleaned and replenished. If the battery is doing very hard work the exciting solution will outlast the depolarizer, and in practice it is seldom necessary to change the one without also also renewing the other and making a complete job of it. On the other hand, the depolarizer is what costs in maintaining the battery, and it should not be thrown out unless it is really used up. When the battery is cleaned the carbon plates

and porous cup should be thoroughly soaked and washed in clean water. Any of the dark crystals that form on the porous cup and jar should be carefully removed; as a rule these crystals do not deposit until the solution is entirely spent and has not been renewed in time.

118. In setting up a gravity battery considerable care is necessary to prevent mixing of the solutions. The copper sulphate solution must be thoroughly saturated before the zinc-sulphate solution is added. Generally three or four pounds of sulphate of copper in crystals are added to the solution to maintain it at saturation. The weak solution of zinc sulphate is poured carefully in on top of the copper solution, which should about half fill the jar. A layer of the zinc solution is obtained sufficient to cover the zinc "crowfoot" when it is in place. The copper sulphate solution should not be replenished by dropping crystals through the zinc solution, as this will tend to cause the solutions to mix. The zinc solution should be drawn off by means of a battery syringe or a siphon. Whenever the battery gets in bad condition the solutions should be drawn off, the plates scraped and cleaned, and the zinc re-amalgamated and the battery set up afresh. If used for open circuit work the battery will require frequent cleaning out, as deposits of metallic copper form on the zinc, and the same conditions will result from moving or shaking the cells so as to cause diffusion of the solutions. The gravity battery is not a satisfactory battery for telephone work, except in situations where a continuous current is required.

119. The Edison-Lalande battery has but one solution, made by dissolving one part of caustic potash in three of water, by weight. The caustic potash is supplied in sticks of various sizes according to the size of the cell they accompany. It is highly important that the potash solution be protected from the atmosphere, or the solution will be spoiled by the formation of an insoluble carbonate of potash. The solution is therefore covered with a layer of heavy oil, which forms a separator effectually guarding it from contact with the air. The layer of oil must never be omitted or the battery will not work properly. Great care must be observed that there is no contact

between the zinc plates and the copper oxide plate within the cell, as they are very close together. For safety a plug of insulating material is generally inserted to keep them apart. If the battery is required for use immediately after it is first set up it must be short-circuited for a few minutes in order to obtain a deposit of metallic copper on the negative element. It should not be short-circuited subsequently, as owing to the low resistance of the cell the heavy current that would pass would do considerable damage. The cell requires little care in maintenance when once properly set up. There is no local action, and the layer of oil prevents creeping and evaporation of the solution. When the solution is exhausted the cell should be taken apart and thoroughly cleaned, the zinc re-amalgamated and a new solution made up. I have not had extended practical experience with this battery, which, while it has manifest advantages has two serious drawbacks in its low electromotive force and its expensiveness. The fact that the negative plate is used up should make this battery expensive to maintain; I believe the manufacturers proposed to allow for the metallic copper deposited in the batteries, as it could be again converted into the oxide, but this is an arrangement scarcely likely to meet with much favor, owing to the trouble of recovering the copper in sufficient quantity to make it worth while.

120. All batteries should be placed where they will not be exposed to extremes of heat or cold, and should be protected from dust and dirt. Where possible the cells themselves should have covers to prevent rapid evaporation of the solution. A dry, cool place is the best situation for a battery.

---

## CHAPTER XXV.

### MAGNETO BELLS.

112. The magneto bell has in this country entirely superseded the ordinary electric bell for signaling over telephone lines. It has the advantage of great convenience, long range and reliability. Its chief disadvantages are its high cost and comparative complication. The magneto bell consists properly of two

distinct parts: the generator, for sending out signals, and the ringer or bell, for receiving them. The generator is a small alternating current dynamo, (Fig. 67) having an armature wound to a high resistance with a large quantity of very fine wire, the armature being so mounted that it can be revolved in a magnetic field created by two or three powerful permanent magnets of horse-shoe form, the poles of which descend on either side of the armature.

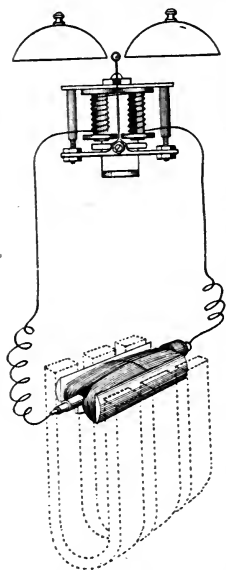

FIG. 67. MAGNETO GENERATOR AND BELL.

The efficient action of the bell depends on the permanent magnet and the adjustment of the armature, which should not stick to the poles of the magnet. Fig. 70 shows arrangement of Post magneto bell complete.

122. The armature coil of the generator has a very high resistance, so that to get good signals it is necessary that the armature coil at the receiving end

is wound with a large quantity of very fine wire, the armature being so mounted that it can be revolved in a magnetic field created by two or three powerful permanent magnets of horse-shoe form, the poles of which descend on either side of the armature. The ringer (Fig. 68) consists of a small electro-magnet with a pivoted armature that plays just over the poles; the armature carries a hammer, mounted at right angles to it, which strikes against two gongs when the armature is vibrated. A small permanent magnet is fixed to the frame carrying the electro-magnet and this magnetizes by induction the cores of the electro-magnet and the armature, giving the latter a bias toward one of the poles of the electro-magnet. This arrangement is usually called a polarized bell, it being a modification of the polarized relay used in telegraphy. When alternating currents are sent through the coils of the electro-magnet (Fig. 69) rapid reversals of magnetism are produced, which set up a vibration of the armature.

should be short circuited, or its resistance would greatly weaken the currents received by the ringer magnets. Several different styles of automatic switch have been devised to cut out the armature when it is at rest and to cut it in when revolved for sending out a call. In the form shown in Fig. 71 the coil is normally cut out by the pressure of the spindle on which the driving wheel is moun-

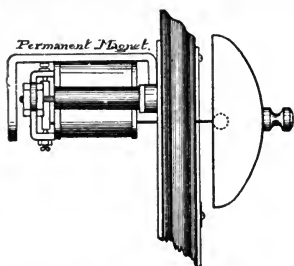

ted against a contact plate attached to an insulated block. A spiral spring, acting on a collar fixed to the spindle, holds the latter up to the contact plate and presses a pin projecting from the spindle into a notch cut in the hub of the driving wheel, which is loose on the spindle. When the handle is turned the driving wheel at first refuses to move and the pin rides out of the notch, drawing the spindle away from the contact plate and breaking the short circuit. As soon as the pin rides up on the edge of the hub the driving wheel revolves and turns the armature by the smaller geared wheel in which it engages. When the handle is let go the pressure of the spiral spring pulls the pin into the notch and the spindle again touches the contact plate, short-circuiting the armature.

123. In the Post magneto bell the cut-out works by centrifugal force and is attached to the shaft of the armature itself. One end of the armature coil is attached to the iron shuttle and the other to a stud which is insulated from the

magnets. Several different styles of automatic switch have been devised to cut out the armature when it is at rest and to cut it in when revolved for sending out a call. In the form shown in Fig. 71 the coil is normally cut out by the pressure of the spindle on which the driving wheel is moun-

ted against a contact plate attached to an insulated block. A spiral spring, acting on a collar fixed to the spindle, holds

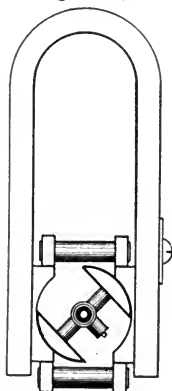

FIG. 69. SECTION OF MAGNETO GENERATOR, SHOWING PERMANENT MAGNET AND ARMATURE SHUTTLE.

iron and has a platinum contact tip. On this tip normally rests a small brass bob carried at the end of a light spring screwed to the armature shaft. By the connection between the spring and the insulated stud the armature coil is short-circuited when at rest. When the armature is revolved the effect of centrifugal force causes the brass bob to fly away from the stud, opening the short circuit. A stop prevents the bob from flying out too far. When the armature stops revolving the spring presses

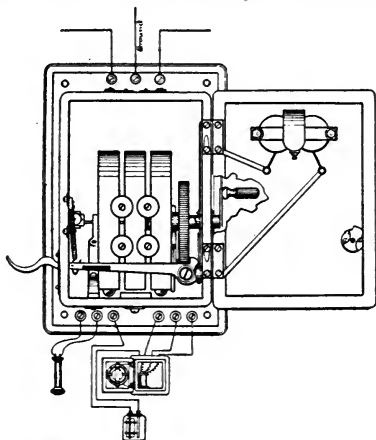

FIG. 70. COMPLETE MAGNETO-BELL. POST PATTERN.

the bob again on the contact and renews the short circuit. Fig. 71 shows the arrangement of this style of cut-out.

124. A very simple form of automatic cut-out is shown in Figs. 73 and 74. The handle by which the armature is revolved engages with the driving wheel by means of a pin working in a short slot cut in the wheel. A spring holds the pin against one end of the slot, making a good contact between the pin and the wheel; this short-circuits the armature coil, which is connected to pin and wheel. When the handle is turned the pin is moved forward to the other end of

the slot, where it presses against an insulating block fixed there; as long as the handle is turned the pin is held against the insulating piece and is insulated from the wheel, thus breaking the short circuit.

125. Magneto bells are much more satisfactory

for telephone work than electric bells. Having no battery to be looked after there is little expense for maintenance and inspection. They can be made to ring through very high resistances, that is, over very long circuits. They are, however, considerably more ex-

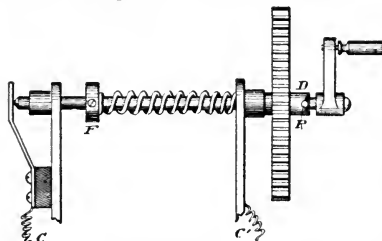

FIG. 71. AUTOMATIC CUT OUT FOR ARMATURE COIL. *C* END OF ARMATURE COIL JOINED TO CONTACT PLATE, *C'* END OF ARMATURE COIL JOINED TO SPINDLE, *D* NOTCHED HUB OF WHEEL, *P* PIN, *F* COLLAR ON SPINDLE.

pensive in first cost than an electric bell and battery, and for very short lines electric bells will be more economical. For lines of anything over half a mile magneto bells will be found more satisfactory and cheaper in the end, in spite of the first cost. They are necessarily somewhat expensive, as both material and labor are of importance in turning out a good bell. A cheaply made magneto bell, in which magnets of poor quality are used, is very liable to get out of order and to give bad results.

126. Two very simple forms of magneto generators or calls without driving gear have been devised,

one by M. Abdank-Abakanowitz, and the other by Messrs. Cox-Walker and Campbell-Swinton. M. Abdank attaches the armature, in the form of a flat coil, to a strong steel spring which plays between the poles of a horse-shoe permanent magnet. By pulling

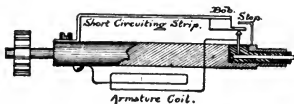

FIG. 72. POST AUTOMATIC ARMATURE CUT OUT.



the spring to one side and letting it go the armature coil is made to vibrate rapidly for some time within the magnetic field, resulting in the induction in the coil of alternating currents, which are sent out to line.

127. In the Walker-Swinton generator the armature is pivoted on a spindle between the poles of a permanent magnet, but two stops prevent it from making more than a quarter of a revolution. A handle is fitted to the spindle by which the armature may be twisted to and fro; for each movement a current is generated in the armature. This call is used with a bell giving single strokes, and it makes a handy arrangement where combination signals are wanted to distinguish between a number of different stations.

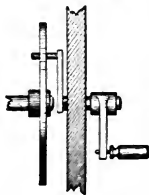

FIG. 73. AUTO-  
MATIC CUT  
OUT DRIVING  
WHEEL.

128. A form of magneto bell designed for use where several stations are operated on one line has recently been invented by J. J. Carty, of the Metropolitan Telephone company, New York. This bell, generally known as the "bridging" bell, embodies several novel features; it will be described in a separate chapter.

129. In situations where a bell is required to ring at some distance from the telephone set what is called an extension bell is used. This consists simply of the polarized bell or ringer movement of a magneto bell, placed in a small case provided with terminals for connecting to the circuit. Extension bells should not be connected directly in the line, but in the ringing circuit, so as to be cut out when the receiver is off the hook. (See Fig. 79).

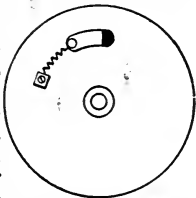

FIG. 74 AUTOMATIC  
CUT OUT.

## CHAPTER XXVI.

### THE AUTOMATIC SWITCH.

130. In a complete telephone set a switch is required to alter the connections for ringing or talking.

This switch must be so arranged that it normally connects the bell to line, enabling calls to be sent or received, and in its second position cuts out the bell and connects the line to the telephone circuit proper, at the same time closing the primary circuit of the transmitter.

131. The different circuits of a telephone set are generally known as the *ringing circuit*, consisting of the magneto generator and the polarized bell; the *talking circuit*, consisting of the secondary of the induction coil and the receiver; and the *primary circuit*, consisting of the battery, the variable resistance of the transmitter and the primary of the induction coil. The switch, then, in its normal position connects the line to the ringing circuit, leaving both talking and primary circuits open; in its second position it leaves the ringing circuit open or short-circuits it, connects the line to the talking circuit and closes the primary circuit. The switch is made to act automatically. A pivoted

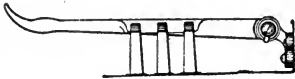

FIG. 75. AUTOMATIC SWITCH.

switch is made to act automatically. A pivoted

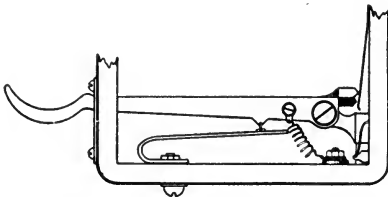

FIG. 76. IMPROVED FORM OF AUTOMATIC SWITCH.

metal lever pressed upward by a spring is held down when the telephone is not in use by the weight of the receiver, which hangs in a prong or on a hook at the free end of the lever. When the receiver is taken off the spring causes the lever to fly up. When down the lever has to make a single contact and when up it has to close two. There are several forms of automatic switches in use, and obviously there is a variety of ways in which the three contacts may be arranged.

132. It should be borne in mind that the safest

arrangement of a contact that is frequently opened and closed is that there should be a rubbing of the surfaces at each motion, so that the friction shall keep the surfaces clean. Rubbing contacts are better than pressing, and vertical contacts better than horizontal, as they are less liable to collect dust. In most forms of automatic switch one end of the secondary and one end of the primary are joined together at one of the contacts. To avoid this switches have been designed with a piece of metal insulated from the arm to close the primary circuit alone, thereby keeping it entirely distinct from the secondary of the induction coil. There is no real necessity for this arrangement, which adds to the expense of the switch, as there is no valid objection to the connec-

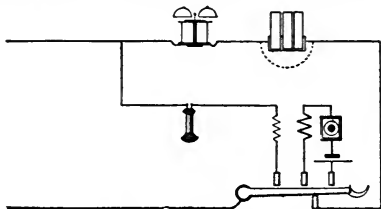

FIG. 77. DIAGRAM OF CONNECTIONS OF POST MAGNETO BELL AND TELEPHONE SET.

tion of primary and secondary at one point, provided that the contacts are properly arranged.

133. A form of automatic switch, shown in Fig. 75, that is a good deal used makes rubbing contact with vertical springs, to which the circuits are connected. When down the lever is against one spring connecting with the ringing circuit and when up it is clear of this spring and against three others corresponding to the talking and primary circuits, the lever itself being permanently connected with the line.

134. Another form of switch, shown in Fig. 76, makes the connection with the ringing circuit by pressing on a strong spring contact, and the talking and primary circuit connections by means of a projection at the pivoted end of the lever which rubs against vertical springs when the lever goes up. Insulating blocks on the lever take the pressure of the

different springs, so that in each position of the lever the spring or springs not in metallic contact are properly insulated. The contacts in each case are accompanied by a certain amount of rubbing between the metal surfaces. This is a very good style of switch and is now used on all the standard forms of telephone sets. The attachment of the line to the arm of the switch is always made by a separate connection and not through the bracket and pivot. This provides against any risk of a bad connection in the pivot through the presence of grease or corrosion.

135. Two different methods of arranging the con-

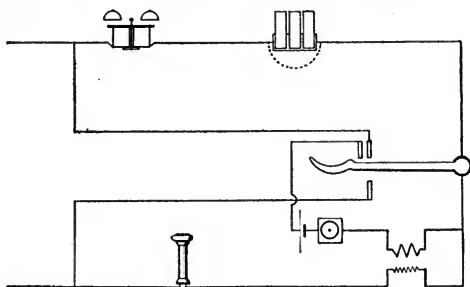

FIG. 78. DIAGRAM OF CONNECTIONS OF W. E. NO. 2 MAGNETO BELL AND TELEPHONE SET.

nections of the different circuits and the automatic switch are shown in Figs. 77 and 78. Fig. 77 shows that usually employed with what is known as the Post magneto bell. It will be noticed that the line is connected to the lever, which passes it either to the ringing or to the talking circuit. When the lever is up it closes the primary circuit by connecting the two springs. Fig. 78 shows the connections of the Western Electric No. 2 magneto bell. The switch has one lower and two upper contacts. The line is connected to the ringing circuit with a branch running to one of the upper contacts. The lower contact is connected to the return wire or to the ground; the primary circuit is connected to the second upper contact and to the talking circuit. The second side of the ringing circuit and one side

of the talking circuit are connected to the lever, the second side of the talking circuit being connected to the return line or to ground. When the lever is down the current passes through the ringing circuit and by the lever out to line or to ground by the lower spring contact; when the lever is up it short-circuits the ringing circuit, throwing the line onto the talking circuit and closing the primary circuit. This arrangement is unnecessarily complicated and has several defects, notably that the ringing circuit is not left open when the telephone is to line; if the contact between the lever and the first upper spring is not good the ringing circuit makes a shunt across

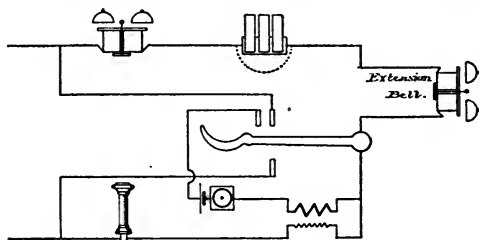

FIG. 79. DIAGRAM SHOWING PROPER CONNECTIONS OF EXTENSION BELL.

the talking circuit, to the detriment of good transmission.

136. The automatic switch is always placed in the case of the magneto bell, the hook for holding the receiver projecting through a slot in the side. The spring controlling the switch should be powerful, to ensure firm contacts. The contact surfaces should be faced with platinum. The connection with the lever should be made by a spiral coil of wire or short, metal arm connected directly with the lever, as the pivot is liable to introduce resistance. Fig. 79 shows the proper method of connecting a series extension bell.

137. In the British Post Office telephone system the automatic switch is arranged to send both call and ring-off signal to the central office. A battery current is used instead of magneto generators. A

steady current is kept to line, and the action of taking the receiver off the hook breaks the current and throws an indicator needle at the central office. Hanging up the receiver closes the circuit and throws the indicator needle back to its normal position. This is a very convenient arrangement where battery current is used for signalling, and not only simplifies the subscriber's operations but also saves time. It necessitates, however, the maintenance of a large number of batteries.

---

## CHAPTER XXVII.

### TELEPHONE LINE CONSTRUCTION.

138. In the early days of telephony it was considered that any kind of construction was good enough for telephone work, and as a consequence telephone installations generally worked badly. To-day the reverse is the case, and the very best construction is not thought too good. In good practice every possible refinement in construction and equipment is carried out, down to the smallest details. A very little consideration of the case is required to see how necessary this is. The telephone is the most sensitive electrical instrument known, and as it is so sensitive the introduction of all foreign currents into the line, either by induction or by leakage, must be carefully guarded against. The telephonic current, even from the most powerful carbon transmitter, is a feeble current compared with those employed, for instance, in telegraphy, and therefore undue loss by leakage or in overcoming resistance must be avoided. Leakage, too, is double-acting in its bad effects, as it facilitates the introduction of foreign currents into the line. In the telephone line, then, we need a good conductor; that is, one of low resistance, well insulated, and as far removed as possible from sources of induction.

139. For short distance lines galvanized iron or steel wire is used on account of its strength and cheapness, the relatively high resistance of iron not being a great objection on short lines. For long distance work copper wire has entirely superseded iron.

140. The electrical properties of copper render

it greatly superior to iron for telegraph and especially for telephone lines. The conductivity of copper is six times higher than that of iron, so that for the same resistance a copper wire will have only one-sixth the weight of an iron wire. Another advantage is that the speed of transmission is greater over a copper than over an iron wire, as the quality termed *electro-magnetic inertia* (that is, the tendency of the conductor to check the speed of the current in traveling along it) is much less pronounced in copper than in iron. This is of great importance in telephony, owing to the extremely rapid reversals and variations in strength of the telephonic current. Hard drawn copper wire is now made practically of equal strength with iron or steel, so that the mechanical objections to its use for overhead line construction that obtained before the introduction of the hard drawing process no longer exist.

141. The size of hard drawn copper wire generally used for telephone lines in this country is No. 12, standard gauge, having a diameter of 104 mils, a weight of 166 pounds per mile and a resistance of 5.2 ohms per mile. For short lines No. 14, diameter 80 mils, weight 102 pounds, and resistance 8.7 ohms per mile, is a sufficiently heavy wire, and amply strong enough if carefully put up, with not too long spans. The practice of calling different sizes of wire either by their weight per mile or their diameter in mils (thousandths of an inch) is fortunately increasing, as either way is much less confusing than the use of any one of the numerous gauges now in existence. Two handy rules to remember in connection with the diameter, weight and resistance of copper wires are these: The weight in pounds per mile can be found by dividing the square of the diameter in mils by the constant 62.57; and, conversely, the diameter can be found from the weight by multiplying the weight by 62.57 and extracting the square root of the number obtained. The resistance in ohms per mile is found by dividing the constant 890 by the weight per mile. (See Appendix.)

142. Hard drawn copper wire should be pliable, not brittle, perfectly cylindrical and uniform in quality, and free from scales, flaws, splits and other defects. It should be in long pieces; the minimum

weight of a coil without joint is generally fixed at 50 pounds. When bought in large quantities the wire is generally tested for tensile strength and ductility. The breaking weight of the 104 mils wire should be not less than 500 pounds, and the wire should take 24 twists in three inches without break-

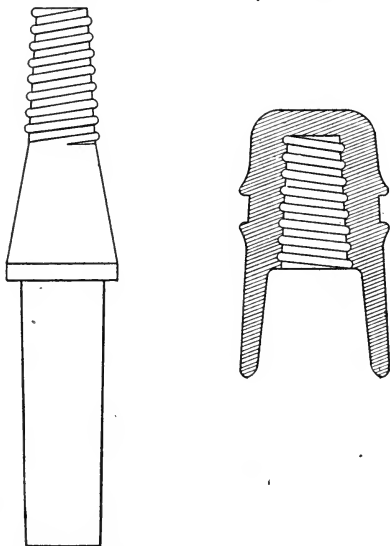

FIG. 80. TELEPHONE INSULATOR AND PIN.

ing. A good test for the ductility of hard drawn copper wire is to wrap a piece of the wire six times around itself, unwrap, and wrap again six times in the same direction; the wire should stand this performance without breaking. The resistance of wire for overhead work is measured at a temperature of 60 F. A change of 1° F. in the temperature of a copper wire changes its resistance about one-fifth of one per cent. If the temperature increases the resistance increases, and *vice versa*. Thus, a wire having a



resistance of 100 ohms at  $60^\circ$  will measure 102 ohms at  $70^\circ$  and but 98 ohms at  $50^\circ$ .

143. The insulator generally used for telephone lines is of clear glass of the form shown in Fig. 80. It is about 4 inches high and  $2\frac{1}{4}$  inches in diameter;

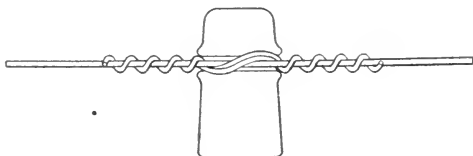

FIG. 81. METHOD OF TYING LINE WIRE TO INSULATOR.

the sides are vertical, and the groove for the wire is placed well above the centre. This style of insulator has given good results, and is largely used; its shape insures good insulation and the clear glass is found to be better than green, as the free penetration of light discourages insects from making their homes under the insulators. The insulator is threaded for



FIG. 82. AMERICAN TELEGRAPH JOINT.

a locust pin 1 inch in diameter at the threaded part and  $1\frac{1}{4}$  inches at the socket. The pin is generally fitted into a hole in the centre of the cross arm and held by a nail driven through cross arm and pin. The method of tying the wire to the insulator is shown in Fig. 81. A piece of wire of the same size as the line wire, and about two feet long, is carried once round the groove in the insulator, the ends crossed over and lapped round the line wire five or six times.

This makes a strong tie if properly done, and is much quicker than tying with a finer size of wire, which necessitates a much greater number of turns. In terminating a line the wire is generally "dead ended" on either a shackle or an ordinary insulator; the wire is given a round turn on the insulator, and the free end is brought back and twisted round the taut



FIG. 83. BRITANNIA JOINT. A piece of the end is generally left projecting beyond the joint for attaching the leading in wire; with the twisted sleeves the leading in wire can be joined directly to the line.

144. Particular care is necessary in making the joints in a telephone wire, as a loose joint is apt to constitute a sort of microphonic contact in itself and to produce noises in the line. The ordinary telegraph joint, Fig. 82, is not reliable enough for telephone work and should not be used. When it is used the joint should be carefully covered over with tin foil and taped with ordinary jointing tape. This will tend to keep out moisture and prevent corrosion. No American linemen can be induced to solder joints, and the tin foil and tape covering has been introduced as a substitute, but it is a poor makeshift. The Britannia joint, Fig. 83, made by overlapping the ends of the wires and binding them with a fine tie wire is very much safer, but requires to be soldered to make a good job of it. The quickest and safest



FIG. 84. MCINTYRE SLEEVE JOINT.

way of jointing is by the use of the well-known McIntyre sleeves, Fig. 84. The ends of the wires are slipped into a double sleeve of the proper size, and the sleeve is then twisted with a special tool. These joints have given excellent results, both electrically and mechanically, and they are very quickly made.

145. The construction of an overhead line must always be governed by the local conditions, the number of wires to be erected, their weight and so on.

In putting up copper wire in hot weather, the precaution should be taken not to stretch it too tautly or the contraction of the wire the following winter will cause trouble. Hard drawn copper requires considerable care in handling to prevent kinks or bruises which may cause breaks when the wire is strained up. The spans may vary from 250 feet for a single line to 130 feet for a line carrying a large number of wires. The details of poles and pole setting, housetop fixtures, etc., will vary in almost every case, and there is very little that can be laid down specifically that will apply to all. The most important points to be observed are substantial construction in all respects, poles one-sixth, at the least, in the ground, placed nearer together on curves than on the straight, properly guyed or braced against side or unequal strains, and the wires kept well clear of trees, buildings or projections, and of all other wires or fixtures. On lines carrying a large number of wires the cross arms should be braced to the pole with iron braces. Cross arms are generally made of seasoned pine and should be thoroughly painted before being put up. They should be braced to the poles with galvanized iron strap braces, as shown in Fig. 85. The best material for poles is live cedar or chestnut. Nothing shorter than an eighteen-foot pole should be used, even for a single circuit in open country; for a heavy line poles of about twice this length are generally used. Excessively tall poles are not advisable except where absolutely necessary to make crossings or to clear other lines, as the leverage is so great that in heavy storms they are liable to be broken off short or pulled entirely out of the ground. To protect the wires from lightning discharges a heavy galvanized iron wire is stapled to the pole from top to bottom; the lower end is coiled round the pole two or three times to give good earth contact. These lightning rods should be placed not less frequently than at every tenth pole.

---

## CHAPTER XXVIII.

### METALLIC CIRCUITS.

146. The essential feature of a metallic circuit telephone line is that the two sides of the circuit

should be properly balanced as regards their electrical qualities and conditions. Any departure from this rule will result in a noisy line. Each wire of the circuit should have as nearly as possible the same resistance, insulation and electrostatic capacity. Generally speaking this means that the two wires should be of the same material, diameter and length, should be equally carefully insulated, and that both

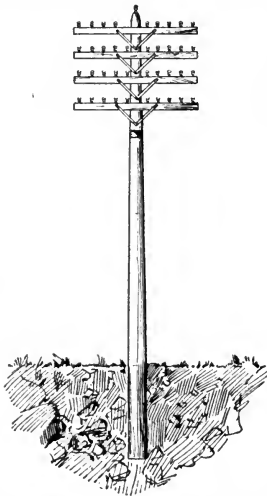

FIG. 85. STANDARD TELEPHONE LINE CONSTRUCTION.

should be carried on the same poles, and even on the same cross arms. The electrostatic capacity of a wire depends upon the surface it exposes (in other words, upon its diameter) and upon the height at which it is strung above the ground (See Chap. 34). It is of the highest importance that a telephone line, especially where long circuits are concerned, should have a low capacity, as the effect of capacity is to deaden and muffle the transmission. In this we have another reason why copper is better than iron for telephone wire; for the same resistance a copper is much smaller than an iron wire, and consequently the capacity is much less, as the surface exposed is less. For example, the superficial area exposed by a mile of copper wire having a resistance of 5.2 ohms is 143.75 square feet, and that of an iron wire having a resistance of 6.75 ohms, which is the largest size generally used, is 334.5 square feet, or nearly two and a half times as much. The capacity of an overhead wire, however, does not vary directly as its surface. In the instance just given the capacity of the copper wire should be from 10 to 15 per cent

lower than the iron, assuming the two to be strung at the same height above the ground. The capacity of a single wire is measured against the ground. The capacity of a loop or metallic circuit entirely disconnected from the ground is considerably less than the capacity of one of its wires against the ground. Theoretically it should be just one-half,

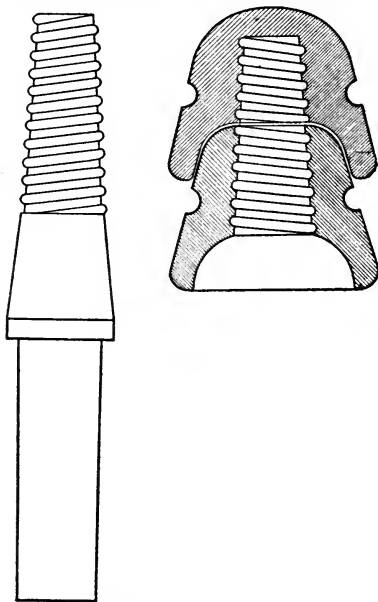

FIG. 86. TRANSPOSITION INSULATOR AND PIN.

but practically the capacity of an overhead metallic circuit is found to be about 60 per cent. of the capacity of one of its wires against the ground.

147. To insure a quiet line not only must the electrical qualities of each wire of a metallic circuit be alike, but the electrical conditions produced by other neighboring wires must also affect each wire equally.

In other words, the relative exposure of each side of the circuit to sources of induction must be the same. This applies principally to other telegraphic or telephonic lines on the same set of poles. Even between two telephonic metallic circuits there may be strong induction, or "cross talk," as it is generally called,

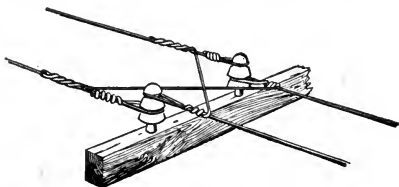

FIG. 87. TRANSPOSITION OF METALLIC CIRCUIT.

if means be not taken to prevent it. The usual method is to cross or transpose the two wires of a circuit at certain poles along the line, so that for occasional stretches each wire takes the place of the other. The number of transpositions made varies according to the number of circuits on the line. On the main long distance telephone lines transposi-

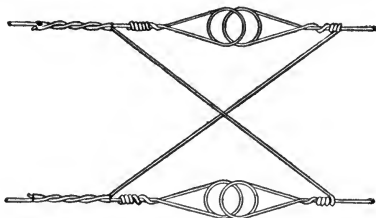

FIG. 88. PLAN OF TRANSPOSITION OF METALLIC CIRCUIT.

tions are made about every quarter of a mile, but only on some of the circuits at each point; a regular system of transpositions is worked out for each particular line, according to the number of circuits. The peculiar style of insulator used for making transpositions is shown in Fig. 86. It consists of two cup-shaped glass insulators screwed on the same pin. The method

of making the transposition is clearly shown in Figs. 87 and 88. The transposition insulators make a break in each wire, the two ends of each side of the metallic circuit being dead-ended on the upper and lower cups of each insulator. By cross connecting the two wires on the upper insulators and the two on the lower the transposition is made and in the next span the relative position of the wires is reversed, the left hand becoming the right. The effect of the transposition is to cause any induced currents to be set up equally in each wire; they thus neutralize each other, and no disturbance is produced in the telephones at the terminal station. In comparatively short lines (of twenty or thirty miles) very few transpositions are needed to secure silence, but the number requisite must generally be determined by experiment.

148. In England the practice obtains to some extent of changing the position of the wires at each cross arm, so that in every four spans the two wires of a circuit make a complete twist around each other. (See Fig. 89.) This is effective against induction, but does not make a slightly line, nor is it such simple construction as the transposition system.

---

## CHAPTER XXIX.

### UNDERGROUND WIRES.

149. During the last few years overhead pole lines have been prohibited in many large cities and the telephone companies have been obliged to place their wires underground. Underground wires are peculiarly unfavorable to telephone work on account of their necessarily high electrostatic capacity, which is to a certain extent increased by the nearness of the wires to each other, as for economy a large number of wires have to be placed in a small space. In the last chapter it was stated that the capacity of an overhead wire depends on the height at which it is strung above the ground, which is the same as saying that it depends on the thickness of the layer of insulating material (in this case the air) that separates it from the ground. When a number of grounded circuits are on the same pole the capacity of the wires

is increased, as the ground is thus brought nearer to them. In underground cables the wires are brought nearer to the ground in two ways; actually, and because of the close proximity of the wires to each other.

150. The electrostatic capacity of different insulators varies widely. Gutta percha, rubber and rubber compounds have the highest; paper, cotton, hemp and fibrous materials generally, oils and waxes, have a much lower capacity, and dry air has the lowest of any insulator known. The capacity of a mile of submarine cable conductor is more than twenty times higher than that of an overhead copper wire of approximately equal resistance. The capacity of a conductor in the type of underground telephone cable

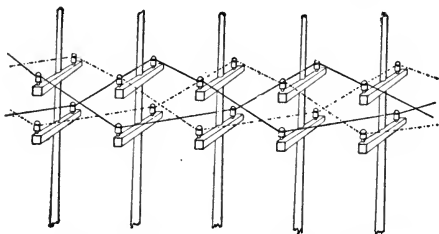

FIG. 89. ENGLISH METHOD OF TRANSPOSING METALLIC CIRCUIT.

put down three years ago, with cotton and paraffin insulation, is about twelve times higher than that of an overhead copper wire 104 mils in diameter; in this case the resistance of the underground conductor is about seven times that of the overhead, as a much smaller wire is used.

151. The standard type of underground telephone cable contains 100 wires. These are twisted in pairs with a lay of about three inches, and the pairs are cabled in reverse layers, forming a cable about  $1\frac{1}{2}$  inches in diameter. This cable is enclosed in a lead pipe having an internal diameter of  $1\frac{1}{2}$  inches. The pipe (Fig. 90) is one-eighth inch thick, and is alloyed with three per cent. of tin to prevent chemical action tending to eat away the lead. The conductors and



insulation of telephone cables have undergone considerable change during the few years that telephone cables have been developing. Three years ago the conductors were No. 18 B. & S. (40.3 mils), having a resistance of about 34 ohms per mile, and were insulated to an outside diameter of one-eighth of an inch with either cotton, hemp or paper. The cotton was impregnated with paraffin, and the hemp or paper with a compound containing principally resin oil. The object of the paraffin or compound was to prevent moisture from penetrating far into the core in case of the rupture of the lead, as both cotton and

paper absorb moisture very readily. Such cables had the disadvantage of losing their insulation very rapidly when exposed to heat, as occurs where steam pipes are laid near the conduits. In many parts of the subways in New York the temperature is kept permanently far above 100° F. by the steam pipes. In such situations "dry core" cables, that is, cables without the filling of

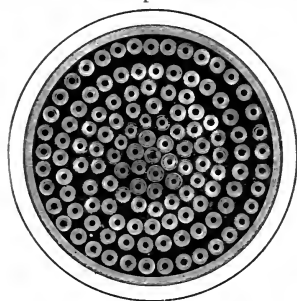

FIG. 90. STANDARD TYPE OF UNDERGROUND TELEPHONE CABLE.

paraffin or compound, were used. On account of the absence of the filling these cables had a very much lower capacity than the treated cables, as the insulation consisted merely of dry cotton or paper and air. They depended for their insulation entirely on the continuity of the lead pipe, as any break or puncture would quickly cause every wire to become grounded, through the absorption of moisture. It was found that accidents very rarely happened to the lead pipe, and "dry core" cables have been adopted altogether on account of the great saving in capacity. With the object of still further reducing the capacity, the insulating covering is applied to the wire in various ingenious ways so as to allow of as much air space as possible around the

conductors, while still effectively insulating them from each other. A size smaller conductor is used, and a further slight gain is thus effected. The standard cable of to-day contains conductors of No. 19 B. & S. (35.9 mils), having a resistance of about 45 ohms per mile. The average electrostatic capacity allowed is .085 microfarad per mile, as compared with .18 microfarad per mile for the old type, or less than half. Competition among manufacturers has resulted in the production of cables having a capacity of less than .07 microfarad per mile, a gain of 60 per cent. over the old type. This is of considerable importance in long distance telephony, where the capacity very quickly mounts up when considerable lengths of cable have to be included in the circuit. The increase in the resistance of the underground conductors from 34 to 45 ohms per mile does not have any appreciable effect on the quality of transmission. The insulation resistance of the conductors of underground telephone cables is required to be not less than 500 megohms per mile after the cable is laid and connected up to the cable heads. Practically the results obtained are always much in excess of this figure, frequently several thousand megohms per mile.

152. The cables are drawn into the conduits in the ordinary way, joints being made in manholes placed 200 to 300 feet apart. Various kinds of ducts are used in different cities, 3-inch iron pipes laid in cement probably being in the majority. At each terminal point the cables are connected by a wiped joint to long boxes, made either of iron or hard rubber (Fig. 91). The wires are fanned out inside the cable head and connected in proper order to double binding posts passing through the sides of the cable head. From the outer ends of these binding posts connections are made to the subscribers' instruments and exchange apparatus. Lightning arresters and fuses are generally inserted in the circuit at the cable head to prevent injury to the cable conductors by strong currents.

153. At telephone exchanges the cables are led into a special department called the underground terminal room, where the cable heads, are arranged on iron frameworks conveniently for extending the

connections to the switchboard cables. The outer terminals of the cables are placed in situations from where a group of subscribers can be reached by short extensions of aerial cables or overhead lines. Sometimes the outer terminal is in the basement of a large office building containing a number of subscribers, and sometimes on a pole for connecting to the long distance wires. The cable heads are always protected by weatherproof boxes which are kept padlocked.

154. In an exchange where a large number of cables enter, a cross-connecting or distributing board is generally placed in the terminal room to facilitate the work that is constantly going on of making and changing the connections of the subscribers' lines to the switchboard cables. The distributing board (Fig. 92) is a long, narrow framework of iron piping having numerous longitudinal and cross supports to carry the wires. At each side are attached rows of terminals consisting of little double metal ears mounted on insulating strips. On one side of the board wires leading from the switchboard are soldered to the metal ears in regular order, and on the other are connected wires from the underground cables, also in regular order.

All that is necessary to connect any pair of cable conductors to any given switchboard number is to run a pair of wires through the framework and solder the ends to the proper terminals at each side. The cross-connecting wires can be unsoldered at any time when a disconnection or change is required. Proper routes, or runs, are maintained for passing the cross-connecting wires through the framework so that any pair can be drawn out if needed. This arrangement greatly simplifies the work of connecting the lines to the switchboard and avoids an immense amount of confusion in large ex-

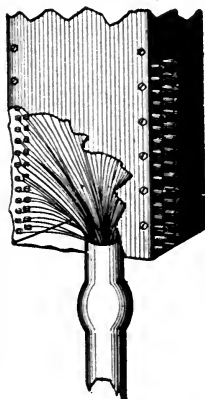

FIG. 91. UNDERGROUND CABLE TERMINAL.

changes. The cross-connecting wires are twisted in pairs, one wire being the ordinary color and the other colored red so that the distinction between "line" and "test" can readily be made.

155. Underground cables are made in sizes from 25 to 100 pairs; 50 pairs is the standard size generally used. To allow for the chance of breaking a wire during the cabling, manufacturers generally lay up 51 or 101 pairs. For short underground wires for telephone circuits there are various types of cable available, insulated either with treated paper or with rubber compounds. They should be run in an iron pipe

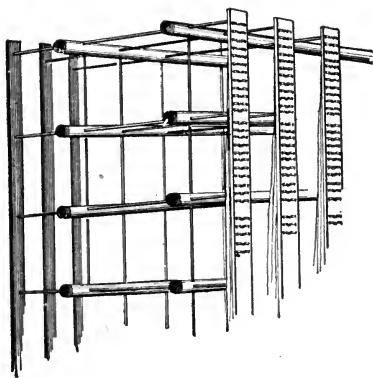

FIG. 92. CROSS-CONNECTING BOARD.

or wooden casing to prevent mechanical injury; or if the wire is laid directly in the ground it should be armored with a lead or iron sheathing. An unarmored insulated wire laid directly in the ground will seldom survive long. The best plan is to use rubber covered wires taped or braided and tarred, drawn either into an iron pipe or a creosoted wood conduit. If anything goes wrong with the wires they can be drawn out and repaired, and new wires can also be added with ease when necessary. For short circuits the relatively high capacity of rubber insulation is not prohibitive. Where a number of wires are placed in the same pipe they should be twisted in pairs or

laid up in fours (the two wires diametrically opposite being used for a circuit), otherwise there will be induction between the various circuits.

156. Aerial cables for telephone work are generally made of No. 18 B. & S. wire, insulated with rubber compound to 3-32 of an inch. The wires are twisted in pairs and laid up into a cable containing the required number of pairs. The separate layers are taped, and the cable is wrapped with two strong tapes impregnated in preservative compound and laid on in reverse layers.

157. Submarine cables for telephone work are generally made with stranded conductors, which give greater strength and pliability than a solid wire. The conductor is a strand of 7-22 (B. & S.) insulated to 8-32 of an inch with rubber compound. The cores are laid up in fours, and the groups of four cabled together with a long lay, or else are simply twisted in pairs and laid up in the same manner as an aerial or underground cable. The cable is served with hemp and armored with galvanized iron wire. The armoring should be protected by two layers of hemp soaked in a compound of pitch and silica.

158. In American telephone practice the two wires of a metallic circuit are always referred to as "line" and "test." The "line" is considered the original line wire, and the "test" the return. This naming of the wires runs through cables and connecting wires and the switchboard cables, with which it originates. In metallic circuit switchboards the cables running through the board are twisted in pairs throughout; the battery that enables the operators to test whether a line is busy is always applied to the same wire, which has come to be called the "test" wire. In underground cables the two wires of a twisted pair are often called No. so-and-so and "mate."

---

## CHAPTER XXX.

### LIGHTNING ARRESTERS.

159. Ordinary telephone sets were formerly provided with a so-called lightning arrester of the form shown in Fig. 93. The lightning discharge is supposed to jump across the space between the saw-

teeth or screw points and pass to earth along the ground wire connected to the central plate. It rarely does so, however, and these arresters do not always protect the instruments.

160. With the multiplicity of wires that exists to-day telephone lines need protection from other dangers besides atmospheric electricity. A cross may introduce into a telephone line two distinct foreign currents, both dangerous. One, a heavy current from a lighting or power circuit that would immediately burn out anything it was led into, the other, what is known by telephone men as a "sneak current"—that is, a relatively feeble current that would not do immediate harm, but, circulating in a

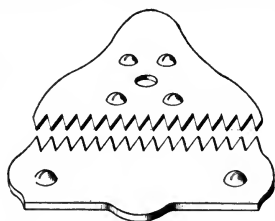

FIG. 93. OBSOLETE SAW-TOOTH LIGHTNING ARRESTER.

bell or annunciator coil, would store up sufficient heat within a comparatively short time to burn it out. With metallic circuits there is yet another danger. As there is no connection with the ground a cross with a high voltage wire would produce no flow of current, but would charge the circuit to the voltage of the foreign wire and a

contact with any part of the telephone circuit might produce dangerous results, even to the person. This is a comparatively remote risk, but still one that requires to be guarded against in crowded localities.

161. The simplest form of protector is a fine fusible wire which is inserted in the circuit between the end of the line and the instruments, in any secure position, Fig. 93 A. This is not a very good form used alone, as the fusible wire when blown out is apt to be replaced by a piece of copper wire, giving the appearance of protection without the reality, which is worse than no protector at all. A very simple form of fusible protector for strong and sneak currents is that known as the Hibbard, Fig. 94. It consists of a strip of fusible foil rolled up with an asbestos tape, making a little cylinder which is slipped between two upright springs that make contact with the

inner and outer end of the fusible strip. These "corn-plaster" fuses, as linemen and inspectors call them, are made to blow out at either half an ampere or one ampere. They are generally placed at the cable terminals and at the subscribers' instruments.



FIG. 93 A. SNEAK CURRENT PROTECTOR. OPERATES BY HEATING OF SMALL COIL, WHICH CAUSES FUSIBLE WIRE TO MELT.

162. The fuse for the outer terminal of an underground cable is calculated to blow out with a current of eight amperes. More delicate fuses were at first used, but it was found that

interruption of service was often caused by delay in replacing burnt out fuses owing to the difficulty of getting at some of the cable terminals. Any foreign current within the carrying capacity of the cable itself is taken care of by the protectors at the central office or subscribers' instruments, Fig. 95.

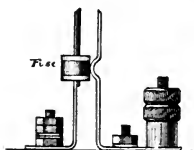

FIG. 94. HIBBARD LIGHTNING ARRESTER.

163. There is a class of protectors sometimes used for telephone work which employ a spring arm normally held in position by the armature of a small electromagnet. Both arm and magnet coil are included in the telephone line circuit.

The ordinary telephone and ringing currents do not operate the electromagnet, but a foreign current of any but very feeble strength will do so, causing the release of the arm, which breaks the line and cuts off the instruments beyond the protector, Fig. 96.

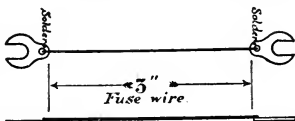

FIG. 95. FUSE FOR OUTER CABLE TERMINAL.

Some of this style of protector also have a fusible wire cut-out. The best practice

does not countenance the use of protectors employing electromagnets connected in the telephone circuit, owing to the retarding effect of the magnet coils on the telephonic current and consequent loss in transmission. (See Chap. 35).

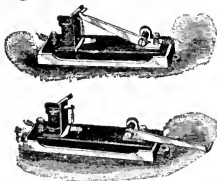

FIG. 96. PLUSH PROTECTOR. CLOSED AND OPEN (OPERATED BY HEAVY CURRENT, MAGNET RELEASES ARM, BREAKING CIRCUIT).

current arrester, which seconds under the influence of a steady current of three-tenths of an ampere. The air space cut-out consists of two carbon blocks separated by a thin sheet of mica with a perforation in the center; the upper carbon block has a drop of fusible metal let into its lower face to complete the short circuit when the current sparks across the space.

164. The style of protector now generally used between the lines and the central office apparatus and also at the subscribers' instruments is shown in Figs. 97 and 98. It comprises an air space cut-out, which blows out when the pressure on the circuit reaches 300 volts, and a sneak

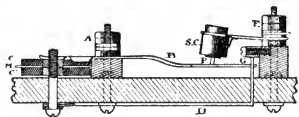

FIG. 97. COMBINATION PROTECTOR. *A* LINE POST, *E* INSTRUMENT POST, *B* GERMAN SILVER SPRING, *CC* CARBON BLOCKS, *M* MICA SHEET, *S C* SNEAK COIL, *P* RELEASING PIN, *G* GROUNDING STRIP, *D* GROUND WIRE.

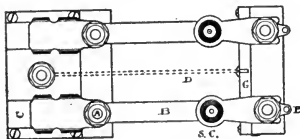

FIG. 98. PLAN OF COMBINATION PROTECTOR.

The lower block rests on a metal strip connected to ground and the upper one is held in position by a spring connected to the line. The sneak current arrester is a tiny spool of fine German silver wire measuring 28 ohms resistance. In the center of the spool



is fitted a metal pin which normally is prevented from passing clear through by a drop of fusible alloy. The line spring presses against the lower end of the pin; the pin is released when the alloy is melted by the heating of the coil by a foreign current, allowing the line spring to fly up and make contact with a grounding strip. The line is then grounded and the apparatus beyond the protector cut out. These protectors are generally placed on the inner cable terminals and on the subscribers' instruments. The cable conductors are protected by eight-ampere fuses connected in the line at the outer terminals (Fig. 95).

## CHAPTER XXXI.

### INSIDE WIRING.

165. The inside wiring of a telephone installation should be carefully and substantially executed, as many annoying and unnecessary defects are liable to arise from careless work and the use of inferior materials. The leading in wire should be soldered to the line or jointed by means of the McIntyre sleeve (see Chap. 27). In passing the wire through a window or door frame a hard rubber tube should be used to protect the wires, the tube having a downward slope toward the outer end, or having the outer end bent down, so as to prevent the entrance of water through the tube. In running inside wires they should be in protected positions, under the flooring or ceilings where possible, and should be cleated to woodwork, not on plaster or brick. For brick work porcelain insulators should be used. If staples or double-pointed tacks are used they should be of the insulating variety having saddles of insulating material under the staple. Some care is required in driving staples hard enough to grip the wire firmly without cutting into the insulation.

166. A good quality of rubber insulated wire<sup>1</sup> should be used for all inside wiring. No. 18 B. & S. insulated to 3-32 is a safe wire to use for house or

---

<sup>1</sup> Where rubber insulated wire is referred to it is understood that any of the standard makes of high class insulated wire is meant. Experience and price govern the particular kind used.

office work. Stouter wire, say No. 16, with 5-32 should be used in buildings where the wiring is much exposed. For metallic circuit lines the inside wiring should be a twisted pair throughout. In offices and houses a neat effect is produced by using a braided cord, colored to match the wood-work, for running down to the instrument.

167. Some of the large modern office buildings are wired throughout for various electric services before the final work on the building is done. Wires are led to each room for electric lighting, district messenger and telephone service. The telephone wires are generally concentrated at a cross-connecting board placed in the basement. A short cable is taken from the underground terminal to the cross-connecting board and connections are made there with the several circuits as required. In the subscriber's office all that is necessary is to run a pair of wires from the ends of the building circuit to the place selected for the telephone. These wholesale wiring installations are often not well done; the work is let out by contract and the lowest bid is generally taken indiscriminately. Consequently the peculiar requirements of telephone work are seldom consulted and trouble not infrequently arises.

---

## CHAPTER XXXII

### INSTALLATION OF TELEPHONES.

168. The chief points to be observed in putting up a wall telephone set are to place it against a solid wall, so that no ordinary vibration of the building shall affect it, and in such a position as regards neighboring objects that the receiver and bell crank can be got at easily, and as regards height from floor so that those who will require to use it most can speak to the transmitter without undue stretching or stooping. A brick and plaster wall should be plugged with four taper wooden plugs, about 3 inches long and 1 inch in diameter at the thick end, hammered flush with the wall, to receive the screws that go through the four corners of the back-board. The user of the telephone will generally indicate the most convenient place for it, and his wishes should of course be respected, provided that the instrument will have a fair chance in

the position selected. If it is obviously unsuitable, this should be pointed out and explained, in the interest of the customer himself. Any situation that will cause the telephone to be in the way of office traffic should be avoided, both because of the risk of the instrument getting damaged by accidental collision and because of annoyance to anyone talking of having people pass close by frequently. The best place for an office telephone is in a small closet or space partitioned off on purpose, but many people do not care either to go to the expense or to give up the necessary space.

169. Long distance cabinet sets, on account of their ornamental appearance, are generally given a good position without any difficulty, and little trouble is ever experienced in placing them conveniently for all concerned. Where the telephone is much used for important conversations the sound-proof silence booths used in pay stations add much to the general comfort and ease of communication. These are also made of very compact dimensions for the upright or wall long distance set. In placing desk sets (see Fig. 40) a safe place must be found for the battery as near as possible to the transmitter to save resistance in the leads from battery to transmitter (see Chaps. 15 and 16). The battery is generally placed in a covered box in the well of the desk or in one of the cupboards. A magneto generator and an extension bell have to be attached to the desk in places convenient to the user, as the nickel-plated standard carries only the transmitter and receiver; the induction coil is sometimes placed in the base of the standard and is sometimes separate. Desk sets are chiefly used in the offices of telephone buildings where the current from the exchange generators can be used for calling, hand generators not being required. They are an extremely handy form of instrument, however, and are much appreciated by telephone users.

170. Batteries should always be carefully covered up and placed where the solution will not evaporate quickly; at the same time they should be accessible for inspection and recharging. Where grounded circuits are used, and they are still in the great majority, the ground connection must be made with extreme care. A great deal of disturbance in the line

may arise from a faulty ground connection. The ground wire should be soldered to a water pipe, not to a gas pipe, as gas pipe joints often have high electrical resistance. Several inches of the pipe should be scraped and filed clean and bright and about 6 or 8 feet of the ground wire bared and thoroughly scoured with emery paper. The copper wire is then wrapped firmly around the pipe and securely soldered. In the country, where a good water pipe is not available, the ground connection may be made to a pump. If ground plates are used they should be two or three feet square (preferably of copper, though iron may be used), buried in damp earth. A layer of coke above and below the plate will improve the ground, and if the earth is dry plenty of water should be poured over the plate and coke. On a short line with two ground plates use the same metal for both plates. Two different metals will form a galvanic couple, setting up currents in the line and causing disturbance.

171. It is a good plan to use every opportunity to teach customers how to use the telephone properly. Very few people know, even to-day, when there are half a million telephones at work in the United States, and many complaints arise solely from the inexperience or ineptitude of the customer. The receiver should be held tightly against the ear; a very appreciable difference will be noticed if the ear piece is placed loosely against the ear and if it is held firmly up to it. Eight telephone users out of ten do not hold the receiver properly. With a Blake transmitter the lips should be about an inch or two from the mouthpiece and squarely in front of it, so as to direct the voice straight at the diaphragm. With a long distance or solid back transmitter the lips should be close up to the mouthpiece, almost touching it, just as in whispering into a person's ear. The speaking should be done in an even, moderate tone; shouting should be avoided, as it does no good and only irritates the man at the other end.

---

## CHAPTER XXXIII.

### INSPECTION AND MAINTENANCE.

172. In order to keep a telephone installation up to the proper pitch of working efficiency periodical in-

spections by a skilled hand are necessary. Careful inspection and overhauling of instruments will often enable incipient defects to be remedied in time to prevent complete interruption. All parts of a telephone set should be kept clean and bright. A dirty instrument, with dull and corroded metal work, is a thing that nobody takes any pride in, and bad order without will often mean the same state within. In a preliminary inspection run over all connections and look out for loose binding posts and screws, nicked or broken wires, dirty contact surfaces at hinges or springs, and frayed cords. Any defect of this sort should be attended to at once. Examine the receiver by unscrewing the ear-piece and see that the diaphragm is not bent or dented, nor in a rusty state; clean off any dust or other foreign matter from pole piece or edges of case. The top of the pole piece should be 1-32 of an inch below the diaphragm, not lower, or the field will be too weak, and not higher, or it will be too strong and there will be a risk of the diaphragm sticking to the pole piece. A good test for the strength of the magnet is that it should hold up the diaphragm edgeways. The clamping surface of the case on which the diaphragm rests should be smooth and even.

173. The magneto generator and bell should be looked over for loose bearings, bad contacts in switch and automatic shunt, and stiff running of driving gear, which requires occasional oiling. The bell should ring clearly; a dull ringing can often be remedied by turning the gongs round a little. The generator should ring its own bell when a piece of metal is placed across the binding posts. To test the strength of the generator a resistance must be placed in circuit between it and the bell; some of the telephone companies use carbon resistances measuring several thousand ohms for making this test, which shows something more than a trial on short circuit, as a generator may be strong enough to ring its own bell on short circuit, but not through a resistance. The really important point about the generator, however, is that it should ring the bell of the distant station or throw the drop at the exchange properly, and this trial should always be made. It may quite easily happen that a generator will throw the drop but will

not ring its own bell. For instance, the ringer magnet of the bridging bell has a resistance of 1000 ohms and the usual form of line drop has a resistance of only 80 ohms; consequently the drop will take almost all the current furnished by the generator and very little will pass through the coils of the ringer magnet. If the bell does not ring at all, even on short circuit, and the bell is known to be all right, the armature is damaged. It may be either short-circuited or open, probably the latter, through a fused or broken wire, and it must be dismantled for repairs. The spring contacts of the automatic switch can be cleaned with fine emery paper if they are not platinized. Platinum contacts should always be cleaned with ordinary unglazed writing paper.

174. The transmitter should always be tried by listening at the receiver and tapping on the mouth-piece or diaphragm of the transmitter, or speaking to it, having first short-circuited the binding posts. The quality of the "side tone" heard will indicate whether the transmitter and battery are in good condition or not. Very little practice is required to judge the general condition of the instrument correctly by side tone. In the Blake transmitter it is important that all the parts should be in good condition. The rubber band on which the diaphragm is clamped and the pad and sleeve should be soft and elastic, not hard or stiff. It is of prime importance, too, that the rubber ring that encircles the diaphragm should not stick to the iron casting. The diaphragm is held by the clip and damper; if pressed inward at a point above the bearing of the damper it should open like a door, the clip acting as the hinge. The platinum spring should not touch the diaphragm except with its point. Both the platinum spring and that which carries the carbon button should be tightly clamped to the support. The contact between the platinum point and carbon button must be absolutely clean. This is the vital part of the Blake transmitter and must be very carefully attended to. In the action of the transmitter the platinum point tends to dig into the carbon button and to become roughened itself. The platinum point may be smoothed and re-burnished by rubbing with a hard steel surface, such as a well polished screw-driver. If the carbon button is

rough, pitted or dirty it should be cleaned and given a high polish by rubbing on a smooth piece of fine emery paper. Ground glass is also a good material for polishing the carbon button with. The final polish should be given with absolutely clean material. Buttons may be "infected" by rubbing on emery or glass that other dirty buttons have been smoothed down on. If the platinum point is not rough at all but merely wants cleaning this should be done with clean unglazed paper, not with emery.

175. The final adjustment of the Blake transmitter, after the removal of any defects, is made by the screw that presses on the iron support of the electrodes. In moving the screw check the results by side tone until clear talking is obtained. If the transmission has a hollow sound weaken the damper and clip; if the volume is poor, loosen the adjusting screw, stiffen the damper and see that the platinum point rests well against the diaphragm; if the sound is confused and broken, give the platinum spring more "follow" to the carbon button and see that the diaphragm is firmly clamped on the rubber ring and that there are no inequalities in the ring; if the sound is thin and scratchy, clean the platinum and carbon button and see that the platinum spring is not twisted at all. The battery should be kept up to the proper strength; a dull or weak transmission may be due to a run down battery or to high resistance in the primary circuit; frying and buzzing noises are caused by loose battery connections or by dirt on the carbon button. A bent diaphragm will give a metallic sound to the transmission.

176. The Warner battery gauge, Fig. 99, is a useful little instrument for checking the condition of batteries. It gives a certain deflection when the battery is at its normal strength.

177. In the long distance transmitter any defects will be due either to the packing of the carbon, or to a damaged platinum diaphragm, which may be bent or perforated. For inspection the transmitter cord is disconnected, the top of the case removed and the insulated chamber taken out by pushing upward on the binding post. The granulated carbon should be poured on a piece of clean paper. The electrode should be cleaned and polished. If the dia-

phragm is bent it should be smoothed by rubbing gently between paper on a flat surface. In replacing the diaphragm see that no carbon gets between it and the clamping ring. No dust should be in the granulated carbon. In re-assembling the transmitter place the electrode in position and pour the carbon slowly into the central hole of the electrode, moving the chamber a little to and fro to settle the carbon down; never move the electrode after it has been put in place and any carbon poured in. No adjustment is required in the long distance transmitter; after setting up it



FIG. 99. BATTERY GAUGE (SCALE READINGS HAVE NO DEFINITE VALUE; COMPARISON MUST BE MADE WITH CELL OF KNOWN STRENGTH).

must be talked to and tapped gently at the side for a little while to get the carbon properly distributed.

178. The good working of this transmitter, and of the solid back also, depends mainly on the battery. If the battery power is either too high or too low the efficiency of the transmitter is reduced, owing to changes in the resistance of the transmitter itself. If the transmitter is overheated by the use of too much battery it will not talk well afterwards. Three cells of Fuller battery are generally used with either transmitter, giving about 6.3 volts at the best. The resistance of the primary circuit is very low when the transmitter is at rest, the actual resistance of the transmitter itself being a little over 1 ohm. The current

passing when the transmitter is not being spoken into may be as much as  $2\frac{1}{2}$  or even 3 amperes, and the consequent heating is productive of the packing effect. When the transmitter is spoken into the resistance of the primary circuit rises to about 10 ohms and the current consequently falls to .6 ampere or less. The heating difficulty is a serious one with these transmitters. When accumulators are used two cells take the place of the three Fullers, the absence of battery resistance allowing of a lower electromotive force.

179. The solid back transmitter has no adjustable parts. It has not been in use very long and so far has



revealed no particular defects. Its efficiency depends on its being properly set up at first and on the condition of the battery and battery circuit.

180. In connection with the inspection and maintenance of telephone installations, the remarks in Chapter 24 are especially applicable, as with all carbon transmitters the battery is the key to the situation.

181. When a telephone will not work the trouble may be either in the line, the inside wiring, or in the instrument and its connections. If on short-circuiting the instrument at the top binding posts the bell rings and side tone is obtained, the instrument is all right. The inside wiring should then be tested by short-circuiting the wires, if a metallic circuit, or attaching a temporary ground, if a grounded circuit, at the point where the line enters the building; if the bell then rings the trouble is in the line and must be found in the ordinary way. If the bell does not ring the fault is in the inside wiring and can soon be traced out. If no side tone is obtained at the first test the instrument is at fault. Either the receiver or a detector galvanometer may be used in locating the defect. The receiver is most convenient and it should be tested first by connecting it directly to the battery; if a good click is heard it is all right; if not, there may be a broken wire in the receiver or the diaphragm may be out of order. If the receiver is good the primary circuit should be tested by opening it at one of the connections, the automatic switch being up, and trying for current either with the receiver or by tasting. If no current is found the trouble may be a broken or disconnected wire, loose binding post, corroded connection, battery dry or zinc eaten off; the automatic switch may have a bad contact through rust or dirt, or bent or loose springs, or broken wire; the transmitter may have a broken wire or cord, or may be open at the variable resistance through bad adjustment or lack of carbon. All the various paths for the current in the primary circuit should be traced out from one pole of the battery back to the other and the trouble will quickly be found. If the primary circuit tests O K, the trouble must be in the secondary circuit, and this can be tested by connecting one terminal of the battery to one binding post of the telephone and touching the end of a wire joined

to the other terminal to various points in the secondary circuit, beginning with the second binding post of the telephone. When a click is heard in the receiver the trouble lies between the point just touched with the wire and the second binding post of the instrument.

182. The inspector's kit should contain the following tools and material :

Pair cutting pliers,  
 " long nose "  
 Warner Battery gauge,  
 Tack hammer,  
 Screw driver,  
 Soldering lamp and iron,  
 File,  
 Dusting brush,  
 Coil of insulated wire,  
 Rubber tape for covering joints,  
 Candle for examining instruments,  
 Solder and soldering fluid,  
 Small bottle of oil,  
 Trimming knife,  
 Box containing screws, staples, washers, nuts, etc.  
 Chamois skin, cloth and polishing paste,  
 Spare parts of instruments, such as transmitter and receiver diaphragms, cords, hinges, bell cranks, gongs, rubber bands, dampers, clips and springs, carbon buttons and granulated carbon.

183. The small articles are conveniently carried and kept in good order by using small round tin boxes to contain them. A separate stout bag should be used for battery material and should contain a number of spare zincs and carbon plates or porous cups complete, a supply of sal-ammoniac, etc., a strong knife, a sponge and a quantity of cotton rags or waste.

## CHAPTER XXXIV.

### THE CONDENSER : ITS USE IN TELEPHONY.

184. A condenser is an instrument capable of holding a charge of electricity. It consists of two metal surfaces separated by a layer of insulating material. If the poles of the battery are connected to the two metal plates an electric charge will accumulate upon them; the presence of this charge can be made evident by disconnecting the battery and connecting the wires of a galvanometer or hand telephone to the two plates; a throw of the galvanometer needle or click in the telephone will be produced by the released

charge. (See Fig. 100). The capacity of a condenser, that is, the amount of electricity it will hold, depends on the extent of the surface of the plates and the nature of the separating material. The form of condenser usually employed consists of a number of leaves of metal foil alternating with sheets of prepared paper or mica. This arrangement is enclosed

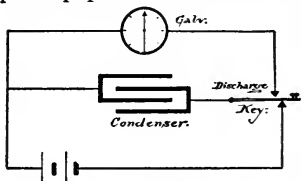

FIG. 100. DIAGRAM ILLUSTRATING PROPERTIES OF CONDENSER.

in a suitable case, all the metal leaves of odd numbers and all those of even numbers being joined together and connected to two terminals placed on the case. Fig. 101 shows a condenser of the form generally used in telegraphy and telephony. The unit of capacity is the farad, which is the capacity of a condenser that will hold one coulomb (one coulomb = one ampere for one second) if charged at a pressure of one volt. This is an enormous capacity and the practical unit is the microfarad; or one-millionth of a farad. (See Appendix).

185. Condensers are used in telegraphy and telephony to a considerable extent. In telephony they are interposed in a circuit where it is desired to prevent a direct or battery current from passing but to enable the talking current to pass. It is quite easy to talk through a condenser of two or three microfarads capacity, as the rapid variations and reversals of the telephonic currents act inductively from plate to plate and are faithfully reproduced. (See ¶ 215). A continuous current of course cannot pass, as the plates are insulated from each other.



FIG. 101. NON-ADJUSTABLE CONDENSER.

The condenser, on account of this facility with which it transmits the telephonic current, while forming a break in the circuit as far as a direct current is concerned, is very useful in special arrangements of telephone circuits, such as the various test circuits used in switch boards for determining

whether a line is busy or not. (See Chapters 36 and 41).

186. Every line is practically a condenser, the surface of the wire being one plate, the earth the other, and the air or covering of the wire the insulating layer between the two. Before a current can reach its full strength at the distant end of the line this condenser must be fully charged; and when reversed currents are used it must be discharged and charged again at each reversal. This explains why a high capacity is so detrimental to telephone working, as the rapid changes and reversals of the telephonic current are deadened and flattened out if they have to charge much capacity before reaching the receiving instrument. The capacity of a number 12 copper wire strung at a height of 30 feet above the ground is about .0148 microfarad per mile. The capacity of the conductors of the best style of underground telephone cable in use to-day is from .07 to .085 microfarad per mile. The capacity of a submarine cable conductor is about .33 microfarad per mile. It is easy to see why telephoning through long submarine cables has not an encouraging outlook. The capacity of a wire is called in full its electrostatic or inductive capacity. (See Appendix).

---

## CHAPTER XXXV.

### ELECTRO-MAGNETIC RETARDATION.

187. Electro-magnetic inertia, electro-magnetic retardation and self-induction are practically different terms for the same phenomenon. This phenomenon, briefly described, is an opposition set up in a circuit to the sudden making or breaking of a current, and is due to a counter-electromotive force induced in the circuit by the prime current itself. It is practically impossible, then, in any circuit to either make or break a current absolutely instantaneously, as the change which takes place in the circuit at either operation generates a force that opposes either the appearance or disappearance of the current. This effect is more apparent in coils than in straight wires, and in coils it is increased by lengthening the coil and placing within it a solid iron core. In

straight wires it is greater in iron than in copper, which is one reason why copper is superior to iron in speed of transmission. (See Chapter 27).

188. Self-induction is particularly to be avoided in circuits carrying alternating currents, because the retarding effect is greatly increased by reason of its action both at the beginning and end of a current. Alternating currents, being made up of numberless small currents, are very much interfered with by the self-induction of the circuit. This is why no unnecessary magnet coils should be included in a telephone circuit. (See Chapter 30). The self-induction of the coils causes their retarding effect on the telephone current to be far in excess of the mere copper resistance of the wire on the coils. This retarding effect is turned to useful purposes in certain ways, as in retardation or choking coils, in the regulating socket for incandescent lamps, and in bridging bells and annunciator drops connected across telephone circuits. (See Chapters 39 and 41).

---

## CHAPTER XXXVI.

### EXCHANGE WORKING.

189. A book of the modest pretensions of the present work cannot attempt to deal fully with the complicated and intricate questions of exchange working, but a short account of the principles of the best systems will not be out of place, and may be useful to those wholly unfamiliar with the subject.

190. The requisites in a telephone switchboard are somewhat complicated. The lines entering it must be provided with means for attracting the notice of the operator, with convenient attachments for making connections with the operator's circuit and with other lines, and with means for notifying the operator when a conversation is finished. The operator must be equipped so as to be able not only to make connections between different lines but also to call subscribers. and, in multiple boards, to test the lines before making a connection in order to ascertain whether they are engaged or not. All these operations have been provided for in many different systems of switchboard apparatus. The principal switchboards in use in this country are the standard, the single-

cord, multiple and non-multiple, and the multiple switchboard proper, all of which are manufactured by the Western Electric company. In all these switchboards the lines are joined to spring-jacks, little switches containing spring contacts, and the connections are made by forcing metal plugs into these spring-jacks, as shown in Figs. 102 and 103.

191. In the standard board, which is used for small

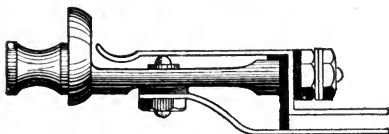

FIG. 102. SPRING JACK.

exchanges of from 50 to 500 subscribers, the line enters the spring-jack by the line spring and passes out by the contact stud on which the spring normally rests; this contact stud is insulated from the rest of the spring-jack and is connected to the annunciator drop, as shown in Fig. 104. The operator is provided with a number of pairs of plugs and cords for making connections with the spring-jacks. The operator's circuit is shown in Fig. 105. Each cord of the pair is connected to a key having two contacts; the normal position of the key connects the cord to the clearing-

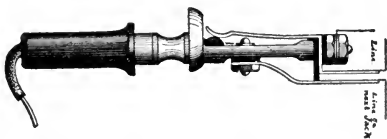

FIG. 103. METALLIC CIRCUIT MULTIPLE JACK WITH PLUG INSERTED.

out drop, which is thus placed directly in circuit between the two subscribers. By pressing down the keys the ringing current can be thrown on either line. From the upper contact of one of the ringing keys a connection is made to a cam-lever switch by which the operator can throw in her own telephone. When a subscriber calls, the operator puts one of the plugs into the proper spring-jack and presses down her

listening key. Having got the number wanted she puts the other plug in the corresponding spring-jack and rings up the subscriber called for. When he answers she releases her cam and the two subscribers

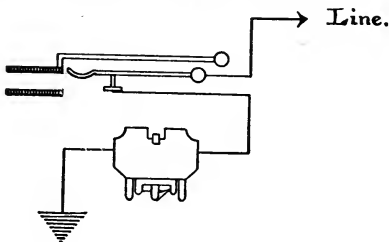

FIG. 104. CIRCUIT THROUGH JACK AND DROP. STANDARD SWITCHBOARD.

are left connected through the clearing-out drop, which falls when they ring off. The operator then takes down the plugs. This is a very simple and convenient switchboard for small exchanges. In large exchanges where this system is used, intermedi-

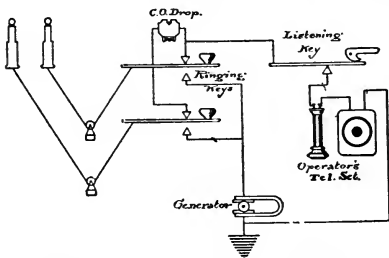

FIG. 105. OPERATOR'S CIRCUIT STANDARD SWITCHBOARD.

ate boards are required to transfer connections from one switchboard to another, and this greatly increases the complication of circuits and the time spent in making connections.

192. In the single-cord board each line, after passing through the spring-jack and annunciator drop,

terminates in a cord and plug; the plug is held upright in a metal socket connected to earth. This system is quicker than the standard, as in putting up connections the plug of either subscriber's line can be connected to the spring-jack of the other, only one plug and cord having to be handled. On the other hand, the complication of connections and apparatus is increased. Fig. 106 shows the metallic circuit plug.

193. In almost all large exchanges the Western Electric multiple switchboard has supplanted other systems. In the multiple board each line passes through a number of spring-jacks instead of only one, so that it is available at a number of different points for making connections. By this arrangement no intermediate switching apparatus is required for transferring connections from one board to another, as every operator can reach every subscriber connected to the board.

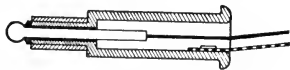

FIG. 106. SECTION OF METALLIC CIRCUIT PLUG.

194. The multiple switchboard consists of a number of sections joined together so as to form one continuous board. Each section contains as many spring-jacks as are equal to the total capacity of the board in subscriber's lines. These are called multiple jacks (Fig. 103). They are all numbered consecutively from zero up in each section and each line is connected to the jack of the same number in each section. Besides the multiple jacks there are in each section a certain number of answering jacks (Fig. 107) and annunciator drops, to which the lines are connected after passing through the multiple jacks. The number of sections is dependent on the total capacity of the board and on the average volume of the service, as in very busy towns an operator cannot take care of so many subscribers as in quieter places. In the 6,000 wire board in New York there are 44 sections, each containing 6,000 multiple jacks.

195. Each operator has under her charge a certain number of answering jacks with their corresponding drops. She attends to the calls of these subscribers and connects them to any others in the board by means of cords and plugs and the multiple jacks.



From 10 to 15 double cords and plugs are provided to each operator for making connections. The cords are connected with ringing and listening keys by which the operator can call in both directions and can cut in her own telephone circuit. It will be noticed in the diagram shown in Fig. 107 that three wires are connected to every spring-jack; one of these, the line, is cut off beyond the jack by the raising of the line spring when the plug is inserted, but the other, called the test, is tapped on the socket of every jack and permanently connects all the spring-jack sockets together. When a connection is put up, the shank of the plug, which is insulated from the tip, makes contact with the socket of the spring-jack. The "test" wire of the cord, connected with the shank

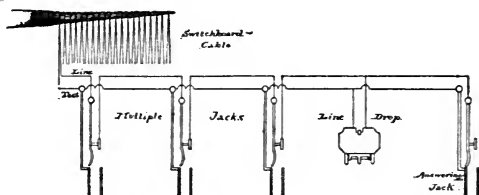

FIG. 107 DIAGRAM OF METALLIC CIRCUIT MULTIPLE SWITCHBOARD, SHOWING SEVERAL LINE JACKS, DROP AND ANSWERING JACK.

of the plug, is also connected with a battery in the operator's circuit, so that when a connection is up the test wire (of each line), running completely through the board, is charged by the battery; if an operator at any of the other sections touches with her plug the socket of the spring-jack belonging to either of the lines connected she will get a click in her head telephone, warning her that the line is "busy." This busy test is a very necessary feature of the multiple board, as each line may be joined to from ten to thirty or more jacks, and if they did not easily indicate the condition of the line the system would be unworkable. In all multiple switchboards, even on the metallic circuit system, there are at present connected a number of grounded lines; the "test" wires of these lines are grounded in the exchange through

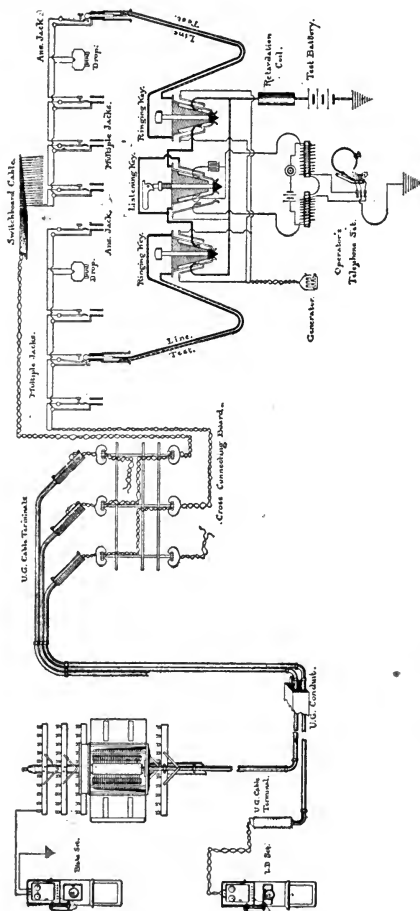

FIG. 108. DIAGRAM SHOWING CONNECTION OF GROUNDED TO METALLIC CIRCUIT STATION THROUGH MULTIPLE SWITCHBOARD.

a resistance coil of about 500 ohms. This is done to prevent the test battery, one terminal of which is normally grounded, from being short-circuited, as would be the case if the "test" wire of the switchboard circuit of a grounded subscriber's line were grounded direct at the exchange; in that case no busy test would be got by an operator at another section of the board on testing either of the lines connected. This is a point that is not clear to many telephone employees, but reference to the diagram, Fig. 109, should make it quite plain. In the diagram *A* is a grounded line and *B* is a metallic circuit. The end of the test wire of *A*'s switchboard circuit is grounded through the 500 ohm coil, the other end of the test

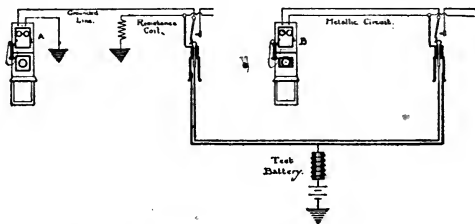

FIG. 109. DIAGRAM OF TEST BATTERY CIRCUIT  
MULTIPLE SWITCHBOARD.

being open at the answering jack. The current from the test battery has two paths to earth, one through the test wire of the grounded circuit and the coil, the other through the test wire of the metallic circuit through the telephone, back along the line and to earth beyond the grounded subscriber's instrument. As the test wire of each circuit is connected to a multiple jack in each section the current can be tested for any of those jacks, and if the socket of any of them be touched with an operator's plug the condenser in the operator's circuit will be charged, producing a sharp sound in the head telephone.

196. When two metallic circuits are joined the plugs and cords connect line to line and test to test; no resistance coil is needed, as there is no escape for the test battery current which simply charges the cir-

cuit and the branches of the test wire extending through the board. The resistance coils are generally placed on the cable heads or at the end of the cross-connecting board, all the circuits being metallic right to the cable terminals, or rather, speaking inward, from the cable side of the cross-connecting board

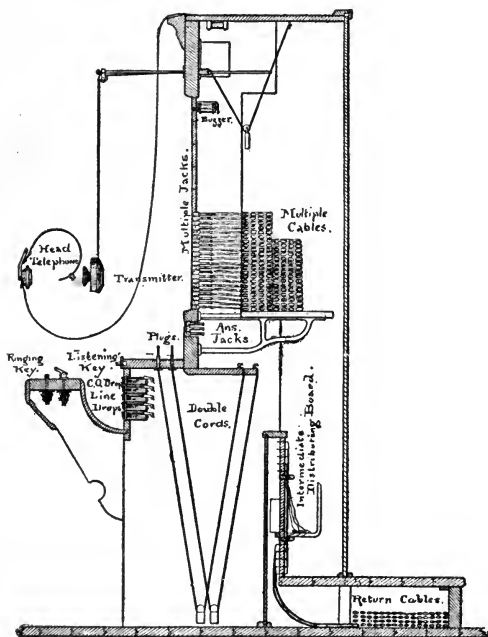

FIG. 110. SECTION OF MULTIPLE SWITCHBOARD.

through to the the switchboard. With this arrangement if a grounded subscriber takes a metallic circuit it is easy to make the change at the cable head without any unnecessary running of wires or overhauling of circuits.

197. The multiple switchboard has various defects

natural to such an intricate system of wiring and apparatus, but it is the best thing that has yet been devised to fulfill the conditions met with in a busy exchange. One of the chief difficulties, which so far has been found unavoidable, can easily be understood from the foregoing description of the busy test and from the diagram. When a local connection is put up (let us say between two metallic circuits) one plug is generally in the answering jack and the other in a multiple jack. The line plugged at the answering jack is evenly balanced, as the answering jack is the end of the switchboard circuit, but the line plugged at the multiple jack has an "open leg" on it, extending by the test wire to all the jacks beyond, through the drop, and back by the line to the stud of the jack where the connection is made. This open leg, of course, varies in length according to the position of the multiple jack in the board. Its tendency, owing to the electrostatic capacity of the switchboard wires and jacks, is to disturb the balance of the circuit and to produce "cross-talk." This defect is absent from the "bridging" type of multiple switchboard. In the bridging board the jacks are in multiple instead of in series and the "test" wire is entirely separate from the line circuit

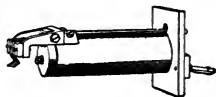

FIG. 111. TUBULAR BRIDGING DROP.

198. In the metallic circuit multiple board the wires that run through the board for connecting to the spring jacks are all twisted in pairs and laid up in oval shaped cables. The connections to the answering jacks are not generally made permanently, but are made through an intermediate distributing board (see Fig. 110) by which the connections can easily be changed if the necessity arises of redistributing the number of answering jacks to a section, or, in other words, the number of subscribers to an operator. The line and clearing-out drops are both bridged across the circuit instead of being connected in series. The line drops generally have a resistance of about 80 ohms. The clearing-out drops have a much higher resistance, generally about 500 ohms, and the coils are enclosed in a soft iron tube (Fig. 111), to increase

the electro-magnetic effect. As the clearing-out drops are left bridged across a circuit on which two subscribers are talking it is essential that they should have high resistance and self-induction in order that they may not shunt the telephonic current. Sometimes the same drops have been used both for calling and clearing-out, but in busy exchanges this is confusing to the operators, and it is better to have separate clearing-out drops in the connecting cord circuit.

199. The multiple system has an infinity of complicated details, some of which are constantly being changed and improved on, so that the foregoing is by no means a complete description; it is merely intended to give an idea of the general method of operation.

200. The Law system, which is used on a large scale in Philadelphia and in St. Louis, differs from the Western Electric in employing no drops. Every subscriber is connected to a calling wire by which he speaks directly to the operator, telling with what number he wants to be connected; when the conversation is finished the operator is advised in the same way to take down the connection. The calling wire serves a number of subscribers' stations connected in series and is distinct from the subscriber's wire proper. The switchboard is multiple, with very small jacks set vertically in a table instead of in the usual horizontal tiers. Remarkably quick service can be given by this system, but it is not used in many places.

---

## CHAPTER XXXVII.

### SMALL EXCHANGES.

201. For small exchanges to serve the different departments of a large building, if an operator is employed, the standard board already described is the best. Where it is desired to connect up a number of offices so that each can call any of the others without the use of a central switchboard, what is called the "speaking tube" system is used. The name does not imply that speaking tubes are used in any way, but the system gives service in situations where speaking tubes would otherwise be depended on, hence the name.

202. Each station is provided with a transmitter and receiver and the usual automatic switch, besides which a cord is attached to the telephone circuit for connecting to the various lines by means of the plug in which the cord terminates. Above the telephone is placed a switch-board having as many sockets as there are lines and a push button for throwing the battery to line. Fig. 112 shows the usual form of wall speaking tube set and Fig. 113 a more recent style in which a switch is substituted for the cord and plug. The battery is placed at a central point and is common to all the stations. By means of the push button it can be used to ring the bell at the station that it is desired to call. As many wires as



FIG. 112.

SPEAKING TUBE SET. there are stations are run round the entire route, and two wires from the battery are also taken past every station; one of these is the battery wire proper and the other a common return wire for both bells and telephones. From the battery wire a tap is taken to the push button at every station, and from the common return wire a tap is taken to one side of each bell and to one side of each telephone circuit. The other side of each telephone circuit is permanently connected to its proper wire, and from every line wire a tap is taken to its corresponding socket at each of the little switchboards. When one station wishes to call another he puts his plug in the socket of the desired number and presses the button, which throws battery on the line connected and rings the bell. No annunciator drops are needed, as when communication is obtained the calling party states who he is. Fig. 114 is a diagram of the connections of



FIG. 113. IMPROVED FORM OF WALL SPEAKING TUBE SET.

a station on this system. It is well adapted for providing communication for from ten to twenty stations in a building; for any greater number the expense and complication of the wiring render it unsuitable. Fig. 115 shows a neat form of desk set for the speaking tube system. The switch can be used as a base or placed in any convenient position on the desk.

---

## CHAPTER XXXVIII.

### PARTY LINES.

203. The arranging of a number of telephone stations on one circuit is by no means a simple problem, and when it is required that any station shall be able to call up any other while attracting the attention of none but the station called, it becomes an exceedingly difficult one. This would be the ideal party telephone line, but it has not yet been reduced to practice. To the connecting of telephones in series there is a limit very quickly reached, as the retarding effect of the magneto bell magnets soon cuts down the transmission below the working point. In good practice telephones are never connected in series, but always in "bridge" or multiple arc; the instruments are bridged across the circuit if metallic, or legged on to ground if grounded.

204. The bridging bell, Fig. 116, invented by J. J. Carty, was designed especially for this kind of work, and is successfully used to-day on party lines having from 10 to 30 or more stations. The magnet coils of the polarized bell are wound to 1000 ohms with No. 33 wire, giving a great number of turns. The magnet cores are longer than in the ordinary bell. (See Fig. 117). These magnets have a very high self-induction and when placed in bridge across the circuit their retardation is so high that the telephone current has no tendency to enter them, but passes along the line. As many as twenty of these electro-magnets have been bridged across a long distance circuit between New York and Boston without producing any appreciable effect on the transmission. The generator is wound to a low resistance in order to supply sufficient current to ring a number of bells. When a call is sent every bell on the line rings, and to dis-



tinguish which station is wanted a code of signals is used. The generator is usually provided with the style of automatic cut out shown in Fig 70, and the signaling can be done very well by giving the crank sharp, quick turns to make the dots and dashes of the signal calls. Sometimes the generator is not fit-

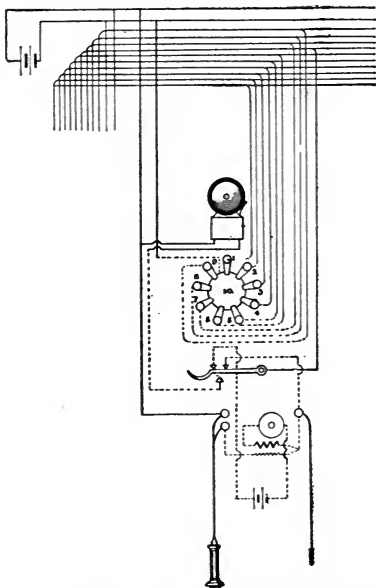

FIG. 114. DIAGRAM OF CONNECTIONS, SPEAKING TUBE SYSTEM.

ted with an automatic cut-out, but the generator circuit is left normally open and a key or push button is placed at the side of the box for closing it. The signaling is then done by turning the crank steadily with one hand and tapping out the combinations on the key with the other; it requires some knack to do this successfully, and the automatic cut-out is preferable. Besides its electrical advantages over the or-

dinary form of magneto bell the bridging bell gives a simpler mechanical arrangement, owing to its fewer parts and permanent connections. By the diagram of connections, Fig. 118, it will be seen that the polarized bell is permanently connected across the circuit, and that the automatic switch has no lower contact. The switch merely throws the talking circuit to line and closes the primary circuit.



FIG. 115 DESK SET FOR SPEAKING TUBE STATION.

205. Although the bridging bell provides a means of operating a number of telephones on a single line, it still has the disadvantage that the calling signals are heard at every station. What is really required in telephony is a system of individual or selective signaling which would enable any station on a party line to call any other without disturbing the rest. Many inventors have turned their attention to this problem, and T. D. Lockwood announced in a paper

before the American Institute of Electrical Engineers, read in 1892, that between January 1879 and December 1891 no fewer than 161 American patents were taken out for systems of selective signals for telephone lines. Most of these devices are extremely complicated, almost all of them are inoperative and none has come into general use.

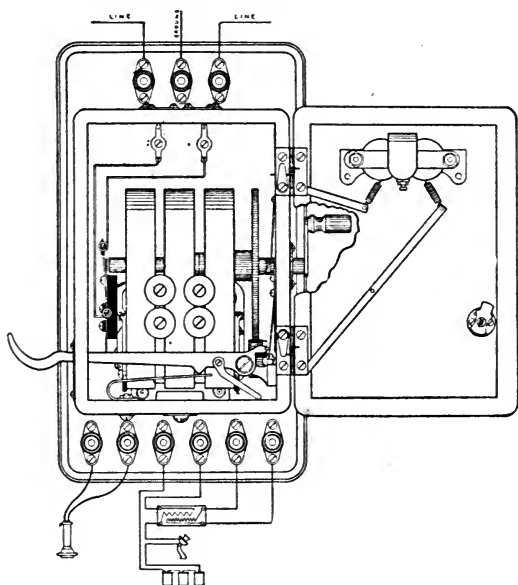

FIG. 116. THE BRIDGING BELL.

206. A comparatively simple and quite efficient selective signal which is used to a limited extent in England is based on the pendulum principle, applied some years ago by Bizot to telegraph work. The signaling apparatus consists of two pendulums, one the receiver and the other the transmitter. The first has a fixed bob, which is set at a different height for each station; the rod is attached to the armature of

an electro-magnet. The second or transmitting pendulum has a movable bob, which can be adjusted at any required height on the rod; when set in vi-

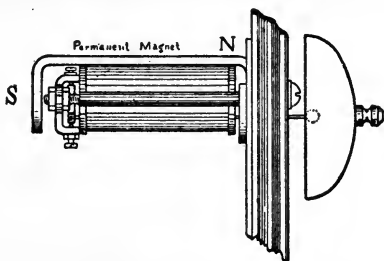

FIG. 117. POLARIZED BELL WITH LONG CORES FOR RINGER OF BRIDGING BELL

bration it sends to line two currents at each complete swing. These currents pass through the mag-

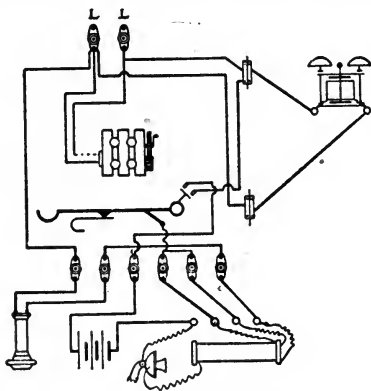

FIG 118. DIAGRAM OF CONNECTIONS OF BRIDGING BELL

nets of the receiving pendulums, but only the one whose bob corresponds with the adjustment of the transmitter is set in vibration. When it reaches its

full amplitude of vibration it closes a local bell circuit. The rod of the transmitting pendulum is marked so that it can be seen at a glance where to set the bob in order to call any particular station. This selective signal works very well, but is only adapted to a very limited number of stations.

207. The need for a simple and efficient system of selectively operating a number of telephone stations on a single circuit is obvious. Even in the busiest centers the average number of times a subscriber's line is used in the day does not exceed 15 or 16, and in small places the average use is not more than one-third of this; so that on an average each line is actually occupied from half an hour to two hours of the twenty-four. Any system that, without being too expensive or complicated, will enable the work to be more evenly distributed among a smaller number of wires has a distinct field awaiting it. Such a system would also be extremely useful for small groups of from 20 to 40 or 50 subscribers where an exchange could not be profitably worked.



FIG. 119 DOUBLE PLUG.

## CHAPTER XXXIX.

### LONG DISTANCE TELEPHONY.

208 Long distance telephony has reached its greatest development in this country: During the last eight years a magnificent plant has been built

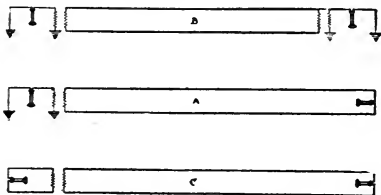

FIG. 120. DIFFERENT METHODS OF CONNECTING LINES THROUGH REPEATING COILS.

up which provides perfect telephone communication between the principal towns in New York, the New

England states, Pennsylvania, New Jersey, Maryland, etc., and during the last two years the system has been pushed West, culminating in the magnificent telephonic feat of connecting Chicago with New York and Boston by the talking wires. Chicago will soon no doubt form an important centre of long distance telephone communication between important towns in the West.

209. The system of the long distance company is based on rigorous metallic circuit working and high grade construction work throughout. The lines are

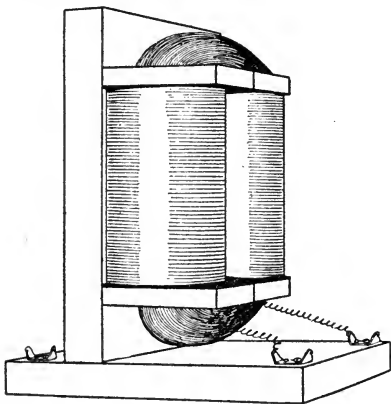

FIG: 121. STANDARD REPEATING COIL.

all carefully constructed copper metallic circuits. Thirty-five foot poles are used, set 130 feet apart. The cross arms are 10 feet long by  $3\frac{1}{2}$  in. by  $4\frac{1}{2}$  in. They carry 10 insulators each and are attached to the poles with iron bolts and supported by iron braces. The cross arms are placed one foot apart and the poles are set 6 feet in the ground ( $6\frac{1}{2}$  at curves), so that on a line carrying 20 circuits (40 wires), the lowest arm is 25 feet above the ground. Every tenth pole in the line is provided with double cross arms carrying transposition insulators; at each of these poles some of the circuits are transposed to prevent inductive disturbances in the circuits. (See Chap

28.) The standard size of wire is No. 12 B. W. G. (104 mils), weighing 166 pounds to the mile, resistance 5.2 ohms per mile.

210. All of the central office apparatus used in the long distance system is connected in bridge, to preserve the balance of the metallic circuits. For putting up connections special switchboards equipped with double spring-jacks, one for each wire of the circuit, are used, with twin plugs made by mounting two plugs in a flat hard rubber socket, Fig. 119. The transmitters used have already been described. (See Chapters 15 and 16.)

211. When a long metallic circuit is joined to a

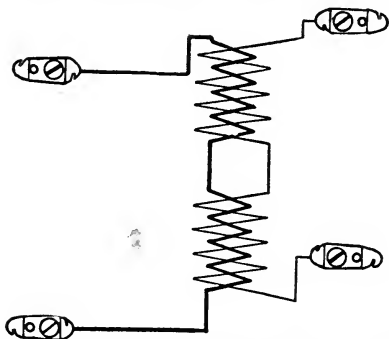

FIG. 122. DIAGRAM OF CONNECTIONS OF REPEATING COIL.

grounded line the connection is not made direct, but through a repeating coil. This is done to prevent the balance of the circuit being destroyed by an uneven arrangement of the lines. The repeating coil is also beneficial in reducing disturbances on the lines in other ways. It has been found that a short line subject to disturbance if joined to a long metallic circuit will cause the whole line to become noisy and difficult to talk over. By making the connection through a repeating coil the disturbance is eliminated and a quiet line throughout is obtained. The diagrams *A*, *B* and *C* in Fig. 120 show three different ways in which repeating coils are used. A rep-

resents a metallic circuit connected to a grounded circuit, *B* two local grounded circuits connected by a metallic circuit with a repeating coil at each end, and *C* shows a long metallic circuit connected to a local one through a repeating coil, the local circuit being subject to inductive disturbance. The standard repeating coil used in this country is shown in Figs. 121 and 122. It has a closed core formed of a bundle of fine iron wires with the ends spliced to-

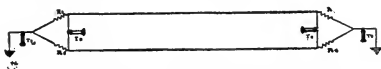

FIG. 123. DUPLEX TELEPHONY.

gether; one-half of each coil is wound on each side of the core, there really being four coils, the two inner and the two outer being joined in series. The resistances of the coils are 110 and 174 ohms, there being in all 10,000 turns of No. 30 B. & S. wire.

212. The New York-Chicago line is the longest telephone circuit in the world and far exceeds in its electrical conditions what was previously thought to be the possible limit of telephonic transmission. The speaking is so good that conversation can be carried

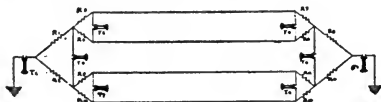

FIG. 124. MULTIPLEX TELEPHONY.

on in a whisper between the two cities. The line is about 950 miles long. The wire used is No. 8 B. W. G. (165 mils), weighing 435 pounds to the mile, resistance 2.06 ohms and capacity .0158 microfarad per mile. The total weight of copper used in the circuit is over 400 tons. The total surface exposed by the wires is 433,000 square feet. If flattened out, the 1900 miles of wire would make a copper sheet .04 inch thick and over 660 feet square. A special circuit of the same wire has recently been built from New York to Boston, to give the latter city tele-



phonic communication with Chicago. The line from Boston to Chicago is over 1200 miles long and the circuit includes several miles of underground and submarine cable.

## CHAPTER XL.

### DUPLEX TELEPHONY.

213. Although methods have been devised for duplexing telephone lines, they are not used in general practice. In the situations where such arrangements would be most useful and profitable, that is, on long and expensive circuits, they are not practicable, as the apparatus for duplexing cuts down the transmission on the second circuit too much. The method of duplexing a metallic circuit telephone line consists in the use of a second grounded circuit, so arranged, by means either of repeating coils or of resist-

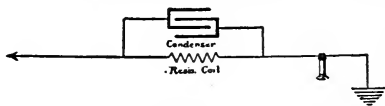

FIG. 125. USE OF CONDENSER AS TELEPHONIC SHUNT.

ances, that the currents from the two grounded stations divide equally between the two wires of the metallic circuit and do not affect the metallic stations.

214. The diagram shown in Fig. 123 gives a clear idea of a duplexed telephone line on the Wheatstone bridge or resistance principle invented by Frank Jacobs.  $T_3$  and  $T_4$  are two telephone stations connected by a metallic circuit. Connected beyond each station are four resistance coils,  $R_1$ , 2, 3 and 4. The resistance of  $R_1$  and  $R_2$ , and  $R_3$  and  $R_4$ , must be equal, but all four need not be of equal resistance. These coils are joined to each wire of the circuit and the two at either end are joined together; to the junctions of the pairs of coils are connected two grounded telephone stations  $T_1$  and  $T_2$ . The resistance of the coils must be higher than that of the line, so that the greater proportion of the currents from  $T_3$  and  $T_4$  will pass along the line instead of

around the coils. The currents from  $T1$  and  $T2$  split equally between the coils and lines and produce no sounds in  $T3$  and  $T4$ , as the divided currents neutralize each other in those telephones.

215. The second diagram, Fig. 124, shows a multiplex arrangement of eight stations on two circuits. In practice the transmission between  $T1$  and  $T2$  and  $T3$  and  $T4$  would be poor, owing to the amount of resistance interposed. If condensers were connected to all the resistances in the manner shown in Fig.

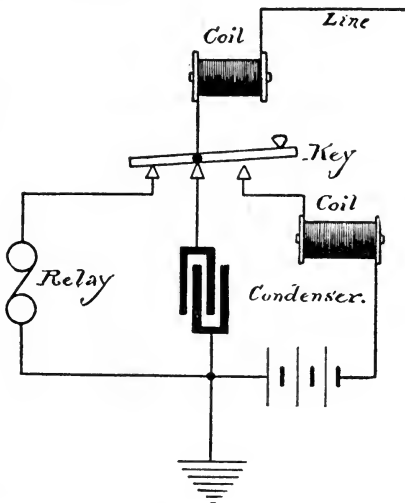

FIG. 126. VAN RYSSELBERGHE'S ANTI-INDUCTION DEVICE.

125, so as to act as telephonic shunts, the transmission would be improved.

## CHAPTER XLI.

### SIMULTANEOUS TELEGRAPHY AND TELEPHONY.

216. The system of working telephones on telegraphic circuits, invented by the late Mr. Van

Rysselberghe, of the Belgian telegraph service, is extremely ingenious and quite effective. He was led to devise it by the success of his experiments for the lessening of induction be-

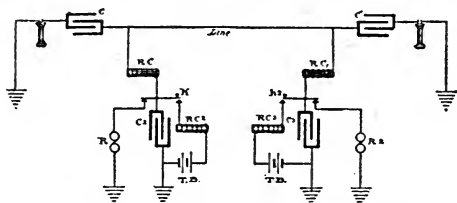

FIG. 127. SIMULTANEOUS TELEGRAPHY AND TELEPHONY.  $C C$  LINE CONDENSERS,  $R C R C_1$  LINE RETARDATION COILS,  $K K_2$  TELEGRAPH KEYS,  $R R_2$  RELAYS,  $T B$  TELEGRAPH BATTERIES,  $C_2 C_3$  CONDENSERS IN BATTERY CIRCUIT,  $R C_2 R C_3$  RETARDATION COILS IN BATTERY CIRCUIT.

tween telegraph and telephone circuits. By inserting an electro-magnetic coil in a telegraph circuit between the line and the key and another similar coil and a condenser in the battery circuit, Mr. Van Rysselberghe produced his anti-induction arrange-

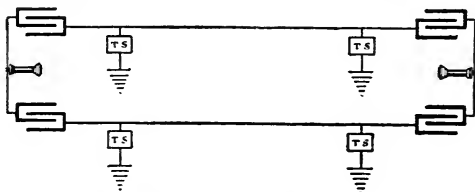

FIG. 128. SIMULTANEOUS TELEGRAPHY AND TELEPHONY.

ment. The retarding effect due to the electro-magnetic inertia of the coils prevents the currents from either gaining or losing their full strength suddenly; a gradual rise and fall in strength taking place instead. The condenser, which is charged at each

closing of the key and discharged to line at each opening, aids in checking the abruptness of the telegraph signals. This arrangement of apparatus, shown in Fig. 126, resulted in greatly reducing the induction between a telegraph line so equipped and a neighboring telephone line. It then occurred to Van Rysselberghe that by connecting to the telegraph line, between the first coil and the key, a condenser and joining the second plate of the condenser to a telephone, conversation could be carried on over the telegraph line, as the flattened out telegraphic currents would not affect the telephones and the minute telephonic currents would by no means interfere with the telegraph apparatus. The idea was entirely successful.

217. The complete arrangement of a line equipped for simultaneous telegraphy and telephony is shown in Fig. 127. The diagram, Fig. 128, shows two grounded telegraph lines arranged to give a metallic circuit telephone line; the squares marked *TS* represent telegraph stations equipped as in Fig. 127. This system, while not adapted for long distance high speed telegraphy, is used very successfully in Europe on circuits of considerable length. High speed telegraphic transmission is not possible because of the retarding effect of the anti-induction appliances. Nevertheless, the system is in many cases easily applicable, and as it obviously greatly increases the earning capacity of a circuit this is a strong point in its favor.

---

## CHAPTER XLII.

## RECENT PROGRESS.

218. As regards the general practice of telephony, there is little to be added to or taken away from the foregoing pages in the light of experience gained since the *HAND-BOOK* was first published. Speaking generally, the advice given at the beginning of chapter XXVII can only be reiterated in the most emphatic terms, and should be applied to every detail of a telephone installation, from the answering jack to the receiver diaphragm. Disregard of what should be an axiom with telephone managers, *viz.*, that nothing is too good for telephone construction, has been responsible for the waste of much good money during the last few years.

219. Reviewing the present state of the art, there is little or nothing to add to the sections on line construction. Experience has proved, as already stated in the body of the book, that short poles are the safest. To the details regarding line building, wiring, jointing, etc., there is practically nothing to be added; the standard practice as described has not altered. In underground cables considerable progress has been made in the manufacture of dry core cable, and the use of 200-pair cable (occupying a 3-inch duct), with a capacity of about .08 microfarad, is now common practice. The economy attained by placing 200 circuits in a space that in the early days of underground telephone construction was occupied by but 50 is obviously a great step in advance. The multiplication of strong foreign currents by the rapid increase of electric railway systems renders the question of protection against foreign currents rather more important than it formerly was. Absolute protection against currents of practically unlimited power, such as a low resistance contact with a trolley line will produce, is impossible, and very startling effects have been produced by such contacts. The best protection is prevention, by so disposing telephone circuits in the neighborhood

of trolley lines (if they must be neighbors) as to render the chance of contact as distant as possible. Fuses and protectors inserted in the line are a necessary precaution besides. Apart from their constantly threatening attitude toward overhead lines, the trolley currents worry telephone managers by insidiously attacking the lead sheathing of underground cables. The reader in search of information on the subject, a serious evil in all largely trolleyed cities, cannot do better than study Mr. I. H. Farnham's classic paper on "Destructive Effects of Electrical Currents on Subterranean Metal Pipes," read before the American Institute of Electrical Engineers, April 18, 1894, and published in Vol. XI of the Transactions.

220. Coming to telephone instruments, although many patterns of transmitters other than those described in the foregoing pages have been introduced, it may be said that the granular carbon transmitter of some form or other is now the standard instrument in use by enlightened telephone administrations and companies all over the world. The solid-back transmitter, the standard American instrument, has stood the test of use well and is considered by many telephone experts to stand at the top of the list for all-round work. Certainly in no other country is ordinary commercial talking, from subscriber's station to subscriber's station, done over longer distances; in fact, the longest European lines in commercial use are not more than about half the length of the lines in daily use in this country. When this book was first published the New York-Chicago line had barely ceased to be a nine days' wonder. Since then the long distance system has been much extended, and direct talking is now had between St. Louis and New York, and between Kansas City and New York.

221. A type of granular carbon transmitter in use to some extent in this country is the Mildé, shown in Figs. 129 and 130. In this transmitter the electrodes and granule chamber are carried on the diaphragm, to which the front electrode is rigidly attached, inertia being given to the back electrode by a metal weight in which the end of

the electrode is set. The chamber is of corrugated tin and is nearly filled with carbon granules: the

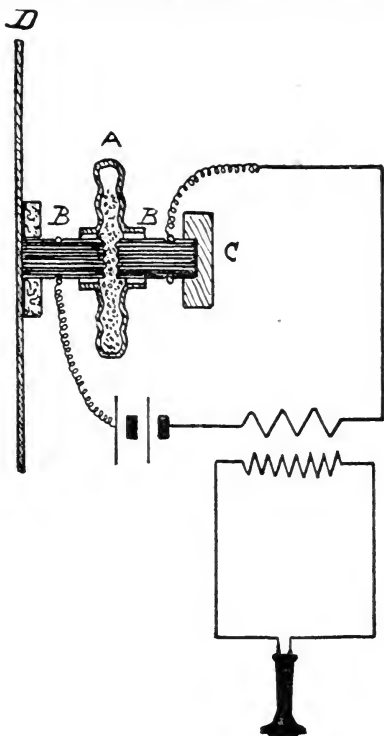

FIG. 129. THE MILDE TRANSMITTER. *D* DIA-  
PHRAGM, *BB* ELECTRODES, *C* WEIGHT AT-  
TACHED TO BACK ELECTRODE, *A* CORR-  
GATED TIN CHAMBER NEARLY FILLED  
WITH CARBON GRANULES.

carbon electrodes nearly meet in the center of the chamber, from which they are separated by insu-

lating collars. The diaphragm is usually of cedar, though sometimes mica or metal is used. As will be seen from the diagram, the construction of this transmitter is very simple. The advantages claimed for it are good quality of transmission and large volume, non-packing of the carbon granules and good talking with low battery power. It can also be used for long distance work with high battery power without affecting the clearness of transmission.

222. Of receivers, as might be expected, there is nothing new to say. The double-pole instrument is coming into more general use, but the gain in efficiency is so slight—the sensitiveness of the Bell telephone, however constructed, being so extraordinary—that the single pole receiver is still very largely used.

223. Where great changes and advances have been made in the art of telephony is in exchange working. While this book does not pretend to go into the details of telephone working on a large scale—and it is only in large systems that switch-board problems assume a serious aspect—a brief review of recent progress in exchange working will probably be of interest to many readers.

224. The obvious direction for improvement in telephone operating to take is that of automatic working. Absolutely automatic working in large systems is practically unattainable, for no machine could possibly be made that would have selective powers sufficient to deal, in any ordinary period of time, with the multitude of different numbers and points among which selections have to be made by the operator in a large telephone system. There are several automatic telephone exchange instruments that are marvels of mechanical ingenuity and skill, rivaling in delicacy and complication many of the wonderful machines used in manufacturing small articles and in such work as type-setting. These instruments have been brought to such a point that they are capable of dealing with the work of a small self-contained exchange. Much beyond that they will never go, for reasons that will be obvious to anyone who has ever looked into the working of a large telephone system.



Briefly, it may be said that the selective powers of any machine that can be made commercially operative soon reach a limit, while the selections to be made in a large telephone system are practically unlimited and the patience of the average telephone user is very limited indeed.

225. While we can never hope to eliminate human labor entirely from telephone operating, there is ample opportunity to reduce the amount of human labor required to handle each connection and so render the operation more automatic and consequently quicker. In every telephone connection the necessary operations for its making and unmaking have to be performed partly by the users of the service and partly by the trained operators at the exchange. Tracing the steps of an ordinary connection on the magneto system we find them to be as follows:

1. The calling subscriber rings his bell, or, more accurately, turns his magneto generator, thereby throwing the drop at the exchange.

2. The calling subscriber takes the receiver off the automatic switch-hook.

3. The operator plugs into the answering jack, at the same time depressing the listening-key, and

4. Replaces the line drop shutter

5. The operator, having got the number wanted, plugs into the multiple jack, and

6. Rings the called subscriber.

7. Conversation finished, both subscribers replace their receivers on the automatic switch-hooks, and



FIG. 130. THE MILDE TRANSMITTER. REAR VIEW OF CHAMBER, SHOWING WEIGHT ON BACK ELECTRODE.

8. Turn their magneto generators, thereby throwing the clearing-out drop.

9. The operator listens in to make sure that disconnection is required, and, such being the case,

10. Pulls out the two plugs, and, finally,

11. Replaces the clearing-out drop shutter.

In different companies and administrations different methods of operating obtain, and there are minor variations from the above series of operations, dependent largely on the efficiency of the users of the service as operators of their end of the system. But the essential steps in the operation of a connection with the series multiple board described in the body of this book are those set forth above, with the possible exception of No. 9 which is not everywhere regarded as essential though for good service it should be.

226. An examination of these steps will show which are absolutely requisite and which may be done by automatic means as a secondary result of a requisite step.

227. Step No. 2 has for its object switching the line from the subscriber's bell, its normal connection, to the talking circuit of his instrument, and, incidentally, closing the battery circuit of the transmitter. This is a requisite step in order to change the telephone station from its normal position of readiness to receive a signal from the exchange to the condition of readiness for talking over the line.

228. Step No. 1 has for its object to signal the exchange for attention. It is quite obvious that step No. 2 may, by the movement of the automatic switch, be made to effect the purpose of step No. 1, at the same time that it switches the line from the bell to the talking circuit. Similarly, step No. 7, which is the converse of step No. 2, may be made to effect the object of step No. 8, the sending of a signal for disconnection to the exchange. Here is a gain of two operations out of four performed by the subscribers. The British Post Office has for many years had a system in operation embodying these features. The indicator at the central office is a galvanometer, whose needle is normally inclined to one side. Lifting the telephone from the

hook at the subscribers' station sends the needle over, indicating a call. When the connection is made the needle stands at zero, affording a visual busy test, and when the two subscribers hang up the needle is inclined in an opposite direction to the normal position, thereby affording a disconnection signal. Consequently there is no radical novelty in combining steps 1 and 2 into one operation, and steps 7 and 8 into one operation.

229. Turning to the exchange end we find that the essential operation of plugging into the answering jack (step 3) is capable of accomplishing the work of step 4, and that either step 9, which is not essential, or step 10, which is, may similarly be made to do the work of step 11. It must be observed here that a system in which the removing of the telephone from the hook sends a signal to the exchange, and the replacing of the telephone sends another signal, necessarily involves the use of signaling devices at the exchange which are entirely automatic (as far as any separate movements on the part of the operator to restore them are concerned), and such a system therefore abolishes steps 4 and 11.

230. The automatic features bring the essential operations in a telephone connection from 11 down to 6, as follows:

1. The calling subscriber takes the receiver off the hook, thereby signaling the exchange, and switching his line from the bell to the talking circuit as usual.

2. The operator plugs into the answering jack, thereby re-setting the line signal and getting into communication with the calling subscriber as usual.

3. The operator plugs into the multiple jack.

4. The operator rings the called subscriber.

5. Conversation ended, the two subscribers hang up their receivers, thereby displaying a disconnection signal at the exchange.

6. The operator pulls out the two plugs, thereby resetting the disconnection signal.

231. The operations are cut down from a total of 11 to a total of 6, or a little more than half. The operations required of the subscribers are cut down from 4 to 2, and those of the operator from 7

to 4 Step 9 in the first series becomes no longer necessary when the disconnection signal indubitably means that the two subscribers connected have hung their telephones on their respective hooks and left them there. Such a disconnection signal is unmistakable and requires no supervision by listening-in; where the disconnection signal is by a drop actuated by a magneto generator, its falling may not always mean a signal for disconnection, and listening-in to make sure of the subscribers' intentions is a part of good service.

232. The British Post Office system, which is fully described in Preece and Stubbs' "Manual of Telephony," has never been adopted in this country, and the first application of automatic work in American practice was made at the exchange end of the system. By the use of what is generally called a self-restoring drop, steps 4 and 11 in the original series of operations are got rid of, step 4 being accomplished by step 3, and step 11 by either step 9 or 10. Self-restoring drops are either mechanically or electrically operated. In mechanically operated self-restoring drops the line drop is so placed that the shutter falls over the aperture of the answering jack, and the plug, in entering the jack, pushes back the shutter, which engages with the armature lever and is held in position to be released by the next call. A clearing-out drop is made mechanically self-restoring by placing it in such a position that the connecting plug on falling back into its socket on the cord-shelf actuates a lever that resets the shutter of the drop. Both of these are simple and ingenious devices.

233. Electrical self-restoring drops are quite another matter, and achieve various results that are not attained by mechanically restored drops. The self-restoring drop is an essential part of what is generally known as the "bridging" board, in which the spring-jacks are connected in multiple instead of in series, as in the older forms of multiple board. In the chapter on multiple switchboards it was explained that the number of contacts in a large switchboard and the "open leg" formed by the test wire were serious disadvantages. In the bridging board the circuit is continuous throughout the

board, without contacts at the jacks; the test wire is an entirely separate circuit from the talking circuit, and the battery which furnishes the test energizes at the same time the magnet of the restoring coil of the drop. The result of this arrangement of circuits is a complete cure of the electrical difficulties in the series board arising from the numerous contacts at the jacks and from

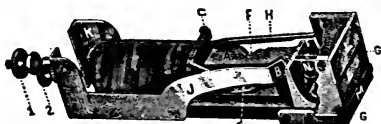

FIG. 131. COMBINED JACK AND SELF-RESTORING DROP. *A* JACK, *JK* LINE SPRINGS, *B* CONTACT FOR SLEEVE OF PLUG, *F* CONTACT FOR TIP OF PLUG, *N* OPENING OF JACK, ENTERING WHICH PLUG RESTORES DROP SHUTTER *E*, *1* LINE DROP COIL, *D* SPRING NORMALLY IN CONTACT WITH *J*, WHICH CUTS OUT COIL WHEN PLUG IS INSERTED BREAKING CONTACT BETWEEN *J* AND *D*, *H* ARMATURE PIVOTED AT *C*. DROP *E* ENGAGES WITH TIP OF *H* WHEN DROP IS IN NORMAL POSITION. *1* AND *2* ARE BINDING SCREWS FOR HOLDING JACK AND DROP IN POSITION ON THE FRAMEWORK OF THE BOARD.

the unbalancing effect of the test-wire. The electrical self-restoring drop consists of two electromagnets; one of these responds to the current sent over the subscriber's line, and the other is included in the test circuit—which is closed as soon as a plug is inserted in the answering jack—and attracts and holds the shutter let fall by the action of the line magnet. The clearing-out drop is of the same pattern, the restoring magnet being energized by a battery brought into play by an extra contact on the listening key. The electrical self-restoring drops, not requiring to be touched after having been properly adjusted, are placed in the upper part of the switchboard, thus leaving the lower part free for jacks. The result is to make the working part of the board more compact and the

jacks more accessible to the operators. This is an advantage not gained by the use of mechanically restored drops, which have to be in a position to be operated by the movements of the plugs.

234. In Fig. 131 is shown a combined spring-jack and self-restoring drop, designed and manufactured by the Western Telephone Construction company of Chicago. When the drop is operated the shutter falls in front of the opening through which the plug must enter the jack. On inserting the plug the shutter is pushed upward and engages

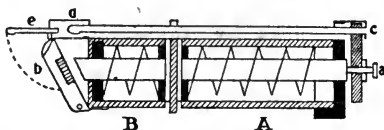

FIG. 132. SELF-RESTORING DROP. *A* LINE COIL, *B* RESTORING-COIL; *a* ARMATURE, *c d* RELEASING LEVER ATTACHED TO *a* AND ENGAGING IN *b*, *b* DROP BEARING NUMBER, *e* ALUMINUM SHUTTER COVERING *b* WHEN *b* IS IN NORMAL POSITION.

with the tip of the armature lever *H*, which holds it in position. The plug, entering the jack at *N*, goes home and makes contact with sleeve at *B* and tip at *F*, cutting out the drop by pressing *J* outward and so breaking the contact between *D*, connected to the coil, and *J*, the line-spring. This arrangement is simple and compact. It can easily be removed for repairs by loosening the nuts at 1 and 2. One hundred complete jacks and drops can be placed in a space 13 inches by 16 inches.

235. Other types of mechanically self-restoring line drops necessarily employ the feature of replacement of the drop shutter by the plug. In some types the drop coil is not cut out, and the plug and shutter are so arranged that the shutter is free to be thrown again while the plug is in the jack. The line drop then serves also as a clearing-out drop, and when the plug is withdrawn in response to a clearing-out signal, it again trips the shutter and restores it to its normal position.

236. The diagrams shown in Figs. 132 and 133

give a clear idea of the principle of the electrical self-restoring drop and of the circuits of the bridging board. This system was designed by the Western Electric company of Chicago. It marked a great step in advance in telephone exchange operating, and has been extensively adopted all over the world. The principal features of the system, as already stated, are a balanced metallic circuit, absolutely free from jack contacts, for the line, an entirely separate test circuit and automatic resetting of both line and clearing-out drops. Fig. 132 shows the self-restoring drop, which is of the same pattern for both line and clearing-out drop. It consists of two separate electro-magnets operating on two distinct armatures. *A* is the line coil, wound to a high resistance, usually 600 ohms, as it is bridged permanently across the line. *B* is the restoring coil, of low resistance, which is included in the test circuit and is energized by the test battery. When *A* is energized by the line current the armature *a* is attracted and the drop-shutter *b*, normally held by the tip *d* of the armature lever *cd*, is allowed to fall forward; *b* only falls forward a short distance, but in falling it pushes outward and upward a light shutter, *e*, pivoted at the top, which normally hangs over *b*. The drop number is painted on the face of *b*; a very slight movement outward of *b* pushes *e* out and up, allowing the number on *b* to come into full view, and a very slight movement back allows *e* to fall back and completely cover the number on *b*. The back of *b* is hollowed out to fit the pole of the restoring-coil, which has an oblique pole piece so as to get as strong a pull as possible on *b*. When the insertion of the plug closes the test circuit the restoring coil *B* is energized, *b* is attracted and brought to its normal upright position and *e* falls, covering the number. As the test circuit is closed as long as the connection is up the drop is locked by the attraction of *B* on *b* during the time the plug is in the jack. The diagram of the plug and jack is shown in Fig. 133. The jack, it will be seen, consists of one short spring, *a*, to which one side of the line is connected, two long springs, which form a break in the test circuit, containing the test bat-

tery and the restoring-coil of the drop, a barrel,  $d$ , to which the other side of the line is connected, and a rim,  $e$ , which is branched to the test circuit. The plug consists of three parts, a tip,  $t$ , to which one conductor of the cord is connected, a sleeve,  $s$ , to which the other cord is connected, and a collar,  $c$ , which is insulated from the rest of the plug. When the plug is inserted in the jack,  $s$  makes contact with  $d$ , and  $t$  with  $a$ , thus bridging in on the line, while  $c$  makes a metallic bridge between  $b$  and  $b^1$ , and so closes the test circuit. The wires marked  $T$ ,  $l$  and  $l^1$  go to the other jacks in the

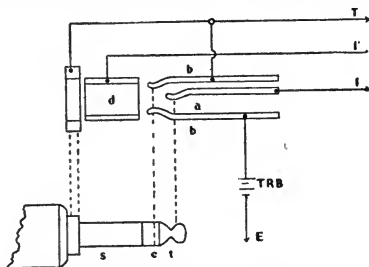

FIG. 133. DIAGRAM OF SPRING-JACK AND PLUG OF BRIDGING BOARD.  $a$  LINE SPRING,  $t$  TIP OF PLUG,  $bb^1$ , TEST SPRINGS,  $c$  COLLAR ON PLUG MAKING CONTACT BETWEEN  $b$  AND  $b^1$  AND SO THROWING  $TRB$ , TEST AND RESTORING-BATTERY, IN CIRCUIT WITH TEST WIRE AND RESTORING-COIL OF DROP,  $d$  BARREL OF JACK CONNECTED TO SECOND LINE WIRE,  $s$  SLEEVE OF PLUG, MAKING CONTACT WITH  $d$ ,  $e$  RIM OF JACK CONNECTED TO TEST WIRE,  $l^1$  LINE WIRES,  $T$  TEST WIRES.

series; the drop and restoring-coil are not shown. The line drop is bridged across  $l$  and  $l^1$ , and the restoring-coil is included in the test circuit between  $T$  and  $E$ .

237. The bridging system, as will be seen from the foregoing description, not only cuts down the number of operations in each connection, but materially improves both the electrical conditions of the lines and the mechanical arrangement of the



switchboard The provision of a balanced circuit throughout the board and the elimination of the jack contacts remove the worst features of the series multiple board, while the placing of the automatic drops above the jacks effect a marked gain in the compactness of the manually worked parts of the board, with a resulting improvement in speed and accuracy.

238. The system now being introduced in this country, which combines all the automatic features referred to in paragraph 230, with a fundamental improvement in the subscribers' station, is the common battery relay system. In the relay system the battery is at the central office and the subscribers' magneto generator and battery are done away with. In the signaling devices at the exchange a relay connected to the line and controlling an incandescent lamp in its local circuit takes the place of the drop. The operation of the board is reduced to the six steps for each connection, referred to above as being the present possible minimum. The subscriber—whose instruments are reduced to a transmitter and receiver, a switch-hook and a call bell—by taking the receiver off the hook operates the relay and lights the lamp corresponding to his number. The operator plugs into the answering jack, and by so doing extinguishes the line signal. Having got the number wanted, the operator plugs into the multiple jack and rings the called subscriber. When the conversation is ended the two subscribers hang up their receivers and the depression of the switch operates a lamp in each cord, which are the disconnection signals. The operator, by removing the plugs, extinguishes the disconnection signals and restores everything to its normal condition. It is not the province of the *HAND-BOOK* to describe in detail an elaborate system, such as the common battery relay system is. It would take a fair sized volume to do the subject justice, both in its technical features and in its general bearing on the working of large telephone exchange systems. But, briefly, it may be said that the relay board, with all its adjuncts, produces radical improvements in all directions. It reduces the subscrib-

ers' station to the three indispensable elements, call bell, transmitter and receiver; doing away with the vexatious question of battery inspection and renewal. It makes the operation of the connection as nearly automatic as it ever will be made in a large system, and gives the operator easy supervision of the progress of each call, effecting a marked gain in speed and simplicity of operation over previous systems. It provides the most distinct and easily supervised signals that can be had, a lamp being decidedly superior to any form of drop or needle indicator, And, finally, with all these improvements, it preserves the multiple system, which experience shows is still the best for large exchanges, but which was at one time threatened by transfer boards employing automatic lamp signals.

February, 1899.

## APPENDIX.

### HANDY INFORMATION FOR TELEPHONE MEN.

#### ELECTRICAL UNITS.

**RESISTANCE:** The true ohm is the resistance of a column of pure mercury 106.27 centimeters (41.839 inches) long, with a cross-sectional area of 1 square millimeter (.00155 sq. in.).

**ELECTROMOTIVE FORCE:** The volt is the electromotive force that, acting on a resistance of one ohm, will produce a current of one ampere.

**CURRENT:** The ampere is the current produced in a circuit having a resistance of one ohm by an electromotive force of one volt.

**ELECTROSTATIC CAPACITY:** The farad is the capacity of a condenser that, charged by one volt, will hold one coulomb. (1 coulomb=1 ampere for one second.)

**THE MICROFARAD**=one-millionth of a farad and is the practical unit of capacity.

**THE MEGOHM**=one million ohms and is used in expressing insulation resistance.

#### COPPER.

The specific gravity of copper is about 8.88; weight of one cubic foot 555 lbs.

The weight of a copper wire in pounds per mile is found by squaring the diameter in mills and dividing by 62.57.

The resistance of hard drawn copper wire at 60 deg. Fahr. is found by dividing the weight per mile into the number 890.

One mil=one-thousandth of an inch, or .001 inch.

The resistance of copper wire increases .21 per cent, approximately, for each degree Fahrenheit increase of temperature, and it diminishes in the same ratio for each degree fall of temperature. For instance, a wire which has a resistance of 100 ohms at 60 deg. will have 102.1 ohms at 70 deg. and but 97.9 ohms at 50 deg.

## INSULATION RESISTANCE.

The resistance of insulating materials is oppositely affected by change of temperature, increasing for decrease of temperature and diminishing for increase. The results of variation of temperature vary widely with different insulating materials. With fibrous materials, such as are generally used for telephone cables, a rise of 10 degrees in the temperature, say from 60 deg. to 70 deg., about halves the insulation resistance. This, however, applies only to treated cables, not to "dry core," which is not affected by temperature variations. With rubber insulation the fall of resistance for rise of temperature is not so precipitous as with materials treated with oils or with paraffin.

The required minimum insulation resistance for underground telephone conductors is 500 megohms per mile; the results obtained in practice are always much in excess of this, and a dry paper or cotton insulated cable that showed an average insulation resistance of only 500 megohms per mile would be considered defective.

The insulation resistance of submarine conductors is required to be not less than 300 megohms per mile at 60 deg. F.

## ELECTROSTATIC CAPACITY.

The capacity of overhead copper wires suspended at a height of 30 feet above the ground is approximately as follows.

Diameter of Wire in Mils.	Capacity per Mile in Microfarads.
80	.0144
104	.0148
165	.0157

On a pole line carrying a number of grounded circuits, the capacity of each wire will be about 5 per cent. higher. The capacity of iron wires is about 10 per cent. higher than that of copper.

The capacity of underground conductors varies from about .17 microfarads per mile in the case of treated cables to about .08 microfarads per mile in

the case of dry core cables. In specially constructed cables, using a No. 19 (35.9 mils) conductor and dry paper insulation, a capacity of less than .07 microfarad per mile is obtained.

The capacity of submarine conductors of the usual type varies from .3 to .36 microfarads per mile, according to the insulating material used and the diameter of the core. (The conductor is generally a strand of three or seven No. 22 copper wires.)

## BATTERIES.

	Electromotive force Volts.	Internal resistance Ohms.
Gravity .....	1.07	.2
Open circuit without depolarizer.	1.35	.25 to .5
Leclanche porous cup .....	1.7	.5 to 2.0
“ agglomerate forms . . .	1.7	.25 to .5
Fuller bichromate. ....	2.1	.3
Dry.....	1.3	Irregular

The electromotive force of open circuit batteries falls to about 1 volt within a short time when working on from 5 to 10 ohms external resistance.

Dry batteries polarize very quickly on low resistance and have a very irregular internal resistance.

# INDEX.

---

Numbers refer to paragraphs, not to pages.

Abdank's magnetic call.....	126
Ader receiver .....	53
" "super exciter" .....	50
" transmitter .....	87
Aerial cables.....	156
Amalgamation of zinc .....	113
American transmitters .....	63
Annunciator drops.....	191, 198
Articulate speech .....	9
Automatic switch.....	130
Batteries .....	98
" best position for .....	120, 169
" closed circuit.....	110
" creeping of .....	115
" Edison-Lalande .....	112
" E. M. F. of .....	103
" Fuller.....	110
" gravity .....	111
" internal resistance of .....	103
" Leclanché.....	100, 106
" maintenance of.....	117
" open circuit.....	102, 106
" polarization of .....	99
" practical management of .....	113
" without depolarizer.....	108
Battery gauge .....	176
Bell telephone .....	16
" " theory of.....	17
" " field of.....	17
" " sensitiveness of.....	42
" " modifications of.....	43, 49, 60
" " early forms of.....	44
" " mouthpiece of .....	45
" " double pole .....	46
Bell's patents.....	7
Berliner patent. ....	64, 77
" transmitter.....	77
" universal transmitter .....	81
Best position for telephone .....	168
Blake transmitter.....	65
" " adjustment of .....	68, 174
Böttcher receiver .....	59
Bourseul's experiments .....	4
Bridging bell, Carty's.....	128, 204
British Post Office system.....	236
Bridging board ....	232
Buildings, wiring of.....	165

Cables, aerial .....	156
" capacity of .....	150
" distribution of .....	154
" standard types of .....	151
" terminals of .....	152
" submarine .....	157
" underground .....	149, 151
Carbon transmitters .....	61
Clamond transmitter .....	93
Clearing-out drops .....	191, 198
Closed circuit batteries .....	110
Complete telephone circuit .....	38
Condensers .....	184
" in telephony, use of .....	185
" as telephonic shunts .....	215
Copper wire .....	140
" " hard drawn .....	142
Creeping of batteries .....	115
Cross-connecting board .....	154, 167
Crossley transmitter .....	88
Current induction .....	24
Cuttriss transmitter .....	84
D'Arsonval receiver .....	54
" transmitter .....	89
DeJongh transmitter .....	90
Desk transmitter .....	76
Double-pole receiver .....	46
Drop, self-restoring .....	233
" " " spring jack and .....	234
" " " and bridging board .....	236
Duplex telephony .....	213
Edison carbon transmitter .....	21
Edison-Lalande battery, setting up of .....	112, 119
Efficiency of telephone transmitters .....	94
Electromagnetic induction .....	30
" inertia .....	187, 216
Electrostatic capacity .....	146, 150, 186
" " on telephone currents, effect of .....	186
E. M. F. of batteries .....	103, 109
European transmitters .....	85
Exchange working .....	189, 224
" " automatic .....	224
Extension bell .....	129
Field of Bell telephone .....	17
Fuller battery .....	110
" " solution for .....	116
Goloubitzky telephone .....	50
Gower telephone .....	52
" transmitter .....	86
Gravity battery .....	111
" " setting up of .....	118
Gray's experiments .....	6
Ground connection .....	170

Hard drawn copper wire.....	142
Hibbard lightning arrester.....	161
Hughes microphone.....	22
Human ear.....	12
Hunning transmitter.....	63
"    "    "packing" of.....	72, 73. 81
Induction, electromagnetic.....	30
"    coil.....	31, 95
"    self-.....	187, 198
Inside wiring.....	165
Inspection of telephone sets.....	172
Inspector's kit.....	182
Installation of telephone sets.....	168
Insulators.....	143
"    transposition.....	147
Intermediate distributing board.....	198
Internal resistance of batteries.....	103
Invention of telephone.....	1
Iron wire.....	139
Joints in overhead wires.....	144
Kotyra receiver.....	57
Law system.....	200
Leclanché battery.....	100, 106
"    "    E. M. F. of.....	109
"    "    solution for.....	115
Lightning arresters.....	159
"    "    requirements of.....	160
"    "    fusible wire.....	161
"    "    Hibbard.....	161
"    "    electromagnetic.....	163
"    "    combination.....	164
Line construction.....	138
Long distance telephony.....	208
"    "    transmitter.....	63, 69
"    "    "    adjustment of.....	177
"    "    "    battery for.....	178
"    "    "    heating of.....	178
Luminous signal for exchange.....	238
Magnetic field.....	15
Magnet telephones as transmitters.....	59, 61
Magneto bells.....	121
"    "    adjustment of.....	173
"    "    automatic cut-out for.....	122
"    "    Abdank's.....	126
"    "    Carty's bridging.....	128
"    "    extension.....	129, 204
"    "    faults in.....	173
"    "    Post cut-out.....	123
"    "    Walker-Swinton.....	127
Maintenance of batteries.....	117
Management of batteries.....	113
Mechanical telephones.....	2
Mercadier "bi-telephone".....	55



Metallic circuits .....	146, 158,	209
Microphone .....	19,	22
Mix and Genest transmitter.....		91
Multiple switchboard.....	193,	195
"    "    spring-jack .....		194
Multiplex telephony .....		215
Neumayer receiver .....		58
New York-Chicago telephone line.....		212
Ohm's law .....		103
Open circuit batteries .....	102,	106
Overhead wires, construction of .....		138
"    "    joints in.....		144
"    "    spans of .....		145
"    "    poles for.....		145
"    "    protection from lightning .....		145
"Packing" of Hunning transmitters.....	72, 73,	81
Page's effect .....		3
Party lines.....		203
Phelps telephone.....		49
Pendulum selective signal.....		206
Polarized bell.....		181
Polarization of batteries .....		99
Poles for overhead wires .....		145
Position of batteries .....	120,	169
Post Office telephone system.....	86,	137
Proper use of telephone .....		171
Receivers, Ader.....		53
"    Böttcher.....		59
"    D'Arsonval .....		54
"    double pole.....		46
"    Kotyra.....		57
"    Mercadier .....		55
"    Neumayer .....		58
"    Siemens.....		56
"    single pole.....		47
Reis telephone.....		5
Repeating coils.....		211
Retardation.....		187
Sal-ammoniac .....		114
Selective signals.....		205
Self-induction .....	187,	198
Self-restoring drop .....		233
Self-restoring drop and bridging board.....		236
"Side tone".....		40
Siemens receiver.....		56
Signal, luminous, for exchange.....		238
Simultaneous telegraphy and telephony .....		216
Single cord switchboard.....		192
Single pole receiver .....		47
Small exchanges.....		201
Société Générale transmitter .....		92
Solid back transmitter.....	63, 73,	179
Sound waves.....		8

Spans of overhead wires.....	145
Speaking tube system .....	202
Spring jack and self-restoring drop.....	234
Standard switchboard .....	191
"    type of underground cable.....	151
Submarine cables.....	157
Switchboards .....	190
"    standard .....	191
"    single cord.....	192
"    multiple .....	193, 195
Telephone batteries .....	98
"    "troubles" .....	181
Theory of Bell telephone.....	17
Terminal room.....	153
Timbre .....	10
Transpositions in overhead lines.....	147
Transmitters, Ader .....	87
"    American .....	63
"    Berliner .....	77
"    "    universal .....	81
"    Blake .....	65, 67, 174
"    Carbon .....	61
"    Clamond .....	93
"    Crossley .....	88
"    Cuttriss.....	84
"    D'Arsonval .....	89
"    DeJongh.....	90
"    desk .....	76
"    Edison carbon.....	21
"    efficiency of .....	94
"    European.....	85
"    Gower .....	86
"    Hunning .....	62
"    "    "packing" of.....	72, 73, 81
"    long distance.....	63, 69, 177, 178
"    magnet telephones as.....	59, 61
"    Mix and Genest .....	91
"    Mildé granular carbon .....	221
"    Société Générale.....	92
"    solid back.....	63, 73, 179
Troubles in telephone installations .....	181
Twisted pairs.....	151, 157, 198
Underground wires, cables.....	149
"    conduits.....	152, 159
Undulatory currents .....	14
Walker-Swinton magnetic call.....	127
Wiring of large buildings .....	167
Wires, iron.....	139
"    copper .....	140
"    hard drawn copper.....	142
"    joints in .....	144
"    underground .....	149
"    twisted in pairs .....	151, 157, 198
Zinc, amalgamation of .....	113

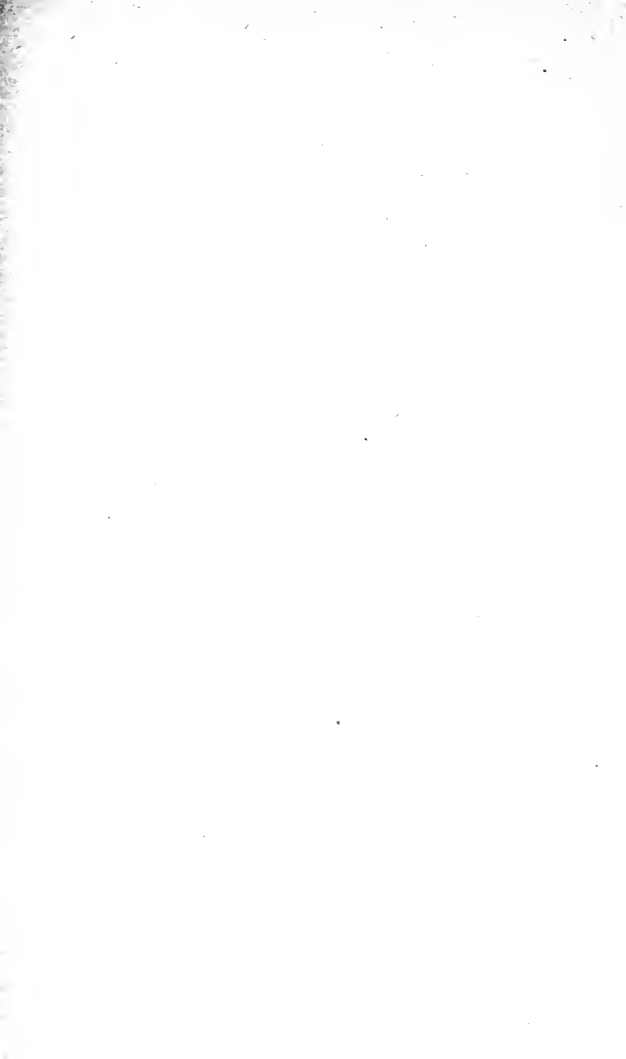



# Western Electrician

PUBLISHED EVERY SATURDAY,

At 510 Marquette Bldg., Chicago,

---

SUBSCRIPTION,	-	-	-	\$3 00 per year
FOREIGN SUBSCRIPTIONS,	-	-	-	\$5 00 "
SINGLE COPIES,	-	-	-	10 cents.

---

*40 Handsomely Illustrated pages Weekly.*

---

## THE WESTERN ELECTRICIAN

Is the only general electrical paper published in the West. It is the brightest, the handsomest, the newsiest, the best electrical journal published.

No one interested in electrical work should be without it. In its departments it gives to its readers the latest news, condensed and arranged in the most attractive manner.

Its special and general articles are of a high order. No electric light or power station, no telephone station, no telegraph office, no manufacturer of electrical goods, in fact no person in any way interested in electricity's rapid advance should be without it.

## THE WESTERN ELECTRICIAN

May be ordered through news dealers, or will be sent direct to any address on receipt of the subscription price. Address,

WESTERN ELECTRICIAN,

510 Marquette Building, . . . CHICAGO, ILL., U. S. A.

# NEW Dynamo Tenders' Hand-Book.

BY F. B. BADT.

---

First Edition now ready, containing much additional information, and many Valuable Tables.

---

230 Pages, 150 Illustrations. Flexible Cloth Binding. Size of Type Page, 6 x 8 inches.

---

This is as the name indicates, a **New Book**, much more complete than the old one, with all the information, instructions and rules which are required by practical men, as Dynamo Tenders, Line Men, Stationary Engineers, and owners and operators of all kinds of Electric Plants. It is the only book of the kind published in the English language.

---

**PRICE,** Post-paid to any address in the United States or Canada. **\$1.00**

---

*Address.*

Electrician Publishing Company,  
510 Marquette Building, - CHICAGO, ILL.

# NEW BOOKS.

AUTHORITIES ON SUBJECTS MENTIONED.

**THE POCKET ELECTRICAL DICTIONARY.** Containing all of the words and definitions in the science. A new work. Indispensable to the electrician, student and professor. Over 11,000 words and about 15,000 definitions. By *Edwin J. Houston*, A. M. Ph. D. (Princeton). 1 volume, 32mo, cloth, \$2.50; leather, \$3.00.

**ELECTRICITY MADE EASY.** Profusely illustrated. A handbook for busy people. By *Edwin J. Houston*, A. M., Ph. D., and *Arthur E. Kennelly*, Sc. D. 1 volume, 12mo, cloth, \$1.50.

**DYNAMO-ELECTRIC MACHINERY.** By *Silvanus P. Thompson*, D. Sc., B. A., F. R. S. Sixth edition, revised and enlarged. Profusely illustrated with new engravings. 19 folding plates. 2 volumes, 8vo, cloth, gilt, \$6.00.

**POLYPHASE ELECTRIC CURRENTS AND ALTERNATE CURRENT MOTORS.** By *Silvanus P. Thompson*, D. Sc., B. A., F. R. S. 1 volume, 8vo, cloth, gilt, \$3.50.

The most important work on the subject. A companion book to "Dynamo-Electric Machinery." One of the text-books in schools of technology and colleges. Beautifully illustrated with fine engravings. Folding plates. Invaluable to the expert electrician.

**ALGEBRA MADE EASY.** By *Edwin J. Houston*, Ph. D., and *A. E. Kennelly*, Sc. D.

This little work is of special value to readers of Prof. Thompson's *Dynamo-Electric Machinery* and *Polyphase Electric Currents*, as the work has been written to explain in a clear and simple manner the equations contained in those works. 1 volume, 16mo, cloth, 75 cents.

**THE INTERPRETATION OF MATHEMATICAL FORMULAE.** By *Edwin J. Houston*, Ph. D., and *A. E. Kennelly*, Sc. D. 1 volume, 12mo, cloth, \$1.25

A most valuable aid to students and electrical workers.

**A B C OF ELECTRICITY.** Now approaching its 65th thousand. By *William H. Meadowcroft*. 1 volume, 12mo, cloth, 50 cents. Fully illustrated.

This excellent primary book has taken the first place in elementary scientific works. It has received the endorsement of Thomas A. Edison. It is for every person desiring a knowledge of electricity, and is written in simple style so that a child can understand the work. It is what its title indicates, the first flight of steps in electricity.

**SCHOLARS' A B C OF ELECTRICITY.** By *William H. Meadowcroft*. 1 volume, 12mo, illustrated, cloth, 50 cents.

Sent Prepaid on Receipt of Price.

**ELECTRICIAN PUBLISHING CO.,**  
510 MARQUETTE BLDG., CHICAGO.

# INCANDESCENT Wiring Hand-Book.

---

BY F. B. BADT.

---

PRICE \$1.00.

---

Type page 6x3 inches, flexible cloth binding, 77 pages, 42 cuts, and 5 tables, 3 of which are 12x18 inches. These tables give **at once**, and without any calculations, the size of wire required in each case for any percentage of loss. A timely book, containing full illustrations for incandescent wiring and complete information concerning methods of running wires, location of safety devices, splices, insulation, testing for faults, wire gauges, general electrical data, calculating sizes of wire, wiring of fixtures, elevators, buildings, isolated and central station plants. The only book of the kind published.

---

Sent postage paid on receipt of price.

**ELECTRICIAN PUBLISHING CO.,**

510 Marquette Building,

**CHICAGO, ILL.**



# Bell Hangers' Hand-Book

By F. B. BADT.

106 Pages, 97 Illustrations. Flexible Cloth Binding. Type  
Page 6 x 3 1/2 inches.

PRICE, \$1.00.

---

JUST the book for those engaged in selling, installing or handling electric batteries, electric bells, elevator, house or hotel annunciators, burglar or fire alarms, electric gas lighting apparatus, electric heat regulating apparatus, etc., etc.

*The only book of the kind published.  
Sent, postage free, on receipt of price.*

---

ELECTRICIAN PUBLISHING CO.,

510 Marquette Building, - - - CHICAGO, ILL.

# DERIVATION OF

---

# Practical Electrical Units

---

BY

LIEUT. F. B. BADT AND PROF. H. S. CARHART.

---

PRICE, POSTAGE PREPAID, 75 CENTS.

---

This is a very handsome book of 60 pages, printed on fine heavy paper, with neat cloth binding. It contains PORTRAITS and BIOGRAPHIES of Ohm, Watt, Faraday, Joule, Gauss, Weber, Sir William Siemens, Dr. Werner von Siemens, Volta, Ampere, Daniell, von Jacobi, together with a carefully prepared table of the Practical Electrical Units, with their relative values.

**In no other Single Volume can this  
Rare Collection of Portraits be Found.**

---

## ELECTRICIAN PUBLISHING CO.

# JUST WHAT YOU ARE LOOKING FOR!

A New and Valuable Book.

## ELECTRIC LIGHTING PLANTS

### THEIR COST AND OPERATION.

By W. J. Buckley. With numerous illustrations diagrams, plans, tables, etc. 275 pages. Cloth. Price, \$2.00, postage free. This work gives all necessary data for the erection of an electric light plant of any size. The cost of Arc Lighting. The cost of Incandescent Lighting.

#### READ THE TABLE OF CONTENTS:

Alternating Arc Lamps, Arc Plants, Belting, Boilers, Boiler Settings, Boiler Efficiencies, Books, Building, Cost of Arc Dynamos and Lamps, Cost of Arc Plants Erected, Cost of Alternating Dynamos, Cost of Alternating Plants Erected, Cost of Belts, Cost of Boilers, Cost of Brick Chimneys, Cost of Copper for Alternating Circuit, Cost of Corliss Engines, Cost of Compound Corliss Engines, Cost of Compound High Speed Engines, Cost of Condensers, Cost of Friction Clutch Pulleys, Cost of Heaters, Cost of High Speed Engines, Cost of Incandescent Dynamos, Cost of Idlers, Cost of Injectors, Cost of Meters, Cost of Motors, Cost of Operating Lamps per hour, Cost of Power Generators, Cost of Poles, Cost of Plain Pulleys, Cost of Pillow Blocks, Cost of Pumps, Cost of Shafting, Cost of Shaft Couplings, Cost of Stacks—iron, Cost of Stacks—brick, Cost of Steam, Cost of Transformers, Cost of Wire. Chimneys, Circuit Loss, Contract Blanks, Current Distribution, Circuits—overhead, Circular Mills of Wire, Depreciation, Direct Connected Apparatus, Dynamos, Dynamo Data, Economy of Condensing, Economy of Covering Steam Pipes, Economy of Heater, Efficiency of Engines, Engines, Equivalent of Current in Horse Power, Equivalent Rates of Lighting, Fuel, Horse Power of Belting, Horse Power of Motors, Horse Power of Shafting, Incandescent Arc Lamps, Instruments, Instructions for Employes, Insulation, Labor, Load Chart, Meter Connections, Municipal Ownership, Natural Gas, N. E. L. A. Standard Rules, Oil, Outcome of Practical Management, Pole Line, Pulleys, Rope Transmission, Resistance of Wire, Rules—Fire Underwriters. Report Com. on Data N. E. L. A., Reports of Cities Owning Plant, Reports of Cities Contracting, Stock Room, Shafting, Transformers, Transformer Curves, Wiring Tables—Primary Wiring, Wiring Tables—Secondary Wiring, Wiring Tables, Motor Wiring, Wire, Wire Formula, Water Power, Wood as Fuel. The only book of its kind in the English Language. Price, \$2.00.

**ELECTRICIAN PUBLISHING COMPANY,**

**510 Marquette Building, CHICAGO.**

# IMPORTANT TELEPHONE BOOKS

**TELEPHONE TROUBLES AND HOW TO FIND THEM.** A complete handbook for telephone inspectors. By W. Hyde and J. H. McManman, edited by Prof. C. H. Haskins. Sixth edition. 16 mo, 50 pages. Price 25 cents.

This little volume is an extremely practical work for telephone employes, written in a popular style and devoid of technicalities.

**PATENTED TELEPHONY.** A Review of the Patents Pertaining to Telephones and Telephonic Apparatus. Published by the American Electrical Engineering Association. Cloth bound; fully illustrated. Price \$1.50.

**THE ELECTRIC TELEPHONE.** By E. J. Houston, Ph. D., and A. E. Kennelly, Sc. D.; 12mo, cloth. 422 pages. 142 illustrations. Price, \$1.00.

**THE PRACTICAL TELEPHONE HANDBOOK.** By Joseph Poole, A. I. E. E. Second edition; revised and enlarged. 360 pages. 288 illustrations. Price \$1.50.

**TELEPHONE LINES AND THEIR PROPERTIES.** By Wm. J. Hopkins. Second edition. 272 pages. Illustrated. Price \$1.50.

**A MANUAL OF TELEPHONY.** A new and large edition. By W. H. Preece, F. R. S., and A. J. Stubbs. 508 pages. 333 illustrations. Price \$4.50.

The Above, or Any Other Electrical Works Published, Sent Prepaid, on Receipt of Price.

**ELECTRICIAN PUBLISHING CO.,**  
510 MARQUETTE BUILDING, - CHICAGO.

# IMPORTANT TELEPHONE BOOKS

TELEPHONES, THEIR CONSTRUCTION AND FITTING. A Practical Manual on the Fitting Up and Maintenance of Telephone and Auxiliary Apparatus. By F. C. Allsop. 191 pages. 168 illustrations. Price \$2.00.

TELEPHONE SYSTEMS ON THE CONTINENT OF EUROPE. By Bennett. 436 pages. 169 illustrations. Price \$4.50.

TELEPHONING OF GREAT CITIES. By Bennett. Paper. Price 35 cents.

MAGNETO HAND TELEPHONE. Its Construction, Fitting Up and Adaptability to Everyday Use. By Hughes. 80 pages. 23 illustrations. Price \$1.00.

BELL'S ELECTRIC SPEAKING TELEPHONE. Its Invention, Construction, Application, Modification and History. By Prescott. New edition, revised and enlarged. 795 pages. 516 illustrations. Price \$4.00.

PHILIPP REIS, INVENTOR OF THE TELEPHONE. A Biographical Sketch with Documentary Testimony. By Thompson. Translation of the original papers of the inventor and contemporary publications. 182 pages. 3 plates and 48 engravings. Price \$3.00.

ELECTRICAL TRANSMISSION OF INTELLIGENCE AND OTHER ADVANCED PRIMERS OF ELECTRICITY, treating on the telegraph, telephone, etc. By E. J. Houston. 330 pages. 88 illustrations. Price \$1.00.

The Above, or Any Other Electrical Works Published, Sent Prepaid, on Receipt of Price.

---

**ELECTRICIAN PUBLISHING CO.,**

510 MARQUETTE BUILDING, - CHICAGO.

STANDARD  
ELECTRICAL  
DICTIONARY

BY T. O'CONNOR SLOANE

---

This new work should be in the hands  
of all who desire to keep abreast  
with the progress of the great-  
est science of the times.

---

600 Pages. : : : 300 Illustrations

---

PRICE, - \$3.00.

---

ELECTRICIAN PUBLISHING CO.

510 Marquette Building, CHICAGO.

# DYNAMO AND MOTOR BUILDING

## FOR AMATEURS.

With Working Drawings.

---

By Lieut. C. D. Parkhurst, U. S. A.

---

Cloth. 163 Pages. 71 Illustrations. Price, \$1.00.

---

Descriptions and working drawings are given of the following dynamos and motors:

A small ventilating fan motor.—A sewing machine battery motor, requiring no patterns or castings in its construction.—A sewing machine motor of more finished appearance and greater efficiency than the above. A 50-light incandescent dynamo.

A chapter treats of armature windings, connections and currents, giving minute instructions illustrated with detailed drawings. In the chapter on the 50-light dynamo the various technical points involved in dynamo design are fully and clearly treated, enabling the amateur to design other forms of machines than those described, in which he will be assisted by an appendix giving data of a number of high class motors and dynamos of standard manufacture.

*Copies of this or any other electrical book will be sent to any address, POSTAGE PREPAID, on receipt of price. Address*

**Electrician Publishing Co.,**

510 Marquette Building, - - - CHICAGO, II

# BUYERS OF ELECTRICAL BOOKS

Should remember that we are headquarters in the West for this class of literature. As we carry in stock all the

## Standard Electrical Publications

considerable time can be saved by ordering from us. We make a point of promptness in shipping. Every Standard Work is covered by our catalogue. Send for it.

Those interested in Electrical Literature are requested, when in Chicago, to examine our stock of books, which will be found complete in every respect.

**Electrician Publishing Co.,**  
510 Marquette Building, - - CHICAGO, ILL.





