

TELEVISION

*A Practical Treatise on the Principles upon which the
Development of Television Is Based*

By

K. A. HATHAWAY

Executive Secretary, Institute of Radio Service Men

ILLUSTRATED

AMERICAN TECHNICAL SOCIETY

American Technical Society

*publishes the following cyclopedias
reference libraries:*

- Modern Shop Practice..... 7 vols.
- Applied Electricity10 vols.
- Painting 5 vols.
- Automobile Engineering..... 6 vols.
- Electrical Engineering 7 vols.
- Architecture, Carpentry and
Building 5 vols.
- Practical Business Adminis-
tration12 vols.
- American Law and Practice.....12 vols.
- Sanitation, Heating, and Ventila-
tion Engineering 4 vols.

From the collection of the



San Francisco, California
2006

die
3/98
11954

Henry Schraub Kelly

1934.

eric
pub
efere
ern
lied
ting
omob
En
itect
Build
tical
ration
ricar
tation
ion E

TELEVISION

*A Practical Treatise on the Principles
upon which the Development of Television Is Based*

By

Kenneth A. Hathaway

Executive Secretary, Institute of Radio Service Men

Associate Member, Institute of Radio Engineers

Formerly Radio Technical Advisor, The Chicago Daily News

ILLUSTRATED

AMERICAN TECHNICAL SOCIETY
CHICAGO U. S. A.

1933

Copyright, 1933, By
AMERICAN TECHNICAL SOCIETY

COPYRIGHTED IN GREAT BRITAIN
ALL RIGHTS RESERVED

INTRODUCTION

THE NATURAL assumption would be, I suppose, that an author writing on a subject such as television would give some indication of his views on what will be the final outcome of the numerous development enterprises and when the art will have reached that stage where it can be declared universally to be a commercial reality. However, if there are those who expect to find predictions of this nature in the pages to follow, they will be disappointed, because, on the contrary, the text is confined to a concise explanation of the principles underlying the most recent development of the art of television from a nonpartisan standpoint.

¶ The text embodies data that will be of service to engineers, service men, and others who are interested in having a compact and complete record of television. The history of the art and the history of the development of the principles of light occupy an introductory position, preparatory to the more detailed explanation of the principles involved in the operation of the integral parts that make up television devices.

¶ The book is devoted principally to a discussion of mechanical systems of scanning inasmuch as those devices which are on the market employ mechanical movement to dissect the picture area. However, one chapter is given over to a presentation of the principles involved in electrical scanning and the development of the process. Scanning devices, the necessity for breaking up the picture, how it is first broken into its integral parts, converted into electrical energy, received, and reconstructed to reproduce what takes place in the television studio are discussed in sequence. There is also a description of one of the leading synchronous motors designed for use in operating a scanning system. A chapter which explains the principles involved and the process used in transmitting pictures by wire gives a description of what occurs in television, except that it is in effective "slow motion."

¶ I have purposely omitted expressing any opinion concerning the "ultimate" in television for the reason that any such prediction would constitute merely a personal opinion and could not be based upon any logical reasoning. That there can be no sort of prediction as to the time when television will be put into a commercially practical form—a matter wholly within the jurisdiction of a governmental body, the Federal Radio Commission—can best be shown by referring to an incident that happened when the data included in the following pages was in the early stages of compilation. It was my privilege to visit with one of the pioneers in the development of television, N. S. Amstutz, now a patent

attorney in Valparaiso, Indiana, who presented photostated copies of an article which he had written and which had been published in two sections in a magazine called "Electricity" under date of February 28 and March 14, 1894. The articles gave a chronological sequence of the high points in the development of what was then known as "Visual Telegraphy," explaining a method that had been developed by Mr. Amstutz himself for visual transmission between telephone stations. The final paragraph of the last article is pertinent and runs as follows:

"In conclusion, it should be stated that Prof. Ayrton recently expressed his intention of again resuming his researches which were commenced nearly seventeen years ago. This is truly significant, for it is evident that the successful consummation of this important attainment will not be dis-
tantly removed into the future."

¶ Be that as it may, there is no gainsaying that the development of television is inevitable. Whether it takes its place among other entertainment features for the home or whether it is limited in its use to commercial projects such as the transmission of pictures, there can be no doubt that the field will be of large proportions. The facilities that are available today should aid greatly in the solving of the problems involved so that this large field of endeavor might be added to the long list of scientific developments for which the twentieth century is noted.

¶ The development of television is not confined to the laboratory for the reason that it is not entirely an engineering problem. The development of programs and the determination of the type of programs are of as much importance as the methods to be employed for transmission and reception of the television signals. Laboratory assistants lose their utility as critics of programs after a short time. They look for the discrepancies from an engineering standpoint and pay little or no heed to the entertainment value of the presentation. The public alone stands in a position to criticize programs constructively, but they cannot act in this capacity unless steps are taken to get sets into the homes in large numbers.

¶ I feel that the art of television should be assisted in every way possible and it is my hope that the facts that are presented in the following pages will stimulate the development of new ideas and that there may be an interchange of ideas that will result in expediting the attainment of the "ultimate."

N. A. Hathaway

ACKNOWLEDGMENTS

THE AUTHOR wishes to acknowledge the valued assistance rendered in the compilation of the matter in the following pages. In one way or another those whose names appear below lent their support and furnished data, drawings, photographs, or material that facilitated his efforts.

N. S. Amstutz
Valparaiso, Indiana

C. F. Wade
President, Western Television
Corporation

Martin Wade
Western Television Corporation

Lloyd P. Garner
Chief Engineer, Western Television
Corporation

William N. Parker
Engineer, Western Television
Corporation

R. E. Wagner
Engineer, Western Television
Corporation

Armando Conto
Engineer, Western Television
Corporation

D. E. Replogle
Chief Engineer, Jenkins Television
Corporation

Hollis Baird
Short Wave and Television Corporation

U. A. Sanabria
Sanabria Presentations, Incorporated

Captain W. J. Jarrard
Baird Television Corporation

D. L. West
Baird Television Corporation

Continuity Department
WMAQ and W9XAP

A. N. Murray
RCA-Victor Company

A. J. McMasters
G-M Laboratories, Incorporated

L. C. F. Horle
New York City



Apex Photo Co.

A 1933 model television receiver for the home. The set, developed in the Western Television Corporation laboratories, is about the size of an ordinary midget radio receiver and contains all the necessary apparatus to tune in and reproduce visual signals.

CONTENTS

	Page
Principle of Television.....	1
History of Television.....	6
Principles of Light.....	13
Optics	21
Photoelectricity	51
Reproducing Devices	61
Facsimile Transmission—Television in Slow Motion...	71
Television Scanning Devices.....	80
Combining Scanning with Associated Equipment.....	97
Receiving Circuits	129
Motors	146
Electrical Scanning	155
Appendix	164
Index	167

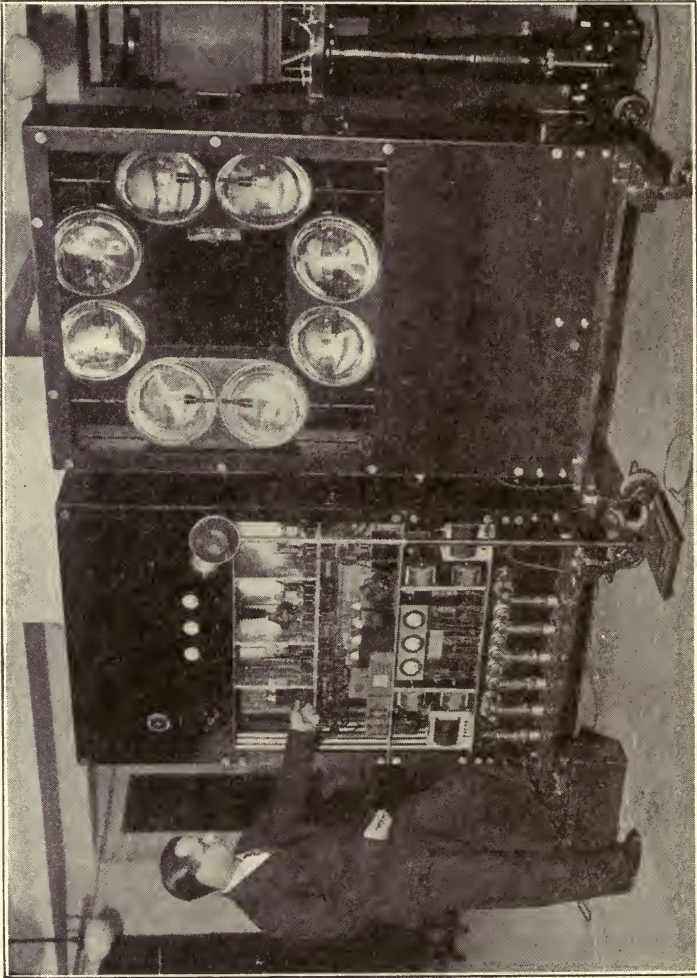

The amplifier and microvisor developed by U. A. Sanabria (at left) for use in theatrical presentations to project television pictures upon a screen six to ten feet square. The photoelectric cells are placed in reflectors, and the cells are mounted so that the varying impulses are reflected upon the light sensitive material. Note that each pair of cells is adjustable by means of the bars upon which the reflectors are mounted.

TELEVISION

CHAPTER I

PRINCIPLE OF TELEVISION

Television is the art that deals with the instantaneous transmission and reception of pictures or moving images by electrical means. It may be said to provide a means for seeing over wide spans through the aid of electrical devices. The definition is modified by the use of the word "instantaneous" in order to distinguish the art of television from that of telephotography, which is another method used for the transmission of pictures, and has been in use for a number of years. The principles underlying the operation of both television and telephotography are, however, identical.

Although light is said to consist of an infinite number of electrical charges vibrating at frequencies and having wave lengths characteristic of each color, it is necessary that it be converted into such form that it can be directed as an electric current. Light is related to television as magnetism is related to electric power, in that the charges roaming promiscuously through space are harnessed and directed according to the desires of man.

Photoelectric Cell. The photoelectric cell, Fig. 1, sometimes called the electric eye, provides a means for converting light into electric energy by making use of a phenomenon peculiar to certain metals whereby they react electrically to the presence of light proportional to the intensity of the illumination. The function of the cell in its relationship to other apparatus is identical with that of the microphone in the sound studio in that the photoelectric cell provides a means for converting a succession of varying light intensities into electric current, whereas the microphone varies the current flowing in the circuit in accordance with the variations in sound pressure. However, although the photoelectric cell assumes a place identical with the microphone, the method of operation is considerably different.

The energy that is generated by the photoelectric cell is small compared with that obtained from the microphone, necessitating the use of an extensive amplification system to provide a strong signal.

Scanning. The breaking up of the picture or image into a series of varying light intensities is called "scanning." It is necessary to thus divide the picture in order that instantaneous reflections of light may cause variations in the energy generated by the photoelectric cell. The scanning operation may be accomplished either mechanically or electrically. The mechanical system has been used more extensively, because of difficulties encountered in the development of electrical methods. It would be foolhardy at this time to predict the future of television so far as the method of scanning is concerned, but there is reason to believe that mechanical scanning will not be supplanted by electrical scanning in television devices for the home in the immediate future.

An electric motor is used as a propelling power to rotate a perforated disc in a mechanical scanning system. The most satisfactory results have been obtained by using a synchronous motor for the reason that the speed of the scanning disc remains identical with that at the transmitter at all times—a condition that is essential if television is to be successful. The success of a synchronous motor is dependent upon the unification of power systems. Otherwise a means for synchronizing must be incorporated in the television system.

Transmission of Signals. The transmission of television signals corresponds directly to the transmission of voice or continuous wave. The varying impulses coming from the photoelectric cells are amplified through a progression of amplifier stages employing vacuum tubes and resistance coupled devices until the weak signals have been made strong enough to properly modulate the carrier wave generated in the transmitter. The carrier wave then assumes a form similar to that for the broadcasting station except that the fluctuations are more sharply defined for the reason that the changes from light to dark are more rapid than the variation between the high and low frequencies of the voice range.

Reception of Signals. Reception of television signals is accomplished by means of a radio receiver equipped with an audio system capable of responding to both low and high fre-

quencies with equal fidelity. Otherwise, the receiver is identical with one designed for the reception of voice except that it must tune to resonance with transmission frequencies used for television, which are higher than those designed for voice broadcast.

Reproducing Device. The reproducing device for television takes the place of the loud speaker for the voice receiver. It consists of a scanning mechanism, identical with that employed at the transmitter, and a lamp, which is con-



Fig. 1

nected directly to the output of the receiving set exactly as is the loud speaker of a broadcast receiver.

The glow lamp serves to convert electrical impulses into light waves and is so made that it responds to the fluctuations of energy delivered by the receiving set to cause the intensity of the illumination which is within the tube to change accordingly. The fluctuations in the output of the receiver correspond to the variation in the intensity of the light reflections projected upon the sensitive electrode of the photoelectric cells in the studio at the television transmitter.

The size of the original picture at the receiving station is dependent upon the design of the apparatus. In earlier sets a lamp with electrodes a little more than an inch square was used, which necessitated an original picture of about one inch square. However, the picture can be enlarged through the use of lenses so that with a single lens the received picture

may appear to be about four inches square or more. A more extensive projection system permits greater enlargement.

Later developments in projection devices for television receivers include a glow lamp that delivers a concentrated beam of extremely high intensity used in conjunction with a disc in which lenses are fitted into apertures which have a concentric relationship identical with the perforations in the ordinary scanning disc. The picture can be projected upon a ground glass screen that is large enough to enhance its value in a home receiver in that the reproduced picture may be seen by a comparatively large group. The development of the crater type lamp, as well as the hot cathode type, removed one of the greatest obstacles to television for, prior to its introduction, it had been necessary to provide a "peep hole" variety of receiving device which limited the size of the group witnessing a television program.

A group of photoelectric cells is usually used in the television studio in order to compensate for the small amount of energy that each cell generates as well as to give depth to the picture. Such a group of cells is called the "microvisor," a name that is partially borrowed from the nomenclature of sound studio devices. The name may apply to the pick-up apparatus whether it consists of a single photoelectric cell or a group of cells.

Mechanical Scanning. Mechanical scanning is a means for producing a shutter effect so that the light projected from the light source upon the subject before the photoelectric cells is directed in such a way that it is cast upon a different portion of the subject at successive instants and in a definite sequence. The most common method for producing the effect is to provide a metallic disc in which holes are arranged in a spiral with reference to the center of the disc. Another means is that provided by a drum in which the perforations are spiralled along the wall of the cylinder. Still another method uses a vibrating mirror, the vibrations in this case being controlled by an electrical device or by a cam according to the design. Another method is that in which mirrors are placed upon a drum at predetermined angles so that the light is reflected to different portions of the subject from each mirror. A motor is the common propelling power for nearly any style of mechanical scanning.

Electrical Scanning. Electrical scanning is accomplished by means of a stream of electrons controlled by alternating electrical currents which are introduced in such a relationship to the electronic stream that they cause the stream to move horizontally and vertically at a predetermined speed.

Consequently, we have in television a new group of terms with which we must become familiar; the *photoelectric cell*, which provides the means for converting light into electrical energy; the *glow lamp* or *neon cell*, which converts the varying electrical impulses into light waves; the *light source* is a means for obtaining a high intensity illumination to be projected upon the object being televised; the *scanning disc*, which acts as a shutter and cuts off the beam from the light source which is being projected at a predetermined sequence; the *lens disc*, which is a scanning disc equipped with lenses to enlarge the picture and to provide a means for projecting the reproduction upon a screen to enable a large group to observe the program; the *crater lamp* is a variation of the glow lamp and is so designed to give a concentrated light of high intensity; the *televisor*, a common name given the device for reproducing the light impulses at the receiver and in which the observers see the picture, otherwise named by one manufacturer the "Visionette;" the *microvisor*, the assembled group of photoelectric cells in the studio before which the object or objects, animate or inanimate, are placed and upon which varying light reflections are impressed to create an electric current; and *framing* is the proper positioning of the picture with reference to the screen or aperture in the televisior.

CHAPTER II

HISTORY OF TELEVISION

Television is not a new art. Disregarding the discovery of such phenomena as inductance, capacitance, and other electrical functions in the early part of the nineteenth century, television dates back to 1877 when the first officially recorded presentation of the transmission of pictures by electrical means was made. Innumerable experimenters, inventors, physicists, and scientists have engaged themselves in the interesting study since that time, but it was not until the late 1920's that anything bordering upon a successful attainment of results rewarded the efforts of the investigators.

The art of electrically conducting or transmitting optical images over distances really dates back to 1817 with the discovery of selenium by Berzelius. Selenium, an element, was found to be photoconductive by Knox, and in 1873 Willoughby Smith discovered that the substance changed its resistance to the flow of electrical current according to the variations in the intensity of the light projected upon it. Consequently, it entered into the early investigations and continued to be used as the means for converting light into electrical energy until during the early part of the twentieth century when photoelectric metals, metals that generate electrical energy when subjected to light rays, were discovered.

Each generation since 1877 has seen and heard of television and each successive development has given promise that the aim of the early scientists was about to be realized. Then, discoveries during the early part of the twentieth century provided material with which to make greater progress in this important research, so that regardless of the fact that there is still more or less crudeness, the clarity of reproduction and naturalness is remarkable.

All experiments in connection with television prior to the advent of radio were considered from the standpoint of wire transmission and were referred to as "visual telegraphy." In fact, that term is the subject of a series of articles by N. S. Amstutz, in "Electricity," a trade publication, February 28 and March 15, 1894.

The fact that the art was referred to in connection with telegraphy did not preclude its application to other forms of research as is shown by the personalities included in the list of inventors. The work of Alexander Graham Bell, the inventor of the telephone, was the foundation for later research that has resulted in the perfection of facilities for facsimile transmission as well as providing a television system for use in connection with telephone systems that has recently been demonstrated. Bell also experimented upon the theory that a ray of light could be used for the transmission of speech. Thomas A. Edison and Samuel F. B. Morse are also credited with having had a hand in the early researches.

Messrs. Ayrton and Perry, experimenters, are credited with having been the first to announce a practical system for conducting luminous images from one point to another electrically. The image was projected upon a glass plate by means of a lens system similar to that employed in a camera. The plate was mounted in front of a cylinder in which a number of selenium cells were placed in a spiral so that when the drum was rotated each of the cells passed an aperture in range of the rays of light from the illuminated plate. Each cell was so arranged that a small portion of its surface was exposed to the light and successive cells were protected, so that they "saw" a portion of the picture about .01 of an inch below that of the preceding one. The drum carrying the cells rotated at a speed of about 600 revolutions per minute, so that the object was scanned ten times each second.

The receiving system used by Ayrton and Perry consisted of a group of projection devices each of which was focused upon a screen and provided with a valve-like arrangement that permitted the passage of a light ray having an intensity determined by the intensity of the ray cast upon the selenium cell placed at the same relative position on the transmitting screen. The mechanical device which controlled the projection of light upon the receiving screen was connected mechanically to the propelling device at the transmitting end.

It is not necessary to delve into the details of each of the steps in the development of the art of television. The system used in the Ayrton and Perry experiment will be recognized as the forerunner of one proposed during the 1920's when it was suggested that a large screen containing a large number

of photoelectric cells be used in connection with a similar screen upon which a specially constructed glow lamp with a corresponding number of elements was mounted. Then, each of the cells at the transmitter was connected by wire with the glow lamp in the same relative position on the receiving screen and a rotating switch made and broke the contacts so that only one cell and its attending glow lamp was in circuit at any given instant.

The scanning disc, which is the basis for all mechanical systems, is credited to Paul Nipkow of Berlin, who used the

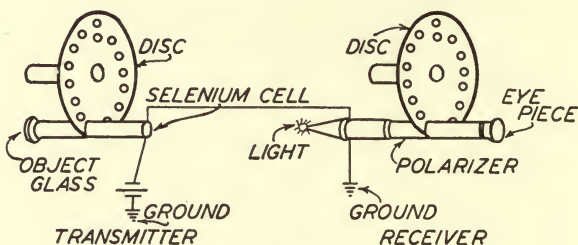

Fig. 2

disc with perforations arranged in a spiral in a system which he announced in 1884. Nipkow's device used a single selenium cell for converting the light waves into electrical impulses. The arrangement used by him is shown in Fig. 2. The disc with the perforations was rotated in a slot in the telescope-like device (in fact, it was called the electric telescope) that was focused upon the object being televised and cut the ray to the selenium cell that was placed in the other end of the telescope. The receiving device consisted of a similar arrangement so far as scanning is concerned, and a light of constant intensity was used for projection purposes, the amount of illumination being controlled through an electrical valve between the light and the scanning device. The electrical valve was in the nature of a light polarizer, which in this instance consisted of a cylinder filled with bisulphide of carbon.

The next principal step in the development of television as we know it today was that of Weiller, which made use of a drum with a series of mirrors mounted upon its outer edge. Each of the mirrors was set at a different angle so that suc-

cessive reflectors covered a portion of the screen slightly below that of the preceding one. The mirrors were placed so that the light reflections were directed upon the selenium cell connected by wire to the receiving device.

The development of the telephone had progressed far enough as to make a telephone receiver a handy device in the hands of Weiller. Fig. 3 shows his adaptation of the telephone

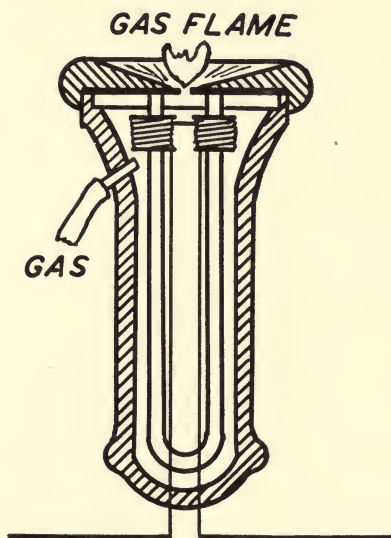

Fig. 3

receiver as a means for furnishing the varying illumination to reconstruct the image as broken down in the scanning operation at the transmitting end of the Weiller experiment. Notice that provision was made for introducing gas into the bell of the telephone receiver. A small hole was drilled in the center of the diaphragm and the jet of gas was lighted. The diaphragm moved inward more or less according to the impulses of current in the line from the transmitter and, if the motion was greater, the intensity of the flame was correspondingly greater because more gas was emitted. Conversely, if the movement of the diaphragm was not so great, the flow of gas was nearer normal and the flame was less brilliant. The

variations in the intensity were reflected upon a screen by means of another mirrored drum identical with that at the transmitter and rotating at the same speed.

The late Thomas A. Edison also contributed to the art of television, although little is known of his efforts. It is stated that his experiments combined the functioning of the phonograph and the kinetograph, the moving picture machine, to provide a means for recording a picture at the receiving end or for reproducing a picture from a record.

Le Pontois in 1893 combined the practices of Nipkow with those of Weiller in another development which is more valuable because it represents the first attempt to attain synchronism between the transmitting and receiving stations without the use of directly coupled machines. Le Pontois made use of synchronous alternating-current motors with the result that once the scanning devices had been set in operation with the perforations at both the transmitter and receiver in the same relationship, that relationship was maintained indefinitely.

Samuel F. B. Morse, famed as the inventor of the telegraph, engaged in investigations along the line of a single wire to connect each of a large group of cells with others in a reproducing device so that the relationship of individual cells was the same on the receiving and transmitting screens. The "cells" referred to instead of being actual cells were really the ends of the wire cable dipped in selenium.

Various forms of discs, drums, and the like were made the basis for further experimentation, but the fact that nothing except selenium was available for converting light into electrical current established an obstacle that prevented the experimenters from attaining the much coveted objective—successful transmission of visual images.

Little is known of the accomplishments of experimenters during the first two decades of the twentieth century, except that certain substances were found to be sensitive to light and when connected into a circuit would control the flow of current due to an electronic action.

Television researches began to reappear subsequent to the advent of radio broadcasting. C. Francis Jenkins of Washington, D.C., and John L. Baird of London, England, almost simultaneously in 1925 successfully demonstrated the transmission of silhouettes by television. At the same time U. A.

Sanabria of Chicago was employing tactics similar to those employed by Jenkins and Baird. Similarly, at the General Electric Laboratories and at the Bell Telephone Laboratories, Dr. E. F. W. Alexandersen and Dr. Herbert Ives were conducting experiments with mechanical and electrical scanning systems.

The transmission of pictures approaching the halftone effect were first transmitted in 1926 by Baird when he gave a demonstration before members of the Royal Institution. The studio technique was comparable with that of the television studio of today and the artists appeared before the microvisor when a beam of light was directed over the picture area. The arrangement was extremely crude, as might be surmised.

The first transmission of motion pictures using motion picture film was done in June, 1925, by C. Francis Jenkins. The demonstration was given before a selected group of officials and was heralded widely by the daily press as indicative of an early consummation of the important development.

It can be seen from the foregoing review of the development of television that the apparatus used today is very little different from that used in the early experiments. The disc that was introduced by Nipkow in 1884 is used today by the majority of the television laboratories and stations of the world, and, in fact, practically every experimental project has incorporated either the original design or an adaptation at one time or another during the course of development. Attempts have been made recently to use some device that did not deviate a great deal from that projected by Weiller in 1889 and it has not been many years since modern laboratories proposed a scanning system that corresponded directly with that used by Morse in 1893.

All this is in retrospect to show that the fundamental principles governing television are not new. Some of them are now more than fifty years old, but because of the rapid strides of science today the old principles have been developed to the point where television can be commercially adapted and assume its place among the industries of the world.

The greater part of the development has had to do with the means for converting light energy into electrical energy and then reconverting the electrical energy into light waves. On the other hand, such development would not have been of

any value had it not been for the findings of radio engineers that have made available high-grade amplifying equipment and vacuum tubes with which to couple the amplifiers. Not only that, but the mechanics of today are far advanced over that period fifty years ago; and although the glory of bringing about the ultimate development of television will undoubtedly go to the engineers of the twentieth century, the scientists and inventors of the nineteenth century are deserving of an enormous amount of credit. It is not improbable that with some of the advantages with which we are blessed today the invention of television might have been definitely accredited to Nipkow, Ayrton and Perry, Bell, Edison, Amstutz, Weiller, Johnson, and Le Pontois. Since they did not have the advantages, the list of names usually connected with television are vastly different and include such personages as Jenkins, Baird, Sanabria, Farnsworth, Ives, Zworykin, and others connected with the large corporations in whose laboratories much work is being carried on.

Great advances have been made since the demonstrations in 1925 and 1926 and with each successive year it has seemed that the culmination of the art is drawing closer. No one is qualified to say how soon the development will have reached the point where the acceptance of television as an entertainment feature for the home is assured.

CHAPTER III

PRINCIPLES OF LIGHT

It is not the province of this treatise to delve deeply into the study of light, but a study of the subject of television requires a review of certain principles because of their relationship with the art of television.

Light is the agent by which objects are rendered visible. It is said to be a disturbance that produces the sensation of vision, provides illumination, and makes possible the creation of photographic and photoelectric effects.

Historical. The study of light has held the astronomical world for many centuries. Records show that much was known about the laws governing light action long before any definite theory concerning the phenomenon itself was accepted. Sir Isaac Newton, of gravitation fame, was one of the first to make a definite stand on the subject. He considered a ray of light to consist of corpuscles; and although a Dutch physicist, Huygens, propounded the wave motion theory which has since been accepted, the Newton hypothesis was considered as law for nearly a century principally because of Newton's reputation as established through his discovery of the existence of the force of gravity.

In 1801, Thomas Young, an English physicist, took up a defense of the wave motion theory of Huygens and, by persevering in his statements with adequate proof, the scientific world was forced to accept his deductions to the exclusion of the Newton hypothesis. There was no association of light and electricity at this time, however, and the theory as set out by Young stated that both light and heat waves were vibrations of particles in the *ether* and that the difference between light and heat lay in the fact that the particles giving light vibrated more rapidly than did those emitting heat. Although the Young theory is, in effect, that of today, it was sixty years after Young had succeeded in obtaining an acceptance of his theory before the electromagnetic theory of light was introduced.

Electromagnetic Theory of Light. James Clerk Maxwell, an English mathematician, advanced the electromagnetic theory by which light is said to consist of electrical vibrations or vibrations of electrically charged particles in the air or other medium through which the light is passing. Color and shading are said to depend upon the speed with which the charges are vibrating.

The vibrations of the particles must not be confused with electronic flow as it is known in radio, although the particles that form light are said to be electrons. Those forming light have no apparent destination and are merely in a vibrating state, whereas those that have a definite destination create an electric current.

Light Waves. Light, like sound, is produced in wave form, the disturbance traveling in waves identical with those produced by casting a stone into a pool of water. The distance between the crests of the waves is called the "wave length," deep red having the the longest wave length and violet the shortest wave length visible to the human eye.

The measurement of the wave length of light is an involved process for the laboratory and has no bearing upon the subject at hand. However, it should be stated that although the normal range of vision differs with individuals, it is considered to be approximately 0.000077 cm., the wave length of deep red, to 0.000037 cm., the wave length of violet. Light having longer and shorter wave lengths than are included in the limits given is referred to as infra-red and ultra-violet, respectively. Infra-red rays, although not visible, are discernible because of the heat radiation created by their presence. Then, too, objects in a room, which so far as the human eye is concerned is in absolute darkness, may be flooded with either infra-red or ultra-violet light for photographic purposes. Special films are required, however.

The phenomenon of the relationship between heat and light as well as the presence of the infra-red rays is best described by an experiment using an incandescent lamp with a varying electrical supply. If a low current is allowed to pass through the circuit, heat waves will be radiated. Increasing the current will cause the element to glow with a dull red and as the current is steadily increased the color of the illumination will change step by step from red to orange, orange to yel-

low, yellow to green, green to blue, and blue to violet. None of the changes will be made abruptly, and, in fact, they will take place so gradually that differentiation would be difficult. Again, certain individuals will be unable to observe some of the changes because of the failure of the eye to respond to specific bands of vibrations.

The limitations of the device used in the foregoing experiment prevent the making of ultra-violet rays, except that a limited number may be present from natural causes. An arc generates ultra-violet rays in abundance, but the eye will detect only those rays having wave lengths as given above.

Speed of Light. Experiments to determine the speed of light have not been confined to modern science. Approximate valuations had been obtained before the advancement of the Newton theory. During the twentieth century, however, more accurate figures have been derived and chief among the experiments that have been conducted have been those of the late Professor Albert A. Michelson of the University of Chicago.

By means of an ingenious arrangement of mirrors and timing apparatus, Professor Michelson found the speed of light to be 186,293 miles per second, which translated into the metric system is 299,796,000 meters.

Direction of Travel. A ray of light is said to travel, but actually it penetrates. It continues to penetrate in a straight line until some object stops or deflects it. The manner in which it is deflected or reflected depends upon the substance with which the ray comes in contact.

Diffraction.* When a ray of light strikes a substance through which it cannot penetrate, a shadow is formed on the side opposite that from which the ray originates. At the same time, the total area behind the object will not be completely shadowed due to what is known as *diffraction*. The outer portion of the shadowed area will be lighter than the center because the vibrations of electrons passing along the side of the object are reflected upon dust and other particles in the air. The intensity of the light will gradually weaken, however, until it is completely exhausted and there is a theoretical total shadow.

*The mathematical analysis of each of the principles of light radiation, reflection, diffraction, refraction, etc., is made very effectively in "Physics for Technical Students" by Anderson, McGraw-Hill Book Company, Publishers.

Classification of Light Penetration Media. Substances are either transparent, translucent, or opaque according to the way in which they permit the passage of light. A transparent substance is one through which light rays may pass and through which objects may be seen readily by the human eye. Plate glass is an example of a transparent substance. A translucent substance is one which obscures the vision but which will permit penetration of light rays to a certain extent as, for example, frosted glass. An opaque substance is one which will not only obscure the vision but which will also absorb so many of the light vibrations that the ray cannot pass through it.

Contrary to the opinion one would naturally obtain, there is no definite line to be drawn between substances that are

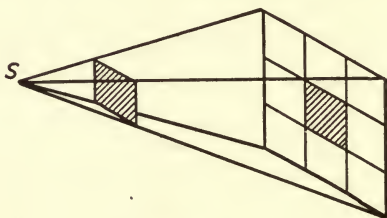

Fig. 4

transparent, translucent, or opaque. An object that is in some cases opaque may be made sufficiently thin as to be translucent or even transparent. Mica represents a striking example. A stack of mica sheets might form an opaque substance, whereas a few sheets would render it translucent or a single sheet would be comparatively transparent.

Intensity of Light. Intensity is a property of light that enters into the subject of television appreciably. The intensity of illumination varies inversely as the square of the distance from the source, so that an object three feet from a light source receives one-ninth as much light as one that is only one foot away, see Fig. 4.

Reflection. An object is never perceived directly by the human eye. Instead, the reflections of light waves from the point upon which the eye is focused create what is called "sight." A rough surface is seen much more easily than one which is very smooth, because the reflections are cast in several

directions instead of in a single ray as from a smooth surface. A rough surface diffuses the rays, whereas if the surface is extremely smooth, as for instance a mirror, the light waves or rays are not diffused appreciably and are, therefore, cast back in a form identical with that in which they strike the reflecting surface, except that they are reversed as to position. The intensity of a reflected ray is equal to that of the original less the loss caused by diffusion, which is determined by the nature of the reflecting surface.

The image seen in a reflecting surface is called the "virtual image" and has no actual existence. At the same time it gives the appearance of being existent because it coincides from the perspective point of view with what is reflected. It should be pointed out also that reflections may be the result of light rays reflected from an illuminated object although the reflecting surface may be in a compartment which is to all practical purposes dark. Thus, if a ray of light were projected upon an object in a dark room, the object would be visible in a mirror also in the dark room.

The angle at which the light rays strike the reflecting surface with reference to the perpendicular to the surface is called the *angle of incidence*. The angle of the reflected ray with respect to the perpendicular to the reflecting surface is called the *angle of reflection*. *The angle of incidence always equals the angle of reflection.*

Refraction. Reflection and refraction are two related properties of light. Reflection, as shown in the preceding paragraphs, is the turning back of the light rays; refraction deals with the effect upon a ray of light as it passes through various media.

When a light ray passes through a pane of glass, it has the appearance of being unhampered. But, unless the ray is impressed upon the glass from an angle exactly 90 degrees to its surface, it is bent and proceeds on the other side of the glass in a line parallel with the ray coming from the source if the glass is clear. Fig. 5 shows how a ray of light changes its direction when passing through plate glass.

Refraction of light is caused by the difference in the speed with which light travels through various media. Whereas light travels at a speed of approximately 186,000 miles per second in air, it will not travel at that speed through media

that have a greater density, such as glass, water, etc. Therefore, if a ray of light is cast obliquely against the side of a pane of glass or against a column of water, the difference in the speed causes the ray to bend as shown in Fig. 6. The ratio of the velocities of light through any two media is called the *index of refraction*.

The density of the media, and therefore the governing factor in the speed with which the light travels through them, also determines the direction in which the ray bends. Consequently, if the second medium is of lesser density than the

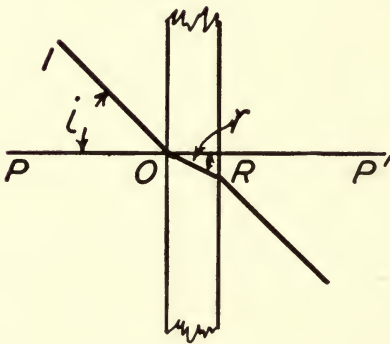

Fig. 5

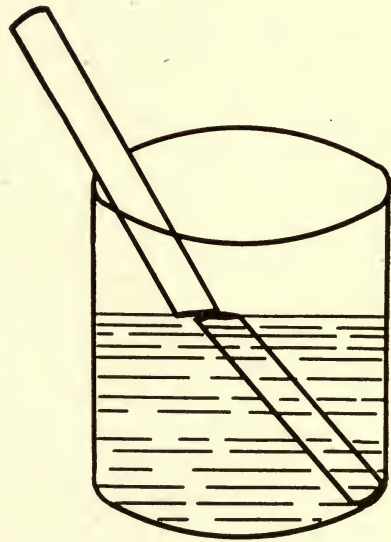

Fig. 6

first, the ray will bend toward the perpendicular; while if the second medium has the greater density of the two, the ray will bend away from the perpendicular, the perpendicular in each instance being considered relative to the surface of the medium, otherwise known as *normal*.

Refraction of light enters into television principally because of the necessity for the use of optical devices. The projection of illumination through optical systems and the subsequent projection of the reconstructed image upon a screen for purposes of reproduction involve the adaptation of the principles of refraction.

A complete study of refraction involves extensive use of mathematics, which is beyond the province of this treatise. Therefore, only those points that are of value to this subject will be discussed under the heading "Optics."

The ray of light coming from the source is called the *incident ray*. The angle between the path of the incident ray and the perpendicular is called the *angle of incidence*. The bent ray is known as the *refracted ray*. The angle between the refracted ray and the incident ray is termed the *angle of deviation*, and the angle between the perpendicular to the surface of the medium and the refracted ray is called the *angle of refraction*. These functions are shown in Fig. 5, the line PP' representing the perpendicular to the surface, striking the

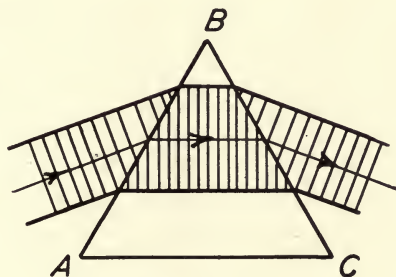

Fig. 7

surface at O , IO being the incident ray, RO the refracted ray, i the angle of incidence, and r the angle of refraction.

It has been shown how a ray of light will bend when passing through a pane of glass. It may be redirected very effectively by means of what is called a "prism," a shaft of glass whose cross-section is triangular as shown in Fig. 7. It will be noted that the lower portion of the ray travels through a greater amount of glass than the upper portion of the ray and that the change in velocity thus created causes the ray to bend. The prism is used in many places where it is necessary to deflect light rays and direct them other than in a straight line, for example, prism binoculars.

The prism has another use, that of breaking light into its component parts. The phenomenon is due to the fact that whereas light of all wave lengths travels through air at rel-

atively the same speed, light of shorter wave length will not travel as fast through glass as will light of longer wave length. Therefore, the violet portion of a ray of white light will bend more than red light, so that a ray of white light cast against the side of a prism will be divided into its component parts which may be seen on a screen in the form of what is called the "spectrum."

Light passing through one medium continues to travel in a straight line, and it must be borne in mind that it is only when it strikes another medium having a density different from the first that refraction takes place. It was stated above that a denser medium would cause the ray to bend toward the perpendicular and that a medium of lesser density would cause the ray to bend away from the perpendicular. Therefore, note that in the case of the ray projected through the plate glass obliquely, the direction of travel through the glass itself tends toward a line parallel with the perpendicular plane and then, on reaching the other side, it flares outward and away from the perpendicular, the air being of lesser density than the glass through which the ray is passed.

CHAPTER IV

OPTICS

Optics is the science of the nature and laws of vision and light. It enters into the field of television because of the necessity for using optical systems in the studio and in the devices for reproducing television programs.

Light serves the needs of man in its own natural ways, but it remains for man to make use of scientific discoveries to enable him to direct light to serve him as he desires. Herein enters the field of optics in which man applies his knowledge of optical systems which enable him to concentrate or expand the illumination to bring about results that meet his requirements. Examples of the use of optical systems are known in everyday life and are to be found in the telescope, the motion picture projector, spectacles, field glasses, mirrors, automobile head lamps, and products of similar nature. All these things are made possible by taking advantage of the discoveries that have been made in the field of handling light rays.

So far as television is concerned, the use of optical systems is necessary in the primary stage of converting the light impulses into form for transmitting them by wire and by air. Whether or not the illumination in the television studio is visible or invisible, it must be directed to the proper position and in sufficient quantities in order that the field covered by the pick-up devices might be well defined. Reflectors as well as lens systems are required, regardless of the kind of illumination that is used.

The receiving devices also require the use of optical systems, although the form varies according to the manner in which the reproduction is effected. Earlier models of modern television reproducing units employed a means for creating an apparent comparatively large picture by a microscopic effect, a lens being placed in such a position as to enlarge to the eye what was transpiring on a small electrode in the glow lamp behind the scanning disc. Later models which employ a thin ground glass or non-inflammable ground film upon which to project the picture necessitate the use of a lens disc for en-

larging the picture from a very small spot of light to one of comparatively large dimensions. Both of these devices come under the classification of optics, and the manner in which the effects are brought about is identical with that in any common form of optical system mentioned in the foregoing paragraph.

Geometric Principles Involved. A study of optics involves geometric principles for the reason that light reacts in a very definite manner when subjected to certain treatment. When a ray of light strikes a substance at an angle, if it is not absorbed it is either reflected or bent at a definite angle, so that it is possible to make calculations to determine just what a ray of light will do when subjected to certain conditions.

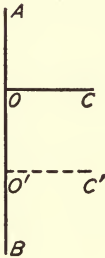

Fig. 8

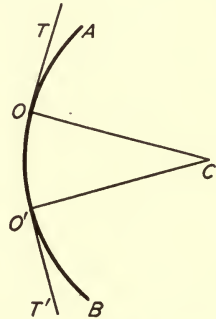

Fig. 9

The development of the phenomenon can well be taken from the elementary stages, and we shall begin with a straight line AB in Fig. 8. At point O on line AB , we have erected a perpendicular, terminating at C . Then, at point O' we shall erect another perpendicular, indicated by a dotted line, but it will be seen immediately that this perpendicular will at no time intersect line OC or OC extended. On the other hand, if the perpendicular at O' be drawn to the same length as OC , terminating at C' , line $O'C'$ will be parallel with OC and a line drawn through CC' will be parallel with line AB . Thus it is seen that there is no point without line AB from which all points of line AB are equidistant and all those points equidistant from line AB and in the same direction from AB will lie on a line parallel with line AB .

But, if line AB were bent to form an arc (a part of the circumference of a circle), then all points on that line would

be equidistant from a common point which we can designate again as C , Fig. 9. In this instance line OC is perpendicular to the line TO which is tangent to the arc at O so that it still retains a perpendicular relationship with line AB at point O only. Similarly, if we erect a perpendicular to the tangent to arc AB at any point O' , that line will pass through point C and will be perpendicular to AB at that point. It follows, therefore, that a line drawn from a point that is equidistant from all points of an arc to any point on the arc will be perpendicular

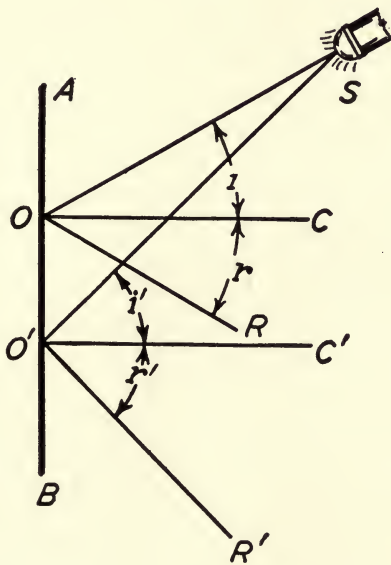

Fig. 10

to the arc at that point. However, it should be emphasized that the line will not be perpendicular to the arc at any other point.

The directing of attention to the fact that a line drawn through any point on an arc and the center of the circle of which the arc is a part is perpendicular to the arc at that point is done for the reason that herein lies the crux of the action of light rays on curved surfaces, as shall be shown.

Plane Mirrors. Progressing one step, let us use the reference points of Fig. 8 and transfer them to Fig. 10. We

shall assume also that line AB is a cross section of a reflecting (mirrored) surface. If a ray of light which originates at S is directed against the reflecting surface so that it strikes at O obliquely, the ray will be reflected from AB as indicated by OR . The angle between OC and OS is known as the angle of incidence, while the angle between OC and OR is the angle of reflection. Since the angle of incidence and the angle of reflection are equal, it is apparent that angle r must equal angle i , so that the ray is reflected in a definite direction as determined by the angle at which it strikes the reflecting surface.

Point O could be any point on the surface of the mirror. Assume that the source of light remains as shown and that the ray is directed to strike the mirror at O' . The direction of penetration is changed and, therefore, the angle of incidence differs from that shown above. Consequently, the angle of reflection will change also and will have a definite relationship between the perpendicular erected at the point where the ray strikes the reflecting surface, as indicated by $O'C'$. Here, the angle of incidence is indicated by i' , the angle of reflection is indicated by r' , and the reflected ray takes the direction $O'R'$.

Reflections of any nature follow the same fundamental principles. We see reflections in a mirror in their exact relationship, because every ray of light on reaching the mirrored surface is reflected to the eye in its own definite position with respect to other parts of the object as determined by the angle with respect to the perpendicular to the surface at which the ray of light strikes the mirror.

An object will appear to be as far behind a mirror as it is actually in front of it. The reason therefor requires an analysis. If a ball bearing B is suspended before a mirror as in Fig. 11, light rays are radiated from it in all directions equally, but we are concerned only with those which are in the direction of the mirror MM' . The rays take the form of waves and since the surface of the ball is spherical, the wave front will be spherical also. Therefore, the progression of arcs represents the wave front as it travels from the ball toward the mirror.

It will be seen readily that the ray radiated from the point nearest the mirror (ray No. 1) will reach the reflecting surface first, designated in the illustration at c . As soon as it strikes the surface of the mirror it begins its return, so that

when ray No. 2 reaches the mirror at a , ray No. 1 will have been reflected a distance equal to that which it would have attained had the mirror not been present; and since the wave front is spherical, it follows that ray No. 1 would have reached point C_1 had it not been reflected. It follows also that the point to which the reflected ray would have traveled is as indicated at c' , c' being the same distance from c as is c_1 .

In order to make the proof conclusive, select any ray, such as No. 3—the one which strikes the mirror at x . It will be seen that if there were no mirror, the ray would continue past x so that when ray No. 2 reached the mirror as indicated at a , Fig. 11, ray No. 3 would have reached the point x_1 on the

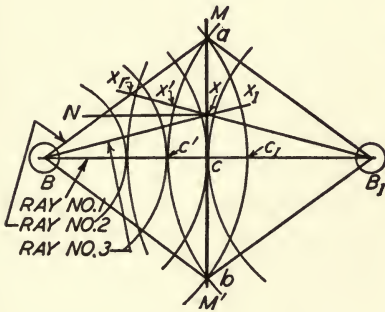

Fig. 11

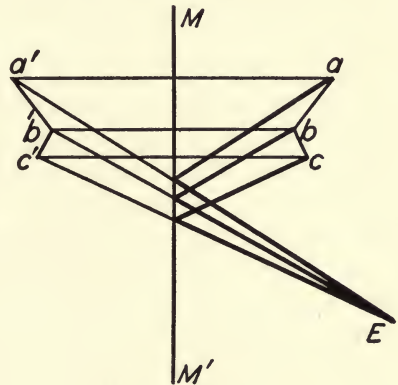

Fig. 12

arc representing the wave front. But it has been reflected, and it is necessary to determine its position. Note should be taken that ray No. 3 strikes the mirror at an angle, and that the angle of incidence is NxB , Nx being perpendicular to MM' at x . Therefore, since the angle of reflection is equal to the angle of incidence, it follows that it will take a direction as determined by an angle with Nx that is equal to angle NxB . This angle is represented by $x_r xN$. It is evident also that the ray will be reflected a distance equal to that which it would have penetrated had there been no mirror, which position is indicated at x' . We, therefore, have three points, a , x' , and c' , the first representing the presence of a ray of light immediately upon its striking the surface of a reflecting surface, the latter two points being the positions attained by reflected rays from the same source.

We know that the distance from c' to c is equal to the distance from c to c_1 . We know also that the distance from x' to x is equal to that from x to x_1 .

Therefore, since a , x_1 , and c_1 are points on an arc with B as a center, it is evident that a , x' , and c' will also be points that have a corresponding position on an arc of equal radius. Consequently, we find the center to be as indicated at B_1 , where perpendiculars to the arc at points a , x' , and c' converge so that the image will appear to lie at the point of convergence.

It follows from the above explanation that the image of the ball bearing will take the same form as that of the object itself and that it will appear to be positioned as far behind the mirror as the ball bearing B is in front of the reflecting surface.

It seems well to interject here the differentiation between two types of images, referred to as *virtual* and *real*. The image as seen in a mirror is known as a virtual image in that it appears to come from the position B_1 . On the other hand if the rays converged at B_1 because of being passed through a lens, then the image would be real for the reason that the image would be formed by the rays from the source itself.

Regardless of the shape and size of an object before a mirror, it must be considered in the light of a myriad of points, each of which is radiating rays to the reflecting surface just as the ball bearing in the foregoing explanation. Naturally, it would be utterly impossible to illustrate what takes place in such minute detail. Parts of an object or individual objects appear to be in perspective because of the relative distance which the rays radiating from the surface of the object travel in reaching the reflecting surface.

Objects appear right side up when seen in a plane mirror but they are reversed right and left. That part of the object that is actually on the right will be seen in the mirror as at the left and vice versa. An explanation of the reason therefor is given in Fig. 12.

Instead of using the usual arrow as a symbol for an object, let us take the letter L , Fig. 12. The position from which the phenomenon is observed is indicated by E and the heavy lines portray the actual direction of the rays which the eye perceives. However, following out the analysis given previously,

the letter appears to originate from a point behind the mirror. It will be noted, also, that the positions of the relative portions of the letter are reversed. Thus it is that one can write backwards and hold the inscription before a mirror where it will appear correctly.

Curved and Spherical Mirrors. The analysis of the action of a curved mirror is a little more complicated, however, although the principles that apply to a plane mirror are applicable identically. Before taking up the matter of reflection of objects in a curved mirror, let us consider the problem with a ray of light projected in a known direction toward the mirrored surface.

Fig. 13 shows the curved mirror MM' , the center of which is indicated by C . A ray of light cast by a flashlight is projected toward the mirror from S , striking the reflecting surface at O . If the mirror were plane, the angle of reflection would have been great. But it has been previously shown that the perpendicular to an arc at any given point passes through the center of the circle of which the arc is a part. Therefore, a line from O to C is perpendicular to the arc at point O , so that we have the angle of incidence in SOC . Since the angle of reflection equals the angle of incidence, it follows that the reflected ray will take a direction on the opposite side of OC from O at an angle equal to that existing between lines SO and OC . The line OR indicates the direction taken by the reflected ray and the angle of reflection is COR .

Similarly, the light from source S' is directed toward the mirror, striking it at O' . As above, the angle of reflection is determined according to the perpendicular or the line $O'C$, and the direction taken by the reflected ray is that shown by line $O'R'$, angle $CO'R'$ being equal to $S'O'C$.

Objects assume queer shapes and positions when reflected by a curved mirror. Not only are they sometimes reversed in both directions, but they appear to come from a different position, either in front of or behind the object according to the position of the object with respect to the *center of curvature*, the position from which all points in the same plane are equidistant.

There are two forms of curved mirrors—those that curve inward and those that curve outward. One that curves inward is called *concave*, the one that curves outward is *con-*

ver. For purposes of analysis, we will first consider a concave mirror, a small portion of a cylinder as shown in Figs. 13 to 17 inclusive.

The *center of curvature* of a curved mirror is the position from which all points of the mirror are equidistant and corresponds to the center of a circle or sphere. Thus, in each illustration the center of curvature is indicated at C .

The *principal axis* of a curved mirror is the line drawn through the center of curvature and the vertex of the curved surface, or, in other words, the center of the arc, as shown at Cb in Fig. 14.

The analysis of the action of a curved mirror or of a spherical mirror can be shown in a manner identical with that used in the plane mirror above. In Fig. 14 the mirror MM' has as its center of curvature point C . An object O radiates light rays in all directions, but here again we are concerned with those which radiate toward the mirror only. As the wave front reaches the reflecting surface, it is evident that because of the curvature of the mirror the rays of light away from the principal axis will strike the reflector before the one which follows the principal axis because it is a shorter distance between O and a than between O and b . The ray at c strikes the mirror simultaneous with the ray at a as shown by the arc $ab'c$. The light at a and at c , instead of proceeding further so that it would reach a'' at the same time that the ray along the principal axis reaches the surface at b , is turned back at an angle equal to Oac , the angle of incidence, so that it takes the direction indicated by line aR . Similarly, the ray at c is reflected in the direction cR' , and a further analysis would show that every point on the mirror would reflect rays that would converge at point F .

Therefore, we have established what is known as the focus of the mirror when the source is at a given distance, and so long as the object is at position O , the light rays will focus at F . At the same time, if the object were placed at F , the light rays would focus at point O . But if the position of O were moved to the right, point F would move to the left, and if the object were moved to the left, the point of focus would move to the right, always at the intersection of the reflected rays from two points on the mirror equidistant from the object, which point of intersection will fall upon the principal

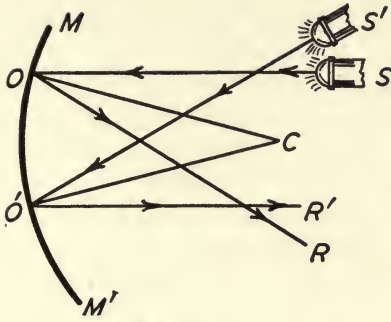

Fig. 13

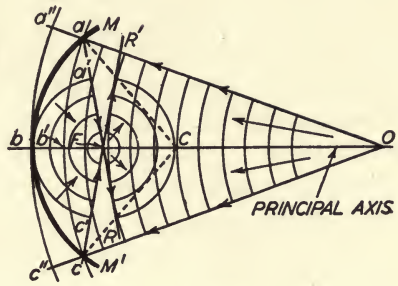

Fig. 14

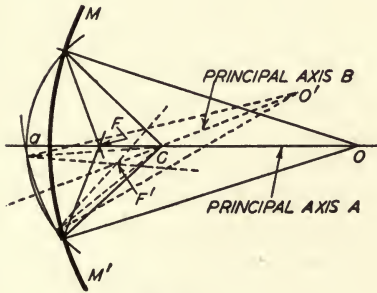

Fig. 15

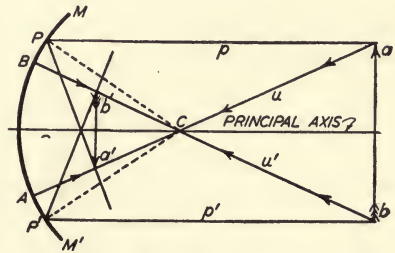

Fig. 16

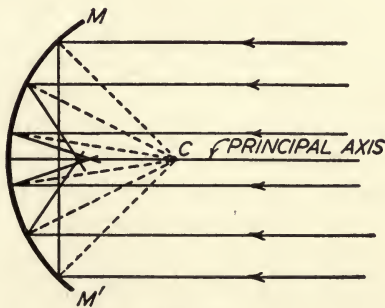

Fig. 17

axis, assuming that the object itself is on the principal axis extended.

The focus of the mirror so far as any point is concerned can be ascertained in like manner by placing the object on a principal axis, which axis will pass through the object and the center of curvature. In such case, the principal axis will intersect the mirror at the point at greatest distance from the object. As an example, see the dotted lines in Fig. 15, by which the position of focus for point O' may be determined. In this case, also, an object placed at F' would be focused on point O' .

Now, in the case of an object before a curved or spherical mirror, the reflected image acts differently than when placed before a plane mirror. In fact, the exact manner in which the reflection is observed depends upon where the object is placed and upon the nature of the mirror, whether it is a portion of a sphere or a side of a cylinder. It will be understood that in all of the discussion in the foregoing paragraphs, what takes place in one plane will occur in another, so that the principles apply to mirrors of the spherical or cylindrical types alike.

An object ab is placed as in Fig. 16, in which MM' is the reflecting surface, C is the center of curvature and the principal axis is as indicated. The object is designated by an arrow as is customary in illustrations used for optics.

Light is being radiated by all points of the object, but since we are concerned only with the position which the reflected image will take, let us consider only the extremities of the object and only those rays that radiate to the reflecting surface.

Two rays determine the position of the reflected image. Referring to Fig. 16, it will be noted that one ray, u , passes from point a of the arrow through the center of curvature C and to the reflecting surface at A . Since this ray travels over a path that is perpendicular to the reflecting surface at point A , it will be reflected back upon itself so that the change in direction is the full 360 degrees. It is, therefore, called the *undeviated ray*. Then from point a , ray p , traveling parallel with the principal axis and referred to as the *parallel ray*, strikes the mirror at P , and the angle of incidence is CPa . Since the angle of reflection equals the angle of incidence, the reflected ray takes a path that intersects the undeviated ray u at a' .

Similarly, at the end of the arrow designated as b , the ray u' , passing from b through the center of curvature and striking the reflecting surface at B , will be reflected back over its own path as indicated by the arrow points on the line. Also, ray p' from b , parallel with the principal axis, is reflected from point P' over the path shown by the line that intersects ray u' at b' .

It will be noticed that whereas a is above the principal axis, a' is below the principal axis, and that b and b' are reversed with respect to the principal axis. Hence, the image is reversed. All other points on the object will radiate the undeviated and the parallel rays in like manner, the reflected rays intersecting as those from the extremities of the arrow.

There is one point that causes a great deal of confusion, and from the above discussion it would be assumed that all the light rays radiating from points a and b would be reflected from the mirror so that they would intersect at points a' and b' , respectively. However, such is not the case, but since the greatest light collects at the intersection of the undeviated ray and the reflected parallel ray, the image is definitely formed there.

A spherical mirror has few practical and commercial uses because of its inability to concentrate light within certain prescribed limits. On the other hand, if it is desired to broaden the illumination to cast it over a wider area indiscriminately, then a spherical mirror will suffice. Prior to the electrical age when oil lamps were used, it was common practice to use a spherical mirror on one side of a wall lamp to spread the light rays over a wide area.

The inability of the spherical mirror to direct a concentrated beam of light to any given point is illustrated in Fig. 17. Note that each of the three pairs of parallel rays have a different focal point, and that there is no place at which a light source could be placed so that a parallel beam of light could be directed to a given point.

Because of the inefficiency of the spherical mirror, a reflecting surface that is more commonly used is that which has the shape of a *parabola*. The *parabolic reflector*, a modification of the spherical reflector, is one which will cast a parallel beam of light from a source of illumination placed at a focal point. Such a reflector is used in automobile headlights. The

derivation of the shape necessitates delving into mathematics which is not deemed advisable in this treatise. Fig. 17 shows the results obtained with a parabolic reflector; and since the reflected waves converge at F , it is evident that if a light source were placed at F , its rays would be reflected along the parallel lines.

There are times when it is desired that rays of light be reflected so that they will converge at a point at a distance from the reflector. An *elliptical reflector* is required in this case, and although the commercial adaptability of the elliptical mirror is limited, it is used where it is desired to concen-

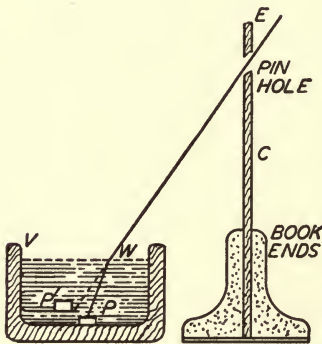

Fig. 18

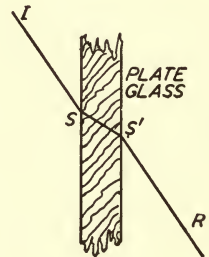

Fig. 19

trate a great amount of light in a small area, such as the film area in a motion picture projector.

The principles that apply to concave mirrors will be applicable to those which are convex, that is, curved outward. Therefore, if one has a thorough understanding of the action of concave mirrors, the results obtained from those shaped in the reverse direction can be determined readily.

Refraction. If a substance other than air does not absorb light rays and still allows them to pass through it, it causes them to bend, and the bending is called "refraction." A simple experiment to show the bending of light rays is shown in Fig. 18. Punch a pin hole in a piece of cardboard supported between book ends or something heavy enough to keep it in position. Place vessel V so that it can be looked into through the peep hole. Then place a coin at position P in the vessel

so that it cannot be seen when looking through the hole in the cardboard. Gently pour water into the vessel, exercising care that the coin is not moved by the rush of the water. As the level of the water rises in the vessel, it will be possible to see more and more of the coin, so that the result as shown in the diagram will be obtained. The coin has not moved its position, but because of the difference in the density of the medium through which the light rays travel, the ray is bent so that the coin appears to be at P' . The actual path of the ray is shown by the heavy line while the dotted line indicates the path of the ray as it appears to the observer.

Thus is shown an example of refraction, a phenomenon that makes possible the directing of light rays in such a manner as to serve the needs of man in many ways.

Light rays travel slower through glass than through air, so if a ray is directed against a piece of plate glass, as shown in Fig. 19, it will change its direction upon striking the glass, and, assuming that the two sides of the glass are parallel, will travel in the direction indicated by $S'R$, parallel with the path taken by the ray from the source. This phenomenon is true only in case the glass has parallel sides.

The amount of bend is definitely related to the nature of the material and to the angle at which the ray strikes the surface. As in the case of reflected rays, the angles are measured with respect to the perpendicular to the surface, otherwise referred to as the *normal*.

Then, too, there is a definite rule that rays passing into a medium of greater density are bent toward the normal while those rays passing into a medium of lesser intensity are bent away from the normal. Thus, in the illustration of the coin in the vessel of water, the light rays being reflected from the coin pass through the water into a medium of lesser density, air, and are bent away from the normal or perpendicular so that they become visible through the pin hole in the cardboard. Also, in the illustration of the light passing through the plate glass, note that the path of the ray through the glass itself tends toward the perpendicular to the surface of the glass and that it bends away from the normal after it leaves the glass on the other side.

Index of Refraction. The index of refraction is a constant value that designates the relationship of one medium to an-

other as a light passing medium. It is actually a ratio of the speed with which light rays pass through one medium to the speed with which they pass through air.

It has been previously shown that the angle of reflection equals the angle of incidence. That rule holds true regardless of what substance may constitute the reflecting surface. But, when we pass light rays through different media, the density of the medium determines the speed with which the rays pass through it, so that if the ray is directed to the substance obliquely, it bends in a definite manner and takes a direction that has a definite relationship to the direction from which the ray originated. However, the angle of divergence or the angle of refraction is not the same for all substances, but it remains the same for a given substance at all times.

Air is the standard against which all other substances are plotted, and is, therefore, given the value of one. Light travels through air at the approximate speed of 186,000 miles per second. Similarly, experimentation has shown that the speed of light through clear water is approximately three-fourths as fast as through air, so that we have a ratio of 4 to 3, from which we can determine the angle that a ray of light will assume when it is directed from water to air or vice versa.

The speed of light through alcohol is slightly slower than through water, so that the ratio of air to alcohol as light penetrating media is as 1 to 1.36.

Glass serves admirably as a refracting agent and lends itself readily to commercial uses. Hard (flint) glass causes the rays to bend more than soft (crown) glass, and the nature of the result desired determines the selection. Light rays travel through crown glass about two-thirds as fast as through air and through flint glass from four-sevenths to a little more than two-thirds as fast, the exact ratio being determined by the hardness of the glass.

Derivation of Index of Refraction. The index of refraction is determined by making a direct comparison of the speed of light through a certain substance with its speed through air, which is the medium through which light passes with the greatest speed, so far as is known. Thus, as shown in Table I, 1.33 times as long is required for light to pass through clear water as through air, so that the index of refraction is 1.33 or approximately four to three as shown.

TABLE I

Relationship of Various Media

Air.....	1		
Alcohol.....	1.36	Water.....	1.33
Crown Glass.....	1.51	Flint Glass.....	1.54—1.71

From Table I, it will be seen that approximate ratios are

Alcohol.....	$\frac{4}{3}$	Water.....	$\frac{4}{3}$
Crown Glass.....	$\frac{3}{2}$	Flint Glass.....	$\frac{3}{2} - \frac{7}{4}$

Calculating the Angle of Refraction. The calculation of the value of the angle of refraction involves the use of elementary trigonometric functions. In fact, the expression denoting the angle of refraction may be used to obtain the relationship existing between the refracting characteristics of any two substances. Expressed in plain terms, the *sin of the angle of*

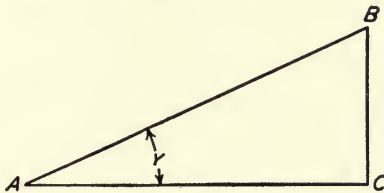

Fig. 20

incidence divided by the sin of the angle of refraction equals the index of refraction, or as expressed usually,

$$\text{Index of Refraction} = \frac{\sin a}{\sin a'}$$

in which *a* is the angle of incidence and *a'* is the angle of refraction. The difference between the angle of incidence and the angle of refraction is known as the "angle of deviation."

The relative index of refraction is a constant denoting the relationship between any two light penetrating media, such as water and glass, while the index of refraction is the relationship between air and any other light penetrating medium.

The relative index of refraction may be ascertained by using the values given for the index of refraction and making algebraic calculations therefrom.

The formula is expressed in terms of the *sin* of the angle for the reason that by that means the values can be determined with greater ease. The *sin* of an angle is the relationship that exists between the hypotenuse of a right angle triangle and the leg opposite the angle. Thus in Fig. 20 the *sin* of angle *y* is

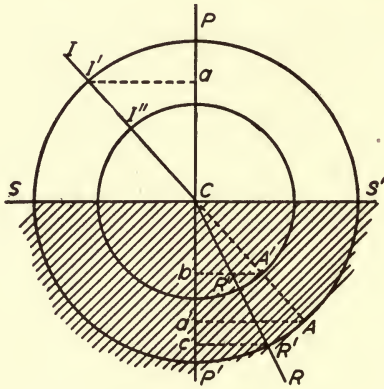

Fig. 21

the ratio between the length of line *BC* and the length of line *AB* and may be expressed as follows:

$$\sin y = \frac{BC}{AB}$$

Table II, on pages 46 to 50, giving the values of the *sin* of angles, is given for convenience in making approximate calculations of the angle of refraction and the angle of deviation. The values are those for a right angle triangle having a hypotenuse one inch long, which fact must be taken into consideration in making the calculations if direct measurements be taken as a basis for the determinations.

Another method that demonstrates the existing relationship between any two light penetrating media is shown in Fig. 21. Here we have taken glass and air as the two media through which the light rays are passed, and, as shown in Table I, crown glass has a ratio of 3 to 2. Consequently, if we construct a circle with a $1\frac{1}{2}$ inch radius and another con-

centric to it with a 1 inch radius, we can readily lay out the angle of refraction.

Assume the surface of the glass to be designated by the line SS' , drawn through the center C of the two concentric circles. The ray of light is indicated by the line IC , which intersects the outer circle at I' and the inner circle at I'' . If it is extended, it will intersect the inner circle again at A' and the outer circle at A . Line PP' is a line perpendicular to line SS' at C and is used as the reference line in determining the angle that the ray will follow.

Angle PCI is known as the angle of incidence in this example, and the *sin* of the angle is indicated by the line aI' so that $I'C$ constitutes the hypotenuse of the right angle triangle while line aI' is the leg opposite the angle. Similarly, Aa' is the *sin* of the angle ACP' and its length is equal to that of aI' .

Now, if we construct a perpendicular to the line PP' from A' where line AC intersects the inner circle, we will have found the length of the *sin* of the angle of refraction because the two circles are in the ratio of 3 to 2, which is the approximate value of the index of refraction which exists between crown glass and air. Line $A'b$ will be found to be just two-thirds the length of line Aa' .

In order for us to determine the angle of refraction, the distance $A'B$ must be transposed to the outer circle as indicated by $R'c$, which is the *sin* of the angle of refraction. A line drawn through C and through the point of intersection R' will definitely establish the path to be taken by a ray of light directed to the surface of the glass from air at point C and from the direction IC .

Similarly, if the ray of light had originated at R in the glass and had been directed to point C where it emerged into air, it would have taken the path indicated by IC and the calculations would have been identical as given above, except in the reverse order. Or, again, if the medium had been flint glass, the relationship existing between the two circles would have been 7 to 4 as indicated in Table I. For water, the ratio would have been 4 to 3, and so on.

Lenses. Any transparent substance having at least one curved surface is known as a "lens." A lens provides a means for directing light rays to given points or to given areas, making use of the natural refracting properties of the substance.

Since glass is a natural refracting agent and lends itself readily to manufacture, it is used extensively in commercial optical systems.

There are various forms of lenses, the term applied to each of them being determined by the shape of the surface. If a surface bends outward, it is called "convex;" and if it bends inward, it is called "concave." However, there are various combinations to suit different purposes, as shown in Figs. 22 and 23. The illustrations are divided thus in order to differentiate between two classifications of lenses—those which cause the rays to converge, called "converging lenses," and those which cause them to diverge, called "diverging lenses."

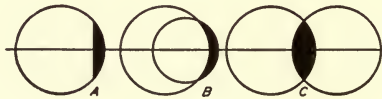

Fig. 22

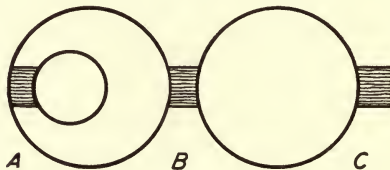

Fig. 23

A lens that is thicker in the center than on the edges will cause the rays to converge toward a common point, while one which is thinner in the center will cause them to bend outward. It will be noted that in Fig. 22 the lenses are thicker in the center than on the edge, and they are referred to as converging lenses. On the other hand those in Fig. 23 are thinner in the center, and they are called diverging lenses.

The lenses, then, are named according to the shape into which they are formed. A surface that curves outward is convex, so that since one surface of the lens at A in Fig. 22 bends outward and the other is a plane surface, the lens is plano-convex. Similarly lens B is concavo-convex since one side is convex and the other concave. Lens B is also referred to as a converging meniscus lens. Lens C is double convex or convexo-convex.

In Fig. 23, the diverging lenses *A*, *B* and *C* are diverging meniscus or convexo-concave, double concave, and plano-concave, respectively.

Principle of the Lens. The action of a lens is dependent upon the refracting powers of the substances, usually glass. To take a concrete example as the basis for describing the principle, let us consider lens *C* in Fig. 22, a double convex lens of the converging type.

Reviewing the definitions that were used in the discussion of reflections, the terms apply to lenses as they do to mirrors. The *principal axis* is the line drawn through the center of the lens, normal to the plane of the surface. It will also pass through the center of curvature. The *focus* of a lens is the point where rays of light concentrate after being passed through the lens. *Conjugate foci* are two points, one

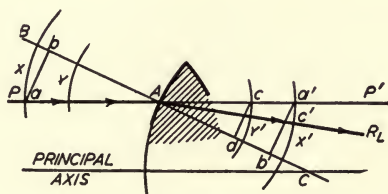

Fig. 24

on either side of the lens, at such positions that if a source of light is placed at either it will focus upon the other. The *principal focus* of the lens is the point at which the rays parallel to the principal axis on one side of the lens will converge after passing through the lens. The *focal length* of a lens is the distance from the principal focus to the center of the lens as measured on the principal axis.

In order to show the action of a lens in detail, we shall consider only one side of a double convex lens at a time, making the analysis step by step. In Fig. 24 there is shown the upper tip of the lens with a parallel ray as indicated by *PA* striking the lens at *A*. The problem is to find the direction which the ray will follow while passing through the glass. We shall disregard entirely the right-hand limit of the lens, considering that it extends to infinity.

With *A* as the center, we construct arcs of concentric

circles, which arcs are represented by $x, y, x',$ and y', x and x' having the same radius and likewise y and y' having equal radii. The radius for y and y' is two-thirds that of x and x' , since the index of refraction for crown glass is 1.52 or as the ratio 3 to 2. Refer to Fig. 21, which shows the method for determining the angle of refraction caused by glass.

Since the surface of the lens is curved, a line drawn through the center of curvature C and point A will be perpendicular to the surface of the lens at point A . Therefore, in the determinations, we shall consider line CA extended to B as the normal reference line against which all calculations shall be made. The angle of incidence, then, is that as indicated by BAP .

A perpendicular to line AB from point a will be the *sin* of angle BAP . Transferring the *sin* ab to the arc of equal

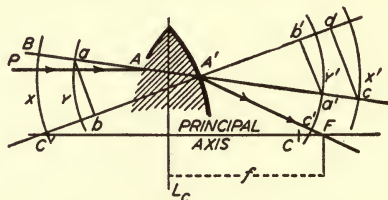

Fig. 25

radius at the right, we have $a'b'$, which is equal to ab . Again a perpendicular from point c to line AC is the *sin* of the angle $P'AC$ at radius Ac . If we transpose the distance cd to $a'b'$ and draw a line through c parallel with CA , it will intersect arc x' at c' . A line drawn through points A and c' will establish the path which the light ray traveling from P to A will follow when it passes through the glass lens. It should be noted here that because the light is directed into a medium of greater intensity, it will tend toward the perpendicular or normal indicated in the diagram as CA .

We now desire to determine the path which the ray will follow after it leaves the lens on the other side. * Using the tip of the same lens, we shall now disregard the left-hand side of the lens and consider that the ray is passing through glass from a point which we shall call infinity.

The direction taken by the ray while passing through the lens is that as indicated by BA' in Fig. 24 and as found from

the experiment in the foregoing paragraph. The center of curvature of the right-hand side of the lens is indicated at C' .

Since we desire to determine the direction taken by the ray after it emerges from the glass, the reference point will be A' and around this point as the center we construct again the arcs of circles with radii in the ratio of 3 to 2 as before. Here, however, it should be borne in mind that the ray is passing into a medium of lesser intensity so that the ratio is reversed and it is necessary that we take this point into consideration in our deductions.

We have extended the line BA' to c on the right-hand side of the lens for convenience. The *sin* of the angle at the radius y and y' is the reference *sin* in this instance for the reason that the light rays will travel at $3/2$ the speed in air that they have in the glass. Consequently, if we construct a perpendicular to line $C'd$ from point c and transpose that length upon arc y' where it intersects at c' and then draw a line through A' and c' , we will have the direction which the ray, originating at P , passing through the lens from A to A' will take when it leaves the right-hand side of the lens. This line will intersect the principal axis at point F' , which will establish the principal focus of the lens used in the illustration.

Thus is given a detailed description of the action of the ray of light as it passes from air through a lens and again into the air. The *focal length* of the lens is determined thus, and is that distance from the principal focus to the center of the lens as shown at f in Fig. 25.

Regardless of what kind of lens is under consideration, the method of calculation is the same as that shown. If the lens be of the divergent type, that is, one which causes the rays to spread or diverge, the calculations are made by comparing the *sin* of the angle of incidence with the *sin* of an angle that will give a result corresponding to the ratio of the speed with which the light rays travel through the two light penetrating media. It is not necessary that the circles be drawn as shown in the diagrams, for reference to Table II will give the angle of refraction directly, from which the angle of deviation can be determined readily.

As an example of the method for determining angle of refraction, using Tables I and II, let us say that we wish to know the path that will be taken by a ray of light that strikes

the surface of a crown glass lens at an angle of 20 degrees. Reference to Table I will show that the index of refraction for crown glass is 1.52. Substituting in the formula, we have

$$1.52 = \frac{\sin 20 \text{ degrees}}{\sin x \text{ degrees}}$$

Referring to Table II, we find the value of the *sin* of the angle for 20 degrees to be .342, which value we can substitute for *sin* 20 degrees in the foregoing formula, so that we have

$$1.52 = \frac{.342}{\sin x \text{ degrees}}$$

Solving for *x*, we obtain .225 as the result. Referring to Table II, we find that .225 is the *sin* of a 13-degree angle. Thus, we have determined the angle with reference to the perpendicular to the surface which a ray of light striking the surface at a 20-degree angle will follow when passing through a crown glass lens with a surface of a given curvature.

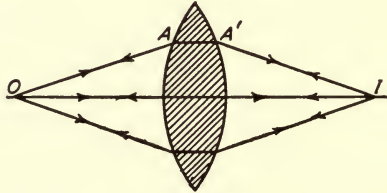

Fig. 26

Similarly, if we know the angle at which the ray emerging from a crown glass lens strikes the surface, we can calculate readily the angle that the ray will assume when it emerges into the air again on the other side.

Conjugate Foci. The conjugate foci of a lens are two points, one on either side of the lens, in such positions that if a source of light be placed at either the rays will focus at the other. The manner in which the phenomenon is brought about is shown in Fig. 26. The paths of the rays through the lens are parallel to the principal axis if the conjugate foci are equidistant from the lens. However, other points will be found to have the same relationship, but one will be close to the lens while the other will be removed at a greater distance.

It can be seen that if the object O were placed closer to the lens, the path of the ray striking the lens at A would be obliquely upward from A , so that the converging point on the right-hand side of the lens would be farther from the lens than is shown.

Image Formation with Lenses. The formation of images through optical systems can be analyzed from the foregoing descriptions of the principles involved in lens action. However, in making the analysis it must be understood that there is a combination of the effects produced by having a point source of light and a parallel bundle of rays such as that used for determining the focal length and the focus of the lens.

Fig. 27 shows the direction taken by the rays of light emanating from point O . The location of the image is determined by the intersection of the parallel and the undeviated

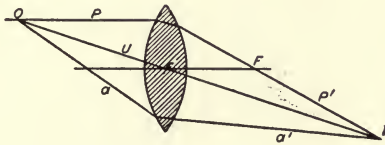

ray, indicated as P and U in the diagram. The parallel ray is designated thus because it is parallel to the principal axis. As the rays parallel with the principal axis converge at a common point known as the focus of the lens, the parallel ray passes through the lens and follows the path through F , the focus, to I where it intersects the undeviated ray U . An undeviated ray is a ray of light that changes its course so slightly while passing through the lens as to be considered to follow the direction of its original path. As a matter of fact it changes its direction twice, once on entering the lens and again on emerging, but since it passes through the optical center C of the lens, it will be found that the path which it takes on emerging is parallel with that from which it came. This phenomenon is evident inasmuch as the tangent to the arc at the point of entry is parallel with the tangent at the point of emergence so that the lens reacts as a piece of plate glass to those rays which pass through the optical center.

Another factor that enters into the phenomenon of lenses is known as *spherical aberration*. Whereas it is desired that all the rays from point O shall converge at point I , it will be found that they will not do so if the lens is strictly spherical, as most lenses appear to be. Therefore, it is necessary that the lens be constructed so that the aberration or distortion will be minimized. A commercial method for overcoming spherical aberration is to make use of an opaque masking device that covers a part of the lens so that only a small portion of it is used.

With the arrangement of the light paths as shown in Fig. 27 in mind, we can now use the arrow OO' as in Fig. 28 to show how images are formed. The conditions as shown in Fig. 27 are repeated and extended so that there is a point on either side of the principal axis. Attention is called to the

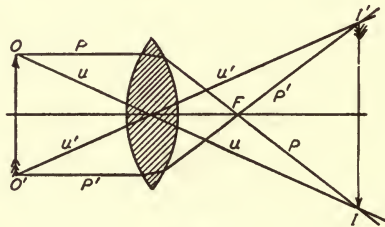

Fig. 28

fact that when the lens is of the convex type the image is inverted, and it would also be found to be reversed in the horizontal direction if the sides of the lens were spherical in shape. The reason for the reversal of position is apparent upon an examination of the illustration. If, however, the lens were of the concave type which causes the rays to diverge when they passed through the lens, the image would not be inverted.

Special Forms of Lenses. Lenses are often produced in special forms to suit a given purpose. For instance, certain television laboratories have used a cylindrical type of lens for the purpose of magnifying the received picture. The results were not highly gratifying, however, for the reason that while the lens did materially enlarge the picture by its microscopic effect, at the same time it created a channel, so to speak, and limited the field of vision to a greater degree than did lenses of the spherical type.

It frequently happens that the two sides of a lens will not be of equal curvature. When such is the case, it is probable that different focal lengths are advantageous because of the limited space that is available. The calculations for lenses with surfaces of unequal radii are identical with that when they are equal, except that the difference between the radii must be taken into account when constructing the angles and making the calculations.

Application for Television Purposes. Lenses are used in television for the purpose of, first, to concentrate the light from the light source upon a small area as determined by the limits of the apertures in the scanning disc, and then to subsequently spread the bundle of rays to cover an area of the desired size in which the motion is to take place. Thus, from the above descriptions and analysis, it will be seen that the lenses used in the optical system must be capable of converging a bundle of parallel rays to focus them upon a small area and that in this part of the optical system, lenses that are thicker in the center than on the edge must be used. Also, that in the optical system that is used to spread the rays to cover a widely distributed field, the lenses must be those which are thinner in the center than at the edges.

The use of lenses is not confined to the studio, however, for receiving devices of modern design require that the picture be received upon a small area and enlarged to a size that will be suitable for the reproduction of television pictures in the home so that the entire family may watch the program.

TABLE II
Values of Sin of Angles

De-grees	Min-utes	Sin	De-grees	Min-utes	Sin	De-grees	Min-utes	Sin
0	0	0.0000	6	0	0.1045	12	0	0.2079
	10	0.0029		10	0.1074		10	0.2108
	20	0.0058		20	0.1103		20	0.2136
	30	0.0087		30	0.1132		30	0.2164
	40	0.0116		40	0.1161		40	0.2193
	50	0.0145		50	0.1190		50	0.2221
1	0	0.0175	7	0	0.1219	13	0	0.2250
	10	0.0204		10	0.1248		10	0.2278
	20	0.0233		20	0.1276		20	0.2306
	30	0.0262		30	0.1305		30	0.2334
	40	0.0291		40	0.1334		40	0.2363
	50	0.0320		50	0.1363		50	0.2391
2	0	0.0349	8	0	0.1392	14	0	0.2419
	10	0.0378		10	0.1421		10	0.2447
	20	0.0407		20	0.1449		20	0.2476
	30	0.0436		30	0.1478		30	0.2504
	40	0.0465		40	0.1507		40	0.2532
	50	0.0494		50	0.1536		50	0.2560
3	0	0.0523	9	0	0.1564	15	0	0.2588
	10	0.0552		10	0.1593		10	0.2606
	20	0.0581		20	0.1622		20	0.2644
	30	0.0610		30	0.1650		30	0.2672
	40	0.0640		40	0.1679		40	0.2700
	50	0.0669		50	0.1708		50	0.2728
4	0	0.0698	10	0	0.1736	16	0	0.2756
	10	0.0727		10	0.1765		10	0.2784
	20	0.0756		20	0.1794		20	0.2812
	30	0.0785		30	0.1822		30	0.2840
	40	0.0814		40	0.1851		40	0.2868
	50	0.0843		50	0.1880		50	0.2896
5	0	0.0872	11	0	0.1908	17	0	0.2924
	10	0.0901		10	0.1937		10	0.2952
	20	0.0929		20	0.1965		20	0.2979
	30	0.0958		30	0.1994		30	0.3007
	40	0.0987		40	0.2022		40	0.3035
	50	0.1016		50	0.2051		50	0.3062

TABLE II (Continued)
Values of Sin of Angles

De- grees	Min- utes	Sin	De- grees	Min- utes	Sin	De- grees	Min- utes	Sin
18	0	0.3090	24	0	0.4067	30	0	0.5000
	10	0.3118		10	0.4094		10	0.5025
	20	0.3145		20	0.4120		20	0.5050
	30	0.3173		30	0.4147		30	0.5075
	40	0.3201		40	0.4173		40	0.5100
	50	0.3228		50	0.4200		50	0.5125
19	0	0.3256	25	0	0.4226	31	0	0.5150
	10	0.3283		10	0.4253		10	0.5175
	20	0.3311		20	0.4279		20	0.5200
	30	0.3338		30	0.4305		30	0.5225
	40	0.3365		40	0.4331		40	0.5250
	50	0.3393		50	0.4358		50	0.5275
20	0	0.3420	26	0	0.4384	32	0	0.5299
	10	0.3448		10	0.4401		10	0.5324
	20	0.3475		20	0.4436		20	0.5348
	30	0.3502		30	0.4462		30	0.5373
	40	0.3529		40	0.4488		40	0.5398
	50	0.3557		50	0.4504		50	0.5422
21	0	0.3584	27	0	0.4540	33	0	0.5446
	10	0.3611		10	0.4566		10	0.5471
	20	0.3638		20	0.4592		20	0.5495
	30	0.3665		30	0.4617		30	0.5519
	40	0.3692		40	0.4643		40	0.5544
	50	0.3719		50	0.4669		50	0.5568
22	0	0.3746	28	0	0.4695	34	0	0.5592
	10	0.3773		10	0.4720		10	0.5616
	20	0.3800		20	0.4746		20	0.5640
	30	0.3827		30	0.4772		30	0.5664
	40	0.3854		40	0.4797		40	0.5688
	50	0.3881		50	0.4823		50	0.5712
23	0	0.3907	29	0	0.4848	35	0	0.5736
	10	0.3934		10	0.4874		10	0.5760
	20	0.3961		20	0.4899		20	0.5783
	30	0.3987		30	0.4924		30	0.5807
	40	0.4014		40	0.4950		40	0.5831
	50	0.4041		50	0.4975		50	0.5854

TABLE II (Continued)
Values of Sin of Angles

De- grees	Min- utes	Sin	De- grees	Min- utes	Sin	De- grees	Min- utes	Sin
36	0	0.5878	42	0	0.6691	48	0	0.7431
	10	0.5901		10	0.6713		10	0.7451
	20	0.5925		20	0.6734		20	0.7470
	30	0.5948		30	0.6756		30	0.7490
	40	0.5972		40	0.6777		40	0.7509
	50	0.5995		50	0.6799		50	0.7528
37	0	0.6018	43	0	0.6820	49	0	0.7547
	10	0.6041		10	0.6841		10	0.7566
	20	0.6065		20	0.6862		20	0.7585
	30	0.6088		30	0.6884		30	0.7604
	40	0.6111		40	0.6905		40	0.7623
	50	0.6134		50	0.6926		50	0.7642
38	0	0.6157	44	0	0.6947	50	0	0.7660
	10	0.6180		10	0.6967		10	0.7679
	20	0.6202		20	0.6988		20	0.7698
	30	0.6225		30	0.7009		30	0.7706
	40	0.6248		40	0.7030		40	0.7735
	50	0.6271		50	0.7050		50	0.7753
39	0	0.6293	45	0	0.7071	51	0	0.7771
	10	0.6316		10	0.7092		10	0.7790
	20	0.6338		20	0.7112		20	0.7808
	30	0.6361		30	0.7133		30	0.7826
	40	0.6383		40	0.7153		40	0.7844
	50	0.6406		50	0.7173		50	0.7862
40	0	0.6428	46	0	0.7193	52	0	0.7880
	10	0.6450		10	0.7214		10	0.7898
	20	0.6472		20	0.7234		20	0.7916
	30	0.6494		30	0.7254		30	0.7934
	40	0.6517		40	0.7274		40	0.7951
	50	0.6539		50	0.7294		50	0.7969
41	0	0.6561	47	0	0.7314	53	0	0.7986
	10	0.6583		10	0.7333		10	0.8004
	20	0.6604		20	0.7353		20	0.8021
	30	0.6626		30	0.7373		30	0.8039
	40	0.6648		40	0.7392		40	0.8056
	50	0.6670		50	0.7412		50	0.8073

TABLE II (Continued)
Values of Sin of Angles

De- grees	Min- utes	Sin	De- grees	Min- utes	Sin	De- grees	Min- utes	Sin
54	0	0.8090	60	0	0.8660	66	0	0.9135
	10	0.8107		10	0.8675		10	0.9147
	20	0.8124		20	0.8689		20	0.9159
	30	0.8141		30	0.8704		30	0.9171
	40	0.8158		40	0.8718		40	0.9182
	50	0.8175		50	0.8732		50	0.9194
55	0	0.8192	61	0	0.8746	67	0	0.9205
	10	0.8208		10	0.8760		10	0.9216
	20	0.8225		20	0.8774		20	0.9228
	30	0.8241		30	0.8788		30	0.9239
	40	0.8258		40	0.8802		40	0.9250
	50	0.8274		50	0.8816		50	0.9261
56	0	0.8290	62	0	0.8829	68	0	0.9272
	10	0.8307		10	0.8843		10	0.9283
	20	0.8323		20	0.8857		20	0.9293
	30	0.8339		30	0.8870		30	0.9304
	40	0.8355		40	0.8884		40	0.9315
	50	0.8371		50	0.8897		50	0.9325
57	0	0.8387	63	0	0.8910	69	0	0.9336
	10	0.8403		10	0.8923		10	0.9346
	20	0.8418		20	0.8936		20	0.9356
	30	0.8434		30	0.8949		30	0.9367
	40	0.8450		40	0.8962		40	0.9377
	50	0.8465		50	0.8975		50	0.9387
58	0	0.8480	64	0	0.8988	70	0	0.9397
	10	0.8496		10	0.9001		10	0.9402
	20	0.8511		20	0.9013		20	0.9417
	30	0.8526		30	0.9026		30	0.9426
	40	0.8542		40	0.9038		40	0.9436
	50	0.8557		50	0.9051		50	0.9446
59	0	0.8572	65	0	0.9063	71	0	0.9455
	10	0.8587		10	0.9075		10	0.9465
	20	0.8601		20	0.9088		20	0.9474
	30	0.8616		30	0.9100		30	0.9483
	40	0.8631		40	0.9112		40	0.9492
	50	0.8646		50	0.9124		50	0.9502

TABLE II (Continued)
Values of Sin of Angles

De-grees	Min-utes	Sin	De-grees	Min-utes	Sin	De-grees	Min-utes	Sin
72	0	0.9511	78	0	0.9781	84	0	0.9945
	10	0.9520		10	0.9787		10	0.9948
	20	0.9528		20	0.9793		20	0.9951
	30	0.9537		30	0.9799		30	0.9954
	40	0.9546		40	0.9805		40	0.9957
	50	0.9555		50	0.9811		50	0.9959
73	0	0.9563	79	0	0.9816	85	0	0.9962
	10	0.9572		10	0.9822		10	0.9964
	20	0.9581		20	0.9827		20	0.9967
	30	0.9588		30	0.9833		30	0.9969
	40	0.9596		40	0.9838		40	0.9971
	50	0.9605		50	0.9843		50	0.9974
74	0	0.9613	80	0	0.9848	86	0	0.9976
	10	0.9621		10	0.9853		10	0.9978
	20	0.9628		20	0.9858		20	0.9980
	30	0.9636		30	0.9863		30	0.9981
	40	0.9644		40	0.9868		40	0.9983
	50	0.9652		50	0.9872		50	0.9985
75	0	0.9659	81	0	0.9877	87	0	0.9986
	10	0.9667		10	0.9881		10	0.9988
	20	0.9674		20	0.9886		20	0.9989
	30	0.9681		30	0.9890		30	0.9990
	40	0.9689		40	0.9894		40	0.9992
	50	0.9696		50	0.9899		50	0.9993
76	0	0.9703	82	0	0.9903	88	0	0.9994
	10	0.9710		10	0.9907		10	0.9995
	20	0.9717		20	0.9911		20	0.9996
	30	0.9724		30	0.9914		30	0.9997
	40	0.9730		40	0.9918		40	0.9997
	50	0.9737		50	0.9922		50	0.9998
77	0	0.9744	83	0	0.9925	89	0	0.9998
	10	0.9750		10	0.9929		10	0.9999
	20	0.9757		20	0.9932		20	0.9999
	30	0.9763		30	0.9936		30	1.0000
	40	0.9769		40	0.9939		40	1.0000
	50	0.9775		50	0.9942		50	1.0000
						90	0	1.0000

CHAPTER V

PHOTOELECTRICITY

Photoelectricity deals with the phenomenon in which certain metals give off electric charges called electrons when exposed to light, thereby providing a means for changing light rays and reflections into electrical impulses to establish an electric current. The establishment of the electric current through the action of light upon the electron emitting substance is called the "photoelectric effect."

In order that there may be no confusion, it seems well at this time to call attention to another means for converting light into electrical energy, but which does not come under the category of photoelectricity.

The selenium cell, the forerunner of the modern photoelectric cell, was used in practically all of the early experiments in television and visual telegraphy. It is often erroneously considered to be a photoelectric device. Selenium acts identically with respect to light as the carbon granules in a telephone transmitter or carbon button microphone do to sound waves. A review of the carbon button action shows that the resistance introduced into the circuit of which the button is a part varies according to the degree to which granules are compressed. Similarly selenium offers a higher or lower resistance to the flow of electric current in accordance with the intensity of the light to which it is exposed. Therefore, selenium, instead of being photoelectric in its properties, is photoconductive. A photoelectric device is one which has the property of causing the flow of an electric current when exposed to light and connected into an electric circuit properly.

Photoconductive cells have been replaced entirely by those of the photoelectric type because of the marked difference in the efficiency of the modern cells over those of the last century.

Photoelectric Metals. Although it is presumed that practically every substance has the property of emitting electrons when exposed to light, yet, out of all substances, only seven metals react to light vibrations included in the limits of human vision, deep red to violet light, in sufficient quantity to

be practical. Barium, caesium, lithium, potassium, rubidium, sodium, and strontium are known to have the necessary qualifications.

Extreme care must be exercised in the handling of all the photoelectric metals since they are highly reactive chemically and oxidize rapidly when exposed to the air. It is, therefore, necessary to store them in sealed vessels and they cannot be exposed to the air even during preparation.

Data pertaining to the photoelectric qualities and characteristics of barium, lithium, and strontium is limited, due to difficulties that are encountered, such as the inability to distill them in glass vessels. Consequently, caesium, potassium, rubidium, and sodium have been used much more extensively in photoelectric devices.

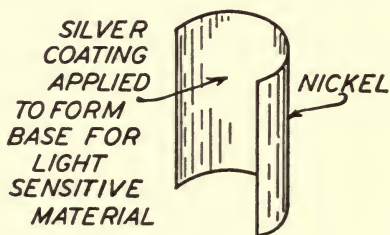

Fig. 29

Photoelectric Cell. The photoelectric cell consists of two electrodes enclosed within a glass envelope from which the air has been exhausted. One of the electrodes, the *cathode*, is a light sensitive material which emits electrons when exposed to light rays. The other electrode, the *anode*, acts as the collecting electrode, attracting the negative charges emitted by the cathode to establish the electric current.

The cathode of a photoelectric cell is much larger in area than the anode in order that the number of electrons might be as great as possible. Further, the anode is made of open construction so as not to prevent light from reaching the cathode, and is usually made of wire and in the form of a ring.

The form of the cathode differs with different types of cells, and the most common construction is that in which the light sensitive material is deposited over approximately half

of the inside of the glass envelope. When so constructed, a layer of silver is placed next to the glass in order that the metal used for the cathode may adhere more readily and to insure contact between the particles of metal as well as with the connection to the outside of the cell.

Another form of construction is that in which the cathode is in the form of a nickel plate, as shown in Fig. 29. A layer of silver is placed upon the nickel after it has been formed and prior to assembly. When the air has been exhausted by means of pumps of extremely high efficiency, the light sensitive material is driven to the cathode by means of heat, applied externally by high frequency generators.

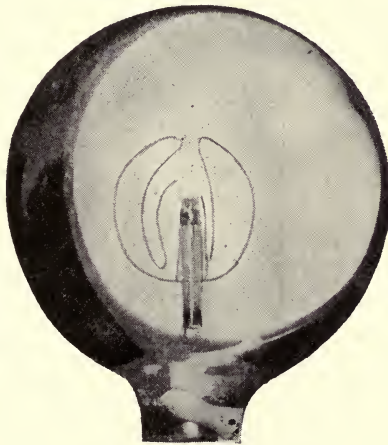

Fig. 30

Forms of Photoelectric Cells for Television. The form of the photoelectric cell used for picking up the impulses in the television studio is largely at the discretion of the engineers engaged in conducting the experimental activities. Prior to 1930, practically every laboratory utilized a globular shaped cell such as shown in Fig. 30 in which the cathode or light sensitive metal was flashed upon the rear wall. Variations of the larger type cells included those of similar construction but of much smaller dimensions, usually entirely obscured except for a small window or aperture on one side. One of the more common forms, however, was that in which the cathode

covered approximately half of the inner surface of the glass envelope.

Recently, however, there has been a divergence from the former type so that in some laboratories it has become common practice to use the form of cell shown in Fig. 31. The use of this latter type of unit because of its size permits its installation in a reflector so that the light rays are reflected back into the cell, it being mounted so that the rear of the light sensitive plate or cathode is toward the subject being televised.

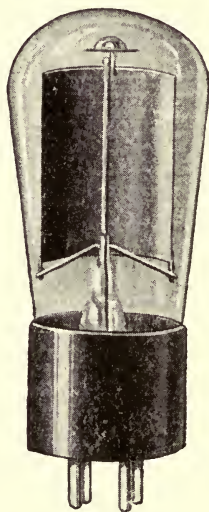

Fig. 31

The selection of the type of cell is strictly a matter for decision on the part of the engineers in the laboratory, principally on the strength of the design of the mechanical apparatus and the amplifying equipment used in conjunction with the cells.

Manufacture of Photoelectric Cells. It must be understood that the manufacture of photoelectric cells requires greater care than in the case of vacuum cells used in radio devices. Whereas the exhausting and sealing-off machines in the ordinary vacuum tube plant are designed for quantity production, the necessity for drawing a higher vacuum in the photoelectric cells prohibits the use of such facilities.

Whether the cell be of the type in which the cathode is deposited on the rear wall of the envelope or on the inner surface of a nickel plate, the cell must be exhausted of air prior to the depositing of the light sensitive material. The use of rubber connections in the pump line is prohibited in view of the necessity for the high vacuum so that each cell is connected individually through a continuous glass tubing system to the pump. It is necessary also to make certain that all the stop cocks in the line are thoroughly cleaned and that they be kept so in order that no impurities may get into the cell and thereby prevent it working with high efficiency.

The exhausting process requires several hours during which time the tubes are kept heated by means of a covering to which heat is applied. The vacuum is drawn to a fraction of a micron before the pumps are shut off and the cell is sealed off if it is to be one of the vacuum type or gas is introduced if the cell is to be one of the gas filled variety.

The gas, which must be inert so that it will not react chemically with either the base metals within the cell or the light sensitive material, is introduced into the cell at low pressure, the exact value of which varies according to the use to which the cell is to be placed. The pressure at which the gas is introduced is inversely proportional to the size of the cell. Smaller cells, therefore, require a higher pressure than those of larger sizes. To cite a concrete example, gas would be introduced into a spherical cell, six inches in diameter, at approximately 0.01 millimeters pressure.

Action of Photoelectric Cell. The manner in which a photoelectric cell converts light into electrical energy is best described by pointing out the action of the thermionic type of vacuum tube. The light sensitive metals, like all other substances, consist of molecules which are in turn composed of a nucleus upon which there is a positive electrical charge surrounded by a group of electrons which are particles of negatively charged electricity. Under normal conditions the molecules vibrate at their predetermined frequency but when the substance comes into contact with rays of light, the molecules vibrate faster and the electrons become disturbed so that eventually with a sufficient amount of light the negative charges lose their hold upon the parent positive charge, break the surface tension of the metal and fly off into space.

As the photoelectric cell is connected into a circuit, the cathode, the electron emitting substance, is negative with respect to the anode, so that when the negative charges are liberated in the space within the cell, they are attracted to the positively charged anode and thereby establish an electronic stream, creating an electric current.

The number of electrons liberated by the metal is dependent upon the intensity of the illumination, so that as the intensity becomes greater there is a greater electronic flow and, therefore, a greater current.

Response to Colors. Photoelectric cells do not function with the same degree of efficiency over an unlimited span of light frequencies. The span is dependent upon the sub-

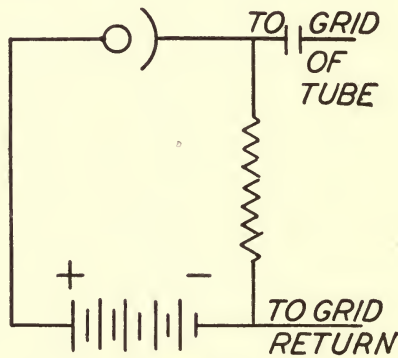

Fig. 32

stance that is used as the photoelectric material. Potassium cells have the property of being sensitive to a rather definite limit in the infra-red spectrum, that portion of the spectrum that consists of frequency vibrations below the limit of human vision. However, potassium cells and those cells known as potassium hydride cells, using potassium sensitized with hydrogen, do not have the property of responding to high frequencies or some of the brighter colors approaching the ultra-violet spectrum. Cells that use caesium as the photoelectric substance have shown a much wider response in that they have never been measurable beyond a certain point in the infra-red spectrum for the reason that measuring apparatus was not designed to measure further, and they will at the same time respond to the violet rays with ease. These

properties make the caesium cell readily adaptable to television.

The earlier type of caesium cells were of a construction similar to the potassium hydride cells so far as the position of the light sensitive coating was concerned. The caesium was exploded upon the glass after the air in the tube had been exhausted. Later tubes, however, utilize a different form of construction in which there is a metallic plate bent in an arc and placed behind the anode. A layer of silver oxide is placed

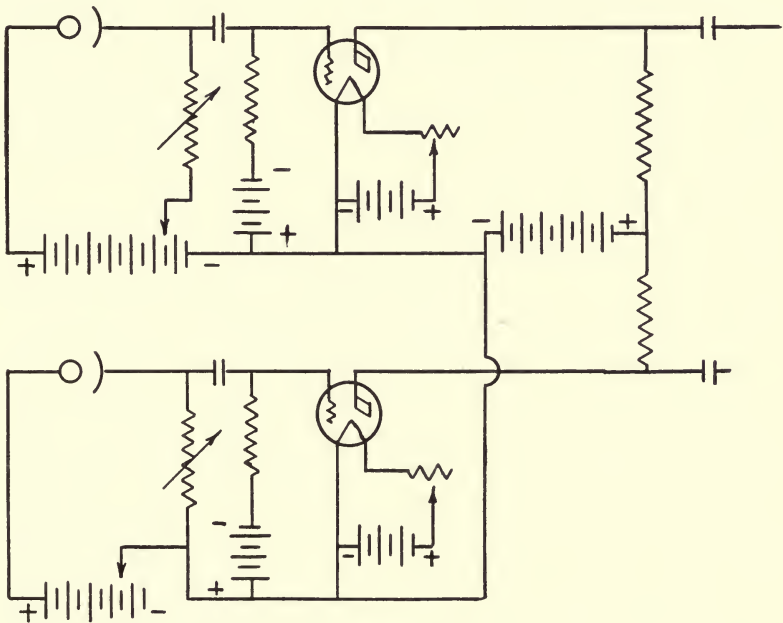

Fig. 33

on the concave surface of the metal plate and a layer of caesium is applied on top of the silver oxide after the cell has been exhausted.

Circuits for Photoelectric Cell. Fig. 32 shows a typical circuit for a photoelectric cell. The positive side of the power supply device, which can be either a battery or a rectifier with filter unit, is connected to the anode and the negative side of the battery connects to the cathode through a protecting resistor. The protecting resistor also serves in a capacity identical with the plate resistor in a resistance coupled amplifier.

Two photoelectric cells can be connected in a parallel circuit as shown in Fig. 33. Each of the cells is provided with a single stage of amplification that may be adjusted to the characteristics of the tube so that the input to a common amplifier may be matched properly, to guard against erratic operation caused by variation in the efficiency of the cells.

The voltage that is applied to the cathode of the caesium cells may vary from $22\frac{1}{2}$ to 180 volts, but in view of the fact that the application of the lower voltage will cause the tube to deliver a very nearly constant signal on frequencies up to about 100,000 cycles, the feasibility for using the lower potentials is evident. The matter of frequencies mentioned here does not pertain to the frequency of vibrations caused by the light reflections, but rather to the frequency of change from one color or shade to another, which is the frequency that must be considered in the study of television.

Vacuum Cells vs. Gas-Filled Cells. Gas-filled cells are used almost exclusively in preference to the vacuum cells that were formerly employed. However, there are certain uses that call for vacuum cells, but for the purposes of television, in which there is a need for amplification within the cells themselves, those of the gas-filled type are more desirable.

In the case of the vacuum cells, the electrons that are given off by the cathode fly off into the space within the cell and a certain portion of them reach the anode on which a positive charge is impressed, so that the negative charges are normally attracted. However, due to the fact that the electrons fly at different directions, many fail to come within the range of the attractive power and return to the cathode. Consequently, there is little or no amplification within the cell.

On the other hand, the inert gas, usually argon (argon being the most popular), or neon combined with helium, fills the cell with gas particles with which the electrons collide. The electrons on leaving the cathode are traveling at a high speed so that when they collide with the gas molecules, the particles of gas are broken and the ions are charged negatively from the electrons so that there is actually an amplification of the electronic stream which is being drawn toward the anode. The effect produced is referred to as ionization by collision and cannot occur unless the electron is moving rapidly. The exact speed required to ionize the gas differs with

gases and the energy required to effect the ionization is called the "ionization potential." In the case of argon the potential usually lies between 10 and 25 volts.

Not all of the electrons leaving the light sensitive material cause ionization for the reason that they strike the molecules of gas a glancing blow so that much of the energy is lost, so much so that it is not equal to the ionization potential and therefore ineffective since the kinetic energy of the electron must be greater than the ionization potential.

An electron with an initial energy many times that of the ionization potential of the gas may collide with several molecules of gas enroute to the anode and ionize each of them. With each collision, however, it loses energy equal to the ionization potential.

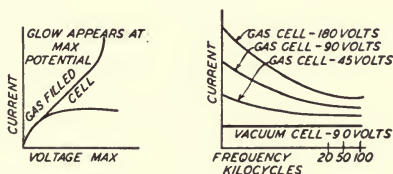

Plate I

Qualitative results obtained from photoelectric cells under varying conditions as shown. The wide variations prevent giving indications as to values. Individual manufacturers of photoelectric devices provide definite information on specific products upon request.

Whenever ionization occurs within a gas-filled photoelectric cell, there are two electrons in place of the one which started from the light sensitive material. Therefore, if the electron possessed energy many times the ionization potential of the gas molecules and collided with a half dozen or more molecules in its passage to the anode, there would be as many electrons attracted to the anode as there had been collisions in addition to the original negative charge, except that in some instances, the original electron would become lost or combine with a positive charge to form a neutral molecule.

Efficiency of Photoelectric Cells. The efficiency of a photoelectric cell is dependent upon the frequency with which it can respond to variations in light intensity and the relationship between variations in the light intensity and current. In other words, if the cell be of the type that will respond to

rapid changes but will not register slow changes effectively, or if the electronic emission is not proportional to the intensity of the light cast upon the cathode, it will not be highly efficient for television purposes.

A photoelectric cell is rated in terms of microamperes of current per *foot candle*, a light measure which is defined as the intensity of illumination of a surface when placed normal to the rays from a standard candle at a horizontal distance of one foot from the candle.* Plate I shows the qualitative characteristics of photoelectric cells as plotted in microamperes of current per foot candle and the relationship between frequency of response and current.**

*Sound, Light, Electricity, and Magnetism, Wm. Ballantyne Anderson Second Edition, Page 430 (McGraw-Hill Book Company, publishers.)

**The foregoing paragraphs give only a scant resumé of the subject. The engineer who is desirous of securing full and complete engineering data on the properties and applications of photoelectric cells is referred to "Photoelectric Cells" by Norman Robert Campbell and Dorothy Richie, second edition, 1930, Sir Isaac Pitman and Sons, Ltd., London, New York, Toronto, Bath, and Melbourne.

CHAPTER VI

REPRODUCING DEVICES

Glow Lamps. It is evident that since light rays are changed to electrical impulses for transmission from one point to another, those electrical impulses must be reconverted into illumination in order for the eye to perceive them. The glow lamp is a device that acts as a means to convert varying electrical currents to light rays. It holds a relationship with the television receiver identical with that of the loud speaker or headphones for a receiving set designed for voice or telegraph, the difference lying in the inability of the glow lamp to reconstruct the picture as transmitted without the use of auxiliary apparatus. Whereas waves are set into motion to create sound in accordance with the varying impulses, by the diaphragm of the headphones, which sounds can be understood if the ear is close enough for the waves to register upon the aural organs, the glow lamp responds to instantaneous impulses which have no connection with one another so far as the eye is concerned.

The discussion of illumination sources for the reproduction of television pictures entails the introduction of terms that are used with reference to light intensities and measures. *Candle power*, the *Lumen*, and the *Lambert* are used most often. Of the three terms, candle power is, no doubt, the most familiar and refers to the intensity of illumination in comparison with a standard light source in the Bureau of Standards. The obtaining of a standard by which to measure illumination has been more or less difficult, and today a complicated lamp, called the *Pentane standard lamp*, having a variation of about one-tenth of one per cent, has a rating of 10 candle power, so that other sources of illumination are rated with reference to it. The Pentane lamp is not rated at 10 candle power as based upon the illumination from an ordinary candle. In fact, if a candle were found to have one-twelfth of the intensity of illumination of the Pentane lamp, it would be rated at $\frac{1}{12}$ of 10 or .83 candle power.

A standard candle $\frac{1}{10}$ of the illuminating power of the

Pentane lamp delivers 4π Lumens of light flux from a source that radiates uniformly in all directions. Therefore, the Pentane lamp, having an intensity of 10 candle power will deliver 10 times 4π Lumens or 40π Lumens. A light source that delivers illumination from a flat surface which has an intensity of one candle power will radiate approximately π lumens of light flux, since it radiates in one direction, not uniformly in all directions.

Surface brightness is measured by the *Lambert* and one Lambert is the surface brightness that will provide one Lu-

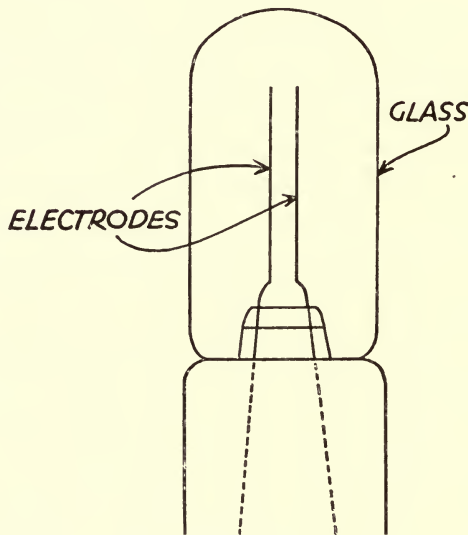

Fig. 34

men per square centimeter, or a luminous intensity of .32 candle power per square centimeter of projected area.

Before going into the application of the above definitions to the television reproducing devices, it is well to discuss the phenomena involved in translating electrical impulses into such form that they will be recognized by the human eye.

Simple Cell. If two pieces of metal are enclosed within a glass case from which the air has been exhausted and into which a quantity of inert gas has been introduced, the application of a sufficiently high potential to the electrodes (metal

elements) through external connections will create a glow within the tube, the color of the glow depending upon the kind of gas used and the intensity depending upon the potential applied to the terminals and the current passing through the cell. The manner in which the glow appears depends upon whether alternating current or direct current is applied to the electrodes. If the supply is alternating, a glow will surround both electrodes; while if it be direct, the glow will surround only that electrode connected to the negative side of the circuit. The arrangement of the electrodes in a simple cell is shown in Fig. 34.

Requirements Imposed on Glow Lamps. The requirements that a glow lamp must meet in order to be valuable as a reproducing device for television are rigid. The glow must measure up to a standard that will enable it to register the differences in intensity as determined by the reflections that have been impressed upon the photoelectric cells in the studio. It must be designed so that the illumination will vary sufficiently with the intensity of the current impressed upon its electrodes to give a good current.

The glow lamp must be capable of responding to rapid changes in current value. In fact, the high frequency response is one of the most important properties of the glow lamp, and it must be capable of changing from extreme brilliance to no illumination in the order of 50,000 times per second. Naturally, the eye is not capable of registering the rapid changes in the glow lamp, and intricate apparatus in the laboratory is necessary to determine its response.

It might well be said that all the requirements center around the ability of the glow lamp to respond to high frequency changes, for the reason that in its ability to change in accordance with the current supplied to it lies its efficiency in contrasting between the light and dark shades.

Theory of Glow Lamps. The principle underlying the operation of a glow lamp has never been clearly defined except in complicated mathematical analyses which are of interest only to the scientific world. However, there is a relatively simple theory that has been accepted commonly and which is devoid of complications and readily understood.

The molecular theory and the theory of ionization are involved in the explanation. Whereas, all matter—solids,

liquids, and gases—is said to consist of small particles called molecules; the molecules in turn are considered to be made up of still smaller units which are electrically charged. The smaller divisions are of two classes, an *ion* which is a particle having a positive charge of electrical energy, and the *electron* which attaches itself to the ion because of the natural law by which unlike charges have an attraction for one another. The molecules vibrate intact unless disturbed, but when disturbed they constitute the cause of phenomena of which use is made in many instances.

In a glow lamp, if a difference of potential be applied to the electrodes, the molecules in the metal become active because of the tension that is created. The negative charges in the molecules of which the metal elements consist are repelled by the negative potential and attracted by the positive. Similarly, the positive ions are attracted toward the negative and repelled by the positive charge. Therefore, motion is established. When the difference in potential has become great enough, the negative charges gain sufficient momentum to leave the parent ion and eventually the metal itself, thrusting themselves into space where they collide with the molecules of gas inside the lamp.

The gas molecules, which are free to move at will within the confines of the glass envelope, are likewise made up of the positive ions with surrounding electrons; but when they come into contact with the negative charges emitted by the electrode of the glow lamp, the stability is overcome and ionization occurs. The ionization of the gas increases the property of the gas to act as an electrical conductor so that the negative charges gain momentum sufficient to disassociate the electrons from the ions when they collide with the gas particles. A discharge between the two charges of unlike polarity takes place, creating the glow, a spark, in effect, as though the terminals of a battery were touched together.

Close examination of a glow lamp will disclose the fact that although the glow appears at first to be directly on the surface of the electrode, it is actually a slight distance from it. It is considered that ionization takes place in the intervening space and that the place where the glow appears is the distance required for the electrons to have gained the speed required to break molecules of gas into component parts.

The fact that no glow appears between the plates of a television glow lamp further bears out the explanation in that it is believed that there is not sufficient space between the electrodes for the electrons to gain the speed of travel necessary to cause the disassociation by collision.

Other theories have been advanced, each with a larger or smaller group of adherents. Certain persons believe that the glow is the result of heat, but inasmuch as there is little or no heat generated in some types of cells, it is assumed that any heat which might be apparent is a by-product of the glow phenomenon rather than the cause of it.

There is another theory which states that the glow is created by friction between the negative charges and the gas particles and that the color of the glow is determined by the speed with which the gas ions are moving.

Neon Cell. The neon cell is used extensively in television experimental work because of its simplicity of construction and its adaptability. It usually consists of two electrodes in the form of nickel plates separated from one another by a thin insulator. The glass envelope is cylindrical instead of spherical over the entire length of the electrode.

The electrodes of the neon cell vary as to size although the popular type for television purposes contained elements that measured approximately $1\frac{1}{2}$ inches square, which gave rise to the practice of providing a one-inch square picture in television receivers.

The construction of the customary type of neon cell permitted the use of a standard tube socket inasmuch as the terminals were brought out through a standard tube base, one electrode being connected to the plate prong and the other to the negative filament prong. The fact that both electrodes were made identically enabled the reversing of the tube to use either electrode, so that when one side became darkened the tube could be used longer by reversing it in the socket after drilling the holes for the plate and grid prongs to receive the filament prongs of the standard tube base.

Sensitivity of the Neon Cell. The sensitivity of the neon cell is measured in terms of brightness of illumination to the value of the current passing through the tube. The relationship is practically linear in good tubes so that it can be rated as so many candle power or lamberts per milliampere. A good

tube of standard make should show a sensitivity of approximately 0.14 candle power per milliamperere or 0.03 lamberts per milliamperere. Since the manufacturer of the cell recommends a maximum current flow of 20 milliamperes, it will be seen readily that the cell would deliver an illumination of 2.8 candle power approximately at its maximum recommended rating.

Operating Voltage. The voltage required to cause the glow lamp to function varies with cells of different manufacture, so that there is no recourse other than to consult the char-

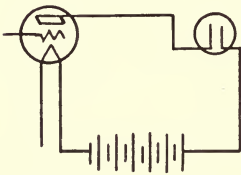

Fig. 35

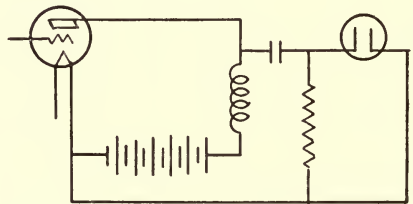

Fig. 36

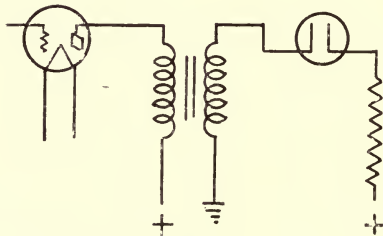

Fig. 37

acteristic chart that accompanies the cell. One cell of commercial make, the Eveready-Raytheon Kino lamp, is specified to work with 200 volts direct current as a minimum potential.

Glow Lamp Circuits. The simplest method for connecting a glow lamp into a circuit is that shown in Fig. 35. However, such a circuit is not recommended for practical purposes. Fig. 36 shows the simple circuit with impedance coupling. Fig. 37 shows an output stage with a coupling transformer. Attention is called to the fact that in the two latter circuits a resistor is connected in series with the lamp as a protecting agent. If the output stage were resistance coupled, the plate resistor might be found to serve as the current limiting unit.

Circuit Explanations. A neon cell in a television circuit works upon a direct current which is derived either from a power supply unit or from an external battery, usually the former. The receiver itself delivers an alternating-current voltage, the output from the power tube in the output stage, which varies in accordance with the received television signal. The alternating-current voltage is impressed on the neon cell and because of its variations it causes an increase or decrease in the amount of direct-current flow. An ideal condition would be one in which the variation of the alternating current would be sufficient to cause the lamp to function at all intensities of brilliance from no glow to maximum brightness.

The worth of the neon cell as a reproducer for television pictures is dependent upon its ability to respond to the variations in current and to the uniformity with which the glow appears. If the cell does not glow with uniform brightness over the entire area of the electrode at a comparatively low current value, in the order of five milliamperes, it is of little use inasmuch as it is essential that the glow be evenly distributed since any part of it may be that selected by the scanning disc at any given instant. If, then, a portion of the electrode be dark, that portion would register darker than normal on the reproduced picture, and another part would register more brilliant than required. The minimum current flow (direct current) should be determined in the design of output circuits.

Each manufacturer of neon cells recommends a maximum current to be passed through the tube. It represents the current flow that will provide maximum brightness and it will be found that higher currents will not be required. Although the use of higher currents may provide a brighter image, it will not increase the contrast between light and dark shadings. Therefore, regardless of what type of output circuit is used, a resistor should be provided for the purpose of limiting the current flow through the cell to, usually, about 20 milliamperes.

The impedance of the neon cell while of some importance is not as critical as is found in the case of reproducing devices for broadcast receivers. The impedance of cells differs with makes but, referring again to the Eveready-Raytheon Kino lamp, the curves show an alternating-current impedance of about 1,000 ohms with 20 milliamperes of direct current and 2,000 ohms with 10 milliamperes of direct current.

Distortion is caused by an increase in the direct-current flow at higher values of alternating-current voltage. The series current limiting resistor will reduce the tendency toward distortion.

Tube Failures. After a cell has been in use for a time, it will be noticed that the picture is splotched with dark spots. A cursory examination of the tube will not reveal anything as the cause and it will appear that the cell is glowing uniformly. The first tendency is, then, to clean the scanning disc, but even this precaution does not correct the deficiency. The difficulty lies with the cell and a close examination of it will disclose that one side of the inner wall of the glass envelope has become darkened. The darkening of the inner wall of the glass envelope is not a phenomenon confined to glow lamps. It occurs in other devices in which an element is heated to a high degree of temperature in a vacuum.

In a glow lamp the electrodes, which are made of nickel, emit electrons in large quantities. Each electron on leaving the parent metal may carry with it a minute portion of the metal itself and in some cases the particle of metal is carried through the gas in the cell and deposited on the glass wall. Or, again, the electron itself may become discharged enroute, but the particle of metal has sufficient velocity to carry through the space to the wall. At any rate, when a sufficiently large number of the particles of metal have been deposited, they shut off the light so that it is impossible to construct a picture.

However, some cells permit lengthening the useful life by reversing them in the socket so that the other electrode might be used, since there is little or no deposit on the side on which there has been no glow. Reversing the cell does not provide double the normal life, however, for the reason that a few of the particles have reached the unused side, regardless of the theory that they should travel in straight lines, so that in a little more than half the time required to darken the first side, the second wall will become so darkened as to render the cell useless as a television reproducing device. Its usefulness for other purposes is not impaired, however, and it can well be put to service in any circuit where it is not essential that the glow be uniformly distributed.

Other Types of Cells. The neon cell is most commonly used in television experiments. While the neon cell serves its

purpose well, it lacks the ability from the standpoint of the quantity of illumination to provide a means for enlargement of the picture. Therefore, the size is limited, and the limiting of the size of the reproduced picture limits, in turn, the size of the group observing a television program or demonstration. A means for providing a more intense source of illumination was sought and developed. In fact, there are at least two general classes of lamps that provide brilliant illumination for television reproduction purposes, exclusive of the cathode ray devices.

Generally speaking, both classes might well be referred to as *point source lamps* for the reason that the illumination is confined to a very small spot. The difference lies in the construction. One of the lamps, referred to usually as the *crater type lamp*, consists of two electrodes, one of which is cylindrical, the other cylindrical or effectively cylindrical, because of the fact that it is a wire. The outer cylinder is open at one end only and the open end is covered with a shield with a small opening that permits a very small beam of light to be projected.

The other type of lamp is known as the *hot cathode type*. The emission of electrons in the hot cathode type of lamp is brought about by the heating of the electrodes instead of depending upon the difference of potential between the electrodes to cause the electrons to be liberated.

A peculiarity of lamps of these types is that the saturation point is reached quickly. In other words, the illumination reaches a certain intensity and from that point, regardless of increasing the current and the impressed voltage, no more brilliance can be obtained.

The matter of maintaining uniformity as to characteristics in cells of the point source type is difficult. Whereas, the ideal condition would be one in which the light output would be linear to the current input, it is found that the striking voltage, the voltage at which the cell glows, will vary considerably. The pressure at which the gas is introduced into the cell is critical, particularly in those cells of the cold cathode type.

So far as the hot cathode type of cell is concerned, the high gas pressure (in the order of 2.0 millimeters or more) is used advantageously in that it permits the gas to be ionized quickly and thereby enables the electrons to gain the momentum necessary to create the glow in short order.

So far as the life of the cells is concerned, the fact that the electronic bombardment is confined within the cylinders prevents the particles of metal depositing themselves on the glass wall. Therefore, the matter of determining the life has not been determined, and one group of cells in a mid-western laboratory has been in operation almost daily over a period of approximately two years at the time of writing this treatise.

The current consumption of the cells is usually in the order of 30 milliamperes, and the voltage drop across the electrodes is usually in the order of about 20 volts.

The development of the lamps of high brilliance has made possible the projection of pictures upon a screen that will permit a sizeable group to view the television picture at one time. It has further eliminated the necessity for completely darkening the room in which the television receiver is operated,

CHAPTER VII

FACSIMILE TRANSMISSION—TELEVISION IN SLOW MOTION

The system of American Telephone and Telegraph Company for transmitting pictures electrically by wire virtually constitutes a means for studying the principles underlying the operation of television as by slow motion. The effects produced are identical fundamentally with those encountered in television, which differs from telephotography in that it deals with the instantaneous transmission of pictures or moving images.

The system as used by the American Telephone and Telegraph Company necessitates that the negative be developed and a positive print made on sensitized film before it can be transmitted. The positive film is used in the transmission to print a negative at the receiving station which can be printed in the ordinary way in a photographic studio.

The apparatus required for the transmission of pictures by wire is shown in Fig. 38 and the receiving device is shown in Fig. 39. However, in order that the nature of the device may be better understood, the equipment shown in the halftone reproductions has been put into line form with the principal parts designated as shown in Fig. 40 and Fig. 41, the transmitting and receiving apparatus, respectively.

A complete picture cannot be transmitted instantaneously. On the other hand, it is necessary to break up the picture so that at any given instant a very small portion of the picture area is being acted upon by the apparatus.

To further describe the apparatus, the transmitting device consists of a machine-driven cylinder within which there is a photoelectric cell, entirely enclosed except for a small opening toward one side of the cylinder. Outside the cylinder there is a housing which contains a source of illumination—a bright incandescent lamp. The opening from which the beam of light emerges is small and directly opposite the elements of the photoelectric cell.

As the cylinder rotates it is moved horizontally on a very

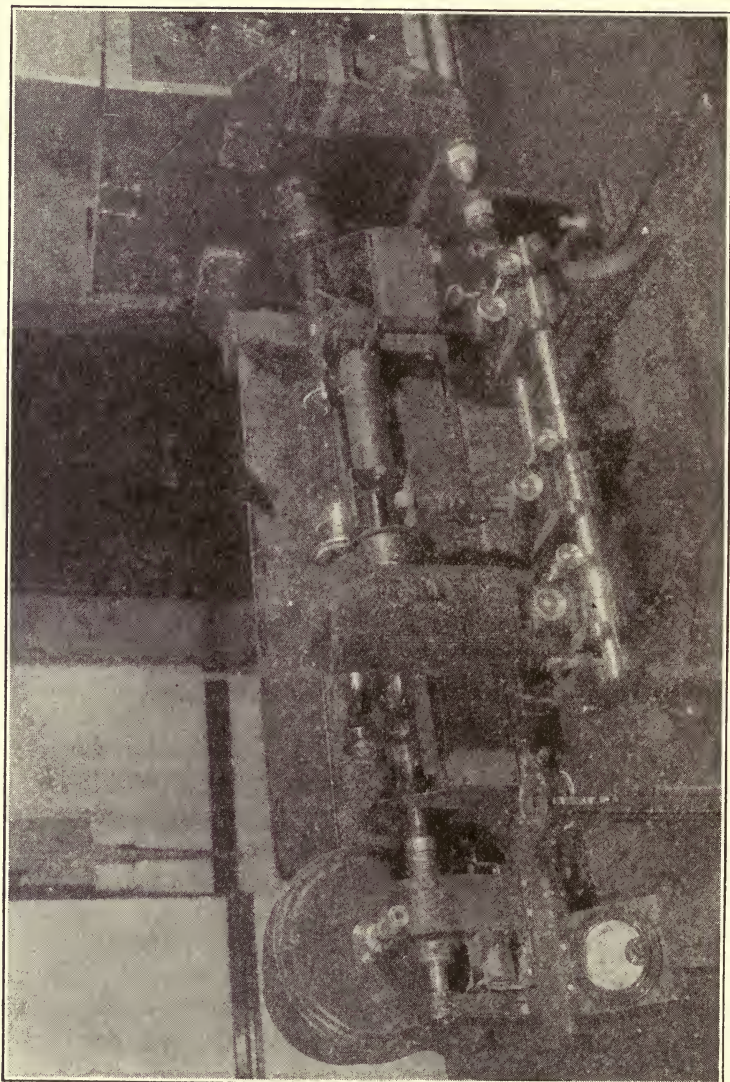

Fig. 38

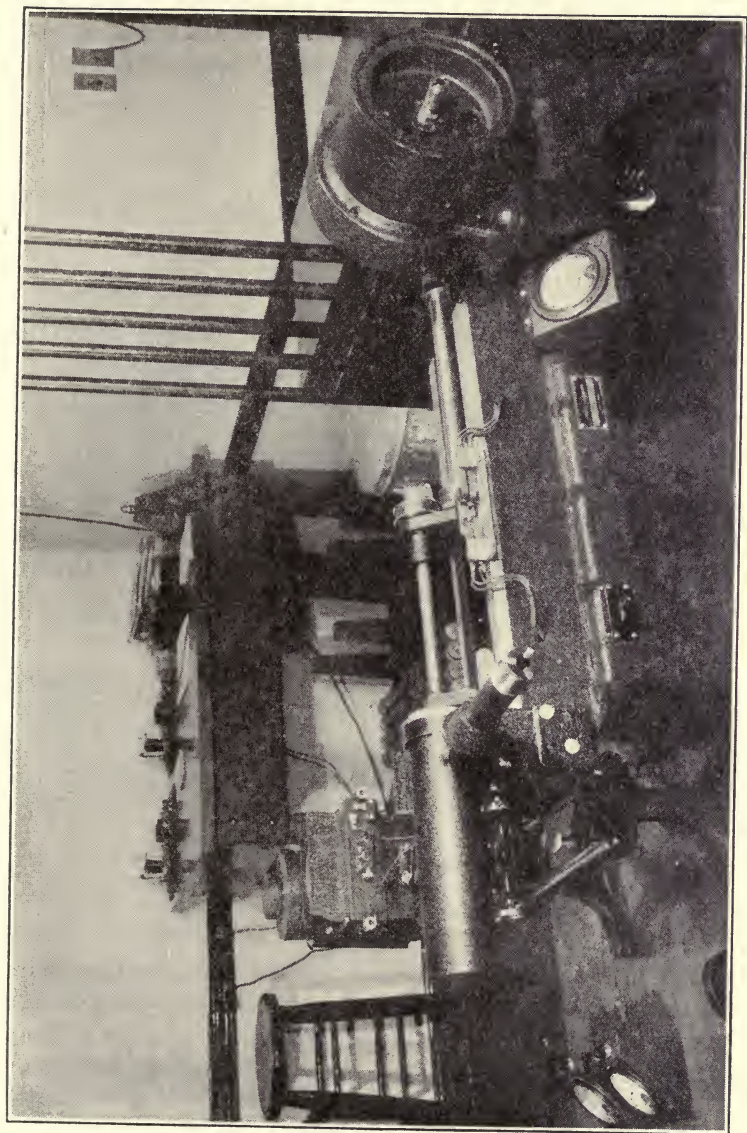

Fig. 39

carefully machined screw having one hundred threads per inch. The horizontal movement of the cylinder is a little more than seven inches, which permits the use of a five-inch by seven-inch print. Both the cylinder and the screw are rotated at a speed of 90 revolutions per minute so that about seven and one-half

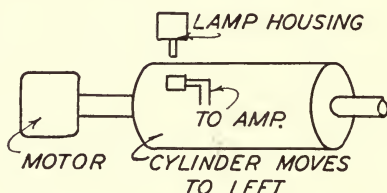

Fig. 40

minutes are required for the light beam to traverse the length of the print.

In order that there may be no confusion, let us eliminate temporarily any of the details connected with the transmission and reception of the pictures and show just what takes place. The positive print to be transmitted is placed upon the cyl-

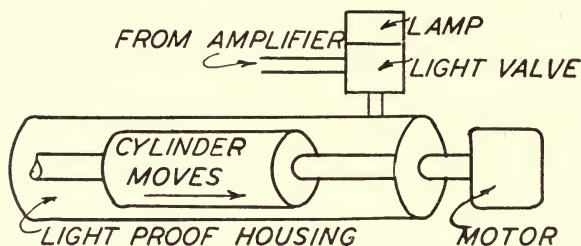

Fig. 41

inder; the power and the light of constant intensity are turned on. A beam of light shuttered down so that it is only .001 inch square is directed upon the surface of the film. As the cylinder rotates, the intensity of the light striking the photoelectric cell on the inside of the cylinder is constantly changed in accordance with the density of the emulsion on the film, so that there is set up a varying electrical current which is carried by wire to the amplifier into which the photoelectric cell is connected.

Concurrent with the impressions of the light upon the ele-

ments of the photoelectric cell, the operation at the receiving end is exactly reversed in that the variations in the current originating in the photoelectric cell are permitting a greater or lesser amount of light from an incandescent lamp to pass through a mechanical valve so that an exact reproduction of the shadings on the negative is recorded on a sensitized film.

Since the cylinder is moving horizontally at the rate of one one-hundredth of an inch for each revolution, it is evident that the received picture is actually made up of lines, each of which is one one-hundredth of an inch away from those on either side.



Fig. 42

The spiral effect, for that is what the form really is, is not noticeable at the normal focal length of the eye but can be readily ascertained by the use of a reading glass or a microscope. See the enlarged section of a photograph transmitted by wire in Fig. 42.

The imperfections in the received picture are not so pronounced but that the picture can be used for reproduction purposes without retouching. Careful examination of the picture, however, shows that although there is remarkable detail, there is evidence of a lag in the operation of the photoelectric cell as well as the valve which governs the amount of light striking

the sensitized film at the receiving end. The lag is manifested in the form of rough edges that can be detected by close examination.

The general method by which the picture is transmitted and received has been described but there are other things to be taken into consideration, such as, for example, the keeping of the machines at the transmitting and the receiving ends running in absolute synchronism. Let us assume, for example, that the cylinder at the transmitting end of the line has made one-half a revolution when the cylinder at the receiving end starts. The two cylinders are running in *isynchronism*, that is, they would be turning at the same speed, but that part of the picture that should be at the edge is in the center of the film at the receiving end. It can be seen at a glance that a picture "out of frame" would be valueless, for the center part of the original picture would lie at the clamping device that holds the sensitized film in position upon the cylinder and would not be printed.

Assume also that the cylinders start concurrently, but that the motor at the receiving end does not run at the same speed as that at the transmitting station. The received picture would contain all the elements of the transmitted picture except those that came at the clamping line, and the shadings of light and dark would not be reproduced in the proper relative positions. Since it is assumed that the receiving station motor is running slower, there would be a constantly increasing lag in the placing of the light upon the sensitized film and the light elements would not be arranged to properly form a picture.

Therefore, it is essential that some means be provided for the maintenance of synchronism. If the entire country were supplied with a single system of alternating current so that the frequency of the alternations was exactly the same at all times at each of the eight stations on the American Telephone and Telegraph wire transmission system, the matter of maintaining synchronism between stations would be very simple. A synchronous motor designed to operate at a given speed would be the sole requirement.

But, since no two of the cities having a facsimile transmitting and receiving set are on power systems that are "tied" together, it is necessary to devise some method by which the

cylinders will rotate at the same speed and maintain the same relationship with that at the transmitter at all times. The synchronizing device is a development of the Bell Laboratories and acts to make an adjustment of the cylinder with each revolution so that at the instant that the cylinder at the transmitter begins a revolution, the cylinders at each of the stations receiving the picture are set automatically to begin another revolution also. While there might be a slight lag or lead in each of the lines comprising one revolution, such a difference would not be noticeable and would be maintained throughout the entire picture.

The synchronizing impulse is transmitted over the same pair of wires that is carrying the picture but is modulated upon a carrier wave that is generated in both the transmitting and the receiving stations by a tuning fork audio oscillator.

The receiving station equipment has features that are similar to the transmitting apparatus, though the procedure is the reverse in that the varying electrical impulses set up through the photoelectric cell at the transmitter must be converted into light impulses to be projected against the sensitive coating on the film which is also placed upon a cylinder that rotates at a speed of 90 revolutions per minute and moves horizontally at the same speed as that on the transmitting device, so that the beam of light is always in the same relative position as that at the transmitting station.

The means for converting the electrical impulses into light rays consists of a light source mounted in a housing on the side of which is a device that is similar to a loud speaker unit. The opening which permits the light to pass through is very narrow and is covered by a ribbon that is thick enough to completely shut out all light when it is in its normal position. The ribbon, vibrating in accordance with the electrical impulses set up by the fluctuations of light cast upon the photoelectric cell, opens the slot more or less and allows the light to pass through accordingly. Consequently, if there is a light spot on the print on the transmitting machine, a greater electrical impulse will be carried over the wires, the slot in the light valve will open wider, and more light will be projected upon the sensitized film. The silver acted upon by the greater amount of light fails to react to the chemicals in the developing process and there is a dark spot on the reproduced picture corresponding to the light

spot on the positive print. A reversed condition holds for the dark portions of the positive print in that they permit a lesser flow of electrical energy with the result that the opening is narrowed and the portions of the reproduced film upon which less light has been projected come out as light spots. When the negative is printed in accordance with standard photographic practice, a positive print identical with that transmitted results.

It should be noted here that the nature of the print received at the receiving station as compared with that on the machine at the transmitter is a function of the design of the apparatus. It would be no more difficult to design the apparatus so that a positive print would be made when a positive was transmitted or to make a negative at the receiving end if a negative were used on the cylinder at the transmitter. This is a matter of circuit design and has to do with the design of transmitting and receiving amplifiers so far as the phase relationship of the images is concerned.

We have noted the process at the transmitting station, so let us look at the operation of the receiving station. The cylinder is placed in a dark compartment into which no light enters except that coming through the aperture of the light valve. The size of the aperture is identical with that in the lamp housing at the sending set—one one-thousandth of an inch square.

At the starting signal the cylinder at the receiver begins rotating and moving along the guide screw in exact synchronism with the movement of the apparatus at the sender. Thus, each variation in the light striking the cathode of the photoelectric cell is reproduced in light cast upon the sensitive coating of the film on the cylinder at the receiving set in the same relative position and amount.

An examination of a picture negative will show that it is covered with gradations of light and dark, according to the way in which the light reflections acted upon the sensitive emulsion at the time the picture was taken. The variations in the intensity of the emulsion permits a greater or lesser degree of light to pass through the film to the cathode of the photoelectric cell so that a constantly varying electrical current results. The same condition holds true if a positive film is made from the negative except that the light and dark spots are changed

about. Although the shadings on the reproduction at the receiving station is the opposite of that transmitted, and it is common practice to use a positive print on the film that is mounted upon the cylinder at the transmitting station, it frequently happens that a single print at the receiving end will suffice, in which case extra printing is not required. A negative is transmitted in such an event and a sensitized paper is used at the receiver.

There are at present eight stations in the United States that are equipped to transmit and receive pictures by wire. New York, Boston, Atlanta, Cleveland, St. Louis, Los Angeles, San Francisco, and Chicago are the centers to which pictures are sent by wire and from which they are distributed locally if desired.

CHAPTER VIII

TELEVISION SCANNING DEVICES

Up to the present time no means for transmitting a complete picture instantaneously and in its entirety has been discovered. Therefore, it is necessary for the picture to be dissected, so to speak, to put it into form for transmission. The process by which the complete picture or image is broken into a series of integral parts in rapid succession in the process of converting light into electrical impulses and later to convert electrical impulses into the light waves at the proper sequence to provide a reproduction of what is taking place in the studio is called "scanning."

The principle of the system used by the Bell Telephone Company to transmit photographs by wire and by radio is identical with that used in television, and it might well be referred to as television in slow motion. The method by which the point of light traveled across the negative at the rate of one one-hundredth of an inch for each revolution of the cylinder constitutes a form of scanning. The effect produced was that of projecting upon the light sensitive cathode of the photoelectric cell a certain intensity of light as determined by the outline upon the negative.

Similarly, by means of a scanning process a definite instantaneous light intensity is cast upon the photoelectric cell in the microvisor at the television studio, thereby setting up an electric current of a given value at any given time.

The human eye has the property of retaining that which is reflected to it for approximately one-sixteenth of a second, a faculty that makes television possible. If there were no lag in the action of the human visual organ, then it is quite probable that no means could ever be found by which images could be sent from one point to another either by wire or by radio so that the human being could see them as though the picture were intact. Neither would there be motion pictures. The lag in the functioning of the visual organs is called *retention of vision* and varies slightly with individuals.

Therefore, the reproduced picture on the screen of the television receiver is not an instantaneous representation of

everything that has transpired before the photoelectric cells in the studio. Instead, at any given instant, there is reproduced upon the screen the reflections that have been picked up from a very small portion of the entire televised area at that immediate instant.

There are, generally speaking, two ways in which scanning can be accomplished. One of the more common methods at the present time is known as mechanical scanning, in that there are moving parts to accomplish the result. The other one is referred to as electrical scanning, because the process of breaking up the picture is accomplished by controlling the flow of an electronic stream.

Mechanical Scanning. Any method of scanning an image for television purposes that employs moving parts is considered to be mechanical. Various means are used to attain the same end. The most common form of mechanical scanning is that in which a flat disc with perforations arranged in specific positions is rotated by means of an electric motor. Another system uses a drum in place of the disc and the holes are arranged in such a manner as to give the results obtained with the disc. Still another method is that in which a belt running in races across the aperture has perforations to provide the passage of light rays from the source to the object. In other words, a mechanical scanner is actually nothing more than a constantly moving device that serves to direct illumination upon small portions of the area in a predetermined sequence.

Attention may also be called to a combination mechanical and electrical system that has been suggested but which has not proved particularly practical. In this instance, a concave mirror is arranged so that it vibrates in accordance with definite pulsations of an alternating-electric current, thereby changing the position upon which the spot of light reflected by the mirror falls upon the object or the screen.

Another form of mechanical scanner is one which is in the form of a drum with mirrors placed along the periphery. Each of the mirrors is set at a given angle different from that of the one adjacent to it, so that the ray from a light source is reflected across the object in the same manner as though the light were projected through the holes of a disc or drum. The adjustment of the mirrors is extremely critical, and the

difficulties encountered in the fabrication of such a disc make it impractical for use outside the laboratory. The fact that the spot cannot without great expense be made so that it will be so sharply defined as when the light ray passes through an aperture, as it does in the case of the disc or the drum, is another of its disadvantages.

An adaptation of the mirror is included in a method developed by A. H. Watson, but here the mechanics of production involved present obstacles too great to be overcome readily. In the Watson disc, the mirrors were punched from a flat piece of highly polished Monel metal. The punching process included cutting the circular metal into segments so that they could be bent individually and placed into position according to a molded Bakelite form on which the disc was to be mounted. The individual sections of the disc are also made concave during the forming process so that a spot of light might be focused upon a certain point as determined by the angle at which the mirror is placed.

Disc. Let us consider, before entering into a discussion of the various forms of discs, what takes place during a rotation of the scanning device. Nearly everyone is acquainted with the action of the shutter on a camera and is familiar with the fact that its purpose is to open and close quickly to allow light to enter the darkened portion of the camera to impress light upon the sensitized film. The disc functions in very nearly the same relationship in that it provides a constantly moving shutter as far as any particular portion of the area is concerned to allow the light to be projected on a given point at a given instant.

In order that the process of scanning may be shown graphically let us consider the procedure without the photoelectric cells for the time being. Set up or assume an apparatus as shown in Fig. 43, consisting of a source of light, an incandescent lamp, a disc in which perforations have been made as shown and a screen upon which the light may shine. Fig. 44 shows the arrangement of the holes in the disc.

If we rotate the disc very slowly, the light passing through the holes in the disc and shining upon the screen will be manifested merely as dots of light. But if we rotate the disc a little faster, the dots appear to become lines of light, each of which is clearly defined from the others.

Now, if a motor be attached to the disc so that it will rotate at a comparatively high speed, the screen will appear to be fully illuminated, which demonstrates the retention of vision as it is called; and here in simple form is just what happens during the scanning operation in a television studio and in the receiving mechanism for reproducing television pictures.

The discs used for scanning must be extremely accurate within parts of thousandths of an inch if a clear image is to be transmitted and reproduced. Variations in the size or in the spacing of the holes will cause overlap so that heavy lines will appear, or if the holes are improperly spaced, there will be areas in which there will be no light and consequently no reflections to be picked up by the photoelectric cells. Similarly

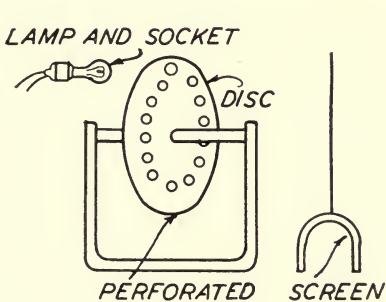

Fig. 43

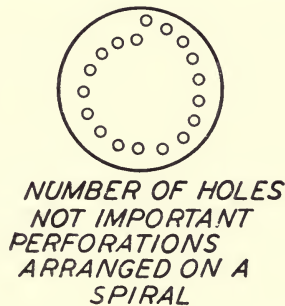

Fig. 44

other positions will receive too much light and distortion may result.

Since the retention of vision in the human eye is approximately one-sixteenth of a second, it is evident that the picture must be scanned about sixteen times each second. However, the design of a motor that will rotate at a speed that will allow sixteen pictures per second and still retain the characteristic of holding the framing is difficult to attain. However, it is relatively simple to build a motor that has the characteristics of retaining the framing and providing a scanning frequency of fifteen times per second.

A motor that rotates at 900 revolutions per minute provides fifteen complete picture scanings per second, as may be determined by dividing 900 by 60, the number of seconds in one minute.

The scanning device used at the receiver must be identical with that used at the transmitter so far as number of lines and number of frames per second are concerned. Before showing the necessity for similarity, however, let us discuss what takes place in the studio to start the electrical impulses on their way through the transmitter.

Fig. 43 shows the scanning process. The apparatus used in the studio is identical in principle with that set-up. Fig. 45 shows a pictorial arrangement of the devices used to concentrate the light and project it upon certain definite areas that are to be scanned. The light issuing from the lamp housing, which is identical with the lamp house for a moving picture projector, is backed with a reflector that directs the beam of light through the opening in the lamp house upon the

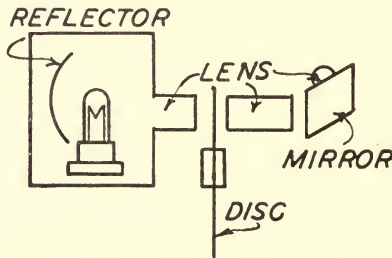

Fig. 45

surface of the scanning disc. A lens beyond the scanning disc concentrates the beam of light that passes through the scanning disc. A mirror is used to direct the field of light to the desired position in the studio. It is placed upon a universal joint that permits its movement in any direction. The televised object is placed in a position, the focal length of the projection lens, and near a group of photoelectric cells that receive the light reflections and convert the light into electrical impulses.

Assume another set-up, as shown in Fig. 46, a neon lamp connected to the output of the television receiver and in front of which is another scanning disc. The object is to reproduce what is transpiring in the studio. Assume that the transmitter is in operation and that the receiver is properly tuned to resonance with the incoming signal.

The motors that rotate the discs are started. The first hole in the scanning disc passes through the area on which the light from the lamp house is projected. That light passes through the projection lens and strikes the area at the top and on an edge (we shall say the left to be specific) of the scanning area and immediately that it passes off to the right of the area, the second hole begins its path through the beam of light and the light is projected upon another portion of the scanning area.

As the light passing from the first hole passes across the light area, it is reflected into the photoelectric cells in accord-

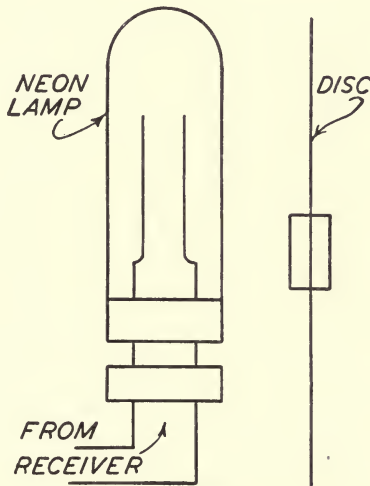

Fig. 46

ance with the shadings of light or dark and sets up a variation of impulses. Since the number of electrons that is emitted by the light sensitive coating on the cathode of the photoelectric cell is dependent upon the intensity of the light, the available electronic stream is varied with each change in the shading of the object. The action of the remaining portion of the scanning disc and the projected light is identical with that for the first two holes, and the disc rotating at a speed of 900 revolutions per second with fifteen pictures per second creates an apparent constancy of illumination.

Receiver. If the picture on the screen of the receiver is to be identical with that at the studio, the disc must be operat-

ing at the same speed and in the same relationship. Conditions must be such that the results obtained are as though the two discs were connected together on the same shaft, so that at the time the first hole in the scanning disc at the transmitter starts through the area, the first hole of the scanning disc at the receiver must be beginning its entry into the pic-

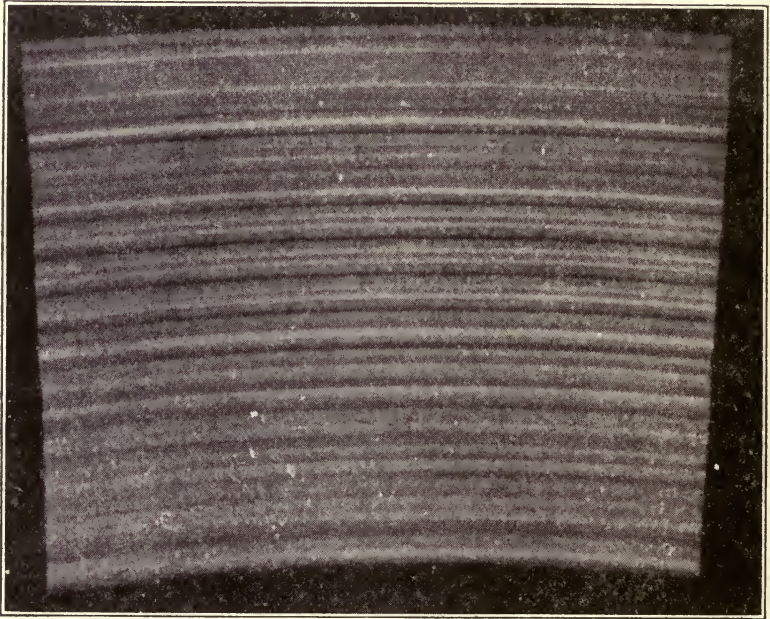

Plate II

The illuminated field at a television receiver. This illustration shows irregularities created by the incorrect spacing of the holes, indicated by the streaks of light and dark. The disc used in the photographic experiments was laid out and drilled in a home work shop. The white band bordered by a black one near the top of the illustration indicates that the hole which should have delivered light where the black line appears was too high so that the space seen as extremely light received greater illumination than was intended.

ture area. Thus, what is impressed upon the photoelectric cells will be properly positioned on the screen of the neon cell or other reproducing device. It must be understood that the illumination of the entire area of the glow lamp is of the same intensity at any given instant and that that intensity must be registered at some particular position upon the picture area as determined by the position of the disc at the transmitter.

Speed of Rotation of Scanning Disc. Since it is evident that there is greater illumination as the speed of rotation of the disc is increased, the question undoubtedly will arise as to why such speeds should not be employed. The speed of the disc and the width of the frequency band required for the transmission of television signals are definitely related, and with a reduction of the speed of rotation, the channel is narrowed proportionately.

The exact width of the band has been an open question for a number of years and no one has ever shown definitely just what width channel is required to transmit pictures by television. Opinions have been expressed, however, and frequency values have varied from 5,000 to 100,000 or more cycles, a very wide margin at the best. The higher value is calculated as the result obtained by the use of motors rotating at normal speeds of, say, 1800 revolutions per minute.

To take a concrete example, consider a 30-hole disc rotating at 900 revolutions per minute. The speed is such that there are 15 complete projections of light over the entire area per second. Consequently, since there are 30 holes in the disc and each of those holes passes over the area 15 times per second, it is evident that there will be 15 times 30 or 450 changes from dark to light and from light to dark every second. Also, it is seen that the change is complete, that is, there is a point at which maximum darkness is attained, so that each time a hole passes the screen area the impulse forms two alternations of alternating current to create one cycle.

From this point, the calculations are vague and subject to controversy on the part of television development engineers. The condition may be compared with that found in voice transmission in which the width of the band required is dependent upon the frequency of the sound impressed upon the microphone. However, there is a difference, in that the frequency of the sound impulse is known, whereas in the scanning of an object in television there is not the same degree of definiteness since the reflections of light impressed upon the cathode of the photoelectric cell are effective because of the difference in intensity and not because of the color. In other words, an object may be any color whatsoever, but the intensity of the light that is reflected to the photoelectric cell may be identical or nearly so with that reflected from an object of an entirely

different color so that the magnitude of the electric current generated will be the same in both instances and the reproduction upon the screen of the receiver will not indicate the variation in color whatsoever. It will be shown as dark or light according to the condition individually. If the frequency of the color itself were the controlling factor, the frequency would be definitely known within close limits and there is no doubt but that the channel would be very wide.

However, in view of the indefiniteness of the situation, the laboratories have adopted the policy of assuming the most adverse conditions. They assume that there will be as many variations in a horizontal plane as there are in the vertical plane. It is known in the case under consideration that there are 30 variations vertically, so they assume that there will be 30 variations horizontally, just as though there were 30 black lines drawn from top to bottom of the screen area with 29 white spaces between the black lines.

One ray of light passes across the area and, so far as the photoelectric cell is concerned, until it reaches the side of the screen the current is zero for the reason that the area is dark. It strikes the white space adjacent to the black line and immediately there is a change in the intensity of the light reflected and the current reaches the maximum, dropping again to zero when the ray strikes the next black line, rising with the white space, and so on across the entire sweep of the surface being illuminated. When the sweep is complete, it is found that 29 impulses have been set up, but it is common practice to use the figure 30 instead of 29 as an added precaution. Therefore, the former result, 450 cycles is multiplied by 30 to obtain a result of 13,500. However, the result obtained represents the number of alternations, since only the rise in the current flow has been taken into consideration. Consequently, the frequency in cycles per second is 13,500 divided by two, or 6,750.

The maximum frequency in cycles per second is never used for transmission purposes in actual television practice. Instead, there is a variation in the intensity of illumination according to the shadings of objects in the area being scanned. Therefore, there seems no way of determining the exact width of the channel required except to make use of the theoretical condition as outlined.

Reflections through Holes in Disc. The make-up of perforations in the disc for the purpose of allowing the light to pass requires attention. The matter of reflections from the sides of the walls of the holes must be taken into consideration and care must be exercised to prepare the holes so that no reflections will occur.

Such reflections can be guarded against by using a thin sheet of metal, but at the same time the thickness of the metal must be sufficient to prevent the disc bending out of shape because of its rapid rotation. If the metal is not thin enough to prevent reflections from the walls of the holes, the ends of the holes at the side of the disc are countersunk so that the cylindrical effect is reduced. The countersinking must be done carefully to make certain that the hole is neither enlarged nor marred.

Different Forms of Discs. The disc that was used to demonstrate the action of the scanning device is identical in principle with that introduced by Nipkow in 1884. Since that time a great deal of effort has been expended in an attempt to improve upon the Nipkow idea, but so far as the single spiral unit is concerned there does not appear to be any particular variation between the original and those of the present day. Other experimenters have attempted to deviate from the standard form of disc, but the only deviation appears to be what is known as the "multiple-spiral disc," one in which the holes are arranged in a multiplicity of spirals instead of in one continuous single spiral around one rotation.

The history of the multiple-spiral disc is obscure. It is known that certain experimenters have made investigations of its worth from time to time, but the records of such research has not been published authoritatively, so far as can be determined. It is known, however, that U. A. Sanabria continued in the development of the multiple-spiral disc. The use of the multiple-spiral disc tends to reduce flicker to an extent that is not possible when the single spiral disc is used, assuming the use of the same speed of rotation.

The experiments of Sanabria are now being continued by the Western Television Corporation, which stands alone in the field so far as multiple-spiral scanning is concerned.

The multiple-spiral disc can be described better if shown diagrammatically together with the results obtained by a single

**CORRECT FRAME****INCORRECT FRAME**

Fig. 47. (Above) Arrangement of holes in multiple-spiral disc.
 (Below) Illustrating the discrepancies caused by incorrect framing when three-spiral disc is used. The upper portion of the incorrectly framed picture is out of frame by approximately one-sixth revolution of the disc.

rotation of the disc. The number of holes in the disc has arbitrarily been taken at 45 with 15 placed in each of the three spirals or groups. The use of 45 holes means that there is an angle of 8 degrees between the radii upon which the holes are drilled. An attempt was made to provide an aperture or picture area one inch square, but since the holes at the lower part of the picture, that part toward the center of the disc, are not the same distance apart horizontally as those at the outer dimension, the aperture takes a form in which the top and bottom are arcs and the sides converge toward a common

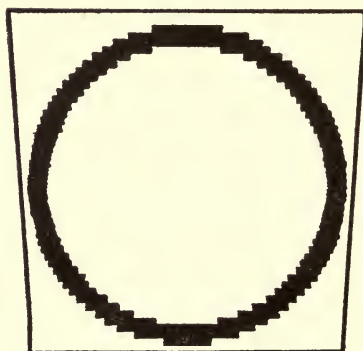
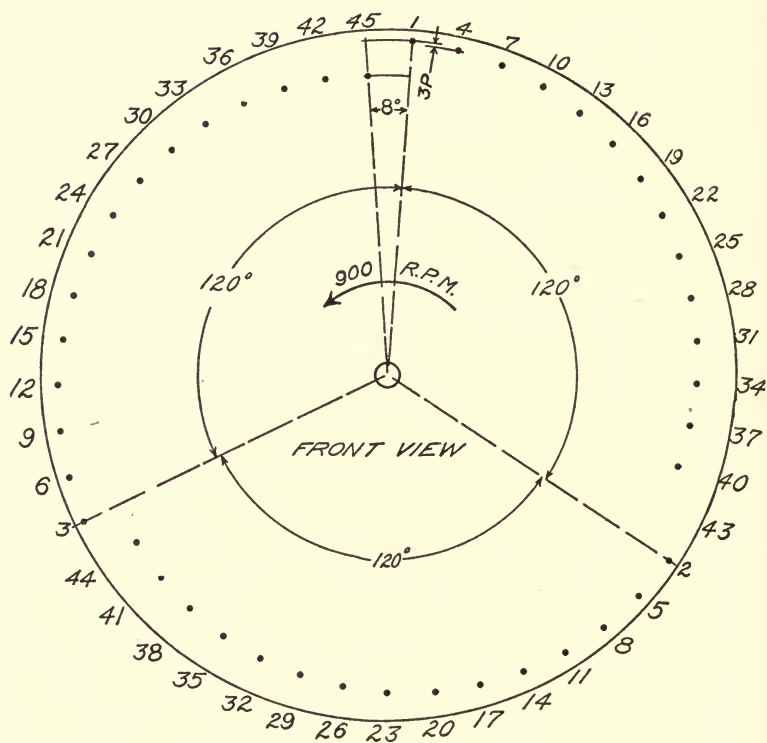
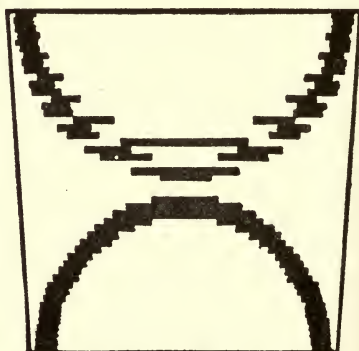
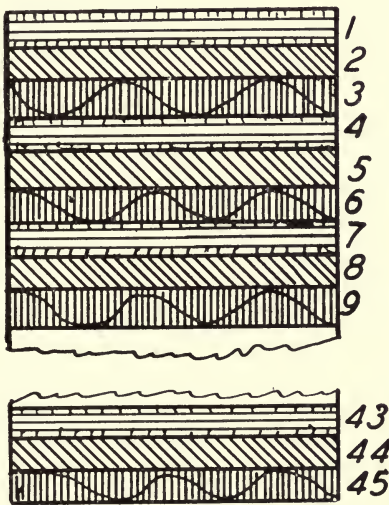

Fig. 48

point, the center of the disc. The size of the picture prevents the form of the aperture taking on serious aspects, however. Each of the groups comprising one of the spirals consumes one-third of the circumference or 120 degrees. (See Fig. 47.)

Let us follow through one revolution of the disc and ascertain just how the process shapes itself as shown in Fig. 48. Starting the disc so that perforation No. 1 flashes across the illuminated area from right to left the ray of light that is passed through hole No. 4, the hole adjacent to hole No. 1 strikes the area on the right at the instant that the ray from No. 1 leaves on the left-hand side. Similarly, the ray from hole No. 7 strikes the area just as that from No. 4 leaves the

left side, and so on through the entire one-third of the revolution until the ray from hole No. 43 is leaving on the left-hand side of the screen just as that from No. 2 strikes the right-hand side.

But there is one thing that should be pointed out here. Note that the holes in the first spiral have not completely covered the screen although the illumination through hole No. 43 is near the bottom of the area. Instead they have only permitted the illumination at certain intervals as indicated on the diagram, leaving a band twice the width of that illuminated between each of the lines. In other words, one-third of the area has been scanned; but instead of being any single portion the entire vertical dimension has been partially scanned. The area illuminated by the first spiral is indicated in the diagram by the space having horizontal lines.

The ray passing through the hole marked No. 2 strikes the area at the instant in which hole No. 43 passes off the left-hand side. The area that is illuminated through hole No. 2 does not coincide with that taken care of by hole No. 1, but is adjacent to it (immediately below, to be explicit). Throughout the entire spiral, then, the area directly below that scanned by the first spiral is illuminated through the holes of the second spiral as indicated in the diagram by the spaces having oblique lines.

As hole No. 44 passes off the left-hand side of the area, the disc has finished two-thirds of a revolution and two-thirds of the area has been scanned, not the upper two-thirds but one-third of each one-fifteenth of the entire vertical dimension.

At this same instant, then, hole No. 3 strikes the right-hand side of the area and reference to the diagram will show that the area illuminated through hole No. 3 fills the intervening space between that illuminated by holes No. 2 and No. 4 as indicated by spaces shaded with vertical lines in the diagram. Throughout the last 120 degrees of rotation in which the third spiral is illuminating its area, the last third of the area is being scanned, and when hole No. 45 passes off to the left, the first hole again takes up the cycle and the process is repeated.

An analysis of the process, then, will show that only one forty-fifth of a second elapses between the time any portion of the area and that immediately below it are illuminated, be-

cause the disc is rotating at a speed of 900 revolutions per minute, or fifteen times per second. The perforation through which the second line obtains its illumination is exactly 120 degrees beyond the perforation through which the top line is illuminated, or one-third of the revolution. Therefore, the time between the first and the second line is one-third of one-fifteenth of a second, the time required for one revolution, or one forty-fifth of a second.

Here again enters a peculiarity of the human visual organs. Whereas vision is retained for about one-sixteenth of a second, the eye does not have the faculty of carrying that vision from the top to the bottom of a space as large as the screen required for television reproduction. The eye will follow unconsciously the ray of light and will note the time at which there is a shift from the bottom of the area to the top. While the use of the multiple spiral eliminates this effect, a "crawl" is observed because of the fact that portions are reaching the end of the *retention period* while other portions are illuminated brightly.

Synchronization. The term synchronization refers to keeping the disc at the receiver in the same relationship with reference to the scanned area as is the disc at the transmitter.

Synchronous motors constitute the best means for maintaining synchronization between the discs at the transmitter and the receiver. It is necessary, however, that the two units operate upon the same power system or on systems that are controlled accurately; otherwise the two discs will not hold the same relationship. A large part of the country's power system is not only tied together but is equipped with elaborate apparatus that controls the frequency to within very close limits. Consequently, it is practicable for a large section of the country to utilize synchronous motors for operating television mechanisms.

Another method of providing synchronization in districts outside the controlled lines is known as automatic synchronization, in which the speed of the motor driving the scanning disc is controlled by an audio impulse set up by the scanning disc at the transmitter. The audio impulse which is heard, if headphones are placed in the output of a receiver tuned to a television signal, depends upon the number of holes in the disc and the speed of rotation. The frequency of the impulse is

the product of the number of pictures per second multiplied by the number of holes in the disc. In other words, the audible note created by a 48-hole disc rotating at 900 revolutions per minute would be 15×48 or 720 cycles per second. A 45-hole disc, be it single or triple spiral, rotating at 900 revolutions per minute, sets up an audible signal of 675 cycles per second.



Plate III

An unretouched television photograph of a photograph. The inaccurate disc (See Plate II) was used in the experiment, and the operators at the television studio cooperated by holding a photograph before the microvisor. Approximately 12 seconds was required for making the exposure at the receiver. Note how the incorrect positioning of the holes in the disc caused displacement of certain light and dark shadings.

A synchronous motor to operate on the audio signal will then, in turn, control the speed of the motor that is propelled by an induction type motor.

There are difficulties with automatic synchronization, however. Any radical change in the studio set up will create a variation in the audio frequency and the motor driving the disc will run wild temporarily. Such a change as a shift from one scanner to another, as from the close-up to the full length, would affect the signal sufficiently to misplace the picture. The cutting of the signal caused by the throwing of the key

switch would be enough to lose the synchronizing impulse and the motor speed would have to be adjusted. However, it would appear that automatic synchronization will be necessary for those districts supplied with power other than the well controlled 60-cycle alternating current.



Plate IV

An unretouched photograph taken by television. The inaccurate disc (See Plate II) was used and one of the operators at the television studio posed for the picture to be taken. Note: Lay the book on a table and back away from it so that the picture is seen at an angle. Notice that the lines tend to disappear.

Flicker. Flicker was an obstacle in the development of moving pictures, and those who witnessed the early showings on the cinema screen will recall the unsteady condition of the pictures and the relief to the eyes when lantern slides were used during the intermission required to change reels. It was

only logical, therefore, that the difficulties encountered in the mechanical presentation of moving pictures should be manifested when the transmission of pictures by means of television was attempted.

The method incorporating the use of the multiple-spiral disc by which the flicker in television pictures has been reduced bears resemblance to the way in which industry combated the evil—multiple projection. The single spiral disc scans the area in sequence so that the light projected through the last hole of the disc illuminates the extreme lower edge of the area. Since the perforations are arranged in one single spiral, the ray of light passing through the disc jumps suddenly from the extreme lower part of the illuminated area to the extreme top; and since the illuminations are occurring at a speed near the normal vision retention period, the eye naturally follows the movement of the ray of light to a certain extent.

Taking the three spiral 45-hole disc traveling at a speed of 900 revolutions per minute as the example, the area that is to be scanned is actually divided into fifteen sections, each of which is again divided into three parts as shown in the diagram. The areas included in each of the fifteen sections is very small as compared to the entire vertical dimension so that variations in the movement are not so noticeable.

Each of the fifteen sections is entirely illuminated once every fifteenth of a second, so that there are three rays of light passing over the section at intervals of one-forty-fifth of a second. Consequently, when the end of the rotation draws near, the jump back to the top of the scanned area is not so abrupt and there has not been the interval of a fifteenth of a second since light was projected in the immediate vicinity of the extreme top of the screen surface.

CHAPTER IX

COMBINING SCANNING WITH ASSOCIATED EQUIPMENT

We have dealt with the description of various methods used to scan the subject and to reproduce the picture, the photoelectric cells—the “electric eyes” of television—and the glow lamps. It is necessary now that combinations be made to show the relationship which one holds to the other in order to attain the desired result.

It has been shown how the scanning devices are used for the purpose of breaking the picture into a series of parts, so that there may be instantaneous reflections of illumination of varying intensity. It has further been shown that the photoelectric cells act to convert light reflections into electrical energy, utilizing a phenomenon peculiar to certain metals.

Then, the principle of the glow lamp, a device for changing the varying electrical impulses into the form of light rays to enable the eye to reconstruct the picture that is being unreeled, figuratively speaking, at the television studio.

Heretofore, the cells used to convert light into electrical energy have been referred to as photoelectric cells. In the studio, however, although there is no term that is used universally, it is not uncommon to refer to the pick-up unit, be it a single photoelectric cell or a group of cells, as a *microvisor*. If, however, several single cells were used at various positions as are the microphones in sound pick-up, then the term would be applied naturally in the plural. A group such as that shown in Fig. 49 would constitute a single unit and would be referred to collectively as a microvisor.

Microvisor. The arrangement of the cells in the microvisor is a matter that is left to the discretion of the development engineers. The most common method is that shown in Fig. 50. Another laboratory prefers to place the cells above the subject as shown in Fig. 51. Still another method is that in which the cells are mounted on tracks that will permit a limited amount of portability. The *television camera* incorporates the cell and provides a greater amount of portability than the track mounting.

The object is to provide a microvisor or pick-up device and install it in such a manner that the reflections will be effectively impressed upon the light sensitive cathode of all cells.

A large cell, such as provided in the studio set-up of the Western Television Corporation, is shown in Fig. 52. This

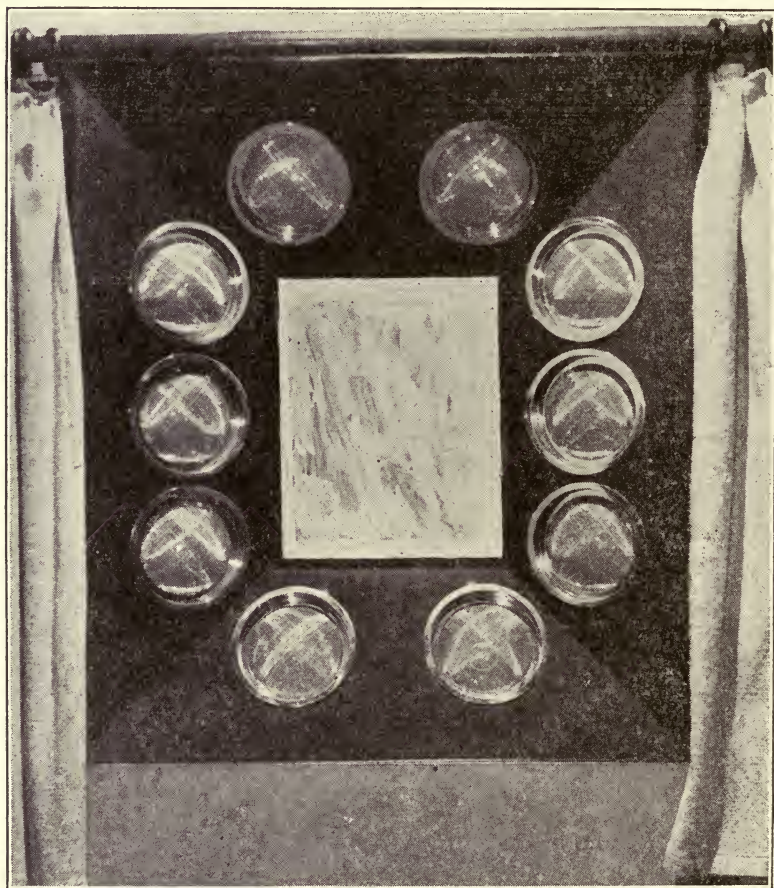

Fig. 49

cell measures sixteen inches in diameter and at the time of its installation in the studio at W9XAP in Chicago, it was the largest cell that had ever been constructed.

Another unit, Fig. 53, developed by the Jenkins Television Corporation, is called the television camera. The

mechanism, including the photoelectric cell, the scanning disc, an amplifier, and a monitoring unit, are all placed upon a tripod, such as used in photographic studios to permit moving the device to follow the television presentation in its movement about the stage. The use of the camera necessitates a



Fig. 50

studio set-up which is quite different from that of the other methods of set-up.

Combining Scanning Devices with Photoelectric Cells. We are now ready to combine the apparatus at the studio to start the television signal on its way. Fig. 54 shows the apparatus used to project the light. The illumination portion

of the equipment is identical with that used for the projection of motion pictures. It consists of a lamp housing in which an arc or a lamp is installed with a reflector behind it to

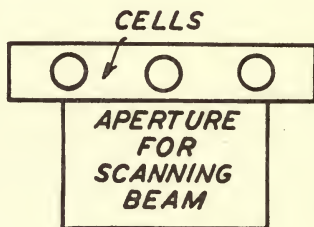

Fig. 51

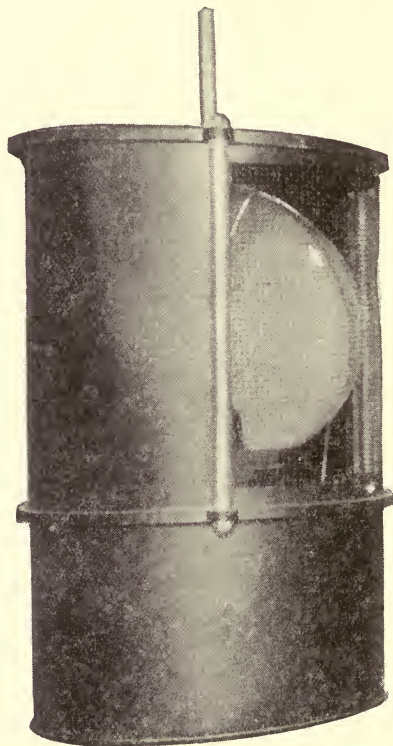

Fig. 52

focus the rays of light in the form of a beam and to make use of those rays that radiate from the rear of the lamp.

The beam of light from the lamp housing is directed through a condensing lens system which consists of two bi-

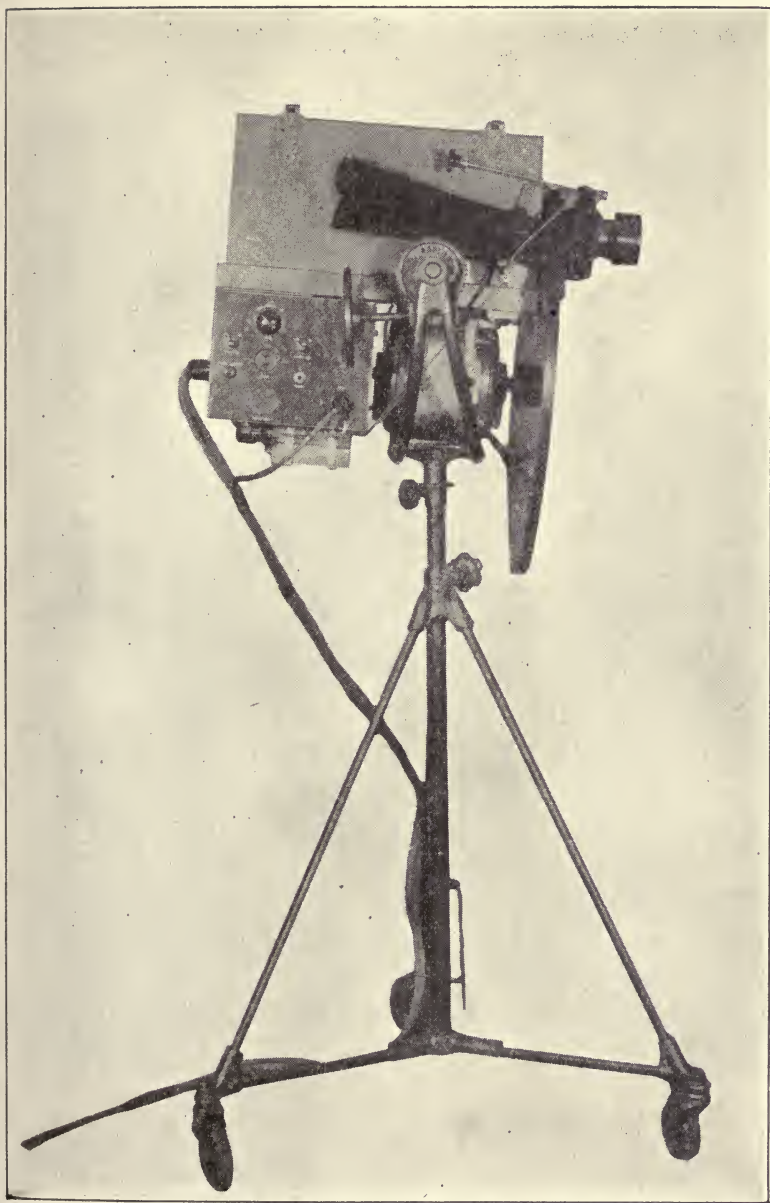

Fig. 53

convex lenses. These lenses are not equi-convex, one side being ground spherical and the other parabolic in order to con-

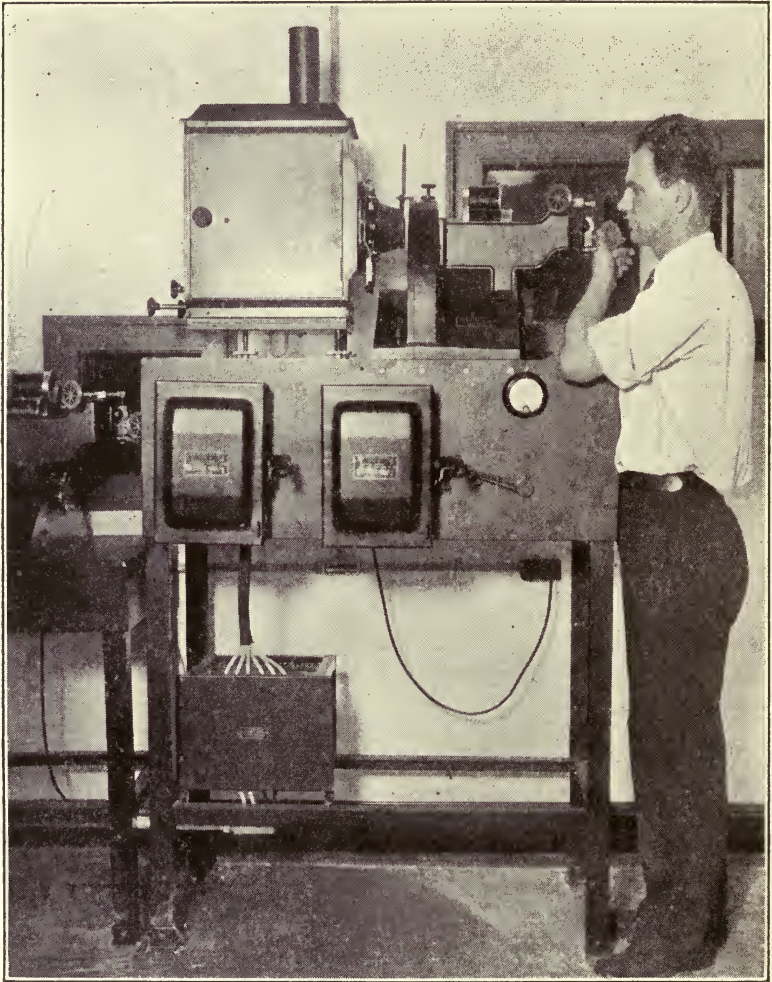

Fig. 54

verge the beam upon an aperture a little larger than that occupied by the scanning area on the scanning disc.

The scanning disc comes next in the system to act as a shutter to cut off the beam of light except that which will pass through the pin-hole that is cutting the beam of light at any

given instant. In this way, the light that passes through to the scanning area at any given time is that permitted to pass through a small aperture in the disc. The rest of the beam is shut off entirely.

The light that follows immediately after the scanning disc is, then, a succession of "lines" of light, which taken in the aggregate will constitute complete illumination as seen by the eye, because of the faculty of the eye to retain that which it sees for a fraction of a second.

A projection lens serves to direct the beam upon the scanning area and to set up the limits in which the action shall take place. The projection system is a compound lens which collects the light that has passed through the holes in the scanning disc and focuses it upon the center of the area that is to be the scanning field. Good collection of light necessitates the placing of the projection lens as close as possible to the light source, a more or less difficult feat in the design of a television projecting system.

The focal length of the lenses determines the nature of the scanning field. A lens having a short focal length gives a larger scanning area while one having a long focal length is required for the smaller fields, the close-up position.

The projection system as shown in Fig. 54 includes a mirror that is placed upon a swivel and may be controlled to direct the rays of light to the desired position. The mirror may be moved either vertically or horizontally, which allows for a considerable amount of flexibility even though the apparatus be of the nonportable type.

We have now provided the facilities for illuminating that portion of the studio in which the action is to take place. Assuming that the subject to be scanned is to take a position in the close-up area, a microvisor such as is shown in Fig. 50 will usually be employed.

The light flickers across the face and a portion of the body of the person sitting before the microvisor, but to an observer the area appears to be illuminated entirely with a sort of a subdued light. The person being televised, however, sees a flickering light because of the continuous cutting of the beam by the disc so that only a very small portion of the full beam is admitted at any time.

Let us take a single revolution of the disc slowly to de-

termine the action. The first hole in the disc, that which is furthest from the center, starts its path through the light beam emanating from the lamp housing through the condensing lens. A small beam passes through the hole, through the projection lens, on to the mirror and is reflected to the scanning area. As it proceeds across the area, it strikes a spot where the shading is different from that of the background, and the intensity of the reflection changes, causing a ray of greater or lesser intensity to be cast back. The reflected ray is impressed upon the cathode of the photoelectric cell from the instant it comes within the limits as outlined by the apparatus, and a signal of a definite value is developed in the electrical circuits. When, therefore, the differently shaded area is reached by the beam, the intensity of the reflected light differs from that which precedes it, and the number of electrons emitted by the cathode of the photoelectric cells in the microvisor is reduced or increased according to the nature of the reflection. The change in the electronic stream causes a corresponding change in the current flowing in the circuit, which change is modulated on the carrier wave of the transmitter and becomes a part of the television signal.

What has happened in the passing of the first hole across the scanning field is repeated with each of the remaining holes, the photoelectric cells registering the differences in shading and causing more or less current to flow in response to the variations in the shading which the small light rays strike at any given time.

It will be seen, now, that the television picture is actually divided into a series of lines, each of which starts at one side of the picture and passes to the other just as though lines of light were being drawn. It can be seen, also, that the television picture actually consists of the electrical representation of these lines placed end upon end as they pass through the *ether* from the transmitter to the receiver.

Direct Pick-Up. Direct pick-up and a device such as the television camera used in the Jenkins Television Corporation laboratories go together. By this system, instead of projecting a shuttered light beam from a light source, the area in which the action is taking place is illuminated brightly and the scanning disc cuts the rays reflected to the photoelectric cell as shown in Fig. 53. Although the direct pick-up system

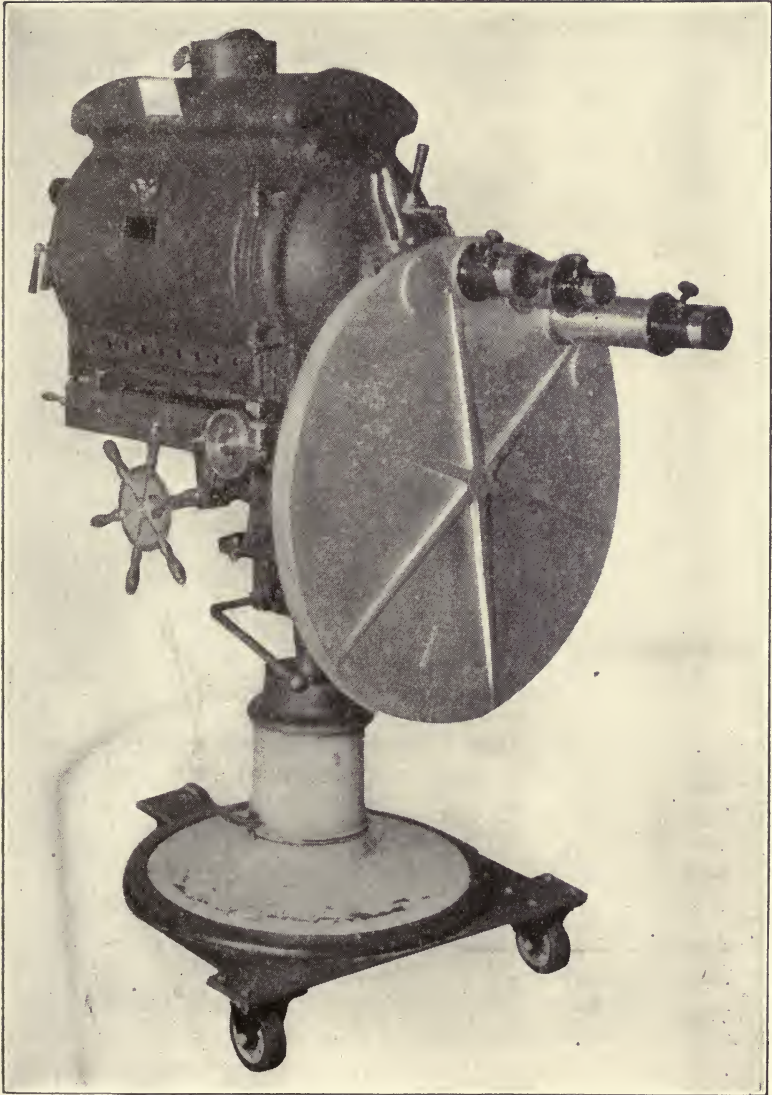

Plate V

Light projection apparatus developed by Jenkins Television Corporation. The rollers permit portability so that the desired area can be illuminated.

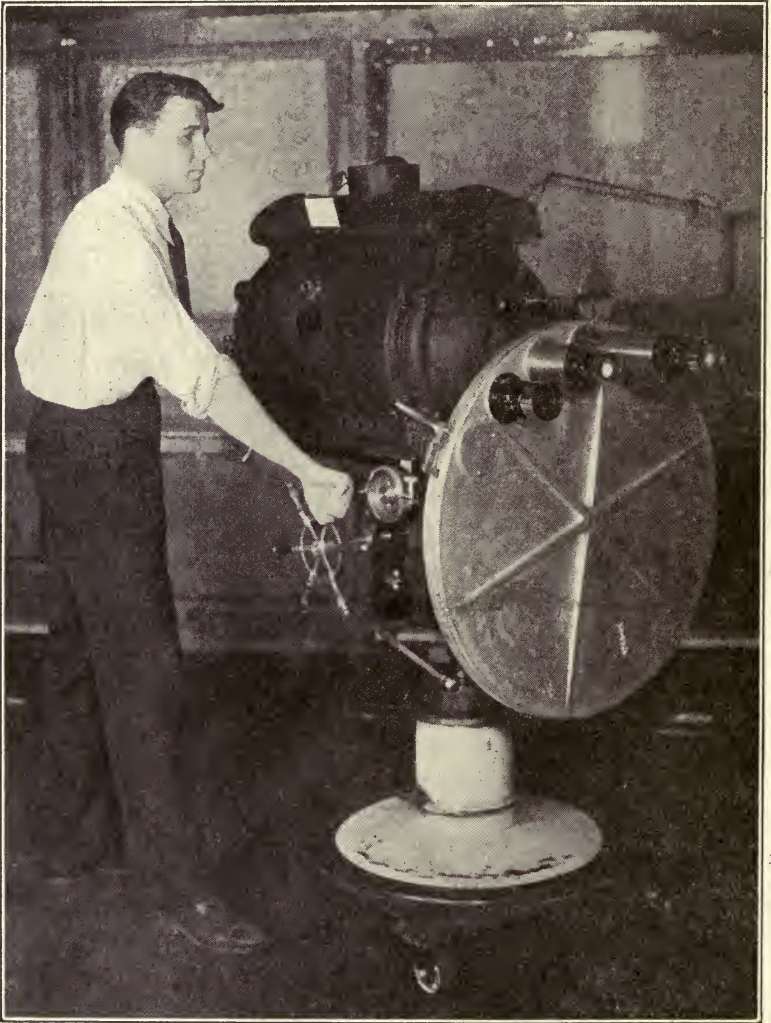

Plate VI

The projection device shown in Plate V being operated in the studio. The control in the hands of the operator permits raising or lowering the light beam. Note that the shutter between the light housing and the scanning disc is open, whereas it is closed in Plate V.

involves the use of so much illumination that the temperature in the studio is markedly high, at the same time it lends itself to those forms of studio technique that make use of light rays outside the range of visibility of the human eye. A system using invisible light would necessarily require photoelectric cells that are known to be sensitive to either the infra-red or the ultra-violet portion of the spectrum.

The direct pick-up system provides greater flexibility of movement since the action can be placed upon a stage of fairly sizeable proportions and the camera or other portable device of a similar nature can be moved so as to take in that portion of the stage on which the desired action is taking place.

Amplification. The signal as generated in the photoelectric cells is extremely weak and requires a great deal of amplification before it is of sufficient strength to make it practical for modulation. In addition, where more than one cell is used in the microvisor or where more than one microvisor is employed, it is necessary that the strength of the signal created by each cell be made equal to that of each of the others. If the output were not matched thus, the amount of light picked up by one would create more or less current flow with the result that certain parts of the reproduced picture would be out of proportion to other parts (distorted). Therefore, we find three pieces of apparatus necessary to prepare the signal for the transmitter, the head amplifier, the fading panel, and the line amplifier.

Head Amplifier. The head amplifier corresponds so far as one of its purposes is concerned to the amplifier that is in conjunction with a condenser microphone in a sound studio in that it serves to amplify the weak signals generated by the photoelectric cell to provide a sufficiently strong signal to be effectively carried to the fading panel and the line amplifier. It serves another purpose, however, that of regulation of the current values to correspond to that of other cells in the circuit. The output of each head amplifier measured at the fading panel should not vary. Even slight variations will result in an over-emphasis of certain parts of the reproduced picture and lack of registration of other portions.

It is essential that the head amplifier be capable of passing a wide band of frequencies with efficiency. Therefore, there is no alternative than to employ resistance coupled ampli-

fication, the coupling condenser for which is of such value that it will permit the proper handling of the low frequencies as well as the high, and the resistors used in the tube circuits must necessarily be such that they will provide a comparatively high voltage drop to obtain the maximum variation in potential and, therefore, more amplification.

The head amplifier is usually mounted very close to the cell, many times in the same compartment in which the cell is installed in order to reduce losses that may be set up through the wiring or through capacitative effects where the wires run parallel for any distance.

Fading Panel. The purpose of the fading panel in a television studio is to provide a means for switching from one scanning field to another readily and to control the circuits so that a sudden change will not damage the transmitter because of an excessive instantaneous current impressed upon the circuits there.

The greatest change in signal would be manifested when switching from the full length positions to the close-up, for the reason that because of the use of lenses of longer focal length, the light field is more intense and the current generated in the photoelectric cells is correspondingly greater. At such a time the operator in the studio must be acquainted with the apparatus to such an extent that he will be capable of judging closely the anticipated change in intensity and make the adjustments accordingly. It is always better policy to have the level too low because it can be increased, whereas if the level were too high, there is danger of putting the transmitter off the air and several minutes or more might elapse before it could be put into operation.

Line Amplifier. The line amplifier is another cascade amplifier, the purpose of which is to further amplify the weak signals to give them sufficient strength to reach the transmitter. Its size and output will depend upon the length of the line leading between the fading panel and the transmitter as well as upon the system of modulation that is employed.

The line amplifier is, like the head amplifier, a resistance coupled device capable of handling the widely varied frequencies of the television circuits. It takes the signal delivered from the fading panel and builds it up to one of comparatively

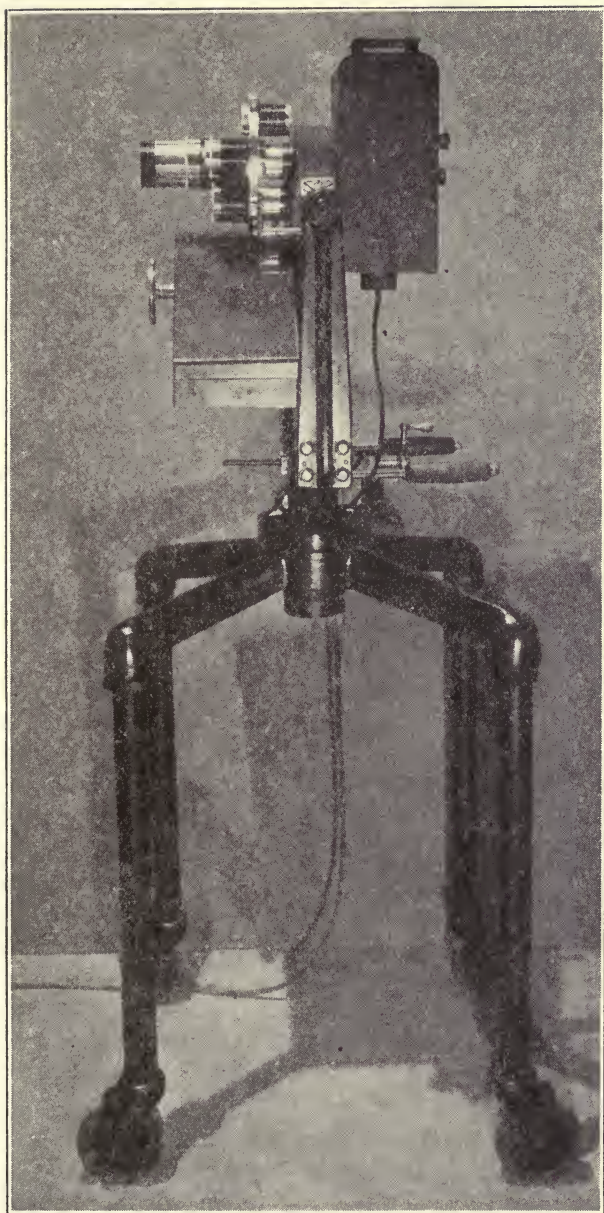

Plate VII

Western Television Corporation portable projector and scanner. The device is controlled horizontally and vertically by means of the handles seen at the rear of the machine. Various lenses, on a turret, provide facilities for illuminating a large or small area as desired.

large values, sufficient to effectively modulate the transmitter.

The modulation system employed is left to the discretion of the engineers engaged in the design of the apparatus. There are those who prefer to use high level modulation, but others report greater success from modulation of the low level stages. Consequently, if the low level modulation be employed, the output of the line amplifier can be decreased with results equal to those of a high output from the line amplifier impressed upon the high level stage of the transmitter.

Receiving the Picture. We have discussed the process of combining the scanning devices with the photoelectric cells, the projection devices to illuminate the scanning field, the amplification units for making strong signals from the minute impulses generated by the photoelectric cells, and finally the modulation of the signal upon the transmitter. Sufficient has been written concerning the design of transmitting devices to make it unnecessary for them to be covered in this treatise, so that we can pass directly to the receiver and make the combination there to show its relationship with the transmitter and to find how the picture is reconstructed.

Receiving the Signal. The device for the reception of television signals corresponds with that for voice with a few exceptions. The receiver may be tuned to the television signal in either one of two ways—by the use of headphones or a loud speaker connected in such a way that the set will feed either the loud speaker or the glow lamp or by tuning directly to the screen. Inasmuch as the television picture impresses itself upon the screen very readily, there seems no reason why the headphones or loud speaker should be used, except that some persons have become so accustomed to tuning in an aural signal that they find it more convenient so that they can watch the dial as they make the adjustment. Lack of synchronization between the disc at the transmitter with that at the receiver will necessitate the use of an aural tuning device.

The television signal heard in the speaker has a tone that is distinctly individual. It is a high pitched chopped whistle with no variation other than that caused by the manipulation of the receiver controls, changes made in the transmitter adjustment, or atmospheric conditions. The audio frequency of the note is calculated readily by multiplying the

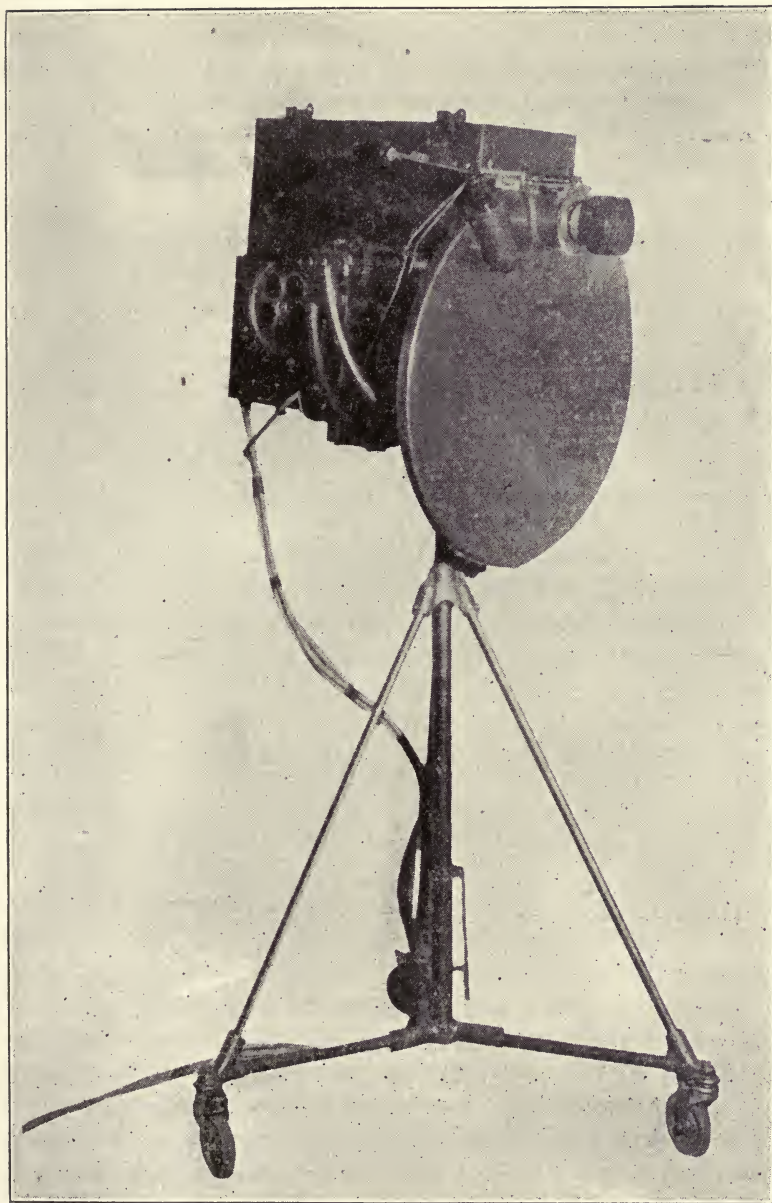

Plate VIII

Front view of the Jenkins Television Camera. Note the hooded finder along the side of the box which enables the operator to keep his camera directed properly.

number of holes in the scanning disc by the number of revolutions of the disc per second.

Tuning to the television signal on the screen is not difficult if the discs are synchronized, except that one must watch the screen continually to prevent passing over the signal. There are occasional splotches on the screen, irregular patterns that have no apparent constructions. Such patterns are usually caused by signals from a voice transmitter, and the patterns are the visual representations of the voice or music. If the pattern appears to run smoothly with definite variations, it can be surmised that a musical program is in progress; while if the splotches appear irregularly and intermittently, there is evidence that someone is speaking. Some forms of staccato music create irregular patterns also.

Constructing the Picture. The signal received on the antenna of the receiving set is amplified through the successive stages of the radio frequency portion of the receiver, and the low frequency signals containing the television impulses are set up in the detector circuit and amplified in the audio system, which is usually of the resistance coupled type, although some receivers also employ one stage of either transformer or impedance coupling. The output of the receiver is fed to the device that takes the place of the loud speaker in the voice receiver, referred to in a number of ways, usually as the *televisor*, or simply the "screen," which term is presumed to refer to the entire mechanism, unless there is a differentiation as by engineers in the laboratories.

Logically, it is best to use the simplest form of set-up for the description of the reconstruction of the picture. Consequently, let us take that apparatus used in the earlier television devices—a combination of a glow lamp, a scanning disc, a motor, and a hood to shut out the outside light and thereby enable one to see the picture more readily.

The output from the receiver should be such that under normal conditions and without modulation the plate of the glow lamp would glow. Therefore, we find on looking in through the shield that there is an orange colored area surrounded by darkness. For the purpose of experimentation, let us shut off the motor and allow the scanning disc to come to rest. As the speed of the motor decreases, the illuminated area changes form, parts of it appear to be dark with spots

of light dashing across them, the lines divide and become distinct from one another, and finally when the disc is turning slowly, there are comet-like shafts of light, then dots, and when the motor has stopped there is likely to be a single ray of light penetrating through a single hole in the disc. As the motor is decreasing in its speed, it is very easy to note the arrangement of the holes through which the light is shining and to see the progression in which the area is illuminated.

Start the motor again and when it has attained its normal speed, the area will again have that full illumination that was noted before it was turned off. Tune the receiver until a television signal presents itself upon the disc. This may or may not be difficult, depending upon the synchronizing system. If the motor is rotating in synchronism with the one connected to the scanning disc at the transmitter, then there is no question concerning the appearance of the picture in its complete form, although it may not be positioned correctly.

We shall assume, however, for the present that the discs are rotating in synchronism so that the picture will be complete. But it may be *out of frame*, and if such is the case, it is necessary to position it correctly in the scanning area, and then we see a representation of what is transpiring before the photoelectric cells in the studio. The manner in which it is accomplished follows.

It was shown how a ray of light passed across the scanning field in the studio and how when it came into the limits of the field, a reflection was cast upon the photoelectric cells in the microvisor, causing a flow of electrons, thereby setting up an electric current which was amplified and modulated upon the carrier of the station. That signal has been received on the antenna of the receiver, carried into the receiver circuits, amplified again, and the glow in the glow lamp has been increased or decreased accordingly. Therefore, when the first hole of the scanning disc rotating before the glow lamp came into the limits of the scanning area, the lamp was at a brilliance that corresponded to the intensity of the light reflection at the studio. It was shown also how in passing across the scanning field at the studio, the ray struck a differently shaded area and that the reflection to

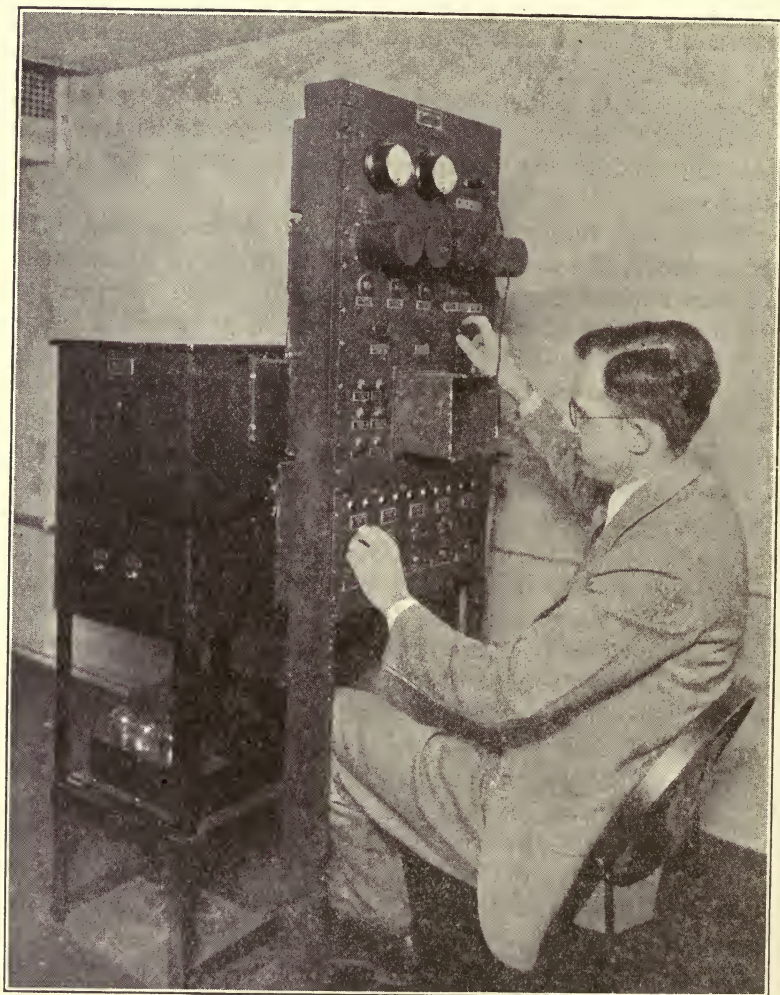

Plate IX

Dr. Lloyd P. Garner, Chief Engineer, Western Television Corporation, operating the fading panel and control board in the studio of W9XAP. The hood in the center of the board shades the illuminated area by means of which the operator monitors the pick-up. The line amplifier is contained in the cabinet behind the fading panel.

the photoelectric cells was more or less intense according to the nature of the object upon which the ray fell and that the electric current was changed in a corresponding degree. The signal impressed upon the carrier was, therefore, changed accordingly and the amplitude was increased or decreased. Such increase or decrease passing through the stages of the receiver caused the glow to be more or less intense and since the hole in the scanning disc before the glow lamp is in a position corresponding to that in the studio, the eye perceives the increasing or decreasing of the intensity of the illumination as compared with that which has immediately preceded it. In such manner is the picture constructed as the entire area of the scanning field is covered, each variation in the intensity of the reflection of light upon the photoelectric cells at the studio registered with an equivalent degree of brightness in the glow of the glow lamp instantaneously and in the proper relative position.

Framing the Picture. A picture is *in frame* only when the integral elements of the reproduced picture correspond relatively with those at the transmitter. Any variation from the original constitutes a division of the picture so that it is not positioned properly with respect to the scanning area. We have already assumed that the picture was properly framed. Now, we can well assume that the picture is *out of frame*. There is only one reason for a picture being out of frame—the scanning disc at the receiver is not running in the same relative position as that at the transmitter. Therefore, let us analyze such a condition.

We will assume that the first hole in the disc (the one furthest from the center) at the transmitter starts across the scanning field at a given instant and the light reflections are registered upon the photoelectric cells. Those reflections in the form of varying electric currents are transmitted to the receiver and pass through the stages of amplification, impressing themselves instantaneously upon the electrodes of the glow lamp.

Here, however, instead of the outside hole of the scanning disc crossing the scanning field at that instant, let us say, merely to cite an illustration, that the tenth hole is passing in front of the glow lamp. It is evident, then, that what is transpiring at the studio and what is registered upon

the glow from the glow lamp will be seen at the position covered by the tenth hole, some distance from the edge of the area. Each successive hole registers just what is delivered to it in the same relation, so that when the disc has made a complete revolution and the last hole in the disc at the transmitter has covered the extreme lower edge of the area, the light reflections from that position will be registered to the eye in the position covered by the ninth hole in the disc, and the operation is repeated.

By the same token that there is only one reason for the picture being out of frame, there is only one way in which it can be properly framed—change the position of the disc at the receiver to correspond to the one at the transmitter. The method by which this is accomplished varies with apparatus of different manufacture.

One of the most common methods for changing the position of the disc is that in which the switch controlling the operation of the motor is shut “off” and then “on” again, allowing the disc to lag slightly. Luck is the controlling factor but often the proper setting is obtained by one or two snappings of the switch, particularly after a little experience.

Another method that has been used with more or less success is one in which a brake is applied to the disc to slow it down and cause it to lag. Releasing the brake permits the disc to resume speed and here, too, a little practice enables the operator to become skillful.

The motor developed in the laboratories of the Western Television Corporation by U. A. Sanabria provides a means for framing that is extremely simple. The motor is one of the synchronous type, the stator of which is arranged so that it may be rotated in either direction. Since the rotor is moving with a direct relationship to the stator as determined by the poles in the stator and the slots in the rotor, any movement of the stator will change the relative position of the rotor. The disc is fastened to the rotor and a sprocket-wheel-like device is made fast to the stator. Hence, if the disc is not rotating at a position that properly frames the picture, the stator is rotated until the picture is in frame, a few degrees in either direction.

Framing the Multiple-Spiral Disc. In framing television pictures, the multiple-spiral disc is more complicated, on the

surface, at least, than the single-spiral disc. There are three positions of the three-spiral disc (the number of positions corresponds directly with the number of spirals) in which the picture will be confined within the picture area. But the observer will note that there is a decided lack of accord in two of them while the third seems to be clear. Persons who have experimented with television for years have been confused at the condition, although the reason therefor is relatively simple.

It has been shown that the multiple-spiral disc consists of three spirals, each of which differs from the others so far as distance from the center is concerned. (See Fig. 47.) Assume again that the first hole in the disc at the transmitter passes the scanning field at a given instant, but that at the corresponding time the first hole of the second spiral is passing in front of the glow lamp. It will be seen that what should go at the extreme top of the picture area will be placed in the second line and that what should be in the fourth line will be in the position of the fifth line, and so on. Similarly, when the disc has made two-thirds of the revolution, and the first hole of the third spiral is passing the area at the transmitter, the eye sees that as registered by the first hole of the outer spiral and what should be three lines from the top is placed directly at the top of the field, and the entire picture is jumbled.

It would be necessary, therefore, in such an event to rotate the stator of the motor used on a multiple-spiral disc as much as 120 degrees in order to properly position the picture, but the construction of the motor is such that if in the event that it is turned that portion of the revolution and it is found that the other scrambled picture is in frame, the stator can be rotated still further until the proper position is obtained.

Synchronizing Sight with Sound. There are two general types of television presentations, those which are referred to as *silent* and those that are *synchronized with sound*. Those of the silent variety are, as the name implies, without sound accompaniment, while the synchronized programs are those in which a sound accompaniment is broadcasted simultaneously with the visual presentation, so that by using two receivers the program can be seen and heard.

The sound station may be either a regularly established broadcasting station operating in the band between 550 and 1,500 kilocycles, or it may be one operating on the higher or lower frequencies. It is separate and distinct from the station used for the transmitting of the visual signals and requires the use of a receiver designed to receive signals on the transmission frequencies employed. No method has been devised to utilize a single channel for the transmission of sound and visual signals.

The function of the sound station in the television studio is to furnish sound accompaniment for what is transpiring before the photoelectric cells. In the case of the regularly established broadcasting stations, several regular features are broadcasted by both forms of transmission. As an example, Dr. Herman H. Bundesen, Coroner of Cook County and Health Commissioner of Chicago, gave health talks over voice station WMAQ, and after the installation of the television station W9XAP, his broadcasts were sent over both WMAQ and W9XAP, the doctor sitting before the photoelectric cells in the television studio as he gave his discussion. Similarly, from the same station, Hal Totten, the sports announcer, gave a sports review each evening during the summer months, and this program, was simultaneously broadcasted over the two stations. Baseball fans who owned television receivers were able to hear Hal give the summary and to see him as well as baseball personalities whom he brought to the studio occasionally for the purpose of interviewing them. In both of these cases the microphone for picking up the sound was placed near the position in which the speakers sat and the signals were transmitted in exactly the same manner as though one of the regularly arranged studios connected with the voice station had been used.

Television Studio Technique. Visual broadcasting necessitates the enforcement of far more rigid qualifications than does sound. The artists must not only be familiar with the microphone, but they must present a good appearance photographically. A person who is "camera shy" or who does not photograph readily would be out of place in a television production. The artist must also be capable of acting parts or doing some form of entertainment work that will hold the attention of the "lookers-in." This is particularly true in

the event the presentation is a silent one, that is, without the sound accompaniment.

There have been many attempts to determine the value of *make-up* in a television studio, but reports concerning the success vary greatly. It is thought commonly that it is better practice to select that type of personality that will televise well without the use of make-up. The response characteristics of the photoelectric cells in some respects are determining factors in this regard.

Attention must be paid to the costumes that are worn by the artists appearing before the microvisors. It is not good policy to permit the use of colors that are widely variant such as black and white, but rather it is advisable to select colors for the costumes that will blend into one another readily and easily, with enough contrast to enable the photoelectric cells to draw a contrasting line.

Dramatic productions for television require the services of continuity writers who are familiar with the procedure followed in a television studio. The play must be written in such a manner that the participants can enact the parts within the limits of the field. The number of actors in the scene at any one time is another matter of importance, and it is essential that the continuity writer determine before hand what are the limitations of the studio for which the presentation is being prepared. These are general restrictions.

So far as television facilities go at the time of writing this book, it has not been found practicable to have more than three actors in the full length area at one time. It is usually found that two faces will fill the scanning field for the close-up position, and for that reason, the small scanning field is used for monologues or dialogues almost exclusively.

Television presentations are more flexible than one would believe at first thought. For instance, it is not necessary that the sound and the visual program originate in the same studio. Take a dancing act as an example. If the television station is in conjunction with a voice transmitter, and such is usually the case, the sound program might well be an orchestra in a night club or hotel dining room somewhere, while the dancing would take place in the television studio in rhythm with the music from a monitor-

ing loud speaker placed in the television studio. Shadow boxing could be handled similarly, although for experimental purposes shadow boxing has been used quite successfully without music of any kind.

Moving Picture Films and Television. The use of moving picture films in television has been discussed widely. There can be no doubt that the films will lend themselves in an appreciable degree to television entertainment, but it would be foolhardy to predict that they will occupy the position of prime importance, for the reason that studio productions constitute presentations of what is transpiring coincidental with observation at the receiver, whereas moving pictures represent something that has transpired in the past. However, such things as news events, vaudeville skits, speeches, and the like can well be provided by television stations for the entertainment or enlightenment of those who are looking and listening in the homes.

A word about the technique of the moving picture film is necessary before entering a discussion of its adaptability to television. A motion picture film is a succession of still pictures, which pictures are taken at the rate of 24 per second, the film moving at a normal speed of 90 feet per minute. The projection of a motion picture film means that 24 single and individual pictures have been brought into the light beam and reproduced upon the screen of the theater each second of time. The phenomenon known as the retention of vision enables the eye to see the picture as one in which there is movement because of the relative position of the objects in the picture.

During the projection operation, the film moves to a position such as will allow the light to pass through it and there it stops. When it has been impressed upon the screen, a rotating shutter passes the lighted area and during the period of darkness, the film is moved to the next picture or frame and again it stops for an instant, is shuttered and moved forward to the succeeding picture.

Thus it is seen that what the eye really perceives on the screen of the cinema is a rapid sequence of individual pictures, each of which would be complete in itself. Modern films include another feature, however, which enters into the television problem—sound.

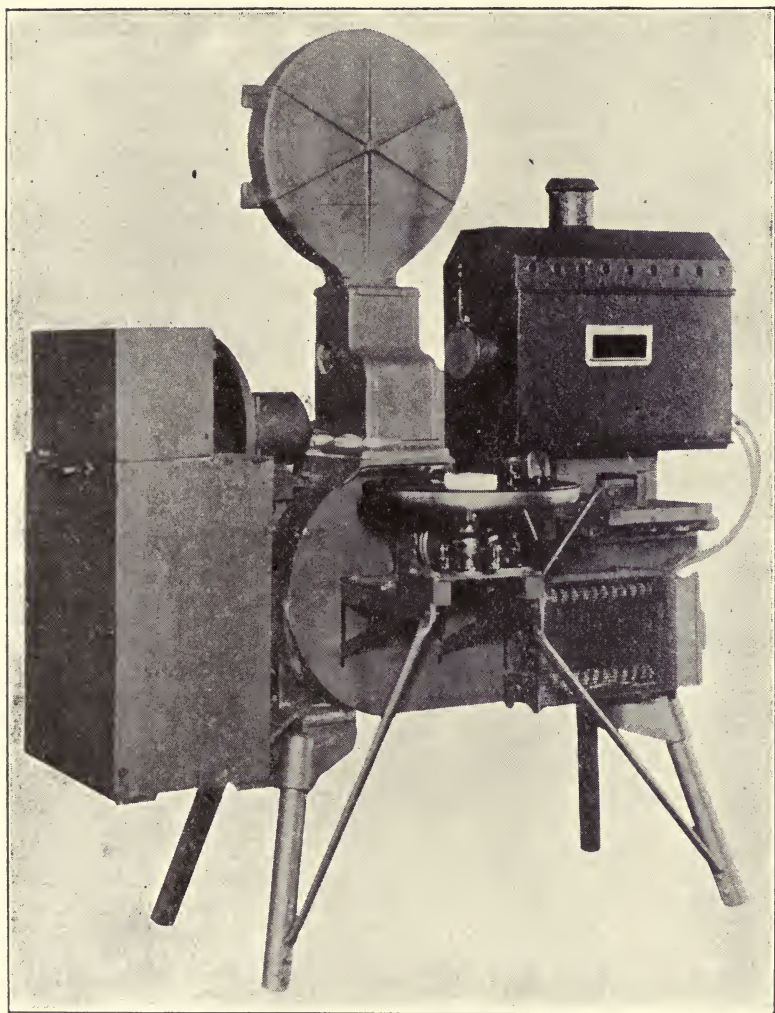

Plate X

The projector for transmitting moving picture films at Jenkins Television Corporation laboratories. The scanning apparatus is included in the compartment at the left of the picture. Note that a turn-table is provided for synchronizing sound with sight.

There are two methods for providing sound with moving pictures. One is that in which the sound is on a wax record that rotates exactly like a phonograph and in synchronism with the movement of the film. The other is that in which the sound is recorded on a small strip of film alongside the pictures and in which the reproduction is effected by the action of the varying light impulses upon a photoelectric cell. The photoelectric method is used more extensively.

It was shown above that the film moves through the light beam with an intermittent motion, but it is evident that the reproduction of sound requires continuous and regular motion, else the sound will be distorted. Therefore, the apparatus is designed so that the sound track moves past the aperture provided for it in a continuous forward motion and without intermittent stops necessary to project the picture.

The method by which this continuous movement is obtained is extremely simple. After the film passes the projection lens before which it moves intermittently in accordance with the Geneva movements, it is allowed to "ride" loosely in what is known as a loop. The loop is large enough that it provides slack to take care of the time interval when the film stops before the projection lens. An examination of a sound projector while it is in motion would reveal the loop alternately large and small with each forward movement and stopping of the film while at a distance of fourteen inches from the picture projecting position the sound is taken off while the film passes steadily through the beam of light directed toward the photoelectric cell that provides the input to the sound system.

The adaptation of motion picture films to television presents some problems that involve the speed of movement of the film and the method of reproducing sound. The use of silent films means that the problems are reduced somewhat, but there still remains a serious difficulty.

Television pictures, it has been stated, are scanned at the rate of 15 or more times per second. It is customary to scan them 20 times at a maximum, although experimental programs call for higher frequency of scanning. However, it is desirable to keep the scanning speed as low as possible.

Therefore, it is seen that since motion pictures are taken at the speed of 24 pictures per second, the slowing down of the film to 15 or even to 20 pictures per second would cause

the motion to be much slower than intended. In other words, if the picture were that of a race, the sprinters instead of running at top speed would be shown to be walking rapidly if the 20-frame per second television system were used, or merely walking with a long stride if the speed of scanning were 15 frames per second. Naturally, such a condition would not represent the true depiction of the event.

Most television laboratories that have been experimenting with the use of motion pictures in television have considered that the movement of the film itself would constitute one element of the scanning process, and they have, therefore, used a system that included horizontal scanning with the perforations in the disc or other device arranged so that they passed the light aperture in such a manner that they took the motion of the film into account, and the film was kept constantly in motion. This method will not suffice, however, unless a television scanning system operating at the rate of 24 pictures per second is employed.

In the use of sound films, the condition is further complicated for the reason that the sound track is not passing the aperture and photoelectric cell at the speed of 90 feet per minute, the speed at which the sound was recorded, with the result that the effect is that produced by running a phonograph too slow. It is evident that there must be an adjustment of some sort; and it is evident, also, that either the pictures for television presentation must be prepared especially for the purpose or some element must be sacrificed.

The matter of providing special television pictures has been discussed but nothing definite has been accomplished, so that the development rests with the standard films. If special films were made, other things, such as the adaptability of the dramatization and the type of artists would be taken into consideration simultaneous with correcting the other discrepancies existing in the standard film in its relationship to television presentations.

One system for adapting standard motion picture film to television, one in which a part of the film was deliberately sacrificed, was developed by Armando Conto, an engineer for Western Television Corporation of Chicago. Two identical films are required for the Conto system, and a duplicate projection system is employed.

Since the Western Television Corporation uses multiple scanning exclusively, the design of the apparatus is built around the three-spiral 45-hole disc rotating to give 15 pictures per second.

Conto held the opinion that the proper method to scan a motion picture film was to make the operation as nearly

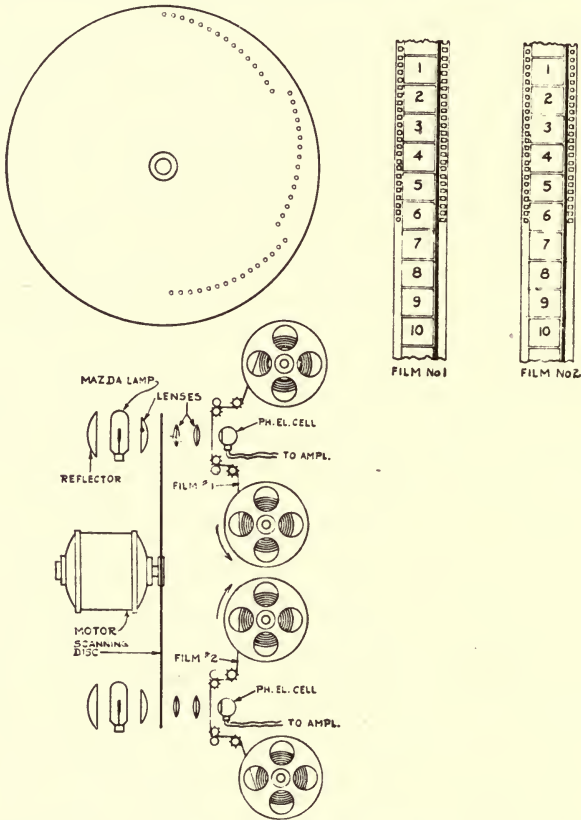

Plate XI

Diagrammatical layout of Conto device for adapting standard moving picture films with sound track to television. A single scanning disc is shown, although two discs operated synchronously could be employed if desired. Note the arrangement of the perforations on half the disc and its relationship with the two projector systems in the lower left-hand corner.

identical with that employed in ordinary projection as possible. He reasoned that the film should not be moving during the scanning. Therefore, he applied Geneva movements (the device used to advance the film in a motion picture projector) to his design.

Two discs are specially designed so the perforations, instead of being distributed all the way around the disc, occupy only one-half of the circumference. However, even though the holes are placed on one side of the disc, they have the same relative position with respect to the scanning area as if they were distributed over the entire 360 degrees. Therefore, during the rotation of the disc, the scanning operation is accomplished with one-half revolution of the disc while the other one-half acts as a shutter, completely shutting off all light passing through the film to the photoelectric cell.

The two discs are mounted so that they operate together, but in such a manner that while one is acting as a shutter, the other is scanning a picture of one of the films. Then, too, while one disc is engaged in scanning a picture that is in a fixed position at one time, the other film is being moved forward so that when the disc has made one-half a revolution, the film has stopped and the scanning is shifted from one projector to the other. While the discs go through another one-half revolution, one film is being scanned, the other is being moved into position.

The films are placed in the twin machines with the index points in the same relative positions. As the discs rotate, and the first picture of film No. 1 reaches the scanning field of machine No. 1, it stops. Simultaneously, the first hole of the scanning disc starts its path across the area, allowing a ray of light to pass through the film to strike the photoelectric cell beyond. Then comes the second hole and so on to the forty-fifth at the extreme bottom of the picture area. In all this time, disc No. 2 has been rotating, but the solid portion of the disc has been cutting off the light from the photoelectric cell and the film has been moving until it comes to rest with a picture in the scanning field, which picture is a little further advanced than the one that was scanned by disc No. 1. Then, as the scanning portion of disc No. 2 scans the picture within its scanning field, the solid portion of disc No. 1 cuts the light off from the photoelectric cell in front of it and film No. 1 moves forward, skipping that picture that is being scanned by disc No. 2, coming to rest again at a position beyond that picture already projected.

The operation continues with first one film being scanned and then the other, and each time one film is at rest and

undergoing the scanning operation, the other is moving forward to be ready for projection.

The photoelectric cells are connected in parallel, each with an individual head amplifier that insures equal output from both cells. The output from the head amplifier is carried into other amplifiers, modulated upon the carrier wave, and transmitted to receiving sets.

But there enters this problem—the discrepancy between the number of pictures on the film and the frequency of scanning. The film was made with 24 pictures per second. Conto's television system provides 15 pictures per second—only a little more than one-half.

It must be remembered that the difference in movement between any two adjacent pictures that make up a motion picture film is that represented by one-twenty-fourth of a second, approximately the time used for ordinary outdoor photographic work of an amateur nature. The eye, on the other hand, can follow the movement with good definition if the pictures are presented at the rate of one every fifteenth of a second.

Conto, therefore, designed a cam arrangement that causes the Geneva movements to work in a predetermined manner, making skips here and there throughout the length of the film. The skips are arranged so that they repeat themselves every two seconds, which means that the same relative parts of each group of 48 pictures are passed by and do not undergo the scanning operation. Thus, there are certain places throughout the film where the movement registered on successive pictures is that which has occurred in one-twelfth of a second. However, since the skips are arranged irregularly, the excessive motion is not perceptible.

Since the scanning is accomplished with one-half a revolution of the disc, it is evident that the speed of rotation of the discs is one-half that usually employed. The ordinary speed of rotation being 900 revolutions per minute, or 15 revolutions per second, the speed of rotation in the Conto motion picture device is only 450 revolutions per minute or $7\frac{1}{2}$ revolutions per second. This point is pertinent as regards the action upon the film itself in the matter of movement. The motion picture projector moves the film along every twenty-fourth of a second, moving it one picture each time.

The television adapter, however, moves each film only fifteen times every two seconds, so that the wear on the film is less than in the ordinary motion picture projector. The lapse of time, therefore, during the one-half revolution of the scanning disc is more than ample to permit the movement of the film without injury.

Again there enters the problem of the reproduction of sound, but it can be seen readily that inasmuch as 24 pictures on the film are being advanced each second of time, the sound track is traveling at the proper speed to prevent distortion.

Therefore, even though there is a sacrifice of a little over one-third of the total picture recorded, at the same time the Conto device effectively provides a means to adapt standard motion picture film to television. If at a later time it is found practical to adopt as a standard a scanning speed different from that used by Conto, a rearrangement of the cam to control the Geneva movements will be the only change necessary.



Plate XII

The Western Television Corporation "Empire State" model receiver, combining facilities for selecting television and sound programs. The television receiver is controlled by means of the knobs at the top of the cabinet, the sound receiver by those in the center. The screen at the top measures eight inches square, and is made of ground glass so that the picture is projected directly upon it.

CHAPTER X

RECEIVING CIRCUITS

Receiving Apparatus. Television receiving apparatus consists essentially of two parts, the receiver and the scanner. The receiver includes the tuning devices, the detecting system, the amplifier stages, and the power supply equipment—all the associated apparatus to deliver the signal to the reproducer. The scanner assumes the same position with reference to the television receiving device as the loud speaker takes in a receiver for sound. In other words, it is the reproducer. The scanner includes a motor for actuating the scanning device, a reproducing lamp, and a projecting system, including the screen if the model be of the screen type.

Receiving Set. The receiving set for television differs from the regular broadcast receiver only to the extent that a different range of wave lengths must be covered. The channels assigned for the use of television are subject to change from time to time as the Federal Radio Commission may deem necessary. Since the art is, at this writing, in an experimental status so far as the Federal Radio Commission is concerned, there is no way to foretell what the channel assignments will be when television is established commercially.

Television signals are transmitted on high frequency carriers at present. The bands set aside for television by the Federal Radio Commission are shown in the table on page 130. Therefore, the receiver must be designed to function in the established limits and since the assignments are not within the range of a single tuning unit, it is necessary that arrangements be made to switch from one band to another, either by means of coils of the plug-in type or an improvised switch to select the proper combination of capacitors and inductance units. Otherwise, the receiver can be designed to conform to modern practice in voice receiving sets for broadcast reception so far as the radio frequency portion is concerned.

**Experimental Visual Broadcasting Stations in the United States
as of November 11, 1932**

Call Letters	Power (watts)	Company	Location
		1600 - 1700 kc	
W1XAV	1000	Shortwave & Television Labrs., Inc.	*Boston, Mass.
W2XR	1000	Radio Pictures, Inc.	Long Island City, N.Y.
W8XAN	100	Sparks-Withington Co.	Jackson, Michigan
		2000 - 2100 kc	
W9XK	100	Iowa State University	Iowa City, Iowa
W2XCR	5000	Jenkins Television Corporation	New York, N.Y.
W2XAP	250	Jenkins Television Corporation	Portable
W2XCD	5000	DeForest Radio Company	Passaic, N.J.
W9XAO	500	Western Television Research Co.	Chicago, Ill.
W6XAH	1000	Pioneer Mercantile Co.	Bakersfield, Cal.
W8XF	500	WJR, Goodwill Station	Pontiac, Mich. (C.P.)
		2100 - 2200 kc	
W9XAK	125	Kansas State College of Agri. & Applied Science	Manhattan, Kans. (C.P.)
W3XAK	5000	National Broadcasting Co., Inc.	Portable
W2XBS	5000	National Broadcasting Co., Inc.	New York, N.Y.
W3XAD	2000	RCA Victor Company	Camden, N.J.
W8XAV	20000	Westinghouse E & M Co.	E. Pittsburgh, Pa.
W6XS	1000	Don Lee, Inc.	Los Angeles, Cal. (C.P.)
W9XAP	2500	National Broadcasting Co., Inc.	Chicago, Ill.
		2200 - 2300 kc	
W9XAL	500	First National Television Corp.	Kansas City, Mo.
		2750 - 2850 kc	
W3XE	1500	Philadelphia Storage Battery Co.	Philadelphia, Pa.
W9XG	1500	Purdue University	W. Lafayette, Ind.
W2XAB	500	Atlantic Broadcasting Corp.	New York, N.Y.
		43000 - 46000 kc, 48500 - 50300 kc and 60000 - 80000 kc	
W2XAK	50	Atlantic Broadcasting Corp.	New York, N.Y.
W6XAO	150	Don Lee, Inc.	Los Angeles, Cal.
W9XD	500	The Journal Company	Milwaukee, Wis.
W2XBT	750	National Broadcasting Company	Portable
W2XF	5000	National Broadcasting Company	New York, N.Y.
W3XE	1500	Philadelphia Storage Battery Co.	Philadelphia, Pa.
W3XAD	2000	RCA Victor Company, Inc.	Camden, N.J.
W2XR	1000	Radio Pictures	Long Island City, N.Y.
W1XAN	100	Sparks-Withington Company	Jackson, Mich.
W9XG	200	Shortwave & Television Company	*Portable
W8XE	1000	U.S. Radio & Television Corp.	Marion, Inc. (C.P.)
W8XF	200	WJR, Goodwill Station	Pontiac, Mich. (C.P.)
W8XL	200	WGAR, Broadcasting Co.	Cuyahoga Heights Village, Ohio (C.P.)

*Temporary License



Plate XIII

One of the early Jenkins television receivers. The cabinet atop the stand contains the scanning mechanism and the glow lamp; the stand itself carries the short wave receiver. The picture is seen through the large lens at the front of the televisior, in which the image, approximately one inch square was magnified to approximately eight inches.

Tuner Unit. The tuning circuit may be the standard type of regenerative circuit preceded or not by a single stage of radio frequency amplification of either the tuned or untuned type as the experimenter may desire. It may also follow the design of standard tuned radio frequency circuits, the neutrodyne, and even the superheterodyne. There may be those persons who will disagree with the use of regeneration in a tuning unit, but experience has shown its practicability and what appeared to be distortion caused by the regenerative circuit has been found to be due to a lack of low frequency response in the amplifier stages.

Calculations. The calculations to determine the specifications for circuits required to tune to the frequencies used in television are identical with those for all tuned circuits. The principal parts that are concerned in the calculations are those pertaining to the inductance coil and the capacity of the condenser. As in radio receiving devices for use on the voice broadcasts, the frequency to which the receiver tunes is dependent upon the relationship that exists between the inductance of the coil and the capacity of the condenser in the circuits of the tuning stages.

In order that calculations may be facilitated, reference tables have been prepared for use in calculations of resonant circuits. The data, referred to as oscillation constants, is usually incorporated in radio treatises, but since, in the discussion of television, it is necessary to use only those that have to do with the short wave lengths, the data in Table III is published for convenience in working out television or short wave reception problems.

The solenoid type of coil, which is a single layer coil wound on a convenient form, shall be considered in preference to other forms of inductances. It is important in the design of a television receiver, as in a voice receiver, that a small electromagnetic field be created around the coil; that the distributed capacity of the coil be low; and that the ratio of inductance to capacity be high.

The formula for use in the determination of inductance is

$$L = \frac{0.0395 a^2 n^2 K}{b}$$

in which L is the symbol for inductance expressed in

microhenries, a is the radius of the coil, n is the number of turns, b is the length of the winding, and K is the shape factor as determined from prepared tables.

Since preliminary calculations are only approximations, it is sufficiently accurate and easier to calculate if the value 0.0395 is used as 0.04. The formula as stated is for calculations using the metric tables so that the radius and length of the coil are measured in centimeters, and since the measurement is probably taken in inches, the number of inches must be multiplied by 2.54 to convert the dimension in inches to centimeters. The value of K is determined from the value obtained by dividing the diameter (twice the radius) by the length of the coil, and referring to Table IV for the constant for the ratio. The radius of a coil is the distance from the center of the wire to the center of the form, although here again the dimension of the form itself may be used in the first calculations with a more accurate value substituted afterwards for the purpose of obtaining a greater degree of accuracy.

It is necessary that the receiver be designed to cover only those wave lengths devoted to the use of television. However, precautions must be taken to provide the proper values for correct operation within those limits since the success of television reception is as critical if not more so than with voice. Therefore, we must select such values as will be most likely to function together with the greatest efficiency.

A circuit resonant at a given frequency is one in which the inductive reactance is equal to the capacitive reactance. In a tuning circuit such as used in a receiver circuit, the inductance is parallel to the capacity so that at resonance a high resistance to the passage of current at a given frequency is set up and the energy is passed to the grid of the tube.

Reactance is measured in ohms. The formula for inductive reactance is

$$X_L = 2\pi fL \times .001$$

in which X_L is the symbol for inductive reactance in ohms, π is the value 3.1416, f is the symbol for frequency in kilocycles, and L is the symbol for inductance in microhenries.

TABLE III

Calculations of Resonant Circuits

Wave Length Meters	Frequency Kilocycles	LC Value	Wave Length Meters	Frequency Kilocycles	LC Value
50	6,000	.000704	88	3,409	.002180
51	5,880	.000732	89	3,371	.002229
52	5,770	.000761	90	3,333	.002280
53	5,660	.000791	91	3,297	.002331
54	5,560	.000821	92	3,261	.002382
55	5,450	.000851	93	3,226	.002434
56	5,360	.000883	94	3,192	.002487
57	5,260	.000912	95	3,158	.00254
58	5,170	.000947	96	3,125	.00259
59	5,080	.000980	97	3,993	.00265
60	5,000	.001013	98	3,061	.00270
61	4,918	.001047	99	3,030	.00276
62	4,839	.001082	100	3,000	.00281
63	4,762	.001117	101	2,970	.00287
64	4,688	.001153	102	2,941	.00293
65	4,615	.001189	103	2,913	.00299
66	4,546	.001226	104	2,885	.00304
67	4,478	.001263	105	2,857	.00310
68	4,412	.001301	106	2,830	.00316
69	4,348	.001340	107	2,804	.00322
70	4,286	.001379	108	2,778	.00328
71	4,225	.001419	109	2,752	.00334
72	4,167	.001459	110	2,727	.00341
73	4,110	.001500	111	2,703	.00347
74	4,054	.001541	112	2,679	.00353
75	4,000	.001583	113	2,665	.00359
76	3,947	.001626	114	2,632	.00366
77	3,896	.001669	115	2,609	.00372
78	3,846	.001712	116	2,586	.00379
79	3,798	.001757	117	2,564	.00385
80	3,750	.001801	118	2,542	.00392
81	3,704	.001847	119	2,521	.00399
82	3,659	.001892	120	2,500	.00405
83	3,615	.001939	121	2,479	.00412
84	3,571	.001986	122	2,459	.00419
85	3,529	.002034	123	2,439	.00426
86	3,488	.002082	124	2,419	.00433
87	3,448	.002130	125	2,400	.00440

TABLE III (Continued)

Calculations of Resonant Circuits

Wave Length Meters	Frequency Kilocycles	LC Value	Wave Length Meters	Frequency Kilocycles	LC Value
126	2,381	.00447	164	1,829	.00757
127	2,362	.00454	165	1,818	.00766
128	2,344	.00461	166	1,807	.00776
129	2,326	.00468	167	1,796	.00785
130	2,308	.00476	168	1,786	.00794
131	2,290	.00483	169	1,775	.00804
132	2,273	.00490	170	1,765	.00813
133	2,256	.00498	171	1,754	.00823
134	2,239	.00505	172	1,744	.00833
135	2,222	.00513	173	1,734	.00842
136	2,206	.00521	174	1,724	.00852
137	2,190	.00528	175	1,714	.00862
138	2,174	.00536	176	1,705	.00872
139	2,158	.00544	177	1,695	.00882
140	2,143	.00552	178	1,685	.00892
141	2,128	.00560	179	1,676	.00902
142	2,113	.00568	180	1,667	.00912
143	2,098	.00576	181	1,658	.00922
144	2,083	.00584	182	1,648	.00932
145	2,069	.00592	183	1,639	.00943
146	2,055	.00600	184	1,630	.00953
147	2,041	.00608	185	1,622	.00963
148	2,027	.00617	186	1,613	.00974
149	2,013	.00625	187	1,604	.00984
150	2,000	.00633	188	1,596	.00995
151	1,987	.00642	189	1,587	.01005
152	1,974	.00650	190	1,579	.01016
153	1,961	.00659	191	1,571	.01027
154	1,948	.00668	192	1,563	.01038
155	1,936	.00676	193	1,554	.01048
156	1,923	.00685	194	1,546	.01059
157	1,911	.00694	195	1,539	.01070
158	1,899	.00703	196	1,531	.01081
159	1,887	.00712	197	1,523	.01092
160	1,875	.00721	198	1,515	.01103
161	1,863	.00730	199	1,508	.01115
162	1,852	.00739	200	1,500	.01126
163	1,841	.00748			

As an example, to find the inductive reactance of a circuit containing an inductance of 30 microhenries to operate at 2,000 kilocycles, we substitute the values for the symbols in the formula, thus:

$$\begin{aligned} X_L &= 2 \times 3.1416 \times 2000 \times 30 \times .001 \\ &= 377.992 \text{ ohms} \end{aligned}$$

Capacity reactance is also measured in ohms, but the formula is:

$$X_C = \frac{159,154,600}{fC}$$

in which X_C is the symbol for capacity reactance, f the symbol for frequency, and C the symbol for capacity, with the frequency designated in kilocycles and the capacity in micro-microfarads.

An example of the solution of the formula is to find the capacity reactance for a circuit containing capacity having a value of 200 micro-microfarads to function on 2000 kilocycles.

$$\begin{aligned} X_C &= \frac{159,154,600}{2000 \times 200} \\ &= 397.88 \end{aligned}$$

It is not possible in the design of a radio receiving set to keep the values of the reactances equal throughout the entire range of tuning, but at any particular setting they must be equal in order that the circuit may be resonant at that frequency.

The two examples illustrating the working out of the formulas for capacity and inductive reactance show a wide variation between the two values. A circuit which had the values assumed in the two examples would not establish a circuit resonant at 2000 kilocycles, but we can readily find the necessary capacity to function with the inductance.

Let us first select the condenser value for use in the circuit. It is a rule that the value should be smaller than is

used for the broadcast tuners, otherwise the channels will be crowded into a small portion of the condenser. At the same time it is not advisable to use a value that is too low for the reason that the tuning range would be too narrow. A condenser having a capacity of .00025 microfarads or 250 micro-microfarads with proper inductance will provide a tuning range from 90 to 200 meters, which will include the main portion of the television band.

Having selected the .00025 microfarad condenser, we can proceed with the calculations. If we divide .01126, the oscillation constant for 200 meters given in Table III, by .00025, we find that 45.04 microhenries inductance is required. Using the value 45.04 as a guide, multiply that value by .00005, which is the approximate minimum capacity of the .00025 microfarads condenser, and obtain a result, .00225. Reference to Table III shows the minimum wave length obtainable is 90 meters.

Having arrived at certain values, it is possible now to check the determinations to determine more accurately the constants at which the circuit will be resonant. In order to do this we revert to the formulas for inductive and capacity reactance and substitute concrete values.

$$X_L = 2 \times 3.1416 \times 2100 \times 45.04 \times .001 = 594.29$$

$$X_C = 594.29 = \frac{159,154,600}{2100 C}$$

Solving $C = 127$ micro-microfarads

Hence, we find a capacity of 127 micro-microfarads and an inductance of 45.04 microhenries will have an equal reactance at 2100 kilocycles.

Having determined that the condenser selected will function at the desired frequency and having found the value of the inductance, it remains to calculate the number of turns necessary to obtain the correct inductance.

Before making the substitutions for symbols in the formula for determining the inductance, it is necessary that certain physical specifications be arbitrarily adopted so far as the length and diameter of the coil is concerned. In order that space may be conserved, it is usually found advisable to use a small diameter form for the coil. At the same time,

the length of the coil must be such that the diameter-length ratio should be as near one to one as possible.

A $1\frac{1}{4}$ -inch tube is a convenient form for winding an inductance, and the proper ratio between the length and diameter can be easily maintained. Using a form not larger than $1\frac{1}{4}$ inches in diameter permits a one to one ratio without question. By keeping the coil length short, the primary winding may be spread over a wider portion of the secondary winding and give a more nearly equal amplification over a greater span of frequencies. This is true in the case of radio frequency transformers because of the lack of any tangible conductor through which the magnetic field may pass, as compared to the low frequency transformers in which the iron core acts as a path for the electromagnetic field that is set up by the pulsations in the primary circuit. A further expedient in lieu of spreading the primary is to place it at the low potential end of the secondary, spacing the two windings by means of a thin piece of empire cloth (varnished cambric). The latter method is usually found the more practical.

We shall assume, therefore, that the condenser having .00025 microfarads capacity shall be used in conjunction with a coil having an inductance of 45.04 microhenries. Assume also that the coil shall be placed upon a $1\frac{1}{4}$ -inch form and that the length of the winding shall be $1\frac{1}{4}$ inches.

Using the formula for finding inductance

$$L = \frac{.04 a^2 n^2 K}{b}$$

we can substitute the known values for the symbols in the formula and obtain a close approximation for the number of turns required in the coil.

The diameter of the coil being $1\frac{1}{4}$ inches, the radius is $\frac{5}{8}$ inch, which, converted into centimeters is found to be 1.58 (1 inch=2.54 centimeters). Similarly the value of b may be found to be 3.16. The value of K will be found in Table IV as a constant for the relationship between the diameter and the length. In the case of the present problem, the diameter is equal to the length. Consequently, reference to Table IV will show that the value of K will be .6884 for a diameter to the length ratio of 1.00.

TABLE IV

Values for Calculating the Inductance of a Single-layer Coil or Solenoid

Diameter	K	Diameter	K	Diameter	K
Length		Length		Length	
$\frac{za}{b}$		$\frac{za}{b}$		$\frac{za}{b}$	
0.00	1.0000	2.00	0.5255	7.00	0.2584
.05	.9791	2.10	.5137	7.20	.2537
.10	.9588	2.20	.5025	7.40	.2491
.15	.9391	2.30	.4918	7.60	.2448
.20	.9201	2.40	.4816	7.80	.2406
0.25	0.9016	2.50	0.4719	8.00	0.2366
.30	.8838	2.60	.4626	8.50	.2272
.35	.8665	2.70	.4537	9.00	.2185
.40	.8499	2.80	.4452	9.50	.2106
.45	.8337	2.90	.4370	10.00	.2033
0.50	0.8181	3.00	0.4292	10.0	0.2033
.55	.8031	3.10	.4217	11.0	.1903
.60	.7885	3.20	.4145	12.0	.1790
.65	.7745	3.30	.4075	13.0	.1692
.70	.7609	3.40	.4008	14.0	.1605
0.75	0.7478	3.50	0.3944	15.0	0.1527
.80	.7351	3.60	.3882	16.0	.1457
.85	.7228	3.70	.3822	17.0	.1394
.90	.7110	3.80	.3764	18.0	.1336
.95	.6995	3.90	.3708	19.0	.1284
1.00	0.6884	4.00	0.3654	20.0	0.1236
1.05	.6777	4.10	.3602	22.0	.1151
1.10	.6673	4.20	.3551	24.0	.1078
1.15	.6573	4.30	.3502	26.0	.1015
1.20	.6475	4.40	.3455	28.0	.0959
1.25	0.6381	4.50	0.3409	20.0	0.0910
1.30	.6290	4.60	.3364	35.0	.0808
1.35	.6201	4.70	.3321	40.0	.0728
1.40	.6115	4.80	.3279	45.0	.0664
1.45	.6031	4.90	.3238	50.0	.0611
1.50	0.5950	5.00	0.3198	60.0	0.0528
1.55	.5871	5.20	.3122	70.0	.0467
1.60	.5795	5.40	.3050	80.0	.0419
1.65	.5721	5.60	.2981	90.0	.0381
1.70	.5649	5.80	.2916	100.0	.0350
1.75	0.5579	6.00	0.2854
1.80	.5511	6.20	.2795
1.85	.5444	6.40	.2739
1.90	.5379	6.60	.2685
1.95	.5316	6.80	.2633

Substituting, we have

$$45.04 = \frac{.04 \times (1.58)^2 \times n^2}{3.16} .6884$$

Clearing the fraction

$$45.04 \times 3.16 = .04 \times 2.5 \times n^2 \times .6884$$

Calculating

$$.069 n^2 = 2062.75$$

$$n^2 = 142.33$$

$$n = 45.4$$

The size wire to be used can be determined by referring to tables showing the diameter of magnet wire. In this case it is #32 enamel, which wound tightly on a form will measure close to the specifications as determined from the calculations and assumptions.

It should be understood that the value as determined cannot be accurate. The distributed capacity of the coil, which has not been taken into consideration, will change the situation somewhat as will the grid to filament capacity within the vacuum tube used in the stage. However, for purposes of beginning, the above calculation will suffice and from there the changes can be made as determined from experiment.

Detector. Although the conventional type of detector circuit can be used in a television receiver, it is advisable to employ the linear detection system, otherwise known as power detection. The use of the linear detection principle decreases the sensitivity of the receiver somewhat but television is now and quite likely will continue to be more of a localized art instead of adapting itself to DX as has sound broadcasting.

A linear detector is one in which a biasing voltage is applied to the grid of the tube instead of using the grid leak and condenser. The method is also referred to as plate rectification or plate current rectification and depends upon the intensity of the incoming signal to change the value of the charge upon the grid of the detector tube and therefore to vary the amount of plate current.

It is not considered essential that a full discussion of

the principle of linear rectification be incorporated herein. Therefore, examples of the circuits using the method are shown in diagram.

Audio Amplifier. The audio amplifier for use in a television receiver should be of the resistance coupled type in order that there may be a minimum of lag in the operation of the unit. The amplifier must be capable of instantaneously impressing upon the electrodes of the glow tube any changes in the intensity of the current as determined by the reflections of light at the transmitting studio. Furthermore, all parts of the resistance coupled amplifier must be non-inductive.

A resistance coupled circuit is shown in Fig. 55. The reproduction of audio frequencies did not require the care in the selection of values that must be exercised in the design of a unit for use with television, for the higher frequencies must be registered quickly and efficiently devoid of the permissible slurring of the changes in intensity and frequency when audible signals are reproduced.

Voltage drop across the resistor in the plate circuit, the difference in phase across the terminals of the blocking condenser, the provision for allowing excessive grid charges to flow to the grid return, and the grid to filament capacity of the tube enter into the design of a resistance coupled amplifier.

A higher voltage is applied to the plate circuits of the amplifier tubes when resistance coupling is used than when transformer coupling is employed. The value of the potential applied directly to the plate of the tube is determined by the amount of current that flows through the output circuit of the tube, which in turn is dependent upon the charge placed upon the grid of the tube at any given instant.

Resistance Coupled Amplifier. The output circuit for a resistance coupled stage is shown in Fig. 55. The value of the plate resistor is not particularly critical except that it be sufficiently low to permit the application of a potential upon the plate element. A value not to exceed 50,000 ohms is usually provided in the output circuit of each of the stages. 20,000 ohms is common in receivers of recent design.

The coupling condenser and the input circuit for the second stage is shown in Fig. 55 also. In the computation of values for the coupling condenser and the grid leak more care

must be exercised in order that the amplifier may function efficiently and without blocking.

Early resistance coupled amplifiers for voice specified a coupling condenser having a value of .006 microfarads, but later findings on the subject have shown that the value should be higher so that in some amplifiers today a coupling condenser having a value as high as 1.0 or 2.0 microfarads is used. A receiving circuit for television signals does not require the maximum values, however, and capacities varying from .1 to .5 microfarads will be found to function efficiently.

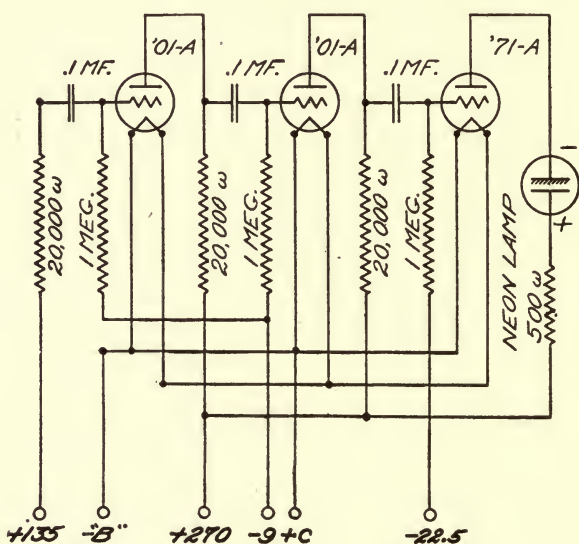

Fig. 55

The reactance of the coupling condenser tends to reduce the value of the coupling resistor in the plate circuit and it is, therefore, advisable that the value of the condenser be high in order that the reactance at the higher frequencies caused by the rapid changes in signal intensity shall not be so high as to impair the action of the coupling resistor. The reactance of a condenser having a capacity of .1 microfarads at 15,000 cycles is slightly over 100 ohms, a negligible quantity when considered in connection with a resistor having 50,000 or even 20,000 ohms.

The value of the coupling condenser must also be considered in connection with the circuit from grid to filament (grid return) in which a high resistance grid leak is in combination with the capacity existing between the grid and filament elements of the tube or, in the case of the alternating-current heater type tubes, the intertube capacity existing between the grid and the cathode. The impedance of that circuit, however, will usually be around a million ohms, so that a condenser having a value of .1 microfarads will function effectively.

The grid leak included in the input circuit is for the purpose of allowing excessive negative charges that accumulate upon the grid to pass to the grid return circuit. The value of the grid leak in a television receiver should be about 1 or 2 megohms.

Output Circuit. The output circuit of the amplifier for a television receiver feeds into the electrodes of a glow lamp, a gas filled vacuum tube containing two electrodes on one of which a glow appears when a sufficiently high electrical voltage is applied. Glow lamps of different sizes require varying output voltages and currents.

The output circuit is shown in diagram in Fig. 55. It will be seen that it compares with the output circuit that was used with earlier models of radio receivers prior to the time when the use of power tubes necessitated the use of a choke coil in the circuit to prevent the burning out of the windings of the loud speaker.

A precaution must be taken, however, in the setting up of the output circuit by way of providing a protective device for the glow lamp. The 500-ohm resistor shown in the diagram is to serve that purpose. The resistor should be of the non-inductive type of the carbon variety, if one capable of passing the required current can be obtained, or if not, then the resistor should be constructed with the wire doubled so as to provide a non-inductive unit.

Power Supply Unit. Except for the high current drain, batteries provide the ideal source of supply for a television receiver because of the lack of complications arising from the introduction of low frequency alternating currents into the receiving circuit. However, since radio receivers have been developed to such a high state of perfection, the matter of

providing the power supply section of the receiver is not so difficult as the problem that was experienced when the device was first adapted to the voice receiver.

The circuit for the unit to provide power for a television receiver is identical with that for voice. The ordinary home television receiver which does not require the use of a high power glow lamp drawing a high current utilizes a full-wave rectifier circuit with a tube of the 280 type acting as the rectifier agent.

Nothing need be said here concerning the power transformer since that coincides in every respect to the power transformer used for voice receivers. The part of the circuit that requires care is the filter circuit, and although there are filter circuits in use in some of the broadcast receivers that would function efficiently with television receivers, for the most part they would be lacking in some of the essentials that make for good television reception and reproduction.

A filter circuit for a voice receiver may not be so efficient that all traces of the alternating current or pulsating direct current that comes from the rectifier tube are removed. At the same time such a filter circuit would function with good results on voice, particularly at such times as the carrier was being modulated, although in the intervening periods between announcements or musical numbers a low rumbling hum might be heard.

In the case of the television receiver a different condition exists. The presence of the hum, as it might be called, would create a pattern upon the television screen and the picture would be fuzzy and irregular. Superfluous lines would play across the picture area and patterns of various forms would be seen.

Therefore, it behooves the designer of a television receiver to devise a filter circuit for the power supply device that will eliminate as much of the alternating current as possible. The way in which the problem is solved is to provide a combination of choke coils and condensers that will give the proper filtering action. The whole thing resolves itself into designing a low pass filter that will cut off all frequencies that may be visible on the glow lamp.

The natural assumption would be that the ideal way in which to eliminate the 60-cycle alternating current would be

to design a trap that would definitely smooth out a 60-cycle or 120-cycle ripple. But it has been found that in practice the use of a low-pass filter serves the purpose just as well and perhaps better than a 60- or 120-cycle trap.

Consequently, if two choke coils each having an inductance of 30 henries be used in combination with filter condensers having capacity values of 2, 4, and 8 microfarads the cut off frequency will be below the fundamental of the power frequency and the effect of the alternating-current supply will be eliminated.

Another method that is found better from practice is to use a higher capacity condenser, such as an electrolytic, in place of the one specified as an 8-microfarad unit. The extremely high capacity at this point will prove valuable in that it provides a tank circuit in addition to acting as a portion of the low pass filter circuit, and also serves as a leak or bleeder.

The choke coils for use with the television power unit correspond to those used for voice receiver devices. The core must be provided with an air gap that prevents the direct current passing through the windings from saturating the core and thereby lowering the inductance of the choke coil which would lower its efficiency in retarding the flow of alternating current.

CHAPTER XI

MOTORS

It is necessary to maintain absolute synchronization between the rotation of the scanning device at the receiver with that at the transmitter. The method by which such synchronization can be obtained mechanically varies somewhat, but fundamentally the principles involved are the same.

The use of a variable speed motor is not recommended under any circumstances unless there is some form of compensation in the form of synchronous control that will hold the motor at the proper speed to insure keeping the picture always in frame. Experience with motors of the ordinary type, commonly called universal have demonstrated that there can be no guarantee that the motor will maintain its speed even though the adjustment might be made ever so carefully.

Synchronous motors provide the most effective method for keeping the receiver scanning devices in step with those at the transmitter, but in order for the condition to be assured, it is essential that the motors be connected to lines of the same system, otherwise a slight difference in the frequency will manifest itself by allowing the picture to slide out of frame. However, it is significant that power supply systems covering wide areas are tied together so that the frequency of the alternating-current supply, controlled from a single point, is constant throughout the entire system. The "tying in" of the systems has been done from an economical standpoint to remove the necessity for smaller communities and smaller cities spending considerable sums of money for duplicate generating apparatus to insure continuous service to patrons.

A synchronous motor is one in which the frequency of the alternations is the determining factor in the speed of rotation and the relative position of the rotor with respect to the stator at any given time.

Motor Principles. It should be pointed out that inasmuch as direct current does not lend itself in any manner to synchronization, we shall only consider motors that function on alternating-current systems.

An electric motor depends upon the magnetic properties of electricity to move certain portions of the machine making use of a natural phenomenon, the attraction of unlike charges on the one hand and the repulsion of like charges on the other.

If a wire connected to a galvanometer is passed before the end of a bar magnet, the needle of the meter will move, indicating that current is flowing through the circuit. Furthermore, it will be found that if the wire passes the magnet in the opposite direction, that is, upward, the needle of the meter will move in the opposite direction showing not only that there is current flowing through the circuit, but that it reverses its direction of flow because of being passed by the magnet in the opposite direction.

Herein lies the fundamental principle embodied in the generation of electric current. In the rotation of generators in the mammoth power plants of the world, the rotating parts are carrying coils of wire through magnetic fields and establishing electric currents, commercial applications of the elementary principle to which reference has been made.

So far as the motor is concerned its operation is a reversal of the procedure, and the electric current delivered to the motor windings sets up magnetic fields that draw unlike magnetic fields toward them and repel fields of like polarity so that the rotor turns. The speed of rotation of any motor is dependent upon the arrangement by which the varying magnetic fields are set up in such a relationship as to cause rotation. There are two portions of a magnet; one end is called the north pole and the other the south pole. These two magnet ends are referred to in generators and in motors as the *poles* and constitute the points which determine the relationship existing between the stator and the rotor coils and magnets.

Electric current that reverses in its direction of flow through its conductor is said to be alternating. It starts on its path from zero potential, rises to a maximum value with a positive polarity, returns to zero, proceeds until it attains a maximum value negatively and then again returns to zero, as shown diagrammatically in Fig. 56. The completion of the two reversals constitutes what is known as a cycle and is referred to according to the number of cycles that are completed during a second of time. Standard practice in the United States calls for the use of 60-cycle alternating current, which

means that the current flows sixty times in one direction and sixty times in the other each second. There are districts, however, where 60-cycle alternating current is not available, and in such places it is usually found that the standard is 25-cycle, the reversals as shown taking place twenty-five times per second. Sixty-cycle alternating current is here considered.

When a current flowing in one direction is passed through a coil of wire which surrounds an iron bar, a magnetic field is established and transmitted to the bar, making what is known as an electromagnet. If the current were passed through the coil in the opposite direction, the polarity of the poles of the magnet would reverse. In the one case, if the bar were magnetized so that a north pole was effected, it would attract the south pole of another magnet. In the latter case, the current being reversed, what had been the north pole would become a

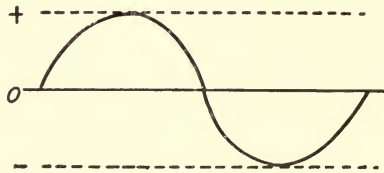

Fig. 56

south pole, and the south pole of another magnet would be repelled. Thus, it is seen that if the current passing through the coil flows first in one direction and then in the other, as does alternating current, the pole of the electromagnet changes its characteristics according to the number of pulsations in the supply.

The ordinary motor used in the household is usually what is known as a "universal" motor and can be used on either alternating- or direct-current systems. The electric energy is supplied to it directly through brushes that make contact with metallic terminals on a part of the rotor called the commutator. Larger motors do not employ the commutator but depend upon the magnetic attraction and repulsion between the stator and the rotor to turn the rotating part.

Synchronous Motors. The subject of synchronous motors shall be divided into three parts. First, a brief statement embodying all synchronous devices, second, a description

of a synchronous motor developed especially for television, and third, a synchronously controlled motor.

If two alternating-current generators are caused to run at the same speed and in such a manner that the voltage rises from zero to maximum positive, thence to maximum negative and again to zero at exactly the same time, and so that the current flows in the same direction from both machines at the same time, one of them will run off the power generated by the other and keep running at the same speed without the aid of outside driving forces. The driving force in this case is the alternating electric energy passing between the two machines which sets up in the driven machine magnetic fields that attract and repel in accordance with the impulses.

A generator running with the same speed and holding the same relationship between the rotor and the stator as one which is generating power is said to be running in synchronism with the driver. Consequently, a synchronous motor can be referred to as a generator running as a motor.

One point should be emphasized, however. Note that the generator in the description above was running synchronously with the driving generator. If the driven generator had not been running at the time the power was turned on, the rotor would have turned only to that position where the poles centered with the opposing poles and would have stopped. A separate winding is required to start a synchronous motor, but once it has attained the speed determined by the frequency of the current and the number of poles, it will maintain that speed so long as the frequency remains unchanged.

The speed attained by a synchronous motor is dependent upon the frequency of the current and the number of poles. Expressed in formula form

$$V = \frac{60 f}{P}$$

in which V is the velocity of the motor in revolutions per minute, f is the frequency of the alternations, and P is the number of pairs of poles. Attention is called to the fact that P refers to pairs of poles, not to individual poles.

It is commonly known that an ordinary synchronous motor will not actually maintain the speed as determined from the above formula, due to what is known as *slip*, caused by losses

in the windings on the motor. A motor for television purposes, however, must be one in which the slip is eliminated, a characteristic that can be attained in small motors but which would be very difficult in motors of the larger sizes.

By way of citing examples of the formula given above, assume that a motor with a single pair of poles is to operate synchronously on a 60-cycle alternating-current source of supply. Substituting values, we have

$$V = \frac{60 \times 60}{1} = 3,600 \text{ revolutions per minute}$$

If there had been four pairs of poles, the values would have been

$$V = \frac{60 \times 60}{4} = 900 \text{ revolutions per minute}$$

The rotor of a motor designed to run synchronously is constructed of soft iron from which at regular intervals the metal has been cut away so that the form is that of an unfinished gear. With such an arrangement, it will be seen that as the rotor turns between two pole pieces, the metal will be alternately in close proximity and at a greater distance from the poles, and that the magnetic flux will act readily upon the projections but not upon the slots between the projections.

If, then, an alternating current of a given frequency is passed through the coil on one leg of the iron core of which the pole pieces constitute a part, the magnetic flux around the pole pieces will be alternately of one polarity and then the other, or, in other words, will alternately attract and repel a magnetic substance.

Fig. 57 (a) shows in diagram the arrangement of one form of synchronous motor, the kind that is employed in electric clocks. The projections on the gear-like wheel lie in the stronger magnetic field and naturally are reacted upon by the variations in the flow of the flux.

It will be seen that if the wheel were given a turn in either direction, the pulsations of the current would set up magnetic influences that would first draw and then repel the projections, causing the rotor to turn in accordance with the changes in the flow of current through the coil.

However, unless some means is provided to counteract the tendency of the motor to "slip," it will not maintain a steady speed but will move faster or slower according to the load that is placed upon it. Electric-clock motors have been designed to provide a frictional compensator to prevent the unsteady movement, commonly known as "hunting." Then,

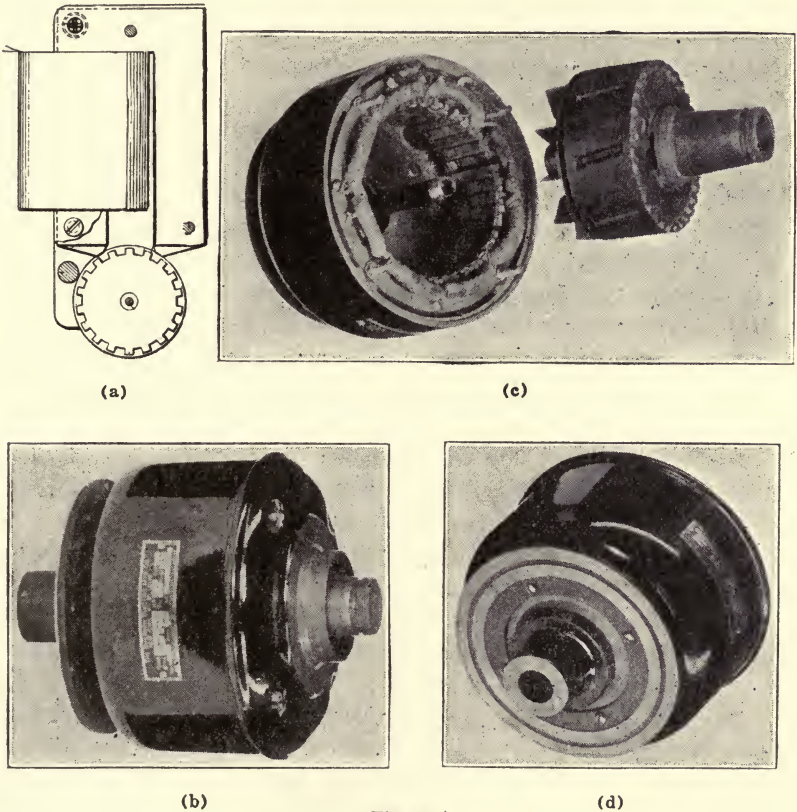

Fig. 57

too, the rotation of the rotor without some form of compensation might easily cause the device to "get out of step" so that the projections do not come within a given position at the correct time. If such were true, the rotor would either "hunt" its position or, as sometimes happens, cause the motor to stop suddenly. As a synchronous motor of the type shown is started manually, it would not run until started again.

The segments (teeth) of the rotor of a synchronous motor change polarity in accordance with the changes in the pole pieces. Thus when the flux flows through the core of the motor in Fig. 57 (a) so that the pole at the right is *north*, the one at the left will be *south* and the tooth that is nearest the north pole will assume the magnetic properties of a south pole, and, vice versa, the tooth nearest the south pole will become a north pole. Then, as the flux reverses its flow and the poles pieces become south and north (right and left, respectively), the teeth also change and become north and south. Once the rotor has been set in motion, however, it gains sufficient momentum while the teeth are being drawn into position by the attracting powers of the pole pieces to cause it to slip past the center position and allow the next pair of projections to be acted upon by the magnetic force.

If a motor for television were not designed properly, that is, if it were not designed to prevent "hunting," the picture would be constantly moving from one side of the area to the other, giving a swing that would be objectionable.

Western Television Corporation Synchronous Motor. The motor used by the Western Television Corporation to rotate the scanning disc at the transmitter or the receiver was designed especially to eliminate "hunting" and to provide an easy method of framing the picture.

Although the design of the motor shown in Fig. 57 (b) utilizes the same fundamental principles as the motor in Fig. 57 (a) there are certain variations in the physical construction that provide steadiness in the operation and keep the picture definitely in the position to which it is adjusted.

Fig. 57 (c) shows the rotor withdrawn from the stator of the motor, exposing the internal construction of the stator and showing the method of forming the rotor. Take note of the fact that the rotor is solid except for slots cut into the metal at regular intervals, and that the slots instead of being cut straight across the rotor are placed at an angle. The angular position of the slot enables the rotor to effectually "slip" into position, eliminating the abrupt motion that would tend to cause the rotor to stop or pass into the next position. The relationship existing between the width of the slots and the remaining portion of the rotor provides greater surface for the action of the magnetic forces.

The rotor consists of a laminated iron core around which, welded into position to a copper disc on either side of the laminations, are copper bars that have been turned down to form a cylinder. The currents generated in the stator windings are induced into the cross bars, setting up the magnetic flux that draws the rotor into position with respect to the magnetic field of the stator. Current flows in the cross bars only when there is a difference in speed between the rotation of the rotor and the effective rotating magnetic field. The current which exists at such times creates a magnetic resistance to "hunting" and keeps the rotor in absolute synchronism.

Close examination of the windings on the stator of the motor would reveal that there are two sets of windings, but that both sets are interlocked. The stator windings are divided into eight groups, each group containing one of each of the two interlocked windings. The two coils in each section are wound in the same direction so that all the pole pieces in a given section have the same polarity. However, the coils in adjacent sections are reversed, so that adjacent sections are reversed in polarity, giving alternately a north pole and a south pole around the stator structure. Since there are eight sections, it is evident that there are four pairs of poles.

If the rotor is set into the stator and connections made to the windings, the rotor will not turn unless it is started manually, but it will take very definite positions with respect to the stator.

If the position of the slots on the rotor be marked before turning on the current, observations to determine the action can be made. The rotor will adjust itself definitely with respect to the sets of coils. It will also be found that there will be two positions on each side of center at which the rotor will not be so rigidly fixed, a condition that is easily analyzed. If we assume that the slots in the rotor coincide with the stator sections to begin with, it will be seen readily that the entire surface is being acted upon magnetically so that there is a definite attraction at all poles. But, if the rotor is moved the width of one of the coil slots in the stator, the surface of the rotor section is divided so that a part of the surface between the rotor slots is being attracted but a smaller part is being repelled by the adjacent pole. Consequently, the rotor can be turned with greater ease, even though it does have well-

defined steps. When it reaches a position where the attraction and repulsion is equalized, it will again be found to have greater resistance to movement.

The matter of facilitating the framing of the picture is a very simple procedure with the motor being described. Fig. 57 (d) shows the front end of the motor, that is, the end that is mounted so that it is at the front of the cabinet. Note that there are two concentric brass rings. When the motor is mounted in position, contact fingers bear against the two rings and constitute the connection with the alternating-current source of supply. Also, in the extreme end of the motorhousing there are three holes which provide the facilities for mounting the framing adjustment.

Since the framing of the picture is nothing more than adjusting the disc at the receiver with the one at the transmitter, and since, as it has been shown, the rotor of the motor rotates in a definite relationship with the stator, it is evident that by changing the position of the stator, the relative position of the rotor will also be changed, and, incidentally, the position of the disc will be changed.

Therefore, if a condition such as that depicted in Fig. 47 exists, it is only necessary to rotate the stator of the motor in one direction or the other until the proper position is obtained. The adjustment on the receivers made by Western Television Corporation is in the form of a nautical steering wheel.

Automatic Synchronization. Automatic synchronization embodies the same principles that have been explained in the discussion of synchronous motors, except that instead of using a synchronous motor to rotate the disc, any other type of motor that can be regulated readily is employed and a synchronous motor, operated on the audio signal developed in a television studio, controls the speed and position of the rotor of the driving motor. The results obtained by automatic synchronization have been fair, but do not compare with those obtained when synchronous motors are used exclusively.

CHAPTER XII

ELECTRICAL SCANNING

Electrical scanning and cathode ray television are synonymous. Both terms refer to the use of a controlled electronic stream for breaking a picture area into its component parts for transmission or reception.

It has been shown that if a sufficiently high potential were applied to two electrodes placed within a glass envelope from which the air had been exhausted and into which a quantity of gas had been introduced, a glow would appear on that electrode which emitted electrical charges called electrons. The principles underlying the operation of a glow tube are identical with those of the cathode ray tube, which constitutes the basis for electrical scanning.

Crookes Tube. The history of the cathode ray tube goes back to the early part of the nineteenth century when Sir William Crookes, an English chemist, conducted experiments with potentials applied to electrodes in vacuum tubes. His experiments resulted in the discovery of the electron and paved the way for the development of the tubes of the present day in which an electronic stream emitted by one of the electrodes casts a beam upon a special screen that enables the eye to perceive certain effects that are produced.

The phenomenon is shown graphically in Fig. 58 (a), which is a form of the Crookes tube with the cathode and the anode as indicated. When a potential difference reaches the proper value, the cathode, a negatively charged electrode, gives off particles that are attracted by the anode upon which there is a positive charge. The electronic stream is said to have no weight and no inertia so that the energy required to control it is negligible. Furthermore, there is no limit to the speed with which it can be controlled other than the limits of the controlling devices or circuits.

The designation of the stream of electrons as cathode rays was made some years after the discovery by Crookes, and the nomenclature was evolved from the fact that the electrons were emitted by the cathode.

The stream of electrons emitted by the cathode of a tube such as the Crookes cell can be deflected in any direction desired by means of an electric field. The deflection of the stream is shown in Fig. 58 (b), in which a tube of the same type as that shown in Fig. 58 (a) is used for demonstration purposes. An ordinary bar magnet placed along side the tube, as shown, will draw the stream to it. Had it been reversed end for end, the stream would have been deflected downward, repelled by the magnetic field.

An electrostatic field may also be utilized for deflecting the electronic stream, and, in fact, such an arrangement is used, in effect, in those tubes that are used for television reproduction. In other words, if two plates were placed on either side of the electronic stream, as shown in Fig. 58 (c), and a positive charge were placed on the upper one with a negative charge on the lower plate, the stream of electrons

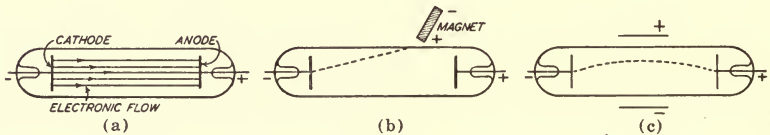

Fig. 58

would be deflected from the negative plate toward the positively charged one, and the amount of deflection would depend upon the charge on the plates.

Then, too, a solenoid coil could be placed alongside the tube to obtain the same reaction, so that when the current flowed through the coil in one direction the stream would be deflected in one direction; and if the current were reversed in its direction of flow, the electronic stream would be deflected in the opposite direction.

Braun Tube. The tube about which the television developments center is that known as the Braun tube, which is shown diagrammatically in Fig. 59. The Braun tube is merely an improved form of the Crookes tube, the improvements being of such a nature as to provide greater efficiency and greater flexibility.

Television reproduction demands a high degree of brilliance, and, as in the case of the development of glow lamps, so with the cathode ray tubes, it has been found that the hot

cathode type of cell will provide a greater flow of electrons with a corresponding increase in brilliance. Consequently, referring to the diagram, Fig. 60, attention is called to the filament type cathode, which is similar to that found in ordinary electronic devices in which a flow of electrons is

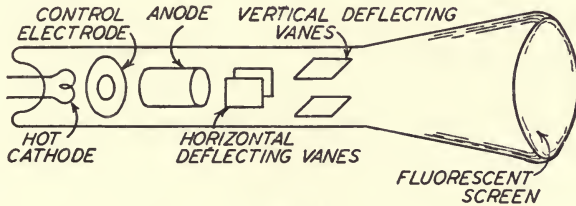

Fig. 59

created by the application of heat caused by the passage of an electric current through a filament element.

The electron emitting element is called the cathode, as shown. Near it is a metal disc, solid except for an aperture through the center through which the electrons flow on their way to the anode. The disc acts in a capacity similar to the grid of an ordinary vacuum tube and serves further to permit the passage of a thin stream of the electrons, returning those which strike the metal itself to the filament. In this way those electrons which pass through the center of the disc are the only ones that pass to the anode, which is the metal cylinder to the right of the control electrode.

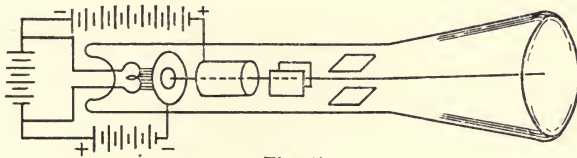

Fig. 60

The potential difference existing between the anode and the cathode of the Braun tube is extremely high so that the electrons gain an enormous speed. They continue through the anode between the first pair of plates, shown in Fig. 59 as the horizontal deflecting vanes. If there is no charge upon the horizontal deflecting vanes, the stream continues unde-

viated and passes between the second pair of plates, designated as the vertical deflecting vanes. Here, again, if there is no charge on the plates or vanes, the stream continues to flow undeflected to the end of the glass tube.

The end of the tube is specially treated to make it fluorescent; so that the spot where the electronic stream strikes the glass will be illuminated to render it visible to human vision. A chemical mixture of calcium, tungsten, and zinc silicate will cause fluorescence. If there are no charges upon the deflecting vanes, the stream of electrons will strike directly in the center of the fluorescent screen and will be manifested as a point of light of extreme intensity.

Let us assume now that a slight difference of potential is applied across the horizontal deflecting vanes, and that the current which is thus applied be alternating. When one of

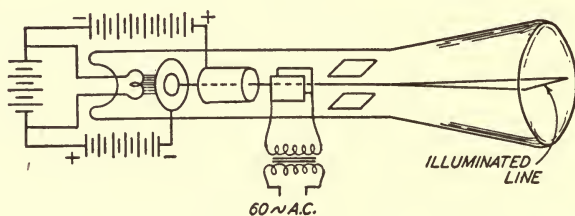

Fig. 61

the vanes is charged positively, the other will be negative so that the electronic stream will be deflected toward the vane which has the positive charge. When the direction of flow of the current reverses and the vane that was formerly charged negatively takes a positive charge, the stream of electrons will move toward the other vane, and so on. If the alternations are impressed fast enough, the illumination on the fluorescent screen will appear as a line.

Fig. 61 illustrates another condition. The cathode is connected to a source of electrical energy, a negative potential is applied to the control electrode, and the anode is charged positively. Since the horizontal deflecting vanes are connected to the opposite terminals of an alternating-current source of supply, the electronic stream is alternately drawn toward one and then the other of the vanes as the direction of flow changes in the circuit. On account of the fluorescence of the screen

on the end of the tube, the stream causes a line to appear thereon. If, however, the frequency of the alternations was slower, so slow, in fact, that the eye could follow the movement, the illumination would appear as a spot of light moving from side to side.

If the source of alternating current is disconnected from the pair of horizontal deflecting vanes and connected to the

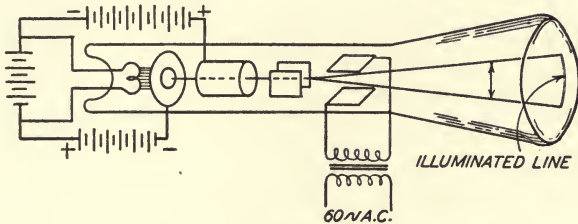

Fig. 62

vertical deflecting vanes, as shown in Fig. 62, the illuminated line on the fluorescent screen will be vertical and, again, if the frequency of the alternations were slow enough for the eye to follow, the illumination would appear as a spot of light moving vertically on the screen.

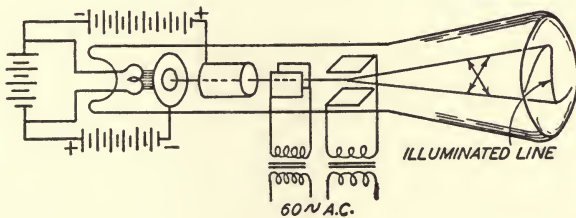

Fig. 63

Thus, it is seen that the stream of electrons is deflected in accordance with the nature of the charge on the deflecting vanes and may be moved either upward, downward, or from side to side. It is evident then that if a charge is placed upon both sets of vanes, the stream may be directed to other positions on the fluorescent screen.

Fig. 63 shows the Braun tube with an alternating-current source of supply connected to both the horizontal and the

vertical deflecting vanes. The result will be as shown on the end of the tube, and if the alternating current is pure, that is, true alternations with respect to time, a true *sine wave* will appear on the screen. The set-up as shown in Fig. 63 is that for an oscillograph in which the characteristics of alternating currents may be studied with facility and accuracy.

The principles involved in the use of the Braun tube for television reproduction are identical with those involved in the study of alternating currents. The difference lies in the speed with which the stream of electrons is deflected either horizontally or vertically.

It has been shown how the scanning operation is effected mechanically and that it is necessary to project approximately sixteen complete pictures per second in order that the eye may see the reproduction on a fully illuminated screen. It has also been shown that according to calculations the width of the band required for the transmission of television increases as the speed of scanning increases and that it is essential that the width of the channel be as narrow as possible. Therefore, arrangements must be provided for scanning at speeds approximating those used in mechanical scanning, varying from 45 lines per picture area at 15 pictures per second to 120 lines per picture area at 24 pictures per second.

For purposes of illustration, we shall select arbitrarily a set of values, 60 lines at 20 pictures per second. We shall assume also that the lines shall pass the screen horizontally, as is customary in most television receivers of the present day.

Since the picture area is to be divided into 60 parts vertically, the lines running horizontally, it is evident that the pencil of light caused by the electronic stream striking the fluorescent screen must cross the area 60 times for each picture and since there are 20 pictures per second, there will be 20 times 60, or 1,200 lines of light from one side of the area to the other each second of time.

However, since a cycle of alternating current consists of two alternations in which the current flows from the maximum in one direction to the maximum in the other and then back again, the frequency in cycles per second will be half the number of lines of light that are desired. Since, then, 1,200 lines of light are required, a 600-cycle alternating current applied to the horizontal deflecting vanes will cause the stream

of electrons to move across the picture area 1,200 times in one second.

It is necessary now that provision be made to cause the pencil of light to move vertically, otherwise the illumination would be confined to a single line across the center of the screen. The accomplishment of the vertical movement is a little more difficult because it is essential that the movement in one direction be gradual and in the other direction abrupt, so that the result obtained by the rotation of a scanning disc of the mechanical type will be obtained.

Therefore, it is found expedient to use a circuit involving a vacuum tube which charges a condenser and connect the circuit to the vertical deflecting vanes. With such an arrangement the charge on the deflecting vane increases gradually as the condenser becomes charged, and then falls almost instan-

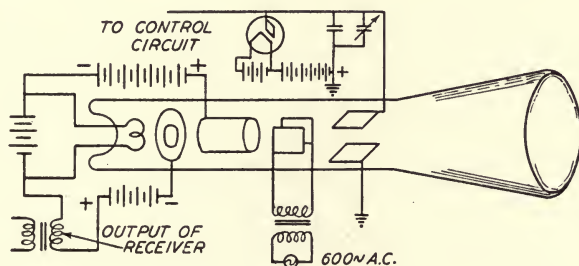

Fig. 64

taneously when the condenser is discharged. The circuit referred to is used more or less extensively in vacuum tube relay devices and is shown graphically in Fig. 64.

The frequency with which the condenser charges and discharges is determined largely by the value of the condenser itself, so that it is customary to employ a pair of condensers in shunt, one of which is fixed, and the other variable, to provide a means for adjusting the frequency to the proper value.

The intensity of the illumination is dependent upon the number of electrons in the stream that passes through the anode to the fluorescent screen, and the control electrode constitutes the means for regulation in the same manner as the grid of a vacuum tube controls the number of electrons that pass between the cathode and the plate element.

Since the control electrode is negatively charged, it is evident that it permits the passage of an electronic stream of a certain intensity; and that if the value of the negative charge were increased, more electrons would be returned to the filament; while if the value of the negative charge were decreased, more electrons would be permitted to pass through. Consequently, if the output of a television receiver is connected into the control electrode circuit as shown in Fig. 64, each of the variations in signal strength will change the value of the bias and will vary the intensity of the electronic stream accordingly. Such change will be registered upon the fluorescent screen in greater or lesser degrees of illumination according to the changes in the value of the charge upon the control electrode.

Here, then, is the foundation for the use of the cathode ray tube in television reproduction. It remains to provide a means for synchronizing the signal at the receiving station with that at the transmitter.

The matter resolves itself into a periodic correction of any discrepancies which might occur. The transmitter provides a signal so that the condenser at the receiving device is discharged at the proper time and the charging of the capacitor always begins in a definite relationship with a specific operation at the transmitter. If it is found that the correction is too great, the value of the condenser can be changed to bring about synchronous action so that the framing of the reproduction will conform to the transmitting area.

Zworykin System. Cathode ray scanning lends itself to the use of moving picture films in television in a system developed by V. K. Zworykin. The Zworykin system was patented in the United States on December 30, 1930, and assigned to the Westinghouse Electric and Manufacturing Company.

There is a source of illumination which is directed upon a mirror which vibrates horizontally in accordance with pulsations set up by an alternator. A concentrated ray of light is reflected through the film to the photoelectric cell which is connected to the transmitter.

The movement mechanism is provided with an extension which constitutes a cam-operated switch that determines the synchronization as described above, and the projections on

the cam cause a switch to close when the beam of light from the mirror is midway between the individual pictures that make up the film. The closing of the switch in the Zworykin system makes a direct connection with the receiver devices, but it can be arranged so that the signal can be transmitted by wireless and without the interconnecting wires.

The output of the receiver is connected through a transformer to the control electrode so that the pulsations cause a change in the value of the bias. A circuit such as shown in Fig. 64 comprising a rectifier tube and condensers constitute the means for moving the scanning beam vertically, by permitting a gradual build-up of the charge with an abrupt discharge at a given time.

Also the alternator which serves to vibrate the mirror is connected directly through to the horizontal deflecting vanes, but, this too, can be controlled without the use of wires and the signal can be transmitted from the antenna of a television transmitting station.

Recent developments in cathode ray tubes have had to do with the fluorescent screen in an effort to provide a retention of the illumination and thereby provide a greater apparent intensity of illumination.

On account of the nature of the rays of light radiated by the cathode ray tubes, it is necessary that provision be made to project the reproduction to a screen as a protection to the eyes. Cathode rays are similar in many respects to X-rays and if they are allowed to penetrate the eye in quantities, they will prove detrimental to the visual organs.

APPENDIX

Certain matters that pertain to television and which are not included in the foregoing pages because of their lack of definite relationship with the text are given herewith.

Lack of Distortion. There is a noticeable lack of distortion when television pictures on a screen are viewed at a wide angle. The fact that the photoelectric cells in the studio are placed in such a way as to create a stereopticon effect is responsible for the phenomenon. The television picture, using the present-day studio methods, actually has length, breadth, and depth. Therefore, the figures on the screen do not become narrowed and elongated regardless of the angle from which they are seen.

Excess Shadows. The opinion that regeneration in the circuits is the cause of excessive shadows that appear in television is not universal. On the other hand, experiments in the television laboratories of Chicago have shown that regeneration aids in the handling of the television signals and that the shadows are created because of a lack of low frequency response in the amplifying equipment.

Size of Screen for the Home. There has been a constant undercurrent of demand for a large size screen for home television, but those who make the demand have not made an analysis of the situation. It is customary to refer to the screens such as are used in the moving picture theaters. In order to have a television picture of that size, it would be necessary that the most forward position be approximately forty feet from the screen. Few homes provide such space requirements. A screen of the size usually employed for home moving pictures is, in reality, too large, and those who have home movie apparatus usually find greater success by reducing greatly the size of the picture on the screen.

Therefore, it is logical to state that the screen for home television should not be larger than two feet square, and it is probable that a screen of smaller dimensions will be found even more desirable.

INDEX

INDEX

	Page		Page
A			
Amplification	107	Crater lamp	5, 69
Amplifier	141	Crookes tube	155
Angle of deviation	19	Curved mirrors	27
Angle of incidence	17, 19	D	
Angle of refraction	19	Diffraction	15
Appendix	164	Direct pick-up	104
Audio amplifier	141	Disc	82
Automatic synchronization	154	E	
B			
Braun tube	156	Electrical scanning	5, 155
C			
Candlepower	61	Braun tube	156
Cathode ray scanning	162	Crookes tube	155
Center of curvature	27	Zworykin system	162
Combining scanning with as-		Electromagnetic theory of light	14
sociated equipment	97	Electron	64
amplification	107	Elliptical reflector	32
constructing the picture	112	Ether	13
combining scanning with		Eveready-Raytheon Kino lamp	66
photoelectric cells	99	Excess shadows	164
direct pick-up	104	F	
fading panel	108	Facsimile transmission—Tele-	
framing the multiple-spiral		vision in slow motion	71
disc	116	Fading panel	108
framing the picture	115	Flicker	95
head amplifier	107	Focal length of lens	39, 41
line amplifier	108	G	
microvisor	97	Gas molecules	64
moving picture films and		Glow lamp circuits	66
television	120	Glow lamps	61
receiving the picture	110	Grid return circuit	143
receiving the signal	110	H	
synchronizing sight with		Head amplifier	107
sound	117	Hot cathode type of lamp	69
television technique	118	I	
Concave mirror	27	Infra-red rays	14
Conjugate foci	39, 42	Ion	64
Convex mirror	28	Isynchronism	76

	Page		Page
Receiving circuits (continued)		Television	
power supply unit	143	appendix	164
receiving apparatus	129	combining scanning with as-	
receiving set	129	sociated equipment	97
resistance coupled amplifier	141	electrical scanning	5, 155
tuner unit	132	facsimile transmission—tele-	
Reception of signals	2	vision in slow motion	71
Reflection	16	history	6
Refraction	17, 32	mechanical scanning	4
Reproducing devices	3, 61	motors	146
circuit explanations	67	optics	21
glow lamp circuits	66	photoelectric cell	1
glow lamps	61	photoelectricity	51
neon cell	65	principles of light	13
operating voltage	66	receiving circuits	129
other types of cells	68	reception of signals	2
requirements imposed on		reproducing devices	3, 61
glow lamps	63	television scanning devices	80
sensitivity of the neon cell	65	transmission of signals	2
simple cell	62	Television scanning devices	80
theory of glow lamps	63	disc	82
tube failures	68	different forms of disc	89
Retention of vision	80	mechanical scanning	81
		receiver	85
		reflection through holes in	
		disc	89
		speed of rotation of scanning	
		disc	87
		synchronization	93
		Television studio technique	118
		Televisor	5
		Transmission of signals	2
		Tube failures	68
		Tuner unit	132
		U	
		Ultra-violet rays	15
		V	
		Virtual image	17
		Visual telegraphy	6
		W	
		Watson disc	82
		Western Television Corporation	
		synchronous motors	152
		Z	
		Zworykin system	162

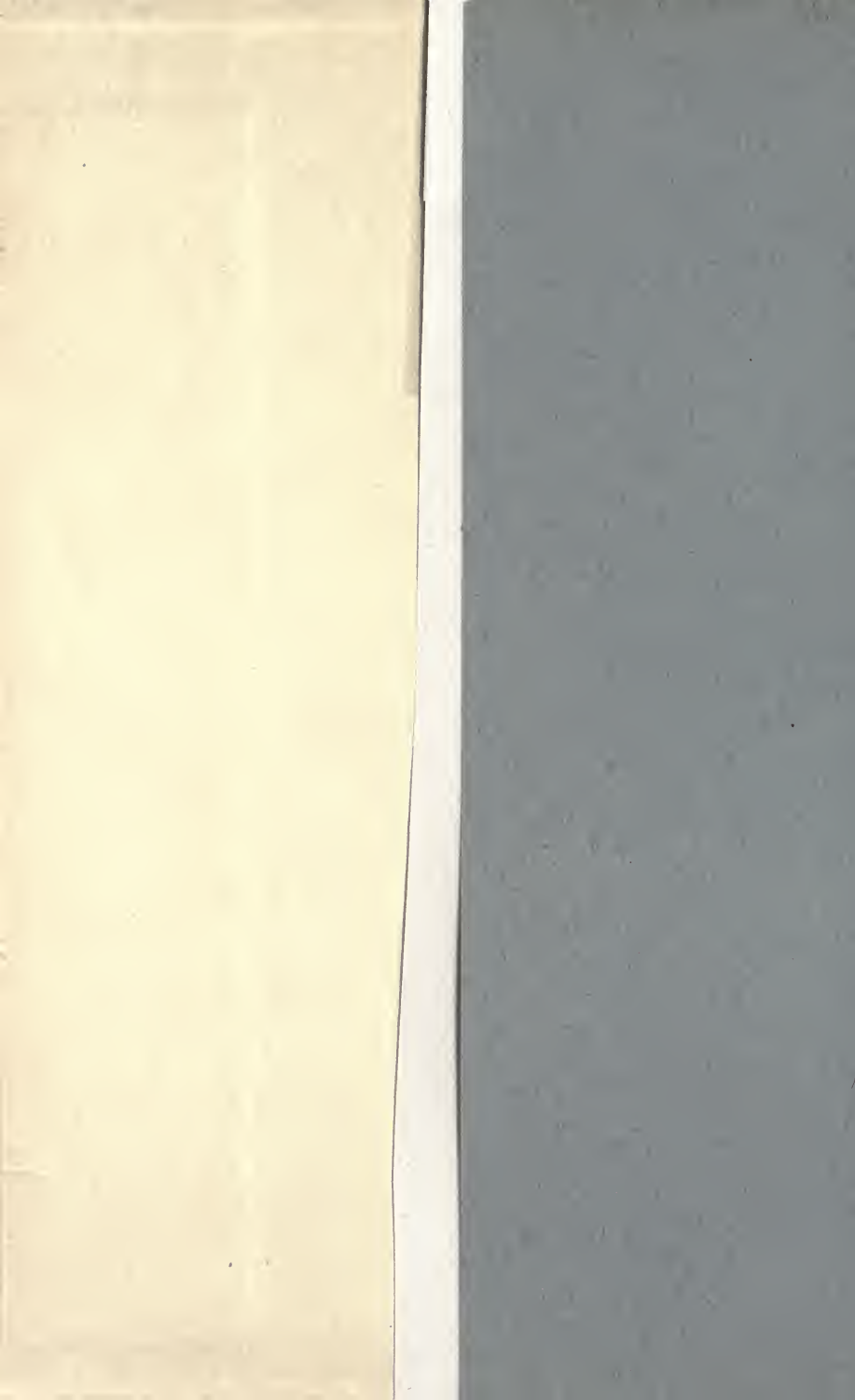

Practical Books

for

Home Study and Classroom Use

AVIATION ENGINES: Kuns. 202 pp. Cloth binding. Every page new! Deals with the latest type of aeroplane motors, including air cooled, etc.

BRIDGE ENGINEERING: Dufour-Schantz. 375 pp., 255 illus. Cloth binding. A new book devoted to practical instruction in the analysis, calculation and design of steel truss and girder bridges for railroads and highways.

A. C. RADIO GUIDE: Hathaway. 117 pp. Cloth binding. A new practical book dealing exclusively with the alternating and direct current sets, A. C. tubes, dynamic speakers, etc.

CONCRETE DESIGN AND CONSTRUCTION: Webb-Gibson. 388 pp., 201 illus. Cloth binding. Just published. Deals with all phases of concrete work including mixtures, testing, beam and slab design, construction work, etc.

MACHINE DRAWING: Griffin-Fortman. 282 pp. Cloth binding. Just rewritten and revised. Presents latest information on cams, pulleys, gears, helix and thread conventions, etc.

SHEET METAL WORK: Neubecker. 267 pp. Cloth binding. A manual of instruction in the art of pattern drafting and construction of all types of sheet metal work.

TELEPHONY: McMeen-Miller. 952 pp. Flexible binding. Unquestionably the finest and most complete book published on the subject. Particular attention is given to developments in automatic systems.

PATTERN MAKING: Ritchey-Monroe-Beese-Hall. 223 pp. Cloth binding. Rewritten and revised edition just off the press. Deals with the subject from every angle and in a very clear manner.

STORAGE BATTERIES: Crocker-Arendt-Kuns. 130 pp. Cloth binding. A thoroughly revised book containing complete data on repair and building of batteries including the Edison type.

FORGING: Bacon-Johnson. 113 pp. Cloth binding. Entirely revised! A very clear treatise on all phases of forging.

MECHANICAL DRAWING: Kenison-Waite-McKinney. 205 pp. Cloth binding. A valuable work for instruction in drafting, lettering and reproducing plans and working drawings.

FOUNDRY WORK: Stimpson-Gray-Grennan. 200 pp. Cloth binding. An entirely new and rewritten book and standard foundry practice in all its phases.

MATHEMATICS, PRACTICAL: Hobbs-MacLennan-McKinney. 448 pp. Cloth binding. An entirely new and clearly written book covering the fundamentals of arithmetic, equations, formulas, mensuration, etc. Answers included.

ACCOUNTING, PRACTICAL: Bell. 302 pp. Cloth binding. A handy book of instruction in practical bookkeeping and elementary accounting.

ARCHITECTURAL DESIGN & LETTERING: Ritow-Brown. 216 pp. Cloth binding. A new book, which thoroughly covers these highly important subjects in an excellent manner.

TOOL AND DIE DESIGN: Cole-Curtis. 140 pp. Cloth binding. A new and practical volume on tool design, die making and metal stamping.

BLUEPRINT READING FOR THE BUILDING TRADES: Dalzell-McKinney-Ritow. 120 pp. Cloth binding. Entirely new! This book deals with the art of reading blueprints in an unusually interesting manner, employing the question and answer method to a large extent.

ELECTRIC WIRING, INTERIOR: Nelson-Dunlap. 243 pp. Cloth binding. This is a thoroughly rewritten and revised edition of our popular book dealing with all phases of interior electric wiring and estimating.

HEATING AND VENTILATING: Hubbard-Severns. 223 pp. Cloth binding. A working manual of approved practice in heating and ventilating modern homes and buildings including maintenance of the new types of systems.

MACHINE SHOP WORK: Turner-Perrigo-Fairfield. 407 pp. Cloth binding. Entirely new! Deals with all phases of shop work, including air tools and slide rule.

These books can be purchased from your
local book dealer.

AMERICAN TECHNICAL SOCIETY - CHICAGO