

TELEVISION



TELEVISION

PRESENT METHODS OF PICTURE TRANSMISSION

BY

H. HORTON SHELDON, PH.D.

*Chairman of the Department of Physics, Washington Square
College, New York University; Science Editor,
New York Herald Tribune*

AND

EDGAR NORMAN GRISEWOOD, M.A.

Instructor of Physics, New York University

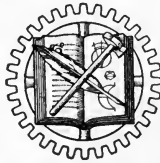

1929

D. VAN NOSTRAND COMPANY, INC.

NEW YORK

COPYRIGHT, 1929, BY
D. VAN NOSTRAND COMPANY, Inc.

*All rights reserved, including that of translation
into the Scandinavian and other foreign languages.*

Printed in U. S. A.

PRESS OF
BRAUNWORTH & CO., INC.
BOOK MANUFACTURERS
BROOKLYN, N. Y.

PREFACE

IN preparing a book on Television one is confronted with the possibility of a revision before the book is off the press. The kaleidoscopic manner in which advances are being made is, of course, responsible for this.

Nevertheless, since the authors feel that for the good of the subject a review of the field is at the moment imperative, they have undertaken this difficult task. At the outset, and during the preparation of the manuscript, they have seen clearly the reason why no one else in this country has ventured such a book to date. They have rushed in where angels fear to tread in spite of the condemnation which is likely to fall upon their heads. The mass of material which could be included in a book of this kind is enormous and we have been forced to use our best judgment as to what to leave out. There will be many to tell us that we have omitted material which ought to have been included and included other material which might well have been excluded. Our argument is that it depends upon the point of view. This, of course, necessitates an explanation of our own viewpoint. We have attempted to give a true picture of the state of television to-day and to give the reader the necessary background to enable him to begin a special study of any one feature. Our style, we hope, is also of a sufficiently popular nature to enable the layman, or the possible investor, to gain a proper perspective of the subject. The book is in no sense a compendium. We have tried to give credit where credit is due and to subdue the blatant claims of pretenders who fill the daily press with extravagant statements. If in

any case we have done an injustice, it has not been intentional.

We have finished the book without knowing what the future of television is to be. Technical difficulties make us somewhat skeptical yet past accomplishments make us, perhaps, over optimistic. We believe, we have fairly curbed our desires to prophesy considering the excellent opportunity afforded by the nature of the subject.

We hope that the book will be found useful and that we may later be able to improve it and keep it up-to-date. Suggestions from readers will be greatly appreciated.

We have had much helpful cooperation in its preparation from individuals and corporations. Without them its writing would have been impossible. We are particularly indebted to the following to whom we extend our sincere thanks: J. L. Baird, of London; Professor Arthur Korn, of Berlin; Jenkins Laboratories, Washington, D. C.; and also to the following corporations: Bell Telephone Laboratories, Case Research Laboratory, Inc., General Electric Co., Radio Corporation of America, Raytheon Manufacturing Co., Westinghouse Electric and Manufacturing Co.; and to the Institute of Radio Engineers.

With these few words on behalf of what is to follow; we leave the book to your tender mercies.

H. H. SHELDON
E. N. GRISEWOOD

CONTENTS

CHAPTER	PAGE
INTRODUCTION	vii
I. ESSENTIAL ELEMENTS OF TELEVISION AND PICTURE TRANSMISSION	I
II. HISTORICAL BACKGROUND OF THE DEVELOPMENT OF TELEVISION	5
III. OFFICIAL SYSTEMS AND THE EYE	19
IV. ELECTROMAGNETIC WAVES	31
V. THE SELENIUM CELL	39
VI. THE PHOTOELECTRIC CELL	46
VII. GLOW LAMPS	59
VIII. OSCILLOGRAPHS	71
IX. SCANNING	81
X. SYNCHRONIZATION	91
XI. TELEPHOTOGRAPHY	101
XII. THE BAIRD TELEVISOR	118
XIII. THE BELL SYSTEM	132
XIV. THE JENKINS SYSTEM	159
XV. ALEXANDERSON SYSTEM	166
XVI. RELAYS	175
XVII. AMATEUR EQUIPMENT	179
XVIII. THE FUTURE OF TELEVISION	185
INDEX	191

INTRODUCTION

Who wants television? Will television serve any useful purpose, become popular as a source of entertainment; or will it, having been perfected, serve a very narrow field?

Hardly has the talking movie made its appearance in almost every theatre, than we are told that it is a passing fancy, that it will soon complete its run. This is not a novel statement; we were told the same thing about the automobile, the airplane and the radio; but they are still here.

Television is not like collecting postage stamps, an avocation which may appeal to a few or be in vogue for a few years and then subside. It is not like police dogs or short skirts which are for the moment fashionable. It is the realization of a desire that has existed in man from his earliest beginnings. The automobile, giving man the speed he has always desired, has stayed. The airplane, giving him the wings he has long sought, has stayed. Television, giving him the distant sight he has longed for ever since, in his ape-like form, he climbed to the topmost, swaying branches of the tallest tree to look afar, is here to stay.

Seeing and hearing things at a distance is as natural a desire as eating. The Indian put his ear to the ground to hear the approach of his enemies so as to be prepared. Lookouts from high hills were common. A great advance in vision was made by the invention of the telescope. This has been greatly improved up to the present time; but still we are not satisfied. We want to see more and further.

The modern newspaper is, after all, nothing more than an instrument to enable us to see and hear more and further.

We can visualize from its printed pages what has happened: but would we read the account as written in the newspaper, had we the time and facilities to be present at the event? Television brings us somewhat nearer to a perfect realization of an event; wherefore its stay will be permanent.

A stadium may seat from seventy to one-hundred thousand people, an auditorium is large if it seats four-thousand, a theatre is built to accommodate considerably less than the last named figure. Why? A theatre is built so that all may hear the spoken word, the auditorium is used by a symphony orchestra which may be heard at greater distances than the human voice and so may be housed in a larger building. One comes to a stadium, however, to see; hence it may be made very much larger. The attendance at stadiums is a good guarantee of the success of television. The advantage lies all with the latter when it is coupled with radio so that both eye and ear may be satisfied.

There are three distinct phases of any message delivered orally. There is the spoken word which may be written or printed on paper. The statement that such words may have several meanings requires no elaboration. Lawyers frequently take advantage of this to convey one idea to a jury; whereas a totally different conception might be gleaned from the statement appearing on the records. However, if we know the tone of voice, the accent, the pauses in such a statement, would we know the correct story? Thus authors of fiction write, " 'Villian!' he hissed," for the purpose of conveying the idea of venom, even though you cannot hiss such a word if you tried. Or turning to the heroine, we might find, " 'John,' she sobbed." Though it is difficult to sob such a word, we get the idea. This helps, but for fullest realization we must *see* the expression on the heroine's face as well as hear how she sobbed the word. At this stage we double or triple the amount of information the single word "John" can convey. It is obvious, then,

that for full comprehension television is essential. Up to this point we can only fill in the details from past experience; a fact which accounts for our greater enjoyment of a radio play when it is one that we have seen as compared to one that we have not seen.

Thinking of television in its broadest sense, that is including the transmission of pictures by wire, there is even here an advantage over the usual telegraph message. Where advertisements are to be duplicated in various cities, the usual telegraph message is not sufficient; only a picturegram can convey the exact form. Where one wishes to send a message in, let us say, Sanskrit, whose alphabet is not familiar to the telegraph operator, the advantage of being able to send a picture of one's handwriting is apparent. Such service has already become a part of the regular routine of our large telegraph companies. That it is destined to supplant the usual service with which we are familiar, may not at the moment be obvious. When one realizes, however, it is now possible to transmit a picture by wire in less than one minute, in the laboratory; there can be little doubt that putting such speed into commercial practice will greatly increase the number of words it is possible to send over a telegraph line in any given time. The tedious ticking off of the individual letters for each word will eventually appear as antiquated as an ox-cart alongside a powerful, electric locomotive.

If one makes an inventory, one will soon discover that there are a number of forms of entertainment from which he is barred without television in conjunction with his radio. Dancing, which forms such a large part of any musical revue, is entirely absent. This was realized when one broadcasting station tried to send over the air a series of Broadway musical shows, direct from the stage. We feel sure that no one will deny this was a failure. Without the stage setting, the display of color and dancing, it was lifeless.

We have long had movies without sound; today, they are being combined. In radio we now have sound without movies; the condition is rapidly being remedied. When this page reaches you, the combination may have been effected in your home; as it has been, for some time, in the laboratory.

The radio expert or amateur who says he is not interested in the development of television might as well say he is not interested in the three electrode vacuum tube. Both are part of his business.

In this book we have attempted to bring together, in a manner that can be understood by all, a summary of the achievements in the field of television together with a description of accessory equipment. We believe, that at the time of going to press, it presented fairly the accomplishments to date. We realize that the next few years will bring a multitude of changes that may at times leave us somewhat behind. It is our hope, however, that public acceptance of this book will make, it possible, through frequent revisions, to keep in step with the parade. We invite our readers to assist us with suggestions.

TELEVISION

CHAPTER I

ESSENTIAL ELEMENTS OF TELEVISION AND PICTURE TRANSMISSION

TELEVISION and picture transmission both require that the light and shade of an object or of a picture be translated into varying electrical impulses. These are transmitted by wire or radio to their destination; where they are changed from the electrical form back into the original light and shade, either to be viewed directly or to be recreated into a picture. To do this there are certain fundamental steps which are unavoidable and which differ only in their method of application. When we fully understand these, we have mastered the entire problem.

All modern television systems require, first of all, illumination of the object in order that the light and shade used to produce the picture may be present. In the early Baird experiments, in which the illumination covered the entire subject at one time, the heat and glare were so great that only dummies could be used. Increasingly sensitive apparatus now makes it necessary to use illumination no greater than strong sunlight. Most systems, however, do not light up the entire object at once; but use a narrow beam which rapidly traverses the object along successive strips.

Thus, if we were to place a series of parallel fine wires before the object, the light would follow the length of each of these successively. In effect this same thing happens

when the entire object is illuminated; for, although the light itself is unchanged, the successive stripes are *viewed* in the same way by a moving lens system. We may say then, without reservation, that present-day scanning, as this process is called, is accomplished by viewing successive portions of an object along a straight line and viewing the consecutive lines in some convenient manner. This is not at all unlike reading the words on this page along any line and then reading the lines one after the other. In this manner the entire page is covered. In an analogous way every portion of the surface of this page would be covered in order, if being scanned for television transmission.

The lights and shadows, or variations of light, which are noticed as we pass over the picture in this or some similar fashion, must next be changed into corresponding variations of electrical current. This has presented the greatest difficulty in the development of television apparatus. In the first experiments, which promised success, the selenium cell was used. Such cells, to be described later, have the peculiarity of decreasing their resistance to the flow of electrical current, in proportion to the intensity of illumination. They are, however, temperamental devices having a fatigue effect which causes them to fall off in effectiveness after a short time of continuous use. To recuperate, they must be left in the dark. Also the change in resistance does not coincide with the illumination changes but follows somewhat later. This peculiarity is suitably known as a "lag." For these reasons, the selenium cell did not satisfy the requirements in its original form, although there are indications that these faults may yet be overcome.

Television was really born with the advent of the photoelectric cell. This cell consists of two electrodes, one of which is coated with an oxide or a hydride of an alkali metal—for example, caesium oxide or potassium hydride. Such coatings, when illuminated, give off copious supplies of elec-

trons, the number of which is a direct function of the light intensity for any given color. These cells have no apparent lag nor fatigue although their sensitivity is not yet all that could be desired. When inserted as part of a circuit they give an apparent change in resistance under illumination; although the effect should not be interpreted as a strict resistance change.

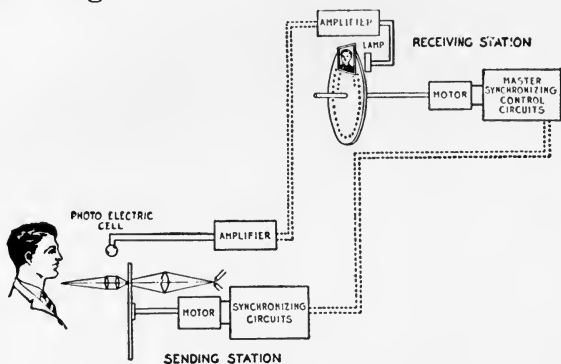

(Courtesy of Bell Telephone Laboratories.)

FIG. 1.—A typical television system.

The variations in current given by either of the above devices are extremely small and must be greatly magnified to be transmitted over any distance. This is accomplished by vacuum tube amplifiers, particularly well constructed to avoid distortion. The amplified output may be sent over wires or on modified carrier waves, as is done in radio transmission. In the former case it is received as changing current,—in the latter, by the usual radio mechanism; so that if put through a loud speaker it would produce actual changing sounds. The picture would be “heard,” so to speak.

In either case the next stage in the procedure would be to reconvert the electrical variations into light variations similar to the original. In the first types of apparatus this was done by again amplifying the currents at the receiving end and causing them to actuate an electromagnet. The

latter would vary a slit width or in some other manner control the amount of light falling upon a sensitive film on which the picture was to be produced. This method was adapted only to picture transmission. There was no hint of television; although if it had been physically possible to have carried on the operation with sufficient speed the picture could have been viewed through a translucent screen.

To procure a speed sufficient for television, it is necessary to obtain some method of reproduction free from the inertia which accompanies a moving mass; a difficulty to which all of the mechanical schemes were subject. The introduction of the neon glow-lamp solved this problem. This lamp glows under a high voltage placed across its terminals and has so little lag that it can easily follow thousands of fluctuations per second.

It is, of course, apparent that the lines drawn by such fluctuating lights must always be exactly in step with the scanning operation, at the sending end. If there is a slight lag of the one behind the other, the picture will be askew. This synchronization of the scanning with the reproduction on the receiving drum, or in the receiving frame, has been one of the principal experimental difficulties in television.

For the transmission of a moving object, if the image is to appear continuous, the original must be scanned completely at least ten, preferably sixteen, times per second. This likewise is a difficult technical problem.

Here we have the important features both of picture transmission and of television. The means of accomplishing each particular step are as varied as the number of experimenters. The purpose of the following chapters will be to consider some of the best known methods in greater detail and to discuss the accessory apparatus.

CHAPTER II

HISTORICAL BACKGROUND OF THE DEVELOPMENT OF TELEVISION

ALTHOUGH television is still in its infancy, perhaps not yet well out of the embryo, we must go back over eighty years to find the earliest apparatus for picture transmission by electric currents. Nor should we feel that this early work was unimportant in the development which has made possible the systems in use today.

In 1847 Bakewell designed a method for the transmission of writing or sketches over wires; a system not very different from one suggested some four years earlier by Bain, but not developed by him at that time. The apparatus is illustrated diagrammatically in Fig. 2.

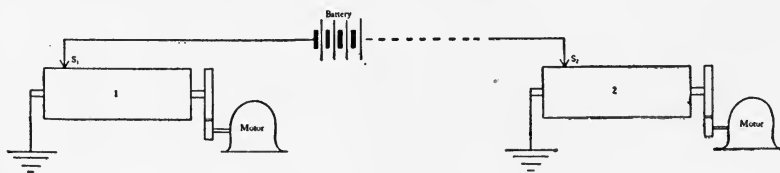

FIG. 2.—Bakewell system.

The metal cylinders (1) and (2), one at each end of a telegraph line, are revolved synchronously. Over each cylinder a metal stylus (S_1 and S_2) describes a spiral path, similar to that of the needle in the early Edison phonograph, which used cylindrical records. Note that our problem in timing would be exactly the same as requiring that two such phonographs, located at a distance from each other, and playing the same record, should sound a given note at

identically the same instant. This apparently could be accomplished by having the speed of rotation of both cylinders identical and starting the needle (or stylus) at exactly the same time.

If now a design be drawn with an insulating material, such as shellac, on the sending cylinder (1); the telegraph circuit will be broken when the stylus passes over this insulation, but closed again when the stylus strikes the uncoated metal. That is, the current in the line will be intermittent; only flowing while stylus (S_1) is passing over a portion of its spiral path which is not covered by the design to be transmitted. The problem then is to make a record on cylinder 2 which will show when current is flowing in the line as distinct from when it is not.

This may be accomplished if the receiving cylinder be covered with a chemically prepared paper such that the passage of an electric current through the paper will change its color. For this purpose we might saturate a piece of porous paper with an aqueous solution of potassium ferricyanide and ammonium nitrate. In this case we will obtain a dark blue color in portions through which the current has passed.

Using such a paper, it is clear that if the synchronism be exact, a negative of the drawing on the transmitter will be traced on the receiving cylinder. That is to say, the paper will be turned blue except when the transmitting stylus is passing over the insulating material. Thus white portions will correspond to the lines of the drawing or writing to be transmitted. The received diagram would then appear like a blueprint made from a line drawing on tracing cloth.

The movement of each stylus actually describes a helical path, like the thread of a screw, on the cylinder above which it moves. When the paper is removed from the cylinder and opened out flat, however, this path will appear

as a series of parallel lines—their spacing depending on the lead of the stylus control. (See Fig. 3.)

As might be expected, the difficulty in obtaining synchronism in the two cylinders militated against the success of the Bakewell system. However, the teletograph used commercially by T. Thorne Baker for transmission of pictures between London and Paris in 1908 was fundamentally the same as the method described above. In the scheme employed by Ferree as recently as 1924, for radio and wire transmission of photographs, the principles of the early development described can be readily recognized.

Another system which was tried by early investigators, notably the French Post-office Engineer, Charbonnelle, is that of mak-

ing the depth of silver deposit on a photographic film act as the means of varying the current in our telegraph circuit. In order to do this, the gelatine containing the active silver salt must be laid on a metal sheet instead of on the usual celluloid or glass backing. On exposure, the reduction to metallic silver occurs at those portions where the greatest amount of light is received. Now place the negative on a cylinder so that the metal backing forms one terminal of the circuit and the stylus, pressing lightly on the surface, the other. As the unreduced silver salt and gelatine are poor conductors, whereas the silver image is good, it is natural to expect the resistance of the circuit to vary, being least where the stylus is over

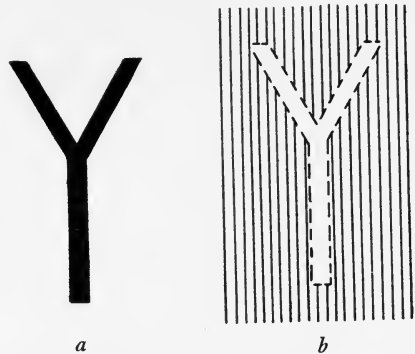

FIG. 3. *a*—Shows the letter as it appears on the sending cylinder; *b*—as it is received in the Bakewell system.

those portions in which the "printing-out" or deposition of silver is a maximum.

The fluctuating current thus obtained might be employed, as in the instance previously described, to act on a chemically prepared paper at the receiving end. Unfortunately, however, experimenters using this scheme seem to strike serious difficulties. Chief among these difficulties is the tendency for the flow of current to follow the path of least electrical resistance rather than the shortest geometric path between the stylus and the metal sheet. Hence the current in the circuit at any instant will not be simply a function of the amount of silver deposit; as would be necessary for an accurate reproduction.

Failing to obtain satisfactory results in transmission directly from photographic negatives, it was not surprising that early experimenters should turn to the half-tone or process-screen reproductions used in newspaper work. Examination of such a picture under a magnifying glass will reveal that it is composed of large numbers of tiny dots of various shapes and sizes. In the light portion of the picture these dots will be far apart; in the dark portions so close together as to merge into one another. The general effect produced by the ensemble will depend on how fine grained a structure is used. A picture composed of some seventeen-thousand dots to the square inch leaves little to be desired; one with only four-hundred, will be barely passable even when viewed at arms' length; the usual newspaper production contains four-thousand two-hundred and twenty-five dots per square inch.

Suppose that we should imagine our photograph placed on a sheet of fine cross-section paper; so that each square may be designated by a letter and number as is done in describing a chess-board; or by two numbers, an abscissa and ordinate, as is done in plotting charts. We then split our picture into a number of small parts, each one of which

may be transmitted separately and the whole reassembled according to the designation of the squares. Such a system makes possible the simultaneous transmission of different portions of a picture over separate wires; thus enabling the entire reproduction to be made more rapidly than would be the case if only a single wire were used. It then remains to find some method for describing the appearance of these squares. We might use a letter of the alphabet to indicate a certain size and shape of dot as used in the half-tone. In

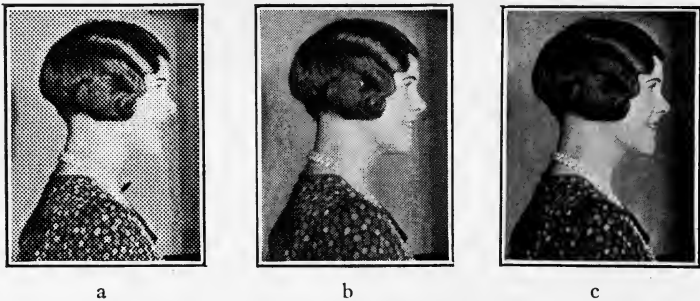

FIG. 4.—The detail of the reproduction depends upon the number of picture elements used per unit area. (a) Made through a 60-screen; e.g., 3600 elements per square inch. (b) through a 100-screen; e.g., 10,000 elements per square inch. (c) through a 150-screen; e.g., 22,500 elements per square inch.

this fashion the square might be coded and transmitted like a written message.

There are, however, a great many objections to be overcome. To obtain a good reproduction, a great many sizes and shapes of dots must be used, making coding a long and difficult process. H. G. Bartholomew and M. L. D. McFarlane, in England, have removed the necessity of a human observer having to assign code letters to the various parts of the picture. Their device not only automatically codes the picture; but also perforates a tape which may be run through the ordinary telegraph or wireless transmitter. Here the problem is somewhat simplified by using only six color variations from white to black to describe a given

portion of the original. This method, which is known as the Bartlane process, will be described in more detail in a later chapter.

L. J. Leishman also has devised a method of transmitting a half-tone without the necessity of coding. The system is not so very different from that described as unsatisfactory when applied to the usual latent image in silver. Here, however, the picture is first photographed through a process screen, the function of which is to split the original into dots of varying sizes. A positive is then made from this negative. The positive is formed on a copper or zinc plate covered with a mixture of gelatine and ammonium dichromate. The dichromate is rendered insoluble by the action of light; so that after washing, only those portions of the copper plate corresponding to the dark parts of the original will be covered with the gelatine and dichromate. After heating, these portions become an excellent thin insulation over the surface of the plate. The reproduction in Leishman's system is accomplished by a stylus actuated by electromagnets. Both transmitter and receiver employ cylinders above which a needle moves much as described in the Bakewell method. The reproduction, however, may be made by the mechanical movement of the recording needle without the medium of a chemically treated paper. One way in which this can be done is to allow the stylus to strike a carbon sheet placed over the paper on which the drawing or photograph is to be received.

The work of Edouard Belin, a French inventor, illustrates still another treatment of the problem, which has been successfully used by not a few experimenters. He made use of a picture formed in relief on the sending cylinder. The displacement of a needle passing in a close spiral path over this irregular surface is made to produce fluctuations in the line current. In an early form, demonstrated over a Paris-Lyons telephone line in 1907, this was

done by amplifying the movement of the stylus by a lever, the far end of which moved over a device for varying the resistance in the circuit. A serious objection to such an arrangement lies in the fact that to produce such an amplified movement a considerable force must be exerted by the stylus; this causes cutting of the gelatine relief used for transmission. Later Belin improved the transmission by connecting the stylus to a microphone in the primary circuit of a transformer, the secondary of which was in the transmission line. This is readily recognized as similar to the ordinary telephone transmitter, except that the movements of the stylus, as it passes over the relief image, have replaced the condensations and rarefactions of sound waves.

The receiving portion of the Belin apparatus introduces a method markedly different from any hitherto mentioned. The varying currents are received on a Blondel oscillograph, an instrument in which the variation of current is measured by the displacement of a beam of light reflected from a mirror rigidly fixed to the suspension. The reflected light then passes through a wedge-shape aperture, called by Belin a "scale of tints"; thence through a condensing lens onto a sensitized film which is carried by a rotating cylinder synchronized with the sending cylinder. It will be noted that here we are using the current in our circuit to vary the amount of light from a constant source which reaches a given portion of the film. Thus, the inertia of the receiving mechanism has been greatly reduced, a major achievement since speed of reproduction is all-important.

Turning now to the method of Professor Arthur Korn of the Berlin Technical High School, we find the selenium cell used at the transmitter. The photographic film is placed on a glass cylinder which rotates and at the same time moves along parallel to its axis. Hence by keeping a small point of light in a fixed position, it may be made to traverse every portion of the film. The light, having passed through

the translucent film, is allowed to fall upon a selenium cell, connected in the usual telegraph circuit. Selenium possesses the property of becoming more conductive for electricity under the influence of light. Therefore the resistance of the circuit at any time will be proportional to the darkness of that part of the film then under illumination. Clearly, in order to obtain the desired current variation, the source of light and the electromotive force acting in the line must both be constant. At the receiving end, a modification of the galvanometer scheme employed by Belin is used.

At first glance, it would appear that in this system the inertia effect has been reduced to a minimum since neither

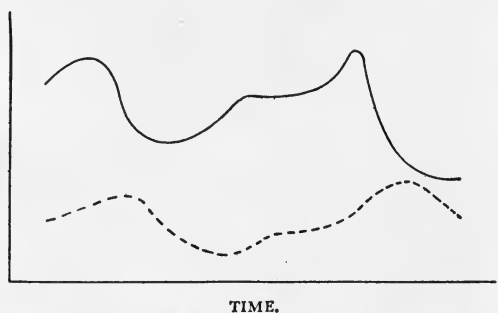
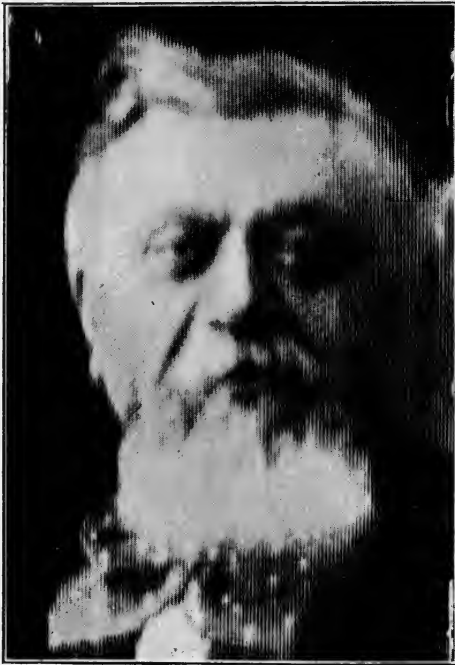

FIG. 5.—Comparison of the fluctuation of light intensity (solid line) and conductivity of a typical selenium cell (dotted line). Note time lag and rounding of conductivity curve.

transmitter nor receiver depend upon the movement of a stylus having mass. Unfortunately, however, the selenium cell is subject to a distinct lag—it does not respond instantly to light fluctuation. The accompanying diagram shows this effect quite clearly. Professor Korn has very ingeniously corrected this difficulty by the use of two cells arranged to compensate for each other. Nevertheless, considerable trouble still exists in the selection of suitable cells. It is for this reason that the selenium cell has been almost completely replaced by the photoelectric cell, as we shall consider later.

Up to this point we have considered only the problem of picture transmission over wires. The wireless or radio transmission, however, presents the same fundamental problems—the production of current or potential variations from the original and their reception so as to give an accurate reproduction. When using a system of the inter-



(Courtesy of Arthur Korn.)

FIG. 6.—Picture of President Fallieres sent by wire from Berlin to Paris in 1907 by Korn system. Time required, 12 minutes. (Note the structure.)

mittent current type as previously discussed, the introduction of a tuned spark-gap is all that need be considered in order to understand the early attempts at wireless transmission. A coherer was employed in the receiving circuit. The problem of synchronization becomes even more complex with the lack of direct wire connection between the two stations.

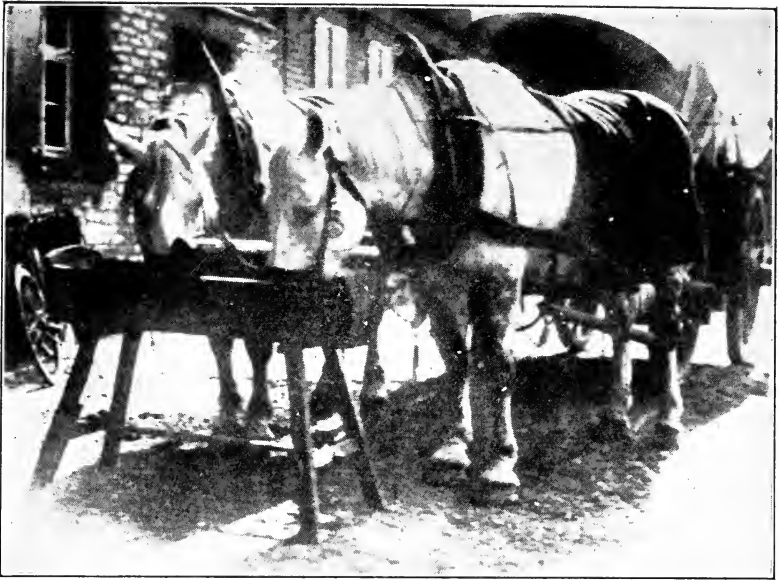

(Courtesy of Arthur Korn.)

FIG. 7.—Examples of pictures transmitted over wires by the Lorenz-Korn method in 1928. A photoelectric cell is used at the sender and a string galvanometer at the receiver. Time required, $1\frac{1}{2}$ minutes.

Hans Knudson achieved some success in wireless transmission of pictures over short distances as early as 1908, despite the inherent difficulties of the spark gap and coherer.

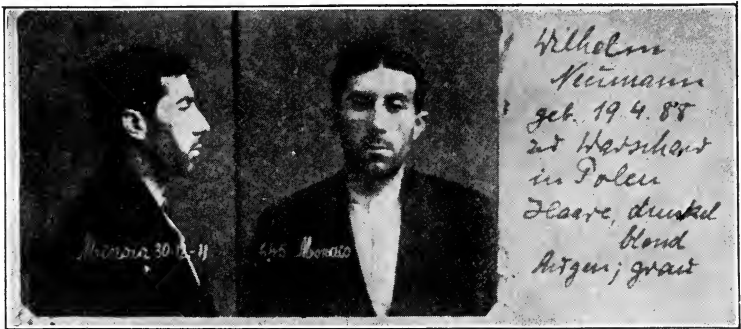

(Courtesy of Arthur Korn.)

FIG. 8.—Examples of wireless transmission by the Lorenz-Korn method, 1928. Time, 1 minute.

He used a relief line-process original and transmitted directly without coding. Professor Korn also adapted the

system described briefly above to wireless transmission. This he demonstrated in 1914. In this case it was found necessary to code the original. A step performed automatically by a sensitive relay operated by the current fluctuation in the selenium cell circuit. The perforated tape made by this relay could be translated into code letters, each one of which designated a shade (or process dot—in shape and size); and transmitted like any radio message. To facilitate reproduction a special typewriter was designed in which the type attached to a given key was a tiny square of the correct shade (or correct process dot) for that code letter.

A number of other code systems such as the Bartlane, mentioned previously, are readily adaptable to radio transmission—provided the problem of synchronization can be solved.

The introduction and development of the three-electrode vacuum tube resulted in such a simplification, both in the transmission and reception of radio signals, as to completely replace the spark-gap and coherer. This is as true in the field of picture transmission as in sound broadcasting. So it is that we find the vacuum tube oscillator employed in the systems of C. F. Jenkins of Washington, D. C., and R. H. Ranger of the Radio Corporation of America; both of which will be discussed in later chapters.

The progress made in radio transmission of pictures since the advent of the vacuum tube has been extremely rapid. On December 2, 1924, pictures were "radioed" from London to New York, using Captain Ranger's method. The system is now established and commercial service maintained between the Radio House, the Marconi telegraph station of London, and the R. C. A. in New York City.

Let us turn now to the problem of transmission of pictures of moving objects, generally referred to as television. As the eye will not hold a discrete impression of pictures

presented at the rate of sixteen per second; it follows that, if a moving object be photographed every sixteenth of a second and these separate images projected before the eye, sixteen each second, the impression will be one of continuous motion. This is then the problem of television.

Little has been said so far about the time required for transmission. In the Bell Telephone system, one of the most recent for wire transmission, a 5 x 7 inch photograph in 100 lines to the inch (equivalent to 100,000 dots per square inch) requires seven minutes for transmission. Any code method such as those previously described will of necessity require a much longer time. It becomes apparent that much more rapid reproduction is imperative. For this reason apparatus of negligible inertia will be required both for transmission and reception.

Early experimenters in the field attempted to use the selenium cell. The first suggestions being to allow the light from a small section of the original to fall on a cell controlling the current for a light which illuminated the corresponding portion of the reception screen. Enough such circuits must be used to cover the entire object to be transmitted. Although direct enough, this system is certainly quite complicated for the transmission of any but an extremely simple picture.

Ruhmer in Germany as early as 1910 accomplished a remarkable simplification of the elementary method suggested above. He used only twenty-five square sections in his transmission and reception board, so that only simple geometric figures could be handled. In place of twenty-five different wires from sender to receiver, however, he employed only one. Each square actuated a separate selenium cell; this cell controlled a circuit of definite frequency. At the reception end a relay responsive only to this frequency illuminated an electric bulb placed behind the corresponding square of the screen. When a number of squares of the sending board

are illuminated a number of different frequency pulses will be sent over the line without interference and the corresponding relays will be actuated, thus lighting the correct squares on the reception board.

As intimated previously, the lag of the selenium cell presents a considerable difficulty, hence it has been supplanted by the photoelectric cell and the cathode ray oscillograph in more recent developments. Even in 1908, A. A. Campbell-Swinton suggested, in a letter to "Nature" that the problem might be solved by the use of the Braun tube, or cathode ray oscillograph. Several workers have since followed along these lines; notably Professor Belin and M. Dauvellier in France.

In America the photoelectric cell seems to have attracted more attention. We find it utilized by C. F. Jenkins in the transmitter used by him in June, 1925, when he succeeded in projecting on a small screen, in his laboratory in Washington, D. C., an image of the rotating arms of a windmill; the arms of the original were turning nearly five miles away in Anacostia, Md. At the receiving end a refinement of the neon tube due to D. MacFarlane Moore was used.

For a clear understanding of these more recent systems of television it is essential that one know something of the construction and characteristics of some of the more important parts used—the photoelectric cell, the neon lamp, the cathode ray oscillograph, the scanning disk, optical systems, etc. The purpose of the following chapters will be to discuss each of these devices in detail. The theoretical background necessary for an understanding of the apparatus will also be treated briefly.

CHAPTER III

OPTICAL SYSTEMS AND THE EYE

IN the study of television one is constantly confronted with optical systems. There is the optical system which produces the scanning pencil or which collects the light rays reflected from the scene at the sending end, and the projection system for throwing the image on a screen at the receiving end. Lenses, mirrors, and prisms have a habit of making themselves useful in what sometimes appears to be the most unexpected ways, as in the Jenkins scanning disc for example. These are the tools with which we control light beams, and as this control is an essential element of television it is necessary that we know something of it. For this study we need know nothing of the fundamental nature of light and this is left for a later chapter. We are here concerned only with its behavior in relation to optical systems.

One of the first laws of geometrical optics concerns itself with the rectilinear projection of light. This law states that light travels in straight lines in any homogeneous medium, that is a medium which is the same throughout. The second important law is that the intensity of illumination from an open point source falls off inversely as the square of the distance from the source. Thus if the distance of a lamp from an object is doubled the intensity of illumination of the object is cut to one-fourth of its former value; if tripled in distance the intensity is cut to one-ninth and so on. If the source is enclosed, as in a reflector, this law does not hold and the rate of falling off will then depend

upon the reflector. It is not true for a source other than a point, but if the object is removed a distance which is twenty times the diameter of the source or further, the error introduced by considering it a point is less than one per cent. For most practical purposes the law is nearly enough correct for satisfactory application. In illuminating an object for television it should not be lost sight of.

Reflection of light is an important point in television. For a mirror there is a law which states that the angle of incidence is equal to the angle of reflection. Thus in Fig. 9, the angle i equals the angle r . This law may

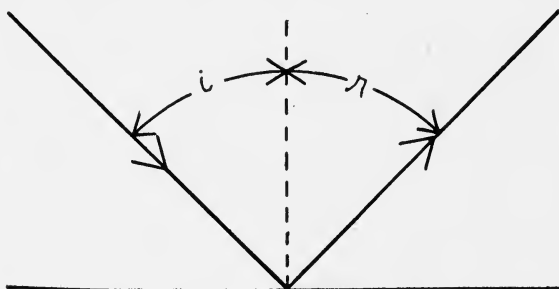

FIG. 9.—For a mirror the angle of incidence (i) of a light beam is equal to the angle of reflection (r).

be accepted wherever a polished metallic surface is considered, but it does not hold true for any but well polished surfaces. A comparatively rough surface which is white, as a piece of white blotting paper, may reflect more light than polished nickel and in general will do so: this is also true of mat white card-board or white cotton, etc. This reflection however does not obey the law given above, but rather Lambert's cosine law. The latter law is best understood by reference to Fig. 10, where the arrows ending on the circle represent the amount of light which comes off at each angle. Such a surface is called a diffusely reflecting surface, whereas the mirror is called a specularly reflecting surface. In properly illuminating a subject to be televised

the choice of reflectors is important: but, in general, diffusing screens would be used. These screens are much used in photograph galleries and their use is no less essential in television studios.

The fourth fundamental law of geometrical optics is that of refraction. This has to do with the passage of light from one medium to another as from air to glass or from air to water, etc. Dipping a pencil at an incline into water and viewing it from above will show that it appears to be bent where it enters the surface. The amount of bending depends, it has been found, on the relative speed

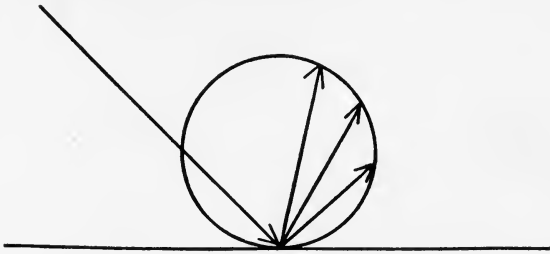

FIG. 10.—In the case of a diffusing surface reflection follows Lambert's cosine law. This is shown above where the length of arrow represents the amount of light reflected in any chosen direction.

of light in the two media considered. It is this property of refraction which makes lenses possible.

Perhaps the simplest optical device is the plane mirror, of which it need only be said that the image appears to be as far behind the mirror as the object is in front. Since no rays of light actually penetrate the mirror, no rays actually exist where the image appears to be. Such an image is called a *virtual* image.

When we come to curved mirrors, however, we have quite a different story, and one which is not so simple. If we consider a concave mirror as shown in Fig. 11; a ray marked *A* striking it as indicated, will be reflected according to the reflection law, for the ray is so small that the part

of the mirror which it strikes appears flat from its point of view. The ray B will likewise be reflected as shown.

The point at which the rays cross, F , is called the focus and if the mirror has been drawn with a compass it will be

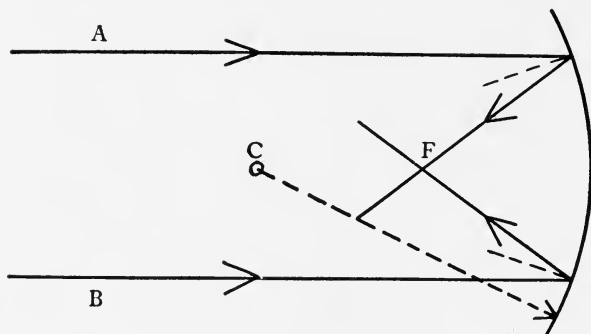

FIG. 11.—Diagram of a concave mirror showing path of light rays, the focal point F , and the center of curvature of the mirror at C .

found that F is halfway between the center of curvature and the mirror.

Now, the useful images which we will get from mirrors of this type are of three kinds:

1. The object is to the left of the center of curvature. Fig. 12*a*.
2. The object is between the center of curvature and the focus. Fig. 12*b*.
3. The object is between the focus and the mirror. Fig. 12*c*.

Wherever the image and object are on the same side of the mirror the light rays actually pass through the image and it is called a *real* image. If they are on opposite sides the image is *virtual*, as in the plane mirror. Formulas may be given so that the exact position of image and object may be located mathematically; but readers are referred to textbooks on optics for this information.

In television, lenses are more important than mirrors

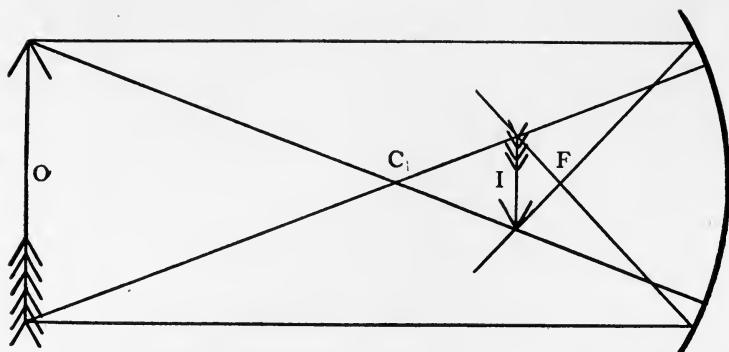

FIG. 12a.—The position of the image and its size with respect to the object when the object is beyond the center of curvature is shown above.

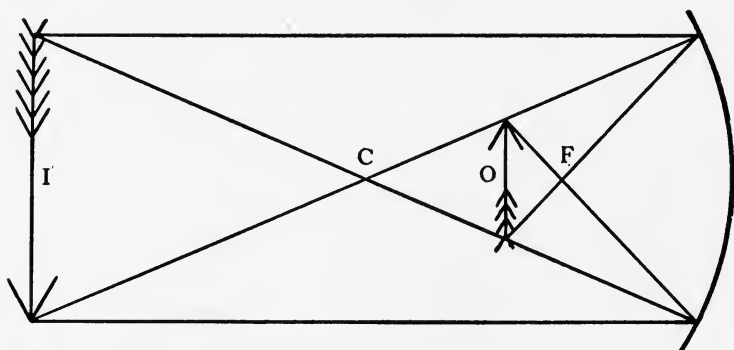

FIG. 12b.—When the object is between the center of curvature and the focus, the image takes a position outside the center of curvature.

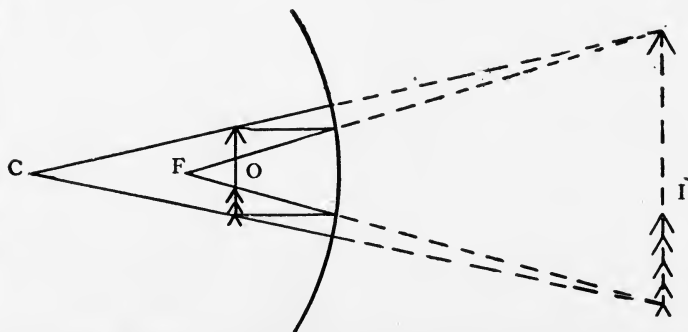

FIG. 12c.—If the object is between the focus and the mirror, the image is virtual. It appears to be behind the mirror.

although they behave in much the same manner. Here parallel rays, instead of being reflected to the focus, are refracted as shown in Fig. 13. Fig. 14 shows the relative location of image and object for one position of the

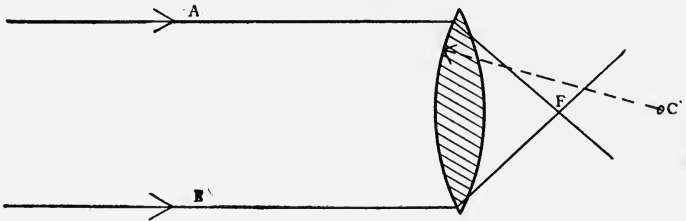

FIG. 13.—The diagram above shows the path of parallel rays which after refraction by the lens pass through the focus. C is the center of curvature for one face of the lens.

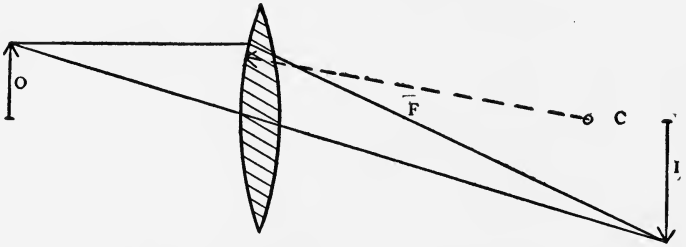

FIG. 14a.—The above is typical of the position of object and image for a double convex lens when the object is outside the focus. This will be the case in most television apparatus.

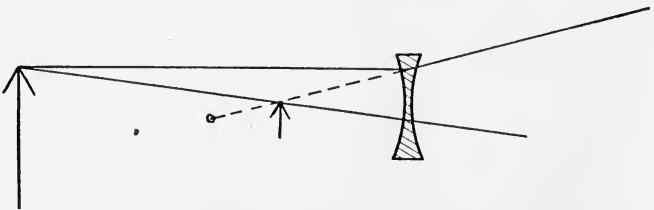

FIG. 14b.—For a double concave lens the image is between the lens and focus when the object is outside the focus. The image is virtual.

object. This is typical as long as the object is not between the focus and the lens. In the case of convex lenses the image is real when it is on the opposite side of the lens from the object and virtual when it is on the same side.

As the double convex lens is almost always used in television for producing real images, the method of choosing a lens for this case only will be given. This is based on the formula:

$$\frac{1}{f} = \frac{1}{p} + \frac{1}{q}$$

where f is the focal length, p is the object distance and q is the image distance. The focal length of any lens can be quickly found by holding it up toward the sun and finding where it casts its light spot. This is not accurate, but is good enough for most purposes. From this formula one can determine distances and dimensions necessary in the construction of television apparatus.

Several things about the choice of a lens are worth noting. The greater the diameter of the lens and the shorter its focus the greater its light collecting ability. A short focus lens has what is called a flat field. It is said to have no "depth of focus," and an object has to be moved only slightly to be thrown in or out of focus. A person's nose might be sharply in focus but his cheeks blurred in such an extreme case. The farther we get from this condition the less light we collect but the more pleasing the view. In television, light collection is frequently the major consideration, consequently such lens are not uncommon.

When one is using a photoelectric cell, sensitive mainly in the violet, or when the image is to be photographed, the available light is increased by use of quartz lenses; for these transmit the ultra-violet rays of high actinic value.

One must also watch for various lens faults. One of these is spherical aberration, a fault which causes a blurred image, as rays from the outside part of the lens focus closer to it than those from the center. (Fig. 15.) Another is chromatic aberration, which is the focusing of different colors at different distances from the lens, the red farthest from

it and the violet nearest. (Fig. 16.) Some lenses also give "pin-cushioned" distortion, others, "barrel-shaped" distortion. Others have astigmatism, the focus across one axis being different from that across another; they are not symmetrical . . . and so the number of possible faults goes on. To correct for such faults good lenses are usually

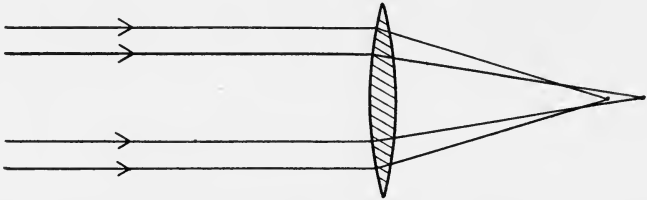

FIG. 15.—Rays from the outer edge of a simple lens whose surfaces are spherical focus closer to the lens than those through the center portion. This gives a blurred image.

made up of two or more pieces each of a different kind of glass. With these pieces all common faults can be corrected.

While one should be careful in selecting lenses if good results are expected, it should be remembered that good selection implies a knowledge of when to use a cheap lens as well as when to use a good one. It would be foolish, for

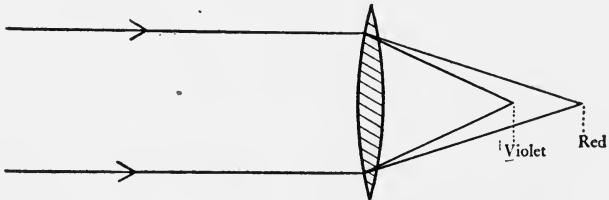

FIG. 16.—Different colors will focus different distances from the lens unless it has been specially corrected for this fault by being made up of different kinds of glass cemented together.

example, to put an expensive lens in a spot-light, where none of the faults enumerated above would have any importance. Before choosing, one should make a careful study of the needs—one would not choose an expensive limousine to haul gravel.

The prism is another optical device which may at times prove useful. This has the ability to bend light as shown in Fig. 17, the red being bent least and the violet most.

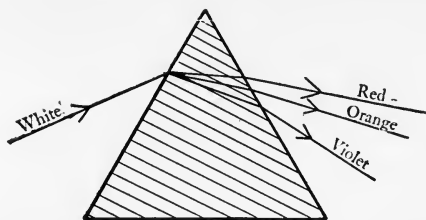

FIG. 17.—A glass prism breaks white light up into component colors, the red being bent least, the violet most, as shown.

The prism has another interesting use, that is as a perfect mirror. As rays of light come from an object under water, for example, they are bent more and more toward the surface as the angle changes, finally being reflected back into

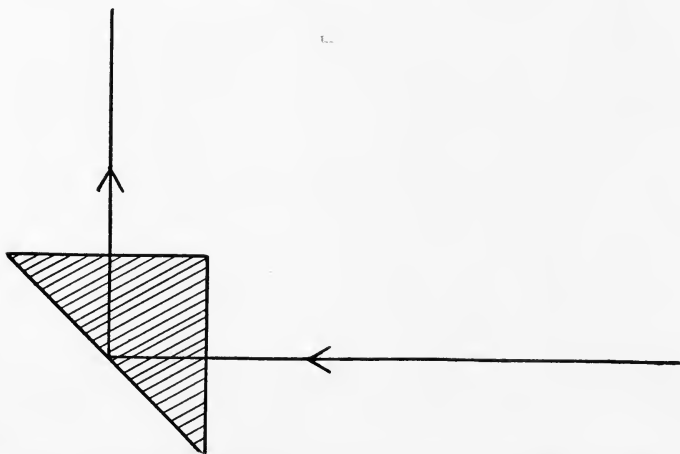

FIG. 18.—A right-angled glass prism may be used as a perfect reflector if light is allowed to strike it as shown.

the water. Beyond the critical angle the reflection is complete, and is known as internal reflection. If light is sent in on one side of a right-angle prism, as shown in Fig. 18,

it will strike the oblique side at such an angle as to be wholly reflected and so the prism acts as a perfect mirror. Prisms are for this reason much used in binoculars, range-finders, etc.

One optical instrument which enters into all television systems is the human eye and since all systems must adapt themselves to, and may take advantage of its characteristics, it is essential that we know something about the manner in which it functions. When the light enters the normal eye it is focused by means of the eye-lens onto the retina. The retina is coated with a material known as the visual-purple in which are imbedded the so-called rods and cones at the nerve ends. When the light falls upon the visual-purple, a photoelectric action takes place, according to the generally accepted Eldridge-Green theory, the electrons being freed much as they are in a photoelectric cell. These freed electrons set up currents in the visual-purple which are detected by the rods and cones; these in turn set up currents in the nerves that carry them to the brain. The detection of the current in the visual-purple by the rods and cones, and its production of secondary currents in the nerves, reminds one of the action of a vacuum tube circuit. The nerves are the wires which carry the message to the brain. The eye interprets different wave-lengths as color.

There are several features of the eye which cannot be ignored in planning television apparatus. For best seeing conditions, the illumination level should not be too high. One to one-hundred foot-candles are advisable limits. It is also advisable to keep the contrast between different parts in the ratio of about ten to one. A ratio of one-hundred to one will produce a glare. The color for best vision is in the yellow-green region. When the diameter of an object being viewed is more than one-twentieth its distance from the eye, it is too close for easy viewing, and if it is less than one three-hundredth the distance, it is too far away. A

ratio of diameter of object to distance of one to one-hundred is most suitable. This should be kept in mind in locating an object to be viewed before the scanning-disc. At the receiving end seeing will be easier if all other lights in the room are dimmed, for stray light will cause the pupil of the eye to contract needlessly and will thus close off much of the light from the television screen.

Owing to the fact that the eye does not change at once in response to any change in light intensity, but has a lag of about one-tenth of a second, it is possible to produce the sense of continuous motion by placing an object successively at slightly different positions and allowing it to be viewed at tenth-second intervals. This is made use of in the produc-

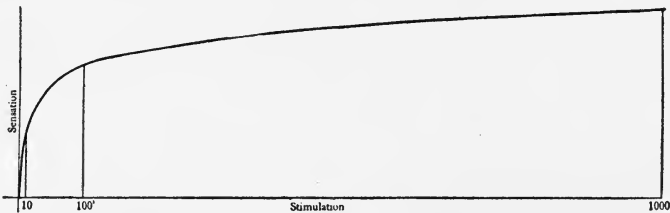

FIG. 19.—The sensation produced in the eye is not in proportion to the stimulation. The relation, which is logarithmic, is shown in the figure above.

tion of motion pictures. Without this so called persistence of vision, television of the modern type, which requires that parts of the image be sent over in succession, would be impossible. The speed of scanning is determined by this lag, which dictates that pictures must be scanned completely at least ten times per second in order that the picture may appear as continuous to an observer.

In operating a television receiver it should also be remembered that the sensation received by the eye is not in direct proportion to the intensity of the light, but to a logarithmic function of this intensity. Thus 1000 foot candles does not produce an appreciably greater effect than 100 foot candles. This will be seen in Fig. 19.

In operating television apparatus one should never forget the fact that every precaution should be made to protect the eye. If one is projecting the light from a neon lamp onto a screen at the receiving end, it should be remembered that increasing the screen size will give a less intense image and may result in eye strain. At the sending end an intense source of light should not be used to the discomfort or possible injury of the subject. By doing so one is only fooling oneself into the belief that he is making more progress than is actually the case. Bigger screens, better scanning, etc., will only come with improved apparatus and eye injury will not further the cause but will weaken it.

CHAPTER IV

ELECTROMAGNETIC WAVES

MUCH of our present understanding concerning the behavior of light is based on the assumption that we are dealing with a wave motion. Just how close this hypothesis approaches the truth remains a matter of conjecture. Considerable evidence obtains to discredit such a viewpoint; yet so many of the common phenomena associated with light can be readily explained on the basis of a wave theory, that for pedagogical purposes, at least, this interpretation will probably remain in vogue for some time to come. At any rate, such a treatment of the subject will prove helpful in so far as it concerns us in our study of television.

Everyone is familiar with the action of water waves. How often have we seen "the angry breakers pile upon the barren shore"? Rather we should have said "batter against," not "pile upon." Although there is no doubt of the force of their impact, as one sometimes finds when surf bathing; yet considering an extended period of time, no appreciable volume of water is transferred landward despite the fact that there may have been a continual, apparent movement of the waves in that direction. Herein lies an important characteristic of all wave-motion,—energy will be carried from one point to another but the material carrier thereof remains in situ.

In order the better to understand the mechanism by means of which this is accomplished, let us turn to the example of a wave form sent along a rope. Suppose the rope to be held horizontally and a very small section marked

so as to distinguish it from the rest. Let this portion be viewed through a narrow vertical slit of considerable length. If now an undulation be sent along the rope by moving one end up and down rapidly, the mark will be seen to travel up and down the viewing slit. Thus, in this case, the parts of the vibrating material move at right angles to the direction in which the wave form travels; i.e., in which the energy is transferred. This is typical of the class known as *transverse* waves—the category to which light radiations belong.

Some of the more important terms used in connection with vibratory phenomena may be understood by reference to Fig. 20. A is the amplitude or maximum displacement of a particle from its rest position. This is important as a measure of the intensity—the loudness of a sound or the brightness of a light. λ (lambda), the distance between consecutive crests, is called the wave-length. The number of complete wave-lengths sent out per second is known as the frequency, generally designated by the Greek letter ν (nu). Suppose a vibrating source sends out ten complete undulations every second, each two feet long; clearly the fore of the first disturbance—the wave front—must have reached a point twenty feet from the source in one second, if there is to be no overlapping of the wave forms. The distance traversed by the energy each second we call the velocity (V) of the disturbance. From the simple numerical case considered, we are led to an important generalization, fundamental in the study of all wave phenomena. *The velocity is equal to the product of the wave-length by the frequency*—in terms of the symbols defined above:

$$V = \nu \lambda$$

Another important attribute of most, possibly all true, wave disturbances is best illustrated by a common example. Let us attend a band concert given in a large stadium. If our ears are good enough, we shall hear the same tunes

whether we sit well forward or near the rear. Since the various notes played are of different pitch (that is frequency) and loudness (that is amplitude), this must mean that the velocity of sound is independent of these two factors; else the time of the music would be effected. One might argue that sound was not a wave-motion; or if so, traveled with an infinite velocity. Both contentions, however, are easily disproven. Under suitable conditions, sound disturbances may be photographed and shown to behave much like water waves. As to the velocity of their propagation, it may be readily measured by the simple expedient

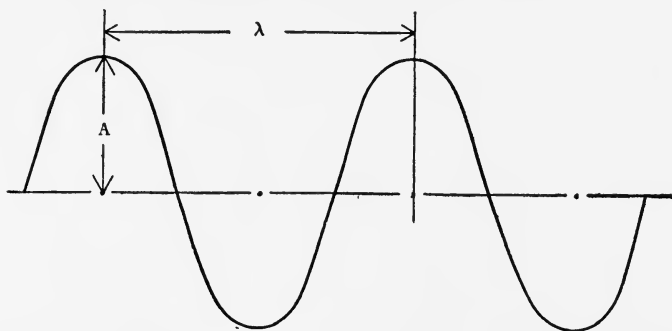

FIG. 20.—This shows a typical wave form, where λ is the wave-length and A , the amplitude.

of timing the interval between the flash and the report of a gun, observed from a known distance. More extended experiments show us that the nature and condition of the vibrating medium are the only factors of influence in determining the velocity of waves of any given type. In this last conclusion lies the keynote to one of the most interesting controversies in the history of physics; one in which the last word has not yet been said. What are light radiations?

Even before the time of Newton, the idea that light was an undulatory disturbance had found some favor. That great genius, however, inclined toward a corpuscular theory; pointing out the observed fact that "light travels in straight

lines," indeed all the phenomena of geometric optics, could well be explained by assuming the rays to consist in extremely small particles projected from the source of illumination. Later, improved optical instruments and more careful observations showed definitely that there were instances where light did not follow a straight path—cases where it actually bent around corners (diffraction). Here was strong evidence for the wave theory since on this basis a much more simple explanation could be given.

Whether wave or corpuscular, the disturbance should have some finite velocity; yet seemingly it travels with infinite speed. In the very experiment that was suggested to determine the velocity of sound, it was tacitly assumed that no time elapsed between the flash at the gun's muzzle and the appearance thereof to a distant observer. The truth of the matter is that the earth is too small a laboratory to detect a velocity as high as that of light; unless we have at our command a very accurate means for measuring extremely small intervals of time. Lacking such a device, early investigators were unable to obtain conclusive results. From the vast laboratory of the heavens came the first evidence that light actually did travel at a finite rate of speed, the work of the Danish astronomer, Römer.

At this point comes a portion of the work of particular interest in connection with our problem. While the experimental workers, by the use of refined methods where the light traveled over terrestrial distances, were still endeavoring to verify and improve Römer's determination, Maxwell suggested a way to obtain the result without making any velocity measurements whatsoever. The determination of one electrical quantity, for example, the capacity of a condenser, in two systems of units already fixed was all that was necessary. Back of the suggestion lay the masterful discussion forming the basis of the classical theory of electromagnetic waves.

Emmissions-Spectra.

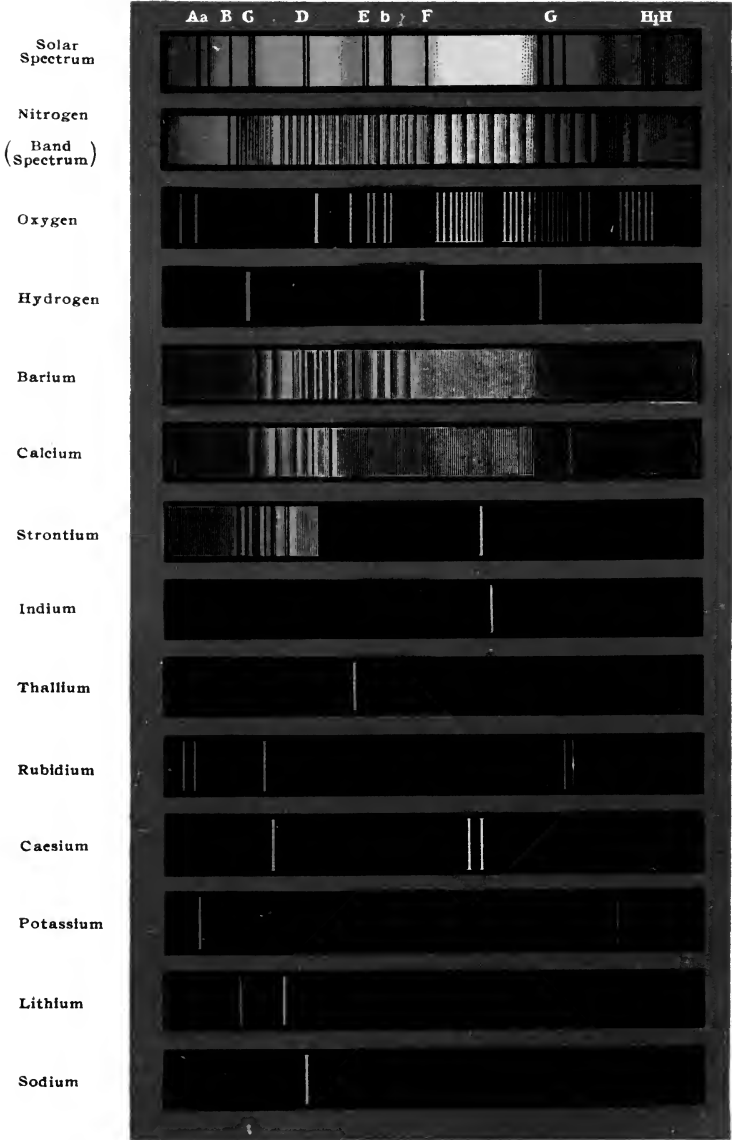

FIG. 22.

The general picture given by this classical theory, as it has been filled in to date, is indeed comprehensive. Many types of phenomena, seemingly unrelated, are included. γ -rays, x-rays, ultra-violet, visible, and infra-red radiations, and radio waves, all fill the requirements for electromagnetic disturbances as described by Maxwell—at least to a fair extent. All have the same velocity— 3×10^{10} cms. per second (where the exponent of 10 indicates the number of ciphers to follow the 3). Recalling the relation given above ($V = \nu \lambda$) it will be seen, that if the wave-length be short, the frequency is high and vice versa. Figure 21 shows how the various kinds of radiations fit into the completed catalog. Figure 22 shows the visible portion of this spectrum, as it is called, in more detail.

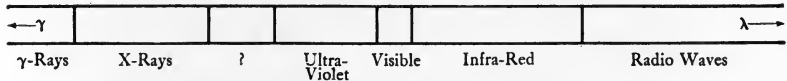

FIG. 21.—Schematic chart of electromagnetic disturbances.

The theory is by no means free from criticism. One of the most obviously questionable features, is the existence of a vibratory medium through which the radiations must pass. In our initial discussion we stressed the fact that in order to transfer energy from one point to another by a wave-motion, a material capable of supporting the wave forms must intervene. The action hinges on the elastic properties of this intermediary. Great quantities of radiant energy come to us from the sun; yet we have good reason to believe that most of the distance between us and that body is extremely close to a perfect vacuum. Far too low a concentration of ordinary matter exists there to support a wave disturbance. To avoid this dilemma it is necessary to hypothecate some elastic medium, distinct from the usual chemical substances, a medium which must be conceived to

fill all interstellar space. The name applied to this, so far intangible something, is "the ether."

Other discrepancies between theory and experiment are most pronounced in the short wave-length end of the gamut as given in Fig. 21. One of these is the well-known case of dispersion—the breaking of white light into its component colors by a prism. The explanation that the short wave-lengths are more retarded on passing through the material of the prism than are the long ones, runs contrary to the idea that radiations of the same type should have the same velocity in a given medium regardless of their wave-length. The deviation being greatest for the short wave-lengths or high frequencies, it is for these that the classical theory becomes most dubious. What the correct interpretation of the variation may be is still somewhat hazy. Unquestionably the electron, that almost infinitesimal unit of negative electricity, holds the answer. As yet, however, there is still much to be learned concerning the interrelation of high frequency radiations and electrons.

In the last paragraph mention was made of the fact that white light actually consists of many different wave-lengths or colors. The proportions in which the different components are mixed depends on the nature of the source of the illumination. Where this is an incandescent solid, there is an important relation between its temperature and the character of the radiation emitted. For qualitative purposes, this may be expressed by saying that the light becomes more intense (more energy is given off) and more of the short wave-lengths are included as the temperature of the emitter increases. See Fig. 23.

The effect may be easily illustrated by connecting a small, 3-4 volt flash-light bulb across a 6 volt storage battery, through a variable resistance. If considerable resistance be left in the circuit the filament will emit no light whatsoever. Nevertheless the outside of the bulb will become

warm to the touch, showing that at this stage the filament is giving off only low frequency radiations invisible to the eye but sensible as heat producers. As the resistance is gradually cut out of the circuit, the filament will first become dull red, then bright red, then yellow, and finally white in

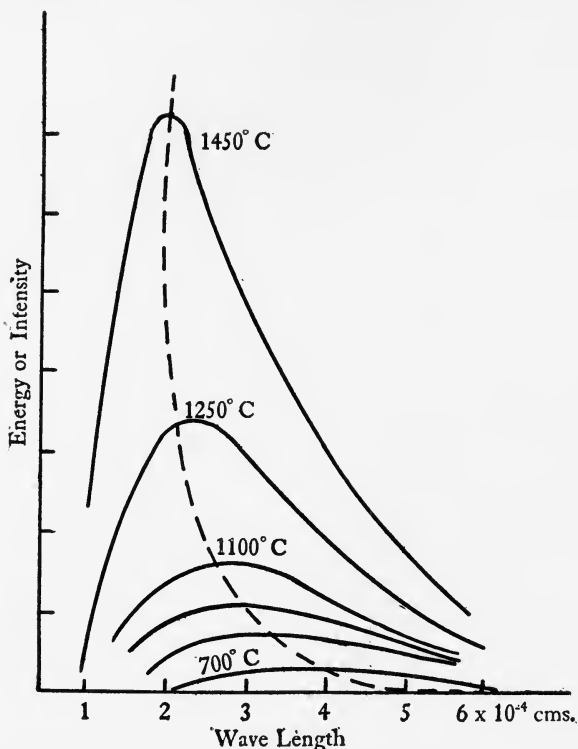

FIG. 23.—Relation of maximum wave-length in emitted spectrum to temperature of emitter. Note displacement toward shorter wave-lengths with increase of temperature.

color—giving off more illumination at each successive stage. A further decrease in resistance will give so much current through the filament wire as to cause it to melt; but just before this happens, the light will become uncomfortably bright for the eyes and will take on a slightly bluish char-

acter—i.e., short wave-lengths are beginning to predominate. As might be surmised from the foregoing experiment, where higher frequency radiations were produced when larger amounts of energy were passed through the wire in a given time; there is a connection between the energy of a radiation and its frequency. The relation is that the energy is equal to the product of a constant (known as Planck's constant) by the frequency. This product, $h\nu$, where h is Planck's constant and ν the frequency of a disturbance, is called a *quantum*,—a bundle of energy. So it appears that we might consider light to *consist of* little packets of energy; yet to *behave* like a wave movement. The two ideas are difficult to correlate; but fortunately in most cases one is of predominate importance. In general when dealing with high frequency disturbances the quantum is most helpful; whereas for low frequencies, the wave serves best.

CHAPTER V

THE SELENIUM CELL

NOT infrequently a consideration of the difficulties arising under one method of attack upon some problem proves helpful in understanding the development of another; we are much more apt to appreciate the new, when we have seen the disadvantages of the old. For this reason we have included in this book a brief account of the selenium cell; even though practically none of the systems now in use for the transmission of pictures or the television of moving objects, employ this device.

Prior to 1873 it was known that selenium, after annealing in the neighborhood of 200° C., became a conductor of electricity—albeit an extremely poor one. The first intimation that the material became more conductive when illuminated came in that year as a chance observation of an attendant in the Atlantic Cable station at Valencia, Ireland, where the selenium was used to produce high resistances. The importance of the phenomenon was quickly recognized. Following close upon the initial observation, we find numerous publications verifying the fact that the conductivity of selenium increases on exposure to light. The names of Willoughby Smith,¹ Sale, and W. Siemens figure prominently among the early workers in this field. More recently other substances have been found to behave similarly, although to a less marked extent: tellurium, thalium

¹ Journal of the Society of Telegraph Engineers, 2, 31.

sulphide, stibnite (antimony sulphide),² and cuprous oxide³ may be mentioned. For further information the following books may prove helpful: "Das Selen" by Dr. C. Reis, "The Moon Element" by Fournier d'Albe, and "Fernphotographie" by Professor Arthur Korn.

Workers in the field of picture transmission quickly seized upon the opportunity presented by the use of selenium to change light impulses into variations of an electric current that might be carried over wires to some distant recording device. All that seemed necessary was to place a selenium resistance, or cell, as it has come to be called, in series with the usual telegraphic circuit. Light, falling on the cell, would decrease its resistance: when the illumination was removed, the resistance would return to its former value. Thus current surges should pass through the circuit at those times during which the selenium cell was illuminated. The method looked promising and attracted much attention. The problem of telephotography—perhaps, even that of television—seemed well on the road to solution. Here was a substance which might be made sensitive to illumination of as low a value as 10^{-5} foot-candles, about the lowest intensity capable of affecting the human eye. Could not an artificial eye—one which would sense the light and shade of an object as does the human organ—be produced?

The problem proved much more baffling in practice than it appears on paper. Sensitivity to variation in intensity is not the only requisite for a light sensory mechanism to be used for picture or object transmission. It must also be capable of reacting rapidly and uniformly to successive changes. In the last requirement, the selenium cell was soon found to be seriously at fault.

Since the term selenium cell has been so often used, it is only fair to describe the appearance of a common type

² Jaeger; Kon. Akad. Amsterdam, 15, 724-30.

³ Pfund; Physical Review, 7 (second series), 289 et seq.

which might be used in picture transmission, before continuing the discussion further. The following brief account applies to the unit made by Giltay, of Delft, Holland; but may be considered as characteristic of most of the more recent methods of manufacture.

A rectangular piece of steatite (a high grade insulating material which is practically non-hygroscopic), some 6 x 3 cms. in size, is wound with two platinum spirals spaced about 0.6 mm. apart. These coils form the two terminals of the cell: the resistance depends on the selenium which is deposited between the platinum wires. After deposition in the plastic form, the selenium is annealed at about 200° C., at which temperature a transformation to grayish, light-sensitive crystals occurs. For the greatest sensitivity the deposit should be extremely thin; hence the resistance of the cell may be extremely high, as much as 250,000 ohms or more. Finally, the cell should be thoroughly dried and vacuum sealed.

For such a cell the change in resistance is approximately proportional to the square-root of the light intensity absorbed per unit time. For the average commercial type, the effect is not the same for all colors; but reaches a maximum for a wave-length in the region of $\lambda = 7 \times 10^{-5}$ cms. in the red. This difficulty may be rectified since it is possible to construct cells giving a maximum even in the blue. Hence by suitable combinations a fairly uniform color sensitivity may be obtained.

A much more serious criticism of the use of the selenium cell, especially in television, lies in the fact that it does not respond instantaneously to a change in the intensity of the light to which it is exposed. Although this inertia is particularly disastrous in work with moving objects, it tends to produce distortion even in picture transmission. Consider the scheme of Professor Korn, described in Chapter II. It will be recalled that here a translucent photographic

film is placed over a glass cylinder which is so moved that a beam of light will pass through every portion of the film in an ordered sequence, thence on to a selenium cell. The object being to produce in this manner fluctuations in a telegraph or telephone circuit which in turn operate a device for reproducing the original on photographic paper. If the effect of the inertia and lag in the cell were simply to delay the current variation, the problem might be solved by suitable retardation of the receiving mechanism.

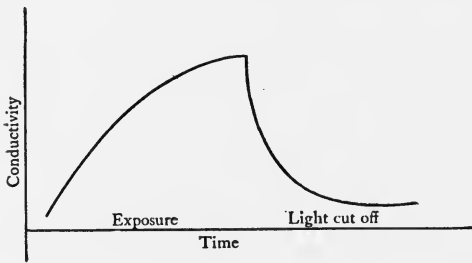

FIG. 24.—Relation of conductivity to exposure time for a typical selenium cell.

Consideration of Fig. 24, however, shows that the response to light is not linear—the greatest part of the change occurs during the first half of the exposure time. Furthermore, when the light is cut off, the conductivity does not return immediately to its former value; but drops rapidly at first, then more slowly, never quite reaching the initial value in any reasonable length of time. This lag in the cell results in increasing values of the “dark” conductivity after each exposure thus producing serious distortion, as may be noted in Fig. 25 reproduced from Chapter II for convenience. Even a casual inspection of the diagram shows that the current plot is not merely a reproduction of the light intensity curve moved to the right on the time axis; but is essentially more rounded, failing to image minor changes in light variation altogether. We would expect the reproduction, therefore, to be lacking in detail.

As previously noted, Professor Korn has succeeded in

counteracting to a fair degree both the inertia and lag of the selenium cell by suitable combination of pairs of cells arranged so that the bad qualities of one will tend to neutralize those of the other. The method involves simultaneous illumination of two cells placed in opposite sides of a Wheatstone bridge, so that the current flowing in the line will be the difference between that in the two cell circuits. With correctly chosen cells the current represented

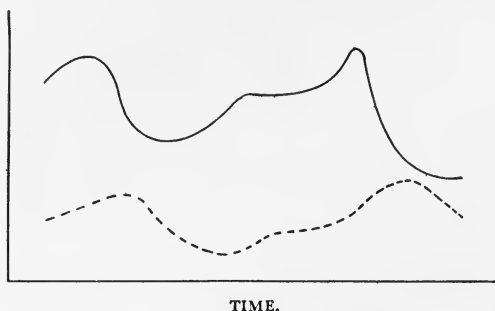

FIG. 25.—Comparison of the fluctuation of light intensity (solid line) and conductivity of a typical selenium cell (dotted line). Note time lag and rounding of conductivity curve.

by this difference fluctuates in fair synchronism with the light variations. For a further discussion of the system, the reader is referred to Professor Korn's book entitled "Fernphotographie" or to "Wireless Pictures and Television" by T. Thorne Baker (pages 28-29).

Other workers have endeavored to devise methods by which the lag of the selenium cell might be overcome. One reported by T. Thorne Baker in "Nature," June 19, 1926, deserves mention. As was stated above, in the normal circuit the "dark" conductivity of a cell tends to gradually increase with successive exposures, an effect which Baker attributed to cumulative ionization of the material. He, therefore, subjected the cell to high frequency alternating current. The constant reversal of direction for such a current makes a continued migration of ions impossible. The

frequency of the current used was much more rapid than the variation in light intensities. In this manner Baker reports that he was able to correct the lag of the cell—to quote: “the lag is automatically eliminated at each alternation of the current with the result that the cell responds with great celerity to changes in illumination and returns to zero with great swiftness.”

A. O. Rankine reported in “Nature,” July 3, 1926, on an interesting series of experiments in which he found that the light conductance could be increased and the “dark” conductance decreased very considerably by careful desiccation of the cell before use. For this reason he was led to attribute the bad effects of “dark” conductivity to a minute film of moisture between the electrodes, i.e., in parallel with the selenium. It will be noted that this checks the ionization theory, since the migration of ions would naturally take place in the aqueous skin layer.

R. J. Piersol of the Research Department of the Westinghouse Electric and Manufacturing Company⁴ contributes still another suggestion for improving the characteristics of selenium cells to be used for the measurement of light intensities. His work indicated that best results were obtained when the thickness of the selenium deposited between electrodes was not over 0.0014 cm. The conclusion was that this represented a maximum depth of light penetration—or rather, the greatest depth effected directly by variation in the incident light. Whereas the material still further from the surface was influenced, the effect was considered to be secondary, transmitted from the primary surface layer; hence not entirely under the control of the light variation. It should be mentioned that Piersol also recorded the fact that absorbed vapors and moisture tended to increase “dark” conductivity.

Let us review the situation. In selenium we have a

⁴ Physical Review, 30 (second series) 664.

substance capable of transforming light and shadow into what might be called an electric record. With suitable preparation the material may be made sensitive to fine gradations in light intensity. In other words, it may be made to produce an appreciable change in an electric circuit for even a small amount of incident illumination. Unfortunately, though, the electric reaction tends to lag behind the light stimulus. True, this difficulty can be remedied to a great extent by suitable construction of the cell. Whereas the results may be satisfactory for the relatively slow speeds used in picture transmission; television, where the image must be scanned completely some ten to sixteen times per second, presents a very much more troublesome case. Hence it is not surprising that experimenters should begin to look elsewhere for a solution to the latter problem.

So far in the discussion nothing has been said as to the cause of the changes observed in the resistance of selenium when exposed to light. Although the question is somewhat beyond the scope of a book of this nature, a brief statement of the principal theories that have been advanced may not be amiss. One of the early suggestions was that, under the influence of light, the metal changed from one to another allotropic form of less specific resistance; then returned to the first state when the illumination was removed.⁵ Another theory, and this appears much more probable in the light of recent research, is that the action of the light is to free electrons from their bonds within the selenium atoms, thus making them available for the conduction of an electric current. In this case the removal of the illumination causes the electrons to be returned to their former "bound" condition. The last concept suggests something akin to the photoelectric effect—"but this," as Kipling would say, "is another story," and leads us to the topic to be discussed in the next chapter, the photoelectric cell.

⁵ Berndt: *Physikalische Zeitschrift*, 5, 121-4.

CHAPTER VI

THE PHOTOELECTRIC CELL

WHEN one reviews the phenomenal progress that has been made during the past fifty years in matters technical, one cannot fail to recognize the importance of the part played by the great genius of those theorists of the last century who set the course which has proven so productive for subsequent investigators. What might now be the condition of our systems of communication, both by wire and by radio, had the keen mind of Clerk Maxwell not formulated the classical electro-magnetic theory? Certain it is that Hertz was activated by the desire to confirm this theory with experiment when he first succeeded in producing and detecting, what we call today, radio waves. Nevertheless, his laboratory oscillator, which so beautifully verified Maxwell's generalizations regarding the properties of electro-magnetic waves—be they radio, heat, or light—also led to the discovery of a phenomenon that marks one of the principal weaknesses in the classical theory. As is so often the case, the exception has attracted as much attention as the rule.

In 1887, while using a spark-gap to measure the energy of the electro-magnetic waves emitted from an oscillating circuit containing a similar gap, Hertz noted a peculiar effect.¹ His method was to adjust the two circuits to resonance, then measure the maximum separation of the points for which sparking could be produced in the receiver.

¹ See "Electric Waves" by Hertz.

Wishing to prevent air currents and hoping thereby to obtain a longer spark, he experimented with a cardboard chimney placed around the receiving gap. This, however, produced just the contrary to the desired effect, requiring the terminals to be brought closer together before discharges would take place. Surmising that this might be due to the fact that the light from the sending gap was screened from the receptor, Hertz used glass to replace the opaque material. The result remained the same. Yet when quartz was used for the screen no diminution of the sparking distance occurred. Since quartz will transmit ultra-violet light, whereas cardboard and glass are alike opaque thereto; Hertz concluded that it must have been this portion of the luminous discharge from the sending gap which in some manner facilitated the production of a spark in the receiving circuit.

It was soon found that ultra-violet radiation from any source would have a similar effect. Hallwachs,² in 1888, made some progress toward a further explanation of the phenomenon. He allowed the radiation from an iron arc, rich in ultra-violet, to fall on a negatively charged zinc plate that was well insulated and connected to an electroscope. The collapsing of the electroscope leaves showed that under this illumination the zinc gradually lost its charge. Yet when a positively charged plate was treated in a similar manner, no loss in charge was observed. A neutral body showed a slight tendency to become positively charged. The suggestion offered was that under the influence of ultra-violet rays a metal tends to lose *negative* charge. The next question naturally is, "What constitutes negative charge and how is it lost?"

Elster and Geitel³ found that those metals which are highest in the electro-motive series—i.e., most chemically

² Ann. Physik, 33, 301.

³ Ann. Physik, 38, 40, 497.

active—showed the effect under consideration most strongly. The alkali metals, which top the list, were acted upon by light of wave-length even in the visible portions of the spectrum. They also pointed out that the action took place with undiminished strength even in the best vacuum obtainable; hence was not dependent upon the presence of gas molecules.

Lenard⁴ demonstrated clearly that ions of the negatively charged material were not involved in the charge transfer, as is the case for electrolysis. He sealed two electrodes, one of sodium-amalgam and the other of platinum, into an evacuated bulb. The circuit was then closed externally through a battery so as to keep the sodium at a high negative potential. When the amalgam terminal, the cathode, was illuminated by ultra-violet light a current flowed in the circuit. The action was allowed to continue until, had the sodium ions been the current carriers, enough of them would have collected on the platinum anode for their presence to have been readily detected by a standard chemical test. No such test was given. Ions were apparently *not* the prime movers in this phenomenon.

It is to the classical experiments of J. J. Thomson performed in the Cavendish Laboratories, Cambridge, England, that we must turn for the answer to our question. Here about 1897, the existence of the electron, the smallest particle of negative electricity, was first proven. The apparatus used in this work is so closely analogous to the cathode-ray oscillograph to be considered in a later chapter that we shall leave the discussion until that point. For the present, suffice it to say that we are now in a position to explain the loss of negative charge without involving either gas molecules or metal ions. We need simply say that under the influence of light waves, preferably of the ultra-violet type, electrons will be liberated from a metallic surface. In

⁴ Ann. Physik, 2, 359 (1900).

the experiments of Hertz, these electrons ionized the air gap, thus rendering it more conductive, easier for the electric energy to cross in the form of a spark. Such electrons, once free, are all alike no matter with what atom they may have been previously associated. So Lenard could detect none of the attributes of sodium on his anode even though the carriers had actually come from that metal.

Electrons liberated from an atom under the influence of light are aptly called "photo-electrons." Just what may be the mechanism of their release need not concern us; so long as we recognize that the optimum conditions are obtained by using a cathode made of one of the most chemically active metals and by using radiation of short wave-length typical of the ultra-violet end of the spectrum.

The question in which we are most interested is "How may the photoelectric effect best be utilized to solve the problem of television?" It will be apparent from the preceding discussion that we now have another method for converting light changes into electric currents. What advantages or disadvantages does it possess when employed in television?

Stoletow,⁵ as early as 1890, devised what might be termed the first photoelectric cell—a device which produced a photoelectric current when illuminated. Referring to Fig. 26, which illustrates the apparatus used, *C* is a zinc plate connected to the negative terminal of a high voltage battery, *B* (what one would call in radio terminology, a B battery); *A* is a platinum screen connected to the positive of the battery; *G* is a galvanometer for measuring the current in the circuit. Under normal conditions the air resistance between *C* and *A* is so high that no current will flow. When the cell is illuminated so that ultra-violet radiation will pass through the screen anode on to the zinc cathode, the latter will emit photo-electrons. These, at-

⁵ Jour. phys., 9, 486 (1890).

tracted by the high positive potential, cross the air gap to the anode. From that point the chemical action of the battery returns them to the cathode, ready to recommence the circuit. This circulation of electrons constitutes an electric current, although in accordance with an old convention we

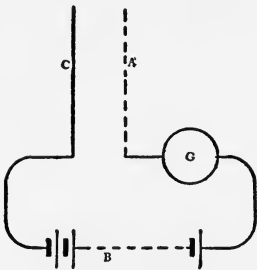

FIG. 26.—Apparatus as used by Stoletow in studying photo-emission.

designate the direction of the current as the reverse of that of electron flow. Since the electrons have almost negligible mass, only one two-thousandth that of the hydrogen atom, the action of the anode field will give them an extremely high acceleration. Once freed from the cathode by the action of light, they will bridge the gap to the positive terminal with velocities approaching that of light itself. Indeed, the entire action is as nearly

instantaneous as we could wish. Here is a distinct advantage over the use of selenium cells, or any of the other systems requiring the movement of a stylus having mass.

Though the photoelectric cell, so described, may possess this one very desirable quality—speed of reaction; nevertheless, it has several very troublesome features. In the first place, the size of the current which is produced in such a cell, even by the intense illumination of a carbon arc, will be very small unless ionization occurs in the gas between the electrodes. Secondly, when such ionization does take place, the characteristics of the cell become uncertain—its response no longer being proportional to the intensity of the incident illumination. Thirdly, if the cathode be zinc, as above, ultra-violet radiation will be necessary for the reaction.

The work of Elster and Geitel, mentioned above, suggests a possible remedy for the last two difficulties. If the electrodes be sealed in a highly evacuated bulb, the troubles

arising from gaseous ionization can be eliminated. (The discussion to be found in Chapter VII on the action of discharge tubes will make this point more clear.) Again, if we replace the zinc by one of the alkali metals—sodium, potassium, rubidium, caesium—ordinary white light will suffice to free photo-electrons from the cathode. This last is a most distinct improvement since any intense source of illumination may now be used and the cell may be made of glass.

There still remains, however, the problem of increasing the current output. Suitable preparation of the cathode was found to help somewhat. Elster and Geitel produced a hydride of potassium by bombarding the metal with electrons, in an atmosphere of hydrogen. They also deposited the metal in a colloidal form. Both schemes gave increased sensitivity, the last mentioned being the better, albeit the more difficult method. The General Electric Company followed the practice of silvering the inner surface of the bulb, later heating a circular portion so as to drive off the silver; thus leaving an opening to admit illumination. Over the remaining silvered part, there was then deposited an extremely thin layer of distilled sodium, potassium or rubidium. In this type, the anode is a tungsten wire usually to be found in the form of a loop at the center of the bulb. (See Fig. 27.)

These vacuum cells are extremely reliable in their action. One type,⁶ now on the market, is claimed to be so free from the fatigue characteristic of the selenium cell that "it will

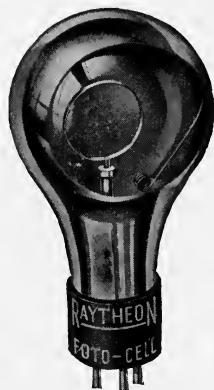

(Courtesy of Raytheon Mfg. Co.)

FIG. 27.—A typical photoelectric cell. Note anode, circle of wire at center of bulb, and standard vacuum-tube base, only two of whose contacts are used in the usual circuit.

⁶ Bulletin No. 271, Dr. R. C. Burt, Pasadena, California.

record direct sunlight (10,000 foot-candles) all day and immediately afterward accurately measure the light from a flashlight bulb at one meter." For a given applied voltage the output is directly proportional to the intensity of the incident light, as may be seen by reference to Fig. 28. Such properties make this form of cell very useful in photometric work. Yet when we consider that a 60 c.p. lamp only 6 inches distant gives a current of something like

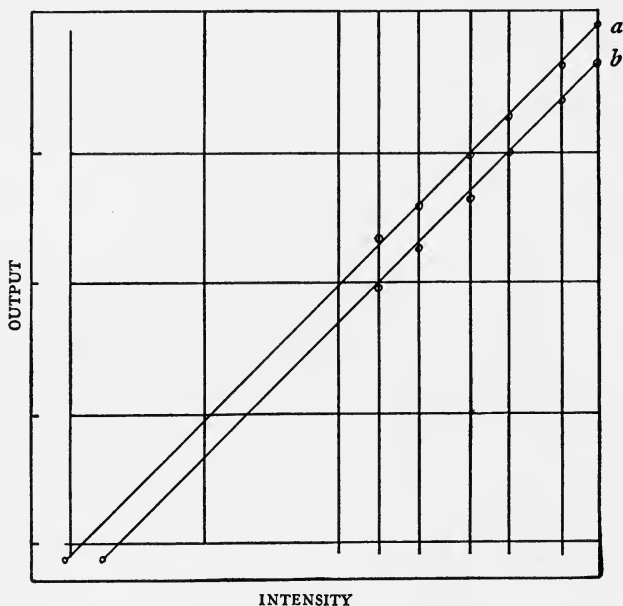

FIG. 28.—Relation between the intensity of incident illumination and the output of a typical photoelectric cell: *a* is for a higher applied voltage than *b*.

$1/10,000$ of a milliamperere, it is obvious that a great deal of amplification is necessary before a picture transmission or a television circuit can be operated.

Not until the perfection of the three electrode vacuum tube was even a partially satisfactory solution of the difficulty found. This device, so well known for its service in the radio set, provides a most excellent means for am-

plifying the small output of the photo-cell. Figure 29 illustrates a typical circuit used for this purpose. At this point, it should be remarked that the screened grid vacuum tube is extremely well adapted to this service.

Unfortunately, there are limits to the amount of amplification that it is advisable to produce in vacuum tube circuits. The restraining factor is the trouble introduced by the amplification of extraneous circuit noises. In picture transmission these evince themselves as spots; in television, as irregular, wavy lines across the image as viewed through the scanning-disc or on the screen. Recent work of J. B. Johnson of the Bell Telephone Laboratories, New York City,⁷ seems to show that the origin of a large proportion of such noises is not in the vacuum tube itself, as was originally thought, but rather in the flow of electrons through the resistances of the circuit. A photo-cell designed by Zwory-

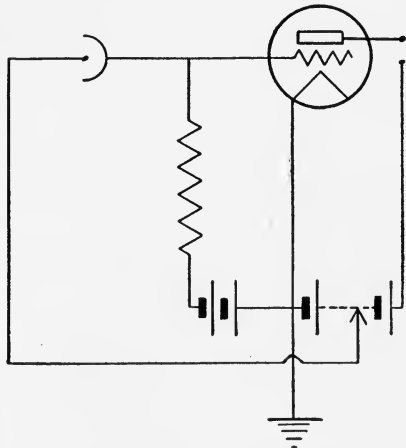

FIG. 29.—Use of a vacuum-tube amplifier in connection with a photoelectric cell.

kin of the Westinghouse Electric and Manufacturing Company, tends to reduce this effect to a minimum by the combination of the photoelectric cell and a three or four element vacuum tube within the same bulb. Of course in this instance care must be exercised to screen the photo-active surface from the light given by the vacuum tube filament. The method employed, is to use the oxide type of filament which need only glow dull red and to locate the vacuum tube in the stem, separated by a light-tight

⁷Physical Review, 32, No. 1, p. 97.

diaphragm from the photoelectric cell in the bulb. There still remains the difficulty in preventing the heating of the unit by radiation from the vacuum tube filament.

When applied to television, the combination of vacuum tube amplification with the high vacuum type of photoelectric cell still leaves much to be desired. In picture transmission, the conditions are not quite so exacting; for we may use a very intense source of light focused on a small portion of a specially prepared photographic film which covers the photoelectric cell. In television, on the other hand, we must deal with light reflected from the object to be transmitted. The magnitude of the problem involved here may be gleaned from the fact that the human face, even in the lightest portions, reflects only about 1/1000 of the light incident upon it; nor can a source of high intensity be used because of the discomfort occasioned the subject.

Oddly enough, what appears at present to be a solution lies in just the action that early workers found vitiated their photoelectric cells—gaseous ionization. Careful investigation has shown that the fatigue observed in gas-filled cells is not a necessary concomitant of ionization. Rather it appears that contamination of the photo-active surface is responsible. If, then, an inert gas, such as argon or helium, be carefully purified before admission to the cell, we should be able to obtain the increased output occasioned by the fact that the gas ions give us an increased number of current carriers; without incurring the irregularities of the poorly evacuated tube. This is just what *is* done in practice. The purification of the gas to be used must be performed with extreme care, as even the slightest trace of impurity tends to devitalize the photo-active material.

The action of gaseous ionization may be employed in a second tube rather than in the photo-cell itself. In this case, the photoelectric action may be regarded merely as a trigger which, through the gas-filled relay tube, releases

large energy pulses. An example of this may be found in the Knowles' Relay.⁸

Another feature of the potassium hydride photoelectric cell, which causes some trouble in television, is that its sensitivity is by no means the same for all colors. Reference to the curve given in Fig. 30 shows clearly that the response to red light will be only about $\frac{1}{3}$ of that to violet, for the same intensity. The usual photographic film possesses very nearly the same property; possibly for somewhat the same fundamental physical reason. In any case, we may visualize the defects in the televised image by consideration of the familiar snapshot.

Whereas a red object and blue object may seem of

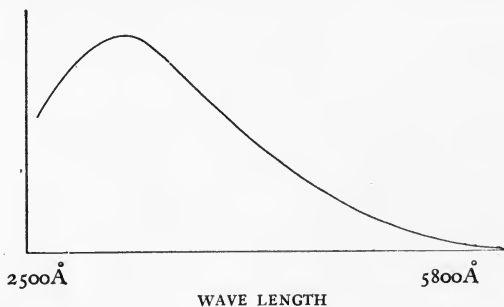
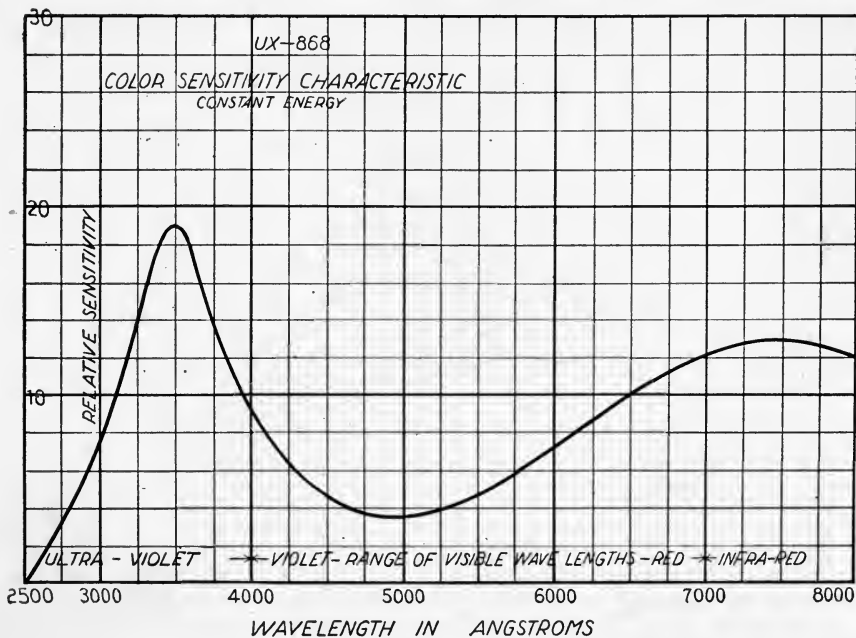

FIG. 30.—Sensitivity curve for a typical potassium hydride photo-sensitive surface. Maximum occurs in the upper ultra-violet region, about 3650 Å.

equal brightness when viewed directly, when photographed on the usual film or plate, developed and printed, it is quite possible that the blue one will appear much the brighter of the two. It should be recalled that the color of objects, when illuminated by white light, depends on the wave-length of the light reflected. Or rather, a material will absorb certain wave-lengths and reflect others—the net result or color sum of those reflected is what we call the color of the object. Hence a red substance does not necessarily

⁸ See Chapter XVI.

reflect only red, but the probabilities are that long wavelengths, typical of the red end of the spectrum, predominate in the reflected radiation. Such an object will have but little effect on a photoelectric cell; just as it has little effect on the average light sensitized plate. In other words, red subjects—or red parts of a subject—when televised will appear dull on the reception screen, even though bright in the original. If the neon lamp be used in reception, giving



(Courtesy of the General Electric Co.)

FIG. 31.—Sensitivity of caesium type photo-cell.

a red glow to the entire image, this effect becomes even more unnatural.

Judging from the evidence on hand, this difficulty is now well on the road to solution. The research laboratories of the General Electric and of the Westinghouse Electric companies have succeeded in producing a cell which gives

very much better sensitivity in the red than any previous type. Indeed, it will be noted from Fig. 31 that there is a distinct peak in the region of 7500 \AA . The effect is produced by a specially treated caesium surface. Quite

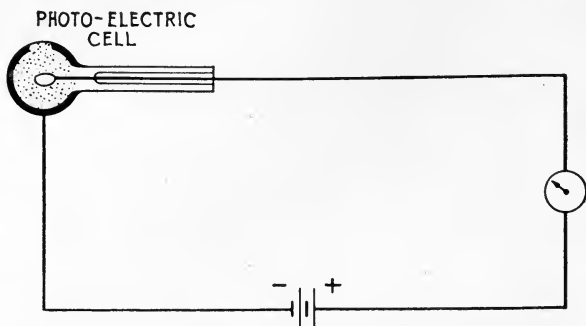
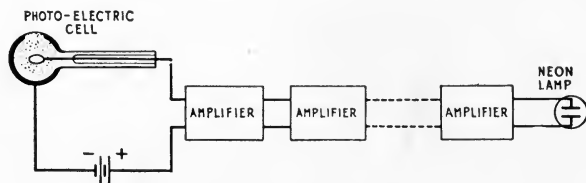

FIG. 32a.—The essentials of a photoelectric cell circuit.

likely subsequent research will develop other photo-active coatings having different color characteristics, so that by suitable blending, a response to all colors may be obtained which is comparable to that of the human eye.



(Courtesy of Bell Telephone Laboratories.)

FIG. 32b.—Extension of the circuit of 32a, to illustrate function of photo-cell in a wire television system.

Before closing a chapter on the photoelectric cell, some mention should be made of the wide variety of uses to which it may be put, other than in the field of television or picture transmission. As was stated above, the vacuum type of cell is most satisfactory for work in which high pre-

cision is required. This type may be used for photometry; or with a relay, for the operation of various alarm systems for protection against both fire and theft, the sorting of materials according to color, the inspection of metals for rust spots or flaws, the control of artificial illumination, etc.

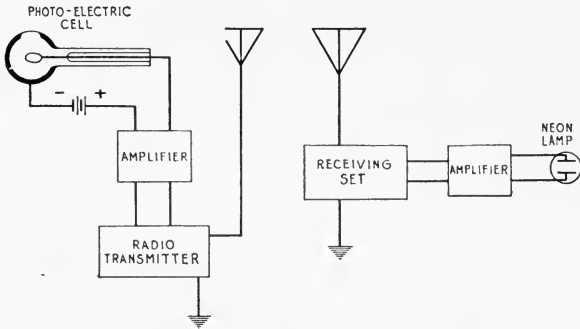

(Courtesy of Bell Telephone Laboratories.)

FIG. 32 c.—Extension of circuit of 32 a, to illustrate function of photo-cell in a radio television system.

One even wonders whether it has not been credited with superhuman intelligence when one finds that Dr. Phillip Thomas of the Westinghouse Co. has devised a method of traffic control for outlying districts, the brains of which is a *photoelectric cell!*

CHAPTER VII

GLOW LAMPS

IN previous chapters, we have already learned the fundamentals of television. At the sending end it is necessary to convert varying light intensities into corresponding electrical variations; then to change the latter back to varying light intensities at the receiving end. We must, then, have some device which reverses the action of the selenium or photoelectric cell. Electro-magnetic valves are perhaps the easiest to understand; but where the problem is one of transmitting an animated object the inertia of the moving parts of any such device make it impractical.

It is well known that the brightness of any electric lamp depends upon the current through the filament. Yet in the case of an incandescent lamp the heat is so great that as much as a tenth of a second may elapse before a decrease in current produces a corresponding drop in brightness. Where changes in light intensity may reach as many as 20,000 variations a second, the absurdity of attempting to develop a source of this type is obvious.

Fortunately there has been developed a lamp, known as the glow lamp, which is able to follow variations in current as rapidly as 100,000 cycles or changes per second. This is all that could be desired. One of the best known of these is the neon lamp developed by D. MacFarlan Moore. Another the Aeolight, using helium, was developed at the Case Research Laboratory. The last mentioned is used extensively in photographing talking movies. Lights using the glow from neon and from mercury vapor are now

common in advertising signs. They are the tubular signs which glow amber-red for neon and blue-violet for mercury. Not infrequently mixtures of inert gases with mercury are used to produce other colors.

To understand the action of these lights it is necessary to know something of the fundamental nature of both matter and electricity. These two are essentially one and the same thing for it has now been established, beyond a possibility of a doubt, that all matter is formed of two kinds of building blocks—positive and negative electricity. The ninety-two chemical elements differ only in the number and arrangements of these blocks. From these ninety-two all compounds may be formed by using the elements in different combinations. The number is almost without limit. It is also established that, for each element, there is a central positive nucleus which consists for the most part of positive electricity held together by a few negative particles or electrons, as they are called. Outside this nucleus, revolving around it much like the earth revolves around the sun, are additional electrons to make up a total equal to the number of positive particles or protons in the nucleus. At the present time there is a discussion as to the exact nature of the electrons, whether they may be regarded as solid particles or as waves of some sort. The outcome of this, however, will make no appreciable difference in the picture here presented.

An atom is only in a stable condition when the total number of electrons in it is equal to the total number of positive particles. If for any reason a negative particle is knocked out of the atom, another will sooner or later be acquired. That is, if through some accident an electron is torn away, the atom becomes at once on the lookout for a replacement. The desired electron on entering the atom and falling toward the nucleus loses energy. Since it can only fall in steps, like a marble rolling down a flight of

stairs, the energy will be given out in pieces. The size of these will depend upon the distance apart of the possible orbits in which the electron may pause; just as the kinetic energy lost by the marble, if it stops on a given step, depends upon how great was the drop from its last resting place. The energy which the electron gives out is detected by us as light whose color is related to the size of jump from one orbit to another. The drops in the case of the electron, as for the marble, may be several steps at a time.

If electrons are in some manner set free from the atoms and are made to flow through a wire, an electric current is produced. Due to definitions introduced into the study before the exact nature of electricity was known, the current is said to flow in a direction which is the reverse of that taken by the electrons. The current is said to flow from plus to minus, whereas the electrons flow in the opposite direction. As the positive particles are nearly two-thousand times as heavy as the electrons, they are sluggish and hardly move at all in comparison. This fact that electrons flow in a direction opposite to the current, frequently leads to confusion.

Now we know that, whereas electricity will flow through a conducting wire under a few volts, it requires about 28,000 volts to the inch to make it flow through air. When it does so, the form taken is a spark resembling a lightning flash on a small scale. When such a spark is produced between the ends of two wires or electrodes, it is because electrons from one of them have been projected by the high voltage with sufficient velocity to break up atoms of air which they strike. The flash is due to the light given off on recombination of electrons with atoms.

If the wires are sealed into the ends of a tube as two electrodes and the air pressure reduced, the spark will pass with much greater ease. In this case the electrons sent out go much farther before striking an atom and so acquire

enough velocity to break it up even when the voltage is greatly reduced below the 28,000 volts to the inch value. If we continue to reduce the pressure the spark becomes quiet and fattens out, soon to fill the entire tube with a glow known as the positive column. At this stage the original electrons disrupt atoms and the plus and minus parts of these, joining the stream, in turn break up other atoms. And so the action goes on. A condition of ionization exists, where ions are everywhere in the tube.

The positive column eventually becomes separated from the negative electrode by a dark space, the electrode itself becomes covered with a luminous glow which extends over its surface and is called the negative glow. From this we go on to the striated condition and eventually to the x-rays,



FIG. 33.—When a certain stage of rarefaction is reached in a discharge tube the glow breaks up into striations.

but we need not consider these conditions for the present problem. The glow in various parts of a partially evacuated tube is shown in Fig. 33.

The neon glow lamp represents just such a phenomenon as has been described above. It consists of two electrodes in a tube of rarefied neon, evacuated to such a point that the negative or cathode glow is present. The brightness of this glow is very sensitive to current changes, a fact very useful in television. As the current varies the number of ions produced changes; the number of electrons falling back into atoms changes, hence there is a change in the amount of light produced. The entire effect takes place so rapidly, as has been said, that variations as rapid as 100,000 per

second can be followed. In fact even this may not be the upper limit.

Just why neon is used instead of some other gas may be a question. The answer is given in the brightness which can be produced by very feeble currents in that gas. The next best is mercury vapor, but this is not practicable since

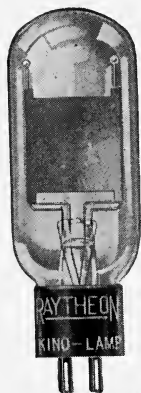

(Courtesy of Raytheon Mfg. Co.)

FIG. 34a.

FIG. 34a.—The Raytheon Kino lamp uses neon as the rare gas. It is intended primarily for amateur use.

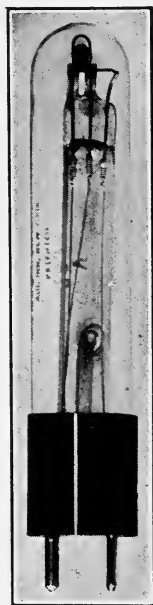

(Courtesy Case Research Laboratory, Inc.)

FIG. 34b.

FIG. 34b.—The Aeon light is used largely in making talking motion pictures. The gas used is helium.

heating is required. Advertising signs are frequently made with neon and mercury. The neon starts the sign and the heat from the resulting current is sufficient, in fair weather, to vaporize the mercury. In cold or windy weather such signs are frequently streaked with the pink glow of neon.

Neon has another considerable advantage aside from the brightness obtainable. Being one of the inert groups it does not readily combine with any materials or impurities of the electrodes. Furthermore, neon is not subject to as great absorption by the glass and other parts of the tube as are other gases. Neither is it occluded to any extent; later to be evaporated into the tube. As such tubes are very sensitive to pressure variations all this is of the utmost importance.

Types of neon tubes are shown in Fig. 34. Some are so arranged that the negative electrode is in the middle, for the purpose of concentrating the light for easy focusing by a lens system. Small lamps of this type use only about $\frac{1}{10}$ watts. For this reason they are coming into use as pilot lights to warn the user when the power is on in any electrical device. A single one of these lamps uses so little power that it will not turn the usual electrical meter.

Where a large viewing screen is to be shown to an entire audience thousands of these little lamps would be required. To avoid this the Bell Telephone Laboratories have devised a multiple lamp of the same sort. This consists of a long tubing through the center of which runs a spiral wire. The wire constitutes one electrode and rectangles of foil pasted on the outside of the tube at regular intervals act as the other electrodes. The action takes place through the glass. As contact is made with a given piece of foil the tube lights up at that point. Thus we have the equivalent of a great number of lamps; when, in reality, it is but a single tube. The tube is bent back on itself a number of times so as to form a rectangular screen, as will be noted in Fig. 35. Its use will be better understood when the chapter on the Bell Telephone system of television is read.

In the Case Aeo light used chiefly in making talking pictures and shown in Fig. 34*b*, the gas is helium. The tube is of glass, or sometimes quartz to allow the emission

of the ultra-violet rays, for their actinic effect is large. It is a little over an inch wide and about six inches long. The anode, or positive electrode, is nickel and the cathode, or negative electrode, platinum coated with a mixture of

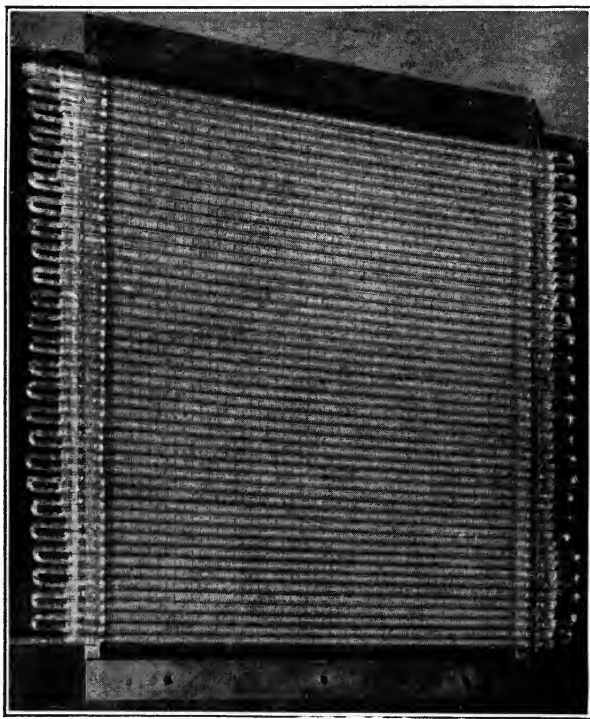

(Courtesy of Bell Telephone Laboratories.)

FIG. 35.—The neon lamp shown above is the equivalent of many of the simple type. The tube, which winds back and forth, has a central electrode and at frequent intervals there is pasted tin foil strips on the outside. When a contact is made to one of these strips the tube lights up at that point.

alkaline earth oxides. The cathode is "U" shaped and is activated during manufacture. The lamp operates on about 350 volts and draws ten milliamperes.

It is obvious that if lamps could be produced such that three, or at least two, complimentary colors could be ob-

tained that we should then have the necessary tools to secure television in natural colors. Baird was partially successful in color television in 1928. He used a neon bulb for the red and a second bulb which combined the greenish-blue of mercury with the blue of helium. The experiment was a success in so far as the limitations of the lamps permitted. A picture was sent first with one color and then with the other, filters at the sending end being used to correspond with the lamp colors at the receiving end. A commutator in synchronism with the filter control threw in first one lamp and then the other.

It would seem at first thought, that a system using three lamps would require that the television process be increased to a speed three times that of the single color type to avoid flicker. As few objects are of so pure color as to appear in one picture and not to appear, at least faintly, in another; a much slower speed than would be supposed was sufficient.

Probably the only satisfactory way of describing the operating characteristics of a glow lamp is to consider some special one as an example. For convenience let us choose the so-called Raytheon Kino lamp. (It should be understood however that neither the authors nor publishers in any way recommend any particular piece of apparatus. This lamp is chosen only because considerable data on its operation is at hand and because its operation is typical of lamps of this class.)

The Kino lamp does not attempt to reduce the neon glow to a small spot for focusing, as do some of those previously described; but rather spreads it out over a large surface. The intention in this is that the negative glow should cover an area equal to that of the framed picture received. As the plates are about one and a half inches square, this is the size of picture which can be received with the lamp. The design is intended for amateur use. The arrangement of the plates in this lamp is such that one may

view the negative glow on one of the plates without any obstruction to vision from the other plate. Thus the life of the tube may be prolonged by reversing the terminals when one side of the tube has become blackened.

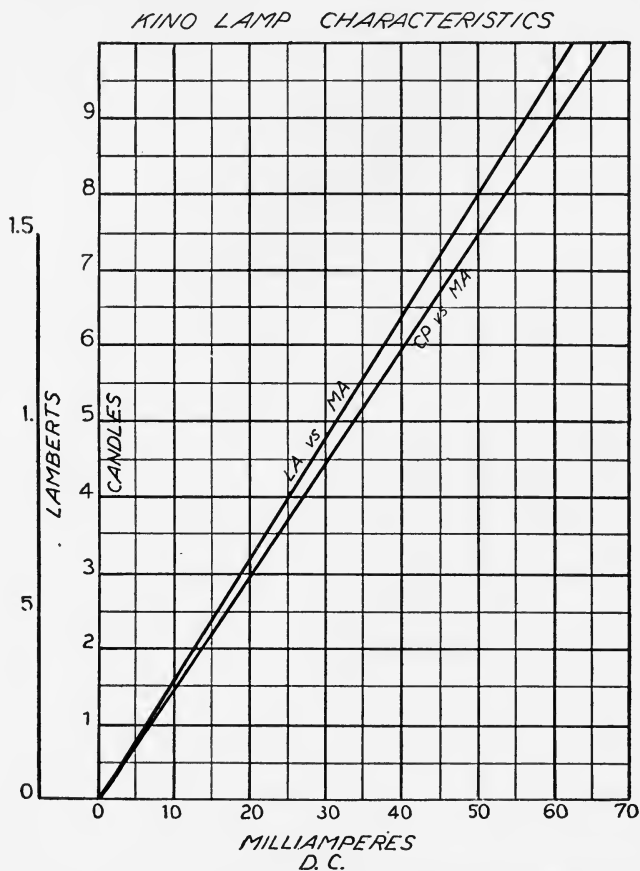

(Courtesy of Raytheon Mfg. Co.)

FIG. 36.

These lamps are current operated. In order to get maximum contrast between the light and shade of a picture it is necessary that their brightness change over a maximum range with current change. The lower curve, Fig. 36,

shows the relation between current in milliamperes and the candle-power. The upper one shows the same relation with Lamberts. A candle-power is distinguished from a Lambert in that the former is a measure of the luminous inten-

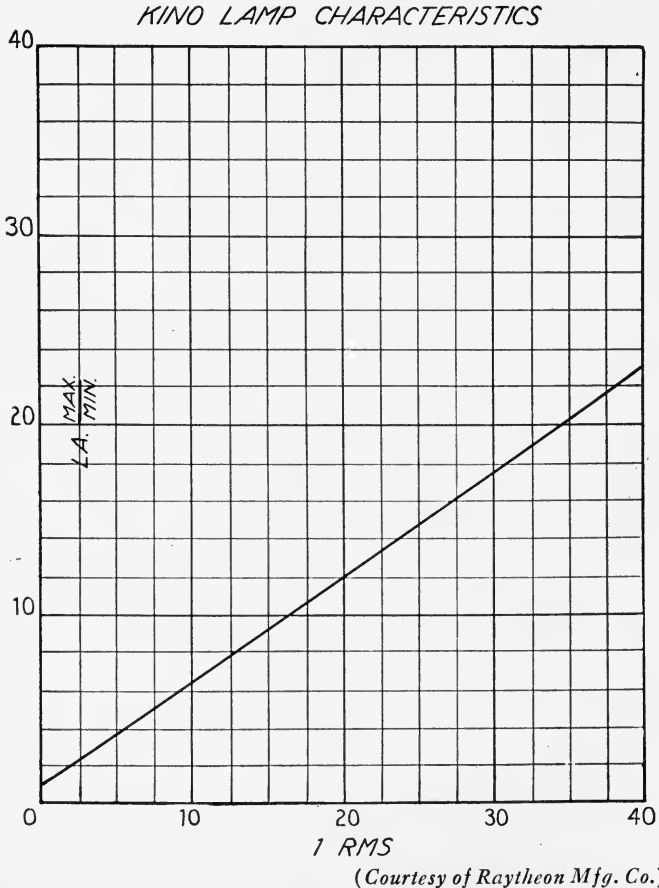

FIG. 37.—As the current increases the ratio of maximum brightness to minimum brightness increases.

sity which leaves the lamp; while the latter is measured by the brightness of the light producing surface itself.

It will be seen that the more nearly vertical these lines

the greater the change of light intensity for a given change in current. This then is an important feature of any such lamp. Straightness is also desirable in the lines, otherwise the comparison of light and shade will be distorted. If the

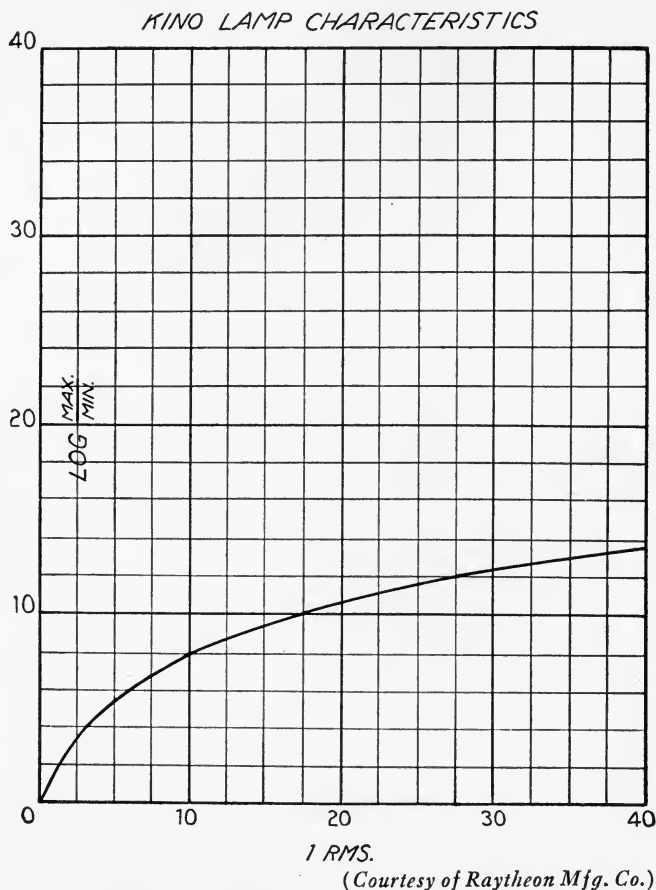

FIG. 38.—The curve above shows the relation of maximum brightness to minimum brightness from point of view of visual contrast.

curve became horizontal over any portion it is obvious that here, at least, all variation of light and shade would disappear in the received image.

Furthermore, since the curve is a straight line and since the eye is less sensitive to variations in light of high intensity than of low intensity, to run the lamp at a high intensity defeats the purpose of contrast as well as shortens the life of the device. It will be seen however from Fig. 37 that as the current goes up the value of maximum brightness to minimum brightness increases. On the other hand the curve shown in Fig. 38 shows what the relation is from the point of view of visual contrast; the visual contrast being roughly proportional to the logarithm of the actual contrast. From this it will be seen that nothing much is gained by running the tube above forty milliamperes.

In the operation of these lamps a background direct current voltage is used sufficient to give about ten or twenty milliamperes through the tube. The alternating voltage from the receiving set is impressed on this, but would not be sufficient to light the tube without the assistance of the d.c. voltage. It is thus the function of the d.c. voltage to light the tube, whereas the a.c. from the receiver varies the intensity corresponding to the light and shadows of the scene. Sometimes, where a dark background is desired, the d.c. voltage is adjusted just below the starting value, the additional a.c. being sufficient to operate the lamp.

We have attempted to give a fair picture of the neon lamp, its characteristics and limitations. In selecting a glow lamp for television one should consider thoroughly all these features as they affect the work in hand. The future will undoubtedly see big advances in the construction of such lamps. Greater intensity, greater variation with current, better colors and longer life may be expected. The lack of suitable glow lamps is at the present time one of the greatest obstructions in television development.

CHAPTER VIII

OSCILLOGRAPHS

ONE of the most useful relations between electricity and magnetism is the fact that a current-carrying wire placed in a magnetic field has a force acting upon it. The direction of this force is given by the so-called left-hand rule, as follows: If the left hand is held so that the thumb and two first fingers are mutually at right angles and if the thumb points in the direction of the magnetic field (north to south pole), and if the first finger points in the direction in which the current is flowing, then the second finger points in the direction in which the force will cause the wire to move. Starting from the thumb we have the directions indicated as field, current, motion. This is shown in Fig. 39.

It will help some in memorizing and understanding this rule if we think of the magnetic field as composed of lines of magnetic force, the number of which, for any given cross-sectional area, depends upon the strength of the magnet, the distance from it and the medium in which it exists. These

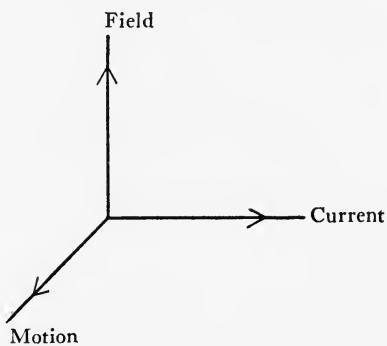

FIG. 39.—The above shows the relative directions, field, current and motion.

lines are thought of as going from the north to the south magnetic pole. In the case of a current-carrying wire, similar lines are considered to surround it, and to run in a

helix, proceeding around the wire in a direction like that of the threads on a right-handed screw. The sense of these lines would be the same as the direction of motion of a point on a thread, if the screw were rotated in the direction of current flow. Now it will be seen, that if the wire is placed in a magnetic field, the lines from this field and from the wire will interfere with each other. Figure 40 shows that at the bottom of the wire, which is carrying current into the paper, the lines from the magnetic field and from the current interfere with each other; while the reverse is true at the top. This will cause the wire to move down, an effect in accord with the left-hand rule. All oscillographs make use of this principle.

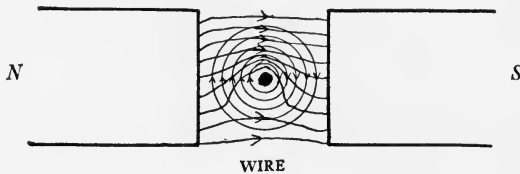

FIG. 40.—If no current were flowing in the wire the magnetic field between the north and south poles would be nearly uniform. If the wire were out of the field of these poles its lines would be circular as they are pictured. When these are brought into the field they result in distortion as shown and there is a resulting force tending to push the wire out of the field.

The string oscillograph is nothing more than is illustrated in Fig. 41. A straight wire is stretched under tension between the poles of a powerful electro-magnet. As the current through the wire varies, the latter is caused to move from one side to the other, depending upon the direction of the current. The amount of movement depends upon the value of the current, the magnitude of the magnetic field and the tension on the wire. To produce a record photographically, a hole is bored through the pole pieces of the magnet and a light placed in line therewith. On the opposite side of the magnet this light casts a shadow of the wire on the photographic apparatus. If the film stood still

there would be a blur produced by this shadow; but if it is pulled through rapidly a curve is traced.

The instrument is extremely sensitive and can be used for measuring changes in different parts of the body due to the heart beat. It is used constantly to diagnose heart troubles. An instrument of this type is properly called an Einthoven galvanometer; but is frequently called a string galvanometer; or when used for purposes of examining the heart, it is called an electro-cardiograph.

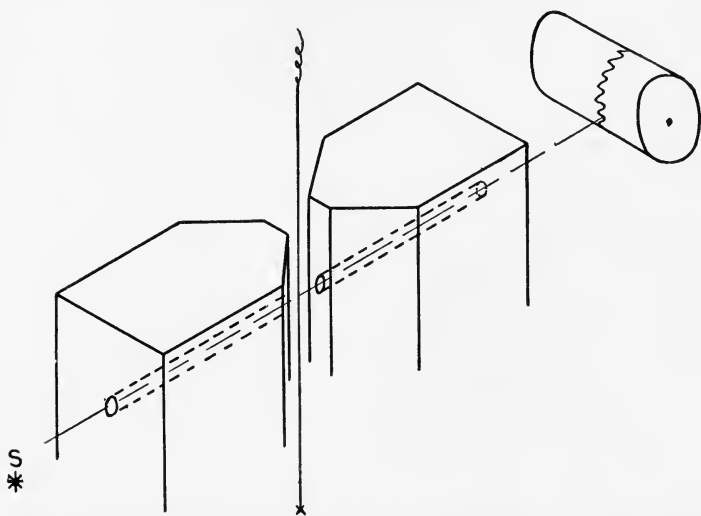

FIG. 41.—The arrangement of parts of a string oscillograph is shown above.

The most common type of oscillograph, one which is more likely to prove useful in television than the string type, is that which uses a "U" shaped loop of wire strung between strong magnetic poles. A small light mirror is attached to these wires and is supported between them. The current goes down one of these wires and up the other; thus in operation one wire will tend to be pushed out of the field in one direction and the other will move the opposite way.

These combined motions turn the mirror and if a spot of light is reflected from it the spot will move. Its motion may be observed visually from a rotating mirror or picked up on a moving film as in the case of a string galvanometer. While the moving part is not as light as is the single string of the Einthoven type, it is sufficiently light to follow vibrations of several thousand per second. For this reason it will be seen that a pair of such vibrators at right angles could be used for directing a scanning spot of light and

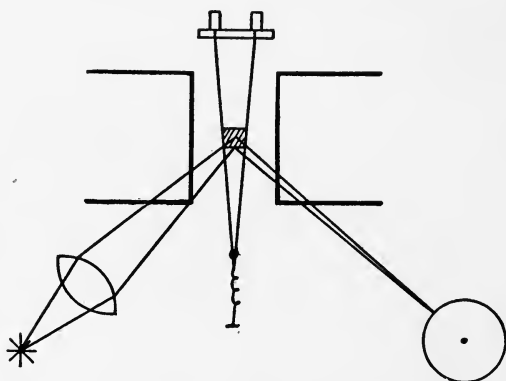
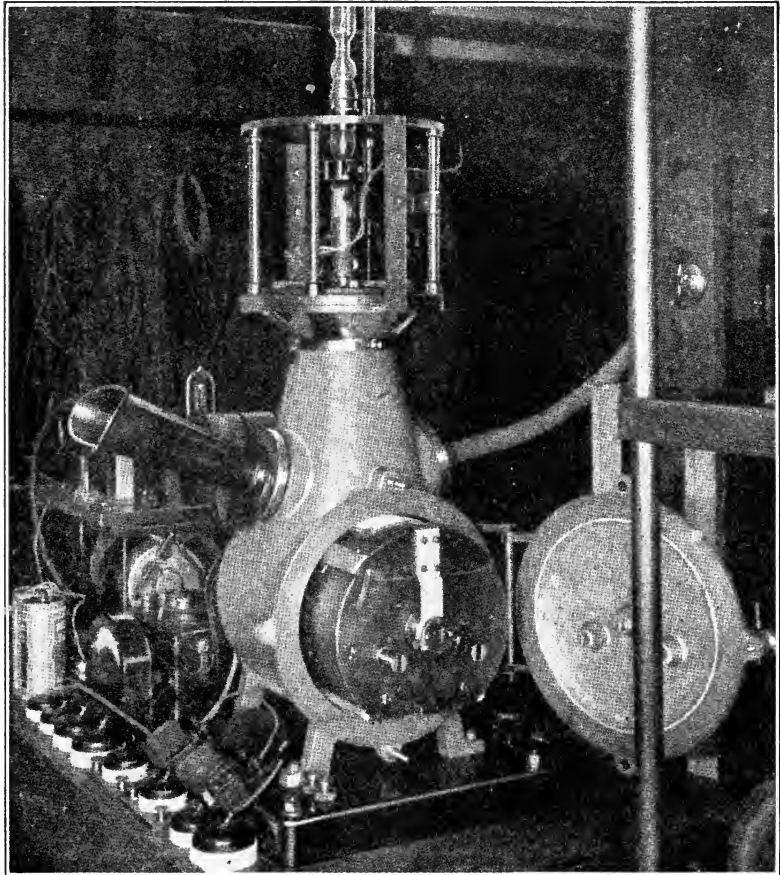

FIG. 42.—A schematic diagram showing the fundamental parts of an oscillograph.

could also be used to reproduce the televised picture at the receiving end. As the inertia of the system to such rapid motion is large, it can only be used with a small screen and in general is not as satisfactory as other systems.

The means by which an electric current is carried through a vacuum, or partial vacuum, was described in the chapter on the neon lamp. If a vacuum is used a high voltage is required because in this case the current must be carried entirely by electrons without the aid of secondary ions. If the electrode is cold this voltage may be fifty thousand volts or more. If, on the other hand, the negative

electrode or cathode is heated a relatively low voltage, of the order of a hundred volts, is sufficient. In either case the stream of electrons can be sent through a pair of pin



(Courtesy of Bell Telephone Laboratories.)

FIG. 43.—The Du Four oscillograph is used to record transient electrical effects of frequency as high as one million cycles per second.

holes in line with each other and the beam restricted to a pencil. These electrons will not spread to any extent due to their mutual repulsion as they traverse the length of the

tube in too short a time to make this possible when high voltage is used. With a heated cathode and low voltage the situation is different.

The electron beam directed through a tube is in every essential the equivalent of a current in the opposite direction; consequently the stream of electrons must follow the left-hand rule. Thus if a magnetic field is placed across this beam it will be deflected, the amount and direction of the deflection being dependent upon the value of the field and the velocity of the electrons, which in turn depends upon the voltage across the tube. The electron stream may also be bent by causing it to pass between two condenser plates which are oppositely charged, the electrons being repelled by the negative plate and attracted by the positive.

The first tube of this type was built by Sir J. J. Thomson for the purpose of measuring the relation of the charge of an electron to its mass and it is frequently called a Thomson tube. The first adaptation of this tube as an oscillograph, the moving part being an electron stream, was in the Braun tube. This tube had the inner side of one end coated with a substance which fluoresced under the action of the electron bombardment so that a spot of light could be seen which moved back and forth with any changes in the field across the electron path. As the Braun tube had to be operated with a very high potential, it required a correspondingly large change in the magnetic field to bend the stream. Its usefulness was consequently limited.

Recently there has been developed a new cathode ray oscillograph by Dr. J. B. Johnson of the Bell Telephone Laboratories. This type employs a hot cathode and uses a voltage of from 300 to 400 volts. While the tube would operate on a lower voltage, this is used to give the electrons sufficient velocity to cause a bright fluorescent spot on the screen. Little is gained in brightness by the use of higher

voltages but at lower voltages the brightness falls too low to be satisfactory.

As has already been said the beam of electrons has a tendency to scatter at this low voltage, as the time to traverse the tube is much larger than at the higher voltages. This is avoided by having a low pressure of gas in the tube which is ionized along the electron stream. Both the ionizing and dislodged electron probably leave the stream; but there remains a positive ion, which because of its great mass relative to an electron, is comparatively sluggish. Thus there is built up in the electron path a pencil of positive particles and the core of the electron path may be said to be a positive space-charge. It is estimated that at any one time during operation that there are as many as four or more positive ions for each electron along the path. The electrons move in a tubular form inside of which is a positive space-charge and outside of which is a blanket of negative charges thrown out by the ionization. Some electrons returning from the target may also be in this outer layer. These two space-charges both tend to hold the moving electrons to a narrow beam, the one by *repelling* them inward, the other by *attracting* them inward. Because of this anything that will tend to increase the number of ions will tend to produce better focusing. Raising the temperature of the filament will send out a greater electron stream which will produce more ions. Thus the filament control determines the sharpness of focus. Argon is used in the tube as argon atoms are the heaviest that can be used of the inert gases. The lighter ions wander too easily from the electron track and so focusing is more difficult.

The screen is made up of equal parts of calcium tungstate and zinc silicate, both of which are specially prepared for fluorescence. The tungstate gives a deep blue light and the silicate, a yellow-green. The former is almost thirty times as effective on a photographic plate as the latter; but

the silicate is many times brighter visually than the tungstate. A mixture of equal parts gives an excellent all-purpose screen.

The tube fits into a bayonet type radio socket to which all connections are made. It is fitted with two pairs of deflector plates. All variations, which may best be measured by their voltage effect, may be connected to these. A magnetic coil outside the glass of the tube may be used for measurements of current variation.

It is not difficult to see how this tube might be used at the receiving end of a television system. The electron beam is limited somewhat in its rate of movement by the possibility of leaving the positive ions behind at the expense of the focus. For all practical purposes, however, the effect is nil. Inertia then is not a problem; but, on the other hand, intensity of illumination is. Perhaps if more intense beams can be produced this device may become an important factor in television reception.

A novel use of an oscillograph of this type has been suggested by A. A. Campbell Swinton. At the receiving end the cathode-ray oscillograph is of the standard type with heated filament and fluorescent screen; but with two pairs of magnetic coils, so arranged that their fields are at right angles to each other. That pair which controls the transverse motion of the beam has an alternating current through it of a frequency of about 800 cycles and that which controls the up and down motion a frequency of about ten cycles. Thus the beam is made to traverse the screen as in any receiving mechanism; but it is free from parts having mechanical inertia.

At the sending end the tube is of a somewhat different construction; for although the cathode ray beam is controlled in the same manner as that already described, it falls upon a screen which is composed of a great number of small cubes. The cubes forming the mosaic are insulated from

each other and contain some photoelectric substance; such, for example, as is used in making photoelectric cells. An image of the scene to be projected is focused on this mosaic, and parts which are strongly illuminated give off more electrons than those on which the darker parts of the image fall.

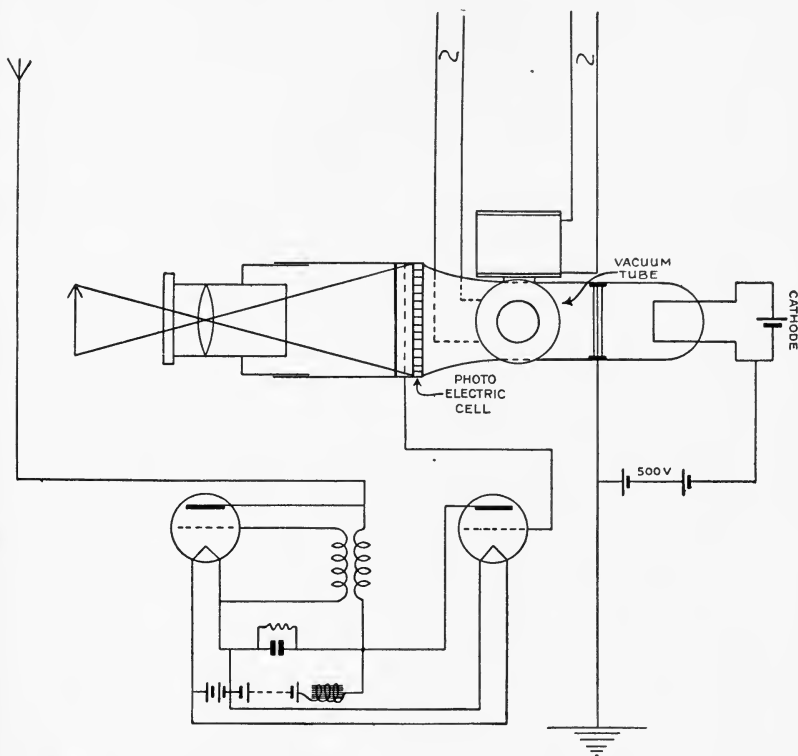

FIG. 44.—The circuit shown above is similar to that suggested by A. A. Campbell Swinton. Light from the object, represented by an arrow, passes through the lens, through a metal gauze, and then through the vapor chamber to the photoelectric cell. The cell, in reality, is a mosaic of separate small cells.

Behind this mosaic is a second chamber which contains sodium vapor, or any other vapor whose conductivity increases under the action of light. When the cathode-ray falls upon one of the cubes of the screen the beam passes

through it into the second chamber and across to the final plate electrode. A current follows this beam from the cube over to the plate connected to the grid of a vacuum tube which it actuates in the usual manner. The current passing depends upon the number of electrons given off from the cube which, in turn, depends upon the intensity of the illumination falling upon it.

While this system has never been put into actual practice it would appear to be one which may eventually solve most of our present-day television problems. Its chief drawback is in the lack of a sufficiently intense cathode-ray beam which can be supplied at a reasonably low voltage.

CHAPTER IX

SCANNING

IN some of the early experiments on television an attempt was made to duplicate the action of the eye, to view a picture as a whole and to transmit each portion of it separately. In the attempt to do this, a honeycomb structure of selenium cells was made and the object placed in front of it. Each selenium cell was connected by its own pair of wires to the receiving system which consisted of a number of lights behind shutters. Light falling upon one of the selenium cells caused the corresponding shutter to open and in this way a crude resemblance of the object was produced. Rignoux and Fournier constructed such a system in 1906 which consisted of sixty-four cells. Both Ruhmer and Baird also constructed similar systems.

But the rods and cones which constituted the electrical detectors in the eye number up into the millions and it is obvious that to attack television from this angle is rather hopeless. We should have to produce photoelectric devices of extremely small size and at the receiving end have a compact screen of neon lamps of much greater efficiency than those now in use and of a size so infinitesimal as to be beyond hope. In addition each of these tiny cells would have to be connected with a pair of wires to the corresponding lamp. This would require an immense cable of many thousands of wires.

As a result of these insurmountable difficulties the trend in television has taken a direction somewhat away from any attempt to duplicate the human eye. The modern method

requires that small portions of the picture be sent separately and in rapid succession over a single pair of wires. The resultant picture is thus made up of a large number of pieces which have been separately transmitted.

In picture transmission no great difficulty is encountered in this method. Either a spot of light is sent through a transparency or is reflected from an opaque picture onto



(Courtesy of Bell-Telephone Laboratories.)

FIG. 45.—Close examination will show that this picture is made up of a number of horizontal lines of varying width.

a photoelectric cell. If the picture is placed on a rotating drum, which revolves on a screw, the spot will follow a spiral path as the drum advances. The variations in the amplified photoelectric current may be made to operate a magnetic shutter, or some form of oscillograph, to produce varying light intensity. Frequently a light beam of varying width is used. This produces a picture made up of lines of varying width as shown in Fig. 45. Variations of this general scheme are numerous.

When we come to television, however, we have before us the problem of greatly increased speed of sending and the difficulty of putting our object on a revolving drum, a method which would first require photographing. The revolving drum must accordingly be dispensed with and other means substituted.

Perhaps the simplest scheme is that used by the Bell Telephone Laboratories which is shown diagrammatically

in Fig. 46. Light from an intense source is focused by a lens in such a manner that it illuminates the whole opening in a frame placed next to the disc. In the figure the source of light is shown as an arc. The frame should be of such a size that its length is equal to the distance between holes in the disc, and its height should be the difference between the radii of the inner and outer holes. If the wheel is stationary, light will come through a single hole in the disc and there will be but one spot of light striking the face of the subject. This will be true regardless of the position of the wheel. The holes are arranged on a spiral in such a

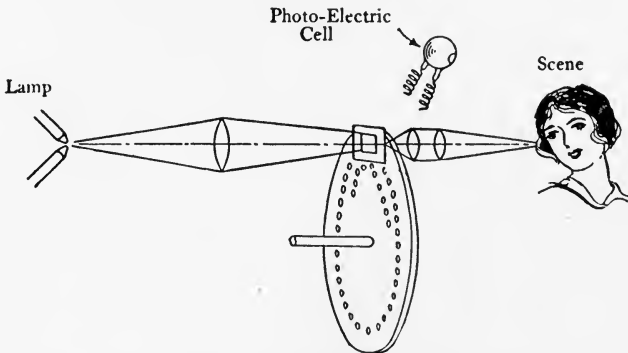

FIG. 46.—Above is shown the simple scanning system employed by the Bell Telephone Laboratories.

relation to the frame that the outermost hole is level with the top of the frame and they run progressively downward until the innermost hole, that nearest the axle, is level with the bottom of the frame. Thus when the disc is turned the light passing through the holes makes successive strips across the subject so that in one complete turn every part of the subject has been passed over by a light spot. The subject has been completely scanned. As the variations in intensity of reflected light take place, three photoelectric cells, only one of which is shown, produce varying current intensity. A row of holes running diagonally across a con-

tinuous belt would perform the same service; but difficulties resulting from stretching or slipping would obviously enter here. As it has no advantage over the wheel except the compactness which can be procured by suitable pulley arrangements, it is confined to laboratory and amateur use. In the case of the circular disc it is advisable to make the holes radial and not circular, as the latter system is inclined to emphasize the strips. More light enters through the centers of the holes, i.e., across their diameters, than enters at the inner and outer edges of the holes. For this reason they should be four sided and bounded by radii and concentric circles for best results.

When a spot of light is used for scanning it is not necessary that the scene to be scanned should be in darkness. The entire scene may be illuminated without interfering with the action of the intense scanning spot. This of course introduces a background of illumination whose effect on the photo-electric cell is to produce a constant background of current upon which the variations due to the scanning spot are superimposed. It might be suggested that an intense beam of light traversing the face of a subject would produce discomfort, but such is not the case. As the spot must scan the entire face in less than one-tenth of a second, if it is to be transmitted, and as the eye is not responsive to changes that take place in less time than this, it follows that the eye does not recognize the spot of light as such. The spot rests upon each portion of the scene only about one twenty-five-hundredth of the complete time for scanning, so that the eye recognizes only an increase in general illumination of one twenty-five hundredth that of the beam when stationary. The scanning process is so rapid that it is not recognized by the subject as such.

The second system to be described is that due to Dr. E. F. W. Alexanderson of the General Electric Company. This consists essentially of a large wheel on whose rim

is mounted a number of mirrors each one of which varies slightly in angle with the next. Thus one mirror will throw a spot of light at one point on a screen, the next one will throw it just to one side of this and so on across the screen. When the wheel revolves a spot will be carried from top to bottom of the screen by reflection from one mirror. The next mirror will then come into play and will cover the succeeding strip and so on. Thus the entire screen is covered. In principle the procedure is the same as that used in the disc with spiral holes. In order to adequately cover a large screen, however, seven spots of light are used in this system so that the speed of the drum may be reduced to a reasonable value and the illumination correspondingly increased.

A third system of scanning by means of a light spot is that devised by M. Dauvillier. In this system two electrically driven tuning forks with their prongs at right angles are used. One vibrates eight-hundred times a second and the other but ten times. If the high frequency fork produced the spot alone it would traverse the screen back and forth 800 times a second. If the slower fork were used it would move over the screen up and down ten times per second. With both forks vibrating it does both these things, traversing the screen rapidly and at the same time moving up and down. Thus the entire screen is scanned ten times per second. In this system there exists the possibility of using the current which drives these forks for synchronizing. A pair of oscillograph systems at right angles may also be used for scanning.

We now come to a somewhat different system, one in which the illumination is uniform and is not projected in a pencil. Here the scanning disc is placed between the scene and the photoelectric cell, whereas in all those systems so far described, it was between the source and the scene. The use of the disc between the cell and scene, as used in early

experiments, was one of the great drawbacks as an extraordinarily intense illumination was necessary. So much was this the truth that in Baird's first experiments dummies were used because of the heat and glare. With improved photoelectric cells, however, this condition is no longer true.

In the Baird system in place of a spiral of holes, as previously described, a spiral of lenses was used. This of course gives greatly increased light collecting ability. Di-

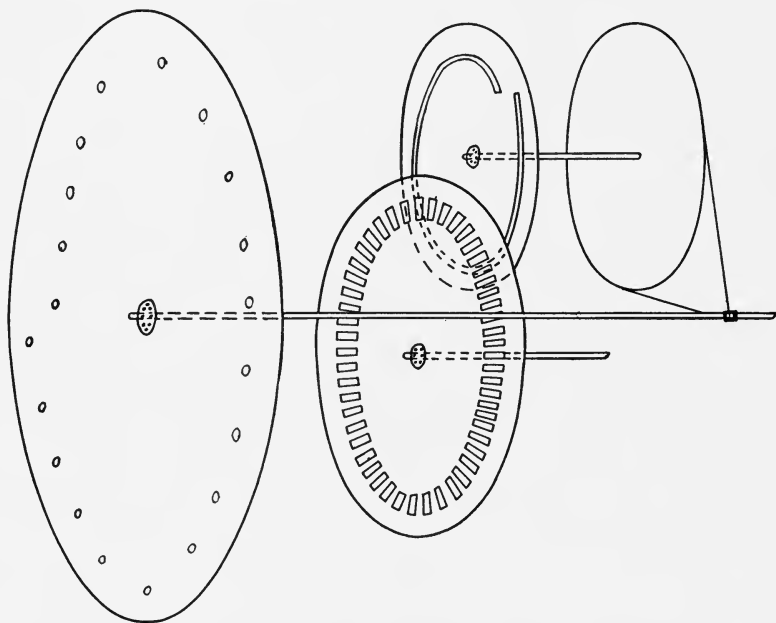

FIG. 47.—Scanning arrangement used in the Baird system.

rectly behind this, revolving at high speed, was placed a slotted disc which might be called a chopper since it successively cuts off the light and allows it to go through. Behind this is another rotating wheel in which a spiral is cut. The arrangement is shown in Fig. 47.

The first disc, carrying the lenses, rotates at about 800 revolutions per minute and the slotted disc at about 4000

r.p.m. The effect of the slotted disc is to break the light up into separate light impulses which produce separate electrical impulses in the circuit. This has an advantage where the changes in intensity are slight or zero; for, in this case, we would otherwise have the equivalent of direct current amplification beyond the photoelectric cell—this is known to be a difficult problem.

The rotating spiral, as will be seen from the mounting shown in the figure, is of relatively slow speed. If the

FIG. 48 *a*.FIG. 48 *b*.

FIG. 48.—As shown in *a* and *b*, the rotation of the slotted disc throws various portions of the scene onto the photoelectric cell. It thus serves to divide it up into smaller portions than would be the case with the lens disc alone.

lens disc were stationary and this spiral disc were revolved, it will be seen that different parts of the scene would be projected through the spiral to the photoelectric cell. Figure 48 shows the disc in two extreme positions. Figure 48 (*a*) shows the spiral at its innermost portion which throws the head of the arrow on the cell. Figure 48 (*b*) shows it at its outermost point, so that the tail of the arrow strikes the cell. As the lens sweeps across the scene the rotation of this disc has the effect of dividing the image produced into additional finer strips. With the combination

it becomes possible to make the strips so numerous as to be little noticed.

A second system of scanning, devised by Baird, is known as the optical lever. This system has the effect of greatly increasing the speed of scanning without increasing the speed of the mechanism over that of other systems. In this system the transverse scanning of the scene is done by two or more lens discs rotating in opposite directions; the up and down movement is provided by a final lens disc. The arrangement is shown in Fig. 49. The image is thrown on a ground glass between each pair of discs placed as shown in the picture. It may not at first be evident that rotating

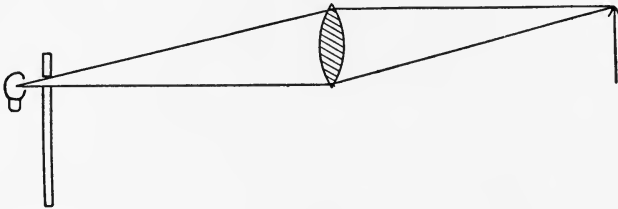
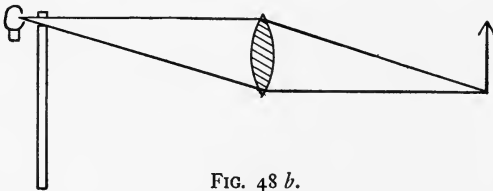
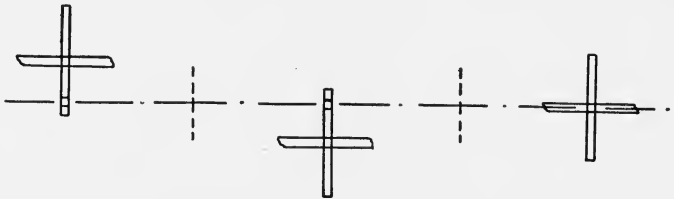

FIG. 49.—This shows the Baird optical lever. The scanned image is thrown onto a ground glass indicated by the vertical dotted line. This is scanned by a second disc and so on. The last disc supplies the up and down motion.

the discs in opposite directions will speed up the scanning process; but considering Fig. 50 should make it clear.

Figure 50 (a) shows what happens to the image of an object when the lens is moved a short distance. The full line represents the original position; the dotted line represents the position after the lens has been moved. Now let us consider a pair of lenses, *A* and *B*, with the ground glass *G* between them as shown. (Figure 50 (b).) The lens *A* will throw an image on the ground glass and this in turn will be picked up and projected by the lens *B* as shown. Now suppose we move each lens a distance which we will call x , and which is identical with the distance the lens was moved in Fig. 50 (a). The full line and dotted positions again record the locations before and after the lenses were

moved. It will be seen here that the final image has been moved over a much greater distance than was the case in Fig. 50 (a). This gives the effect of a greatly increased speed of scanning; yet the lens discs move at a relatively low speed. This process can be carried on through additional stages but it is limited by the rapid diminution of light as we pass from one lens disc to the next.

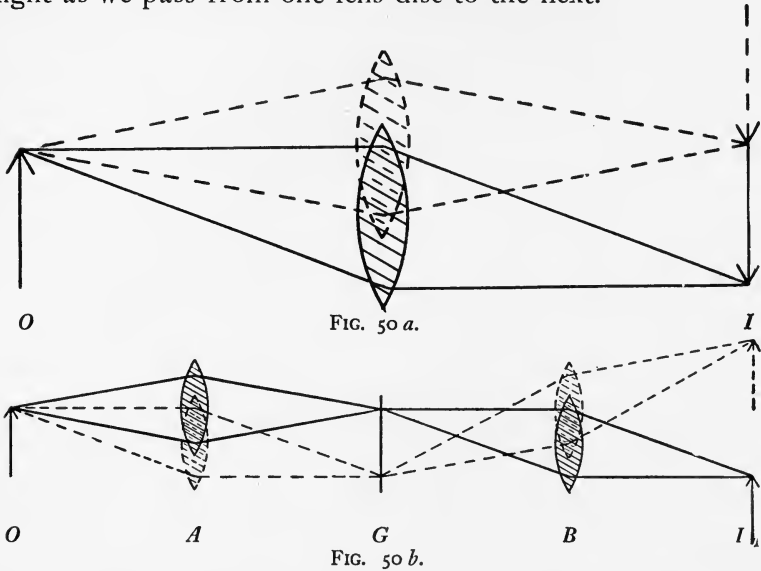

FIG. 50.—Moving a single lens will displace the image I as shown in *a*, but moving two lenses A and B in opposite directions will give a greater displacement as shown. B picks up the image from the ground glass screen G .

The Jenkins system uses what is in effect a variable prism to bend a spot of light from one side of the scene to the other, and another similar one to move it up and down. The bending of light by a prism is a familiar phenomenon and was described in Chapter III. The variable prism is ground into the edge of a glass disc. The disc is bevelled off at one point so that it forms a fairly sharp edge on the glass; as we go along the rim the angle of the bevel gradually becomes less and less, until, halfway around, the two sides

of the disc are parallel. As we continue the angle slopes the other way so that the rim which constitutes the prism cuts into the glass deeper and deeper. At the completion of the revolution the rim is almost severed from the main part of the disc.

In practice one of these discs is used to traverse the picture and another to move the light up and down. The two are so placed that at one point the two rims are traveling at right angles. The scene is viewed through the discs at this point. A cross-section of one of these discs is shown in Fig. 51 (a) and the relation of the discs when in use is shown in Fig. 51 (b). The disc for transverse scanning runs at high speed and the one to produce the up and down motion runs relatively slow. The system apart from the prismatic disc is similar to the others previously described.

A suggested form of television depends upon a cathode-ray oscillograph

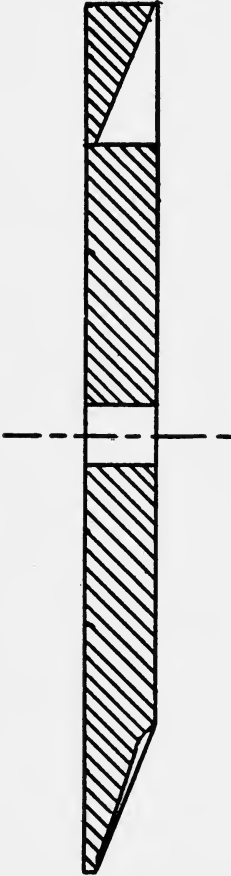

FIG. 51 a.—A cross-section of the Jenkins scanning disc.

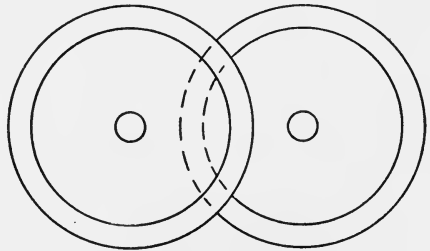

FIG. 51 b.

both for transmitting and receiving. As this is a highly specialized use of a cathode ray-oscillograph and differs very materially from all other systems of scanning it has already been described in the chapter dealing with oscillographs.

CHAPTER X

SYNCHRONIZATION

THE process of television, and that of telephotography, requires that the sending and the reception of the image or photograph occur in unison. This operation is known as synchronization—equal timing. The term immediately suggests something in the nature of a clock control. This, in essence, is exactly the system at first employed. In order to understand the difficulties to which it is subject, let us consider the method in some detail.

In passing, perhaps, some mention should be made of devices whose speed is controlled by a fly-ball governor—for example the common phonograph motor. Although these may be suitable for the motive power of telephotocylinders, they are subject to too much variation in speed to be used without the checking action of some synchronizing system.

Timepieces are controlled in two ways: either by a pendulum or by a hairspring. The latter requires less space and will function in any position; hence is best adapted to portable mechanisms, such as watches. The pendulum on the other hand, must be kept in a vertical plane but is considerably simpler in construction and easier to make reliable; hence is almost universally used in stationary clocks. Both methods of regulation are subject to errors produced by temperature changes. The trouble may be corrected by suitable compensation devices, both for the hairspring and the pendulum; although, in general, automatic compensation is cumbersome as well as expensive.

Since the pendulum has the merit of great simplicity, workers in the field of picture transmission early attempted to employ it for synchronizing their sending and receiving mechanisms. There are two possible ways to do this. We may use two pendulums, one at each end of the line; or we may employ only one pendulum, located at the transmitter and sending a synchronizing signal, in the form of an electric current, to the reception apparatus. At first glance, the former might appear to be the simpler scheme, since no energy link between the two stations is entailed. Attempts to put the method into practice were made by a number of early investigators; but without much success.

To a first approximation, we may say that the period of a pendulum depends on its length; which, however, is altered slightly by temperature changes. Where the two instruments are not used in the same location, it is important to remember that the acceleration of gravity is also a factor in determining their periods and that the value of that factor varies from point to point on the earth's surface. Hence the difficulty of maintaining accurate unison between two isolated mechanisms of this type proved well-nigh insurmountable.

Turning to the second method, mentioned above, synchronization by a single pendulum, consider the apparatus described by T. T. Baker.¹ "One pendulum has been used at the transmitting station, the rod being fitted with a spring contact which strikes a second contact at the end of each swing. This striking of the contacts throws into circuit a relay, which actuates an electro-magnet, and thus releases the cylinder. The receiver is also fitted with a similar electro-magnet release and relay, and both relays are connected in series through the telegraph line, the one pendulum thus operating the synchronizing devices on both instruments. In

¹ T. T. Baker—"Wireless Pictures and Television," p. 58 et seq.

this way any fluctuations in period of swing become immaterial."

Since for commercial telephotography speed is extremely important, we shall find a tendency to run both cylinders as rapidly as the receiving and recording operations can be performed. With the advent of the photoelectric cell and the neon lamp, both inertia-free, came the possibility of very much more rapid operation. So that the rotation of the cylinders, between the synchronizing action of successive pendulum swings, would be quite appreciable. In other

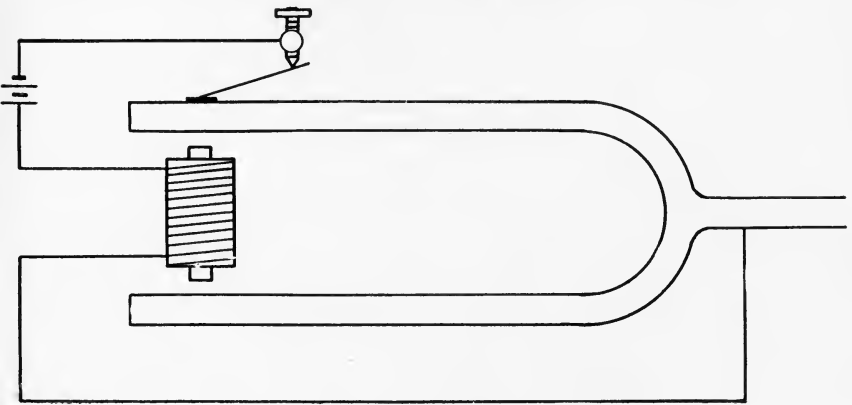

FIG. 52.—Electrically driven tuning fork.

words it would be possible for them to get considerably out of step with each other, thus distorting the reproduction. To avoid this a control is needed which is not only definitely periodic in nature, but whose period is also very rapid.

The tuning fork answers these qualifications. Its period depends on the density of the material and shape of the fork, fluctuates but slightly with temperature and may be made very much more rapid than that of a pendulum. Figure 52 shows the way in which a tuning fork can be electrically driven. The system is not so very different from

that used in the common electric bell, the electro-magnet supplies the necessary energy to keep the fork vibrating; whereas the time at which current flows through the circuit is determined by the period of the fork. We have, then, a fixed current frequency which must be utilized to check the speed of rotation of the cylinders.

A good example of the way in which an electrically driven tuning fork may be used for timing purposes is seen in the apparatus of Captain R. H. Ranger, used by the Radio Corporation of America for picture transmission

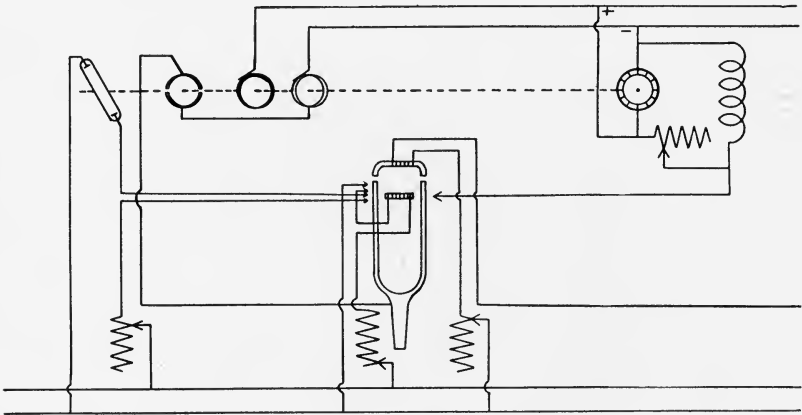
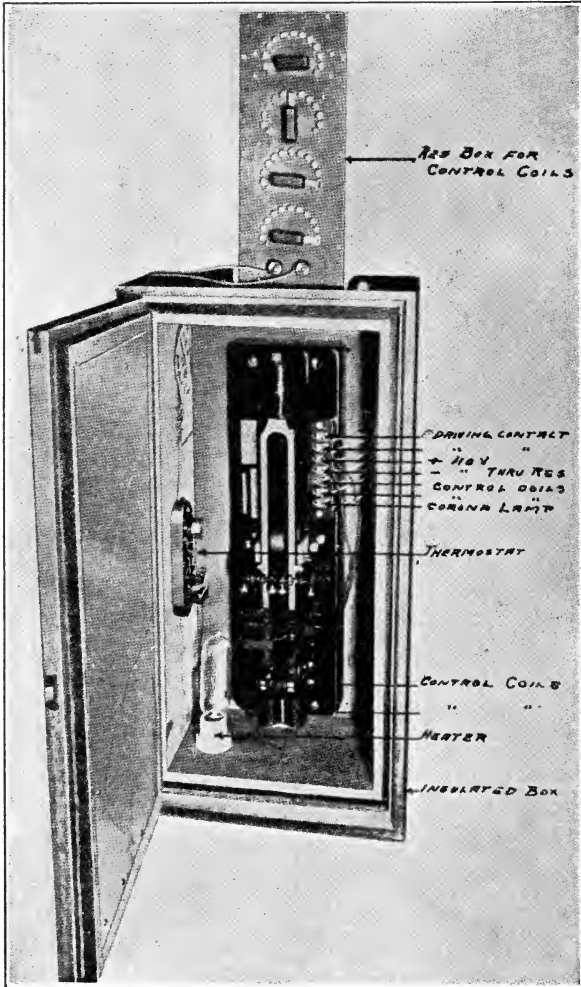

FIG. 53.—Schematic diagram of circuit used for synchronization in the Ranger system. Neon tube, at upper left, is connected to motor shaft, at upper right, and is used as a stroboscope.

from New York to London. Figure 10.02 gives the details of the circuit used. In this case the fork is encased in a constant temperature box to obviate the variations in the period of the fork produced by the expansion or contraction of the metal. For simplicity this detail of the apparatus is omitted in Fig. 53. The general appearance of the temperature control system is illustrated separately in Fig. 54. The period of the fork is further checked by an electro-magnetic control operated from an accurate

chronometer. (Note circuit containing crown piece above prongs of the tuning fork.)

The frequency of the fork is used to check any cumulative variation in speed of the direct-current, shunt field



(Courtesy of Radio Corporation of America.)

FIG. 54.—Mounting of synchronizing tuning fork in constant temperature box, Ranger system,

motor which drives the transmission or reception cylinder. The motor is designed for a speed of 2100 revolutions per minute, whereas the frequency of the forks is 4200; so that the controlling action is brought into play twice each revolution of the motor. It will be noticed from the diagram that in one position of the tuning fork prongs, the shunt field of the motor is placed in parallel with the almost negligible resistance of the auxiliary commutator segments and slip rings, this will greatly decrease the field current, thereby tending to speed up the machine. At the next position of the fork, however, the variable resistance in series with the field is shorted, so that an increase in field current will occur; thus tending to retard the motor. By these extremely rapid fluctuations in field current, the common proclivity of electric motors to "hunt"—that is change speed cumulatively due to some slight variation in line current—is prevented.

The neon tube, seen at the left of Fig. 53, is employed as a method of determining visibly whether the motor is running at correct speed or not. The tube is connected mechanically to the end of the motor shaft so as to revolve at the same speed as the motor. Electrically it is connected with the tuning fork circuit so that a discharge is produced for each vibration of the fork. When the motor is running at correct speed, the tube should light exactly twice each revolution. That is to say it should be illuminated at the same two positions every revolution. Since the speed is too rapid for an observer to receive distinct impressions of each flash and since each occurs for the same position, the tube will appear as if stationary. If the motor is turning too slowly, successive discharges will occur closer together in the circular path; hence the tube will appear to gradually rotate backwards. On the other hand when the motor speed is too high, the tube will seem to rotate slowly in the same direction as the machine. A device of this type, a strobo-

scope, is helpful in many places where one desires to check high rotary speeds.

Although the tuning fork represents a decided advancement over the pendulum for a synchronizing control, something of greater simplicity is desirable for the high speeds necessary in television. The most common system is to employ alternating-current synchronous motors. The principle of their operation may be understood by reference to Fig. 55. In this case alternating current is sent through the stationary electro-magnet, the stator. The drum, or

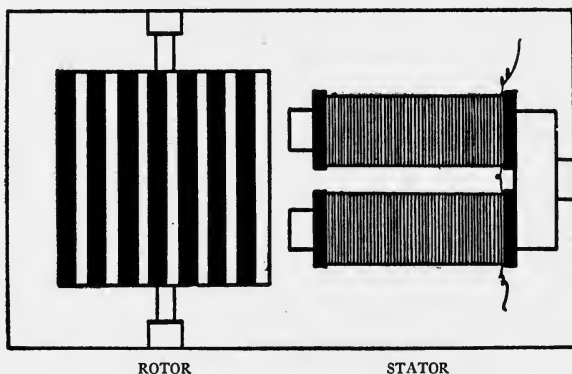

FIG. 55.—Simple phonic drum. This illustrates the fundamental construction of a synchronous A. C. motor.

rotor, may be made of wood carrying bars of iron on the circumference. The periodic magnetization of the stator will cause the iron strips of the rotor to be pulled around at a speed dependent on the frequency of the current supply. In practice the arrangement is often changed so that a.c. is sent through the rotating armature and d.c. is used in the stationary field. The speed of rotation then depends on the frequency of the alternating supply and the number of field coils.

Synchronous motors of this type might conceivably be used in two ways: either transmitter and receiver could be

controlled by the same constant frequency generator, or the transmitter could be made to generate the frequency which controls the receiver. Both methods require another energy link between the two stations in addition to that which carries the image. So that the television receiver, unlike the radio set, must be designed to receive two distinct signals

simultaneously. To make this possible, two different carrier wave bands must be transmitted—one modulated by the scanning process; the other, by the synchronizing generator. Since only very small quantities of energy can be sent from station to station by means of radio waves, it will be necessary not only to amplify the synchronizing signal for control purposes, but to supply auxiliary power to actually drive the receiving disc. To illustrate, let us consider a system originally due to the English inventor, Baird.

The scanning disc of the sending station is driven by a d.c. motor to whose drive shaft is coupled a small a.c. synchronous generator. In this way, any tendency of the motor to vary in speed will be reflected in a corresponding variation of the frequency of the current generated by the a.c. unit which is used to modulate the synchronizing carrier wave. It will be clear that by reversing the process

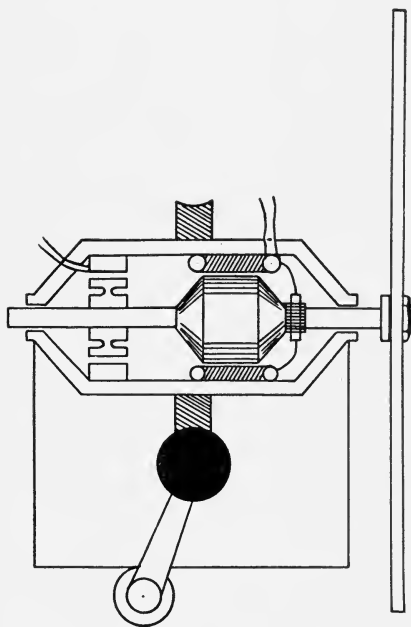

FIG. 56.—Scanning-disc motor and speed control. The large unit, near the disc, is the d.c. drive motor; the smaller unit, at the base of the same shaft, is the synchronous motor used as a speed control.

at the receiving end, we should be able to keep the two scanning discs turning at the same rate of speed at any instant; albeit the speed may not be constant. Figure 56 shows a skeleton view of the main drive for the scanning disc at the receiver and its synchronous control motor. Here a.c. and d.c. units are again mounted on the same shaft; although this time both are motors. The d.c. motor supplies the power to drive the scanning disc; but without control, would be subject to speed variations. However, the speed of the a.c. unit depends upon the input frequency which comes from the amplified synchronizing signal as received from the transmitter. Since both units are connected to the same shaft, it follows that the speed of the pair will be governed by the synchronous unit. It will be understood, of course, that the drive motor is brought close to correct speed by manual control. In short, the scanning discs at transmitter and receiver will turn in unison.

So far, one important consideration has been neglected. Though both scanning discs may be turning at the same rate of speed, analogous parts of the two may not be opposite the center lines of the respective viewing frames at the same instant. This will result in a displacement of the image from the center of the screen, not unlike the effect sometimes seen in the motion picture theatre. Supposing the subject to be a human being, we may see the legs at the top of the screen separated by a dark band from the head and trunk which appear at the bottom. The picture has apparently been cut in two and the parts interchanged in the projector. In television the difficulty can be corrected by rotating the reception unit, casing and all, without changing the drive and speed. For this purpose, a ring gear operated from a hand crank is attached to the outside of the motor casing. (See Fig. 56.)

The greater the periodicity of the synchronizing current, the more frequent will be its checking action. It will there-

fore be advisable to use as high a frequency as circumstances will permit for this purpose. In the demonstration given by the Bell Telephone Laboratories during 1927 a frequency as high as 2125 cycles was used. The main drive current, on the other hand, may be either a.c. or d.c., whichever is most convenient.

The foregoing discussion has been designed to give the principles of the more common methods used for obtaining synchronization both in telephotography and television. The development of these concepts may be traced in the descriptions of the various present-day systems to be given in subsequent chapters.

CHAPTER XI

TELEPHOTOGRAPHY

TELEPHOTOGRAPHY, using the word in its broader sense to mean the transmission of photographs either by wire or by radio, has now reached the stage of commercialization. In February, 1929, a number of American newspapers carried reproductions of portions of Einstein's famous five page manuscript which had been sent across the Atlantic as radio pictures. Photographs which have been "wired" over considerable distances are frequently seen alongside the news report of the event. The larger telegraph offices are prepared to transmit facsimilies of hand writing as part of their daily routine. All of which goes to show that photo transmission has arrived; although to be sure, there is plenty of room for improvements, in the way of increased speed, elimination of blurring due to static, and so forth.

In Chapter II an outline of the early experiments in telephotography was given. For a more detailed description of this field the reader is referred to one of the following books:—T. Thorne Baker, "Wireless Pictures and Television"; Korn, "Handbuch der Phototelegraphie und Teleautographie"; Work, "Bildtelegraphie."

In the preparation of this book the authors have felt that material relating to picture transmission should be included only in so far as the main subject, television, was clarified thereby. For this reason only a few of the more important present-day systems used in America are discussed.

In Chapter II, it was pointed out that photographs might be transmitted directly or in code. Since the coding

operation requires valuable time, we find that most commercial systems are direct. Yet it will be evident that a code message is less apt to be distorted by extraneous disturbances than one in which the variations are relatively small and continuous, as is the case in direct transmission. For example, a Morse-code wireless message is much more likely to be decipherable through bad static than is a radio broadcast program. Hence a code method possesses an advantage where the picture is to be sent over a very considerable distance, such as across the Atlantic. In this particular instance, there is another reason for the use of

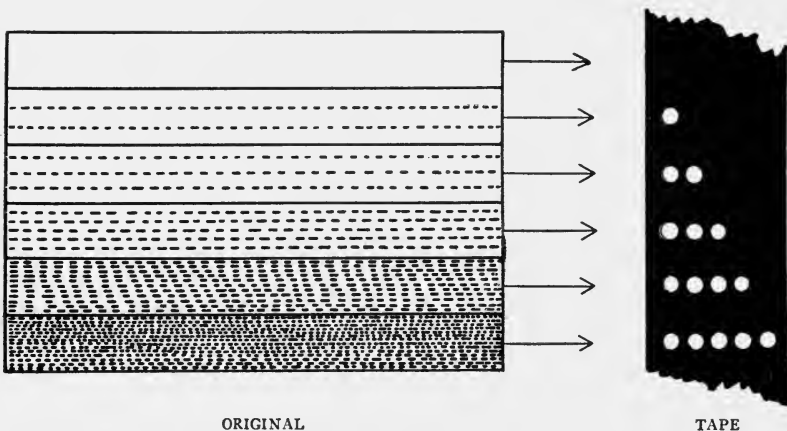

FIG. 57.—Appearance of original and tape which would be formed for various sections thereof in Bartlane process.

code. The electrical characteristics of long cables render them unsuitable for the transmission of modulated currents such as are produced in any direct photo-scanning system. On this account we find the Bartlane process, which employs an extremely rapid, automatic coding of the photograph, quite frequently used in transoceanic work. This ingenious scheme is due to Captain M. D. McFarlane and H. G. Bartholomew, two English inventors.

The first step is the preparation of five special prints

made from the photographic negative. These are made on sensitized zinc plates, each one being given a different exposure so that each contains a different amount of detail. Suppose, for simplicity, the original photograph had appeared like Fig. 57, in which six shades from white to black have been represented. Had all the plates been exposed for the full length of time, they would all appear like the original. If, however, the exposure times be cut down in steps, since the prints are made by passing light through the photographic negative, we may arrange them so that the longest exposure will be effected by all the original but part one, the next longest by all but parts 1 and 2, and so on; the fifth plate being acted on only in the portion corresponding bottom section in Fig. 57. The exposure to light renders the plate coating soluble. So that after developing and washing, the zinc plates are left bare at those portions effected as described above; but are covered with the sensitizing coat, which is a good insulator, at all other places.

The next step is to mount all five zinc plates on a metal cylinder, geared so as to revolve and move parallel to its axis. Over each plate is placed a metal stylus which, before the operation is completed, will have passed in a close spiral path, over all points of its particular plate. The electrical circuit for each stylus is reminiscent of many earlier designs mentioned in Chapter II. It consists in a battery or other source of e.m.f., an electro-magnet and is closed through the metal cylinder to the stylus, provided no insulating material intervenes between the two. Clearly, then, the circuit is closed when the stylus passes over a portion of its respective plate which has been acted on by light. Each electro-magnet operates an arm designed to perforate a special tape. Each line across this tape corresponds to one process spot on the photograph, and as may be gleaned from the foregoing may contain, anything from none up to

five holes. Figure 57 illustrates the relation between the tone quality of the original and the appearance of the tape. The motor feed for the tape must of course be timed to agree with the rotation of the zinc plate cylinder. Since each spot of the original must be represented by a sufficient length of tape to record the necessary perforations, it follows that a very considerable total length will be required. For the transmission across the Atlantic of a picture of the Hon. James J. Walker, Mayor of New York, 275 feet of tape were required.

The first step in reception employs a device similar to the common automatic telegraph receiver to perforate a

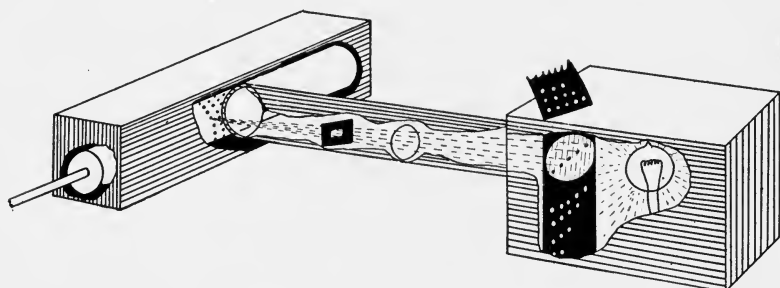

FIG. 58.—Schematic diagram of reception apparatus as used in the Bartlane process. Note how special lens concentrates light passing through an entire line of perforations onto one spot of negative.

second tape in exactly the same way as the original. It now becomes necessary to reconvert the tape message into a photograph. Figure 58 shows how this is accomplished. The keystone of the system is the special lens which concentrates onto one spot of a photographic film whatever light passes through a given line of tape perforations. If there are five holes in one line the exposure of the film for that part will be five times as great as for another portion where the tape contains only one perforation. The receiving film will obviously have to be mounted in a manner analogous to that used for the zinc plates in transmission. From this

point the process merely requires the treatment of the negative as in the usual type of photography.

Although this method involves coding, the apparatus is so cleverly devised that a remarkably short time is needed for the entire operation. When a photograph of the sinking of the S. S. Antinoc was sent from London to New York, thirty minutes were required for the preparation of the transmitting tape, some five minutes for cabling, and only $1\frac{1}{4}$ minutes for the reproduction of a four inch by five inch negative in New York. To be sure, the print was somewhat

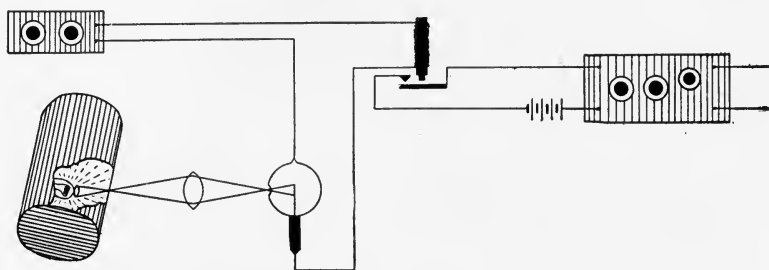

FIG. 59.—Schematic diagram of Ranger system of picture transmission by radio. Note light source inside cylinder which carries photograph. Photoelectric cell output is amplified by special "condenser accumulator" (seen at upper left), then applied through relay (center) to radio modulator (right).

lacking in detail but was quite satisfactory for newspaper work.

Captain R. H. Ranger, of the Radio Corporation of America, has developed a system of picture transmission which is now in commercial service over long distances. The scheme is typical of the direct method, requiring no coding or special preparation of the negative. This negative is clipped firmly in place on the outside of a glass cylinder. A light source within the cylinder is sharply focused by a lens onto one spot of the negative. That portion of the illumination which passes through the negative is focused by a second lens onto a photoelectric cell. (See Fig. 59.)

The cell output is then made to modulate the carrier wave used for transmission.

The receiving mechanism of the Ranger system is made to reproduce the picture in duplicate. One record is made on paper by an inked pen, the other, on a photographic film by a light beam. In both instances the material on which

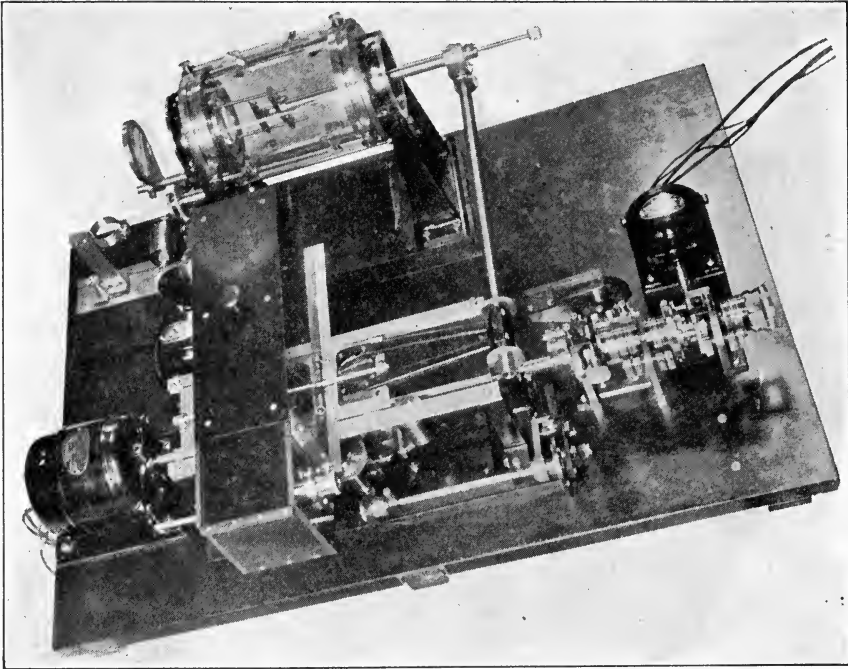

(Courtesy of Radio Corporation of America.)

FIG. 60.—R. C. A. radio picture transmitter of recent design.

the reproduction is made must be placed on a cylinder, whose rotation is synchronized with that at the sending station. The synchronization is accomplished by tuning fork control, a detail already discussed at some length in Chapter X.

The Bell Telephone Laboratories have developed another system of picture transmission over telephone lines,

which is in commercial service today. The schematic outline of the method is well illustrated in Figs. 63 and 64. The transmitter (Fig. 63) will be seen to differ from the Ranger device in that the positions of light source and photoelectric cell are reversed: in the Bell apparatus the cell is inside and the source outside the cylinder carrying the photographic negative. In the receiver (Fig. 64) the amount of light falling on the sensitized paper or film



(Courtesy of Radio Corporation of America.)

FIG. 61.—Photo-radio transmitter and receiver as demonstrated by R. C. A. recently.

is regulated by a light valve controlled by the received signal. Tuning forks are used to produce synchronization.

The method for facsimile picture transmission discussed by V. Zworykin of the Westinghouse Electric and Manufacturing Company, at the New York meeting of the Institute of Radio Engineers, January 2, 1929, shows the present tendency toward simplification of the apparatus and greater speed of reproduction. To quote, "The chief object of the design of this system was to produce a simple, rugged

apparatus for practical usage, which would not require the attention of a skilled operator. The system does not require a special preparation of the original, and the receiver records the copy directly on the photographic paper. . . .



(Courtesy of Radio Corporation of America.)

FIG. 62.—Enlarged reproductions made by radio picture reception apparatus of R. C. A.

In spite of the simplicity of operation, it is capable of transmitting a five inch by eight inch picture, either in black and white or in half-tone in forty-eight seconds, or a message

at the rate of 630 words per minute—over short distances.”

The great speed attained by this method is in a large measure attributable to the fact that the original needs no

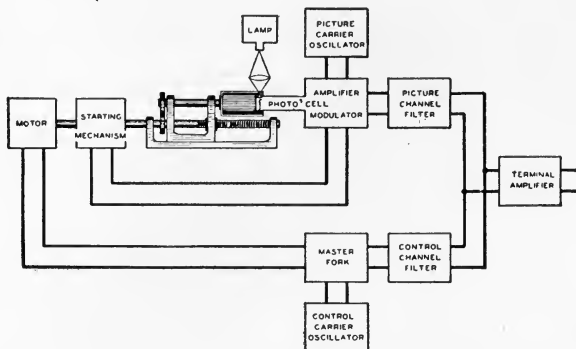

(Courtesy of the Bell Laboratories.)

FIG. 63.—Schematic diagram of photo-transmitter as used by the Bell Telephone System.

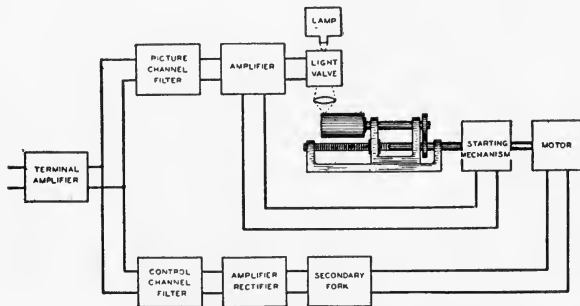

(Courtesy of the Bell Laboratories.)

FIG. 64.—Schematic diagram of photo-receiver as used by the Bell Telephone System.

special preparation to adapt it for transmission. The picture or writing to be handled is mounted directly on the sending cylinder. Light from a constant source is concentrated on a small portion of this original. The reflected illumination is collected by a parabolic mirror and thrown

against the window of a photoelectric cell. Figure 65 shows the optical system used. The scheme suggests the scanning methods used in television.

Since the intensity of the light reflected is extremely

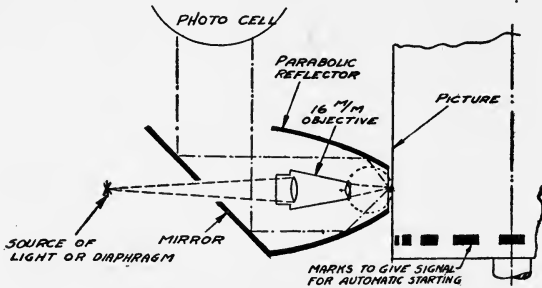

(Courtesy of the Westinghouse E. & M. Co., and of the Institute of Radio Engineers.)

FIG. 65.—Optical system of the Westinghouse facsimile transmitter.

small, this system will require photoelectric cells of great sensitivity and highly efficient amplification of their output. The cell used is of the gas-filled type, the light sensitive coating being caesium oxide; the gas, argon. The ionization

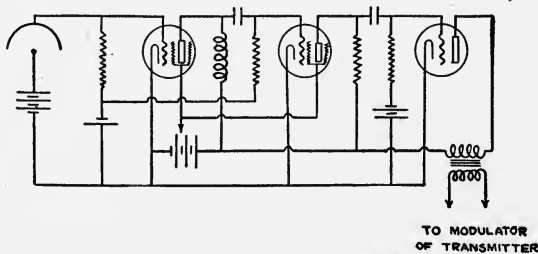

(Courtesy of the Westinghouse E. & M. Co., and of the Institute of Radio Engineers.)

FIG. 66.—Photo-cell amplifier of the Westinghouse facsimile transmitter.

of the argon, when photoelectrons are emitted, greatly increases the output of the cell. Under operating conditions the photo-cell supplies a current of about $\frac{1}{20}$ of a micro-ampere for the white portion of the picture. This must be

greatly magnified before transmission. Figure 66 shows the vacuum-tube amplifier used. It will be noted that two screen-grid tubes are used, the third being the usual three-element amplifier. The voltage output of the last tube is in the neighborhood of forty volts, sufficient to operate the modulator of the radio transmitter. The circuit must be designed so as to be free from any tendency to oscillate or otherwise distort the photoelectric currents.

For reception of the signals, a standard radio set, employing one stage of radio-frequency amplification with a

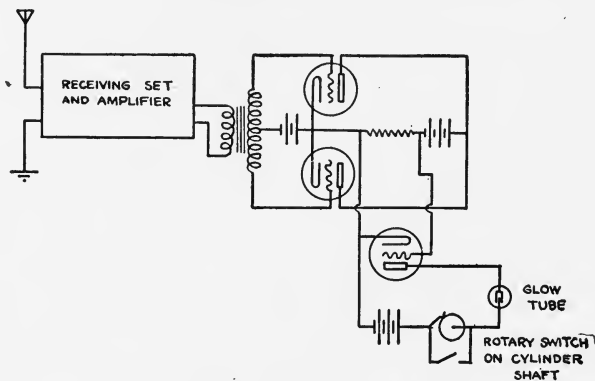

(Courtesy of the Westinghouse E. & M. Co., and of the Institute of Radio Engineers.)

FIG. 67.—Glow-tube control circuit of the Westinghouse facsimile receiver.

screen-grid tube, a detector, and two stages of audio-frequency amplification, is used. The output of this set is utilized as shown in Fig. 67, to operate a neon glow tube.

The neon tube is designed to expose a small portion of photographic paper placed on a receiving cylinder, which must, of course, rotate in unison with the sending device. Since white portions of the original cause the greatest photo-cell currents, it follows that they would produce maximum brightness in the glow tube; hence form the darkest portions on the photographic paper of the receiver—i.e., the re-

production would be a negative. In order that a positive may be made directly the process must be reversed either at the transmitter or receiver. If the reversal be made at the transmitter, bursts of static would get the same interpretation as dark portions of the original; that is, would be reproduced as black spots. This is undesirable in the transmission of material for the most part white, as is usually the case. For this reason the reversal is made at the receiver. The way in which the effect is produced is illustrated in Fig. 67. By placing the correct bias on the grids of the two tubes

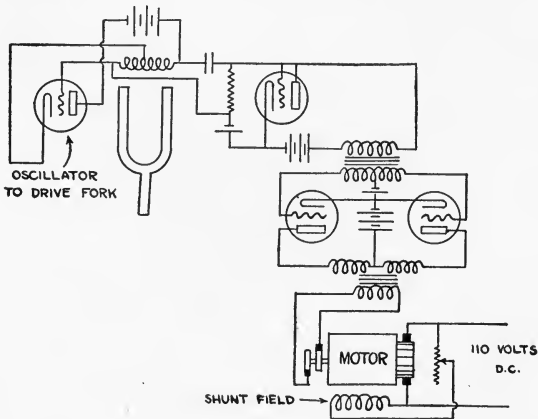

(Courtesy of the Westinghouse E. & M. Co., and of the Institute of Radio Engineers.)

FIG. 68.—Synchronizing circuits of the Westinghouse facsimile reproducer.

whose plate circuits are in parallel, an increase of signal from the receiving set will produce a decrease in the output of the tube which controls the glow lamp. In other words a bright part of the original will be recorded by a dimming of the neon bulb, thus leaving the photographic paper undarkened.

Dr. Zworykin employs two electrically driven tuning forks for synchronization. These are mounted in constant temperature boxes, as in the Ranger system. The fork

controls the speed of the d.c. motor used to drive the transmission or reception cylinder as the case may be. The way in which this is done may be seen from Fig. 69. The

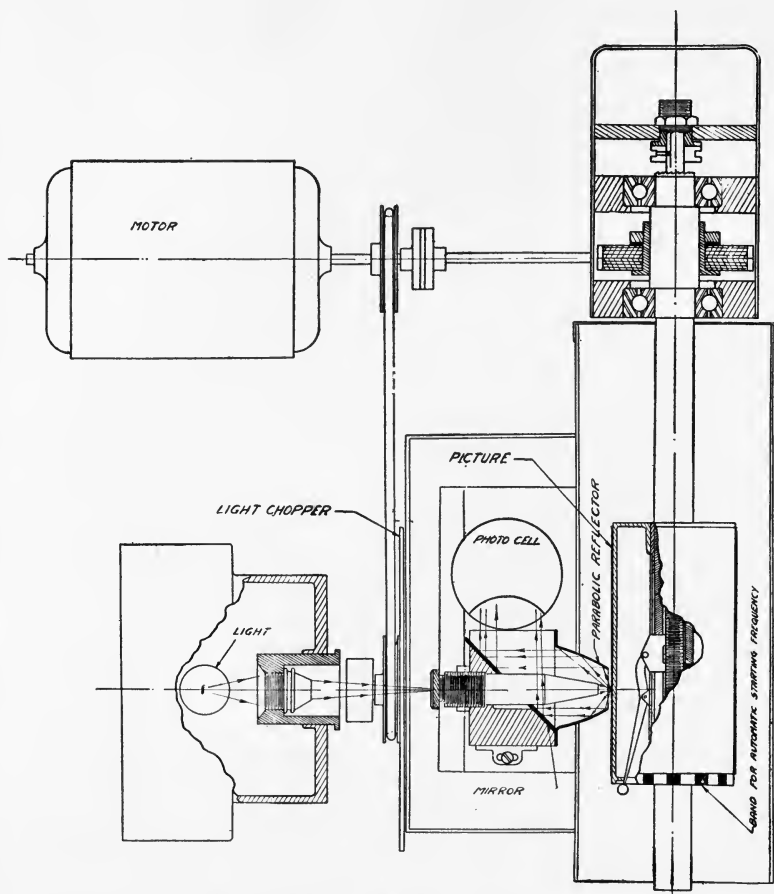

(Courtesy of the Westinghouse E. & M. Co. and of the Institute of Radio Engineers.)

FIG. 69.—Westinghouse facsimile picture transmitter.

period of the oscillations in a vacuum-tube circuit is fixed by the fork. The oscillations are then amplified and impressed on what may be regarded as an a.c. synchronous

motor mounted on the same shaft as the d.c. drive. The action of this combination has already been mentioned in the chapter on synchronization. In order to keep the two forks in unison, a synchronizing signal is sent from the transmitter every revolution of the picture cylinder. This is sent over



(Courtesy of the Westinghouse Electric and Manufacturing Co.)

FIG. 70 a.—Westinghouse facsimile transmitter.

the same wave-band as the picture signals, but the record is restricted to the margin to avoid confusion of the two.

In order to insure correct framing of the picture, it is necessary to make certain that the cylinders not only rotate

in unison, but also that corresponding parts pass under the projection and reproduction light beam at the same time.

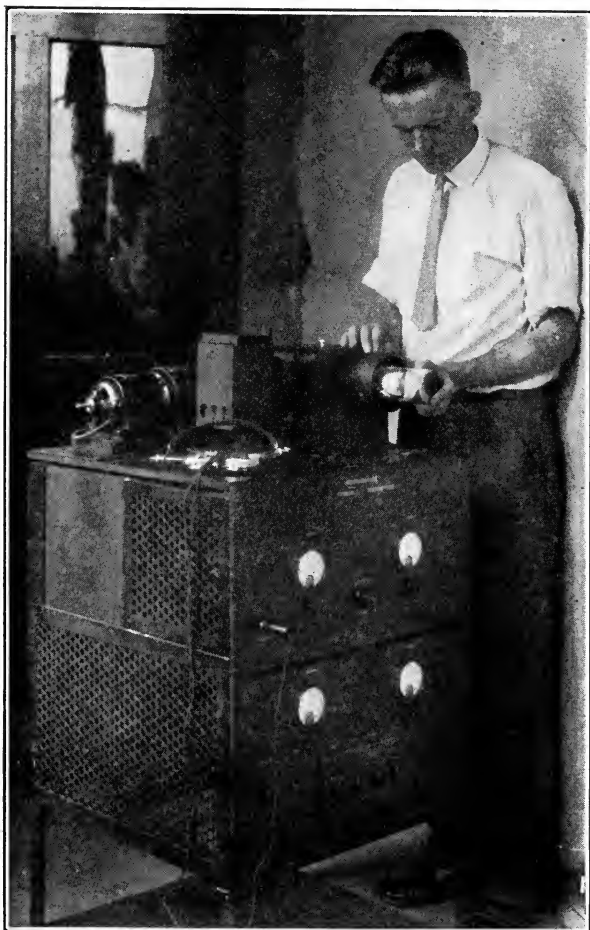

(Courtesy of the Westinghouse Electric and Manufacturing Co.)

FIG. 70 *b*.—Westinghouse facsimile transmitter, showing photograph to be sent.

This is accomplished by a stroboscopic action. The picture is held on the transmitter by a black band running the length of the cylinder. At the starting end this band crosses a

white strip which runs completely around the cylinder. While the projector beam is exploring this portion, the glow-



(Courtesy of the Westinghouse Electric and Manufacturing Co.)

FIG. 71.—Westinghouse facsimile receiver. Note photographic dark bag over cylinder on which print is made.

lamp at the receiver should flash once each revolution; that is, when the projector beam falls on the dark band. At the

receiver an interrupter is arranged so as to break the glow lamp circuit for a length of time equivalent to the transmission of the dark band once every revolution. Consequently, should the two actions occur at the same time, the glow-tube would not flash. Framing consists in attaining this condition by "a process equivalent to rotating the frame of the receiver motor."

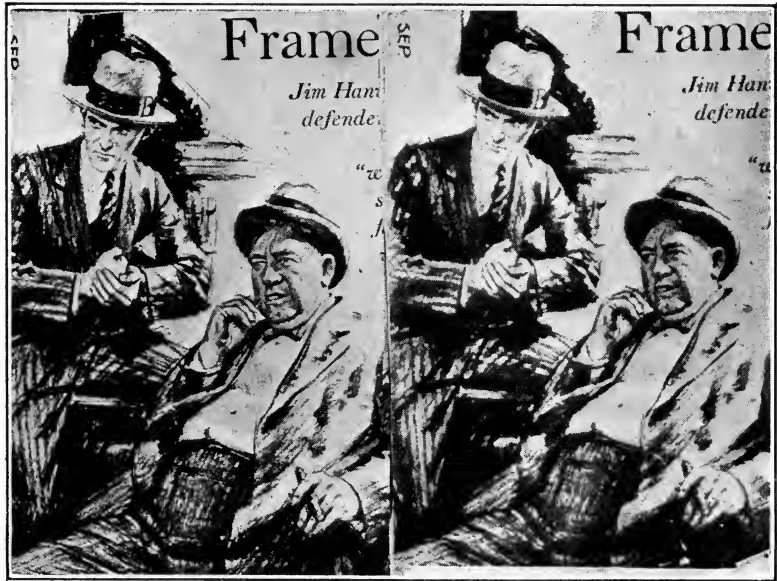

(Courtesy of the Westinghouse Electric and Manufacturing Co.)

FIG. 72.—Original and reproduction as received by the Westinghouse facsimile system.

Figure 69 shows a plan of the transmitter; the actual instrument is seen in Fig. 70. The receiver is illustrated in Fig. 71. It will be seen that both machines possess the advantage of compactness. In Fig. 72 "are shown side by side an original picture and the facsimile transmitted over a short telephone line and a few miles of radio channel."

CHAPTER XII

THE BAIRD TELEVISOR

MR. J. L. BAIRD, who has for many years been identified with the development of television apparatus, is generally credited with having built the first really practical television system. This he demonstrated before the Royal Institution in January, 1926. The device, although but three years old, appears crude in comparison with the improved systems of the present day. Its crudeness, however, is rather in the construction than in the principles involved, for no innovation of any consequence has been made since his original exhibit. Others have followed in much the path taken by Mr. Baird. The original apparatus is now to be seen in the South Kensington Science Museum.

The scene to be transmitted is strongly illuminated with a number of incandescent lamp bulbs, placed in banks. In the original apparatus this illumination was the source of so much glare and heat that the system could not be used to transmit pictures of people. Since then, however, improved more sensitive apparatus has made this possible.

The scene is placed before a large lens-disc which contains thirty-two lenses arranged in a spiral as shown in Fig. 73. As the lens-disc revolves each lens in turn scans a strip of the scene and projects the light it receives from the scene onto a photoelectric cell. Thus the first lens, farthest out from the center of the disc, projects light from a horizontal strip across the top of the scene. The variations in the illumination from the scene along this strip are projected in rapid succession onto the cell. When the first

lens has passed across the scene the next one has just reached it; so that each strip is scanned in turn. As the disc rotates at a speed of 800 revolutions per minute this means that the entire scene is scanned 800 times per minute or about thirteen times a second. The picture is thus completely reproduced at the receiving end thirteen times per second and the persistence of vision of the human eye causes us to interpret the picture as continuous.

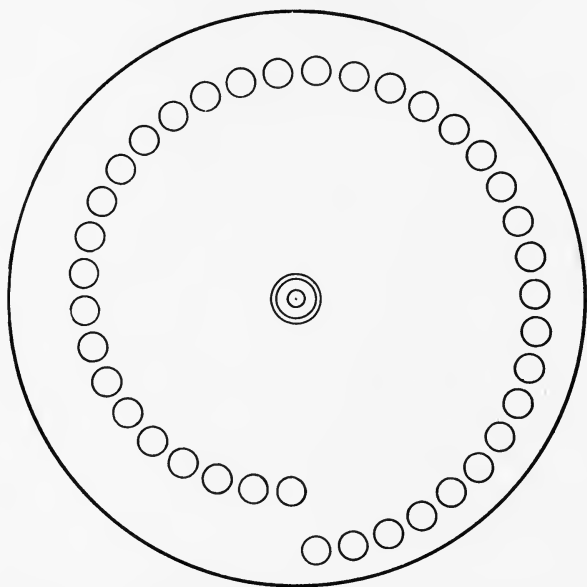

FIG. 73.—Baird lens disc showing spiral arrangement by means of which the scene is scanned.

Directly behind the lens-disc is a second disc, Fig. 74, which revolves at a thousand revolutions per minute and which carries sixty-four radial openings. It revolves in a direction opposite to that of the lens-disc. The radial teeth in this disc act as a chopper to cut up the continuous light striking the photoelectric cell into a number of separate impulses. The purpose of this is for better amplification of the signals in the vacuum-tube amplifier. If, for example,

a strip of the scene being scanned was of uniform brightness the current produced by the light in the photoelectric cell would be direct and unvarying if this radial disc were not there. This would mean amplification of direct current, a notably difficult problem. With the disc, the current is started and stopped at a rate too great to be noted by the eye at the receiving end and such as to make amplification easy. The disc also gives a definite frequency to the tele-

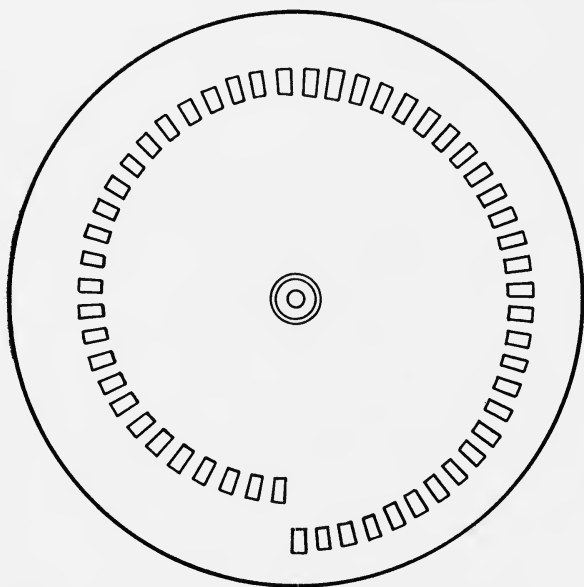

FIG. 74.—A disc of radial slots is placed behind the lens disc and revolves in the opposite direction.

vision current which is useful in filtering it from the synchronizing current when both are sent on the same carrier-wave.

Behind the radial disc is a third disc carrying a spiral slot, Fig. 75. This disc revolves at a low rate of speed. If the outer part of the spiral is before the cell, only light from the bottom part of the strip being scanned enters the

cell. If the inner part of the spiral is before the cell only the lower part of the strip sends light to the cell. This spiral acts then, to multiply the number of strips scanned and is the equivalent of placing many more lenses in the lens-disc. The arrangement of the discs and photoelectric cell is shown in Fig. 76.

When the varying light strikes the photoelectric cell, currents are set up through the cell which are proportional

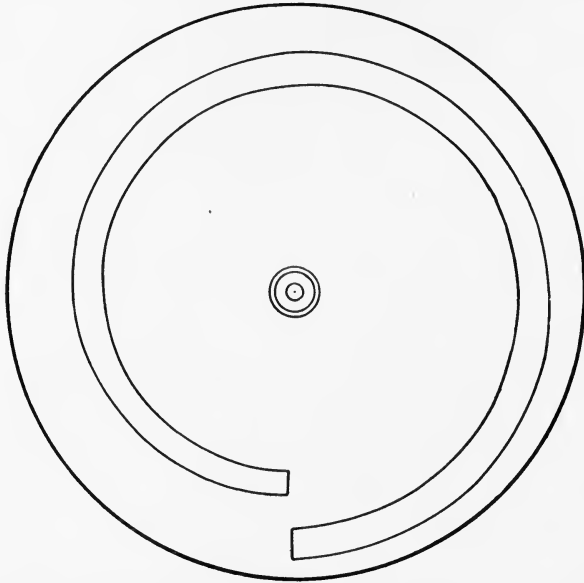

FIG. 75.—A spiral disc, just in front of the photoelectric cell, produces "finer grained" scanning.

to the light received and these are superimposed upon the carrier wave of the usual radio transmission apparatus. If the picture is to be transmitted over wires, the amplified variations in current of the cell may be placed directly upon them.

At the receiving end the entering signals are amplified in the usual manner and if the energy is led into telephones or a loud speaker it would be heard as sound. If the output

is connected to a neon glow-lamp, as is done in the Baird system, the brightness of this lamp will vary with the current passing through it, as the lamp is current operated. From here on, the system is the reverse of that at the receiving end, the disc with the spiral slot and the lens-disc being used to spread the light out on a ground glass viewing screen in the same manner that the light was originally collected. As

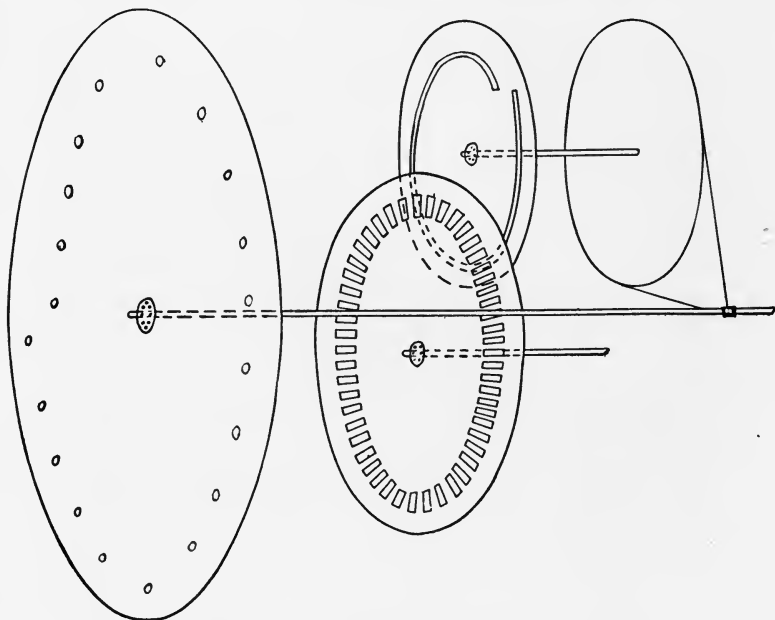
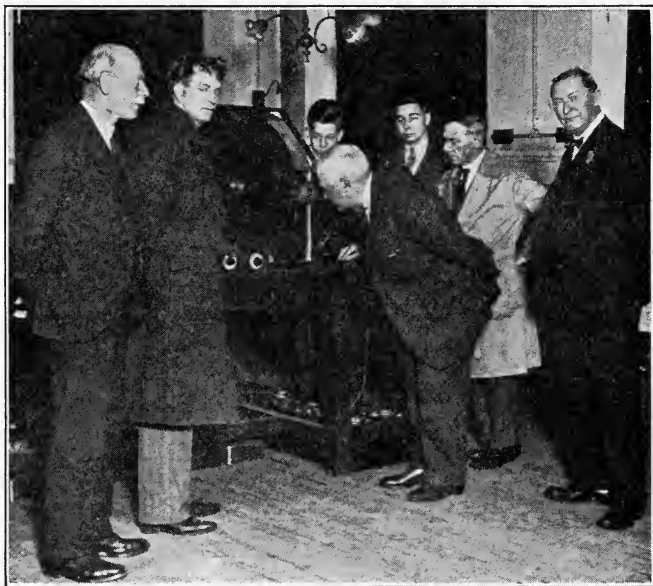

FIG. 76.—Scanning arrangement used in the Baird system.

there is no longer any system of amplification involved the radial disc is of no service and is accordingly omitted.

Of course, it will be obvious that the beam of light reproducing the picture must, at any instant, be in a spot corresponding exactly to that which is being scanned by the sending system. They must not only start at the same place but they must be kept in step. Keeping them in pace is accomplished by the synchronizing system. On the shaft

driving the sending lens-disc there is, besides the driving motor, an a.c. generator. The a.c. current generated is sent out by the usual broadcasting system either on a separate carrier-wave from that used in the television, or on the same wave, later to be filtered out. In Baird's original apparatus two sending and two receiving sets were used for simplicity.



(Courtesy of J. L. Baird.)

FIG. 77.—British scientists at the Glasgow meeting of the British Association inspecting a Baird receiver, September, 1928.

The a.c. from this generator is supplied after transmission and amplification to a synchronous motor. This motor is placed on the shaft which drives the receiving lens-disc but does not itself drive the disc. A driving motor is brought as nearly as possible to the correct speed by the usual motor controls and the synchronous motor has just

sufficient power to bring this driving motor into exact step with the system.

The framing, by which is meant centering the picture on the ground glass screen, can be accomplished by manual operation of adjustments.

It will be seen that there are a number of limitations to the system as described. The speed of scanning is limited by the speed at which the disc can be rotated. The size of the picture is limited by the light which the glow-lamp

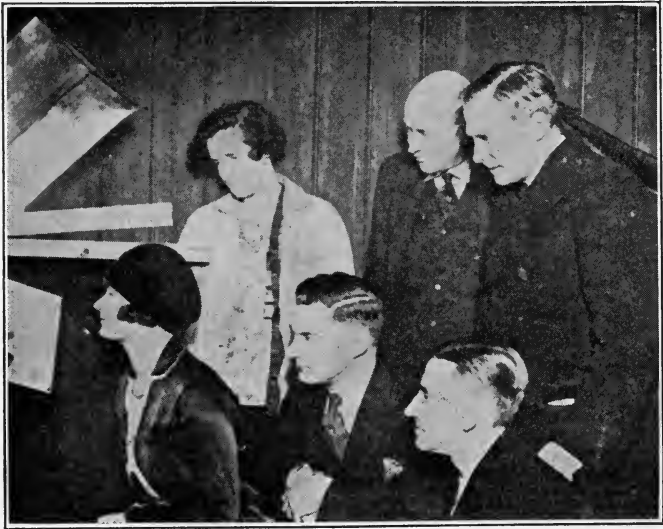

(Courtesy of J. L. Baird.)

FIG. 78.—In the first successful television from London to New York a picture of Mrs. Howe, at the left of the picture, was sent. This shows a group assembled around the transmitter.

can supply. The sending signal is limited both by the sensitivity of the photoelectric cell and by the strength of the illumination of the scene. Mr. Baird, has, however, suggested changes which overcome these difficulties, to some extent.

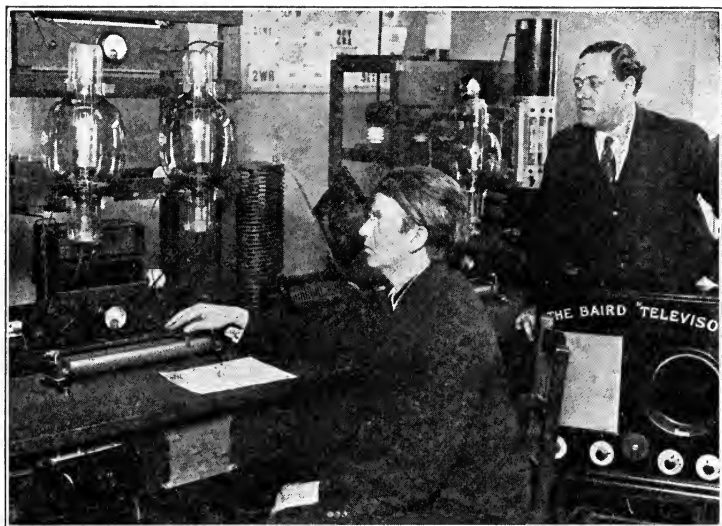

(Courtesy of J. L. Baird.)

FIG. 79.—A close-up of the first transmitter used in trans-Atlantic television tests.



(Courtesy of J. L. Baird.)

FIG. 80.—Television receiver in operation on the "Berengaria" when in mid-Atlantic.

The scanning speed may be greatly increased by use of a series of oppositely rotating lens-discs, each of which throws an image onto a ground glass screen from which it is picked up by the succeeding lens-disc. This system is described in Chapter IX.

For increasing the amount of light falling on the receiving screen, he has made several suggestions. One of these involves what is, in a sense, the placing of one picture adjacent to another. This may be done, without using several complete systems, by putting several lens spirals in the lens-disc, and a corresponding number of spirals on the radial disc. Each spiral has a different number of radial teeth. There is a photoelectric cell for each spiral and the output from each of these passes through a primary coil. All primaries are coupled to the same secondary coil. At the receiving end, the output from the different cells is filtered out by their corresponding frequencies set up by the radial teeth of the radial-disc. After filtering, the current is sent to the proper glow-lamp and light therefrom is projected by a disc similar to that at the transmitting end. Each part of the picture is projected to its proper place.

A second system suggested by Baird is to use a screen which is made up of a number of neon lamps, forming a mosaic. A motor revolving synchronously with the sending disc carries a brush which passes over a commutator, thus connecting one after the other of these lamps into the circuit. Each row of lamps corresponds to one hole in the scanning-disc. Thus as one strip is scanned, each lamp in the row corresponding to that hole will be lighted and the brightness of the lamp will correspond to the brightness coming through the hole at the corresponding point of the scene. If enough of these lamps are used a steady picture will appear because of the persistence of vision. As each lamp must have two wires leading to it, an enormous number

of wires are necessary for a screen of any size. This is the chief barrier to a system of this kind.

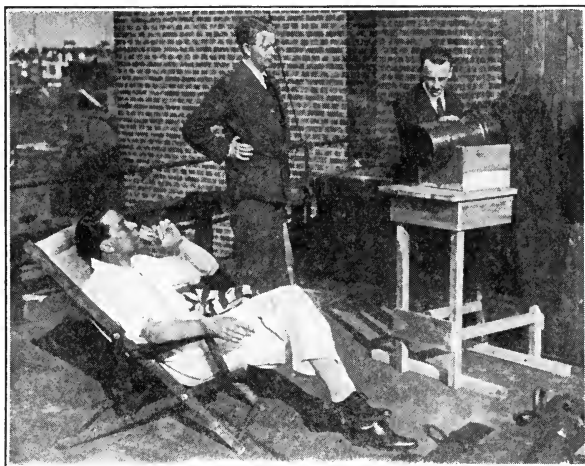
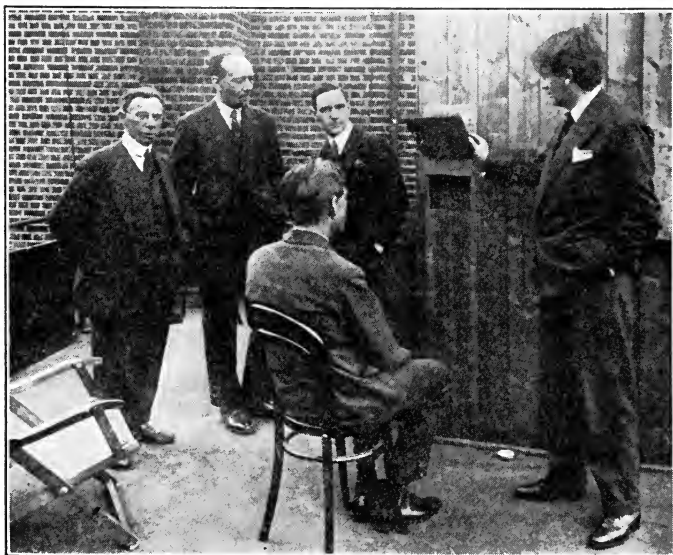

FIG. 81.—Daylight television by the Baird system.



(Courtesy of J. L. Baird.)

FIG. 82.—A group before the daylight transmitter.

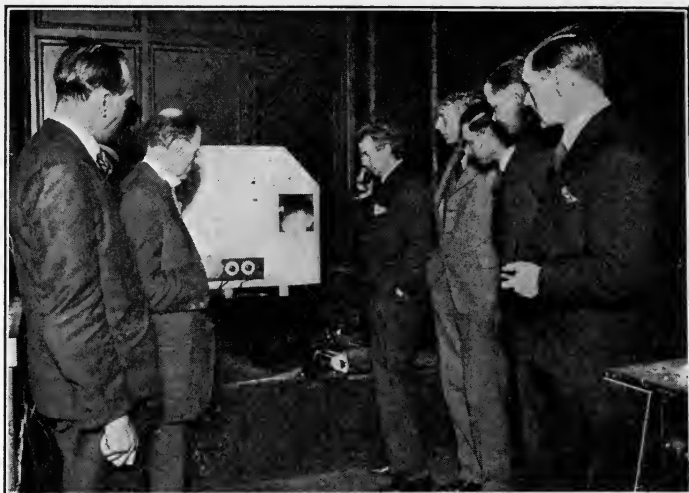

FIG. 83.—Party of American and English journalists inspecting a picture being received by daylight television. Mr. J. L. Baird to the right of the apparatus is demonstrating.

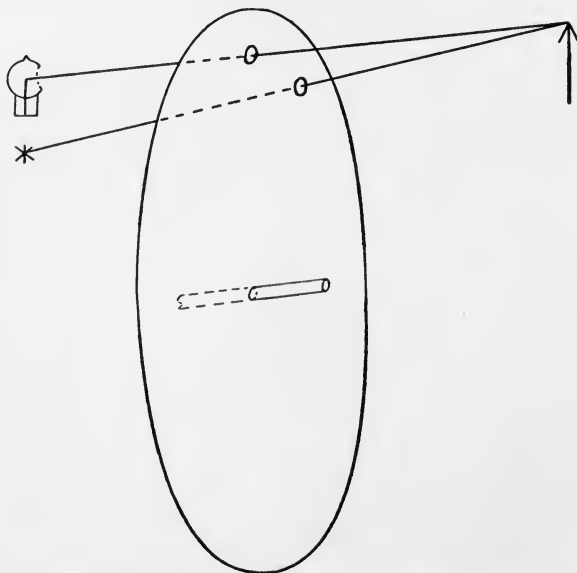

FIG. 84.—A Baird system whereby a spot of light is projected to the exact spot of the scene at the moment being scanned, by a double use of the scanning-disc.

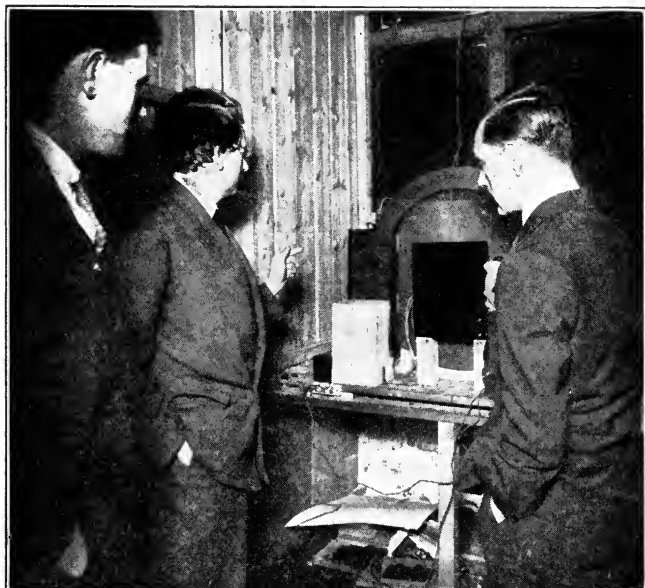
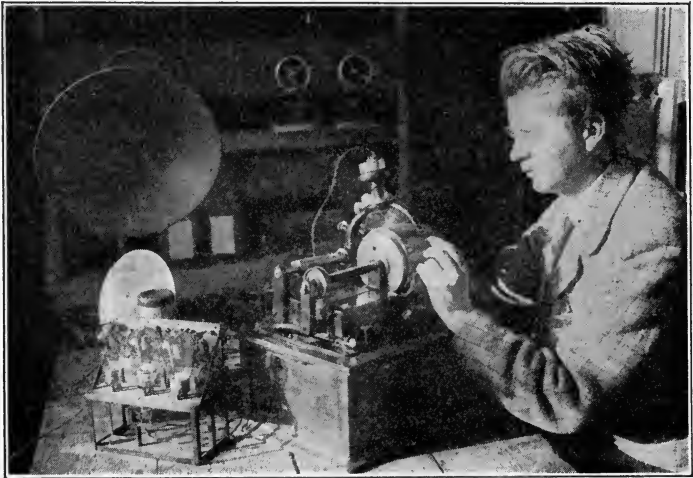

FIG. 85.—A part of the color television apparatus used by J. L. Baird.



FIG. 86.—Mr. Baird demonstrating the first color television.

Mr. Baird also suggested a method for overcoming the difficulty due to the brilliant illumination found necessary in his first apparatus. He used a light so placed that its rays passed through a lens in the lens-disc other than that which was, at the moment, scanning the scene. The resulting light spot struck the scene at the point then under the scanning-lens. This gave a beam of light which fell upon the exact spot being scanned at the moment. As this light passed rapidly over the scene it appeared to the eye to give



(Courtesy of J. L. Baird.)

FIG. 87.—A phonovisor, in which the television sounds are recorded on a cylinder, as in a phonograph, later to be re-created into a picture at any time desired.

uniform illumination of but low intensity, whereas to the television apparatus it gave, at any instant, a very intense spot of light exactly where it was needed; the spot at that moment being scanned. (Fig. 84.)

In another suggestion a spiral of concave mirrors was placed on the front of the disc and the light was then on the side toward the scene. A spot was reflected back at any instant to the point being scanned.

Mr. Baird in addition to being the first to successfully demonstrate television in a practical manner was also the first to transmit pictures by short wave radio apparatus across the Atlantic Ocean. This was accomplished on February 9, 1928, when pictures were sent from London and

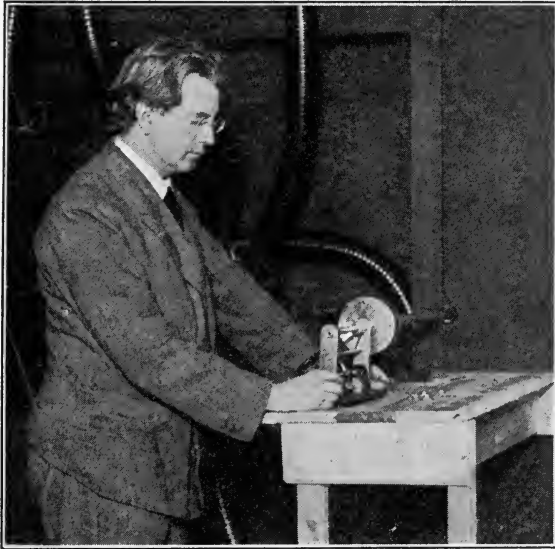

(Courtesy of J. L. Baird.)

FIG. 88.—A recent model of the phonovisor for recording pictures by means of waves on a cylinder. No picture appears on the cylinder, but when the sound which it produces, used as a phonograph record, are changed back into electrical impulses the usual television receiver will create the picture.

successfully received on the American side at Hartsdale, N. Y., a suburb of New York City. He deserves much credit for his pioneer work extending over years, for his successes, and for his many fruitful suggestions.

CHAPTER XIII

THE BELL SYSTEM

ON April 7, 1927, the Bell Telephone Laboratories gave a most elaborate demonstration of television both by wire and by radio. The program presented at that time was made possible by the coordinated research and development work of the vast staff of technicians of the Bell System. In describing the demonstration, let us use the words of Dr. Herbert E. Ives, whose able guidance was in no small measure responsible for the success attained by the Bell Laboratories' experiments in television.

“. . . In that demonstration television was shown both by radio and by wire. The wire demonstration consisted in the transmission of images from Washington, D. C., to the auditorium of the Bell Telephone Laboratories in New York, a distance of over 250 miles by wire. In the radio demonstration images were transmitted from the Bell Laboratories' experimental station at Whippany, New Jersey, to New York City, a distance of 22 miles. Reception was by two forms of apparatus. In one, a small image approximately two inches by two and one-half inches was produced, suitable for viewing by a single person; in the other a large image, approximately two feet by two and one-half feet, was produced, for viewing by an audience of considerable size (Fig. 89). The smaller form of apparatus was primarily intended as an adjunct to the telephone, and by its means individuals in New York were enabled to see their friends in Washington with whom they carried on conversations. The larger form of receiving

apparatus was designed to serve as a visual adjunct to a public address system. Images of speakers in Washington addressing remarks intended for an entire audience, and of singers and other entertainers at Whippany, were seen by its use, simultaneously with the reproduction of their voices by loud speaking equipment."¹

The engineers of the Bell System set themselves the

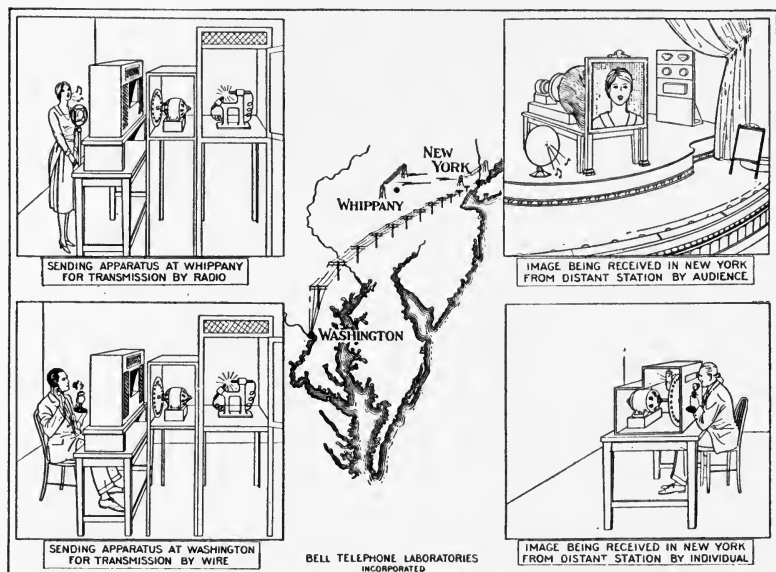

(Courtesy of the Bell Telephone Laboratories, Inc.)

FIG. 89.—Picturegram of the demonstration of television given April 7, 1927, by the Bell system.

primary problem of transmitting the human face in satisfactory detail, as it was felt that this was the most probable requirement for a television service to be rendered in conjunction with the telephone. A consideration of the half-tone engraving process led to the conclusion that a 50 line screen (i.e., 2500 dots per square inch) would give sufficient

¹ From a paper presented at the Summer Convention of the A. I. E. E., Detroit, Michigan, June 20-25, 1927.

detail for this purpose. Fortunately it is possible to transmit images of this type of a size up to 5 x 7 inches, sixteen per second, as is necessary in television, without exceeding the frequency limits of a single communication channel—either telephone wire or radio wave-band. Accordingly, this was the structure of reproduction selected, and the operations of scanning, transmission, screening and synchronization were adapted thereto.

The arrangement used for scanning is well illustrated in Fig. 90. Light from a source of high intensity (a 40 ampere Sperry arc, at the right of the photograph) is concentrated onto a small portion of the scanning disc. (The latter may be clearly seen, together with its synchronous motor drive, at the center of the apparatus table.) This disc contains 50 small holes, arranged in a spiral near its periphery. At any instant the illumination will strike several of these apertures, but by means of a frame placed on the side of the disc away from the light source, the beam coming through just one will be selected and focused by a second lens onto the subject being scanned. As the disc makes approximately eighteen revolutions per second, the subject is completely scanned by a very rapidly moving spot of light that number of times each second. Though the intensity of illumination is high, its transitory nature, in a system of this type, prevents discomfort to the person being scanned.

The next step in the process is to pick up the light reflected from the portion of the subject being scanned and convert it into some form of electrical impulse. For this purpose the Bell System employs three large photoelectric cells, as seen arranged in an inverted U, just in front of the subject. Figures 91 and 92 give an idea of the size and structure of these cells. They are of the potassium-hydride, gas-filled type. The three, arranged as shown, present an aperture of 120 square inches to collect the light reflected from the subject. By connecting these cells in

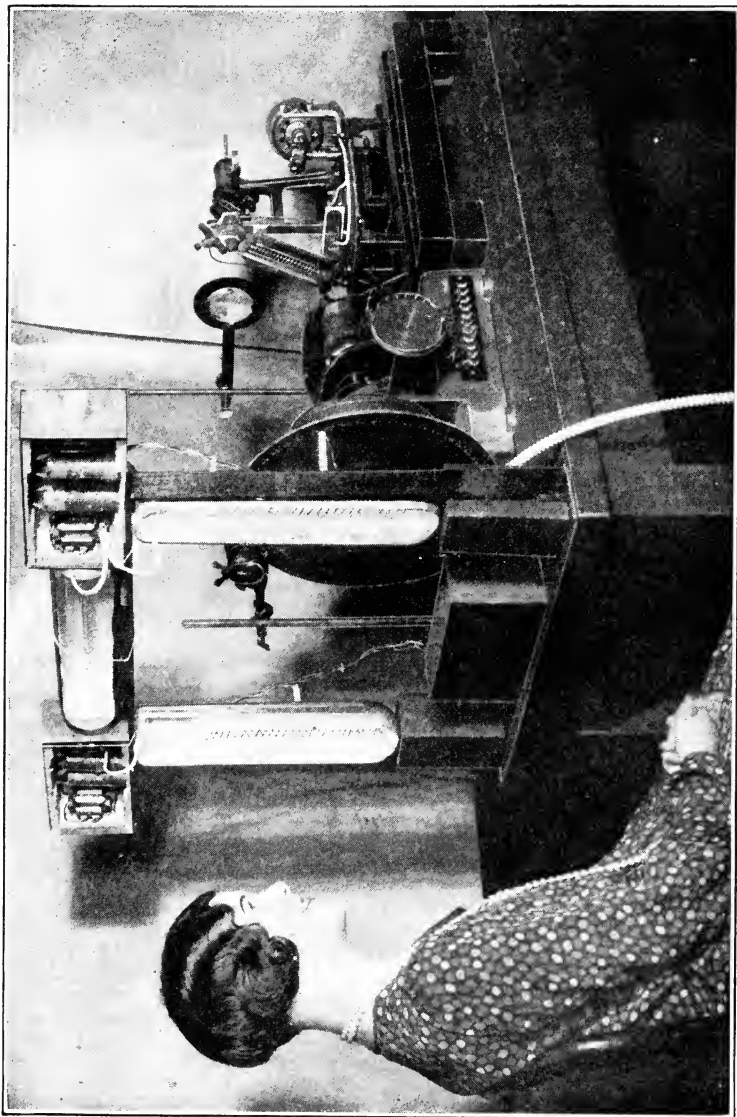

(Courtesy of the Bell Telephone Laboratories, Inc.)

FIG. 90.—The transmitting apparatus used in the Bell system demonstration.

parallel, a current output may be obtained which is above the noise level of the amplifier system—that is, will not be



(Courtesy of the Bell Telephone Laboratories, Inc.)

FIG. 91.—One of the giant photoelectric cells, which served as the eyes of the Bell Laboratories' tests.

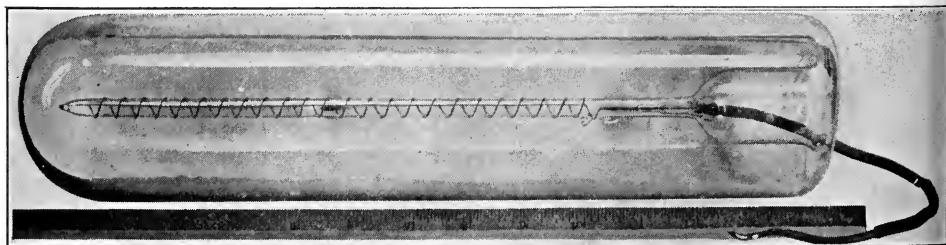

(Courtesy of the Bell Telephone Laboratories, Inc.)

FIG. 92.—Detail of a photoelectric cell of the type used in the Bell apparatus. Note large area of photo-sensitive coating.

confused with the extraneous circuit noises incident to the amplifying circuits.

That the problem of rendering the output of the photo-cell suitable for transmission is no inconsiderable one, will be recognized from the fact that the power delivered to the transmission medium is 1,000,000,000,000,000 times the

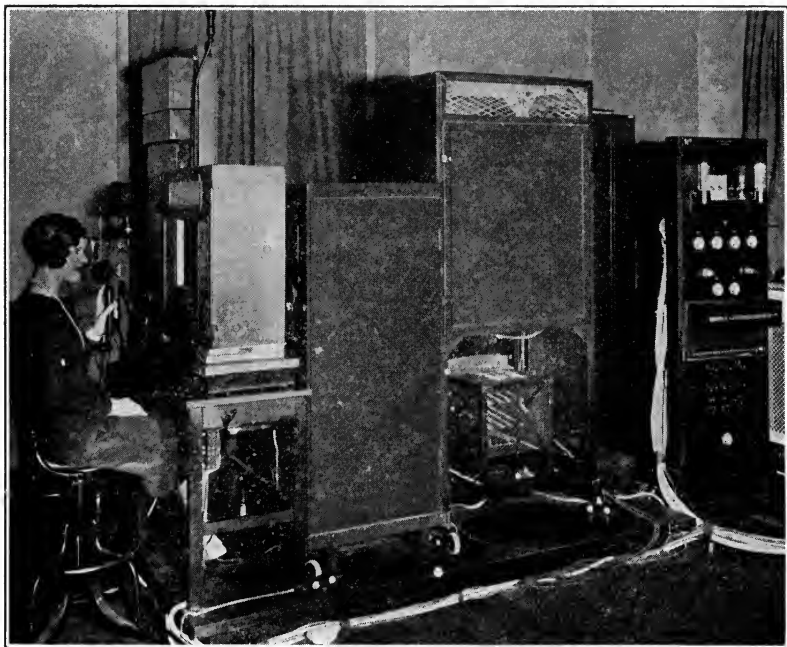

(Courtesy of the Bell Telephone Laboratories, Inc.)

FIG. 93.—Complete transmitter as developed by the Bell engineers. Note separate units used for mounting intermediate amplifiers.

power received from the photo-electric cells. The amplification must also be uniform over a range of frequencies from 10 to 20,000 cycles if the pictures are to be free from distortion. In the system employed by the Bell engineers, ten stages of vacuum tube amplifiers were used to raise the signal to a point where it would successfully override inter-

ference encountered in transmission. The first two stages are included in the frame which holds the photo-electric cells; the remaining eight are mounted in a special relay rack (see Fig. 93. Owing to the large amplification and freedom from distortion which is essential, transformer coupling between stages was considered unfeasible and the resistance capacitance type substituted in its stead. Figure 94 is a schematic diagram of the first two stages of the amplifier.

It should be recalled that the photo-cell output is an unidirectional current whose magnitude depends on the general lighting conditions around the object being transmitted; on this the fluctuations due to the light and shade

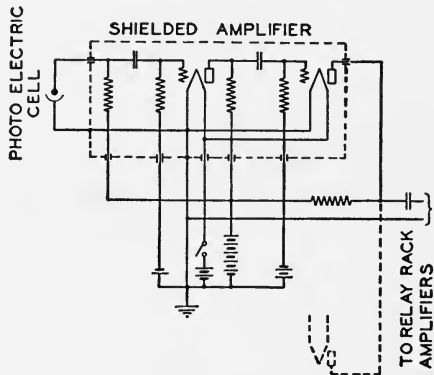

(Courtesy of the Bell Telephone Laboratories, Inc.)

FIG. 94.—Schematic diagram of the first two stages of the vacuum-tube amplifier used with the photoelectric cells in the Bell equipment.

of the various portions of the object itself are superimposed. Now, satisfactory amplification of a direct current presents very considerable difficulties. So much so, that it was decided to introduce this background current arbitrarily at the receiver, making no attempt to transmit it either by wire or radio. The results obtained by this system were quite satisfactory and the amplifier characteristics could be specifically designed to handle the alternating component of the cell current.

In the determination of the electrical characteristics of the amplifier, attention was given to the possibility of correcting distortion produced in scanning. Since the scanning spot has finite dimensions, its response to an abrupt change in the surface being viewed will be less sharply defined than the original. For example, take a surface such as illustrated in Fig. 95. At the time the scanning spot crosses the white to black boundary the cell output should drop abruptly. As a matter of fact, there will always be a finite area illuminated by the light spot (e.g., dotted circle); hence the illumination received by the cell will depend on the total amount reflected by this area. Clearly, then, the current in the photo-cell circuit is related to the average coloration of the area covered by the light spot; so that in the case



FIG. 95.—Circle denotes area covered by scanning-spot.

considered no sharp drop will be produced, but rather a gradual decline as the proportion of dark surface under illumination increases. This apparent sluggishness can be greatly reduced by sharp definition in the scanning spot. In fact for objects of soft tonal quality such as the human face, little difficulty is encountered from this quarter. For more extreme cases, however, such as black and white designs, it was found possible to obtain markedly improved transmission by suitable design of the electrical circuits used in amplification. An explanation of the method used would entail a somewhat involved discussion of electrical circuits which the authors have felt beyond the scope of this book. The interested reader is referred to Section II of a paper entitled "The Production and Utilization of Television Signals" by Frank Gray, J. W. Horton, and R. C. Mattes,

to be found in the Bell System Technical Journal, for October, 1927.

Considering next the actual transmission of the television signals: two systems were used—wire and radio. Wire facilities capable of transmitting a wide range of frequencies were available between New York and Washington. The characteristics of these channels were so well known that the problem of adapting them to television requirements was solved almost entirely in the laboratory. When the final tests were made, the character of the images sent from Washington to New York was not inferior to that attained in short transmissions in the laboratory. For the April 7th demonstration two circuits were provided for picture transmission, one being a spare for use in case of trouble; a third circuit was used for transmitting the synchronizing signal, which will be discussed later; a fourth for the speech transmission; and a fifth for operating orders and so forth.

The problem of radio transmission proved more troublesome than the wire case, because of the severe crowding of the "air" in the New York area. The difficulty is especially pronounced where television signals are to be sent, on account of the great width of the frequency band needed. Preliminary tests made with the available channels led to the selection of a 1575 kilocycle band for picture transmission, a 1450 kilocycle band for speech and one of 185 kilocycles for synchronization. Of the three, as would be expected, the picture signals gave the most trouble in transmission. The portion of the station at Whippany which contained the photo-electric cell circuits was completely copper-shielded from antennae radiation; this was considered necessary because of the very great amplification used in those circuits. A Western Electric 5-B Radio Broadcasting Transmitter was modified so as to suit the special requirements of television, under which conditions it gave approximately a one-half kilowatt output. Tests made with

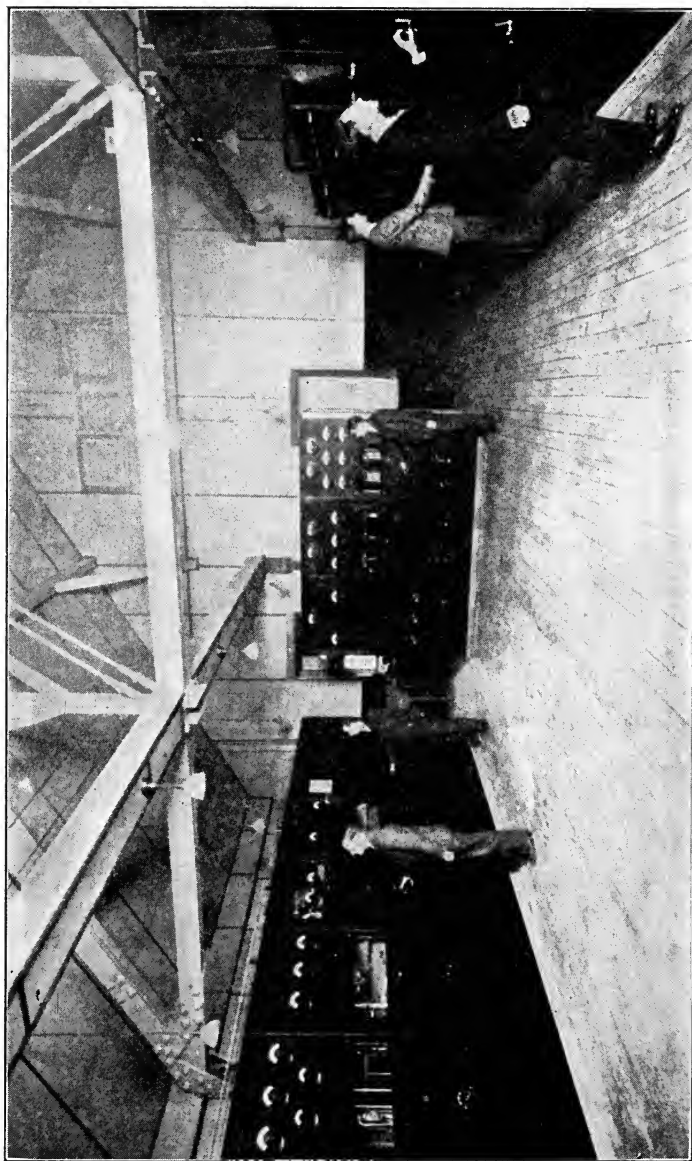

(Courtesy of the Bell Telephone Laboratories, Inc.)

FIG. 97.—Operating room of 3XN (transmitting station at Whippany, N. J.). Transmitter for television on the right. Power supply unit and radio transmitter for the speech channel in the center and on the left, respectively.

the equipment indicated that the daytime was preferable for transmission. Fading began with the sunset period and became more pronounced as evening advanced. Coincident with the fading of the desired image, an appearance of "ghosts" was noted. These were readily seen to be similar to the principal reproduction but incorrectly framed. The

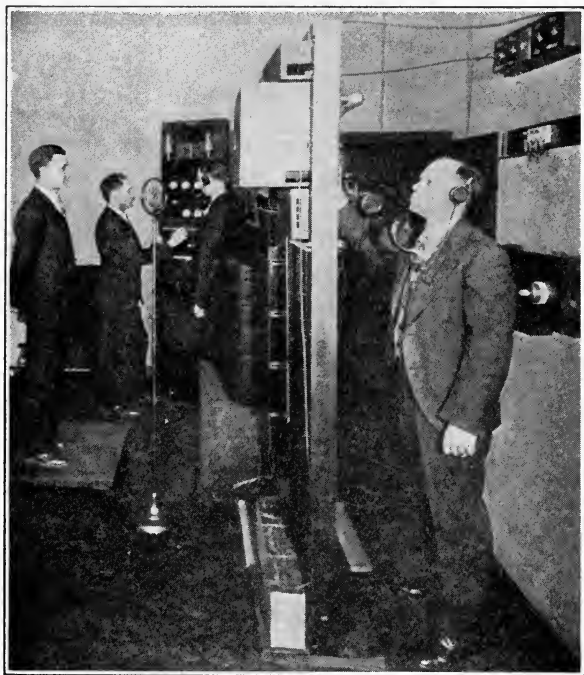

(Courtesy of the Bell Telephone Laboratories, Inc.)

FIG. 98.—Television transmitting apparatus in the studio at Whippany.

effect was attributed to reception of signals which had traveled over paths of different length, hence had required different times for transit and were consequently out of phase. The probability was that the main image was produced by energy coming by the most direct route; whereas the "ghosts" represented energy which had traveled from

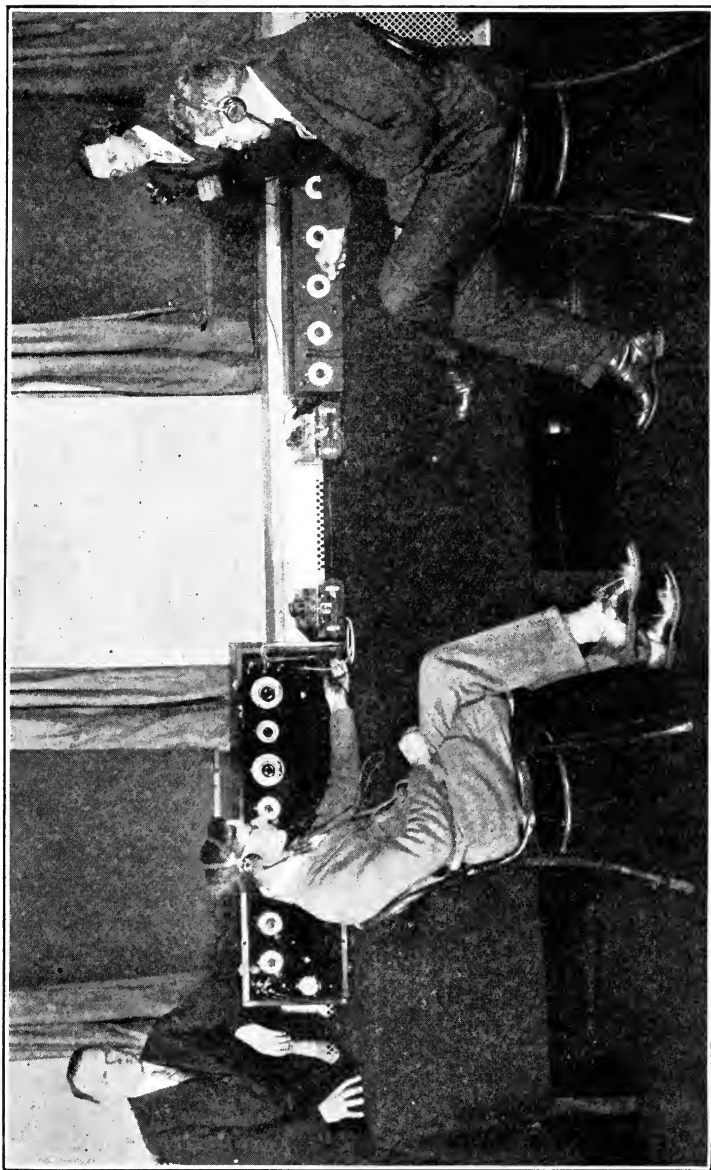

(Courtesy of the Bell Tel. Lab., Inc.)

FIG. 99.—Radio receiving equipment for the television and speech channels in the auditorium of Bell Telephone Laboratories, N. Y.

the transmitter upward to the Heaviside, or conductive layer of the earth's atmosphere, whence it was reflected to the receiver. Calculation of the interval between the two signals verified this conclusion, giving as a height of the reflection surface about 60 miles—a value close to that generally stated for the height of the Heaviside layer.

The radio reception apparatus consisted of a specially designed superheterodyne receiver for the television signals, one of standard design for the speech, and a third receiver for the synchronizing channel. In the television receiver a system of triple detection was employed in order to pass the wide frequency band used, without too great a loss of selectivity.

The received television signal, after amplification was impressed across the electrodes of a neon discharge tube. The tube, or glow-lamps, were made in two very different forms; one for small pictures to be viewed by a single person and one for large projections, large enough to be seen by a fair-sized audience.

Considering the apparatus for individual screening first, Fig. 100 shows the neon tube, and Fig. 101 the way in which it is mounted for viewing. The electrodes of the tube are two metal plates placed about one millimeter apart. The gas pressure is so regulated that the glow discharge develops on the outer surface of the negative plate, or cathode. The luminous surface of this plate is viewed by the observer through the holes of a disc similar to the



(Courtesy Bell. Tel. Lab., Inc.)

FIG. 100.—Neon receiving lamp used in Bell Laboratories' experiments. The rectangular cathode is covered by a uniform glow slightly larger than the field of view on a television disc.

scanner used at the transmitting station. This viewing disc must revolve synchronously with the scanning disc; so that at any instant, the observer is viewing a portion of the luminous plate which corresponds in position to that part of the image then being scanned. Since the brightness of the glow discharge depends on the current passing through the tube and this, in turn, depends on the output of the

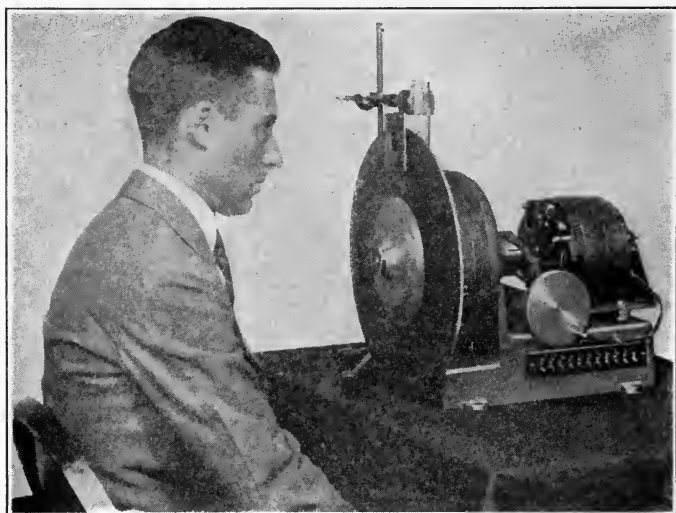

(Courtesy of the Bell Telephone Laboratories, Inc.)

FIG. 101.—The individual receiving equipment as used in the Bell system demonstration. Note mounting of neon lamp behind scanning-disc and synchronous drive motor.

photoelectric cell at the sending station, the observer actually gets a series of rapid glimpses of a surface illuminated proportionally to the corresponding parts of the object being transmitted. So rapidly does the motion occur, 17.7 complete transitions of the entire viewing screen (i.e., the discharge tube cathode) each second, that the eye is conscious of no discontinuity, unless it be a slight horizontal line-texture of the image. This may be corrected by allowing the

paths described by successive holes, as they pass the viewing frame, to overlap slightly.

Whereas the image produced by the apparatus described in the last paragraph was about 2 inches by $2\frac{1}{2}$ inches in



(Courtesy of the Bell Telephone Laboratories, Inc.)

FIG. 102.—Complete disc receiver apparatus of the Bell system. The observer looks through the shielding window at a picture some $2\frac{1}{2}$ inches square. The 36-inch scanning disc is used.

size, another system was used that gave an image nearly 12 times that size. In the latter case the large neon tube seen in Figs. 103, 104 and 105 was used. The tube is bent back and forth, so as to give fifty parallel sections. Each section contains fifty exterior electrodes, cemented on the back side of the tubing. In this fashion 2500 picture elements are produced, just as in the case of the small viewing frame. The operation of the large grid receiver is con-

trolled by a 2500 wire distributor (Fig. 106) which plays the same part as the viewing disc previously discussed. Through the center of the tube runs a single spiral electrode (Fig. 104), connected permanently to one output terminal of the receiving set. Contact is made through the revolving

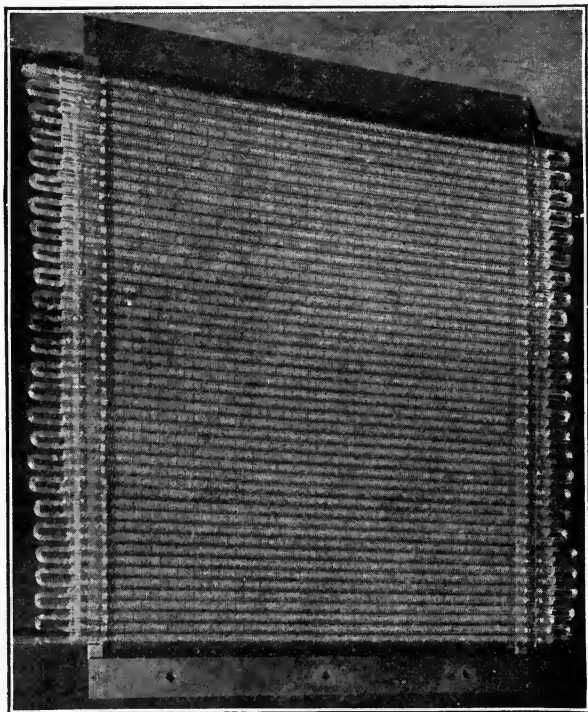

(Courtesy of the Bell Telephone Laboratories, Inc.)

FIG. 103.—This large grid, formed by a continuous neon tube bent back and forth, is the electro-optical element of the receiving equipment used by the Bell Laboratories for large audiences.

arm of the distributor between the second output terminal of the receiver and the successive external electrodes of the large tube. As contact is made to a given external electrode a discharge will occur between it and the central electrode. Due to the high frequency of the voltage used (500,000

kilocycles) the current will actually flow, by a capacity effect, through the glass and luminescence will be seen on the inside of the tube. It will be seen that if the distributor arm revolves synchronously with the scanning-disc at the transmitter, we may build up the enlarged image in this grid receiver exactly as was done on the smaller screen.

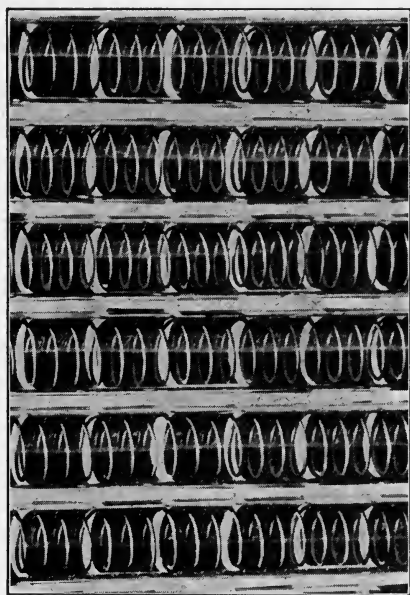

(Courtesy of the Bell Telephone Laboratories, Inc.)

FIG. 104.—Detail of Bell grid-receiver. Note continuous spiral electrode running through center and external electrode elements placed at intervals on back side of tube.

In the transmission of the television signal it will be recalled that the direct current component of the photoelectric output was not utilized, hence it becomes necessary to introduce this background illumination at the receiver. This is done by placing a suitable bias across the neon tube so as to produce a steady state of current therein, on which the alternations from the sending station are superimposed.

With the large grid receiver, it was found that when a considerable interval elapsed between discharges at a given electrode, there would be a lag between the application of the potential and the appearance of illumination at that point. To correct this difficulty pilot electrodes were placed at the bends of the neon tube thereby irradiating each branch and

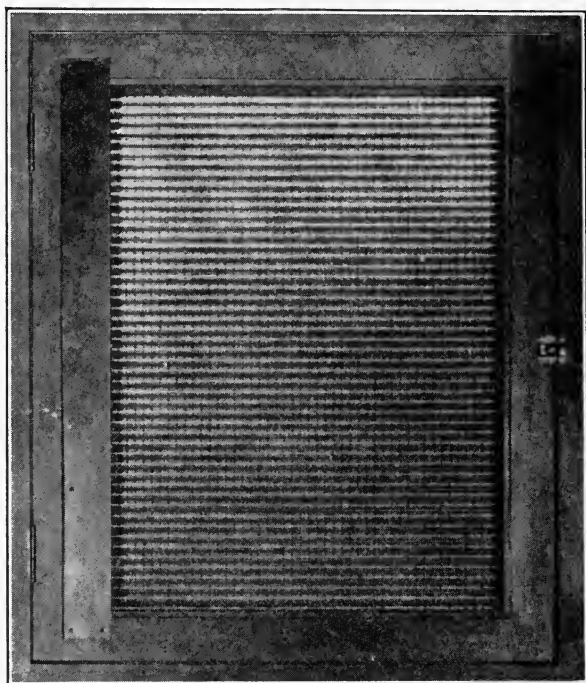

(Courtesy of the Bell Telephone Laboratories, Inc.)

FIG. 105.—Final mounting of Bell grid-receiver. Note framework which covers pilot electrodes.

keeping it in what might be called a sensitive state. These pilot electrodes were hidden from the audience by the framework placed around the receiver. (Fig. 105.)

Turning now to the method used for synchronization, we find a system not unlike that previously described as due to the English inventor, Baird. The Bell engineers took

as a standard for synchronization the requirement that the sending and receiving discs should be not more than one-half of the width of a picture element apart. Since there were 50 elements in the entire width of the picture, which

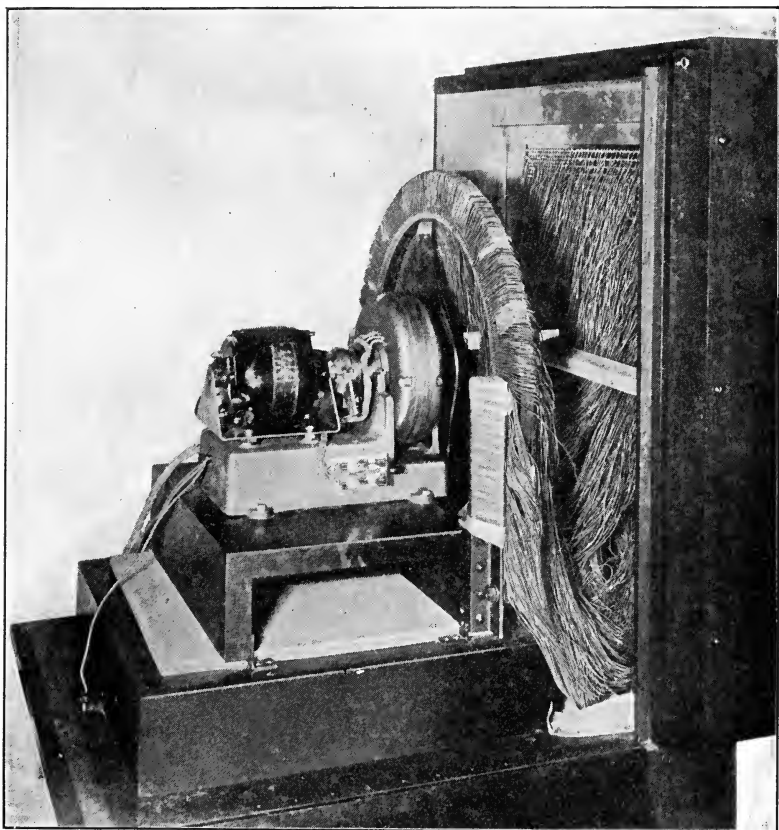

(Courtesy of the Bell Telephone Laboratories, Inc.)

FIG. 106.—Distributor whose function is to send high frequency current to each of the 2500 external electrodes of the Bell grid-receiver at the proper time.

corresponds to the separation between each of the 50 holes of the disc, it follows that the requirement set meant that the two discs should not be more than $\frac{1}{2} \times \frac{1}{50} \times \frac{1}{50}$ of a

revolution, i.e., .072 degree apart. The ordinary two-pole synchronous motor will not approach this degree of precision. But increasing the number of poles improves the speed

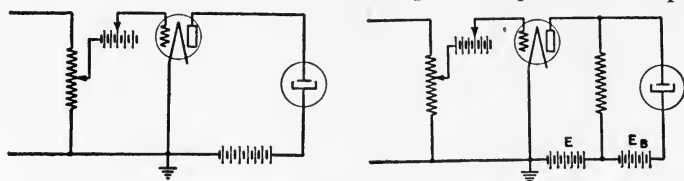

(Courtesy of the Bell Telephone Laboratories, Inc.)

FIG. 107.—Circuits used for neon tube control by Bell engineers.

characteristics of such motors, and it was found that a machine with 120 pairs of poles could, under favorable conditions, be expected to satisfy these requirements.

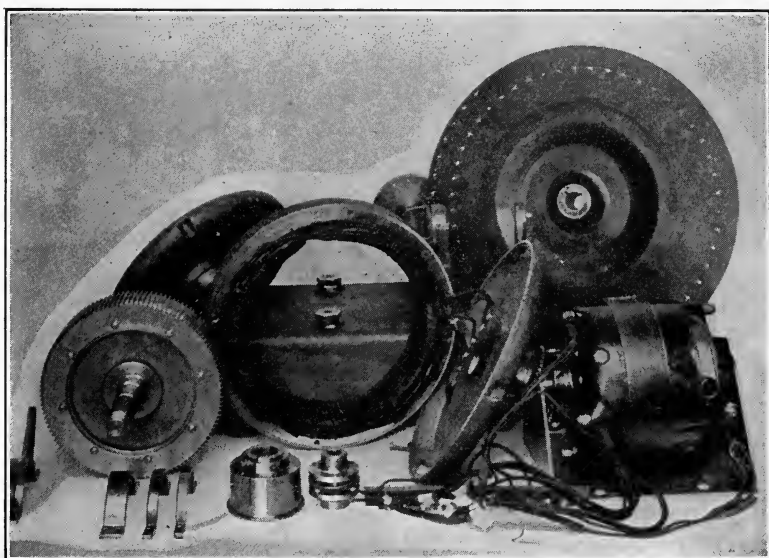

(Courtesy of the Bell Telephone Laboratories, Inc.)

FIG. 108.—Assembly of scanning-disc motor used by Bell apparatus.

The speed is set for these motors by the necessity of producing 17.7 complete pictures per second, as noted

previously. Each picture corresponds to one revolution of the disc, hence the motor speed must be 17.7 r.p.s. or 1062 r.p.m. For 120 pairs of poles this gives a frequency of 17.7×120 or 2124 cycles per second. As a matter of fact the machines were made of the variable reluctance type, with 120 teeth on the rotor (see Fig. 108) in which case only eight coils are needed. The tendency of these motors

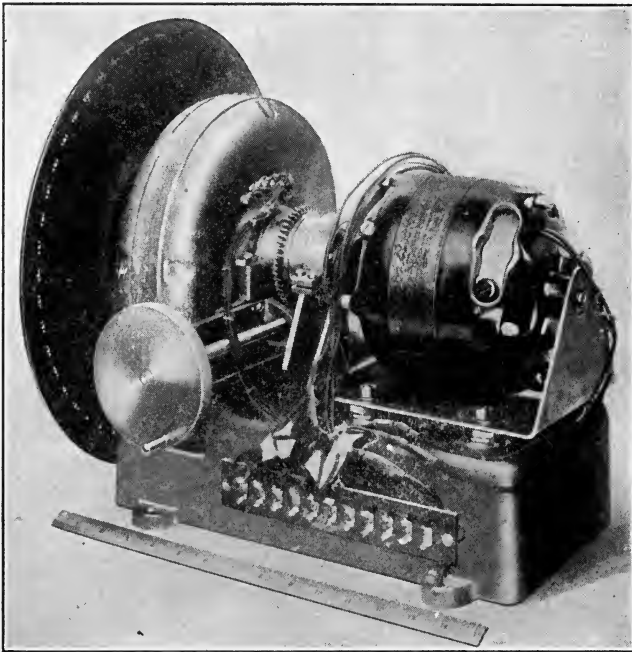

(Courtesy of the Bell Telephone Laboratories, Inc.)

FIG. 109.—Mounting of scanning-disc drive as used by Bell apparatus.

to “hunt” (i.e., vary their speed of rotation) was checked by a series condenser placed in the circuit which feeds energy between them.

There still remains the question of the framing of the picture, which implies that both discs be in the same relative position at the same time. This may be accomplished by

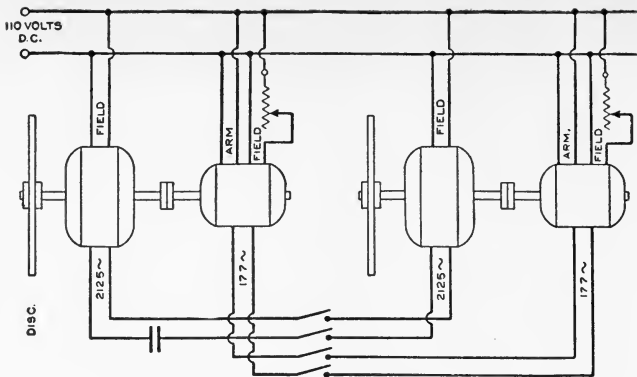

(Courtesy of the Bell Telephone Laboratories, Inc.)

FIG. 110.—Synchronizing circuit as used by Bell Laboratories in short distance transmission over wires.

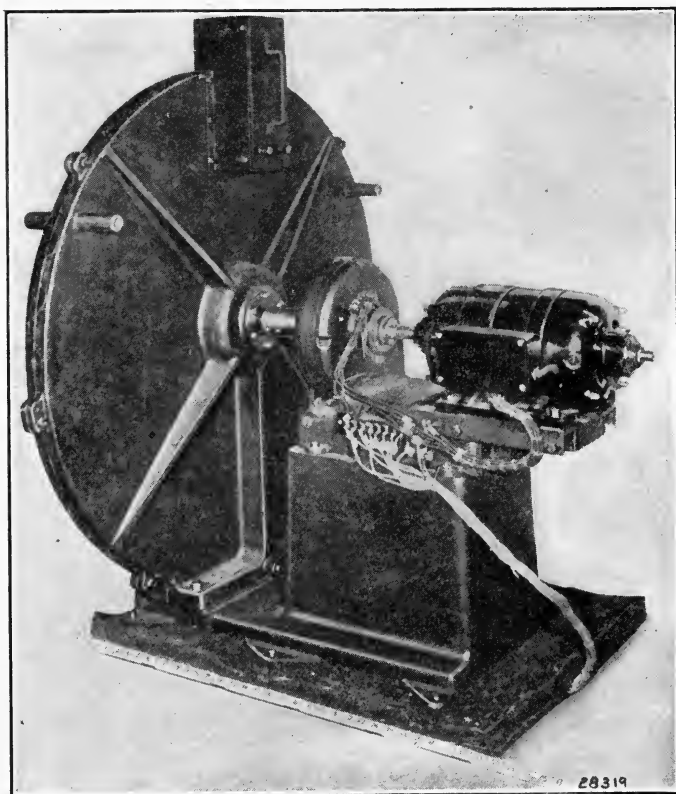

(Courtesy of the Bell Telephone Laboratories, Inc.)

FIG. 111.—Large scanning-disc motor used in completed form of Bell apparatus.

manual rotation of the entire motor (note crank seen in Fig. 109). However, it was found that too rapid rotation of this control would throw the motor out of step. For this reason the d.c. drive motors were fitted with a pair of slip rings tapped to opposite commutator bars, so that, at 1062 r.p.m., they generated a 17.7 cycle current. With a two-pole machine of this type there will be only one angular

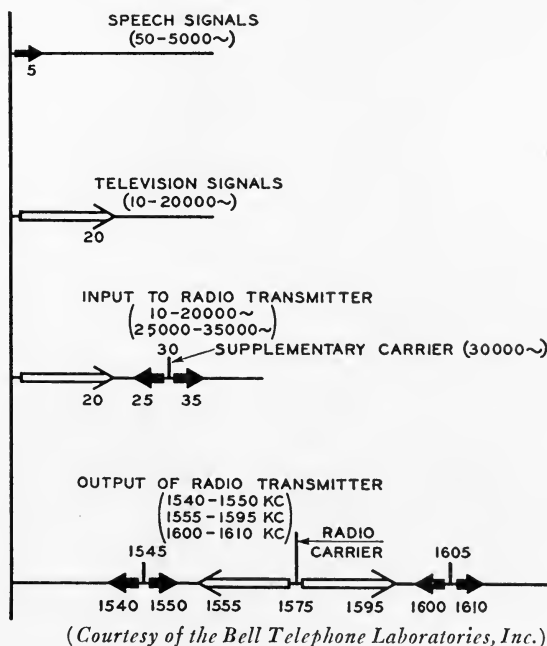

.. FIG. 112.—Diagrammatical representation of frequency conversions in multiplex radio system.

position at which synchronization will occur. For a schematic diagram of the arrangement see Fig. 110.

Where the synchronizing signal must be sent over a long distance either by wire or radio, large quantities of energy cannot be transferred from the sending generator to the receiving motor. In this case the energy must be attenuated at the transmitter and amplified before use at the

receiver. The circuits necessary to accomplish this energy transfer may be found in a paper entitled "Synchronization



(Courtesy of the Bell Telephone Laboratories, Inc.)

FIG. 113.—A corner of the auditorium of the Bell Telephone Laboratories as arranged on April 7, 1927.

of Television," by H. Stoller and E. R. Morton, published in the Bell System Technical Journal, October, 1927.

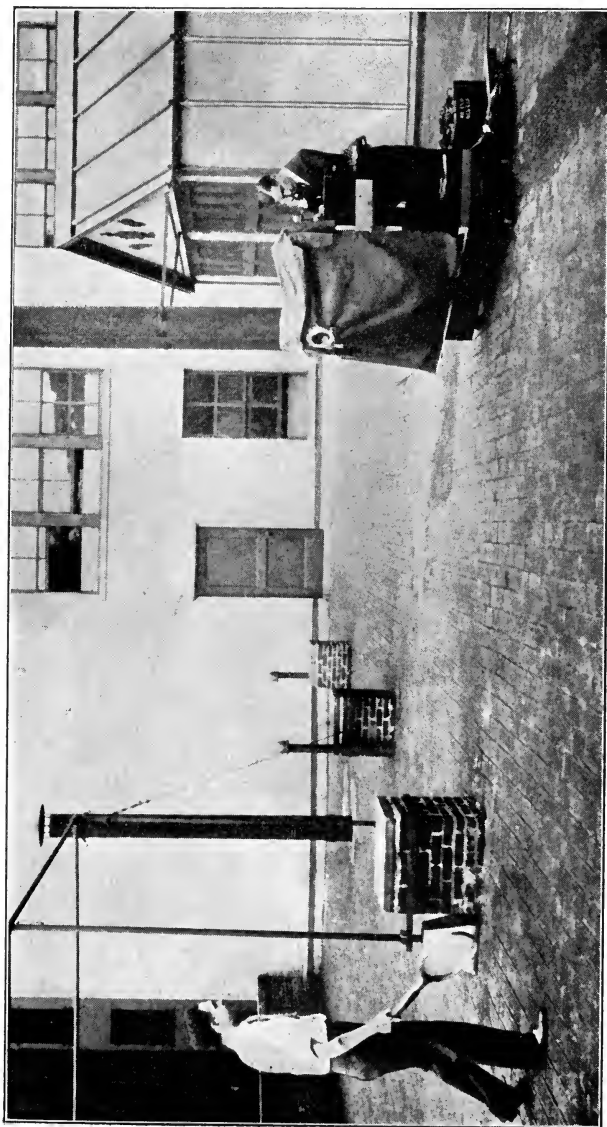

(Courtesy of the Bell Telephone Laboratories, Inc.)

FIG. 114.—Transmission of a scene illuminated only by daylight, apparatus is that developed at the Bell Laboratories, during 1928.

In the summer of 1928 the engineers of the Bell Laboratories announced a decided advance in their television transmitter. Whereas, the earlier apparatus required that the object be illuminated by light from a powerful electric arc, the new development made possible the transmission of scenes illuminated only by daylight. The system employs a large lens which forms an image of the scene and it is this image that is scanned much as the object was in the former system. In this manner moving persons and objects at a considerable distance from the lens could be successfully scanned.

In concluding this chapter it is well to emphasize the fact that the methods herein described represent a super refinement of television now possible only with the vast technical equipment and trained staff of an organization like the Bell System. In the words of Walter S. Gifford, President of the American Telephone and Telegraph Company, at the opening of the demonstration, April 7, 1927: "The elaborateness of the equipment required by the very nature of the undertaking precludes any present possibility of television being available in homes and offices generally."

CHAPTER XIV

THE JENKINS SYSTEM

THE lone experimenter whose lack of equipment is a constant goad to his ingenuity and whose endeavor is entirely of his own choosing, has played, in the past, no inconsiderable part in the development of new fields of endeavor. Nor is the research laboratory of our titanic industrial corporation ever likely to entirely replace him. The inventive mind is *sine qua non* a free lance; only with difficulty can it be caged in the toils of a large organization. Though the superb coordination of the engineering and research staffs of the Bell Telephone Laboratories has given us the most elaborate demonstration of television; the individual efforts of J. L. Baird in England and C. F. Jenkins in America have come much closer to realizing the ideal of home entertainment by radiovision.

C. Francis Jenkins has long been a worker in the field of optics. To him is generally accredited the invention of the motion picture machine. He is also the holder of an Elliot Cresson gold medal, awarded by the Franklin Institute of America for original contributions to the field of motion-picture mechanics.

As early as 1923, he was able to give an official demonstration of the transmission of pictures by radio over a distance of about seven miles. The most interesting part of the apparatus then used was the prismatic ring, a device original with Mr. Jenkins. In describing it he says: "the prismatic ring is equivalent to a glass prism which changes the angle between its faces, and in rotation gives to a beam

of light having a fixed axis on one side, a hinged or oscillating axis on the other." The device can be visualized by imagining a glass wheel with its edge ground to the form of a triangular prism; but at no two points on the circumference of the wheel would the angle between the faces of the prism be the same. For half a revolution, the base of the prism is toward the center of the wheel and for half a revolution it is toward the periphery: the angle between the faces varies continually.

The result of this construction is that a beam of light traveling parallel to the axis of the disc and focused at a point near the periphery will be refracted a varying amount

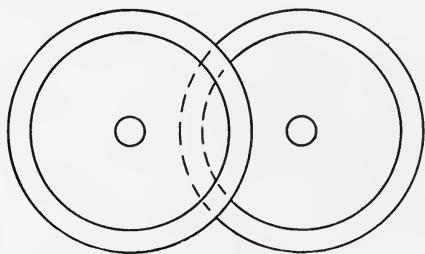

FIG. 115.—Mounting of Jenkins' prismatic discs.

as the wheel is rotated. Assuming the wheel to be spinning about a horizontal axis, the light beam, after passing through the top of the prismatic disc, will move up and down in a vertical plane perpendicular to the face of the wheel.

Now if the light beam should pass through the *side* of a similar disc, it would be made to move back and forth in a horizontal plane, also perpendicular to the face of the wheel. By the combination of these two actions with two discs mounted as shown in Fig. 115, an object may be scanned completely by the emergent light beam. In practice the horizontal displacing disc rotates one hundred times as fast as the one which gives the vertical displacement; hence the object surface would be covered in one hundred horizontal strips.

More recently, the name of C. F. Jenkins has been associated with a very definite attempt to bring radio movies into the home. It must be understood that this is not yet

true television, for only silhouettes from a motion picture reel can be received. However, the advance represented by the simplification of the receiving apparatus so that an equipment suitable for viewing by a group of five or six people is as compact as the average radio set, and costs but little more, is certainly worth of mention.

The device by which this is made possible is another ingenious optical piece original with Mr. Jenkins—the drum-scanner. The great merit of the construction used in this drum is that it makes possible a picture of good intensity with low current input to the glow-lamp. In scanning through a disc the area of the cathode of the neon lamp

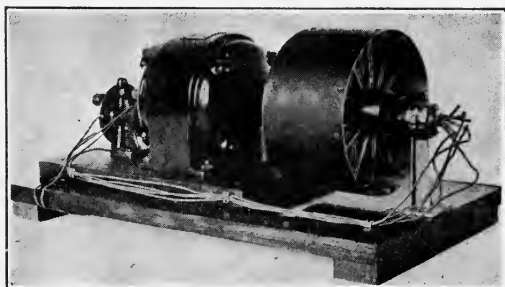

(Courtesy of Jenkins Laboratories.)

FIG. 116.—Jenkins' drum-scanner. Note quartz spokes.

must be a little larger than the total size of the picture reproduced and the entire plate must be illuminated; although at any instant, only a very small portion is being viewed. Whereas in the drum method used by Jenkins, the cathode of the tube is, in effect, divided into four parts and only that part being viewed is illuminated. Furthermore, the light from the lamp cathode is concentrated onto the viewing aperture by a quartz rod. By the combination of small plate area and effective use of illumination, it is claimed that a picture of sufficient size to be seen across a room can be produced with as low as 5 milliamperes input to the

glow lamps; as compared to some 50 milliamperes required for a $2\frac{1}{2}$ inch square picture formed with a disc-scanner.

Another decided advantage of the drum-scanner is its compactness. Where a disc is used for scanning, the minimum separation of the apertures determines the width of the picture and the offset of the ends of the spiral fixes the height. If we employ a 48-line image and make suitable allowance for framing and size of the apertures ($\frac{1}{24}$ inch), we find that a disc of 36-inch diameter is necessary even to produce a picture 2 inches square. Where a drum is used, the aperture spiral may be divided into a number of parts spaced along the axis of the drum, so that the number of holes per revolution is decreased and the periphery need not be so large. We may say that the four-turn drum used by Jenkins in his radio-movies receiver need only be one-quarter the diameter of a disc which would produce the same size image. And here we have neglected the magnification made possible by the intensification of the image in the Jenkins' drum. Nor is there any fundamental objection to increasing the number of parts into which the aperture spiral is separated.

A detailed description of the drum as used in the radio-movies receiver will probably serve to clarify the preceding discussion. The drum is a hollow cylinder about 7 inches in diameter and 3 inches long. On its surface are punched 48 holes about $\frac{1}{24}$ inches in diameter and arranged as if on a screw thread which makes four complete turns in 2 inches along the cylinder (i.e., has a pitch of $\frac{1}{2}$ inch). A quartz spoke connects each one of these elemental picture areas with the hub of the drum. This hub connects, at one end, with the motor drive shaft, but for the length of the drum is hollow and about $1\frac{1}{2}$ inches in diameter. Inside the drum-hub, but not attached thereto, a glow-lamp is mounted. The lamp is of special design, having four cathode plates about $\frac{3}{16}$ by $\frac{1}{4}$ inch in size, one under each

turn of the quartz rods; but only one anode, running the entire length of the under side of the tube.

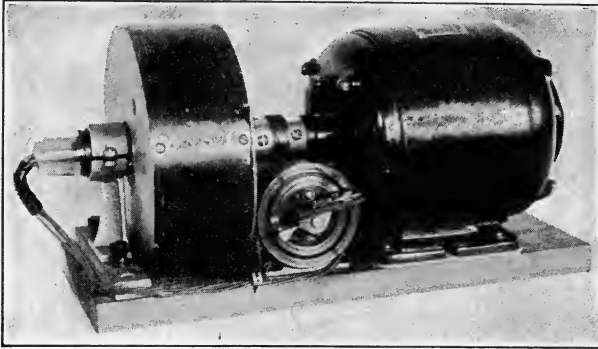

(Courtesy of Jenkins Laboratories.)

FIG. 117.—Mounting of Jenkins' drum-scanner.

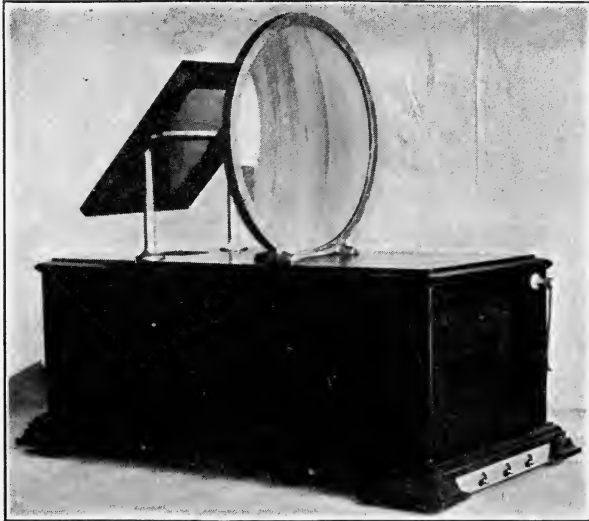

(Courtesy of Jenkins Laboratories.)

FIG. 118.—Jenkins' radio-movies receiver. Note magnifying lens and mirror on top. The drum and its drive are inside the box.

With such a device the picture is built up, one-quarter for each complete revolution of the drum. The drum shaft

is equipped with a commutator so that the negative input from the radio amplifier is connected to each of the four cathode plates of the neon tube in turn. The connection remains on a given plate during that revolution of the drum in which the picture is being constructed by the turn of the quartz rods over that particular plate. By the reduction of the glow area in this fashion, considerable brightness may be produced by a small current. This illumination is most effectively utilized by employing a quartz path for the light from the tube to the scanning aperture. In this case

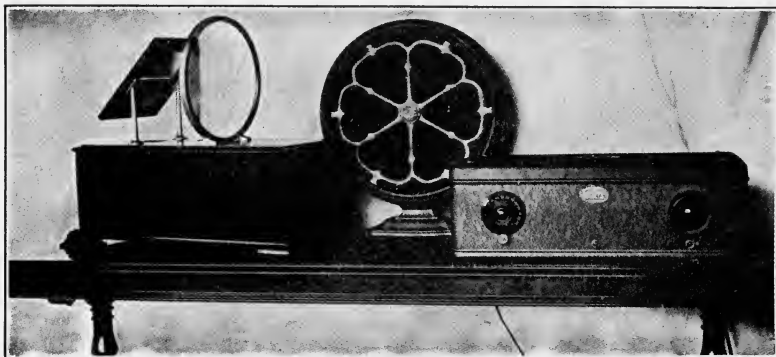

(Courtesy of Jenkins Laboratories.)

FIG. 119.—Complete radio and radio-movies equipment. Note comparative size.

the internal reflection at the walls of the quartz tube tends to reinforce the light within the tube cross-section.

The drum described gives a picture two inches square. It will be noted from the accompanying photographs, however, that the picture is viewed through a magnifying glass. The resulting image appears about 6 inches square. The entire outfit is very compactly arranged; the motor with its controls and the drum being in a neat box on which is mounted the viewing lens. Since the drum shaft is horizontal, a mirror inclined at 45° is used to change the light from a vertical to a horizontal path.

For synchronization the Jenkins' "radiovisor" set relies on the standard 60 cycle alternating current supplied by the power lines. He claims to have had no difficulty with synchronous motor drives of this type even when transmitting from Washington to New York.

CHAPTER XV

ALEXANDERSON SYSTEM

THE Alexanderson system of television has its chief value in the receiving and projecting equipment rather than in the transmitter. In fact a transmitter of the type to be suggested has a number of distinct disadvantages. For this reason let us examine the projector in detail and leave the remaining part of the equipment for brief discussion at the end of the chapter.

The projector consists of a drum on the periphery of which is mounted a number of mirrors. In Alexanderson's first apparatus there were twenty-four of these, each one being eight by four inches in size. They are mounted on the rim so that they are normal to a radial line of the drum. In other words their position corresponds to the tread of an automobile tire. Each mirror is set at a slight angle to its neighbor. Thus if a reflected ray from the first of these mirrors falls upon one side of a large viewing screen the same ray reflected from the last one will fall on the opposite side of the screen. The intermediate mirrors will cast the ray to intermediate positions and thus the entire screen is covered as the wheel revolves. Each mirror sweeps the ray from top to bottom of the screen as it passes the incident beam. These rays are referred to in Alexanderson's original paper as the "paint brushes" which paint the picture on the screen. As this is done over and over again with sufficient speed to take advantage of the persistence of vision the scene painted appears to be continuous.

The advantage of this system of projection over others

is that without any complication it can be used with a multiple spot. Alexanderson used, in fact, seven light spots. The multiplicity of spots has several advantages. Perhaps it is best to describe these in his own words as given before the St. Louis section of the American Institute of Electrical Engineers, December 15, 1927.

“When the drum revolves, the spot of light passes across

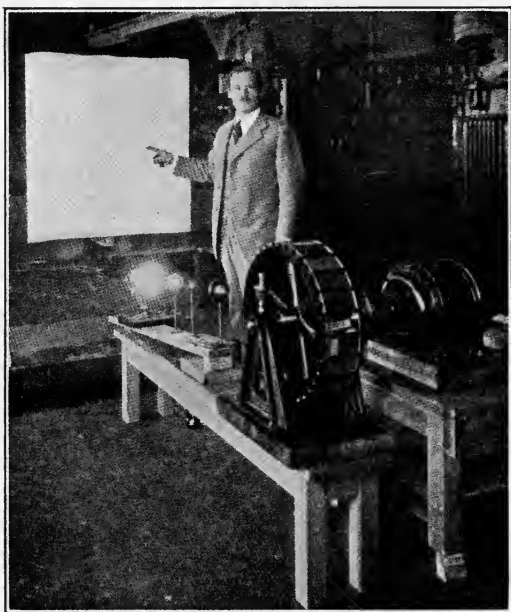

(Courtesy General Electric Co.)

FIG. 120.—The Alexander projection drum.

the screen. Then as a new mirror which is set at slightly different angle comes into line, the light spot passes over the screen again on a track adjacent to the first and so on until the whole screen is covered. If we expect to paint a light picture of fair quality, the least that we can be satisfied with is ten thousand separate strokes of the brush. This may mean that the spot of light should pass over the screen

in one hundred parallel paths and that it should be capable of making one hundred separate impressions of light and darkness in each path. If we now repeat this process of painting the picture over and over again sixteen times in a second it means that we require 160,000 independent strokes of the brush of light in one second. To work at such a speed seems at first inconceivable; moreover, a good picture requires really a scanning process with more than 100 lines. This brings the speed requirements up to something like 300,000 picture units per second.

“Besides having the theoretical possibility of employing waves capable of high speed of signalling, we must have a light of such brilliancy that it will illuminate the screen effectively, although it stays in one spot only one-three hundred thousandths of a second. This was one of the serious difficulties because even if we take the most brilliant arc light we know of, and no matter how we design the optical system, we cannot figure out sufficient brilliancy to illuminate a large screen with a single spot of light. The model television projector was built in order to study this problem and to demonstrate the practicability of a new system which promises to give a solution to this difficulty.

“The result of this study is briefly that, if we employ seven spots of light instead of one, we will get 49 times as much useful illumination. Offhand, it is not so easy to see why we gain in light by the square of the number of light spots used, but this can be explained with reference to the model. The drum has twenty-four mirrors and, in one revolution of the drum one light spot passes over the screen twenty-four times; and when we use seven sources of light and seven light spots we have a total of 170 light spot passages over the screen during one revolution of the drum.

“The gain in using seven beams of light in multiple is twofold. In the first place we get the direct increase of illumination of 7 to 1 but we have the further advantage

that the speed at which each light beam must travel on the screen has been reduced at a rate of 7 to 1, because each light spot has only 24 tracks to cover instead of 170. While the light itself may travel at any conceivable speed there are limitations of the speed at which we can operate a mirror drum or any other optical device and the drum with 24 mirrors has already been designed for the maximum permissible speed. A higher rate of the light spot can



(Courtesy General Electric Co.)

FIG. 121.—A broadcast studio sending a drama by television and radio.

therefore be attained only by making the mirrors correspondingly smaller and a mirror one-seventh as large will reflect only one-seventh as much light. The brilliancy of the light spot would therefore be only one-seventh of what we realize by the multiple beam system, which gives seven light spots seven times as bright or forty-nine times as much total light.

“There is another advantage in the use of the multiple light beam. Each light beam needs to move only one-

seventh as fast and therefore needs to give only 43,000 instead of 300,000 independent impressions per second. A modulation speed of 43,000 per second is high with our present radio practice but yet within reason, being only ten times as high as we use in broadcasting.

“The significance of the use of multiple light beams may be explained from another point of view.

“It is easy enough to design a television system with something like 40,000 picture units per second, but the images so obtained are so crude that they would have very little practical value. Our work on radio photography has shown us that an operating speed of 300,000 picture units per second will be needed to give pleasing results in television. This speeding up of the process is unfortunately one of those cases where the difficulties increase by the square of the speed. At the root of this difficulty is the fact that we have to depend upon moving mechanical parts.

“If we know of any way of sweeping a ray of light back and forth without the use of mechanical motion, the answer might be different. Perhaps some such way will be discovered, but we are not willing to wait for a discovery that may never come. A cathode ray can be deflected by purely electromagnetic means, and the use of the cathode ray oscillograph for televisions has been suggested. If, however, we confine our attention to the problem as first stated of projecting a picture on a fair sized screen, we know of no way except by the use of mechanical motion. If we also insist upon a good image, we must reduce the dimensions so that we will have only one-forty-ninth as much light. Our solution to this difficulty is, not to attempt to speed up the mechanical process, but to paint seven crude pictures simultaneously on the screen and interlace them optically so that the combination effect is that of a good picture.

“Tests have been made with this model television projector to demonstrate the method of scanning the screen



FIG. 122.—A home receiver used in the early broadcasting experiments of the General Electric Company.

with seven beams of light working in parallel simultaneously. The seven spots of light may be seen on the screen as a cluster. When the drum is revolved, these light spots trace seven lines on the screen simultaneously, and then pass over another adjacent track of seven lines until the whole screen is covered. A complete television system requires an independent control of the seven light spots. For this purpose

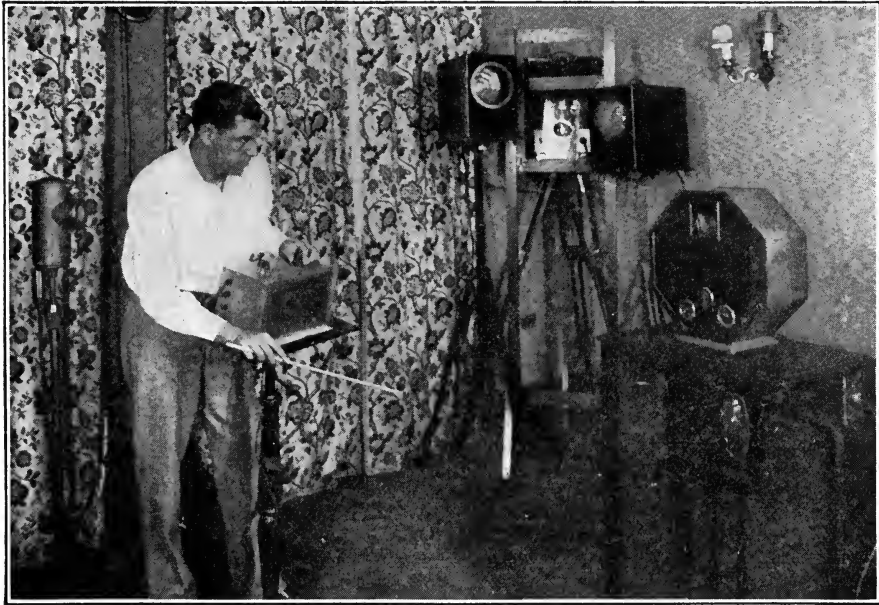

(Courtesy General Electric Co.)

FIG. 123.—In directing a television drama, the director uses a receiver to enable him to see the effect as his audience will see it.

seven photoelectric cells are located in a cluster at the transmitting machine and control a multiplex radio system with seven channels. A Hammond multiplex radio system may be used with seven intermediate carrier waves which are scrambled and sent out by a single transmitter and then unscrambled at the receiving station so that each controls one of the seven light beams.

“Seven television carrier waves may thus be spaced 100 kilocycles apart and a complete television wave band should be 700 kilocycles wide. Such a radio channel might occupy the waves between 20 and 21 meters. If such use of this wave band will enable us to see across the ocean, I think all will agree that this space in the ether is assigned for a good and worthy purpose.

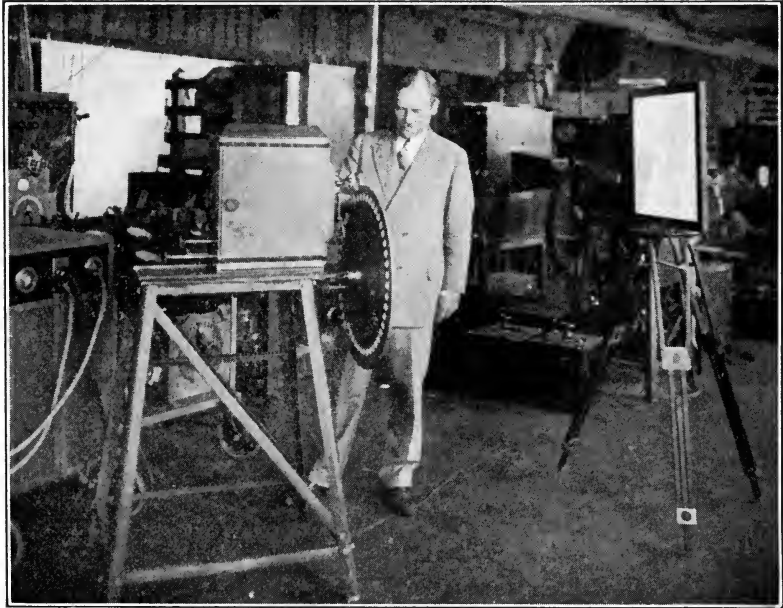

(Courtesy General Electric Co.)

FIG. 124.—A scanning apparatus as used in Alexanderson's later experiments.

“How long it will take to attain this, I do not venture to say. Our work has, however, already proven that the expectation of television is not unreasonable and that it may be accomplished with the means that are in our possession at the present day.”

The Alexanderson drum does not lend itself to use at the transmitting end as it does at the receiving end. Here

the method would be to project an image of the scene onto the mirrors by means of a lens. It would require that the scene be illuminated as a whole, and that the mirrors be scanned by seven apertures which, by suitable lens systems, cast the rays received by them into their respective photo-electric cells. The intensity of illumination necessary on the scene would be large, an objection which applied to the original Baird system. It is possible of course that an exploring spot, or spots, could be used, provided that at any instant their position on the screen corresponded exactly with those being explored on the mirror image. This would introduce the synchronization problem and its added technical difficulties. One synchronization system between transmitter and receiver is all that most people care to be troubled with.

On the other hand there is no objection to the use of a multiple spiral disc such as that suggested by Baird. This, used at the transmitting end in conjunction with the Alexander drum at the receiving end, would make an admirable combination. Since, in later apparatus, Alexander used a spiral disc at the transmitting end, it is likely that such an arrangement will constitute the essentials of any system which he may eventually develop.

CHAPTER XVI

RELAYS

FREQUENTLY, in electrical work, there is available only a weak current from the primary source; and yet it is required that this current operate apparatus requiring considerable power. This is the case in long-distance transmission, or in radio transmission, where the conditions are such that only feeble currents reach the receiving apparatus. In such cases it is necessary to use a relay; a device, which controlled by the primary current, in turn controls a secondary current capable of operating the machines or apparatus being used.

Relays are naturally of many varieties to meet the great number of requirements of every-day practice. In general, they operate by passing the primary current through coils of an electro-magnet which pulls over the contact to complete the secondary current. The usual telegraph relay is of this type. The principle of the electro-magnet is too well known to require explanation.

The simple telegraph key is one of the class of non-polarized instruments. It matters not what direction the primary current has; the secondary contact will always react in the same way. It will close the circuit in the secondary when a current flows in the primary.

For many purposes this is not sufficient, and so polarized relays have been developed. These are made to close one circuit when the flow of current is in one direction and to close another when the current reverses. It will be seen that an adaptation of the usual moving-coil galvanometer is

capable of doing this. The moving-coil of such an instrument hangs between a pair of permanent magnetic poles. The magnetic polarity of the coil will depend upon which direction the primary current flows through it. (Fig. 125.) Its face will turn either toward the north or south magnetic pole, depending upon the direction of the primary current. The electrical contact for the completion of the secondary current may be made by a pointer attached to the moving coil being carried over to a fixed contact on either side of its swing. In actual practice, however, the torque which turns the coil is not sufficient to hold the con-

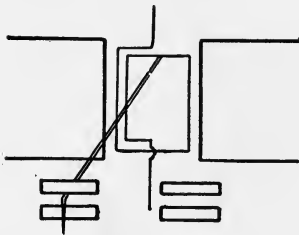

FIG. 125.—A moving coil galvanometer may be used as a polarized relay. A pair of jaws on either side of its swing open and close periodically and when the needle is caught between a pair then the circuit is completed on that side.

tacts firmly together. On this account the apparatus is frequently built so that a pointer carried by the coil moves between the two pairs of jaws, one pair on either side. These jaws open and close periodically but never make electrical contact except when the pointer attached to the coil is caught between the jaws. The contact from one jaw to the other is then made through the material of the pointer. This offers a means

of periodically adjusting a current in the secondary to a change in direction of current in the primary. It may also be arranged so that the pointer is normally on one side. Thus for a weak current it will remain there, but for a stronger one, depending upon the torsional value of the coil suspension, it will go over to the other side. This offers a means of controlling secondary currents by a fluctuating value of the primary current. Instruments built upon this principle and carrying a recording pen are used for recording temperature changes, light changes, etc.

An alternative method of construction is to use a per-

manent magnet, or a bar of iron magnetized by the inductive effect of a nearby permanent magnet, as the moving part. The incoming current is now passed through the magnetizing coils of the fixed electro-magnetic pole pieces. As a change in direction of current changes the polarity of the fixed pole pieces the moving magnet may be attracted to the one side or the other, depending upon the direction of this current. The rod supporting the permanent magnet, or magnets, also carries a contact point which may close either one circuit

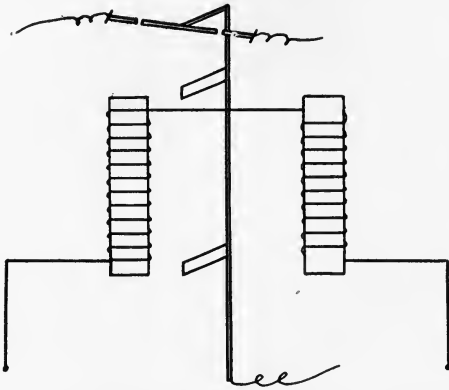

FIG. 126.—In this type of polarized relay a pair of vane-like magnets are fastened to a stem. These are magnetized by a pair of large magnets not shown. Change in direction of current in the primary cause these vanes to turn one direction or the other and contact is made by a contact point shown at the top of the figure.

or another, depending upon the direction of swing. The arrangement will be obvious from Fig. 126.

While it is customary where different frequencies are sent over the same circuit, or on the same carrier wave, to separate them by means of electrical filters, it is not impossible to do this directly by means of tuned relays. One relay of this sort which has been suggested has a number of tuned reeds arranged much after the manner of an harmonica. These reeds are placed next to an electro-magnet operated by the current received or by a corresponding

amplified current. The vibration of the tuned reed causes the current to vary in a coil an amount depending upon the extent of the reed vibration. As this vibration depends upon resonance with the received variations in current, the secondary will only be actuated when the frequency of the reed is equal to or nearly equal to the frequency of the received signal.

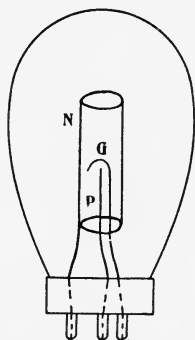

FIG. 127.—The Knowles relay.

Perhaps the most unusual type of relay is the Knowles device. This relay has an appearance resembling the radio vacuum-tube. It has three electrodes arranged as shown in Fig. 127. A rare gas, usually neon, is present at a pressure of about one centimeter of mercury. When a voltage is applied across terminals *P* and *N*, a positive space charge is soon built up around the *P* terminal which is itself positive. This space charge prevents any further flow of current. If, however, the hooked terminal *G* is grounded or made negative the space charge is dissipated and current is allowed to flow. Such a tube has an amplification factor of about a million to one. It may be readily actuated by the feeble effect of a photoelectric cell and in this respect acts as a very positive control; much more so than is the case with the usual vacuum-tube amplifying arrangement.

CHAPTER XVII

AMATEUR EQUIPMENT

ALTHOUGH most of the manufacturers of radio parts are prepared to supply the amateur with scanning discs, neon lamps and other special requisites for a television receiver, when the outfit is assembled there is little guarantee of any definite entertainment to be obtained therefrom. At the time of writing, there is a discouraging lack of uniformity in the spasmodic attempts which are being made by the various broadcasting stations to transmit television programs. Too much emphasis can hardly be placed on the fact that *television is still in the experimental stages of development.*

On the other hand, the adventurer who gropes his way into new realms is certain to be rewarded with thrills never experienced by the man who trods only well-beaten paths. There are those who derived keen enjoyment, some ten years ago, in adjusting the "cat's whisker" of their crystal detector so that, with almost superhuman auditory acuteness, they might hear a phonograph record being played in a broadcasting station some ten miles away; albeit the same record lay in their own rack not ten feet distant. To such as these, television now offers a fruitful field of endeavor. The disappointments are apt to be many; but the explorer does not go without reward.

From the point of view of the development of the art, there is nothing more beneficial than widespread amateur interest. Not only does it act as a stimulus to organized commercial progress in the field, but often leads to the dis-

covery of new ideas and new talent. Few will deny that amateur enthusiasm over radio at the close of the World War contributed more than anything else to the perfection of the present-day broadcast receiver. Television, today, is sorely in need of just such a boost.

The authors feel that amateur television equipment is at present in such a state of flux as to make the discussion of any particular "hook-up" inadvisable in this book. However, the interested reader will find no difficulty in obtaining detailed information of this character from the various manufacturers of radio parts, photoelectric cells, neon lamps and so forth. The following brief discussion considers the problem only in the most general terms.

Recent action of the Federal Radio Commission indicates that television signals are likely to be restricted to the short wave-length bands, below those generally used in speech and music broadcasting. For this reason the television set must be adapted to short wave reception. There are a number of standard kit sets of this type on the market. The use of a 222, or screen-grid tube, ahead of the regenerative detector has the advantage of increasing the sensitivity of the receiver and preventing radiation from the set. Aside from the usual electrical shielding, which good practice dictates in all set construction, it is well to remember that mechanical vibration from the scanning-disc motor must be guarded against when building a television receiver. For this reason, all parts should be securely fastened in place and the set, as a whole, cushion mounted.

In the discussion of television signals given in the chapter on the Bell system, it was pointed out that to produce a good half-tone image a wide frequency range was necessary. This means that transformer coupled amplification can scarcely be used without introducing distortion. Only recently have transformers been developed whose reproduction was faithful over the normal range of audible frequencies

(16-5000 cycles). For the "audio" amplification in a television set, we would expect uniform results over a range of from 18 to 20,000 cycles. To be sure, a recognizable picture may be obtained when standard transformer coupling is used, and for initial experiments such a "hook up" may be good enough. Where the best results are desired a resistance coupled amplifier is probably much to be preferred. One manufacturer recommends three stages of this type of amplification between a regenerative detector and the neon tube, employing a 240, a 112A and 171A tube in the order named and with the usual *B* and *C* potentials applied. The tube characteristics dictate the constants of this portion of the circuit as in any other radio amplifier.

The exact nature of the neon tube circuit will depend on the nature of tube used. In general a background direct current of about 20 milliamperes is desirable. To produce this current a permanent voltage must be supplied across the tube; but a high resistance must be inserted in series with the tube because of the tendency of ionization, which occurs when a current flows through the gas, to decrease the resistance of the tube itself. This series resistance should consist in a high permanent portion, for safe-guarding the lamp, and a variable portion, for controlling the current to the lowest satisfactory value.

The scanning-disc and its motor drive, as previously noted, should be so placed that vibrations from them will not be introduced into the tube circuits. These synchronous vibrations evince themselves as horizontal wavy lines appearing across the picture. To avoid this trouble, the best policy is to mount the disc and motor drive in a unit entirely separate from the receiver and amplifier circuit. The motor will probably be a 60 cycle a.c. type of about $\frac{1}{8}$ horse power rating, fitted with a rheostat for speed control. A good method to employ here is to have one resistor which may be varied for general speed control, and another, of

smaller value, which may be shunted, when the need arises, with a push button held in the operator's hand. Unfortunately, programs requiring 24, 36 and 48 hole discs are all "on the air," which means that the experimenter will probably wish to have the facilities to receive them. Either the three types must be at hand so that a change can be made when needed, or a special combination scanner must be used. The latter, as produced by one manufacturer,

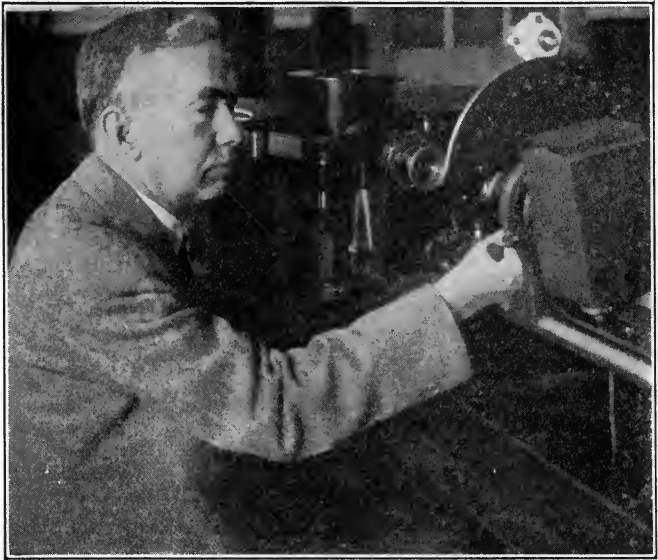

(Courtesy of the Westinghouse El. and Mfg. Co.)

FIG. 128.—Dr. Frank Conrad, Assistant Chief Engineer, Westinghouse Electric and Manufacturing Co., adjusting his television motion picture equipment.

merely requires a shift in the neon lamp position in order to make the shift from one to the other class of program. In the discussion of scanning, it was pointed out that radial holes lead to less "lining" of the image; discs of this kind are available.

The successful operation of a television receiver is naturally an art which takes some time to acquire. A few

pointers may prove helpful. The tuning of the receiver is not very different from a similar operation in the usual radio

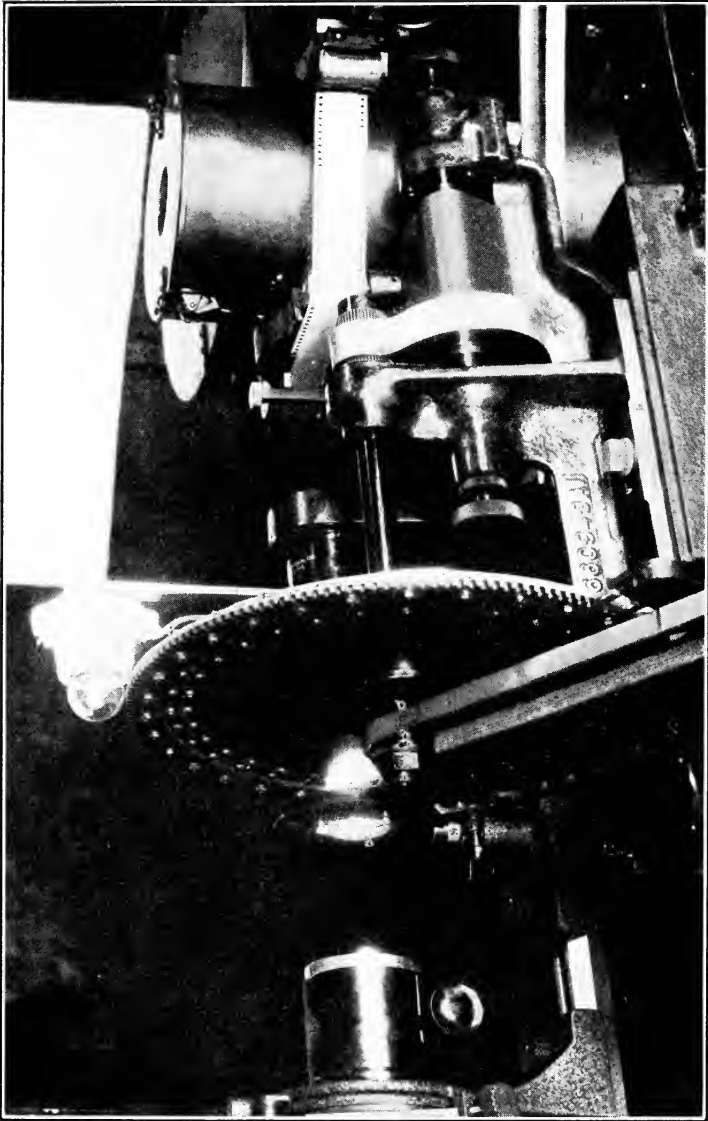

FIG. 129.—The heart of the television motion picture transmitter of the Westinghouse Electric and Manufacturing Company. The scanning-disc is clearly shown as well as the dot of light which is thrown upon the motion picture film. Above the scanning-disc may be seen the synchronizing tube which keeps the disc turning at a predetermined speed.

set. The signal may be heard by attaching a loud-speaker (with a microfarad condenser in series, for protection) across the input terminals of the neon lamp circuit. "If you are getting a good television signal, it will sound very much like a slowly revolving circular saw which is slightly off center. In other words, you hear a high pitched note which might correspond to the tooth frequency and this is broken up into groups whose frequency corresponds to the rate at which the saw (the disc) rotates."¹

The framing of the image is an operation requiring some skill in handling the motor speed control. Where the image persists in appearing inverted, however, the lamp plate is obviously being scanned from bottom to top, instead of from top to bottom. The fault can be corrected by reversing the direction of rotation of the disc, or by turning it so that the side formerly toward the lamp is now toward the viewing frame. Where the image appears right side up but transposed horizontally (that is, viewed from right to left instead of from left to right) the correction is more troublesome. The direction of rotation of the disc and also the side facing the lamp must be changed. Where the image obtained is a negative of the original, reversal of the input leads to the neon tube will correct the difficulty.

The Jenkins, the Westinghouse, and the von Mihaly systems of radio-movies all promise good "picking" for the amateur. But, to date, the authors have insufficient material at hand to give any helpful information, other than what has already been given in previous chapters.

¹ Bulletin TS-10, Raytheon Manufacturing Company, Cambridge, Mass.

CHAPTER XVIII

THE FUTURE OF TELEVISION

TEN years ago one of the authors of this book was extremely skeptical of the possible success of television. The speed required to successfully accomplish television, the state of photoelectric cells, the lack of suitable sources, seemed insurmountable difficulties. He is now writing the final chapter to the first American book on television.

With this in mind the situation is a difficult one. Fortunately his ideas of ten years ago are not in print. Ten years from now the situation will be different. Shall we go to the limit in our predictions and line up with the "Jules Vernes" of the day or even with those wild spectacular writers who out-Verne Verne in some of our present daily publications? Or shall we line up with the rank and file of humdrum, unimaginative engineers who still almost deny the existence of even the steam locomotive; perhaps, because of the fact that one is considered a good scientist by scientists if he is ultra skeptical of future developments?

Undoubtedly it will be wise to steer a middle course; or better yet, to predict what television will be like a hundred, rather than ten years from now. In that case the remarks are likely to be forgotten in suitable time. Let us, however, discuss the attitude taken by leading men of the present day.

Mr. M. H. Aylesworth, President of the National Broadcasting Company, tells us that television is coming in our homes. But he advises that this should not stop us

from buying a present-day radio set. We shall have time to buy three or four before we are able to buy a combined radio and television set.

In opening the demonstration of television given by the Bell Telephone Laboratories, April 7, 1927, Mr. W. S. Gifford, President of the American Telephone and Telegraph Company remarked: ". . . The elaborateness of the equipment required by the very nature of the undertaking precludes any present possibility of television being available in homes and offices generally."

The advance in the next ten years cannot help but be astounding. The invention is in its infancy and it is at this stage that most rapid growth takes place. Let us take the case of the modern automobile; let us assume that the progress of television is as far advanced. Could we expect much change in ten years? Dr. Charles F. Kittering, Director of Research for the General Motors Company, sums this up in an article in *Nation's Business*. His remarks are as follows:

"A few weeks back I was sitting with a group of executives. All were admiring a new model.

"'It is absolutely the best automobile that can be made,' enthused one. I objected to that statement.

"'Let's take this automobile which you say, is the "best that can be made" and put it into a glass showcase,' I said. 'Let's put it in there—seal it so no person can possibly touch it. Just before we seal it in the case let us mark the price in big letters inside the case.

"'Let us do that and come back here a year from today. After looking at it and appraising it, we will mark a price on the outside of the glass. It will be a price something less than what we think the car is worth today. Probably \$200 less. Then, let's come back once every year for ten years, look through the glass, and mark a new price. At the end of ten years we won't be able to put down enough

iphers to indicate what we think of the car. That is, of course, eliminating its value as junk.

“In those ten years, no one could possibly have touched the car. There could be no lessened value through handling. The paint would be just as good as new; the crank case just as good; the rear axle just as good; and the motor just as good as ever.

“What, then, has happened to this car?

“People’s minds will have been changed; improvements will have come in other cars; new styles will have come. What you have here today, a car that you call “the best that can be made,” will then be useless. So it isn’t the best that can be made. It may be the best you have made and, if that is what you meant, I have no quarrel with what you said.’”

If this is true of the automobile, how much more is it true of television? How true has it been of radio in the last ten years? Less than ten years ago I tuned in my first home-made radio; a crystal, a few coils on a breakfast-food box, and some telephones. I heard WWJ from a point about forty miles from Detroit. It was remarkable! A parade of neighbors filled the house each evening. A face would light up with “Yes, I can hear it now.” Today we expect an almost exact reproduction of the studio rendition. I was astonished when it was announced in our local paper that on such and such a night at such and such a time our electrical goods dealer would have on exhibition a loud speaker in operation. How could he be sure the set would work at that time? In fact what he got was simply a lot of squeals with a little music coming through. People were still working in the laboratories trying to send music over by a heterodyne system. A violin came across fairly well. A saxophone was not bad. But the two together sounded about as bad as one could imagine.

When we look at this situation is it possible to believe

that we can predict too much? The fact that wave-bands are now being set aside by the Radio Commission for television broadcasting shows how seriously the subject is being taken. There can be no doubt that television of moving pictures will soon come about. This brings up the problem of illumination only at the receiving end, instead of at both ends. But one broadcast station can serve many receivers so that expense need not be spared at the transmitting end. With searchlights now in use in aviation with beam candle-power up into the millions we need hardly worry about this point. From movies to actual dramas will be but a short jump.

The chief difficulty at present is that television requires a rather broad band of wave-lengths. Had television come ten years ago this would have presented no difficulty. As matters stand now, however, with a broadcast station crowded into every possible space, the introduction of television will of necessity crowd some of these out. With their enormous commercial possibility, none are willing to drop out for the general good of the future of television. Here, perhaps, lies television's greatest obstacle. It is probably greater than the various technical obstacles which have been presented in this book. In the meantime, the fact that there is no public demand for television magnifies this difficulty. If the public knew that it wanted television, if there would arise a vast army of enthusiasts such as those who built one home-made radio set after another a few years ago, then television would at least be given a hearing. But now a factory-made set is so much superior to one fabricated at home that most of these so-called fans have disappeared. As it is now we are waiting for a good factory-built television receiver. But will this come without public demand? We are met with the problem of public demand on both sides and it appears that this will only come as a result of press reports of laboratory demonstrations. It will be a

rather slow process. Television cannot win its way foot by foot; it must come as a more or less finished product.

Julius Weinberger of the Radio Corporation of America, speaking before the Federal Radio Commission, recently said:

"If the public is interested in purchasing picture or television receivers, and if commercial interests are desirous of setting up a service along these lines, it will be possible to set up and develop a better class of service with far less interference with the present sound broadcasting art if visual broadcasting service is placed in those bands above 1500 kilocycles. If this is done the necessary elements of standardization can be worked out at a reasonable and thoughtful pace and will develop so as to be of the greatest general public service."

Other speakers before the Commission were reported by the New York *Herald Tribune* of February 17, 1929 as follows:

"M. B. Sleeper, of the Sleeper Research Corporation, told the commission that television is no more annoying than any other program and the public is privileged to tune off any program it dislikes. He favored television programs in the broadcast band, and stated his belief that if sets were on the market the public would buy them. Under the present conditions, he said, most of those who have sets had to make them.

"Declaring that engineers developed all the great inventions and that statements made on television other than by engineers are of little value, C. W. Horn, manager of radio operations of the Westinghouse Electric and Manufacturing Company, told the commission that television will have no right on the broadcast bands until it has developed so that a moving picture can be shown. Television is now in the laboratories, he said, and not ready for the market, intense research work still being necessary.

“Oswald Schuette, executive secretary of the Radio Protective Association, said the commission could do everything possible to encourage the development of television. He opposed the standardization by certain groups and asked that the independent manufacturer, inventor and others be given a free hand in the development of television. Colonel Manton Davis, vice-president and general counsel of the Radio Corporation of America, agreed with Mr. Schuette that ‘development of the art should not be cramped.’ ‘Let us, if we can avoid it, not develop one radio art at the expense of another,’ Colonel Davis said.”

This probably gives us a fair picture of the present attitude toward television by those capable of passing judgment upon it.

Another difficulty comes in the lack of standardization. If one transmitter is working with a scanning-disc of forty-eight holes, another with thirty-six, two receiving discs would be needed. To shift from one station to another we should have to change the discs or make some equivalent adjustment. This is but one of several problems which lack of standardization presents. On the other hand, standardization at the present stage is dangerous. It is extremely difficult to change a standard, however undesirable it may prove, after the public has invested thousands of dollars in equipment.

But development goes on, and will go on. There is no question but that the technical difficulties will be overcome. This in turn will overcome the other difficulties which have been outlined. There is little question but that ten years from now we shall receive television broadcasts as readily as we receive radio programs today. And they will be relatively as satisfactory.

INDEX

- A**berration, chromatic, 25
 spherical, 25
Aeo light, 59, 63, 65
Alexanderson, E. F. W., 84
Alexanderson projector, 166
Alexanderson system, 166
Amateur equipment, 179
Amplifier, Bell system, 138
Amplitude, 32
Atomic structure, 60
- B**aird, 66, 81, 86
 color television, 129
 daylight television, 127
 J. L., 118
 optical lever, 88
 synchronization, 98
Baker, 101
 T. Thorne, 7, 43, 92
Bakewell, 5
Bartholomew, H. G., 9, 102
Bartlane, 10, 102
Belin, Edouard, 10, 18
Bell, synchronization, 100
Bell System, 132
 neon tube, 145
Blondel oscillograph (fig. 42), 74
Braun tube, 76
Burt, Dr. R. C., 52
- C**aesium photoelectric cell, 56
Campbell-Swinton, A. A., 18
Cathode-ray oscillograph, 70, 76
Charbonnelle, 7
- Chemical reproduction, 6
Chromatic aberration, 25
Circuit, neon tube control, 152
 synchronizing, Bell, 154
Code system, 102
Color-television, 66
 Baird, 129
Cosine law, 20
Critical angle, 27
- D**auvellier, M., 18
 scanning, 85
Daylight television, 58
Daylight transmitter, Baird, 127
Disc—Baird lens, 119
 Baird radial, 120
 Baird spiral, 121
 prismatic, 160
Disc receiver, Bell, 147
Discharge tube, 62
Dispersion, 27
Distributor, Bell, 151
Drum scanner, 161
DuFour oscillograph, 75
- E**intheven galvanometer, 73
Eldridge-Green theory, 28
Electromagnetic waves, 31
Elster and Geitel, 50
Equipment, amateur, 179
Ether, 36
Eye, 19
- Fading, 143

- Ferree, 7
 Fluorescent screens, 77
 Fournier, 81
 Framing, 99, 184

G
 Galvanometer, Einthoven, 73
 moving coil, 175
 moving magnet, 177
 Geometrical optics, laws of, 19
 "Ghosts," 143
 Giltay, 41
 Glow lamps, 59
 Governor, fly-ball, 91
 Gray, Frank, 139
 Grid receiver, Bell, 148

H
 Half-tone, 8
 Hallwachs, 47
 Heaviside layer, 145
 Hertz, 46
 Historical, 5
 Horton, J. W., 139
 "Hunting" of an electric motor,
 96

I
 Inverse square law, 19
 Ives, Herbert E., 132

J
 Jenkins, 89
 Jenkins, C. Francis, 18, 159
 Jenkins, drum, 160
 Radio-movies, 162
 synchronization, 165
 Jenkins system, 159
 Johnson, J. B., 53, 76

K
 Kino lamp, 63, etc.
 Knowles relay, 178
 Knudson, Hans, 15
 Korn, 101
 Korn, Prof. Arthur, 11, 41

L
 Lag-selenium cell, 42
 Lambert's cosine law, 20
 Left-hand rule, 71
 Leishman, L. J., 10
 Lenard, 48
 Lens disc, 119
 Lens, convex, 24
 faults, 25
 formula, 25
 Light, velocity of, 34
 Lorenz-Korn, 15

M
 McFarlane, Capt. M. D., 102
 MacFarlane Moore, D, 18, 59
 McFarlane, M. L. D., 9
 Mattes, R. C., 139
 Maxwell-Clerk, 35
 Mercury vapor tube, 63
 Mirror, concave, 21
 Mirror-drum, Alexanderson, 167
 Moving coil galvanometer, 175
 Moving magnet galvanometer,
 177
 Morton, E. R., 157
 Mounting, amateur equipment,
 131
 Multiplex radio system, 155

N
 Neon tube, 63
 Bell type, 145
 Neon tube control circuit, 152
 Non-polarized relays, 175

O
 Optical lever, Baird, 88
 Optical systems, 19
 Oscillograph-cathode ray, 76, 90
 Du Four, 75
 string, 73
 Oscillographs, 71

P
 Pendulum, 91

- Phonic drum, 97
 Phonovisor, 130
 Photoelectric cell, 46
 caesium, 56
 circuits, 57
 Photoelectric cells, Bell, 136
 Picture transmitter, Bell system, 109
 Piersol, R. J., 44
 Planck, 38
 Polarized relays, 175
 Prism, total reflecting, 27
 Prismatic disc, 90
 Prismatic ring, 159
 Process screen, 8
 Projector, Alexanderson, 166
- Quantum, 38
- Radial disc, 120
 Westinghouse, 182
 Radio-movies, Jenkins, 162
 Radiovisor, 165
 Ranger, R. H., 16, 94, 105
 receiver, 106
 Rankine, A. O., 44
 Real image, 22
 Reflection, internal, 27
 law of, 20
 Refraction, law of, 21
 Relay, Knowles', 178
 Relays, 173
 non-polarized, 175
 polarized, 175
 telegraph, 175
 tuned, 177
 Retina, 28
 Rignoux, 81
 Römer, 34
 Ruhmer, 17, 81
- Scanner, drum, 161
 Scanning, 81
 Scanning-disc motor, Bell, 152
 Scanning spot distortion, 139
 Scanning system, Alexanderson, 84
 Baird, 86, 122
 Dauvillier, 85
 Jenkins, 89
 oscillograph, 85
 system, simple, 83
 tuning fork, 85
 Selenium cell, 39
 lag of, 12
 Selenium, lag of, 42
 Sensation, relation to stimulation, 29
 Seven-spot projector, 167
 Spectrum, chart of, 35
 Spherical aberration, 25
 Spiral disc, 121
 Stoletow, 49
 Stoller, H., 157
 String oscillograph, 73
 Stroboscope, 96
 Swinton, A. A. Campbell, 78
 Synchronization, 91
 Baird, 98
 Bell, 100, 150
 Jenkins, 165
 Synchronizing circuit, Bell, 154
 Synchronizing system, Baird, 123
 Synchronous motors, 97
- Telectograph, 7
 Telephotography, 101
 Thomson, J. J. 48, 76
 Transatlantic transmission, 131
 Tuned relays, 177
 Tuning fork, electrical, 93

Virtual image, 21
Visual contrast, 70
Visual-purple, 28

Wave formula, 32
Wave-length, 32
Waves, 31
 transverse, 32

Westinghouse facsimile trans-
mitter, 107

Westinghouse radio-movies, 182

Wire television, 140

Work, 101

Zworykin, 53, 107, 112

TIMELY TOPICS FOR TELEVISION AND RADIO ENTHUSIASTS

STORAGE BATTERIES

By MORTON ARENDT, E.E., Assistant Professor of Electrical Engineering, Columbia University, Fellow, American Institute of Electrical Engineering.

Such material as can be readily applied to every-day problems relating to the manufacture and assembling of storage batteries, to questions having to do with their upkeep and care, and to their application and usage comprise the scope of this book.

290 Pages **Cloth** **6¼×9¼** **Illustrated** **\$4.50**

RADIO

By ELMER E. BURNS, Instructor in Physics, Austin High School, Chicago.

Radio theories and principles are dealt with in this book in a simple style. The mathematics employed is not hard, and all electrical discussions are in terms of the electronic theory.

266 Pages **Cloth** **5¼×8** **Illustrated** **\$2.00**

MATHEMATICS FOR THE PRACTICAL MAN

By GEORGE HOWE, M.E.

Explaining quickly and simply all the elements of algebra, geometry, trigonometry, co-ordinate geometry, and calculus.

143 Pages **Cloth** **5×7½** **Diagrams** **\$1.50**

PHYSICS FOR COLLEGES

By H. H. SHELDON, Ph.D., Professor of Physics and Chairman of the Department, Washington Square College, New York University, C. V. KENT, Ph.D., Professor of Physics, University of Kansas, C. W. MILLER, Ph.D., Assistant Professor of Physics, Brown University, and R. F. PATON, Ph.D., Assistant Professor of Physics, University of Illinois.

Here is a text that merges the old physics with the new. There are discussions of the electron theory of electricity, the principles of radioactivity are reviewed, and modern theories of radiation are studied. Difficult mathematics has been avoided, nothing higher than algebra is employed.

653 Pages **Cloth** **5½×8¾** **Illustrated** **\$3.75**

THE RADIO MANUAL

By GEORGE E. STERLING, Radio Inspector and Examining Officer, United States Department of Commerce. Edited by ROBERT S. KRUSE, B.S., Formerly Technical Editor QST, Magazine of American Radio Relay League; Consultant for Development of Short Wave Devices, Technical Editor and Writer.

It answers all questions on the installation, upkeep, operation, and control of radio apparatus and equipment—broadcasting, transmitting, and receiving.

666 Pages **Semi Flexible Fabrikoid** **5⅞×8** **Illustrated** **\$6.00**

SWOOPE'S LESSONS IN PRACTICAL ELECTRICITY

By ERICH HAUSMANN, E.E., Sc.D., Professor of Physics at the Polytechnic Institute of Brooklyn and Fellow of the American Institute of Electrical Engineers.

The uses of D-C and A-C machinery in the industry are discussed. Electromagnetism and its theories are fully treated. Facts are given on electric lighting, vacuum tubes, telegraphy, radio, precision instruments, and many other electrical subjects of every-day importance.

694 Pages **Cloth** **5½×8** **Illustrated** **\$2.50**

Van Nostrand books sent post paid on approval to residents of the United States and Canada. General Catalog sent free upon request

